

# SEPA20-XS Solar Electric Power Assembly

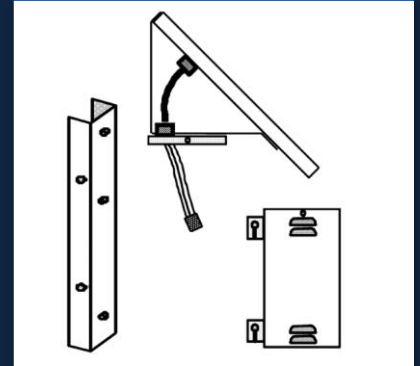

## Features & Benefits:

- The SEPA20 solar electric power assembly features a 20 Watt solar panel that is mechanically riveted to the battery box lid for mounting.
- The 36 Amp hour battery is contained within a vented aluminum battery box and includes a wiring harness and control electronics.
- There are 14 different controllers to choose for different types of applications such as dusk to dawn dusk activated, motion detector, etc.
- The systems are built for easy installation with quick connect terminals and can be mounted to a wall, roof, or pole.
- Every system is available to produce DC or AC power depending on the needs of the device.
- Meets AASHTO 150 mph wind force ratings.
- Powder coating and custom design available.
- 5 year maintenance free and system warranty up to 25 years (see warranty).

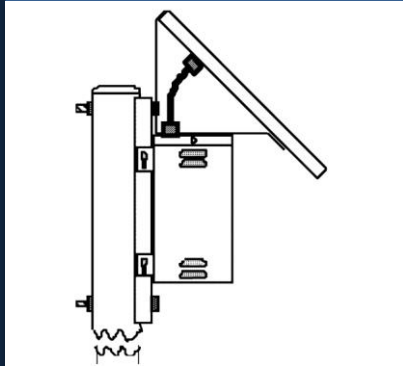

**Solar Electric Power Company**

1521 SE Palm Court, Stuart, FL 34994 | ph: 772-220-6615 | fax: 772-220-8616 | [www.sepco-solarlighting.com](http://www.sepco-solarlighting.com)



## Specifications

### Panel Assembly

A 20 Watt single array consists of one 20 Watt module which is integrally mounted upon and power riveted to a vented aluminum battery box cover and terminated in pre-wired 3 prong Molex type connector. Solar array produces 1.16 +/- amps charge current and measures 21.3"L x 17.7"W x 2.1"D. The array has a 10 year warranty for 10% power loss and 25 year warranty for 20% power loss. Solar array has a life cycle testing and actual field proven life of over 30 years.

### Battery Assembly

A vented aluminum box containing a 36 amp hour sealed GEL battery which is integrally mounted and pre-wired to include a standard wire harness with simple plug in connections for the SEPCO ALC Adaptive Lighting Control and the solar panel assembly. The low profile design contains a preformed and welded back mounting plate for easy slide on attachment to the power bracket. Battery assembly contains SEPCO unique "Through the Pole" rear wire routing output for no exposed wiring to provide a neat clean appearance for the finished installation.

The battery is warranted for 5 years. Battery assembly is complete with all stainless steel mounting hardware. All metal crafting has been performed by high speed robotic presses using computer programmed instructions.

### Power Bracket

Aluminum power bracket consists of a substantial aluminum channel for mounting to any pole or wall and providing a low profile, only 20" on the pole, to provide maximum strength for wind loading in excess of 150 MPH. The power bracket contains predrilled and tapped battery slide mount bolts of stainless steel and two 11/16" mounting holes for utility standard 5/8" mounting bolts. The bracket contains the unique "Through the Pole" battery wire hole for no exposed system wiring.

The SEPCO solar electric power assemblies have proven themselves as the most rugged and robust design in thousands of installations worldwide since their introduction in 1994. SEPCO systems surpass all codes, compliances, and quality controls.

**Solar Electric Power Company**

1521 SE Palm Court, Stuart, FL 34994 | ph: 772-220-6615 | fax: 772-220-8616 | [www.sepco-solarlighting.com](http://www.sepco-solarlighting.com)