



VIKING POOLS

Escape

*from the world
without ever leaving
the comforts
of home with
a Viking Pool.*



Isn't it your turn to own a V

In 1975, Viking Pools began manufacturing in San Jose, California with a single swimming pool mold. A second mold was added two years later. In 1979, Viking added an entire line of new pool designs.

Over the next decade, Viking continued to experience incredible success due to its wide range of products, high-quality materials, customized services, and their use of vinyl ester resin—a formula that would become the benchmark of the fiberglass pool industry. Soon new technologies and higher-quality materials were developed which spurred Viking's latest innovation—a new pool made from the finest, most durable raw materials. It is called A.C.P.[™] (Advanced Composite Pool). Today there is no other pool quite like it in the world.



a Viking Pool?

Isn't it your turn

...to experience the pure enjoyment,
complete relaxation, and
endless hours of recreation that
come with owning a Viking Pool?

Just imagine it...coming home after work
on a hot summer day...you walk out on to
the patio, approach the pool and jump in...
Instant gratification!

Just imagine the hours of fun with family
and friends on lazy summer afternoons...
sweet smells emanating
from the pool-side grill...
water splashing from
children's pool games...
while you float lazily,
sipping ice cold lemonade...
Just Another Day in Paradise!



Ten-Stage Manufacturing

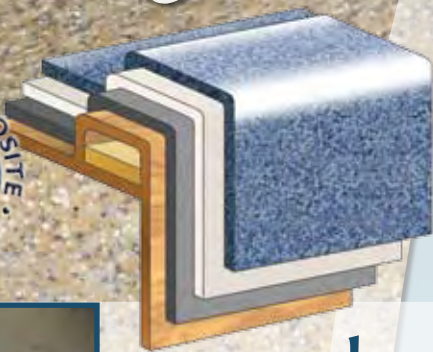

The Viking Pool A.C.P.™ (Advanced Composite Pool)

Combining premium raw materials and our unique ten-stage manufacturing process creates a pool with unsurpassed appearance and performance.

Closed-beam construction means your pool is built using the strongest method of construction available in the industry.



1

Prepare the mold so that the pool easily separates from the mold to give the pool a better quality finish.



2

Our standard gel-coat or premium Crystite® finish is added, which has a 7-year finish. Our Crystite® finish is available in four unique colors.



3

Vinyl Ester Resin is then added to provide the greatest impact resistance, blister protection, and helps give the gel-coat or Crystite® finish a gorgeous profile.



4

An additional layer of Vinyl Ester Resin and hand laid fiberglass is strategically placed for durability and strength.



5

The heart of every Viking pool is the ceramic core, which is sandwiched between protective layers of specially designed resin and fiberglass. The ceramic core adds a greater strength to the pool walls and provides enhanced water resistance.



6

Fiberglass is hand-laid across the pool to complete the important corrosion barrier to enhance durability. Additional layers of chopped fiberglass are added. When combined with the hand laid fiberglass it provides additional strength.

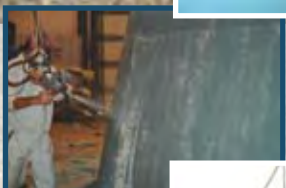

7

Honeycomb vertical supports are added to help support the walls during the installation process. The closed beam construction is then completed to strengthen the coping around the pool and allow for easier lifting of the pool. Chains are also secured around the pool for easy unloading and setting.



8

The completed pool is lifted off the mold.



9

The pool is then detailed according to specifications for a spectacular finish.



10

Pool is loaded onto the truck and ready for delivery.

the **Eco-Friendly**
Pool *of Tomorrow is*
Available Today

1 The pool layout is carefully marked for precision.



2 The dig begins the process for perfection.



3 The hole is carefully prepared to achieve proper shape and depth.



4 The pool is set in place.



5 The pool is now filled with water and the backfill process begins.



6 The proper plumbing and electrical equipment is installed.



7 The concrete is poured around the pool.



8 Your lifetime guaranteed Viking pool is ready for years of enjoyment.



Installation



Rectangle

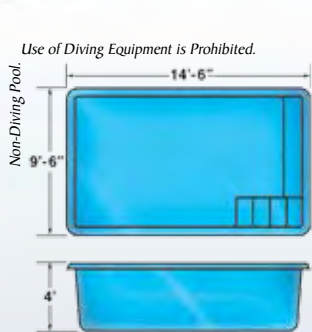

Tropicana

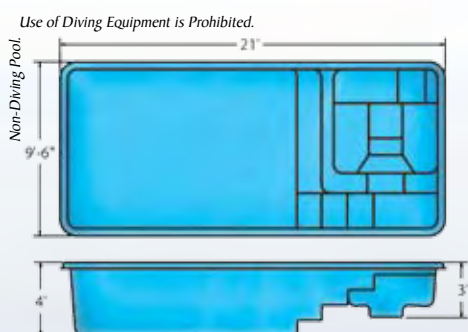

*Shipped from California Barbados

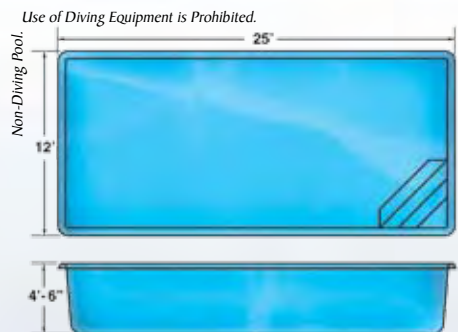

Delray

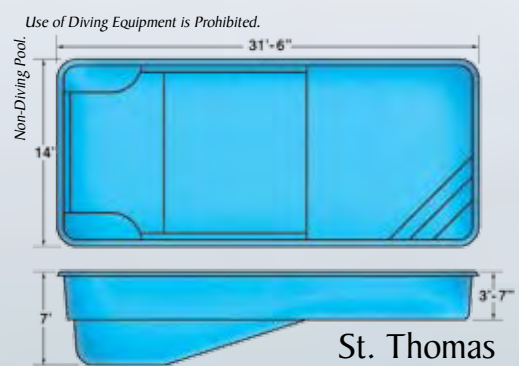

St. Thomas



Lake Shore

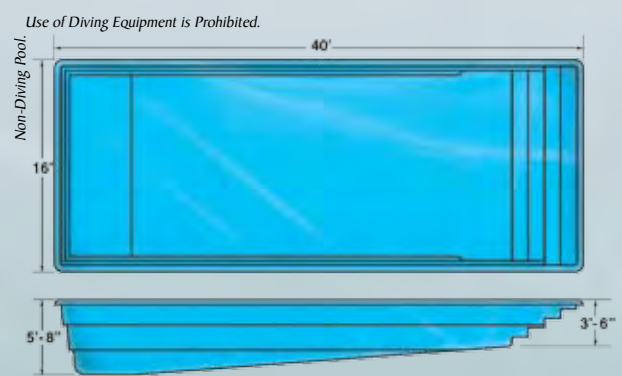

Ocean Breeze (pictured)

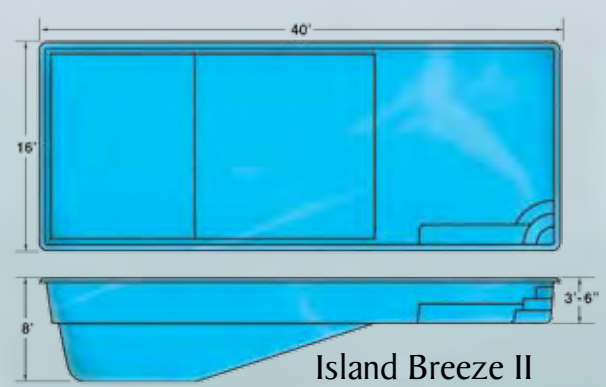

Island Breeze II

Diving/Sliding equipment shall be designed for swimming pools and shall be installed in accordance with the diving/sliding equipment manufacturer's specifications. Please contact the diving/sliding equipment manufacturer for their specifications.

All dimensions are to outside edge. Lengths, widths, and depths may vary up to 3%. Measurements are to widest point on each side of the outside edge.

Pool Styles & Dimensions

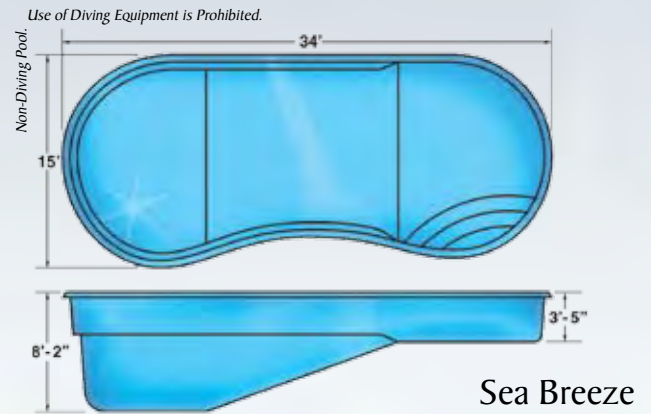
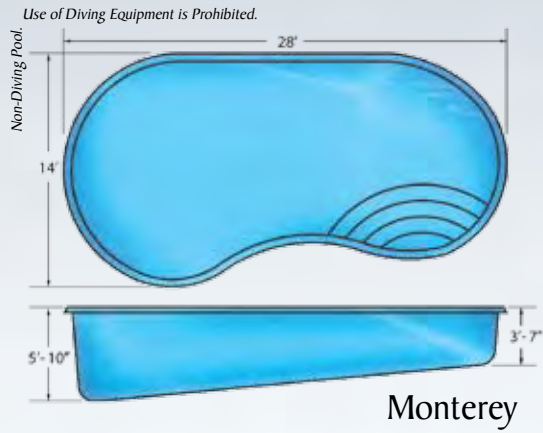
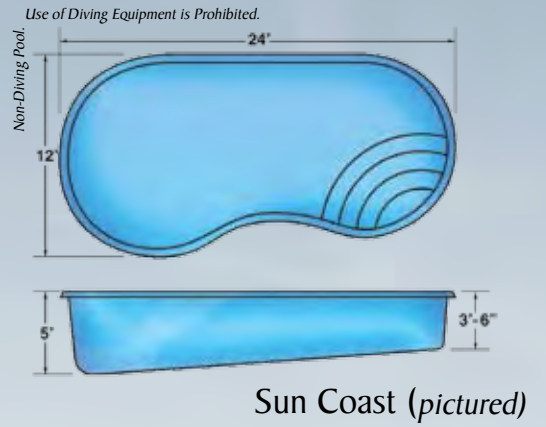
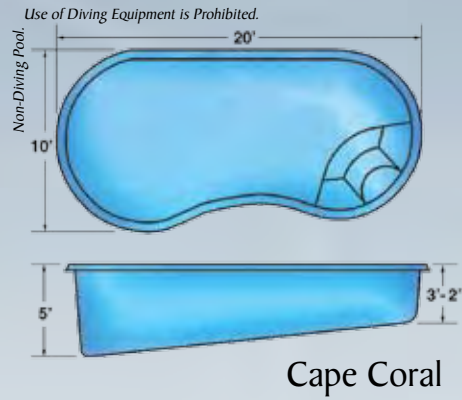
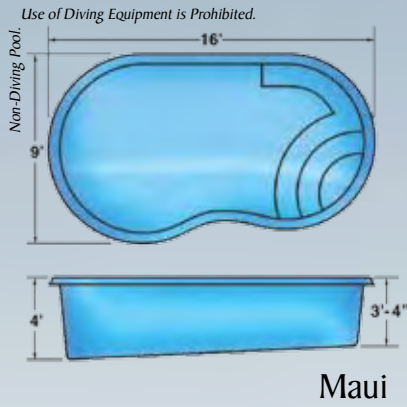

Kidney





Classic

Use of Diving Equipment is Prohibited.

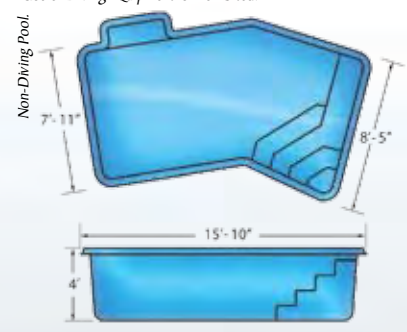

Oahu

Use of Diving Equipment is Prohibited.

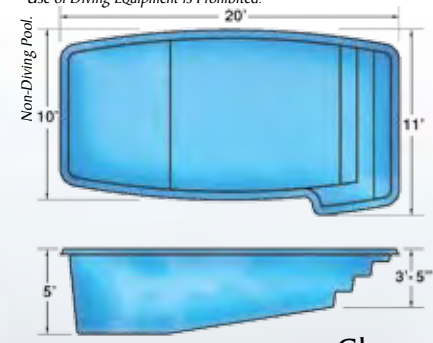

Clearwater

Use of Diving Equipment is Prohibited.

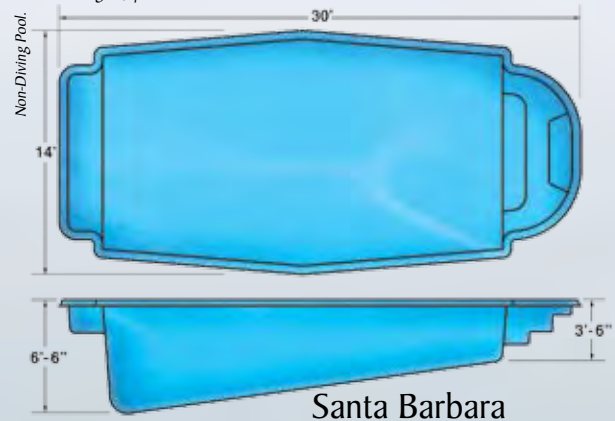

Santa Barbara

Use of Diving Equipment is Prohibited.

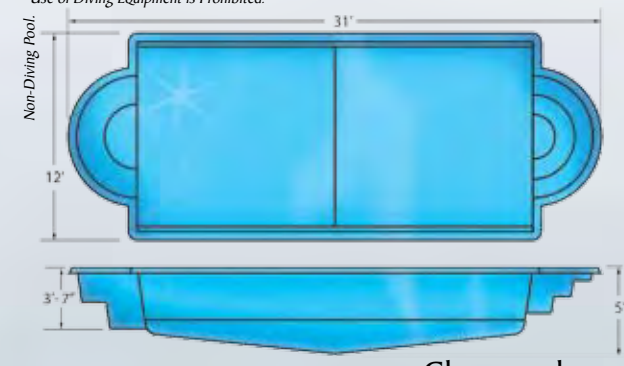

Chesapeake

Use of Diving Equipment is Prohibited.

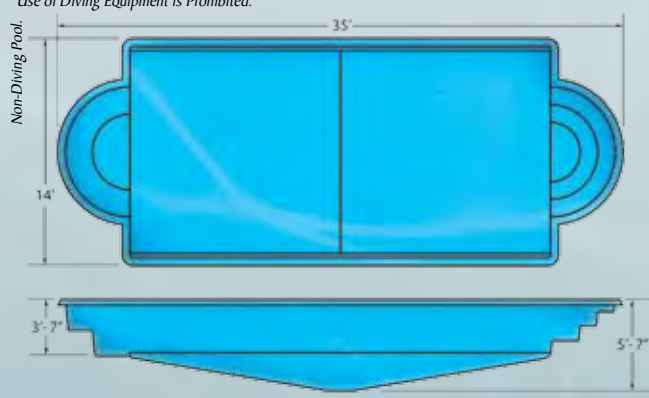

Montego (pictured)

Use of Diving Equipment is Prohibited.



Acapulco

All dimensions are to outside edge. Lengths, widths, and depths may vary up to 3%. Measurements are to widest point on each side of the outside edge.

Pool Styles & Dimensions

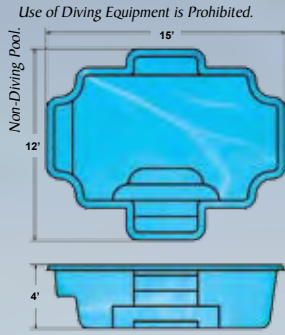

Atlantis
*Shipped from Florida

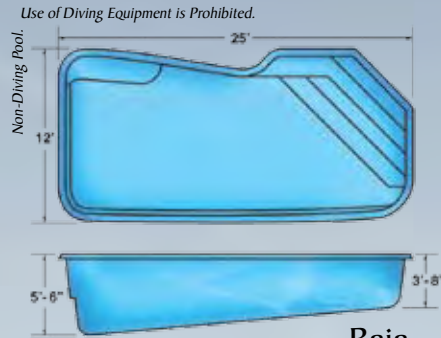

Baja

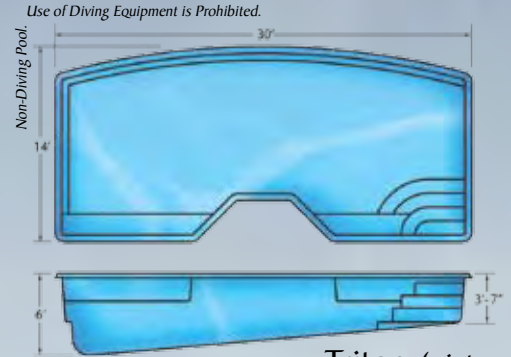

Triton (pictured)

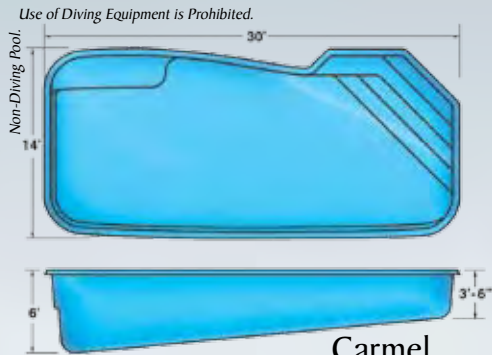

Carmel

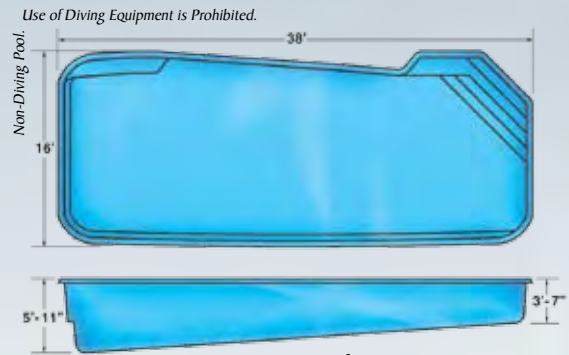

Mediterranean

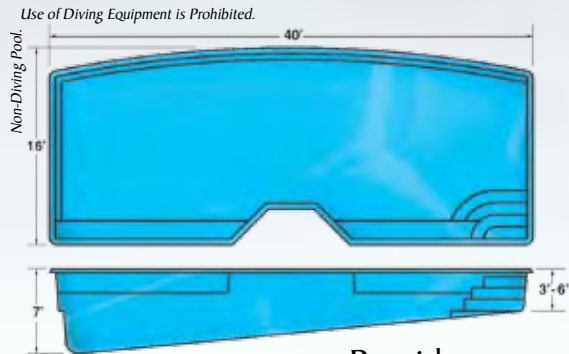

Poseidon

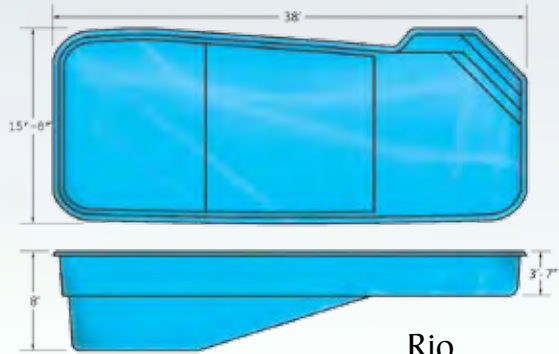

Rio

Diving/Sliding equipment shall be designed for swimming pools and shall be installed in accordance with the diving/sliding equipment manufacturer's specifications. Please contact the diving/sliding equipment manufacturer for their specifications.



Custom



Free Form

Use of Diving Equipment is Prohibited.

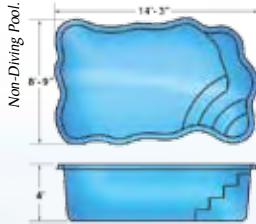

Bahamas

Use of Diving Equipment is Prohibited.

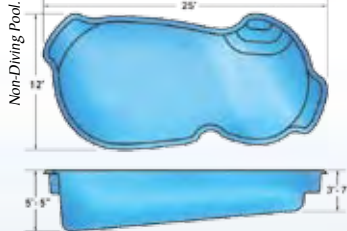

Freeport

Use of Diving Equipment is Prohibited.

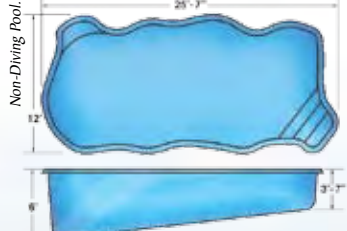

Key West

Use of Diving Equipment is Prohibited.

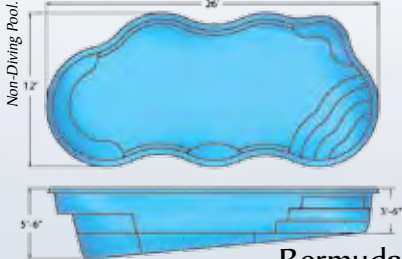

Bermuda

Use of Diving Equipment is Prohibited.

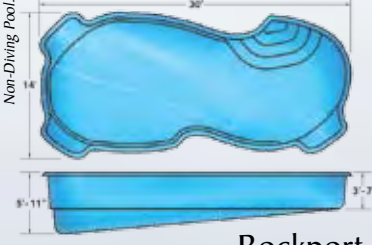

Rockport

Use of Diving Equipment is Prohibited.

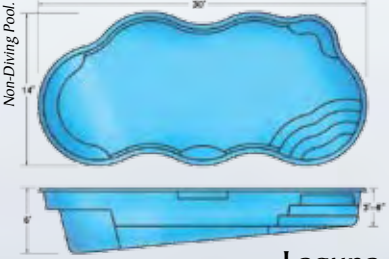

Laguna

Use of Diving Equipment is Prohibited.

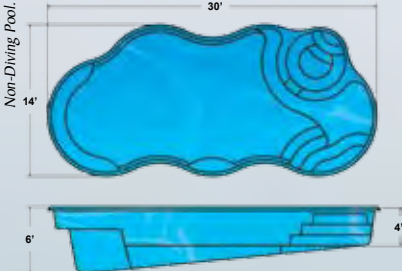

Laguna Deluxe

Use of Diving Equipment is Prohibited.

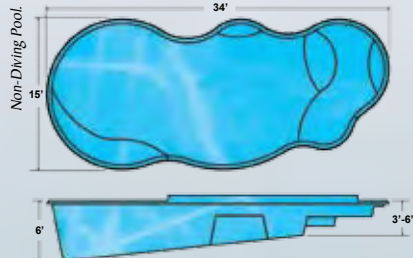

Fiji

Use of Diving Equipment is Prohibited.

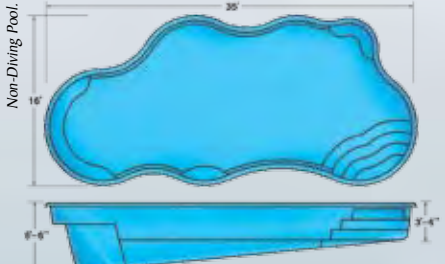

Cancun (pictured)

Use of Diving Equipment is Prohibited.

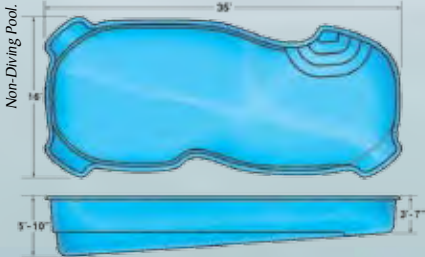

Gulf Shore

Use of Diving Equipment is Prohibited.

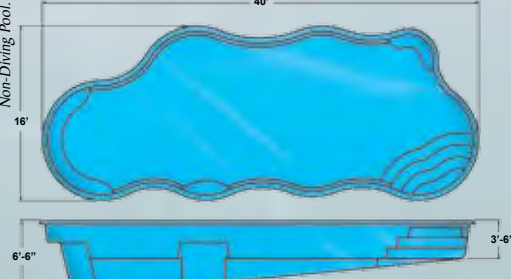

Caribbean

Use of Diving Equipment is Prohibited.



Gulf Coast

Diving/Sliding equipment shall be designed for swimming pools and shall be installed in accordance with the diving/sliding equipment manufacturer's specifications. Please contact the diving/sliding equipment manufacturer for their specifications.

All dimensions are to outside edge. Lengths, widths, and depths may vary up to 3%. Measurements are to widest point on each side of the outside edge. All Lap Pools and Hydro Zones are Non-Diving Pools. Use of Diving Equipment is Prohibited.

Pool Styles & Dimensions

Physical Fitness

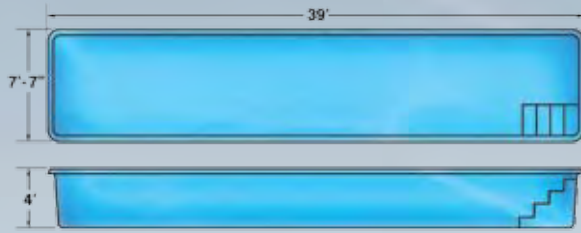

Santa Cruz



Panama

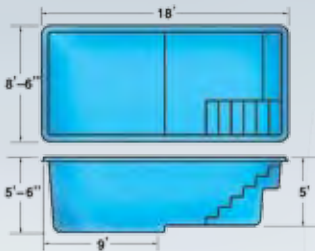

HZ A

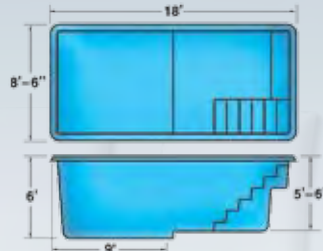

HZ B

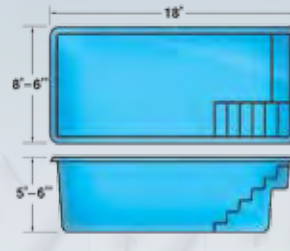

HZ C

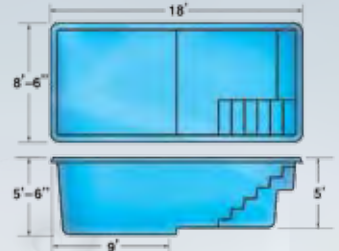

HZ D

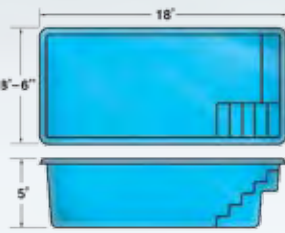

HZ E

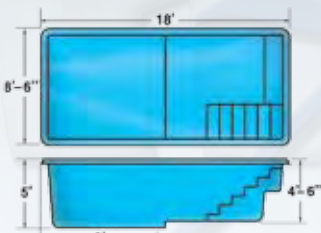

HZ F

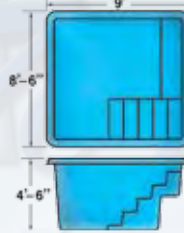

HZ G

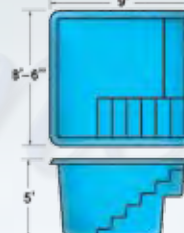

HZ H

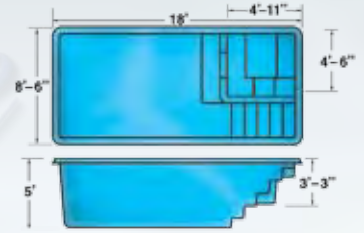

HZ DXL (pictured)

Lap Pools &





Spas & Splash Spas

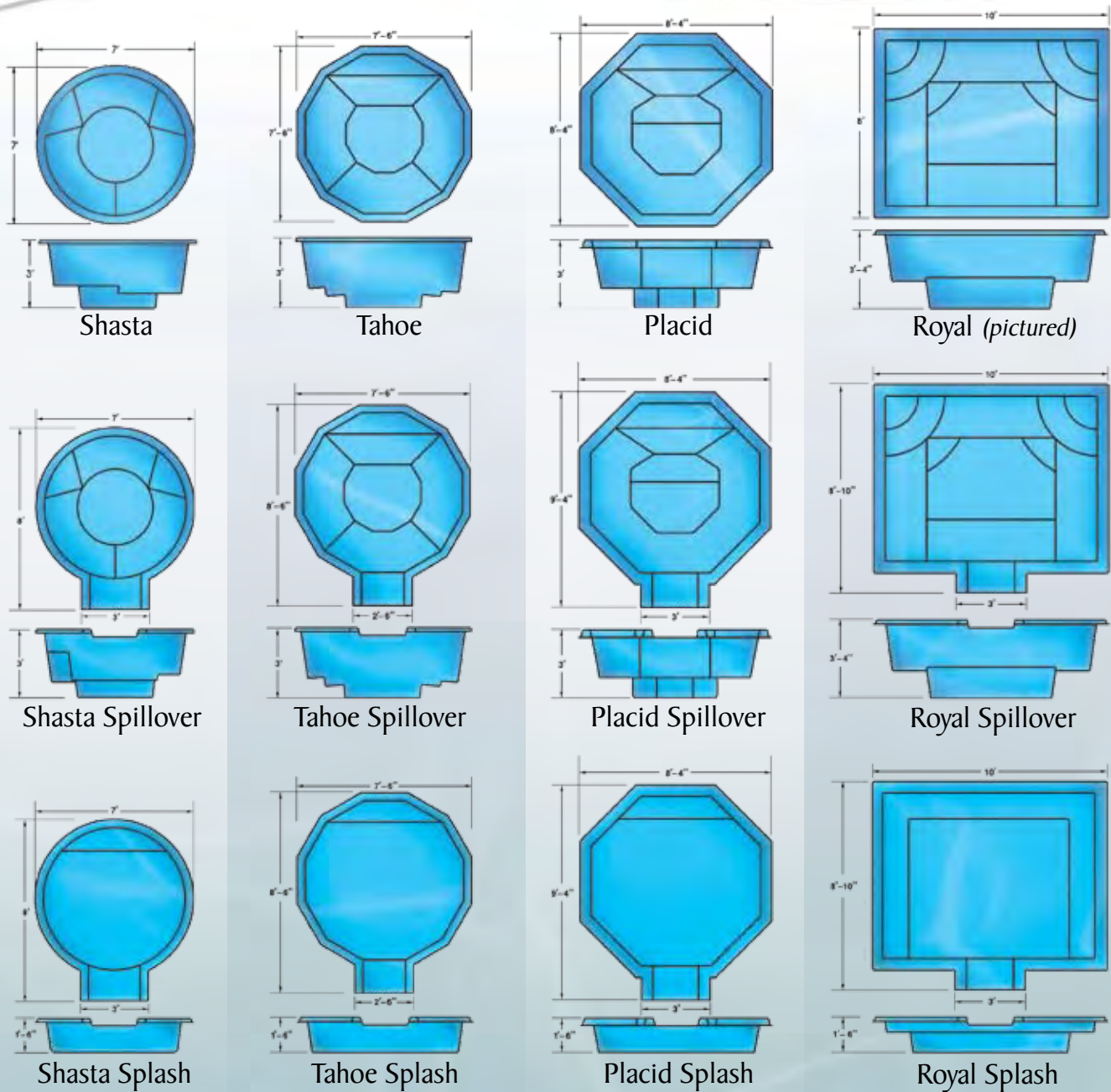

All dimensions are to outside edge. Lengths, widths, and depths may vary up to 3%. Measurements are to widest point on each side of the outside edge. All Spas and Splash Spas are Non-Diving. Use of Diving Equipment is Prohibited.

Spa Styles & Dimensions

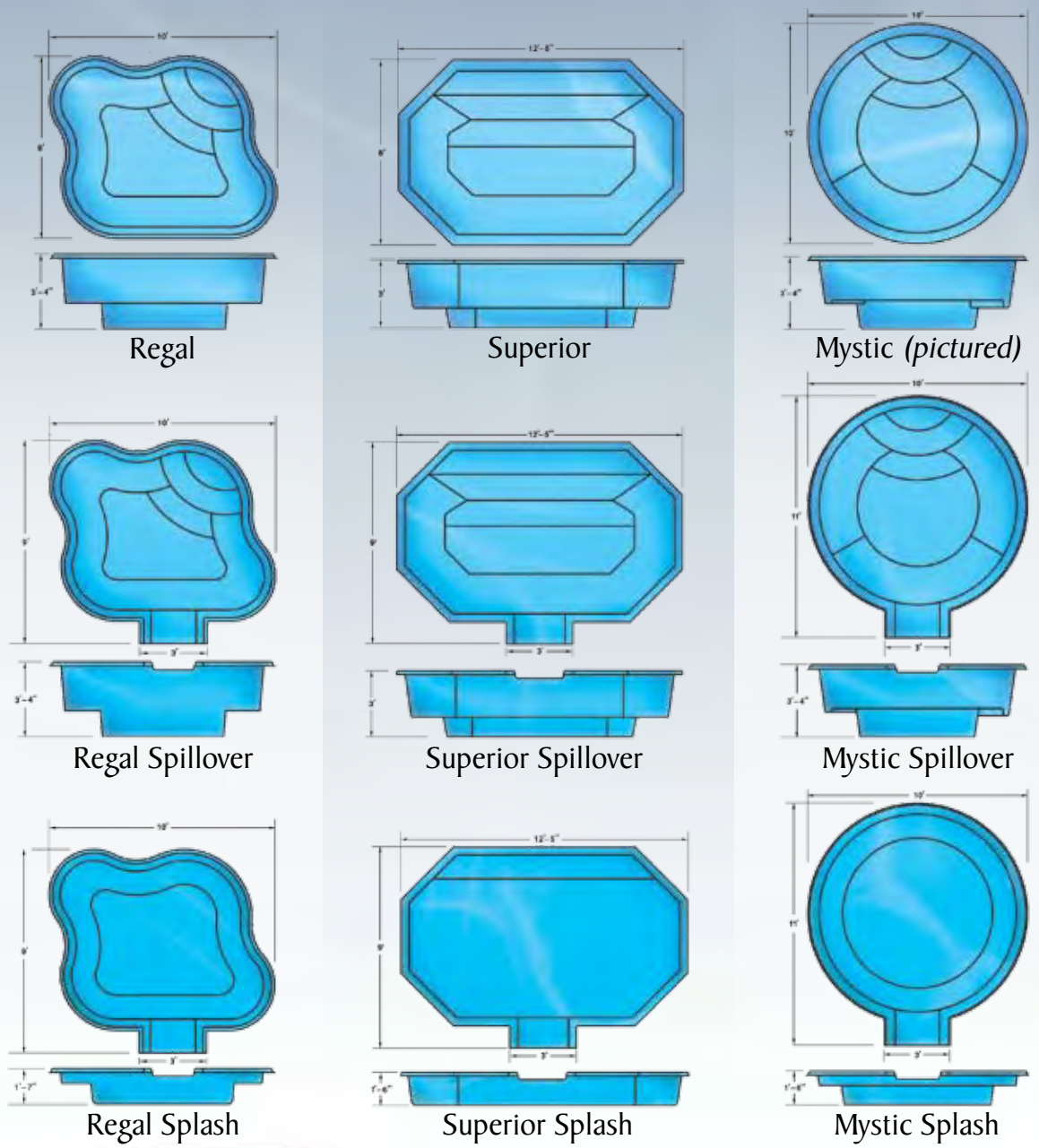

Spas & Splash Spas



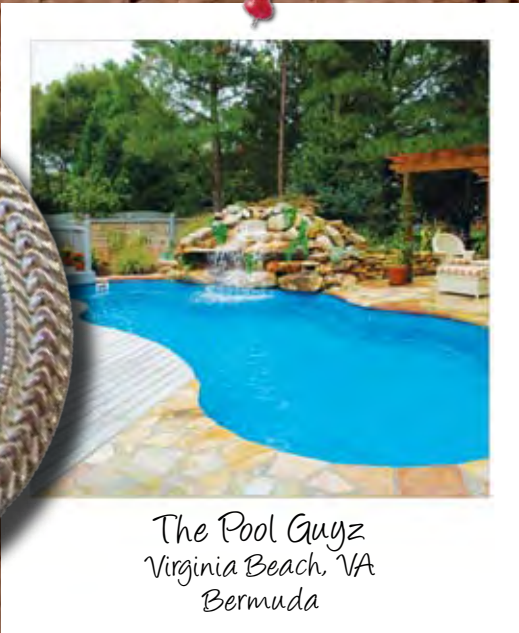

The Pool Guyz
Virginia Beach, VA
Bermuda



Fiberglass Pools of the Desert
La Quinta, CA
Caribbean & Regal Spa



Gary's Pool & Patio
San Antonio, TX
Acapulco

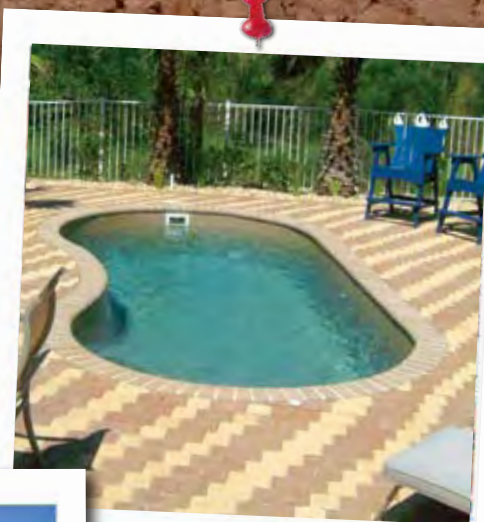

Majestic Pools & Spas
Navarre, FL
Sun Coast



Viking Pools of Sacramento
Sacramento, CA
Laguna Deluxe



Advanced Pools
Albuquerque, NM
St. Thomas



AM&C
Hollister, CA
Caribbean



Paradise Design Super Store
Draper, UT
Laguna



Custom Pools
Freemont, CA
Maui



WV Pool Construction
Jane Lew, WV
Island Breeze II



Pool Crafters
Vero Beach, FL
Regal Spa



Pool Crafters
Vero Beach, FL
Bermuda



Acapulco Pools
Phoenix, AZ
Bermuda



Renaissance Pools
Henderson, NV
Bermuda & Regal Spa

Renowned Innovations



Vanishing Edges

What better way to add mystique and intrigue to any pool than with the contemporary elegance of a vanishing edge. Vanishing edges can be incorporated into virtually any Viking pool to create the look and feel you are trying to accomplish. Who would have guessed that the pool of tomorrow would be a pool without the appearance of walls—and available today, from Viking Pools.

Viking Cascades



Listen to the intoxicating sounds of waterfalls echoing down from beautiful water features that originate in the coping of your own Viking pool. Viking Cascades are available in a variety of sizes and quantities for invigorating and attractive waterfalls that fit the size and landscape of your pool.

Tiled floors, steps, seats, and skimmers

Glass or ceramic tile can be added to the floor, steps, seats, and/or skimmers of any Viking pool or spa. These creative designs can be added to complement the shape of your pool for a polished and sophisticated look.

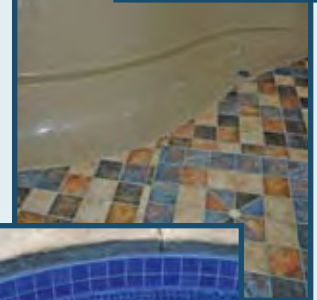

Modular Units

Extend the boundaries of your Viking pool by adding Modular Units. This feature provides the opportunity to enhance the look and feel of any Viking pool. With absolutely no limits to size, your designs are even more customizable.

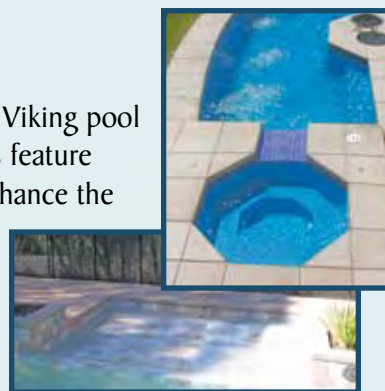

Aromatherapy

A recent study suggests that people of all age groups and nationalities experience some levels of stress—a leading cause of sickness today. Aromatherapy has become a popular form of relaxation and alternative medicine practice over the past several years. Due to the profound influence on moods and general well-being, hot tub manufacturers have been very successful offering fragrances as an add-on accessory. Viking Pools is now offering Aromatherapy for our entire pool and spa lines in four delightful scents: Ocean Breeze, Kiwi, Red Apple, and Floral.



Introducing FIJI

the first ever fiberglass pool with a
Built-in Raised Bond Beam

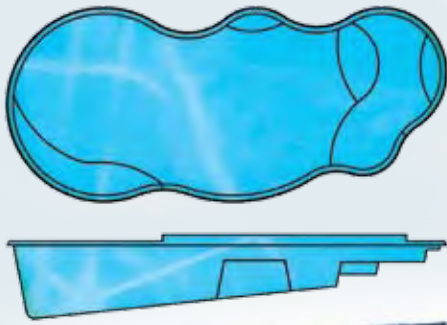

Viking Pools once again sets industry standards by introducing the first ever built-in raised bond beam pool. The Fiji also features a princess deck which adds an excellent seating area to this innovative Viking pool.



THE VIKING POOLS ADVANTAGE

Features	Viking Pools	the others	Advantage
Options: Inlayed Tile	Yes	No	Defines Steps for Safety
Options: Perimeter Tile	Yes	No	Tile Individualizes Pool
Options: Inlayed Mosaics	Yes	No	Adds Life & Character to Pool
Options: Viking Cascades	Yes	No	Built in Water Feature
Options: Fiber Optic & LED Lighting	Yes	No	Illuminates Pool
Options: Vanishing Edge	Yes	No	Pool Without the Appearance of Walls.
Options: X-tream Klean® In-Floor Cleaning System	Yes	No	Self Cleaning Pool
Manufacturing Facilities: Coast to Coast	Yes	No	CA, TX, WV, FL NATIONWIDE

Features	Viking Pools	the others	Advantage
Pool: Thickness	1/4 inch	3/16 inch	33% Thicker
Warranty: Structure/Surface	Lifetime Warranty/ 7 Yr Warranty	25 Yr Warranty/ 1 Yr Warranty	Best Warranty in the Industry
Manufacturing: Quality Assurance Program	Yes	No	Every Pool Has a Detailed Record
Technology: Period	2000's	1980's	Advanced Composite Pool
Technology: Ceramic Core	Yes	No	Enhanced Flexural Strength
Technology: Vinyl Ester Resin	Yes	Yes	Unsurpassed Blister Protection
Options: Crystite	Yes	No	Gives a Natural Look to Pool

Why Buy a Viking Fiberglass Pool?

Over 30 Years of Experience • 33% Thicker Than our Competitor's • 30 mil. Thick Gel-Coat

- Vinyl Thick Resin • Exclusive Ceramic Core • Hand Laid Fiberglass • Crystite Finishes
- Inlayed Accent Tile • Third Party Quality Control • Textured Steps and Bottom

Convenience Ledge in Deep Pools • Lifetime Limited Structural Warranty • 7 Year Warranty on Finish

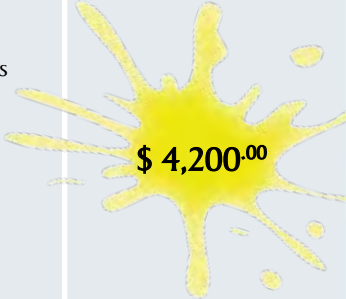
	Pros	Cons	Maintenance Cost Comparison	Total Maintenance Cost for 10 years
Viking Fiberglass Pool	<ul style="list-style-type: none"> • Quick installation (3-5 days). • Permanent home improvement that can be customized to compliment your home and your lifestyle. • Proven product with factory controlled quality. • Flexural strength that prevents cracking in freeze-thaw climates. • 17 times stronger than concrete. • Smooth finish means no skin abrasions. • Non-porous surface resists the problems associated with imbalanced water chemistry, requiring less chemical maintenance, labor, and electric and is algae resistant. • Most pool options available—perimeter tile, inlayed tile, tile mosaics, Crystite® pool finishes, built-in cascades, fiber optic lighting, vanishing edges, and in-floor cleaning systems. 	<ul style="list-style-type: none"> • Limited sizes and shapes. (Viking has 65+ designs to choose from) 	<ul style="list-style-type: none"> • No Acid Baths-ever \$ 0.00 • No replastering-ever \$ 0.00 • No tile to replace (no replastering) \$ 0.00 • Chemicals at \$15.00 per month for 10 years \$ 1,800.00 • Electric costs at \$20.00 per month for 10 years \$ 2,400.00 • Pool Service \$ 0.00 	 <p>\$ 4,200⁰⁰</p>
Gunite Pool	<ul style="list-style-type: none"> • Unlimited design capabilities. • Permanent home improvement. 	<ul style="list-style-type: none"> • 4-8 wk installation by subleased contractors. • Concrete shows through around the pool's edge. • The surface is rough and abrasive and also stains and discolors easily. • Porious surface is a breeding ground for algae and other micro-bacteria. • Cracks in freeze-thaw climates and requires acid washing and replastering. • High maintenance; monthly pool service required, excessive use of chemicals and electricity. 	<ul style="list-style-type: none"> • At least 3 acid baths in 10 years at \$350.00. \$ 1,050.00 • Replastering one time (plaster lasts about 7-8 years). \$ 3,000.00 • Tile replacement (due to replastering). \$ 1,500.00 • Chemicals at \$45.00 per month for 10 years. \$ 5,400.00 • Electric cost at \$30.00 a month for 10 years. \$ 3,600.00 • Pool service at \$20.00 a month for 10 years. \$ 2,400.00 	 <p>\$ 16,950⁰⁰</p>
Vinyl Liner Pool	<ul style="list-style-type: none"> • Low initial cost. 	<ul style="list-style-type: none"> • Temporary pool that punctures, rips, and tears. • Replacing liners periodically. • Walls can deteriorate over time. 	<ul style="list-style-type: none"> • At least 1 liner replacement due to cuts and tearing. \$ 2,500.00 • Chemicals at \$45.00 per month for 10 years. \$ 5,400.00 • Electric at \$30.00 a month for 10 years. \$ 3,600.00 	 <p>\$ 11,500⁰⁰</p>

GEL-COAT



Whisper White

GEL-COAT



Viking Blue

Pool Colors

The color of your pool will have an impact on the pool's overall appearance and ambiance. Choose from our standard colors or our exclusive Crystite® finishes to customize your Viking pool.

Due to the nature of photography, raw materials, and printing, variations in color may occur.

CRYSTITE®



Granite



Pebble Beach



Sapphire Blue



Pacific Blue



New

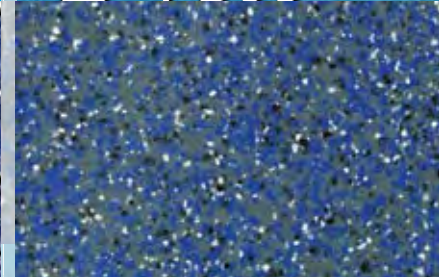
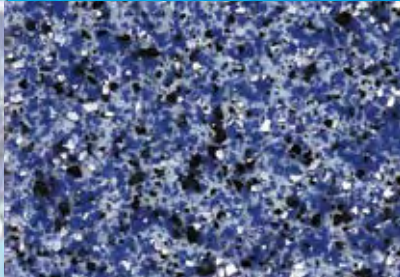
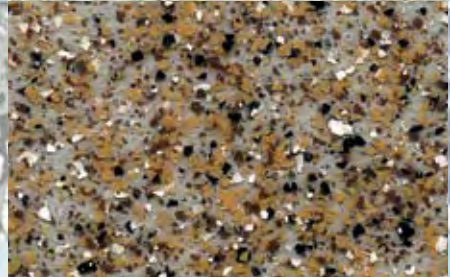
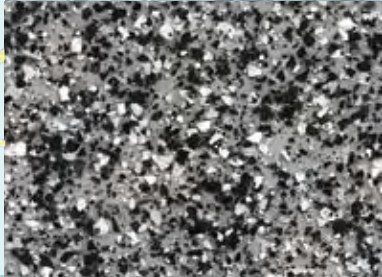

Personal Paradise

Not only does Viking offer numerous pool sizes and shapes to fit your home and landscape, but you will also be able to choose from more options than any other pool manufacturer, including handcrafted tiles, mosaics, and inlayed tiles. Create and decorate a private oasis in your own backyard.

Mosaics

Mosaic tiles reflect charm and personality, adding to the overall appeal of your pool. Reflect your own personality in your pool with a selection from Viking's standard product line or a custom mosaic of your own creation.

Artistry in Mosaics, Inc. is the largest manufacturer of quality, handcrafted ceramic mosaic tile designs in the world. Since 1987, Artistry in Mosaics has been creating fun and exciting hand cut tile mosaics for applications in swimming pools.



artistryinmosaics inc
integrity in product and people

Inlaid Tiles

Inlaid tiles offer a striking way to emphasize stairs and seats for safety and a unique appearance to your Viking pool.

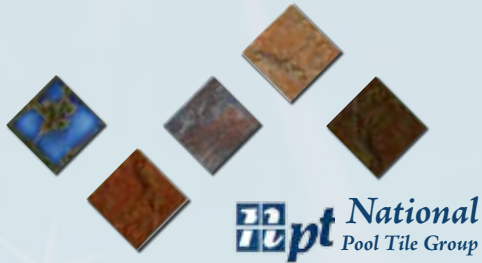

pt National
Pool Tile Group

Perimeter Tiles

You can also accent your pool with a distinctive border in a wide variety of standard tiles or a custom selection available from your Viking representative.

BORREGO

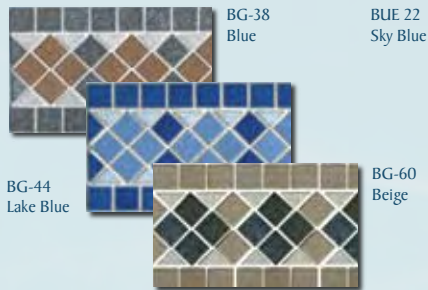

BOTANICALS

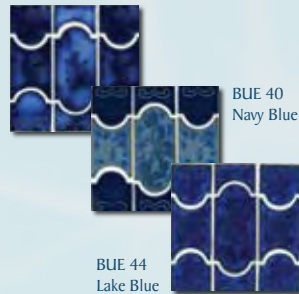

RIPTIDE

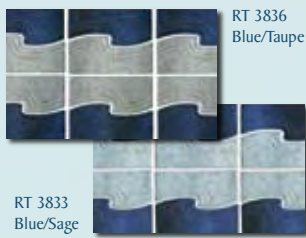

AVALON

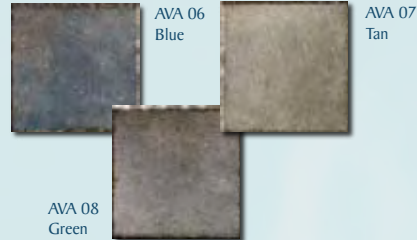

AZTEC

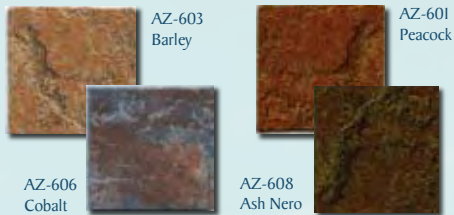

VENUS (Glass Tile)



Create your own paradise that suits your personal style.

Effortless Maintenance

Chemical Distribution & Cleaning

The VCS and X-tream Klean® systems are unlike conventional cleaning systems. The patented pop-up nozzles on the pool's floor emit a powerful stream of pressurized water—circulating treated, filtered water through every layer of your pool. This “bottom-to-top” circulation eliminates areas below the surface where bacteria and algae grow, reducing the amount of chemicals needed—resulting in dramatic savings on chemical costs.

Heat Savings

The VCS and X-tream Klean® systems turn your pool into a passive, solar-heated pool—saving energy and extending your swimming season. By circulating solar-heated water from the top of your pool to the bottom, constant temperatures are maintained throughout the pool—eliminating uncomfortable “cold spots” and resulting in as much as 50% savings over conventional heaters.

Maintaining a clean, healthy, warm pool is easier and more affordable than ever with Viking Pools and X-tream Klean® systems, which provide chemical distribution and heat savings through your choice of four cleaning systems.

Viking's Circulation System (VCS): Includes two nearly-invisible pop-up circulation nozzles in the pool's floor.

X-tream Klean® System: Designed similar to the VCS system with the added benefits of a network of nozzles. This provides additional cleansing power for the entire bottom of the pool, forcing debris towards the active main drain for easy removal.

X-tream Klean® Plus: Extra cleaning heads are also placed in steps and seats for a more complete pool cleaning.

X-tream Klean® Deluxe: Cleaning heads are located on the floor, steps and seats. In addition, a debris canister is located next to the skimmer to catch large debris.

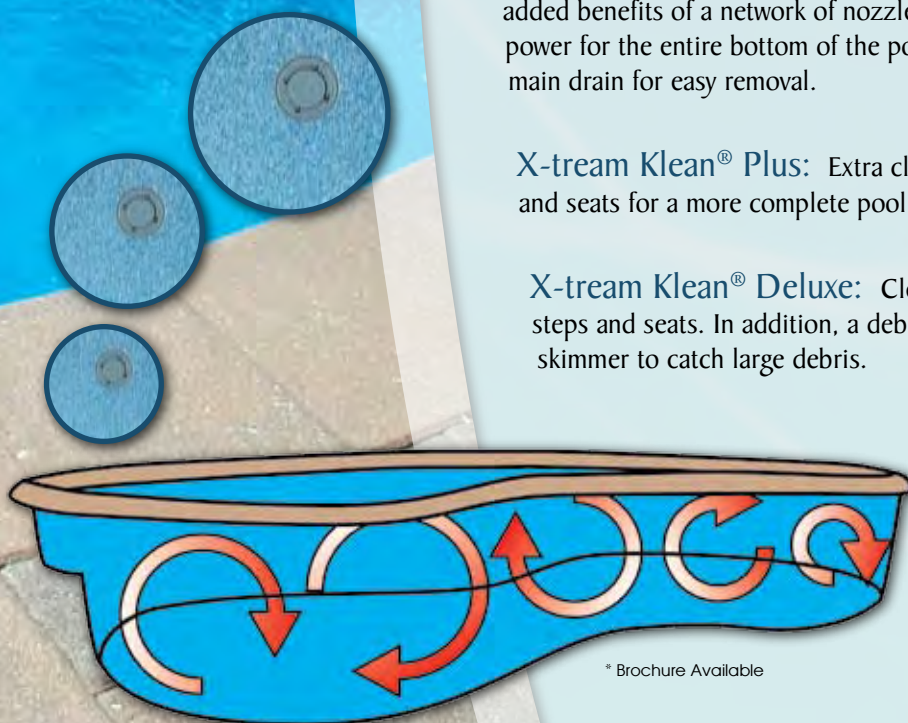

* Brochure Available



Lighting from FIBERSTARS®

Fiber Optic Technology in Lighting™

Enjoy the beauty and romance of your Viking pool by night with lighting from Fiberstars®, the nation's leader in swimming pool lighting systems.

Fiber Optic Lighting

Set the mood with your choice of four colors. With the added luminescence of fiber optics, you will be able to capture your pool's beauty by day as well as night.

As pioneers in the fiber optic field, Fiberstars® allows you to highlight virtually anything, from your pool and spa to landscaping and patio designs. Fiberstars® fiber optic lighting can also be used with water features such as Viking Cascades to highlight the movement of an unbroken, falling waterfall.

The Fiberstars® color wheel gives you the creative freedom to light your pool, spa, waterfall, and surrounding landscape with four color combinations to fit your personality and taste.

L.E.D. Lighting

The PAL-2000 provides a totally new concept in Underwater Pool/Spa and Aquatic Landscape Lighting Design.

Utilizing new molding materials, it has been possible to produce a compact light fitting with unique features that are not currently available from any other existing pool or spa lighting product.

Even-Glo Light Distribution:
created by a unique
prismatic lens design.

L.E.D Color Changing :
six colors with disco mode,
fully synchronized.

Color Change Digital Array:
can be fitted with a 100,000 hr
color change array with color
lock on six different colors or
two color change modes.

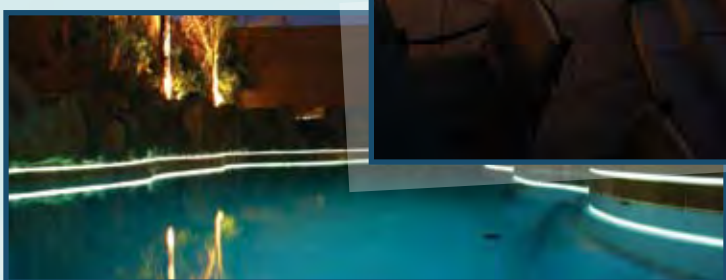

Charm & Ambiance

Protection for your Pool and Family

Advanced Safety Covers

Advanced Safety Covers are manufactured specifically to fit your pool size and shape.

Solid Safety Cover with INVIS-A-DRAIN™

Every 6" there are ¼" drain holes inserted in reinforced vinyl, down the center of the pool cover. Underneath is a 12" wide mesh drain filter panel designed for simple cleaning.

Solid Cover with Optional Pump

Use of a weighted cover pump will rapidly pump off all standing water and will maintain all applicable safety standards.

Strong as its Seams

Advanced Safety Covers are equipped with interlocking seams, double overlapped for ultimate strength and coverage.

Excellence and Durability

Durable box tack reinforcements are found on all safety straps. Protective pads are located at step nosing to prevent abrasion.



* Brochure Available

Ultra (Automatic Safety) Cover

The ULTRA COVER™ system is a UL® approved safety cover and also meets all ASTM™ powered safety cover requirements.

Jump Right in, Whenever You Want

You just flip a switch and in less than a minute you're ready to take a well deserved and refreshing break from the everyday stresses of life.

Keep Out the Dirt and Leaves. Keep in Water, Heat and Pool Chemicals

Like a lid on a jar, the ULTRA COVER™ system prevents leaves and dirt from getting into your pool while keeping the good things like heat, water and chemicals, from going out. Most of the maintenance and cost of pool ownership can be dramatically reduced by covering your pool when it's not in use.

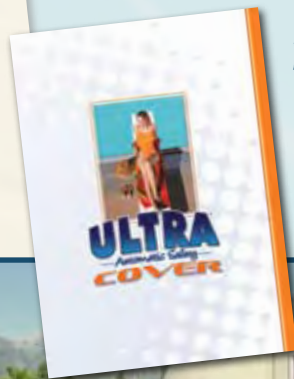

* Brochure Available

Little People, Big World

Viking Pools had the pleasure of working with Matt Roloff and the Roloff family to install a pool in their backyard on the set of TLC's *Little People, Big World*, a reality show that follows the lives of the family of six living near Portland, Oregon.

A Gulf Coast pool was installed with modified steps to accommodate the family's special needs. The pool installation was featured on *The Learning Channel*.

When asked why a Viking pool, Matt Roloff replied that Viking offered everything the family needed.

“Viking has the benefit of a big corporation and the benefit of a family owned business.” – Matt Roloff

Extreme Makeover: Home Edition

Viking pools has also worked with ABC's Emmy nominated *Extreme Makeover: Home Edition* on several episodes. The reality show helps families in need by renovating their home and backyard.

Viking called on selected dealers to assist with the installations to complete the show's phenomenal seven-day transformation. For more information about Viking's involvement in the show visit www.VikingPools.net.

Viking's pools have also appeared on:

American Builder,
The Adam Corolla Project,

Rapid Remodel,
The Real World,

and various organizations like *Camp Heartland*, a non-profit camp for children living with AIDS/HIV.



As Seen On TV

The Benchmark of Quality Pools

When something is well made, from high-quality materials as a Viking pool, you'd expect the company to stand behind it. And Viking does, with a lifetime structural warranty. This warranty means, among other things, that your Viking pool will outlive you. But don't let that worry you. Just get out there, swim, and have a good time with your friends and family. If you have any questions or comments about our pools, just pick up the phone and call. Viking's pools and spas can be installed by independent pool contractors. Call 800-VKG-Pool for the name of a dealer in your area or visit our web site at www.VikingPools.net.



NOTICE AND DISCLAIMER TO CUSTOMER AND BUYER OF NON-RELATIONSHIP BETWEEN DEALERSHIP AND MANUFACTURER

This NOTICE AND DISCLAIMER is made to all retail customers and buyers of Viking Pools in the United States.

You are by this NOTICE advised that Viking Pools are sold by independent dealers and dealerships. Each dealer is an independent business person, who is completely separate from the manufacturer of Viking Pools. Each dealer is an independent contractor, and no dealer is an owner, agent (in fact or law), or employee of Viking Pools, the manufacturer.

Viking Pools, the manufacturer, hereby DISCLAIMS any liability for an intentional or negligent act by any Viking Pools dealer or dealership or any damage to any Viking Pool caused by an act of any dealer or dealership. Viking Pools will not be responsible or liable for any damages caused by any dealer or dealership. Viking Pools, as the manufacturer, offers a separate warranty to all customers and buyers of Viking Pools. That warranty offered by Viking Pools, the manufacturer, is separate and apart from other or additional warranty or guarantee offered by any dealer or dealership.

Any statement in any advertisement, literature, brochure, or website should NOT be interpreted or construed to expressly or impliedly create any relationship between Viking Pools and any dealer or dealership contrary to this NOTICE AND DISCLAIMER.



Feet First™

Always Enter Pool Feet First.
Diving May Result in Injury or Death.

Have a conversation with your pool provider about the correct use and installation of safety devices like; safety ropes, child safety barriers, pool surface alarms, and safety covers. Every pool should be surrounded by a locked and gated fence in compliance with the National Spa and Pool Institute's guidelines, as well as with local building and safety codes.

Safety should be the first priority of any new or existing pool owner. Make sure to take the necessary steps to assure that you, your friends, family, and anyone else in or around the pool are familiar with the guidelines of its safe and sensible use. Smart pool owners urge their guests to not use it under the influence of alcohol, drugs, stimulants, prescription medications, or anything else that could by any way hinder their judgment or abilities.

With your pool, you will receive a free pool Customer Information Kit, including:

- Safety Sign Installation / Illustration Sheet
- Signs & Labels
- The Sensible Way to Enjoy Your Inground Swimming Pool (NSPI Publication)
- Children Aren't Waterproof (NSPI Publication)
- Inground Pool Owner's Handbook
- Warranty
- Use & Care Manual
- Warning Label

We strongly recommend the use and careful placement of all safety stickers and signs included in your pool owner's safety kit. It's also a good idea to contact your local American Red Cross for available CPR classes and other vital safety programs.



Pool Safety



Isn't it your turn
...to experience the
pure enjoyment,
complete relaxation,
and endless hours of
recreation that
come with owning
a Viking Pool?



VIKING POOLS

www.VikingPools.net

P.O. Box 96

Williams, CA 95987

P.O. Box 60045

Midland, TX 79711

P.O. Box 550

Jane Lew, WV 26378

40119 County Road

Zephyrhills, FL 33540

This brochure represents pool finishes as closely as possible. Due to the nature of photography, raw materials, and printing, variations in color may occur. Lengths, widths, and depths may vary up to 3%. Measurements are to largest section on each side of the outside edge. Viking Pools dealers are independent contractors.