

## POWER INFORMATION

Input Voltage: 12 V DC  
Amperage: 0.800 A  
Electric Consumption: 9.6 W

### PowerAdapter Specifications:

- Input Voltage: 100-240 V AC
- Input Frequency: 50/60 Hz
- 12V DC output
- Options:
  - Stepdown Transformer (in-line)
    - Rated Current: 2.1 A
  - Wall Mount Transformer
    - Rated Current: 2.08 A

## SIZING INFORMATION

-specified by daily ice production-  
CLIZ-05: up to 600 lbs  
CLIZ-10: between 600 and 1200 lbs  
CLIZ-20: >1200 lbs  
-high yeast environments may require a larger model

## FEATURES

PlasmaProtect®  
NSF Compliant Universal Installation Kit

## APPLICATIONS

Ice Machines  
Ice Bins  
Beverage Dispensers  
Refrigerators

## OPTIONS

Stepdown Transformer (in-line)  
Wall Mount Transformer

## WARRANTY

Warranty valid in United States and Canada.  
Contact factory for warranty in other countries.  
One year Parts and Labor on entire unit.

## Product Certifications:



# Closed Loop IceZone® Sanitation System

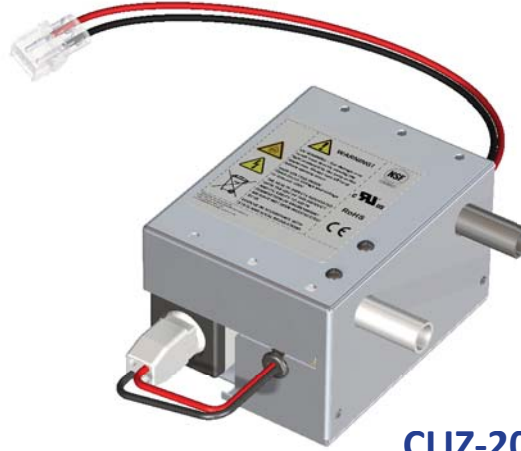

**CLIZ-20**  
Shown

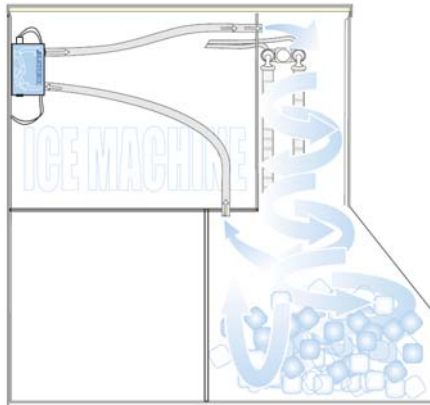

**CLIZ-20**  
Shown installed in an ice machine

- Prevent slime and mold
- Keep ice machines, ice bins, and beverage dispensers clean
- Reduce equipment cleanings and associated costs
- Reduce bacteria, yeast, and other microorganisms
- Decrease technical malfunctions and equipment downtime
- Completely automated and chemical-free
- Maintenance free – requires a simple annual UV lamp replacement

## © BioZone Scientific International, Inc.

7751 Kingspointe Parkway  
Suite 124  
Orlando, FL 32819  
USA



**Closed Loop IceZone®- 05, 10, 20**  
**Product Family: IceZone®**  
**Model: CLIZ-05, CLIZ-10, CLIZ-20**  
**Description: Sanitation System**

# BIOZONE®

## ORDER INFORMATION

### Closed Loop IceZone®

CLIZ-05

CLIZ-10

CLIZ-20

### Replacement UV Lamps

CLIZ-05: 10-04010

CLIZ-10: 10-04050

CLIZ-20: 10-04100

### Replacement Power Supply

Wall Mount (White): 16-2000

Wall Mount (Black): 16-2001

In-line: 16-2002

## SPECIFICATIONS

Length: 5"

Width: 4"

Height: 2.6"

Weight: 1 lb

## CONTENTS

Closed Loop IceZone®

UV Lamp (pre-installed)

Power Supply (must specify)

Owner's Manual and Installation Guide

Installation Kit, Mounting Bracket, Wiring

includes NSF compliant:

- tubing
- fittings
- clamps

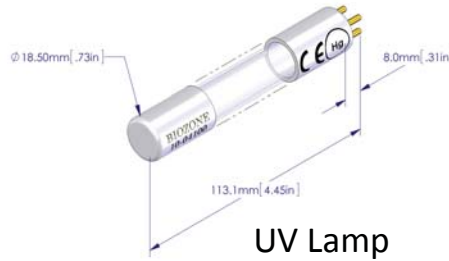

UV Lamp

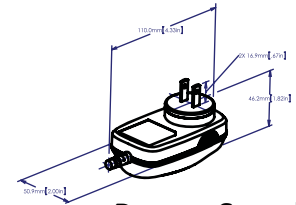

Power Supply

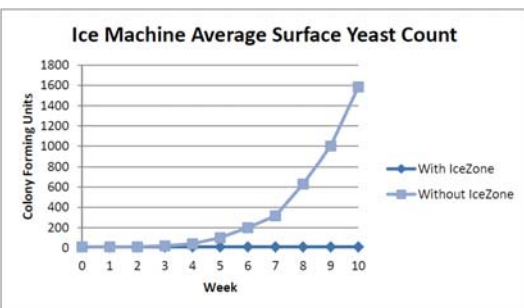
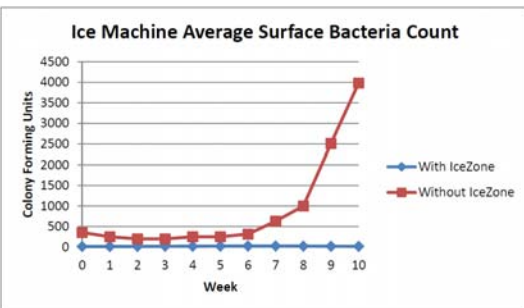
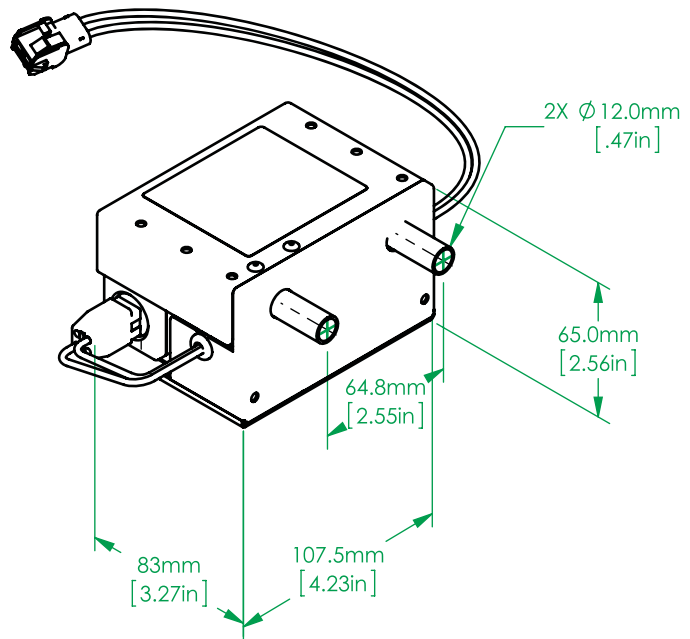

**Compatible with all Major Ice Machine Manufacturers**  
 (new and retrofit installations of ice machine and ice bins)



**Includes PlasmaProtect® Advanced Technology**  
 Customized photoplasma distribution system that targets the vulnerable areas of equipment to provide added protection.

© BioZone Scientific International, Inc.

7751 Kingspointe Parkway  
 Suite 124  
 Orlando, FL 32819  
 USA

