

TriStar



Engineered Plastic Solutions™



TriSteel™



Engineering | Custom Fabrication | Manufacturing

Material Name	Category	Data Sheet	MDS	Specific Gravity	Yield Strength (psi)	Tensile Strength (psi)	Tensile Modulus (psi)	Yield Modulus (psi)	Yield Elongation (%)	Tensile Elongation (%)	Yield Modulus of Elasticity (psi)	Yield Strength (ksi)	Yield Modulus (ksi)
15K Glass Filled PTFE	Rulon (Engineered PTFE)	Data Sheet		2.2	2,750		300	1,900	155,000	2,000			
PC Composite Bearings	Composite Bearing Materials	Data Sheet	MDS050	1.9									\$0.0000
PTFE	Fluoropolymers (PTFE)	Data Sheet		2.16	9,800	80,000	800		70,000	8,800			
Rulon A10	Rulon (Engineered PTFE)	Data Sheet	MDS050	2.3	1,500		130	600					
Rulon DC1242	Rulon (Engineered PTFE)	Data Sheet		1.96	1,500	200,000	40		1,870				
Rulon DC1285	Rulon (Engineered PTFE)	Data Sheet		1.94	1,800	238,000	40	640					
Rulon E	Rulon (Engineered PTFE)	Data Sheet		2.28	2,000	240,000	100	800					
Rulon B 1410	Rulon (Engineered PTFE)	Data Sheet	MDS050	2.2	2,150			210					
Rulon B 1345	Rulon (Engineered PTFE)	Data Sheet	MDS050	2.11	9,800			400					

Material Data

Use our material database to filter and compare hundreds of the most popular high performance plastics in the industry based on specific characteristics.

Filter, compare and call on our engineering team to help you choose the right material and component geometry for your application.



Educational Seminars

We offer a series of training seminars on a variety of subjects relative to materials, component design and applications.

Custom seminars are available for your specific industry. Contact TriStar's technical department for more information.

Topic	Title
High Performance Materials	Pushing the Design Envelope of Plastics
Plane Bearing Technology	The Application of Self-Lubricating Materials in Bearings
Composites	Materials for Extreme Bearing Structural Applications
Fluoropolymers	Specific Overview of Fluoropolymers and their Applications

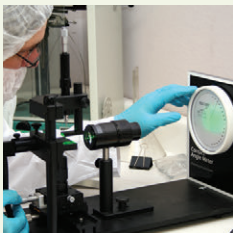

Analytical Services

We offer a complete array of surface analysis and materials characterization solutions by providing services that help companies get the critical information they need.

Our analytical techniques include:

- FTIR
- XPS
- AFM
- Goniometry
- Durometer [shore A shore D]
- Haze, Transmittance, Clarity [mainly transparent materials]
- Tensile Pull Testing [shear and T-peel]
- Compression Testing
- Flexural Testing



Enhanced Materials Division

From enhancing cell culture trays to bonding dissimilar materials, the scientists at TriStar's Enhanced Materials Division (EMD) can assist you in identifying problems and recommending solutions for your toughest surface issues.

Our services include:

- Plasma Treatment
- Asymmetric & Symmetric Filtration Membranes
- Specialized Primers & Coatings

Our expert technicians apply unique, dry, environmentally-friendly techniques to modify the surface of polymers, elastomers, and films in order to dramatically increase (or, if desired, decrease) the bond strength of adhesives, paint, markings, or specialty coatings.

TriStar
Engineered Plastic Solutions

PRODUCTS INDUSTRIES ENHANCED MATERIALS ENGINEERING RESOURCES ABOUT US CONTACT

Engineered Plastic Solutions

Your engineering partner from prototype to production

TriStar Plastics Corp. provides engineering, custom fabrication and manufacturing of high-performance plastics and self-lubricating bearings materials. Our capabilities include component design, material selection, prototype, production and manufacturing.

Material Database: Search our database of 450+ plastic materials

Ask The Expert: Engineering assistance & material selection support

Technical Library: Spec sheets, design worksheets, case studies & brochures



Our site has been praised by engineers and purchasing agents alike. We continually strive to make this site an indispensable engineering resource for your company.

- Engineering Tools
- Ask the Expert
- Tech Talk Blog
- On-line Brochures
- Material Database
- Product Videos
- Web Store
- Customer Portal

With our in-house technical and scientific staff we can resolve any challenge and help you find the right engineered plastic solution.



All TriSteels are 100% Lead Free



TriSteel™

TriSteel™ is a metal backed system that is self-lubricating and is used in the most rigorous applications. ■ TriSteel bearings utilize special polymer liners for self-lubrication and improved wear properties. Each material has a specific wear rate dependent on the speed, load, temperature, lubrication and hardware of the application. ■ The metal backing supports liner materials made to withstand high loads, speeds and adverse environments. The advantage of the TriSteel™ design is that even if wear-thru occurs in the liner, the supporting interlayer is a self-lubricating material as well.

3

TriSteel bearings are available in inch and metric dimensions in various combinations of liners and backing materials. When ordering TriSteel bearings follow the format and codes as shown below.

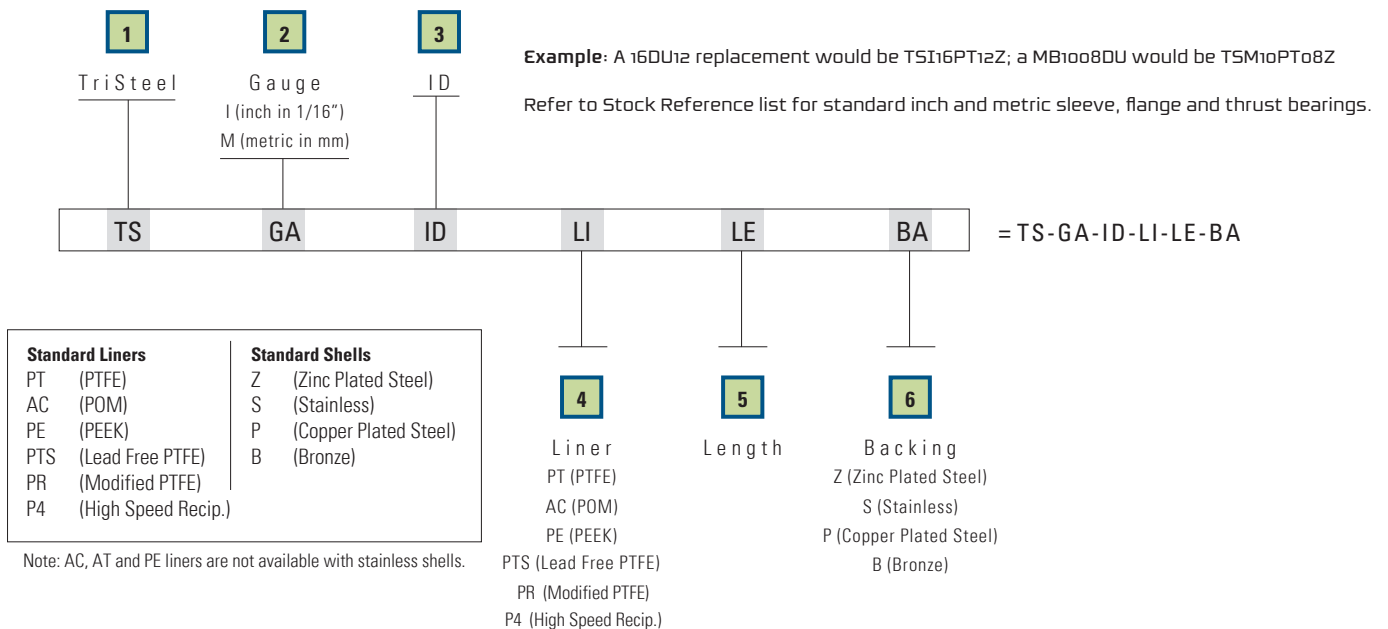

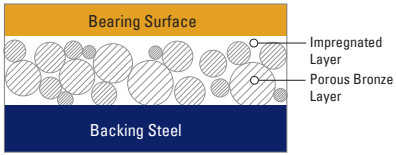

TriSteel bearings are produced by impregnating a self-lubricating, polymer liner into a sintered porous bronze interlayer. The steel backing material provides structural and mechanical support for the bonding layer and the bearing surface. The steel backing can be zinc or copper plated or stainless steel can be used for maximum corrosion resistance.



Benefits

- Cost Competitive
- Improved Wear Properties
- Stable
- No Lubrication Needed
- Available in Inch and
- Metric Dimensions

Applications

- Agricultural Equipment
- Hydraulic Components
- Aircraft/Aerospace
- Automotive
- Construction Equipment
- General Engineering

Property	Units	PT (PTFE)	AC (POM)	PE (PEEK)
P Factor				
Steady Unidirectional loads, radial	psi	20,000	20,000	26,000
Steady Unidirectional loads, oscillating	psi	20,000	10,000	26,000
Steady, Continuous rotation, oscillation	psi	8,000	10,000	13,500
Dynamic Continuous rotation, oscillation	psi	8,000	6,000	8,800
Maximum Static Load	psi	36,000	36,000	40,000
V Factor				
Maximum Speed - Unlubricated	fpm	1,000	<i>Consult with TriStar Engineering</i>	
Maximum Speed - Lube / Oil	fpm	2,000	500	2,000
Maximum Speed - Lube / Grease	fpm	2,000	100	2,000
Maximum PV Limits	psi/fpm	50,000	80,000	100,000
Impact Strength - Notched	ft-lbs/in.	>20	>20	>20
Coefficient of Friction Dynamic - Dry		.08- .12	.15- .20	.15- .20
Wear Factor	Kx10 ⁻¹⁰	9	21	5
Operating Temperature				
Minimum	°F	-300	-40	-140
Maximum - Continuous	°F	535	210	500
Coefficient of Thermal Expansion (x10⁻⁶)				
Parallel to Surface	in/in/°F	6	18	4.5
Thermal Conductivity	BTU/hr/ft ² /°F/in	288	30	28
Water Absorption - 24 hour saturation	%	0	0.02	0.15
Liner Thickness	in	0.002	.018- .020	.018- .020



All TriSteels are
100% Lead Free

TriSteel Design Information

TriSteel Liner Options

PT – Sintered porous bronze on metal substrate with PTFE calendared into the dynamic wear surface. High PV, self lubricating and long wear life. Commonly used in lift and tilt applications in construction, material handling, textile, hydraulic components, agriculture and forestry machinery.

AC – Sintered porous bronze on metal substrate with PDM calendared into the dynamic wear surface. Requires boundary lubrication for optimum performance. High PV rating, low speeds. Commonly used in mining equipment, rolling mills, automotive chassis components and other applications where bronze bushings are utilized.

PM – Special modified PTFE heavy liner with enhanced wear properties. Used in linear motion devices where lubrication is not desirable. Also used in automotive shock and strut applications where high speed linear rods can experience high side loading. Available in rod or piston configurations.

PE – Modified PEEK with self lubricating additives for applications where chemicals may be utilized. Excellent wear in both wet or dry applications. Available with a bronze substrate for use as chemical pump or valve bushings. Extra thick liner allows for slight modifications for shaft misalignment.

PR – No lead, enhanced PTFE liner for dampening devices, hydraulic motors, automotive lift and pivot devices and linear motion equipment. Popular use is for bicycle and motorcycle shock absorbers as piston and rod wear bearings. Exceptional wear properties in unlubricated service. Service equivalent to DP4 grade.

AT – Thicker POM liner with PTFE lubricant added for unlubricated service. Used extensively in ski lift operations for pivot points on towers and chair clips. Also useful in cranes, textile machines, printing equipment and light duty hoists. Service equivalent to DS grade.

ID/ Wall Dimension Criteria – Inch Size PT,PM,PTS,PR,PTO Liners

For inch size bearings the following standards are available:

- ID – 1/8 thru 5/16 – .032" wall
- ID – 3/8 thru 11/16 – .047" wall
- ID – 3/4 thru 1 – .062" wall
- ID – 1-1/8 thru 1-5/8 – .079" wall
- ID – 1-3/4 thru 7 – .093" wall

Sizes up to 1-1/4" can be made up to .062" wall on special order
Sizes over 4" ID can be made with .118" wall on special order

ID/Wall Dimension Criteria – Metric Size PT, PM,PTS,PR,PTO Liners

For metric size bearings the following standards are available:

- ID – 2mm thru 4mm – 0.75mm wall
- ID – 5mm thru 18mm – 1.0mm wall
- ID – 20mm thru 25mm – 1.5mm wall
- ID – 28mm thru 40mm – 2.0 mm wall
- ID – 45mm thru 300mm – 2.5mm wall

Sizes up to 30mm ID can be made with 1.5mm wall on special order
Sizes over 100mm can be made with 3.0mm wall on special order

ID/Wall Dimension Criteria – Inch Size AC, AT, PE Liners

For inch size bearings the following standards are available:

- ID – 1/2 thru 1-1/8 – .067" wall
- ID – 1-1/4 thru 1-5/8 – .083" wall
- ID – 1-3/4 thru 3 – .093" wall

For metric size bearings the following standards are available:

- ID – 8mm thru 18mm – 1mm wall
- ID – 20mm thru 25mm – 1.5mm wall
- ID – 28mm thru 40mm – 2.0mm wall
- ID – 45mm thru 300mm – 2.5mm wall

**NOTE: 28mm ID AC/AT liners are available in 1.5mm and 2.0mm walls
AC/AT/PE liners are available with or without lubrication holes. Consult with Engineering before recommendation to customer.**

Thrust Washers – PT,PM,PTS,PR Liners

For inch size thrust washers the following standards are available:

- ID – 1/2 thru 1-3/4 – .059" thick
- ID – 2 thru 2-1/4 – .090" thick

For metric size thrust washers the following standards are available:

- ID – 10mm thru 42mm – 1.45mm thick
- ID – 48mm thru 62mm – 1.95mm thick

Thrust Washers – AC,AT,PE Liners

For inch size thrust washers the following standards are available:

- ID – 5/8 thru 1-3/4 – .062" thick
- ID – 2 thru 2-1/4 – .093" thick

For metric size thrust washers the following standards are available:

- ID – 12mm thru 42mm – 1.5mm thick
- ID – 48mm thru 52mm – 2.5mm thick

Non standards can be made on a special run basis.

Length Tolerances

Inch sizes tolerance – Up to 3/8" ID or length: $\pm 0.015"$, Over 3/8" ID or length: $\pm 0.010"$

Metric sizes tolerance – Up to 10mm ID or length: $\pm 0.38\text{mm}$, Over 10mm ID or length: $\pm 0.25\text{mm}$

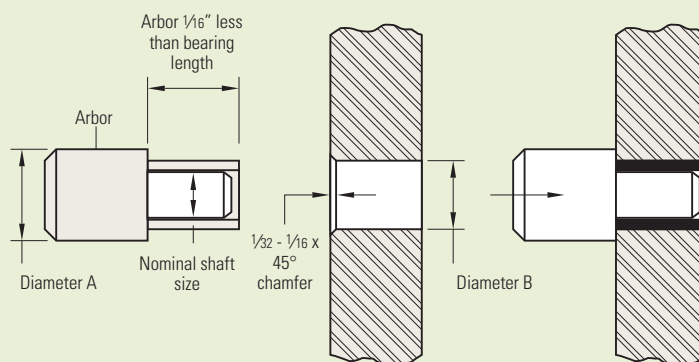

TriSteel Installation Dimensions for PT, PTS, PM, and PR Liners

Tri-Star Part NO.	Shaft Dia	Length	Housing Bore	Shaft Dim's	Installed ID
TSI06XX06X	3/8"	3/8"	.4684/.4691	.3740/.3731	.3742/.3769
TSI06XX08X	3/8"	1/2"	.4684/.4691	.3740/.3731	.3742/.3769
TSI06XX12X	3/8"	3/4"	.4684/.4691	.3740/.3731	.3742/.3769
TSI08XX06X	1/2"	3/8"	.5934/.5941	.4990/.4980	.4992/.5019
TSI08XX08X	1/2"	1/2"	.5934/.5941	.4990/.4980	.4992/.5019
TSI08XX10X	1/2"	5/8"	.5934/.5941	.4990/.4980	.4992/.5019
TSI08XX14X	1/2"	7/8"	.5934/.5941	.4990/.4980	.4992/.5019
TSI10XX08X	5/8"	1/2"	.7184/.7192	.6240/.6230	.6242/.6270
TSI10XX10X	5/8"	5/8"	.7184/.7192	.6240/.6230	.6242/.6270
TSI10XX12X	5/8"	3/4"	.7184/.7192	.6240/.6230	.6242/.6270
TSI10XX14X	5/8"	7/8"	.7184/.7192	.6240/.6230	.6242/.6270
TSI12XX12X	3/4"	3/4"	.8747/.8755	.7491/.7479	.7493/.7525
TSI12XX16X	3/4"	1"	.8747/.8755	.7491/.7479	.7493/.7525
TSI14XX12X	7/8"	3/4"	.9997/1.0005	.8741/.8729	.8743/.8775
TSI14XX16X	7/8"	1"	.9997/1.0005	.8741/.8729	.8743/.8775
TSI16XX12X	1"	3/4"	1.1247/1.1255	.9991/.9979	.9993/1.0025
TSI16XX16X	1"	1"	1.1247/1.1255	.9991/.9979	.9993/1.0025
TSI18XX12X	1-1/8"	3/4"	1.2808/1.2818	1.1238/1.1226	1.1240/1.1278
TSI18XX16X	1-1/8"	1"	1.2808/1.2818	1.1238/1.1226	1.1240/1.1278
TSI20XX12X	1-1/4"	3/4"	1.4058/1.4068	1.2488/1.2472	1.2490/1.2528
TSI20XX16X	1-1/4"	1"	1.4058/1.4068	1.2488/1.2472	1.2490/1.2528
TSI22XX16X	1-3/8"	1"	1.5308/1.5318	1.3722/1.3738	1.3740/1.3778
TSI22XX24X	1-3/8"	1-1/2"	1.5308/1.5318	1.3788/1.3722	1.3740/1.3778
TSI24XX16X	1-1/2"	1"	1.6558/1.6568	1.4988/1.4972	1.4990/1.5028
TSI24XX24X	1-1/2"	1-1/2"	1.6558/1.6568	1.4988/1.4972	1.4990/1.5028
TSI24XX32X	1-1/2"	2"	1.6558/1.6568	1.4988/1.4972	1.4990/1.5028
TSI26XX16X	1-5/8"	1"	1.7808/1.7818	1.6238/1.6222	1.6240/1.6278
TSI26XX24X	1-5/8"	1-1/2"	1.7808/1.7818	1.6238/1.6222	1.6240/1.6278
TSI26XX32X	1-5/8"	2"	1.7808/1.7818	1.6238/1.6222	1.6240/1.6278
TSI28XX16X	1-3/4"	1"	1.9371/1.9381	1.7487/1.7471	1.7489/1.7535
TSI28XX24X	1-3/4"	1-1/2"	1.9371/1.9381	1.7487/1.7471	1.7489/1.7535
TSI28XX32X	1-3/4"	2"	1.9371/1.9381	1.7487/1.7471	1.7489/1.7535
TSI30XX16X	1-7/8"	1"	2.0621/2.0633	1.8737/1.8721	1.8739/1.8787
TSI30XX30X	1-7/8"	1-7/8"	2.0621/2.0633	1.8737/1.8721	1.8739/1.8787
TSI30XX36X	1-7/8"	2-1/4"	2.0621/2.0633	1.8737/1.8721	1.8739/1.8787
TSI32XX16X	2"	1"	2.1871/2.1883	1.9987/1.9969	1.9989/2.0037
TSI32XX24X	2"	1-1/2"	2.1871/2.1883	1.9987/1.9969	1.9989/2.0037
TSI32XX32X	2"	2"	2.1871/2.1883	1.9987/1.9969	1.9989/2.0037
TSI32XX40X	2"	2-1/2"	2.1871/2.1883	1.9987/1.9969	1.9989/2.0037
TSI36XX32X	2-1/4"	2"	2.4365/2.4377	2.2507/2.2489	2.2509/2.2573
TSI36XX36X	2-1/4"	2-1/4"	2.4365/2.4377	2.2507/2.2489	2.2509/2.2573
TSI36XX40X	2-1/4"	2-1/2"	2.4365/2.4377	2.2507/2.2489	2.2509/2.2573
TSI36XX48X	2-1/4"	3"	2.4365/2.4377	2.2507/2.2489	2.2509/2.2573
TSI40XX32X	2-1/2"	2"	2.6869/2.6881	2.5011/2.4993	2.5013/2.5077
TSI40XX40X	2-1/2"	2-1/2"	2.6869/2.6881	2.5011/2.4993	2.5013/2.5077
TSI40XX48X	2/1-2"	3"	2.6869/2.6881	2.5011/2.4993	2.5013/2.5077
TSI40XX56X	2-1/2"	3-1/2"	2.6869/2.6881	2.5011/2.4993	2.5013/2.5077
TSI44XX32X	2-3/4"	2"	2.9358/2.9370	2.7500/2.7482	2.7502/2.7566
TSI44XX40X	2-3/4"	2-1/2"	2.9358/2.9370	2.7500/2.7482	2.7502/2.7566
TSI44XX48X	2-3/4"	3"	2.9358/2.9370	2.7500/2.7482	2.7502/2.7566
TSI44XX56X	2-3/4"	3-1/2"	2.9358/2.9370	2.7500/2.7482	2.7502/2.7566
TSI48XX32X	3"	2"	3.1858/3.1872	3.0000/2.9982	3.0002/3.0068
TSI48XX48X	3"	3"	3.1858/3.1872	3.0000/2.9982	3.0002/3.0068
TSI48XX60X	3"	3-3/4"	3.1858/3.1872	3.0000/2.9982	3.0002/3.0068
TSI56XX40X	3-1/2"	2-1/2"	3.6858/3.6872	3.5000/3.4978	3.5002/3.5068

Continues on next page



All TriSteels are
100% Lead Free

TriSteel Installation Dimensions for PT, PTS, PM, and PR Liners continued

Tri-Star Part NO.	Shaft Dia	Length	Housing Bore	Shaft Dim's	Installed ID
TSI56XX48X	3-1/2"	3"	3.6858/3.6872	3.5000/3.4978	3.5002/3.5068
TSI56XX60X	3-1/2"	3-3/4"	3.6858/3.6872	3.5000/3.4978	3.5002/3.5068
TSI64XX48X	4"	3"	4.1858/4.1872	4.0000/3.9978	4.0002/4.0068
TSI64XX60X	4"	3-3/4"	4.1858/4.1872	4.0000/3.9978	4.0002/4.0068
TSI64XX76X	4"	4-3/4"	4.1858/4.1872	4.0000/3.9978	4.0002/4.0068
TSI80XX48X	5"	3"	5.1844/5.1860	4.9986/4.9961	4.9988/5.0056
TSI80XX60X	5"	3-3/4"	5.1844/5.1860	4.9986/4.9961	4.9988/5.0056
TSI96XX48X	6"	3"	6.1858/6.1874	6.0000/5.9975	6.0002/6.0070
TSI96XX60X	6"	3-3/4"	6.1858/6.1874	6.0000/5.9975	6.0002/6.0070
TSI112XX60X	7"	3-3/4"	7.1812/7.1830	6.9954/6.9929	6.9956/7.0026

Other sizes are available in all liner styles upon request.

TriSteel Installation Dimensions for AC, AT and PE Liners

Tri-Star Part No	Shaft Dia	Length	Housing Bore	RECOMMENDED	
				Shaft Dim's	Installed ID
TSI08XX06X	1/2"	3/8"	.5934/.5941	.4990/.4980	.4992/.5019
TSI08XX08X	1/2"	1/2"	.5934/.5941	.4990/.4980	.4992/.5019
TSI10XX10X	5/8"	5/8"	.7184/.7192	.6240/.6230	.6242/.6270
TSI10XX12X	5/8"	3/4"	.7184/.7192	.6240/.6230	.6242/.6270
TSI12XX12X	3/4"	3/4"	.8846/.8854	.7500/.7488	.7508/.7540
TSI12XX16X	3/4"	1"	.8846/.8854	.7500/.7488	.7508/.7540
TSI14XX12X	7/8"	3/4"	1.0097/1.0105	.8750/.8738	.8759/.8791
TSI14XX16X	7/8"	1"	1.0097/1.0105	.8750/.8738	.8759/.8791
TSI16XX12X	1"	3/4"	1.1348/1.1356	1.0000/0.9988	1.0010/1.0042
TSI16XX16X	1"	1"	1.1348/1.1356	1.0000/0.9988	1.0010/1.0042
TSI18XX12X	1-1/8"	3/4"	1.2598/1.2606	1.1250/1.1238	1.1260/1.1292
TSI18XX16X	1-1/8"	1"	1.2598/1.2606	1.1250/1.1238	1.1260/1.1292
TSI20XX12X	1-1/4"	3/4"	1.4160/1.4170	1.2500/1.2484	1.2512/1.2550
TSI20XX16X	1-1/4"	1"	1.4160/1.4170	1.2500/1.2484	1.2512/1.2550
TSI22XX16X	1-3/8"	1"	1.5410/1.5420	1.3750/1.3734	1.3762/1.3800
TSI22XX24X	1-1/2"	1-1/2"	1.5410/1.5420	1.3750/1.3734	1.3762/1.3800
TSI24XX16X	1-1/2"	1"	1.6660/1.6670	1.5000/1.4984	1.5012/1.5050
TSI24XX24X	1-1/2"	1-1/2"	1.6660/1.6670	1.5000/1.4984	1.5012/1.5050
TSI24XX32X	1-1/2"	2"	1.6660/1.6670	1.5000/1.4984	1.5012/1.5050
TSI26XX16X	1-5/8"	1"	1.7910/1.7920	1.6250/1.6234	1.6262/1.6300
TSI26XX24X	1-5/8"	1-1/2"	1.7910/1.7920	1.6250/1.6234	1.6262/1.6300
TSI26XX32X	1-5/8"	2"	1.7910/1.7920	1.6250/1.6234	1.6262/1.6300
TSI28XX16X	1-3/4"	1"	1.9371/1.9381	1.7500/1.7484	1.7515/1.7577
TSI28XX24X	1-3/4"	1-1/2"	1.9371/1.9381	1.7500/1.7484	1.7515/1.7577
TSI28XX32X	1-3/4"	2"	1.9371/1.9381	1.7500/1.7484	1.7515/1.7577
TSI30XX16X	1-7/8"	1"	2.0621/2.0633	1.8750/1.8734	1.8765/1.8829
TSI30XX24X	1-7/8"	1-1/2"	2.0621/2.0633	1.8750/1.8734	1.8765/1.8829
TSI30XX32X	1-7/8"	2"	2.0621/2.0633	1.8750/1.8734	1.8765/1.8829
TSI30XX36X	1-7/8"	2-1/4"	2.0621/2.0633	1.8750/1.8734	1.8765/1.8829
TSI32XX16X	2"	1"	2.1871/2.1883	2.0000/1.9982	2.0015/2.0079
TSI32XX24X	2"	1-1/2"	2.1871/2.1883	2.0000/1.9982	2.0015/2.0079
TSI32XX32X	2"	2"	2.1871/2.1883	2.0000/1.9982	2.0015/2.0079
TSI40XX24Z	2-1/2"	1-1/2"	2.6871/2.6883	2.5000/2.4982	2.5015/2.0079
TSI40XX32X	2-1/2"	2"	2.6871/2.6883	2.5000/2.4982	2.5015/2.0079
TSI40XX40X	2-1/2"	2-1/2"	2.6871/2.6883	2.5000/2.4982	2.5015/2.0079
TSI48XX24X	3"	1-1/2"	3.1875/3.1889	3.0000/2.9982	3.0019/3.0085
TSI48XX32X	3"	2"	3.1875/3.1889	3.0000/2.9982	3.0019/3.0085
TSI48XX40X	3"	2-1/2"	3.1875/3.1889	3.0000/2.9982	3.0019/3.0085
TSI48XX48X	3"	3"	3.1858/3.1889	3.0000/2.9982	3.0019/3.0085

AC and PE liners come standard with lubrication holes. PE liners also available without holes on request.

TriSteel Metric Installation Dimensions for PT, PTS, PM, and PR Liners



ID	OD	Shaft Dia	Housing Bore	Wall Thickness	
				Min	Max
6	8	6 ^{-0.013} / _{-0.028}	8 +0.015	0.980	1.005
8	10	8 ^{-0.013} / _{-0.028}	10 +0.015		
10	12	10 ^{-0.016} / _{-0.034}	12 +0.018		
12	14	12 ^{-0.016} / _{-0.034}	14 +0.018		
13	15	13 ^{-0.016} / _{-0.034}	15 +0.018		
14	16	14 ^{-0.016} / _{-0.034}	16 +0.018		
15	17	15 ^{-0.016} / _{-0.034}	17 +0.018		
16	18	16 ^{-0.016} / _{-0.034}	18 +0.018		
17	19	17 ^{-0.016} / _{-0.034}	19 +0.021		
18	20	18 ^{-0.016} / _{-0.034}	20 +0.021		
20	23	20 ^{-0.020} / _{-0.041}	23 +0.021	1.475	1.505
22	25	22 ^{-0.020} / _{-0.041}	25 +0.021		
24	27	24 ^{-0.020} / _{-0.041}	27 +0.021		
25	28	25 ^{-0.020} / _{-0.041}	28 +0.021		
28	32	28 ^{-0.020} / _{-0.041}	32 +0.025	1.970	2.005
30	34	30 ^{-0.020} / _{-0.041}	34 +0.025		
32	36	32 ^{-0.025} / _{-0.050}	36 +0.025		
35	39	35 ^{-0.025} / _{-0.050}	39 +0.025		
38	42	38 ^{-0.025} / _{-0.050}	42 +0.025		
40	44	40 ^{-0.025} / _{-0.050}	44 +0.025		
45	50	45 ^{-0.025} / _{-0.050}	50 +0.025	2.460	2.505
50	55	50 ^{-0.030} / _{-0.060}	55 +0.030		
55	60	55 ^{-0.030} / _{-0.060}	60 +0.030		
60	65	60 ^{-0.030} / _{-0.060}	65 +0.030		
65	70	65 ^{-0.030} / _{-0.060}	70 +0.030		
70	75	70 ^{-0.030} / _{-0.060}	75 +0.030		
75	80	75 ^{-0.030} / _{-0.060}	80 +0.030	2.440	2.490
80	85	80 ^{-0.035} / _{-0.060}	85 +0.035		
85	90	85 ^{-0.035} / _{-0.060}	90 +0.035		
90	95	90 ^{-0.035} / _{-0.060}	95 +0.035		
95	100	95 ^{-0.035} / _{-0.060}	100 +0.035		
100	105	100 ^{-0.035} / _{-0.060}	105 +0.035		
105	110	105 ^{-0.035} / _{-0.060}	110 +0.035	2.415	2.465
110	115	110 ^{-0.035} / _{-0.060}	115 +0.035		
120	125	120 ^{-0.04} / _{-0.060}	125 +0.035		
125	130	125 ^{-0.04} / _{-0.060}	130 +0.040		
130	135	130 ^{-0.04} / _{-0.060}	135 +0.040		
140	145	140 ^{-0.04} / _{-0.060}	145 +0.040		
150	155	150 ^{-0.04} / _{-0.060}	155 +0.040		
160	165	160 ^{-0.04} / _{-0.060}	165 +0.040		
180	185	180 ^{-0.046} / _{-0.060}	185 +0.046		
190	195	190 ^{-0.046} / _{-0.060}	195 +0.046		
200	205	200 ^{-0.046} / _{-0.060}	205 +0.046		
220	225	220 ^{-0.046} / _{-0.060}	225 +0.046		
250	255	250 ^{-0.052} / _{-0.060}	255 +0.052		
260	265	260 ^{-0.052} / _{-0.060}	265 +0.052		
280	285	280 ^{-0.052} / _{-0.060}	285 +0.052		
300	305	300 ^{-0.052} / _{-0.060}	305 +0.052		

Part Number Guide

Build a part number using the table data at left, plus the liner material, backing material, and your desired length.

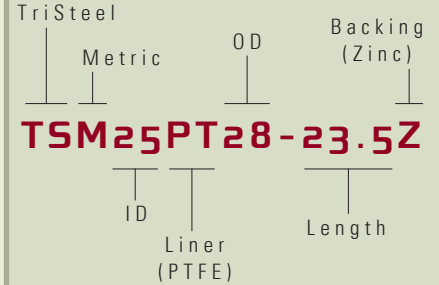

See Page 3 for the full chart showing how our part numbers are built (including liner and backing abbreviations).

TriSteel **Metric** Installation Dimensions for AC, AT, and PE Liners



ID	OD	Shaft Dia	Housing Bore	Wall Thickness	
				Min	Max
10	12	10 -0.022	12 +0.018	0.955	0.980
12	14	12 -0.027	14 +0.018		
14	16	14 -0.027	16 +0.018		
15	17	15 -0.027	17 +0.018		
16	18	16 -0.027	18 +0.018		
18	20	18 -0.027	20 +0.021	1.445	1.475
20	23	20 -0.033	23 +0.021		
22	25	22 -0.033	25 +0.021		
25	28	25 -0.033	28 +0.021		
28	32	28 -0.033	32 +0.025	1.935	1.970
30	34	30 -0.033	34 +0.025		
35	39	35 -0.039	39 +0.025		
40	44	40 -0.039	44 +0.025		
45	50	45 -0.039	50 +0.025	2.415	2.460
50	55	50 -0.039	55 +0.030		
55	60	55 -0.046	60 +0.030		
60	65	60 -0.046	65 +0.030		
65	70	65 -0.046	70 +0.030		
70	75	70 -0.046	75 +0.030		
75	80	75 -0.046	80 +0.030		
80	85	80 -0.046	85 +0.035		
85	90	85 -0.054	90 +0.035	2.385	2.450
90	95	90 -0.054	95 +0.035		
100	105	100 -0.054	105 +0.035		
105	110	105 -0.054	110 +0.035		
110	115	110 -0.054	115 +0.035		
120	125	120 -0.054	125 +0.040		
125	130	125 -0.063	130 +0.040		
130	135	130 -0.063	135 +0.040		
140	145	140 -0.063	145 +0.040		
150	155	150 -0.063	155 +0.040		
160	165	160 -0.063	165 +0.040		
170	175	170 -0.063	175 +0.040		
180	185	180 -0.063	185 +0.046		
190	195	190 -0.072	195 +0.046		
200	205	200 -0.072	205 +0.046		
220	225	220 -0.072	225 +0.046		
240	245	240 -0.072	245 +0.046		
250	255	250 -0.072	255 +0.052		
260	265	260 -0.081	265 +0.052		
280	285	280 -0.081	285 +0.052		
300	305	300 -0.081	305 +0.052		

Part Number Guide

Build a part number using the table data at left, plus the liner material, backing material, and your desired length.

TriSteel Metric OD Backing (Zinc)

TSM25PT28-23.5Z

ID Liner (PTFE) Length

See **Page 3** for the full chart showing how our part numbers are built (including liner and backing abbreviations).



Material Selection Process [MSP]

In all plastic component designs, material selection is critical. During the selection process, one should consider the following factors to ensure the best possible selection.

1 Temperature

All plastics are affected by ambient heat and have a maximum continuous service temperature. The maximum continuous service temperature is not a melting point, but is the highest temperature at which a material will retain physical integrity. *Important: Note that elevated temperatures affect material properties in a negative manner and should be carefully reviewed before use.*

2 Temperature Variation

All plastic materials have coefficients of thermal expansion. Measured in in/in/°F, plastic materials vary greatly not only from each other, but in some cases ten times that of metallic counter parts. As a result, we consider temperature variations. Components should be designed to meet required service temperature. Not doing so may result in premature failure.

3 Environmental Conditions

Always consider the following environmental conditions under which the material must operate:

- Contact with debris such as sand, grit or dust
- Contact with chemicals such as strong acids, bases and caustics
- Contact with water, constant spray or wash downs
- FDA or USDA compliance
- Thermal conductivity
- Radiation exposure
- Microwave exposure

4 Other Considerations

- Size and shape availability
- Material cost/economy
- Machinability
- Standard or custom runs
- Custom compounds

tstar.com

Visit our interactive [online material database](#) to research and compare various plastic materials. If you have questions regarding which materials are appropriate for your project, just reach out via our [Ask the Expert page](#) and our engineering team will assist you.



All TriSteels are
100% Lead Free

Plastic Material	Shape Availability		Machinability Rating 1-10 1=Easy	Serv Temp Long/Short Degrees F	Characteristics / Attributes
	Rod Dia	Sheet Thickness			
ULTRACOMP UC200	Tubing	1/8 to 3	3	266/360	High Load / Impact-Vibration Resistant / Composite
ULTRACOMP UC300	Tubing	1/8 to 3	3	266/360	Lowest Friction / Chemical Resistant / High load
ULTRACOMP UC400	Tubing	1/8 to 3	3	266/360	Moly lubricant / Slow Rotary / Salt Water Applications
ULTRACOMP UC500	Tubing	1/8 to 3	3	266/360	Bearing Grade Blended Fiber / Bearing Grade Composite
ABS	3/16 to 8	1/4 to 4	1	140/210	General Purpose / Economical / Machinable / Moldable
ACETAL / DELRIN	1/8 to 12	.010 to 4	1	195	Machinable / Economical / Good Wear / FDA / USDA
ACETRON	1/4 to 6	1/4 to 2	1	180	Acetal / Machinable / Wear Resistance
ACRYLIC	1/16 to 6	1/32 to 3	5	140/200	Optically Clear / Colors / Machinable / Formable
CELAZOLE / PBI	1 to 4-3/4	3/8 to 2	8	650/1000	Highest Temp / Chemically Resistant / High PV
DELRIN AF	3/16 to 8	1/32 to 3	1	185/300	PTFE Filled Acetal / Low Friction / Brown
DELRIN 500CL	1/2 to 3	1/4 to 4	1	180/300	Chemically Lubricated Acetal / Low Friction
ERTALYTE / ERTALYTE TX*	3/16 to 8	1/4 to 4	1	210	PET I Bearing Grade* / Good Wear / FDA / White
FEP	1/16 to 6	.005 to 3	3	400	Fluoropolymer / Excellent Chemical Resistance
FLUOROSINT 207* / 500	1/2 to 8-3/4	1/4 to 3	3	500	Family of Filled PTFE / High Thermal Stability / FDA*
HYDEX 4101 & 4101L*	1/2 to 6	3/8 to 4	1	220	PBT I PTFE Filled* / FDA-USDA / Low Friction / White
HYDEX FGA	1/2 to 4	3/8 to 2	1	185/300	Teflon Filled Delrin / FDA / USDA / Low Friction
HYDLAR ZF	1/4 to 5	1/4 to 2	5	230/300	Aramid Fiber Filled Nylon / Wear Resistant
KYNAR / PVDF	1/4 to 10	1/4 to 4	2	122/230	Fluoropolymer / Excellent Chemical Resistance
MICARTA C & L	1/32 to 10	1/32 to 8	8	257	Phenolic Resin / Cloth Fabric Matrix / Laminate
MICARTA G-10 & G-11*	1/32 to 5	.005 to 5	10	284/356	Epoxy I Silicone* / Woven Fiberglass Matrix / Laminate
MICARTA XXX	1/32 to 2	1/32 to 5	8	284	Phenolic Resin / Paper Matrix / Laminate
NORYL EN265	3/8 to 8	1/4 to 4	2	195/375	PPO & Styrene Alloy / Good Creep Resistance
NYLATRON	1/32 to 2	.010 to 4	1	200	Modified Nylon Type 66 / Cast Type 6 / Impact and wear
NYLON 66	1/32 to 6	.010 to 3	1	210	Economical / Good Wear / High Impact Strength
PCTFE / KEL-F	1/16 to 6	.005 to 2	3	400	Chemical Resistant / Heat Resistant / High Temp
PEEK	1/4 to 4	1/4 to 2-1/2	5	480	Autoclavable / Chemical & Steam Resistant
PFA / NEOFロン	1/16 to 3	.002 to 3	3	500	Chemical Resistant / Heat Resistant / High Temp
POLYCARBONATE	1/32 to 15	1/32 to 4	3	210/265	Good Machinability / Transparent / High Rigidity
POLYETHYLENE	1/32 to 18	.002 to 10	1	140/175	General Purpose / Economical / Chemical Resistant
POLYIMIDE / MELDIN	1 to 4-3/4	3/8 to 2	7	600	High Temp / Wear Resistance / High PV / Low Outgas
POLYPROPYLENE	1/4 to 16	.010 to 10	1	160/230	Chemically Resistant / Weldable / Economical
POLYSULFONE / UDEL	3/16 to 8	1/4 to 4	1	300/340	Autoclavable / Chemically Resistant / Heat Resistant
PVC / CPVC*	1/4 to 13-3/4	3/32 to 4	1	155	Weldable / Economical / Chemical Resistant / Hi Temp*
REXOLITE	1/16 to 9	1/32 to 6	3	212	Crosslinked Polystyrene / High Frequency Dielectric
RULON 123	3/16 to 13	.010 to 2	3	550	Filled PTFE / FDA / USDA / High V / Inert / Black
RULON 142	N/A	.015 to 1/4	1	550	Slideways / Machine Ways / Expansion Supports
RULON 488	3/16 to 12	.015 to 1	3	550	Filled PTFE / High V / Inert / Dryer Bearings / Green
RULON 641	3/16 to 12	.015 to 1	3	550	Filled PTFE / FDA / USDA / High V / Inert / White
RULON J	3/16 to 13	.010 to 4	3	550	Filled PTFE / Low Friction / Non Abrasive / Gold
RULON LR	3/16 to 13	.010 to 4	5	550	Filled PTFE / Good Strength / High V / Inert / Maroon
TECHTRON / PPS	1/4 to 3	1/4 to 2	4	425	Chemical Resistant / High Temp / High Strength
TEFLON / GLASS FILLED	1/4 to 12	1/4 to 4	5	550	Filled PTFE / High V / High Temp / Chemical Resistant
TEFLON / EXT & MOLDED	1 to 38	.001 to 12	3	550	Unfilled Teflon / Inert / High Temp / Insulator / White
TEFLON/ FEP / TUBING	.034 to 12	N/A	N/A	550	Roll Covers / Spaghetti / Shrinkable / AWG Sizes
TEFZEL / ETFE	1/16 to 3-3/4	.030 to 3	3	300/350	Fluoropolymer / Excellent Chemical Resistance
TFM	1 to 12	.010 to 4	3	500	Fluoropolymer / Low Porosity / High Temperature
TORLON 4203 / 4301	3/32 to 2	3/16 to 1	5	500	High Temp / High Strength / Electrical & Bearing Grade
UHMW	1/4 to 10	.005 to 7	5	180	High Abrasion Resistance / Low Friction / FDA
UHMW / GLASS FILLED	1/2 to 4	1/16 to 2	3	180	Low Friction / Highest Abrasion Resistance
UHMW / OIL FILLED	1/4 to 8	1/8 to 2	3	180	Lowest Friction / High Abrasion Resistance
ULTEM 1000	1/32 to 8	.002 to 4	5	340	High Strength / Autoclavable / Chemical Resistance
ULTEM 2300	1/4 to 8	3/8 to 4	8	340	High Strength / Rigid / Autoclavable / Thermally Stable
VHMW	N/A	1/8 to 3/4	5	160	Good Abrasion Resistance / Low Friction / Economical



Plane Bearing Design (PBD)

In all plane bearing designs, material selection is critical. During the selection process, one should consider the following factors to ensure the best possible selection.

1 Bearing Load – P $P = \text{LBS} / (\text{ID} \times \text{LENGTH})$
Measured in pounds per square inch (PSI), bearing pressure is calculated by disbursing the total load over the projected area (ID x LENGTH) of the bearing. This provides the average pressure (PSI) that the bearing must support. Note that all materials have a maximum P.

2 Relative Velocity – V $V = C \times \text{RPM}$
Measured in feet per minute (FPM), bearing velocity is calculated by first calculating the shaft circumference (C) in inches (C = Shaft Dia x 3.14 ÷ 12). Then by multiplying by the RPM of the shaft, this calculation gives the surface velocity in feet per minute (FPM) or V. Note that all materials have a maximum V.

3 System – PV $PV = P \times V$
System PV is measured in PSI x FPM, and is the product of P x V. System PV is a means of measuring the performance capabilities of a plastic material and is the result of multiplying the operating pressure by the surface velocity. *Important: Note that the maximum PV rating is not the maximum P x maximum V.*

4 Temperature
Materials used as self-lubricating plane bearings are always affected by ambient heat. All plastic materials have a maximum continuous service temperature. The maximum continuous service temperature is not a melting point, but is the highest temperature at which a material will retain enough physical integrity to allow it to continue to operate as a bearing. *Important: Note that elevated temperatures affect material properties in a negative manner and should be carefully reviewed before use.*

5 Temperature Variations
All plane-bearing materials have coefficients of thermal expansion. Measured in in/in/°F, plastic materials vary greatly not only from each other, but in some cases ten times that of their metallic counter parts. As a result, we must consider temperature variations. Bearings should be designed such that at service temperature, the bearing does not close down on the shaft. Failure to do so will result in additional frictional heat and/or total system freeze up.

6 Environmental Conditions
Always consider the following environmental conditions under which the bearing must operate:

- Contact with debris such as sand, grit or dust
- Contact with chemicals such as strong acids, bases and caustics
- Contact with water, constant spray or wash downs
- FDA or USDA compliance
- Shaft material, surface finish, and thermal conductivity

7 Hardware Conditions
Hardware Conditions are critical elements in optimizing wear life and frictional properties in bearing design.

- Shaft material
- Shaft surface finish – 12 to 16 RMS recommended
- Shaft treatments
- Housing design – finish and materials

[tstar.com](https://www.tstar.com)

Use our online [Linear Plane Bearing Engineering Worksheet](#) to spec out your bearing. We have other worksheets available as well, including for flange bearings, structural shapes, and seals. [Check them out!](#)



All TriSteels are
100% Lead Free

Bearing Material	Max P Static psi	Max V No Load SFM dry	Max PV P x V Dry	Serv. Temp Continuous °F	Characteristics / Attributes
ULTRACOMP UC200	54,400	15	25,000	266	High Load / Impact-Vibration Resistant / Composite Bearing
ULTRACOMP UC300	45,000	100	15,000	266	Lowest Friction / High Load / Bearing Grade Composite
ULTRACOMP UC400	52,000	15	25,000	266	Moly lubricant / Slow Rotary / Salt Water Applications
ULTRACOMP UC500	50,000	30	25,000	266	Bearing Grade Blended Fiber / Bearing Grade Composite
CJ BEARING	35,000	150	25,000	300	PTFE Nomex-Lined Glass / Epoxy Shell / High Load
FCJ BEARING	20,000	500	20,000	300	Rulon Lined Glass / Epoxy Shell / High P
15% GRAPHITE 10% TFE POLYIMIDE	4,500	750	100,000	550	High PV / High Temp / Low Friction / Chemical Resistant
15% GRAPHITE FILLED POLYIMIDE	5,000	1,000	250,000	550	High PV / High Temp / Low Friction / Chemical Resistant
15% GRAPHITE FILLED PTFE	400	100	10,000	500	Filled PTFE / Low Friction / Economical
25% CARBON FILLED PTFE	1,000	400	10,000	500	Filled PTFE / Low Friction / Conductive
25% GLASS FILLED PTFE	1,000	350	10,000	550	Filled PTFE / High V / High Temp / Chemical Resistant
BEARING GRADE PPS	1,500	400	10,000	425	High Strength / Rigidity / Excellent Chemical Resistance
CARBON FIBER / PTFE FILLED PEEK	6,000	600	10,000	480	High PV / High Temp / Chemical Resistant / Thermally Stable
CARBON FIBER FILLED PEEK	6,000	600	50,000	480	High PV / High Temp / Thermally Stable / Conductive
CELAZOLE / PBI	1,000	150	37,500	650	Highest Temp / Chemical Resistant / Polybenzamidizole
DELTRIN / HOMOPOLYMER	1,000	50	2,700	180	Acetal / Economical / Good Wear / FDA / USDA
DELTRIN AF	1,000	100	11,000	180	PTFE Filled Acetal / Low Friction / Brown
DELTRIN CL500	1,000	50	3,000	122	Chemically Lubricated Acetal / Low Friction
ERTALYTE	1,000	100	5,000	210	PET / Economical / Good Wear / FDA / USDA
FLUOROGOLD	1,000	400	10,000	500	Filled PTFE / Lowest Friction / High V / Chemical Resistant
FLUOROLOY A	1,000	400	7,500	500	Filled PTFE / Stability / Strength / High V / Low Friction
FLUOROLOY K	1,000	400	10,000	500	Filled PTFE / Stability / Seals / High V / Chemical Resistant
FLUOROSINT 207	750	400	7,500	500	Filled PTFE / Low Friction / FDA / Thermal Stability
FLUOROSINT 500	750	400	5,000	500	Filled PTFE / Most Thermally Stable in PTFE Family
FLUOROSINT HPV	1000	400	22,000	500	Filled PTFE / Low Friction / FDA / Thermal Stability
GLASS FILLED NYLON	350	40	3,000	225	Economical / Good Wear / High Impact
GLASS FILLED UHMW	1,000	50	1,500	180	Low Friction / Highest Abrasion Resistance
HYDEX 4101	1,000	100	6,000	245	PBT / Chemical Resistant / Economical / Good Wear
HYDEX 4101L	1,000	200	15,000	245	PTFE Filled PBT / FDA / USDA / Low Friction
HYDLAR FGA	1,000	100	12,400	180	PTFE Filled Acetal / Low Friction / FDA / USDA
HYDLAR ZF	1,500	100	8,000	230	Aramid Fiber Filled Nylon / Good Wear / FDA
MELDIN / POLYIMIDE	6,600	500	250,000	550	High PV / High Temp / Chemical Resistant
MELDIN 2021 / FILLED POLYIMIDE	6,000	1,000	300,000	550	Highest PV / Very High Temp / Lowest Friction
MELDIN 2030 / FILLED POLYIMIDE	3,000	750	100,000	550	High PV / High Temp / Low Friction / Chemical Resistant
MICARTA	27,500	15	5,000	250	Thermo-set / Rigid / High Strength / Electrical Insulator
NYLATRON GSM	300	60	3,000	200	MOs Filled Nylon Type 6 / Economical / Monocast
NYLATRON GSM BLUE & MC901	350	100	3,800	260	Oil & MOs Filled Nylon Type 6 / Monocast, Good Wear
NYLATRON NS/NSM	400	100	12,000	200	Solid Lubricant Filled Nylon Type 6
NYLON 66	300	60	2,700	210	Economical / Good Wear / High Impact
NYLON ST801	300	40	3,000	200	High Strength / Good Impact Strength
OIL FILLED UHMW	800	75	1,500	180	Low Friction / High Abrasion Resistance / FDA
PTFE	50	400	1,000	550	Unfilled Teflon / High Temp / Low Heat Transfer
RULON 142	1,000	400	10,000	500	Filled PTFE / Bondable / Machine Tool Ways / High Load
RULON 488	1,000	400	10,000	500	Filled PTFE / Economical / High V / Chemical Resistant
RULON 641	1,000	400	10,000	500	Filled PTFE / FDA / USDA / High V / Chemical Resistant
RULON DC7035	1,000	400	10,000	500	Filled PTFE / Conductive / High V / Chemical Resistant
RULON J	750	400	7,500	500	Filled PTFE / Low Friction / Non Abrasive / Chemical Resistant
RULON LR	1,000	400	10,000	500	Filled PTFE / Good Strength / High V / Chemical Resistant
RULON W2	1,000	400	10,000	500	Filled PTFE / Water Applications / High V / Chemical Resistant
TORLON 4301	1,000	900	50,000	500	High Temp / High Strength / Low Friction / Graphite Filled
UHMW	800	50	1,000	180	High Abrasion Resistance / Low Friction I FDA
ULTRALINER J	10,000	400	20,000	500	Filled PTFE w / Screen Reinforcement

BiMetal Bushings

We have several products available that are classified as bimetal construction. These are products that use copper or steel backing structures with sintered liners of different compositions. All of these products are rolled bearings like our standard TriSteel products.

BiMetal JF800

Steel backing with CuPb10Sn0 or CuSn6Zn6Pb3 liners. This grade is best applied in lubricated pin bushings for application in suspensions, off road construction



equipment, auto chassis points and areas where speeds are medium range but high impact is possible. Load capacity is 10,000 psi, speed 900 fpm. ■ Hardness: HB70-100 ■ Temperature: -40 to +500F ■ Coefficient of friction: .06-0.14

BiMetal JF720

Steel backing with CuPb24Sn4 liner, with good fatigue strength and sliding performance. Primarily applied to fully lubricated connecting rod or main bushings in engines and



compressors. Load capacity is 5500 psi, speed up to 1800 fpm. ■ Hardness: HB45-70, Temp: -40 to +400 ■ Coefficient of friction: 0.06-0.16

BiMetal JF700

Steel backing with CuPb30 liner. Low friction and good dry breakaway properties. Primarily low loads and high speeds in engine and transmission applications.



Load capacity is 3600 psi, speed to 2900 fpm ■ Hardness: HB30-45, Temperature: -40 to +325F. ■ Coefficient of friction 0.08-0.16

BiMetal JF20

Steel backing with AlSn20Cu liner. Good corrosion resistance, high speed, low load applications in compressors, engines and pumps.



HT-M Bushing

Roller hardened steel bushing used in lubricated environments. Popular style for off road construction applications. Other uses include agriculture, railroad, conveyor, and material handling applications.



TFR Bushing

TFR Bushing is constructed of a steel backing with PTFE bonded to a metal fabric. Maximum static load is 32,000 psi and dynamic load is 22,000 psi. ■ Speed up to 1000 fpm, temperature rating: -328 to +400F continuous.

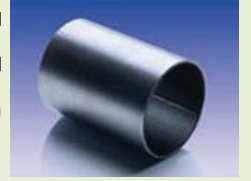

FR Bushing

FR Bushing material is available in tape form or as finished parts. Constructed of copper mesh with filled PTFE pressed in to recesses.



Maximum static load is 14,500 psi with dynamic load at 7,500 psi. CoF is .06-.19 depending on load. Normally used as pin bushing in light-to-medium duty oscillating applications like door hinges, bike components, automotive hood and trunk pins, etc.

tstar.com

Visit our online technical library at tstar.com/tristeel-applications to view real-world TriSteel case studies. These studies highlight actual challenges, from a variety of industries, solved with TriSteels.



TriStar



Engineered Plastic Solutions™

The Advantage is closer than you think.

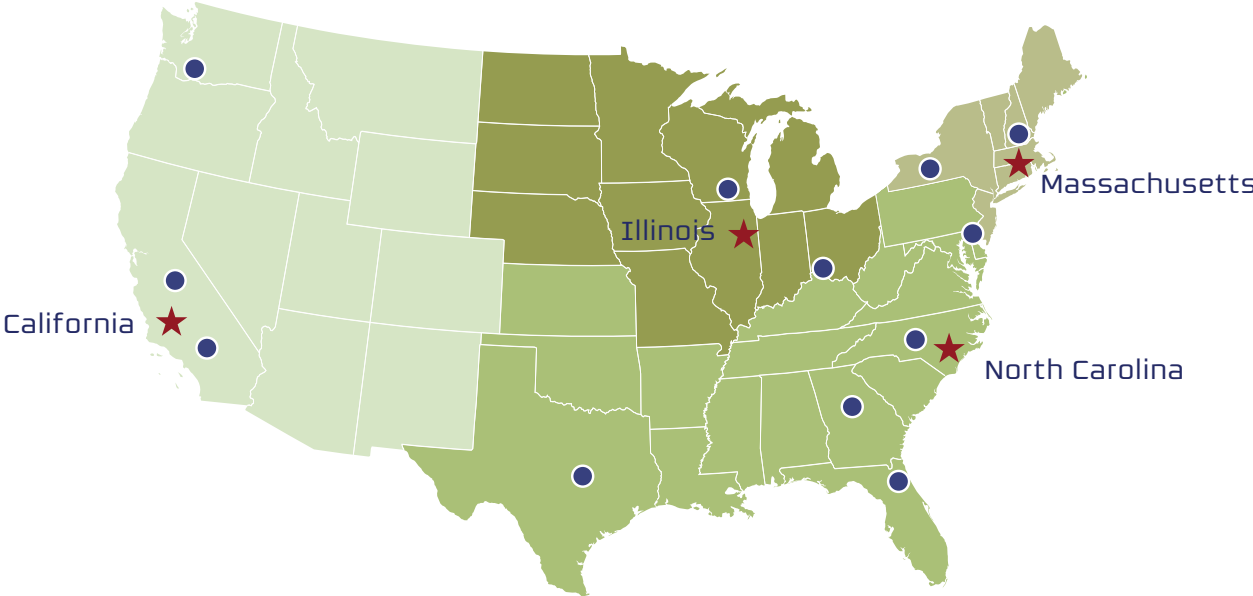

tstar.com 1.800.874.7827



Exclusive Rulon Partner



This company powered by:  SYSPRO

© Copyright TriStar Plastics Corp. Printed in U.S.A.

TS-TRI Rev. 2021a