



Part #: 800SB-2W Retrofit Security Bars for Installation at Top of Roof Curbs
(Two-way bars with extended frame held down inside roof curb)

Standard Construction:

Frame: Welder 16 ga. Galvanized steel. Security Bars are welded in a grid pattern. All welds micro-sealed and prime painted after fabrication.

Added Options (When Required):

RPI Job #: -

Project: _____ Architect: _____

TO INSTALL ON TOP OF NEW OR EXISTING ROOF CURBS

BAR SIZE

Standard: 1/2" 6 inches on Center

Custom: _____ " _____ inches on Center

HARDENED TOOL RESISTANT

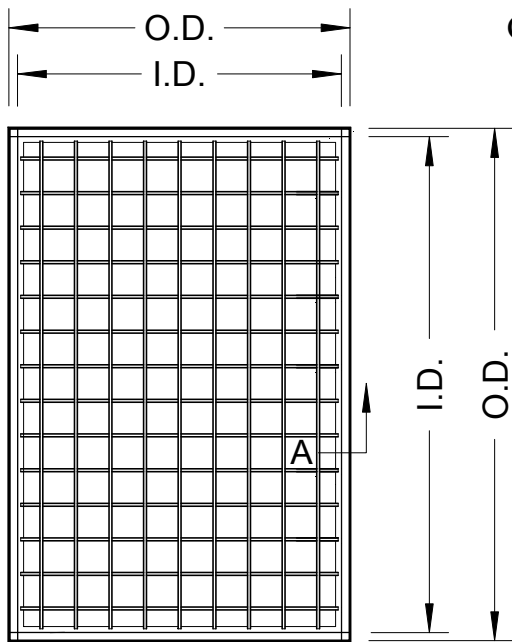

PLAN

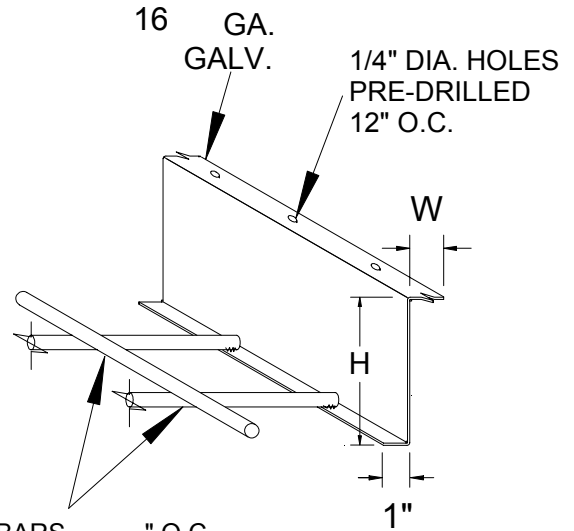

BURGLAR BARS _____ " O.C.
 BOTH DIRECTIONS

SECTION - A (ISO)

Qty.	I.D.	O.D.	H	W	Tag: