

Automatic Potentiometric Titrator

AT-710

Function Description

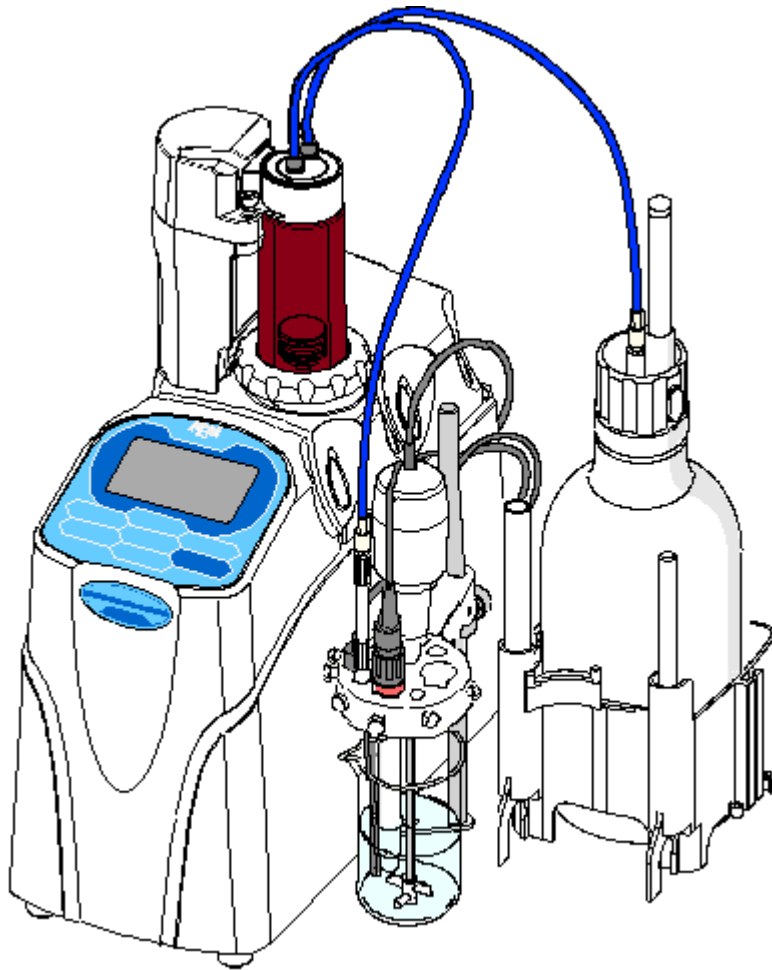

Please read this manual thoroughly in advance for the best performance of the equipment.

KEM KYOTO ELECTRONICS
MANUFACTURING CO., LTD.





<http://www.kyoto-kem.com>

AN 59-00419-03Ver.00

Important:

You must observe the following rules in order to prevent physical or property damage of yourself as well as of the others.

Meaning of Symbols

	Warning	Danger of severe injury or possible death
	Caution	Risk of physical or property damage
		This symbol means Prohibition.
		This symbol means Mandatory.

1. Burette Operation

Read this operation manual thoroughly before use.

It describes all that are required for routine measurements.

Keep this manual beside your equipment so that you can refer to whenever necessary.

For detailed test methods, see the separate Operation Manual.

The following symbols indicate the important notes that raise your attention.

1. Note



Unless you observe the note, you may not be able to obtain specified performance of the unit, and your unit may not be covered by warranty.

2. Hint



This symbol notes technical tips which are convenient to your measurement work.

- In this manual, [^], [V], [<SAMPLE] and [STIRRER>] key are explained the sign each of [↑], [↓], [←] and [→].
- It is prohibited to duplicate any part or all of manual without prior consent.
- This manual has been prepared to the best of our knowledge; however, if you should find any missing or ambiguous description, please contact your nearest dealer or sale representative.
- Maker will not be liable for any loss or damage caused by use of or the result of the product.
- This manual describes usage according to standard specification. For special version, refer to the accompanying document.
- This manual describes usage according to standard specification. For special version, refer to the accompanying document.
- Windows, Excel, Word, Access and Internet Explorer is a registered trademark of Microsoft Corporation in the United States and other countries. Google and Android are trademarks or registered trademarks of Google Inc.

Table of Contents

	Page
Menu	1
1. Burette Operation	2
1-1. Manual Operation.....	2
1-2. Dosing Reagent.....	5
1-3. Validation of burette precision.....	7
1-4. Volume adjust of burette.....	10
2. Result List	11
2-1. Display of Titration result and Recalculation.....	11
2-2. Statistics.....	12
3. Method	14
3-1. Method.....	14
3-2. Titration, Electrode and Preamplifier.....	17
3-3. Preamplifiers.....	18
3-4. Titration Parameter.....	19
3-5. Control Parameter.....	26
3-5-1. Control Parameter.....	27
3-5-2. Initial values of Control parameters.....	31
3-5-3. Input range for potential parameters.....	32
3-5-4. Normalized potential.....	32
3-5-5. Settings of discharge amount of titrant.....	33
3-6. Calculation Parameter.....	34
3-7. Report Parameter.....	39
3-8. Predosing parameter.....	43
3-9. After Titration parameter.....	46
4. Calibration	47
4-1. Calibration condition setup.....	47
4-2. Configure sensor calibration conditions (CH1/pH).....	49
4-3. Configure sensor calibration conditions (Ch3/%T).....	52
4-4. Configure sensor calibration conditions (Ch3/Pol).....	53
4-5. Configure sensor calibration conditions (Ch3/ μ S).....	54
4-6. pH Table.....	55
5. Data Copy	57
5-1. Saving Titration Data.....	57
5-2. Saving Method Conditions, Setting Up on PC.....	58
5-3. Saving pH Table, Setting Up on PC.....	59

6. Changer	60
6-1. Setting Up Changer Mode.....	60
6-2. Changer Mode Screen.....	62
7. History	64
8. Sample	65
9. Blank List	67
10. Factor List	68
11. Setup	69
11-1. Burette Set.....	70
11-2. Interface.....	71
11-2-1. RS-232C setting.....	71
11-2-2. Printer setting.....	72
11-2-3. Balance setting	73
11-2-4. USB setting	74
11-2-5. Setting up other instruments.....	75
11-3. Operator	76
11-4. Date & Time.....	77
11-5. Serial No.	78
11-6. LCD Contrast.....	78
11-7. Language	79
11-8. Beep	80
11-9. Parameter Clear.....	81
11-10. Smart Electrode	82
11-10-1. Initialize of smart electrode	82
11-10-2. Setting up alarm	84
11-10-3. Check	84
11-11. Other	85
12. Option	87
12-1. Connecting a Printer	87
12-2. Balance setting	88
12-3. Connecting Multiple Sample Changer.....	91
12-4. Connecting USB Devices	92
12-5. Connecting Android devices.....	93
12-5-1. Connecting to instrument	93
12-5-2. Starting app	94
12-5-3. Starting measurement.....	95
12-5-4. Entering weight.....	96
12-6. Adding a Built-in Burette.....	97
12-7. Connecting additional burette	98

12-8. Adding auto dispenser	99
12-8-1. Supplied parts.....	99
12-8-2. Installation of auto dispenser	99
12-8-3. Assembling burette unit.....	100
12-8-4. Setting up operation.....	102
12-8-5. Maintenance	102
12-8-6. Specification.....	102
12-9. PC.....	103
12-9-1. Data acquisition software (SOFT-CAP)	103
12-9-2. RS-232C output.....	103

Menu

Menu has the following items.

Item	Description
1. Manual Operation	Enables you to operate burette manually. This is to fill reagents, to purge burette or to manually dose fixed amount of reagents.
2. Data File	Shows and prints out titration results. Also conducts recalculation and statistic calculation.
3. Method	Edits methods to be used in titration.
4. Calibration	Calibrates preamplifier. Present calibration information can also be checked.
5. Data Copy	Saves measurement results in a USB flash drive. Also transfers data to edit methods on PC.
6. Changer	Sets up CHA-700 when connected.
7. History	Reviews check records or calibration records.
8. Sample	Sets up sample-related parameters.
9. Blank List	Sets up blank value.
10. Factor List	Sets up factor value for titration reagent.
11. Setup	Sets up system-related settings.

1. Burette Operation

The burette can be operated manually only when the unit is in "Wait for Titr." mode.

1-1. Manual Operation

Filling the burette with reagent and purging the burette can be operated manually.

Press [MENU/HOME] on a main screen. Select "1. Manual Operation" and press [ENTER]. Select "1.Manual" and press [ENTER].

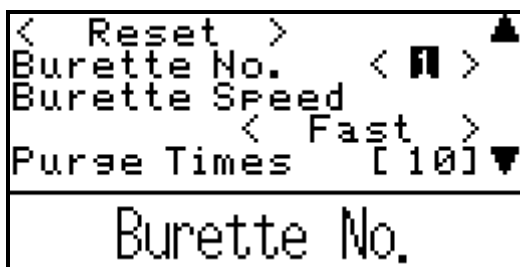

[Burette No.]

Select the burette for use in titration:

- 1.2 : The supplied one burette works.
- 3 - 10 : Additionally installed second burette works.
- D. : The optional auto dispenser is activated. Burette speed may not be changed.



The other burette can be operated when a burette No. is changed.

[Burette Speed]

Select the rate of suction, discharge or purge on the APB manual operation screen display.

- Fast : Burette operates at its maximum speed. Ordinary setting.
- Medium : Burette operates at its medium speed.
- Slow : Burette operates at its low speed.

[Purge Times]

Select a number of purge cycles.

- 1 - 99

[Purge Type]

You can select a purge type:

- to Bottle : Reagent moves back and forth between the reagent bottle and burette in order to degas the burette and to homogenize the reagent.
- to Nozzle : Nozzle is degassed and the reagent is discarded. The operation is the same as discharge and can be repeated by the preset number of purge cycles.

Explanation of Key

キー	Operation
[Purge]	Move the cursor to [Purge] and once press [ENTER], it purges for a number of preset times, and stops by filling the burette with reagent. When pressed [ENTER] again, it stops purging and sets in standby for discharge position.
[Up]	Move the cursor to [Up] and once press [ENTER], pushes out the reagent to the nozzle, and stops the piston when it reaches the upper limit top position. The piston also stops when pressed [ENTER] again. The switching valve is turned to discharge direction during this event.
[Down]	Move the cursor to [Down] and once press [ENTER], move down to the lowest limit bottom position to aspirate the reagent from the bottle. Then reagent will be discharged to the reagent bottle side, and it will become RESET. Burette will stop if [ENTER] is pressed once again while moving.
[Exit]	Move the cursor to [Exit] to return to main screen.

Explanation of State display

Display	Burette Condition
Reset	Piston is in lower limit bottom position. The burette unit can be removed.
Top	Piston is in upper limit top position.
Up	Piston is moving upward to discharge reagent.
Down	Piston is moving downward to aspirate reagent.
Stop	Piston is stopping at any point in burette.
Purge	Piston is moving for purge event.
- - - -	The burette is not connected for use.



**Be aware of discharge rate when pressing key.
The reagent may be splashed out of the nozzle when reagent is dispensed into the nozzle with [UP] [Purge] key.**



The burette can be reset with pressing [START/STOP] key on the burette manual screen when the reagent is splashed out of the nozzle.

1. Burette Operation



Note

State display is based on the burette No.

1-2. Dosing Reagent

The reagent is dosed by the manual operation.

Press [MENU/HOME] on the main screen. Select "1. Manual Operation" and press [ENTER]. Select "2.Dose" and press [ENTER].

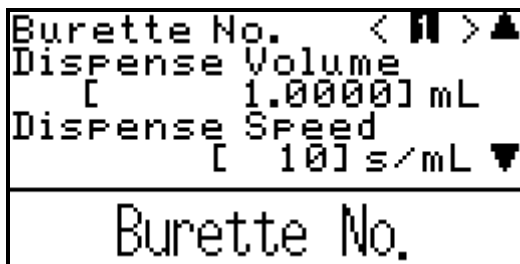

[Burette No.]

Select the burette to activate:

- 1.2 : The supplied one burette works.
- 3 - 10 : The additional burettes are activated.
- D. : The optional auto dispenser is activated. Dispense speed may not be changed.

[Dispense Volume]

Set dispensing volume from a burette. Since the dischargeable amount of reagent depends on the installed burette, see the section "3-5-5. Settings of discharge amount of titrant" in this manual.

- 0.0000 - 9999.0000mL

[Dispense Speed]

Set dispense speed. The higher a set value becomes, the slower dispense rate becomes.

- 1 - 999s/mL



There is a danger that a reagent splashes out of the nozzle when burette dispensing rate is too high; set the dispensing rate at about 5 to 10s/mL.

[Start]

Dosing starts and dispenses up to the preset "Dispense volume." Check the change of potential when dosing starts.

[Reset]

Stop dosing reagent and allow the burette to be reset.

[Exit]

Return to the main screen display.

1. Burette Operation



The burette can be reset with pressing [START/STOP] key on the burette manual screen when the reagent is splashed out of the nozzle.

State display

Display the potential when dosing starts. The potential value can be printed by pressing [Print] and [ENTER].

1-3. Validation of burette precision

The burette cylinder is vilified.

Press [MENU/HOME] on the main screen. Select "1. Manual Operation" and press [ENTER]. Select "3.Validation" and press [ENTER].

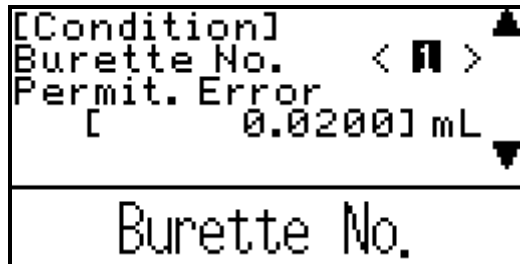

<settings for burette capacity validation>

Set the conditions for the verification of burette capacity.

[Burette No.]

Select the burette to activate for precision check:

- 1.2 : The built-in burette is activated.
- 3 - 10 : The additional burettes can be activated.

[Permit. Error]

Set a range of criterion for precision check. When the measured value is out of this permissible value to the reference value, the result is judged as 'out of range'.

- 0.0000 - 9999.9999mL

[Dispense Speed]

Select the rate of burette discharging amount. The higher a set value becomes, the slower dispense rate becomes.

- Typically, set at: $80 / [\text{Burette capacity}] \text{ (s/mL)}$
- 1 - 999s/mL

[Ambient Temp.]

Set the ambient temperature in the inspection.

- 0.0 - 40.0°C

[Air pressure]

Set atmospheric pressure in the inspection.

- 500.00 - 1500.00hPa

[Titrant Temp.]

Set the temperature of pure water in reagent bottle.

- 0.0 - 40.0°C

1. Burette Operation

[Relative Humidity]

Set the relative humidity in the inspection.

- 0.0 - 100.0%RH

[Dispense Volume]

Set a volume of discharging amount from the burette. Since the dischargeable amount of reagent depends on the installed burette, see the section "3-5-5. Settings of discharge amount of titrant" in this manual.

- 0.0000 - 9999.0000mL

< Capacity conversion >

In the burette capacity check, weight is converted to volume according to JIS K0050 and JIS K0061 as in the conversion calculation:

$$V \text{ (mL)} = W \times \{1 + \rho \times (1 / dt - 1 / d')\} / [\{1 + a \times (\text{Temp} - 20)\} \times dt]$$

W (g) : Dispensed weight of pure water

ρ (g/cm³) : Barometric pressure and air density at the relative humidity given by the below formula

dt (g/cm³) : Density of water at the temperature in inspection

d'(g/cm³) : Density of the weight (= 8.0g/cm³ fixed)

a (K⁻¹) : Cubical expansion coefficient (= 97.5×10⁻⁷ fixed) of burette glass material

Temp (°C) : Water temperature in inspection

$$\rho(\text{g/cm}^3) = 0.001293 \times \{273.15 / (273.15 + t)\} \times \{(P - 0.378 \times e) / P_0\}$$

t (°C) : Ambient temperature

P (kPa) : Atmospheric pressure in the inspection

(P = 0.1 × pressure in inspection (hPa))

e (kPa) : Water vapor pressure (e = 0.01 × RH% × e0)

e0 is referred to saturated water vapor pressure from Table 2 shown in the Appendix of JIS K0061

P0 (kPa) : Standard atmospheric pressure (= 101.325kPa)

[Execute]

Verification of burette capacity starts under the preset conditions.

[Reset]

Stops dosing reagent and allow the unit to be reset.

[Exit]

Return to the main screen display.

Status screen display

Display the operational status during burette capacity check (Operation, Dispensed volume, Titrant temperature, Check conditions).

Validation

- 1) Set the container like measuring flask to the balance and operate tare cancel.
- 2) Set the container tare canceled at 1) to the nozzle.
- 3) Move the cursor to [Execute] and press [ENTER] to allow the burette to dose.



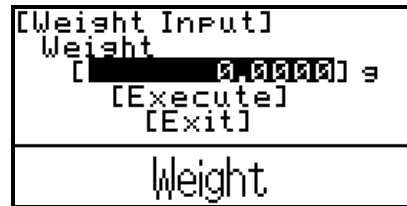

- 4) After the preset volume is dispensed, the screen "weight input" appears. Weigh the dispensed water and press [ENTER].

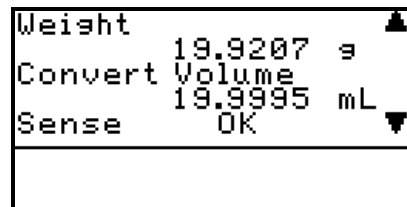

- 5) The validation results appear on the screen display.
The validation history can be viewed by selecting "MENU"->"History"->"Validation".
When continuing to operate the validation of burette precision, press [ENTER] on [Execute] screen again.



 **Note** When Titrant temperature compensation sensor (12-00166-00) is connected, sensor reading is applied to the compensation instead of solution temperature.
The precision of sensor reading is ± 0.5 C. For precision check, a thermometer with resolution of ± 0.1 C is required.

 **Note** See "12-2. Connect the Balance" for input the volume when the balance is connected.
For precision check, a precision of ± 0.0002 g is required.

 **Note** The precision check is performed on user's responsibility.
The resulting precision is warranted only when it's performed on the KEM's quality assurance system. For accurate precision check, it is recommended that users ask our service department for precision check of the burettes.

1. Burette Operation

1-4. Volume adjust of burette

Volume of burette cylinder can be corrected.

Press [MENU/HOME] on the main screen. Select "1. Manual Operation" and press [ENTER]. Select "4. Volume adjust" and press [ENTER].

```
[Volume Adjust]
Burette No.  < 1 >
  5.00
  [      5.000000]
 10.00
  [     10.000000]
 15.00
  [     15.000000]
```

[Burette No.]

Select the burette of which you wish to correct the volume. When you press [Enter], a display will appear, where you can enter actual volume. Correction can be made with the following four steps: burette volume set by 11.Setup-1.Burette Set, 25%, 50% and 75% of burette volume (eg. in case of 20mL volume: 5mL, 10mL, 15mL, 20mL, respectively).

- 1.2 : The built-in burette is activated.
- 3 - 10 : The additional burettes can be activated.

[Calculation]

Burette volume can be corrected under the set condition.

[Reset]

Stops dosing reagent and allow the unit to be reset.

[Exit]

Return to the main screen display.



Note

If you are using the Validation of burette precision in order to set up a correction value of the burette volume, return the volume on the display to the initial value (eg. in case of 20mL volume: 5mL, 10mL, 15mL, 20mL) before executing.



Note

KEM is not responsible for the volume correction by this function. If the accuracy of the burette fails to meet the accuracy of KEM's warranty range, it is suggested that the cylinder be replaced.

2. Result List

Titration result can be displayed, printed, recalculated and calculated statistic.

Press [MENU/HOME], select "2.Data File" with [↑][↓] and press [ENTER]

2-1. Display of Titration result and Recalculation

Move the cursor to a result you wish to display and press [ENTER] to display a result. The result of After Titr is displayed respectively. Select the result and press [ENTER]. The results can be re-calculated.

Move the cursor to [Print] and press [ENTER] to reprint and recalculate the result. The results of recalculation are printed out with sample number (Sample No.) headed with (#) mark.

[Data File]			
01	04/01	15:57	
	01-03		
02	04/01	15:53	
	01-02		
03	04/01	15:49	
	01-01		



Note

Up to 50 samples measurement results can be stored. As for After Titr. result, 2 results are stored.

When it exceeds 50, note that data will be erased on the first-in first-out basis.

[Re-Calculation]

Move the cursor to [Re-Calc.] and press [ENTER] to recalculate. Sample size and unit of the result and print format can be changed.

- Size :Change a sample size
- Unit :Change a sample unit
- Blank List :Change a blank value
- Factor List :Change a factor value
- Format :Change a print format of result
- Data List :Change a print format of data list
- Graph :Change a print format of titration curve

[Execute]

Execute to recalculate. A result screen is displayed.

[Exit]

Cancel to recalculate. A result screen is displayed without recalculation.

2. Result List

2-2. Statistics

Move the cursor to [Statistics] and press [ENTER].



< Search conditions >

You can narrow down the data by selecting the following conditions. Set to narrow down the condition as for being intended when condition is "On".

- High sample No. : The high order number for grouping the samples.
- Method No. : The number of Method particular to it.
- Titration Date : The date of measurement when it was performed.

[Execute]

The selected data under the conditions as above are going to be batch calculated. And the result can be excluded from a statistic calculation by pressing [←] on a result display screen. "*" is displayed on the excluded result before displaying a result.

Move the cursor to [Print] and press [ENTER] to print out the result.

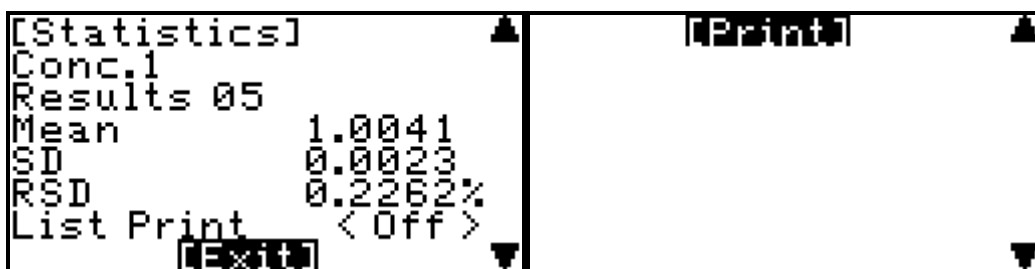

< About statistics >

The batch calculation determines Mean value, Standard deviation (SD) and Relative standard deviation (RSD), which is the same as coefficient variance (CV).

Those values are calculated by the built-in processor as follows:

Where n number of data (X1, X2, , Xn):

$$\text{Mean value} \quad \bar{X} = \frac{(X_1 + X_2 + \dots + X_n)}{n}$$

$$\text{Standard deviation} \quad SD = \sqrt{\frac{\sum_{i=1}^n (X_i - \bar{X})^2}{n-1}}$$

$$\text{Relative SD} \quad RSD(\%) = \frac{SD}{\bar{X}} \times 100$$

[List Print]

You can choose from Yes or No to print the statistical data:

- Off : No printout
- On : Print the results list

**Note**

If the mean value is zero "0", RSD will appear on display and be printed out as "--" symbols not as zero "0".

In addition, when the number of digits of statistical calculation results is greater, all digits may not be displayed. Refer to "3-5. Statistics of Data" in the operation manual how to operate.

3. Method

3-1. Method

For precise measurement effected in a short span of time, it is necessary to configure conditions appropriate for a sample and a method. The method consists of information on the measuring conditions, calculation of concentration, and the like.

AT-710 can store standard methods (No. 01 through 20). Each method can be named individually.

A Method consists of, [Titration parameter], [Control parameter], [Calculation parameter], [Report parameter], [Predosing parameter] and [After titration parameter].

To edit a method, press [MENU/HOME] on the Main screen to display "1.Method", and put the cursor on the method to be edited, followed by pressing [ENTER] key.

[Method List]	
01	METHOD-01
02	METHOD-02
03	METHOD-03
04	METHOD-04
05	METHOD-05
06	METHOD-06
07	METHOD-07
16	METHOD-16
17	METHOD-17
18	METHOD-18
19	METHOD-19
20	METHOD-20
	[Exit]

Each parameter can be selected with corresponding Key on display.



Note

For details of each parameter, refer to individual item in this manual.

[Lock]

Protects method contents.

Setting up a lock on method

- 1) Press [MENU/HOME].
- 2) Select "3. Method" and press [ENTER].
- 3) Select "Lock" with [↑] [↓] and press [ENTER].
- 4) Enter your password in "Password" with [↑] [↓] [←] [→] and press [ENTER].
- 5) Move the cursor to [Lock] and press [ENTER].
- 6) Select "Yes" with [↑] and press [ENTER].
- 7) An icon of key will appear next to "Method List," and method contents are now protected.

```
[MENU]
1.Manual Operation
2.Data File
3.Method
4.Calibration
5.Data Copy
6.Changer
7.History
```

```
16 METHOD-16
17 METHOD-17
18 METHOD-18
19 METHOD-19
20 METHOD-20
[Lock]
[Exit]
```

```
[Method Lock]
Password
[ ]
[Lock]
[Cancel]
```

```
Method Lock
Are you sure?
[Yes]
[No]
```

```
[Key] Method List
01 METHOD-01
02 METHOD-02
03 METHOD-03
04 METHOD-04
05 METHOD-05
06 METHOD-06
07 METHOD-07
```

3. Method

Unlocking method

- 1) Press [MENU/HOME].
- 2) Select "3. Method" and press [ENTER].

```
[MENU] ▲
1.Manual Operation
2.Data File
3.Method
4.Calibration
5.Data Copy
6.Changer
7.History ▼
```

- 3) Select "Unlock" with [↑] [↓] and press [ENTER].

```
16 METHOD-16 ▲
17 METHOD-17
18 METHOD-18
19 METHOD-19
20 METHOD-20 ▼
[Unlock]
[Exit]
```

- 4) Enter your password in "Password" with [↑] [↓] [←] [→] and press [ENTER].
- 5) Move the cursor to [Unlock] and press [ENTER].
Method is now unlocked.

```
[Method Unlock]
Password
[ ]
[Unlock]
[Cancel]
```



Note

Once method is locked, "2. Method Data" on Menu 5. Data copy may not be used. Once method is unlocked, "2. Method Data" on Menu 5. Data copy may be used.

3-2. Titration, Electrode and Preamplifier

For correct titration, it is important to know the characteristics of reagent and reaction of solutions, and then to select appropriate titration control, detection electrode and preamplifier. The below chart shows the relations of titration, electrode, preamplifier and control.

Titration	Control	Remark	Electrode/Preamplifier
Blank titration of reagent	Auto Int. (Blank mode)	For titration less than 0.3mL	
Strong acid – Strong base HCl – NaOH H ₂ SO ₄ – NaOH	Auto Tit.	Increase control speed when reaction is fast.	Combination glass electrode C-171 STD preamplifier
Weak acid – Strong base Strong acid – Weak base Weak acid – Weak base Benzoic acid – KOH HCl – Na ₂ CO ₃ HClO ₄ –Potassium hydrogen phthalate	Auto Tit.	Slow down control speed if reaction is slow with less than 1/100mol/L. Also use Auto Int.	Combination glass electrode C-171 or Combination double junction electrode C-173 STD preamplifier
Precipitation titration	AgNO ₃ – I ⁻ Br ⁻ Cl ⁻ CN ⁻ S ²⁻ SCN ⁻ Pb(Cl O) ₂ – SO ₄ ²⁻	Auto Tit. Slow down control speed if reaction is slow with less than 1/100mol/L. Also use Auto Int.	Silver electrode M-371 Ref. electrode R-272 For non-aqueous: Silver electrode M-371 Glass electrode H-171 STD preamplifier
Redox titration	Na ₂ S ₂ O ₃ – I ₂ KMnO ₄ – Fe ²⁺ I ₂ – As ₂ O ₃	Auto Tit. Use Auto Int. if reaction is slow and potential comes back.	Combination Pt electrode C-272 If inner solution affect; Silver electrode M-271 and Ref. electrode R-173 STD preamplifier
Petroleum neutralization titration	Acid value of fats/oil Neutralization of fatty acid Acid number of petroleum products Base number of petroleum products	Auto Int. Intermit	For quick measurement, use Auto Int.. Combination glass electrode C-171 when noisy, use: Glass electrode H-171 Ref. electrode R-173 STD preamplifier
Chelatometric titration by ion electrode	EDTA – Zn ²⁺ EDTA – Ca ²⁺	Auto Tit.	Use ionic electrode for detection For Zn ²⁺ – Cu-EDTA, use copper ionic electrode. For Ca ²⁺ , use calcium ionic electrode STD preamplifier
Chelatometric titration by photometric titration	EDTA – Ca ²⁺ , Mg ²⁺ EDTA – Zn ²⁺ EDTA – Ni ²⁺	Auto Int.	Use preamplifier for photometric titration Ca ²⁺ , Mg ²⁺ , Zn ²⁺ – EBT indicator λ=630nm Ni ²⁺ – MX indicator λ=530nm PTA preamplifier
Bromine titration	KBr, KBrO ₃ – Olefin Back titration Na ₂ S ₂ O ₃ – Petroleum resin	Auto Int. Back titration, use Auto Titr.	Use preamplifier for polarization titration Twin Pt electrode M-511 For low current fluctuation: Twin Pt electrode M-512 POT preamplifier
Diazotation titration	NaNO ₂ – Sulfonamide acid, Aromatic primary amine	Auto Int. Intermit	Use preamplifier for polarization or redox titration Use STD. for redox. Twin Pt electrode M-511 For low current fluctuation: Twin Pt electrode M-512 POT preamplifier

3. Method

3-3. Preamplifiers

There are five sorts of preamplifiers connectable with detecting electrode as shown in Table 3-3-1. Select a preamplifier appropriate for your titration. At the time of the device purchase, three kinds of either is connected to the main body depending on an order other than STD preamplifier unit.

Table 3-3-1

Detector number Titration type	1	2	3	Description
Standard preamplifier (STD)	pH / mV	mV	—	Acid base titration, Redox titration, etc. Detector 1: Range -20 - 20pH Resolution: 0.01pH(0.1mV) Detector 2: 0-±2000mV Resolution: 0.1mV
Photometric preamplifier (PTA)	—	—	%T / Abs	Analysis of hydraulic modulus, metal concentration in plating liquid. Detector 3: Transmittance range: 0-120%T Resolution: 0.1%T Absorbance : 0-9.999Abs Resolution: 0.001Abs
Polarization preamplifier (POT)	—	—	μA / mV	Diazotization of dye. Detector 3: Regulated current polar potential titration Loaded current: 0-20μA Voltage : 0-2V Resolution: 0.1mV Regulated voltage polar current titration Voltage : 0-500mV Current : 0-100μA Resolution: 0.01μA
Conductivity preamplifier (CMT)	—	—	μS/cm	Electrical conductivity measurement. Detector 3: Measuring range: 1-100, 1-1000, 1-10000 -S/cm Resolution : 0.01% in each full scale Temperature compensation coefficient: 2% / 1°C (fixed) Range of cell constant : **,*** - 0.**** Reference temperature : 25°C
pH dual input preamplifier (TET)	—	—	pH / mV	Acid base titration, Redox titration, etc. Detector 3: Range -20 - 20pH Resolution: 0.01pH(0.1mV)

3-4. Titration Parameter

Setup the general parameters relevant to titration.

Select [Titration] on the screen where you have selected the method, and press [ENTER]. "Titration" screen will then appear.

```

[Titration]
Method Name
  [METHOD-01 ]
Mode < AutoTit. >
Form   < EP >
-----
Method Name
  
```

[Method Name]

Setup Method Name. The character can be set up to 10.

[Titr. Mode (Mode)]

Set a titration mode to determine how to dose titrant:

- Auto Tit. : This mode allows titrating according to parameter-controlled rate, thereby it accelerates the titration where potential change is small and slows down where the change is large.
- Auto Int. : This mode is appropriate for samples featuring slow chemical reaction that takes time before reaching stable potential while adding titrant.
Dose volume is automatically set according to potential gradient. Blank mode programmed suitable to blank measurement can be selected by selecting this mode.
- Intermit : This mode is designed for cut-off or constant rate titration.
For continuous constant rate titration, enter "0" for "Cut-off time" as control parameter. Titration rate can be set by "Dispense speed". Intermittent titration waits for "Cut-off time" each time titrant is dosed at the preset intervals.
- Stat : Stat titration doses reagent up to maximum volume to the end while keeping Stat level that is preset on control parameter settings. The data are sampled each Lag time when data are read. Time vs. titrant consumption will be printed out as measurement results. The titration form is fixed to "Stat."

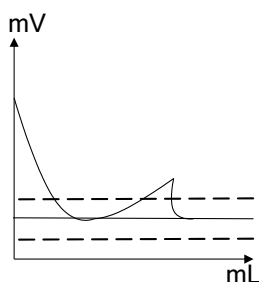

3. Method

[Titr. Form (Form)]

Here you can select a titration form mainly used to find endpoints.

- EP Stop : Titration can detect endpoints to the number (up to 5) of EP (endpoint) preset on Control parameters. If titration volume reaches the maximum volume, however, it ends halfway.

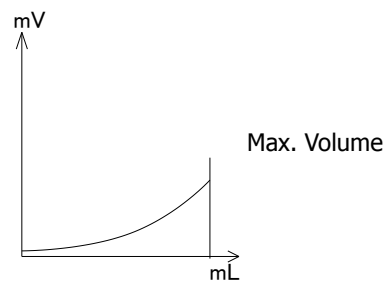
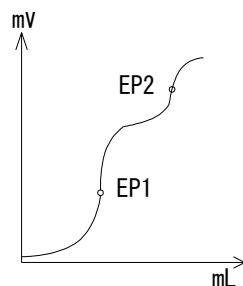

This EP Stop titration form is the typical titration form popularly used. It detects the highest inflection point as EP, and is least influenced by titration conditions, resulting in good repeatability.

- Level : Titration can detect endpoints to the number (up to 2 EP potential levels) of EP preset on Control parameters. When titration volume reaches the maximum volume, however, it ends halfway
This form is useful for those samples measured by such method as non-aqueous buffer method for petroleum products, M-alkali or P-alkali measurement or the like where the EP level is known. For titration with unclear inflection points, it is also recommended to determine endpoints using this titration form where the titration continues to the preset potential level.

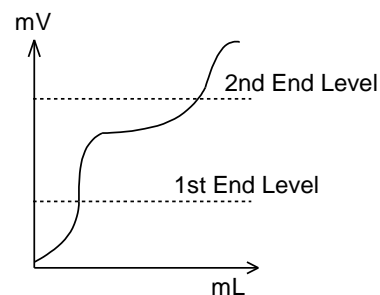

- Full : Titration goes on to the maximum volume as preset on titration parameter. This titration form can detect the endpoint by EP Stop form up to 5 EPs. This form is useful for samples where the number of EP is unknown

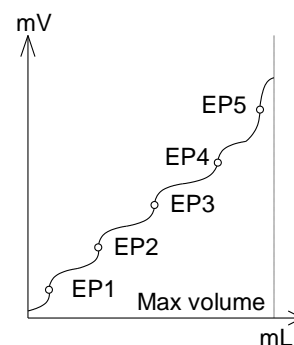

When a titration form is changed, the control parameters of Method are initialized to the default as described in the Chapter "3-5-2. Parameter list".

[Blank Mode]

Blank mode is used for blank measurement and micro determination. This mode can be selected when "Mode" is "Auto Int."

- On : Slowly conducts measurement of Auto Int. as Blank Mode, and detects one end point.
- Off : Performs normal titration in Auto Int.

[Burette No.]

Here you can select the burette number used for titration.

- 1 - 10

[Channel/ Unit]

Here you can select the detector number and the unit of detected potential unit--settable unit depends on the preamplifier selected.

- Ch1, mV : Use for detector 1 and unit in mV.
- Ch1, pH : Use for detector 1 and unit in pH.
- Ch2, mV : Use for detector 2 and unit in mV.
- Ch3, mV : Use for detector 3 and unit in mV when POT or TET preamplifier is connected.
- Ch3, pH : Use for detector 3 and unit in pH when TET preamplifier is connected.
- Ch3, %T : Use for detector 3 and unit in %T when PTA preamplifier is connected.
- Ch3, Abs. : Use for detector 3 and unit in Abs when PTA preamplifier is connected.
- Ch3, μA : Use for detector 3 and unit in μA when POT preamplifier is connected.
- Ch3, $100\mu\text{S}$: Use for detector 3 and conductivity range in $100\mu\text{S}$ when CMT preamplifier is connected.
- Ch3, $1000\mu\text{S}$: Use for detector 3 and conductivity range in $1000\mu\text{S}$ when CMT preamplifier is connected.
- Ch3, $10000\mu\text{S}$: Use for detector 3 and conductivity range in $10000\mu\text{S}$ when CMT preamplifier is connected.

**Note**

"Channel/ Unit" will not be displayed when it is not selected preamplifier.

3. Method

Table 3-4-1. Combination of preamplifiers and detectors

Preamplifier	Detector 1	Detector 2	Detector 3
STD	pH, mV, Temp.	mV	—
PTA	—	—	%T, Abs
POT			μ A, mV
CMT			μ S/cm
TET			pH, mV, Temp.

[Elec.type Check]

Set up the type of electrode you are using with titration. The type is checked with the set one in the smart electrode. If they are different, an error will occur before measurement. This prevents you from using an incorrect electrode. This function is valid only when a smart electrode is used.

- No Check : Select this when a smart electrode is not used or when the type of electrode is not estimated.
- Glass : Select this when you use a glass electrode.
- Platinum : Select this when you use a Pt electrode.
- Silver : Select this when you use an Ag electrode.
- Ref. : Select this when you use a reference electrode.
- Conduct. : Select this when you use a conductivity cell.
- Ion : Select this when you use an ion selective electrode.
- Other : Select this when you use other electrodes.

[Titr.Direction (Direction)]

Here you can select the direction of EP detection:

- Auto : The endpoints of both directions (A and B) are detected regardless of the direction of change in potential.
- Positive : The endpoint like A below with positive direction of change in potential is selectively detected.
- Negative : The endpoint like B below with negative direction of change in potential is selectively detected.

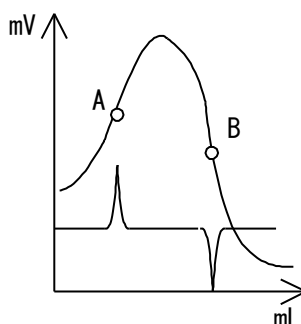

[Max. Volume]

Here you can set maximum titration volume. When it reaches the preset volume, titration will end regardless of the detection of EP or not. The selective range depends on the burettes selected.

The Max. volume should include dose volume.

Burette capacity	Setting range
1,5mL	0 - 999.0000mL

Burette capacity	Setting range
10,20,30,50mL	0 - 9999.0000mL



Do not set an excessive volume that will overflow reagent out of a sample vessel like beaker.

[Wait time]

Here you can select time delay before titration starts. When the preset delay time elapses after pressing [Start] button, actual titration will start. This is useful when it takes a time in titrating hardly soluble samples or in stabilizing potential level.

- 0 - 9999s

[Dose Mode]

Here you can select a dose mode from the followings. The burette for dosing reagent will be one set in "Burette No.". The dose amount set in this dose mode will affect the titration volume of measurement results.

- None : No dosing is applied.
- Volume stop : Dose a reagent up to preset volume on "Stop volume." When potential change of a sample is small, you can shorten measurement time by using "Volume stop".
- Level stop : Dose up to the potential level preset on "Stop level". When the potential at inflection points is stable, you can predose by "Level stop" regardless of titration volume.

Typical plot for volume stop

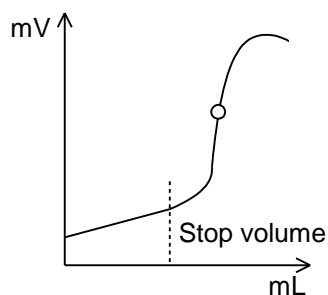

Typical plot for Level stop

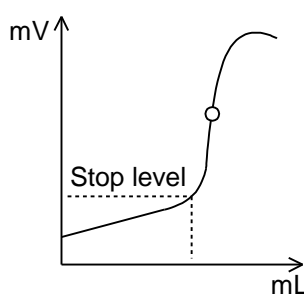
**[Dose Set]**

Here you can select a dose mode method from the followings. This will appear when selecting anything other than "None" on "Dose Mode."

3. Method

< Dose Set Parameter >



[Stop Volume (Volume)]

When "Volume stop" is set for "Dose mode", you select reagent volume to be dosed. When either "Level stop" or "Diff. stop" is set for "Dose mode", you select the maximum dose volume for the burette to be used. When dosed volume reaches stop volume, the burette stops dosing regardless of "Stop level" as shown below.

The setting range for stop volume differs according to the burette unit. See below chart:

Burette capacity	Setting range	Burette capacity	Setting range
1,5mL	0 - 999.0000mL	10,20,30,50mL	0 - 9999.0000mL



Note

Set a greater value than the above for maximum titration volume on titration parameter.

[Stop level]

Here you can select potential level to end dosing when it reaches the set level. This dialog box appears only when "Dose mode" is set to "Level stop". Dosing will stop when detected potential reaches the set level.

- See Chapter "3-5-3. Input range for potential parameter" about the input range.

[Cut Off time]

Here you can select a cut-off time for intermittent dosing. [Cut-off time]=0 means continuous dosing.

- 0 - 9999s

[Unit volume]

Here you can select reagent volume for each cut-off time in intermittent dosing. You cannot set Unit volume when [Cut-off time] is set at '0'. Since the dischargeable amount of reagent depends on the installed burette, see the section "3-5-5. Settings of discharge amount of titrant" in this manual.

- 0.001 - 9999.000mL

[Dispense Speed]

Here you can select dispense speed. This speed differs depending on the burette unit. The range of speed should be set according to the table below:

- 1 - 999s/mL

[Wait time]

Here you can set a time to wait before starting dose. This is useful for viscous or hardly soluble samples.

- 0 - 9999s

3-5. Control Parameter

Configure various settings for your intended titration including titrant dose speed, EP detection method and its conditions.

Control parameters differ depending on the titration form and mode of the preset method as shown below.

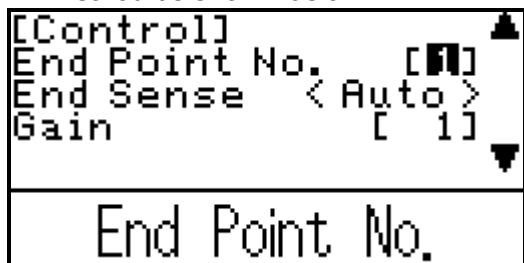

Below chart shows the elements of control parameter. For the details about each parameter, refer to the corresponding chapter.

Control Parameter

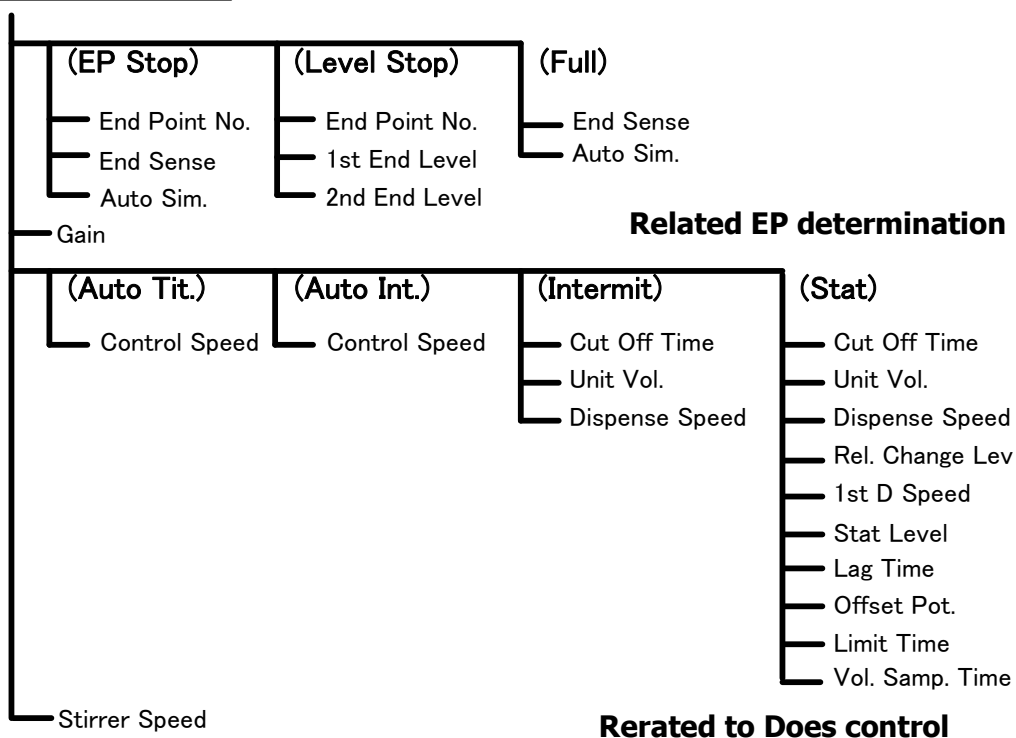

3-5-1. Control Parameter

[End Point No.]

Here you can select the number of endpoints. Titration ends when it detects the preset number of endpoints. This setting will be unable when the titration form is set to "Full."

- 1 - 5 : When titration form is set to "EP Stop"
- 1 - 2 : When titration form is set to "Level Stop"



Note

When titration form is set to "Full", a titration goes on up to the maximum volume regardless of the number of endpoints (up to 5) that are detected during a titration.

[1st End Level] <When Form is Level Stop>

Here you can set the potential level of a first endpoint.

- See Chapter "3-5-3. Input range for potential parameters" about the input range.

[2nd End Level] <When Form is Level Stop>

Here you can select the potential level of a second endpoint when the number of EP's is set to "2".

- See Chapter "3-5-3. Input range for potential parameters" about the input range.

It should be noted that a titration will be carried out in the following way depending on the "Direction" of "Titration parameter":

- Auto : After a titration is initiated, the first endpoint potential level is to be EP1. Then, the second endpoint potential level is to be EP2. As shown in Fig. 2 below, a titration will continue to the maximum volume preset when the first endpoint is not detected.
- Neg. : In negative direction, all the endpoints shown below will be detected as EP. When the initial level is set between levels e.g. 1st and 2nd EP, [1st EP] = [Volume at start of titration], and when the initial potential level is lower than EP1 and EP2, [1st EP] = [2nd EP] = [Volume at start of titration].
- Pos. : When the initial level is set between levels e.g. 1st and 2nd EP, [1st EP] = [Volume at start of titration], and when the initial potential level is higher than EP1 and EP2, [1st EP] = [2nd EP] = [Volume at start of titration].

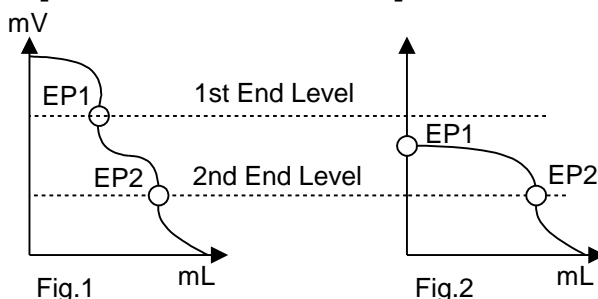

3. Method

[End sense] (When Form is Full or EP Stop)

Here you can select Auto or Set for EP sensing method.

- Auto : End sense is determined automatically. It starts EP sense by default value and then automatically changes EP sense if an endpoint is not found. The change EP sense is stored as "Set", and therefore, chose "Set" from second measurement onward.
- Set : The endpoint is detected according the preset end sense value (dE, dE/dmL).

[dE Sense potential (dE)]

Here you can select a normalized potential to detect EP. The potential difference is the gap between E2 (normalized potential where maximum differential value is detected) and E1 (normalized potential where minimum differential value is detected). When the potential changes more than the preset end sense level, the point will be regarded as a possible endpoint. This will appear when selecting "Set" on "End Sense."

- 0.0 - 99999.9dE

[dE/dmL Sense value (dE/dmL)]

Here you can select the differential difference in normalized potential to evaluate EP. Select a differential difference between a maximum differential value (dE2/dmL) and a minimum value (dE/dmL).

When the potential changes more than preset end sense level, the point is determined to be a possible endpoint. This will appear when selecting "Set" on "End Sense."

- 0.0 - 99999.9dE/dmL

The endpoint is thus determined by preset two end sense levels when the requirements for both dE and dE/dmL are fulfilled.

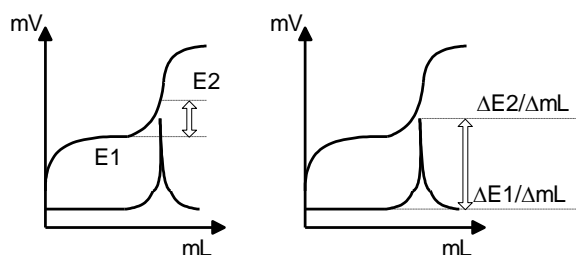

[Auto Sim.]

Here you can select the redetection of endpoints using the automatic simulation. When a titration form is set to "Full" and at least one endpoint is detected, this function will not be implemented.

- Off : Auto simulation will not be put into effect after a titration is completed.
- On : Auto simulation will be put into effect after a titration is completed.

[Gain]

Here you can select the sensitivity of detection signal. Typically, use '1' for this setting.

When potential change is too small to detect, increase the gain.

- 1 - 10

[Control Speed] <When Mode is Auto Tit. or Auto Int.>

Choose your desired speed out of the following modes:

- Fast : For fast reaction like strong acid – strong base.
- Medium : For typical measurements like weak acid – weak base · strong acid – weak base.
- Slow : For slow reaction in dilute titrant (e.g. no more than 0.01mol/L).

[Cut Off Time] <When "Mode" is "Intermit" or "Stat">

Here you can select a Cut-off time for intermittent dosing. It doses at preset intervals. [Cut-off time]=0 means continuous dosing at constant speed. The corresponding speeds for control speed are [Fast] = 1, [Standard] = 5 and [Slow] = 10.

- 0 - 9999s

[Unit Volume] <When "Mode" is "Intermit" or "Stat">

Here you can select a unit volume when the potential gets to the "Dose speed switching potential" ([Rel. Change level]). You cannot set Unit volume when [Cut-off time] is set at '0'.

Since the dischargeable amount of reagent depends on the installed burette, see the section "3-5-5. Settings of discharge amount of titrant" in this manual.

- 0.001 - 9999.000mL

**Note**

When a too narrow range of unit volume is set, the sampled data may exceed the memory capacity (Max.256 points), causing failure in drawing graphical curve. Thus, care should be taken of setting these parameters in consideration of maximum possible titration volume and potential variation.

[Dispense Speed] <When "Mode" is "Intermit" or "Stat">

Here you can select a dispense speed. A dispense speed is the speed after [Rel. Change level] is reached when "Mode" is "Stat".

- 1 - 999s/mL

[Rel. Change Lev.] <When "Mode" is "Stat">

Here you can set "Dose speed switching potential". Setting this level allows dose speed to alter. [Rel. Change level] is set as the potential level relative to "Stat level".

- See the Chapter "3-5-3. Input range for potential parameters" about the input range.

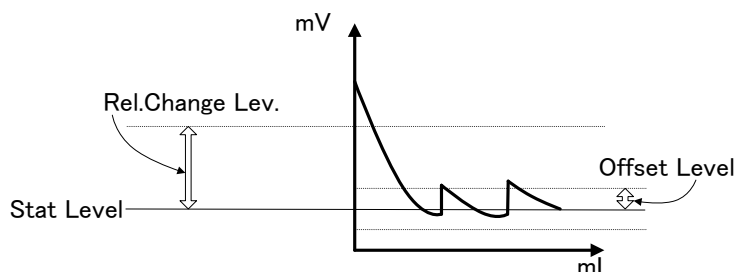

3. Method

[1st D.Speed] <When "Mode" is "Stat">

Here you can select a dose speed until the potential reaches [Rel. Change level].

- 1 - 9999s

[Lag Time] <When "Mode" is "Stat">

Here you can select a data sampling lag time. The data (titration volume, potential, time) will be stored in the memory at preset intervals when Stat titration is performed.

- 1 - 9999s



Note

When a too narrow range of data sampling interval is set, the sampled data may exceed the memory capacity (Max. 256 points), causing failure in drawing graphical curve or performing simulation. Thus, care should be taken of setting these parameters in consideration of maximum possible titration volume.

[Stat Level] <When "Mode" is "Stat">

The potential for Stat control can be set here.

- See the Chapter "3-5-3. Input range for potential parameters" about the input range.

[Limit Time] <When "Mode" is "Stat">

Here you can set a time to limit titration. When titration time arrives at the preset time, a titration will be completed.

- 0 - 9999s

[Offset potential] <When "Mode" is "Stat">

Offset potential can be set here.

Dosing will stop when the potential falls within the offset potential even when there is a deviation between control potential and detection potential. "Offset potential" is set as such potential level is relative to "Stat level".

- See the Chapter "3-5-3. Input range for potential parameter" about the input range.

[Stirrer Speed]

Here you can select an initial stirrer speed for titration. You can select a speed appropriate for sample properties.

- 0 - 9



Caution!

Normally, set the stirrer speed at 4. When precipitation is anticipated during titration, set it at 6 to 8. Care should be taken not to allow the stirrer speed to be too high because the rotator bar may spin out of a beaker depending on the size of the bar, resulting in damages on electrodes.

[Volume Sample Time (Vol. Samp. Time)] <When "Mode" is "Stat">

Here you can set dose volume sampling time (the time elapsed since Stat has started) used in the calculation formula where VT1 - VT5 can be applied. Pressing [Details] button will turn the screen display to "Dosing time setting."

<Vol. Samp. Time Parameter>

The dispense volume of setting time can be used as VT1 - VT5 in the calculation formula.

- 0 - 99999s

3-5-2.Initial values of Control parameters

Parameter	Form and Initial value		
	EP	Level	Full
End Point No.	1	1	—
1st End Level	—	0.00	—
2nd End Level	—	(0.00)	—
End Sense	Auto	—	Auto
dE	(50)	—	(50)
dE/mL	(100)	—	(100)
Auto Sim.	(Off)	—	(Off)
Gain	1	1	1
Stirrer Speed	4	4	4

Parameter	Mode and Initial value			
	Auto Tit.	Auto Int.	Intermit	Stat
Control Speed	Medium	Medium	—	—
Cut Off Time	—	—	0	0
Unit Vol.	—	—	0.1000	0.1000
Dispense Speed	—	—	100	100
Rel.Change Lev	—	—	—	0
1st D .Speed	—	—	—	50
Lag Time	—	—	—	30
Stat Level	—	—	—	0
Limit Time	—	—	—	0
Offset Pot.	—	—	—	0
Vol.Samp.Time				
VT1	—	—	—	0
VT 2	—	—	—	0
VT 3	—	—	—	0
VT 4	—	—	—	0
VT 5	—	—	—	0

3. Method

3-5-3. Input range for potential parameters

The input range for potential parameters depends on "Channel, Unit" of "Predosing parameter" or "Channel, Unit (ctrl.)" of "titration parameter". The chart is shown Channel unit and Input range for potential parameter as below.

Channel/unit	Input range	Potential unit	Differential unit
Ch1, mV Ch2, mV Ch3, mV	-9999.9 - 9999.9	mV	mV/mL
Ch1, pH	-99.99 - 99.99	pH	pH/mL
Ch3, %T	-9999.9 - 9999.9	%T	%T/mL
Ch3, Abs.	-99.999 - 99.999	Abs.	Abs/mL
Ch3, uA	-999.99 - 999.99	μA	μA/mL
Ch3, 100uS	-9999.9 - 9999.9	100μS	100μS/mL
Ch3, 1000uS	-99999 - 99999	1000μS	1000μS/mL
Ch3, 10000uS	-99999 - 99999	10000μS	10000μS/mL

3-5-4. Normalized potential

A normalized potential is a calculated potential for eliminating the difference in titration conditions on preamplifiers used. This parameter is utilized for control, data sampling, EP detection or the like. Sampled potential data will be actually converted according to the following table:

Preamplifier	Unit	Actual potential range	Normalized potential range
STD	mV	-2,000 - 2,000 mV	-2,000 - +2,000 mV
TET	pH	-28 - 28 pH	-2,000 - +2,000 mV
PTA	%T	0 - 100 %T	0 - +1,000 mV
	Abs	0 - 1 Abs	0 - +1,000 mV
POT	μA	0 - 100 μA	0 - +1,000 mV
	mV	0 - 2,000 mV	0 - +1,000 mV
CMT	μS	0 - 100,1000,10000μS	0 - +1,000mV

3-5-5.Settings of discharge amount of titrant

The minimum discharge amount for the titrator depends on the capacity of the burette that is combined with the titrator.

Type of burette unit (Capacity)	Minimum discharge amount
1mL	0.0005mL
5mL	0.0025mL
10mL	0.005mL
20mL	0.005mL
30mL	0.0075mL
50mL	0.025mL

3-6. Calculation Parameter

Equation for concentration calculation is set.

Here you can freely set equations (Max. 5) for concentration calculation.

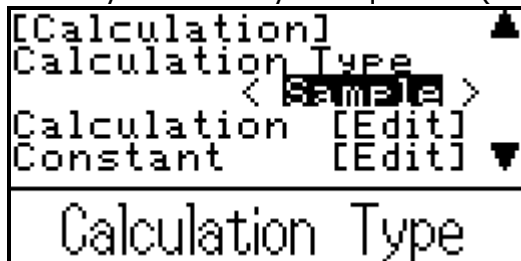

[Calculation Type]

Selection of calculation type:

- Sample : Set up a Method for sample measurement.
- Blank : Set up a Method for blank measurement. Input a blank value to a blank list of "MENU" automatically.
- Factor : Set up a Method for factor measurement. Input a factor value to a factor list of "MENU" automatically.
- Check : Set up a Method for check measurement with standard substance. Check can be record as a result of regular check to history list of "MENU."

[Calculation]

Set up a calculating formula. Move a cursor to [Edit] and press [ENTER].

<About Calculation>

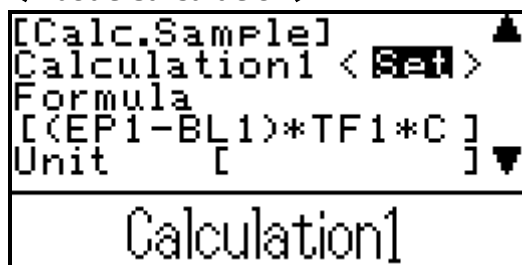

[Calculation1]

Here you can set a calculation formula 1.

- Off : Disable formula 1
- On : Enable formula 1

[Calculation2], [Calculation 3], [Calculation 4], [Calculation 5]

These formulas can be set in the same way (settings) as Calculation1. This setting will be unable when the "Calculation type" is set to "Factor" or "Check."

[Formula]

Here you can set a calculation formula. You can directly input numeric numbers. You can use symbols such as [(), []], symbols for four arithmetic operations and the coefficients shown in the tables '3-6-1' and '3-6-2' below. Example of calculation formula is shown in the table '3-6-3'. A maximum of 60 characters can be input in a calculation.

Table 3-6-1. Enabled symbols for calculation

EP1 - EP5 : Titration volume	TM : Titrating time
CEP1 - CEP5 : Volume (Temp. comp.)	IP : Initial potential
CO1 - CO5 : Concentration calculation	FP : End potential
PK1 - PK5 : Acid dissociation constant	FCO1 - FCO5 : Latest concentration calculation
FV : Final titration volume	FI : Latest titration volume

Table 3-6-2. Symbols

Symbol	Meaning	Reference chapter
TF1 - TF10	: Factor value of titrant	10
BL1 - BL10	: Blank value	9
S	: Sample size	8
PD1 - PD5	: Pre-dosed volume	3-8
DV	: Dosed volume	3-4
VT1 - VT5	: Volume sampling time	3-5-1
C1 - C5	: Concentration conversion factor	3-6
R	: Purity, dilution factor	3-6
K1 - K5	: Unit conversion factor	3-6
FA	: Local factor	3-6

Table 3-6-3. Example of calculation formula

Calculation Type		Example of calculation formula
Sample	Normal titration	$(EP_n - BL_n) \times TF_n \times C_n \times K_n / S$ $(EP_n - EP_{n-1}) \times TF_n \times C_n \times K_n / S$
	Back titration	$(BL_n - EP_n) \times TF_n \times C_n \times K_n / S$
	Hydroxyl value	$((EP_n - BL_n) \times TF_n \times C_n \times K_n + S \times K_{n+1}) / ((EP_n - BL_n) \times TF_n \times C_n \times K_{n+2} + S \times K_{n+3}) + R$
	Acid dissociation constant	<p>PK_n</p> <p>The acid dissociation constant is defined as follows.</p> $pK_a = pH - \log \frac{[B]}{[HB^+]}$ $BH^+ \rightleftharpoons B + H^+$ <p>From this Eq., [B]=[HB+], that is, half neutralized pH shows pKa. More precisely, approximately [B]=[HB+] at half equivalent point, however, due to little error at pKa3-11, the pH at half equivalent point is regarded as pKa.</p>
Factor	Factor	Normal titration $(S \times R \times K_n) / ((EP_n - BL_n) \times C_n)$ Back titration $(S \times R \times K_n) / ((BL_n - EP_n) \times C_n)$

3. Method

[Unit]

Enter a unit used for calculation. Max 10 characters can be set as unit.

[EP No.]

Here you can set the EP position to carry out computation:

- EP1 : Calculate at EP1.
- EP2 : Calculate at EP2.
- EP3 : Calculate at EP3.
- EP4 : Calculate at EP4.
- EP5 : Calculate at EP5.

[Blank Replace]

Set the blank replace number. This setting takes effect when "Calc. type" of calculation parameters is set to "Blank."

- 1 - 10

[Factor Replace]

Set the factor replace number. This setting takes effect when "Calc. type" of calculation parameters is set to "Factor."

- 1 - 10



Select an input method according to [11-10. Other] - "Auto Set. mean" when Blank or Factor is measured with AT-710 and set a value automatically.

[Constant]

Here you can set constants Concentration conversion coefficient, Unit conversion coefficient or the like used in a Concentration calculation formula Put the cursor to [Edit] and press [ENTER].

<Constant>

[Constant]	
C1	[1.000000]
C2	[1.000000]
C3	[1.000000]
C4	[1.000000]
Conc.Coeff1	

[Conc. Coeff1(C1)]

Enter a concentration conversion coefficient for a measured sample. For example, when NaOH is titrated with 1mol/L-HCl, the reaction is expressed as:

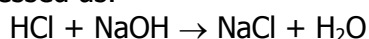

Since this reaction proceeds on 1-to-1 equivalence, 40.00mg of NaOH ($M_w=40.00$) is consumed per 1mL of 1mol/L-HCl. Accordingly, C1 becomes 40.00mg/mL.

- 0.00000 - 99999.99999

**[Conc. Coeff2 (C2)], [Conc. Coeff3 (C3)], [Conc. Coeff4 (C4)],
[Conc. Coeff5 (C5)]**

Same definition as for [Conc. Coeff. 1].

[Unit Coeff1 (K1)]

Here you can set a unit conversion coefficient to convert a unit to like percent (%) or ppm.

For example, when NaOH is titrated with 1mol/L-HCl and the result is expressed in %, the calculation equation will be:

$$\text{NaOH (\%)} = (\text{EP1} - \text{BL1}) \times \text{TF} \times \text{C1} \times \text{K1} / \text{S}$$

Here, when EP1=10(mL), BL1=0.02(mL), TF=1.006, C1=40.00(mg/mL) and S=5.0000(g), K1 should be 0.1 – becomes 1000 when expressed in ppm.

- 0.00000 - 99999.99999

**[Unit Coeff2 (K2)], [Unit Coeff3 (K3)], [Unit Coeff4 (K4)],
[Unit Coeff5 (K5)]**

Same definition as for [Unit coeff. 1 (K1)].

[Constant (R)]

Here you can set a constant of purity or dilution factor.

- 0.00000 - 99999.99999

[Local Factor (FA)]

Here you can set a factor for the method, which is different from a factor (TF) set on reagent information:

- 0.00000 - 99999.99999



Use TF1 - TF10 when Factor is measured and factor value is set automatically with AT-710.

3. Method

[Temp. Comp.]

Here you can set temperature compensation function for titration. A temperature compensation sensor for titration can not be used with the second burette

<Temp. Comp>

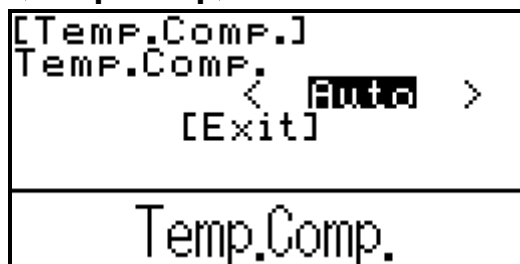

[Temp. Comp.]

Here you can select a method for titrant temperature compensation from:

- Off : No compensation.
- Fixed : Manual compensation.
- Auto : Automatic compensation with the optional sensor for titrant temperature compensation.

[Titrant temp.]

Here you can set titrant temperature when "Temp.comp." is set to "Fixed".

- 0.0 - 100.0°C

[Comp.Temp]

Here you can set titrant compensation temperature when "Temp.comp." is set to either "Fixed" or "Auto".

- 0.0 - 100.0°C

[A]

Here you can set Temperature compensation coefficient. A of a following formula.

- -99999.99999 - 99999.99999

[B]

Here you can set Temperature compensation coefficient. B of a following formula.

- -99999.99999 - 99999.99999

< About Temperature compensation for titrant >

Titration volume needs to be corrected when organic solvent like Acetic acid, Dioxane or Ethanol is used for titrant. Normally, titrant is used at the temperature in factor calibration, however, when titrant temperature differs by more than $\pm 3^\circ\text{C}$ compared with that in standardization, the volume titrated needs to be corrected:

Liquid temperature compensation formula:

$$V = V_0 \times (1 + A \times \Delta T \times 10^{-3} + B \times \Delta T^2 \times 10^{-6})$$

V : Compensated volume

V_0 : Titration volume

ΔT : (Compensated temperature – Titrant temperature)

3-7. Report Parameter

Report is set when printer is connected.

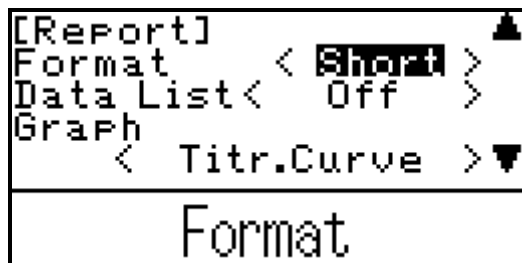

[Format]

Selection of print format:

- Off : No printout.
- GLP : Prints all of measurement parameters and results.
- Short : Prints sample number, measurement date, sample size, measurement results, titration time except measurement condition.

[Data List]

Selection of printout of the data list.

- Off : No printout of data list.
- Short : Prints the endpoint, data number, potential difference and differential difference.
- Det. : Prints Data list and Short form.

[Graph]

Selection of graphic print together with measurement results when they are printed out.

- Off : No printout of graph
- Titr. Curve : printout of titration curve only
- Titr. + Diff. : printout of titration curve and first-derivative curve together.

3. Method

<Print contents>

Item	Print format			
	Off	Short	GLP	
Model/Serial No.		On		
Method name		On		
Sample No.		On		
Sample name		On		
Titration date		On		
Titration parameter		Off		
Control parameter		Off		
Calc. parameter		Off		
Reagent constant		Off		
Blank		On		
Predose result	Off	On	On	
Initial information		On		
Final information		On		
Dose volume		On		
Last volume		On		
Titration time		On		
Sample size		On		
Sample constant		On		
EP Data		On		
Conc.		On		
Operator		On		

<Data List>

[Data List]			
No.	Volume [mL]	Potential [mV]	St
001	0.0000	-40.00	0
002	0.4300	-192.20	0
003	0.4600	-196.30	0
004	0.7950	-200.30	0
005	1.1450	-204.40	0
006	1.4750	-208.40	0
007	1.8200	-212.90	0
008	2.2000	-217.10	0
009	2.5800	-221.30	0
010	2.9600	-225.10	0
011	3.4600	-100.00	0
012	3.5700	1.30	3
013	3.6400	228.80	0
014	3.8000	224.90	0

Titration volume
Actual potential
Status

- Meaning of status -

- 1 : This status number means the max inflection point is not determined to be the EP since it is out of the preset range both in titration volume and potential.
- 2 : This status appears when the max inflection point has been found somewhere a little further than the inflection point that was first found. The status is labeled with 3, 6 or 7 in this case.
- 3 : The max inflection point satisfying the End Sense (dE) and End Sense (dE/dmL) is found, and its measurement results will be then printed out.
- 4 : When a max inflection point is not detected as EP with a titration in the set direction on the titration parameter.
- 6 : When a max inflection point is not detected as EP since the End Sense (dE) value is less than a preset End Sense (dE).
- 7 : When a max inflection point is not detected as EP since the End Sense (dE/dmL) value is less than a preset End Sense (dE/dmL).

018	5.3800	212.90	0
019	5.7600	208.60	0
020	6.1150	204.40	2
021	6.4700	200.20	0
022	6.8300	195.90	0
023	7.1600	191.50	0

EP determined value

[dE]	[dE/dmL]	St
No. 012		
1.666E+02	4.911E+02	3

Total number of data

Data count : 23

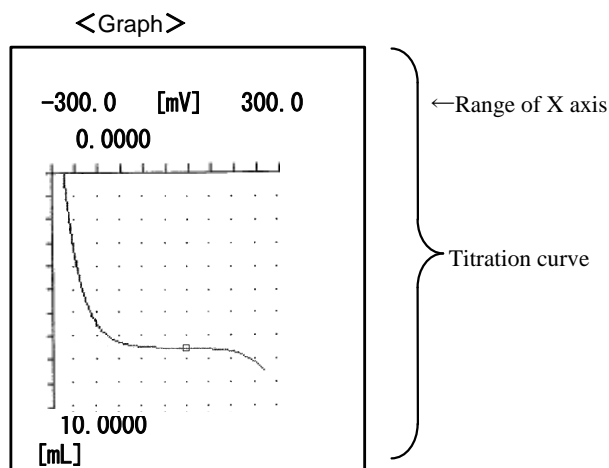

Note

Data list will save all measurement results.

3. Method

<Example of printing measurement results: GLP form>

Model : AT-710	←Model	[Constant]	←Reagent constant
Serial No. : 1930XXXX	←Serial No.	TF1 : 1.00000	
Print : 2014/04/01 10:00	←Printed date	BL1 : 0.00000	←Blank value
*** R e s u l t ***		C1 : 40.00000	
Method No./Name : 01/Auto Titration	←Method No.	K1 : 0.10000	
Titration Mode : Auto Titr.	←Titration mode	Init.Temp. : 26.0 C	} Initial information
Titration Form : EP	←Titration form	Init.Level : -784.8 mV	
Sample No. : 01-01	←Sample No.	Fin.Temp. : 25.8 C	} Final information
Sample Name :	←Sample name	Fin.Level : 1427.6 mV	
Date 2014/04/01 09:50	←Titration date	Dose Vol. : 0.0000 mL	←Dose volume
[Titration]		Last.Vol. : 8.1870 mL	←Last volume
Burette No. : 01	} Titration parameter	Titration Time : 00:04:30	←Titration time
Ch./Unit : Ch1/mV		Size : 5.1647g	←Sample size
Dose mode : None		End point 1	} EP Data
[Control]	Volume : 8.1176mL		
End Point No. : 1	} Control parameter	Potential : 1.3mV	
Stir. Speed : 4		Conc1 : 33.895 %	←Conc.
[Calculation]		(Stop by reset)	←A comment appears when titration is reset
Calc. type : Sample	} Calc. parameter	Operator:Kyoto Taro	←Operator
CO1 : Set			
Formula (EP1-BL1)*TF1*C1*K1/S			
Unit : %			
CO5 : Off			
Temp.Comp. : Off			

3-8. Predosing parameter

Predosing conditions on a sample before measurements is set. Samples can be previously dispensed with up to 5 burettes.

```
[Pre Dose List]
01 None
02 None
03 None
04 None
05 None
[Exit]
```

[No.]

Here you can see the order of predosing for up to 5 burettes. Select the setting number and press [Enter].

```
[Pre Dose 01]
Mode
  < None >
  [Exit]
```

```
Mode
```

[Mode]

Here you can select a dose mode from the followings:

- None : No dosing is applied.
- Volume stop : Dose a reagent up to preset volume on "Stop volume". Use a reagent to dose when a reagent volume is fixed.
- Level stop : Dose up to the potential level preset on "Stop level". When the potential at inflection points is stable, you can predose by "Level stop" regardless of titration volume.
- Dispenser : Dispenses reagent of volume set on "Stop Volume" with the optional auto dispenser. Use this when dispensing solvents.

Typical plot for volume stop Typical plot for Level stop

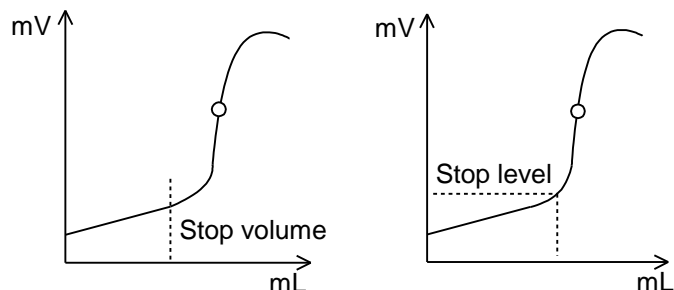

3. Method

[Burette No.]

Here you can select the burette numbers for dosing.

- 1 - 10



Set a burette No. different from a number used for titration. Dosing reagent is set according to a titration parameter.

[Channel/Unit]

Here you can select the detector number and the unit of detected potential--settable unit depends on the preamplifier selected.

- Ch1, mV : Use for detector 1 and unit in mV.
- Ch1, pH : Use for detector 1 and unit in pH.
- Ch2, mV : Use for detector 2 and unit in mV.
- Ch3, mV : Use for detector 3 and unit in mV when POT preamplifier is connected.
- Ch3, Abs. : Use for detector 3 and unit in Abs when PTA preamplifier is connected.
- Ch3, μ A : Use for detector 3 and unit in μ A when POT preamplifier is connected.
- Ch3, 100 μ S : Use for detector 3 and conductivity range in 100 μ S when CMT preamplifier is connected.
- Ch3, 1000 μ S : Use for detector 3 and conductivity range in 1000 μ S when CMT preamplifier is connected.
- Ch3, 10000 μ S : Use for detector 3 and conductivity range in 10000 μ S when CMT preamplifier is connected.

[Stop volume]

When "Volume stop" is set for "Dose mode", you select reagent volume to be dosed. When "Level stop" is set for "Dose mode", you select the maximum dose volume for the burette to be used. When dosed volume reaches stop volume, the burette stops dosing regardless of "Stop level" as shown below.

The setting range for stop volume differs according to the burette unit. See below chart:

Burette capacity	Setting range	Burette capacity	Setting range
1,5mL	0 - 999.0000mL	10,20,30,50mL	0 - 9999.0000mL

[Stop level]

Here you can select potential level to end dosing when it reaches the set level. This dialog box appears only when "Dose mode" is set to "Level stop". Dosing will stop when detected potential reaches the set level.

- See Chapter "3-5-3. Input range for potential parameter" about the input range.

[Cut Off Time]

Here you can select a cut-off time for intermittent dosing. [Cut-off time]=0 means continuous dosing.

- 0 - 9999s

[Unit volume]

Here you can select reagent volume for each cut-off time in intermittent dosing. You cannot set Unit volume when [Cut-off time] is set at '0'. Since the dischargeable amount of reagent depends on the installed burette, see the section "3-5-5. Settings of discharge amount of titrant" in this manual.

- 0.001 - 9999.000mL

[Dispense speed]

Here you can select dispense speed.

- 1 - 999s/mL

[Titr. Direction (Direction)]

Here you can select the direction of EP detection:

- Auto : The endpoints of both directions (A and B) are detected regardless of the direction of change in potential.
- Pos. : The endpoint like A below with positive direction of change in potential is selectively detected.
- Neg. : The endpoint like B below with negative direction of change in potential is selectively detected.

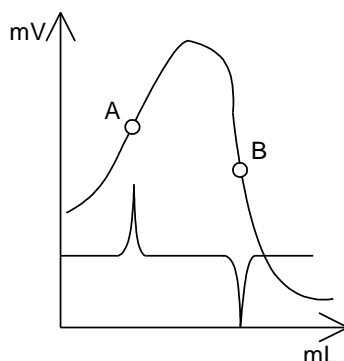
**[Wait time]**

Here you can set a time to wait before starting dose. This is useful for viscous or hardly soluble samples.

- 0 - 9999s

[Stirrer speed]

Here you can select a speed of the rotator bar for the stirrer at dosing. Speed can be selected from nine steps:

- 0 - 9



Set a stirrer speed usually is 4 and use a speed 6-8 when a lot of precipitation is found. The electrode and the like might be damaged as the rotator jumps up and down according to the its size when the rotational speed is raised too much.

3-9. After Titration parameter

1 method selected arbitrarily from method No. 01 - 20 can be connected and measured after titration.

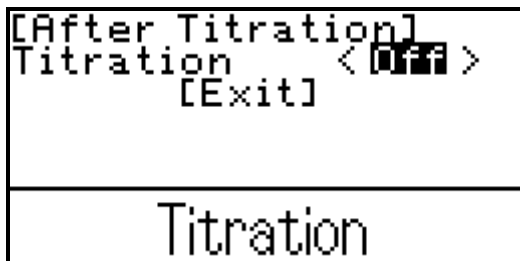

[Titration]

Set combined method

- On : set a combined method
- Off : for single measurement only

[Method No.]

Select the method No. used for measurement from No.01 - 20 after the titration. Then Method Name is displayed.

<Setup of calculation formula when After Titr. is used>

When After Titr. is used, the calculation formula has to be set for each method according to the section "3-6. [Calculation parameter]". However, when the previous measurement results on the combined method are applied to the next method, the constants (FCO1 through FCO5) listed in Table 3-6-1 should be used — e.g. "FCO1" should be used when applying "CO1" (results on the first method) to the next method.

(Example)

First method:

Calculation formula (CO1) = $EP1 * TF1 * K1 * C1 / S$

Second method after titration:

Calculation formula (CO1) = $(EP1 - FCO1) * TF1 * K1 * C1 / S$

4. Calibration

Calibrates preamplifier. Present calibration information can also be checked.

4-1. Calibration condition setup

Press [MENU/HOME] on the main screen. Select "4.Calibration." and press [ENTER].

```
[Calibration]
Ch.1 pH [Cal.] [View]
          [Exit]
```

Set detector channel for calibration.

- Ch.1 : pH calibration by Detector 1. Move the cursor to [Cal.] and press [ENTER]. Calibration condition setup screen will then appear. Move the cursor to [View] and press [ENTER]. Present calibration information will appear. When a smart electrode is connected, what is saved in it will be shown.
- Ch.3 : Regulated current/potential calibration by Detector 3 when POT-preamplifier is connected.
Cell conductivity calibration by Detector 3 when CMT- preamplifier is connected.
Transmittance, %T, by detector 3 when PTA preamplifier is connected. Move the cursor to [Cal.] and press [ENTER]. Calibration condition setup screen will then appear.
Move the cursor to [View] and press [ENTER]. Present calibration information will appear. When a smart electrode is connected, what is saved in it will be shown.

Table 4-1-1. Combination of preamplifiers and detectors

Preamplifier	Detector 1	Detector 2	Detector 3
STD	pH, mV, Temp.	mV	-
PTA	-	-	%T, Abs
POT			μA, mV
CMT			μS/cm
TET			pH, mV, Temp.

4. Calibration



Note

As for Ch3, only the one of the connected preamp is displayed.
For detailed setup of calibration conditions for "Ch1/pH" Channel/Unit, see 4-2.
Configure sensor calibration conditions (Ch1/pH).
For detailed setup of calibration conditions for "Ch3/%T" Channel/Unit, see 4-3.
Configure sensor calibration conditions (Ch3/%T).
For detailed setup of calibration conditions for "Ch3/·S" Channel/Unit, see 4-4.
Configure sensor calibration conditions (Ch3/·S).
For detailed setup of calibration conditions for "Ch3/Pol" Channel/Unit, see 4-5.
Configure sensor calibration conditions (Ch3/Pol).

[pH Table]

Can see the pH table setup screen display. AT-710 is equipped with the table for temperature compensation at pH7/pH4/pH9. For other pH standard solutions, you can configure vicinity temperature and pH value for the pH standard solutions so that temperature compensation is automatically carried out for calibration.



Note

For pH table setup, see "4-6. [pH table]."

4-2. Configure sensor calibration conditions (CH1/pH)

Set calibration conditions for pH electrode.



[Calibration mode]

Set calibration mode for pH calibration:

- Auto : This mode automatically calibrates from the table of correlation of the built-in pH standard with temperature. Up to 5 calibration points can be selected.
- Manual : This mode calibrates to the pH value manually entered. Up to 5 calibration points can be selected.

– Parameters for Auto calibration mode –

[Temp.]

Set the temperature of the standard solution. This setting will be invalid when connecting a temperature compensating electrode and allows to read the temperature automatically during a calibration.

- 0.0 - 100.0°C

[Table]

The user can select a table of temperature compensation for pH standard solution as follows:

- JIS : Table of temperature and pH relation as specified in JIS Z8802
- ASTM : Table of temperature and pH relation as specified in ASTM E70-97 for pH4/pH7/pH9
- BS : Table of temperature and pH relation as specified in BS 1647 for pH4/pH7/pH9
- NF : Table of temperature and pH relation as specified in NF T90-008 for pH4/pH7/pH9
- DIN : Table of temperature and pH relation as specified in DIN19 266 for pH4/pH7/pH9
- NIST : Table of temperature as specified in US ORION's pH "All in One" buffer kits (Cat. No. 910105)
- User : Table of temperature and pH relation as preset on pH table setup display

Refer to table 4-2-1 for the relation of each country's pH standard solution.

Refer to table 4-2-2 for the NIST's relation between temperature and standard solution.

4. Calibration

Table 4-2-1

Standard	pH liquid	Spec. No.	Standard components
JIS	pH4	JIS Z8802	0.05mol/L-Potassium hydrogen phthalate
	pH7		0.025mol/ L-Potassium hydrogenphosphate · 0.025mol/L-Sodium hydrogenphosphate
	pH9		0.01mol/L-Sodium tetraborate
ASTM	pH4	E70-97	0.05mol/kg-Potassium hydrogen phthalate
	pH7		0.025mol/kg-Potassium hydrogenphosphate · 0.025mol/kg-Sodium hydrogenphosphate
	pH9		0.01mol/kg-Sodium tetraborate
DIN	pH4	19 266	Dissolve 10.21g (KHC ₈ H ₄ O ₄) in 1000mL (25°C) water.
	pH7		Dissolve 3.38g (KH ₂ PO ₄)+3.53g (Na ₂ HPO ₄) in 1000mL (25°C) water.
	pH9		Dissolve 3.814g (Na ₂ B ₄ O ₇ ·10H ₂ O) in 1000mL (25°C) water.
BS	pH4	1647	Dissolve 10.21g (KHC ₈ H ₄ O ₄) in 1000mL (20°C) water.
	pH7		Dissolve 3.39g (KH ₂ PO ₄)+3.54g (Na ₂ HPO ₄) in 1000mL(20°C) water.
	pH9		Dissolve 3.80g (Na ₂ B ₄ O ₇ ·10H ₂ O) in 1000mL (20°C) water.
NF	pH4	T90-008	Dissolve 10.21g (KHC ₈ H ₄ O ₄) in 1000mL water.
	pH7		Dissolve 3.402g (KH ₂ PO ₄) + 3.549g (Na ₂ HPO ₄) in 1000mL water.
	pH9		Dissolve 3.81g (Na ₂ B ₄ O ₇ ·10H ₂ O) in 1000mL water.

Table 4-2-2

Standard	temperature	pH		
		pH4	pH7	pH10
NIST	0	4.00	7.11	10.32
	5	4.00	7.08	10.25
	10	4.00	7.06	10.18
	20	4.00	7.01	10.06
	25	4.01	7.00	10.01
	30	4.02	6.98	9.97
	40	4.03	6.97	9.89
	50	4.06	6.97	9.83
	60	4.08	-	-
	70	4.13	-	-
	80	4.16	-	-
	90	4.21	-	-
	95	4.24	-	-

[Calib. point]

Select a combination of pH standard solutions used for calibration:
 When buffer solution temp. table is anything other than "User":

- pH7/4
- pH7/9
- pH4/9
- pH7/4/9

When buffer solution temp. table is "User":

- Std.1/Std.2
- Std.1/Std.3
- Std.2/Std.3
- Std.1/Std.2/Std.3/Std.4
- Std.1/Std.2/Std.3/Std.4/Std.5

[Calibration]

Calibration is performed according to the present calibration conditions.

– Parameter for manual calibration mode –**[Calib. point]**

Select the number of calibration points for manual calibration:

- 2/3/4/5

[Std. buffer 1]

Set pH value for the first calibration point.

- 0.00 - 14.00

[Std. buffer 2]

Set pH value for the second calibration point.

- 0.00 - 14.00

[Std. buffer 3]

Set pH value for the third calibration point. This will appear when "Calib. Point" is set to 3.

- 0.00 - 14.00

[Std. Buffer4]

Set pH value for the fourth calibration point. This will appear when "Calib. Point" is set to 4.

- 0.00 - 14.00

[Std. Buffer5]

Set pH value for the fifth calibration point. This will appear when "Calib. Point" is set to 5.

- 0.00 - 14.00

[Calibration]

Calibration is performed according to the present calibration conditions.

**Note**

For the details of calibration method, see "3-2. Calibration of preamplifiers (pH calibration)" how to operate.

4. Calibration

4-3. Configure sensor calibration conditions (Ch3/%T)

Set calibration conditions on transmittance of an adaptor used for photometric titration when a preamplifier for photometric titration is used:

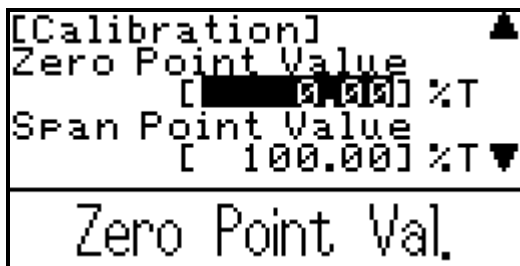

[Zero point val.]

Set a zero calibration value for the photometric titration adaptor. Ordinarily, set it at 0%T when light-transmittance is prevented.

- 0.00 - 120.00%T

[Span point val.]

Select span calibration value for the photometric titration adaptor. Ordinarily, set it at 100%T for the transmittance of pure water.

- 0.00 - 120.00%T

[Calibration]

Calibration is performed according to the present calibration conditions.

 For the details on calibration method, see "4-1-1. Preamplifier for photometric titration (PTA)" how to operate.

4-4. Configure sensor calibration conditions (Ch3/Pol)

Set the conditions of polarization when a preamplifier for polarization titration is used:

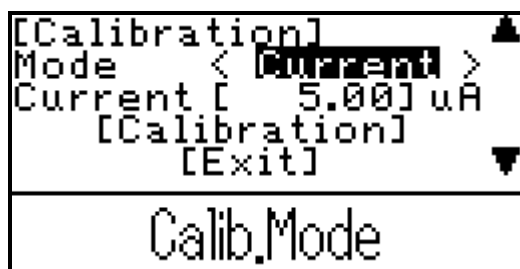

[Calib.Mode (Mode)]

Select a polarization mode:

- Current (Constant current polarization)
- Voltage (Constant voltage polarization)

[Curr.]

Set a polar current for constant polar current mode. This appears when calibration mode is "Current."

- 0.00 - 20.00 μ A

[Volt.]

Set a polar voltage for constant voltage polarization mode. This appears when calibration mode is "Voltage."

- 0.00 - 500mV

[Calibration]

Calibration is performed according to the present calibration conditions.



Note

For the details on calibration method, see "4-1-2. Preamplifier for polarization titration (POT)" how to operate.

4. Calibration

4-5. Configure sensor calibration conditions (Ch3/ μ S)

Set conditions of conductivity cell when a preamplifier for conductometric titration is used:

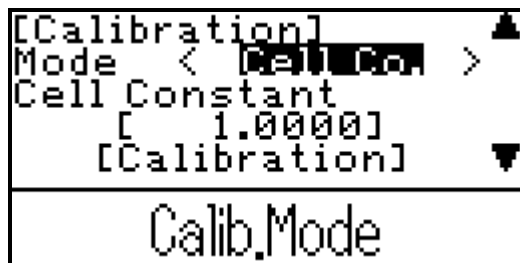

[Calib.Moe (Mode)]

Select a calibration mode:

- Cell Co. (Cell constant)
- STD sol. (Standard solution)

[Cell constant]

Set the cell constant indicated on a conductivity cell. This appears when calibration mode is "Cell Co."

- 0.0000 - 99.9999

[Cond. of std.sol.]

Set the conductivity of standard solution. This appears when calibration mode is "STD sol."

- 0.0 - 9999.9 μ S

[Sample range]

Set a sample range depending on conductivity of standard solution. This appears when calibration mode is "STD sol."

- 100 μ S/1000 μ S/10000 μ S

[Calibration]

Calibration is performed according to the present calibration conditions.



Note

For the details on calibration method, see "4-1-3. Preamplifier for conductometric titration (CMT)" how to operate.

4-6. pH Table

The user can view the table menu screen (as shown below) for setting temperature-pH relation by selecting "pH std. liquid table (Table)" of Ch1 (JIS,ASTM,BS,NF,NIST) or configuring the user defined table.

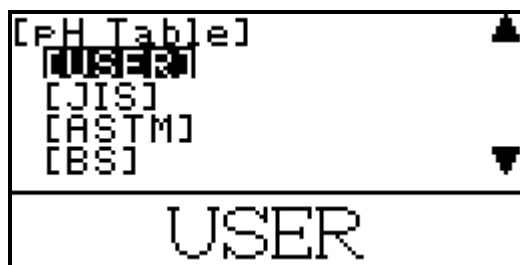

Item	Contents
USER	AT-710 has various pH tables (pH 4/7/9) on the corresponding standards. When using pH standard solutions other than the built-in ones, configuring necessary vicinity temperatures and pH values in using the pH standard solution will allow the temperature in calibration to be automatically compensated to perform calibration. Sets up a table between pH and the temperature which is used when "USER" is specified on "calibration solution temp. table" of Ch1.
JIS	Table for temperature-pH relation as specified in JIS Z8802
ASTM	Table for temperature-pH relation as specified in ASTM E70-97 on pH4/pH7/pH9
BS	Table for temperature-pH relation as specified in BS 1647 on pH4/pH7/pH9
NF	Table for temperature-pH relation as specified in NF T90-008 on pH4/pH7/pH9
DIN	Table for temperature-pH relation as specified in DIN19 266 on pH4/pH7/pH9
NIST	Table for temperature-pH relation as specified in NIST; Actually the temperature table on the US ORION's pH "All in One" buffer kits (Cat. No.910105)

< About "pH Table" screen display of "User">

The user can enter a set of 17 points for temperature (0.0 - 100.0°C) and pH (0.000 - 14.000)



4. Calibration

[Set Buffer1]

The user can set up the lowest pH table.

[Set Buffer2]

The user can set up the second lowest pH table.

[Set Buffer3]

The user can set up the third lowest pH table.

[Set Buffer4]

The user can set up the fourth lowest pH table.

[Set Buffer5]

The user can set up the fifth lowest pH table.

5. Data Copy

5-1. Saving Titration Data

Measurement data can be saved to a USB flash drive.

Press [MENU/HOME] on main screen. Select "5. Data Copy" and press [ENTER]. Then select "1. Result Data" and press [ENTER].
Select either file format as shown below, and save data.

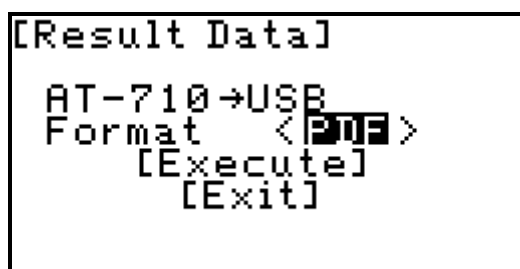

[Format]

- PDF : Select this when saving a file in PDF format or when using data with Tview6. Use this format when sending measurement results to KEM or your nearest distributor.
- CSV : Saved in CSV file. Select this if you wish to perform your own analysis or to make a report with a commonly-used application software product such as Microsoft® Excel®, Microsoft® Access®, Microsoft® Word, etc. The same results as printout are saved except for titration parameters, control parameters and line chart.

[Execute]

Transfers titration data to a USB flash drive in the file format you have selected as mentioned above. See "3-12. Saving Data to USB Flash Drive" of AT-710 Operation Manual for details.



Note

It takes about six (6) seconds to save one measurement data in PDF format to a USB flash drive.

5-2. Saving Method Conditions, Setting Up on PC

Method conditions can be saved to a USB flash drive. They can also be copied from a USB flash drive to the titrator.

Press [MENU/HOME] key on the main screen. Select "5. Data Copy" and press [ENTER]. Select "2.Method Data" and press [ENTER].



Note

This function is not available when method contents are locked. Follow the steps in 1-1 and unlock method first.

```
[Method Data]
1.Select Data
2.All Data
  [Exit]
```

Select how you wish to save method conditions.

Item	Description
1. Select Data	Copies each method individually. Select a method No. of either AT-710 or the USB flash drive, and select the method No. of AT-710 or the USB flash drive to which you wish to copy. Then execute copying.
2. All Data	Copies all data at a time. Select "AT-710→USB" or "USB→AT-710." Then execute copying.

[Execute]

Copies the titration method to a USB flash drive or to AT-710 as you have desired. Move the cursor here and press [ENTER].



Note

If you will save the 50 measurement results in PDF in USB memory, the capacity is about 2.5M byte.

For setup, refer to "4-3.Using method making software" how to operate.

5-3. Saving pH Table, Setting Up on PC

pH tables can be saved to a USB flash drive. They can also be copied from a USB flash drive to the titrator.

Press [MENU/HOME] on the main screen. Select "5. Data Copy" and press [ENTER].
Select "3.pH Table" and press [ENTER].

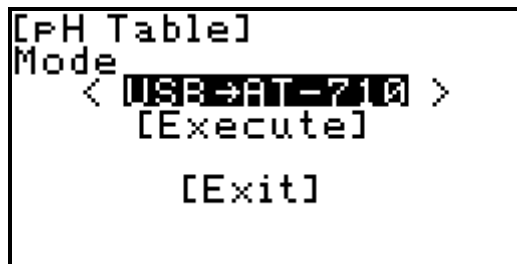

[Mode]

Select how you wish to copy pH tables. Select from "AT-710→USB" or "USB→AT-710."

[Execute]

Copies the titration method to a USB flash drive or to AT-710 as you have desired. Move the cursor here and press [ENTER].



Note

For setup, refer to "4-3.Using method making software" how to operate.

6. Changer

Set changer parameters when connecting CHA-700.

Press [MENU/HOME], select "6.Changer" with [↑][↓] and press [ENTER]

6-1. Setting Up Changer Mode

Set up changer parameters when connecting a multiple sample changer. Changer operations can be set.

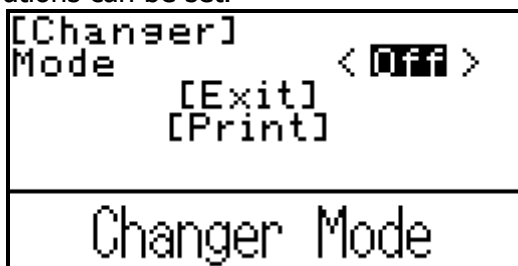

[Changer Mode (Mode)]

Select "On" when using the optional sample changer.

- Off : Changer is not used.
- On : Changer is used.

[Size List]

Set the sample size beforehand collectively at the balance.

- Off : Input the sample size individually on sample setting screen.
- On : Input several sample size beforehand collectively. When this setting is "On", "Size" is changed to "Size List" on sample setting screen so that sample size can be stored up to 12.

[Method]

Set the adaption mode of measurement method.

- Variable : A sample condition individual can be specified a method.
- Fixed : Measure by current method. Use for measurement at the same sample condition.

[Shower]

Set the rinsing mode.

- Off : Rinsing unit is not used. Only dip cleaning can be used.
- Bath : Use for installation of rinsing pot and rinsing with solution. After measurement, operate shower rinsing and dip cleaning with solution in rinsing pot.
- Ring : Use for installation of shower ring, rinsing with nonaqueous solution and soaking with solution. After measurement, operate shower rinsing at measurement position and dip cleaning with the beaker set at home position. After the final sample measurement is ended, solution for dip cleaning is automatically filled to end.

[Time]

Sets up operating time of command you wish to execute. Zero ("0") means no operation.

- Drain : Sets up drain time by optional drain pump.
- Shower : Sets up shower rinsing time by optional shower pump. Executes drain as well during shower rinsing.
- Rinse : Sets up electrode dip time by rinse bath. A propeller stirrer operates during immerse rinsing.

[Rinse Stir. Speed]

Here you can select a stirrer speed for electrode dip by rinse bath.

- 0 - 9

[Start Mode]

Set the operation mode at the starting measurement.

- 1 : Measure in order of putting on the table after turning on the power.
- 2 : Measure in order of small number of table No. put on the table at the starting measurement, and in order of putting on the table after measurement.

6-2. Changer Mode Screen

Use changer mode when using the multiple sample changer. Set "CHA Mode" to "On" so that you can, on main screen, execute sample setting or manually operate the changer.

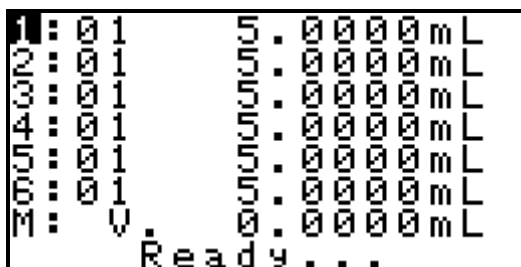

<Sample Setting Screen>

Move the cursor with [↑] [↓] keys to the number corresponding to the table No. of the multiple sample changer. Then press [ENTER]. Sample setting screen will appear.

[Sample No.]

Here you select sample number. The sample number consists of a high order and low order number. The high order number is a group number for batch calculation. The low order number counts up after each measurement.

- 00 - 99

[Size] (When "Size List" is Off)

Input "Sample weight". When a balance is connected, sample size can be according to setting of the balance; sample size is entered in absolute value.

- 0 - 99999.9999

[Size List] (When "Size List" is On)

Move the cursor to [Edit] and press [ENTER]. When mass is input from the balance by "Print" mode, the sample size can be input up to 12 samples on the balance side. The sample is measured in order of setting No. at Next No. before starting measurement. This sample size is measured in order of sample size of the table measured next regardless of table No..

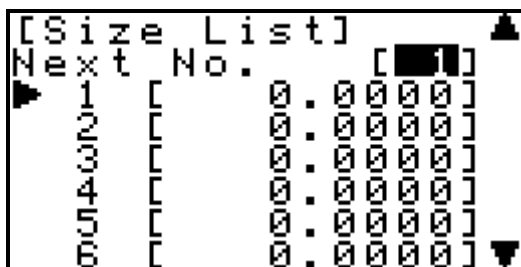

[Unit]

Select a unit for sample (mL, mg, g).

[Sample Name]

You can name a sample with characters up to 10 letters.

[Method No.]

Set up the method No. you wish to use in measurement. Once set, the method name will appear in "Method Name." When "6.Changer - [Method]" is "Fixed", and either of method No. of the sample setting screen is changed, all the sample conditions is reflected.

- 01 - 20

<Multiple Sample Changer Manual Operation Screen>

Move the cursor to [M] with [↑] [↓] keys and press [ENTER]. The multiple sample changer can manually be operated.

[↑]	: Moves up the table to the top.
[↓]	: Moves down the table to the bottom.
[←]	: Moves the arm to the left by one slot.
[←] Hold	: Move the arm to the original position.
[→]	: Moves the arm to the right by one slot.
[ENTER]	: Executes shower rinsing.
[START/STOP]	: Executes drain.
[MENU]	: Leaves sample changer manual operation screen.

7. History

Check history/record and calibration history/record can be reviewed.

Press [MENU/HOME], select "7.History" with [↑][↓] and press [ENTER]

Calibration results can be reviewed if you print out with [Print] key.

```
[History]
1.Check
2.Calibration(ch1)
4.Burette Vali.
   [Exit]
```

Move the cursor with [↑][↓] keys to the item you wish to review. Then press [ENTER].

Details of each item are as follows:

Item	Contents
1. Check	Shows history/record of a periodic check. The measurement result will appear that set up a Method for check measurement.
2. Caliration. (Ch1)	Shows calibration history/record of the electrode on detector No. 1.
3. Calibration (Ch3)	Shows calibration history/record of the electrode on detector No. 3. (Shown only when detector No. 3 is connected.)
4. Burette Vali.	Shows history/record of a burette capacity check.



Note

Up to 10 data can be saved. When exceeding, data will be deleted from the oldest.

8. Sample

Sets up sample-related parameters

Select [SAMPLE] on main screen. Or press [MENU/HOME], select "8.Sample" with [↑][↓] and press [ENTER].



[Sample No.]

Here you select sample number. The sample number consists of a high order and low order number. The high order number is a group number for batch calculation. The low order number counts up after each measurement.

- 00 - 99

[Size]

Input "Tare + Sample weight". When a balance is connected, sample size can be entered according to setting of the balance; sample size is entered in absolute value. Use "S" in the calculation formula.

- 0 - 99999.9999

[Unit]

Select a unit for sample (mL, mg, g).

[Sample Name]

You can name a sample with characters up to 10 letters.

[Method No.]

Sets up the method No. you wish to use in measurement. Once set, the method name will appear in "Method Name."

- 01 - 20

8. Sample

<Sample Setting After Titration Has Started>

Press [SAMPLE] during titration. Below screen will appear and sample setting can be made. After entering items you wish to set up, move the cursor to [Exit] and press [ENTER].

[Sample]	▲	
No.	01-01	
Size	[████████ 0.1050]	
Unit	< g >	▼
Sample size		



Note

Once measurement has started, sample No. and method No. cannot be changed.

9. Blank List

Blank values can be set. This value is automatically updated when "Blank" is selected on "Calc. Type."

Press [MENU/HOME], select "9.Blank List" with [↑][↓] and press [ENTER]. Up to 10 blank values can be preset.

[Blank(BL)]	
1	[0.000000]
2	[0.000000]
3	[0.000000]
4	[0.000000]
5	[0.000000]
6	[0.000000]
7	[0.000000]

[Blank1(BL1)],...[Blank10(BL10)]

Here you enter blank values. Enter blank values with [↑][↓][←][→] keys, and press [ENTER].

Such numbered blank values can be selected and used in concentration calculation on Method parameter for calculation parameter.

- 0.00000 - 9999.99999

10. Factor List

Factor values can be set. This value is automatically updated when "Factor" is selected on "Calc. Type."

Press [MENU/HOME], select "10.Factor List" with [↑][↓] and press [ENTER]. Up to 10 factor values can be preset.

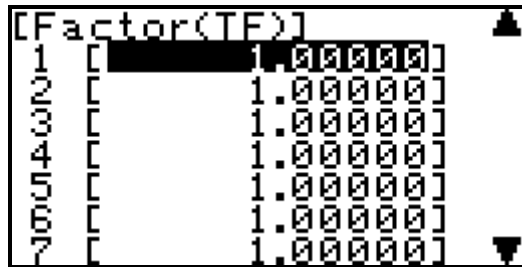

[Factor(TF)]	
1	1.000000
2	1.000000
3	1.000000
4	1.000000
5	1.000000
6	1.000000
7	1.000000

[Factor1 (TF1)],...[Factor10 (TF10)]

Here you enter factor values. Enter factor values with [↑][↓][←][→] keys, and press [ENTER].

Such numbered factor values can be selected and used in concentration calculation on Method parameter for calculation parameter.

- 0.00000 - 9999.99999

11. Setup

Sets up system-related settings.

Press [MENU/HOME], select "11.Setup" with [↑][↓] and press [ENTER].

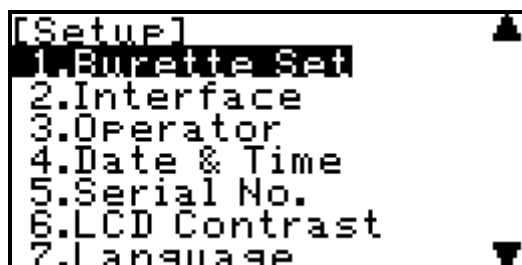

Items and contents, please see below.

Items	Contents
1. Burette Set	Sets up the capacity of the burette connected to the titrator.
2. Interface	Set up the use of printers, balance , Personal computers and , USB or other instruments.
3. Operator	Here the operator is defined for identification.
4. Date & Time	Date and clock time can be set.
5. Serial No.	The connected device, burette, the version number of the auto sampler and software version number can be checked.
6. LCD Contrast	The contrast for LCD can be adjusted.
7. Language	Languages can be set.
8. Beep	Beep tone for alarm can be selected on this display.
9. Para. Clear	It is necessary to initialize preset parameters and setting in order to reset the system to default value. In this instrument, partial initialization (measurement date only, etc.) is possible.
10. Smart Electrode	Setting up the smart electrode.
11. Other	Automatically sets up blank, factor or display size of results.

11. Setup

11-1. Burette Set

Capacity of the burette you are going to use can be set.

Select "1.Burette Set" with [↑][↓] and press [ENTER].

```
[Burette Set]
01 Burette1
      [Exit]
```

Select with [↑][↓] keys the burette currently connected to the titrator, and press [ENTER]. Select with [←][→] keys the capacity of the burette, and press [ENTER]. Move the cursor to [Execute], and then press [ENTER] to set the capacity.



Note

When two burettes are connected, set the capacity of each burette separately. Correct measurement results will not be obtained with incorrect capacity entered. See "2-5. Setting Burette Volume" of AT-710 Operation Manual for how to set.

11-2. Interface

Output settings to PCs, printers, balances and other instruments can be made. Any two devices or three of a PC, a USB printer and a balance can be set.

Select "2.Interface" with [↑][↓] and press [ENTER].

```
[Interface]
1.RS-232C
2.Printer
3.Balance
4.USB
5.Other
      [Exit]
      [Print]
```

11-2-1. RS-232C setting

Select "1.RS-232C" with [↑][↓] and press [ENTER].

```
[RS-232C]
Interface < NONE >
      [Exit]
```

Interface

[Interface]

Select a COM port on which you wish to output RS-232C. Only one RS-232C can be connected. Select where a printer or a balance is not connected.

- COM1 :RS output is set to COM1.
- COM2 :RS output is set to COM2.

[Baud Rate]

Select baud rate:

- 300bps / 600 bps / 1200 bps / 2400 bps / 4800 bps / 9600 bps

[Parity]

Select parity:

- None/Even/Odd

[Stop Bits]

Select stop bits:

- 1bit / 2bit

11. Setup

[Data Bits]

Select data bits:

- 7bit / 8bit



Note

See "12-7.PC" of this manual about the explanation of RS-232C. When you want to transfer the output data to a personal computer, you need to purchase our optional Data Acquisition Software (SOFT-CAP). But you have to check the version of the Data Acquisition Software because some software cannot be compatible with the titrator. For more information, please contact your sales representative nearest to or local dealer.

11-2-2.Printer setting

Select "2. Printer" with [↑][↓] and press [ENTER].

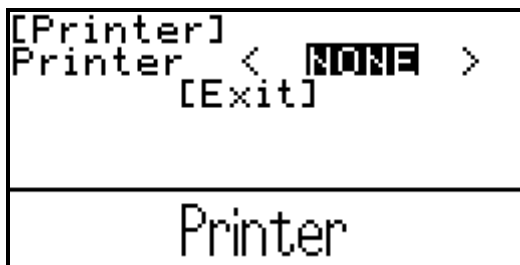

[Printer]

Select a type of printer you are going to use: Select "NONE" if no printer is connected.

- NONE :No printer.
- IDP- :KEM's impact dot printer model IDP-100.
- DP-USB :Select this when connecting our thermal printer (DP-600) to the USB port.
- OTHER :Other printer than the above.



Note

For printer type and configurations, refer to the Table 11-2-2-1. The communication protocol between your printer and titration unit must match. Otherwise, printing may fail and halt halfway. For digital configurations for your printer, refer to the operation manual for the printer.

[Baud Rate]

If you use other printer as defined on [Printer], you have to select baud rate for your printer:

- 300bps / 600 bps / 1200 bps / 2400 bps / 4800 bps / 9600 bps

[Parity]

If you use "Other" printer as defined on [Printer], you have to select parity for your printer:

- NONE/EVEN/ODD

[Stop Bits]

If you use "Other" printer as defined on [Printer], you have to select stop bits for your printer:

- 1bit / 2bit

[Data Bits]

If you use "Other" printer as defined on "Printer", you have to select data bit for your printer:

- 7bit / 8bit

Table11-2-2-1

Printer	Cables	Titrator setup		Printer settings
Citizen	Connecting cable	Printer	IDP-	Digital configurations for printer:
CBM-910	12-02013			Baud rate :4800
CBM-910	64-00625			Parity :none
Type II				Stop bits :1
				Data bits :8

11-2-3. Balance setting

Select "3. Balance" with [↑][↓] and press [ENTER].

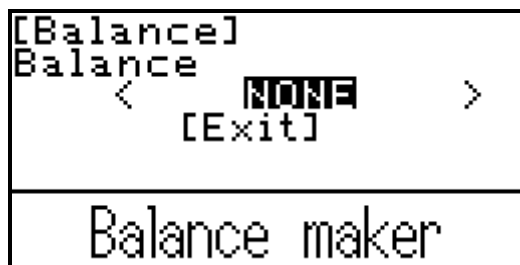
**[Balance maker (Balance)]**

Select the maker's name of your balance. Select "NONE" if no balance is connected. For details data format, refer to the Table11-2-3.

- NONE
- KEM
- Mettler
- A&D
- Shimadzu
- Sartorius
- Mettler-Old

**Note**

Make sure to contact your local dealer to see if any particular connecting cable may be required.

11. Setup

Table 11-2-3. Balance setting

Balance	KEM	Mettler	Mettler-Old	A&D	Shimadzu	Sartorius
Baud Rate	2400	9600	2400	2400	1200	1200
Parity	Even	None	Even	Even	None	Odd
Data Bits	7	8	7	7	8	7
Stop Bits	1	1	1	1	1	1
Handshake					H-oFF	
Delimiter	CR/LF	CR/LF	CR/LF	CR	CR	CR/LF

[Interface]

Select a COM port on which you wish to output the balance. Only one balance can be connected. Select where a printer or RS-232C is not connected.

- COM1 : Output of balance is set to COM1.
- COM2 : Output of balance is set to COM2.

[Mode]

Select the receive mode from the balance.

- Continuous : Select "Continuous" mode on the balance to enter the weight of the balance from the titrator.
- Print : Press "Print" key of the balance to enter the weight from the balance.

11-2-4.USB setting

Select "4. USB" with [↑][↓] and press [ENTER].

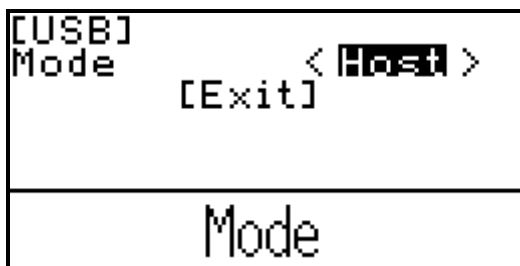

[Mode]

Select USB mode. Normally select "Host." Once setup is completed, restart the titrator.

- Host : Select this when connecting USB devices.
- MCU : Select this when connecting the AT-Win or MCU-710 through USB.



Note

When setting to "HOST," power will be supplied to connected instruments. When AT-Win or MCU-710 is connected, make sure to supply power only to AT-710 and to change the mode to "MCU." Otherwise, connected instruments may break.

11-2-5. Setting up other instruments

Select "5. Other" with [↑][↓] and press [ENTER].

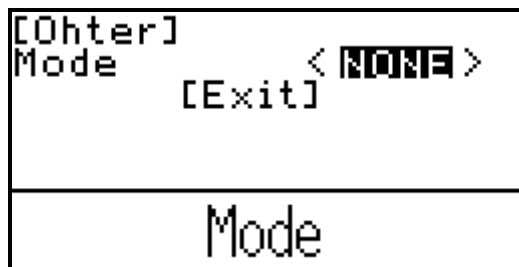
**[Mode]**

Select instruments you wish to connect. Select "NONE" if nothing is connected.

- NONE : Nothing is connected.
- K-360 : Communication with the Buchi Kjeldahl distiller (model K-360) will be done via COM2 port. If you wish to connect the titrator to K-360, you will need to change the nozzle joints.

K-360setting

Baud Rate	4800
Parity	EVEN
Stop Bit	1
Data Bit	8

11-3. Operator

Up to 10 operators can be registered with individual names. The registered name will be automatically printed out together with measurement results. (Characters: alphanumeric capital letters)

Select "3. Operator" with [↑][↓] and press [ENTER].

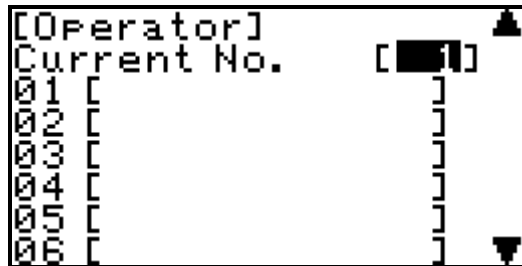

[Current No.]

Select the number of the operator you wish to put on the measurement data. Select with [←] [→] keys and press [ENTER].

To enter an operator: Move the cursor with [↑] [↓] keys to the number (01 to 10) you wish to enter. Press [ENTER]. Then enter a name with [↑] [↓] [←] [→] keys, and press [ENTER] again. Up to twenty (20) letters can be input.

11-4. Date & Time

Date and clock time can be set.

Select "Date & Time" with [↑][↓] and press [ENTER].

```
[Date & Time]
 2014/04/01 13:35
Date Style
 < YYYY/MM/DD >
Date
 [ 2014/04/01 ]
Time [ 13:34 ]
 [Exit]
```

[Date Style]

Here you select and update the date of year, month and day. Select with [←][→] and press [ENTER].

- YYYY/MM/DD : Christian year/month in number/day of the month
- MM/DD/YYYY : month in number/day of the month/Christian year
- DD/MM/YYYY : day of the month/month in number/Christian year

[Date]

Input the present date (2001/1/1 - 2099/12/31). Input with [↑][↓][←][→] keys, and press [ENTER].

[Time]

Input the present time (00:00 - 23:59). Input with [↑][↓][←][→] keys, and press [ENTER].



Note

See "2-4. Setting date and time" of AT-710 Operation Manual for how to set.

11. Setup

11-5. Serial No.

Serial No. and the software version of the titrator are shown.

Select "5. Serial No." with [↑][↓] and press [ENTER].

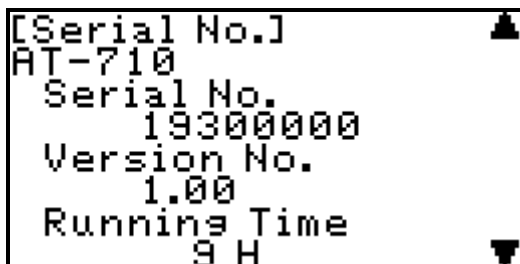

```
[Serial No.]
AT-710
Serial No.
19300000
Version No.
1.00
Running Time
9 H
```

[Serial No.]

When the multiple sample changer is connected, its serial No. and software version will also be shown.



Note

Make sure to advise your distributor of the serial No. and the software version should you require servicing.

[Running Time]

Multiplication of the operation time for measuring equipment is displayed.

[ReNew]

You can make sure if all of the peripherals are connected securely.

11-6. LCD Contrast

The contrast for LCD can be adjusted.

Select "6. LCD Contrast" with [↑][↓] and press [ENTER].



```
[LCD Contrast]
Light           Dark
←             ■             →
               [Exit]
```

[LCD Contrast]

Adjust contrast of LCD with 14 steps by [←], [→] key and confirm by [ENTER] key.

11-7. Language

Select the language you wish to use.

Select "7. Language" with [↑][↓] and press [ENTER].

```
[Language]
Language
  < English >
  [Exit]
```

[Language]

Move the cursor with [←] [→] keys to the language you wish to use, and press [ENTER].

- English : Shows in English.
- Japanese : Shows in Japanese.
- Mandarin : Shows in Mandarin Chinese.
- Korean : Shows in Korean.
- Russian : Shows in Russian.
- Spanish : Shows in Spanish.

**Note**

See "2-3. Setting Language" of AT-710 Operation Manual for how to set.

11-8. Beep

Select the beep at the end of measurement.

Select "8. Beep" with [↑][↓] and press [ENTER].

```
[Beep]
Beep  < Set >
Type  < Type1 >
      [Exit]
```

[Beep]

Select the beep.

- Off : Turns off the beep. Turns off the beep during measurement as well.
- Set : Sets up the beep. Select from types below

[Type]

Select the beep from the five (5) types below.

Move the cursor with [←] [→] keys to the type you wish to use, and press [ENTER].

- Type1 : Beep sound lasts for about two seconds: "pi, pea-pea-pea-pea"
- Type 2 : Beep sound lasts for about four seconds: "pi-pi-pi-pi-pi-pi"
- Type 3 : Beep sound lasts for about ten seconds: "pi, pea-pea-pea-pea"
- Type 4 : Beep sound lasts for about one second: "pi-pi-pi-pi-pi-pi"
- Type 5 : Beep sound lasts for about one second: "pi, pea-pea-pea"

11-9. Parameter Clear

It is necessary to initialize preset parameters and settings in order to reset the system to default value. In this instrument, partial initialization (measurement data only, sample file only, etc.) is possible.

Select "9. Parameter Clear" with [↑][↓] and press [ENTER].

```
[Parameter Clear]
1.Method Parameter
2.Measure Data
3.History
4.Changer Parameter
5.All Parameter
  [Exit]
```

Select the item to initialize by [↑], [↓] key and confirm by [↵] key. See items that can be initialized in below.

Items	Contents
1. Method Parameter	Initialize parameters (Titration, Control, Result) of each Method.
2. Measure Data	Erase all measurement results data stored in Data File.
3. History	Erase all the calibration records and the check records in History.
4. Changer Parameter	Initialize all the settings for the auto sampler.
5. All Parameter	Initialize all of the above items once for all.

When initialization is chosen, the confirming message appears. Select Yes/No by [↑], [↓] key and confirm by [ENTER] key.



Note

1.Method Parameter and 5.All Parameter cannot be used if it is not allowed to revise the contents of the method. Refer to 3-1 to unlock the method before use.

11-10. Smart Electrode

Setting up the smart electrode. Valid when a smart electrode is connected.

Select "10.Other" with [↑][↓] and press [ENTER]. What is set up in this section can be viewed from [View] of each channel of MENU-4.Calibration.

```
[Smart Electrode]
1.Initialize
2.Alarm
3.Check
  [Exit]
```

The display below will appear if a smart electrode is not connected.

```
[Smart Electrode]

Unconnected!!!

  [Exit]
```

11-10-1.Initialize of smart electrode

Select "1.Initialize" with [↑][↓] and press [ENTER]. Initialize the smart electrode before use.

```
[Smart Elec. Init.] ▲
Serial No.
[ ]
Type < Glass > ▼
-----
Serial No.
```

[Serial No.]

Setting up the serial number of the electrode. Up to ten (10) characters can be used.



Note

Errors of the smart electrode are managed with this serial number.

[Type]

Setting up the type of the electrode. Check the electrode type set in the method. If different, an error will occur during measurement. This prevents you from using an incorrect electrode.

- Glass : Select this when you use a glass electrode.
- Platinum : Select this when you use a Pt electrode.
- Silver : Select this when you use an Ag electrode.
- Ref. : Select this when you use a reference electrode.
- Conduct. : Select this when you use a conductivity cell.
- Ion : Select this when you use an ion selective electrode.
- Other : Select this when you use other electrodes.

[Model]

Setting up the model of the electrode. Up to ten (10) characters can be used.

[Channel]

Setting up the detector number you are using. The number is checked with the set one in the method. If they are different, an error will occur before measurement. This prevents you from using an incorrect electrode.

- 1 : Select this when you use with the detector 1.
- 2 : Select this when you use with the detector 2.
- 3 : Select this when you use with the detector 3.

[Execute]

Initializing the smart electrode per set conditions.

If the display below appears, initialize the smart electrode.

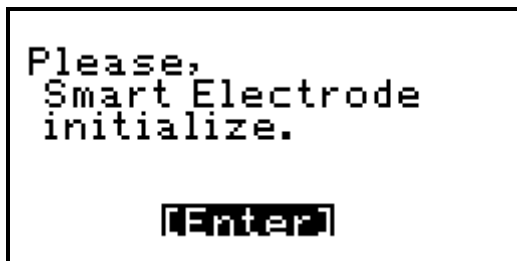

11. Setup

11-10-2.Setting up alarm

Select "2.Alarm" with [↑][↓] and press [ENTER].

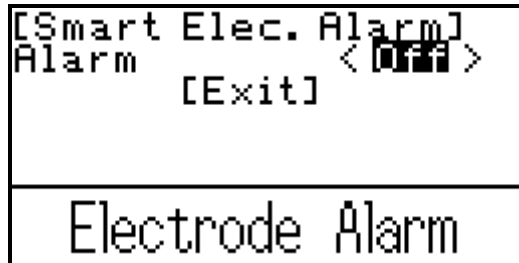

[Alarm]

Setting up the expiration of the smart electrode.

- Off : Select this when you do not set up the alarm.
- On : Select this when you set up the alarm.

[Days]

Setting up the expiration date of the electrode. When the set period has passed from the date of initialization (or the first calibration date with an electrode which requires calibration), an alarm will be given at the start of measurement (or at the start of calibration with an electrode which requires calibration). This is valid when "Alarm" is set to "On."

- 1~9999 days

11-10-3.Check

Select "3.Check" with [↑][↓] and press [ENTER]. Operation of the smart electrode can be checked when "Smart Electrode Error" appears.

A display for operation check of smart electrode appears. Select [Yes] and press [Enter].

"OK" will appear with a good smart electrode. "NG" will appear with an abnormal one.

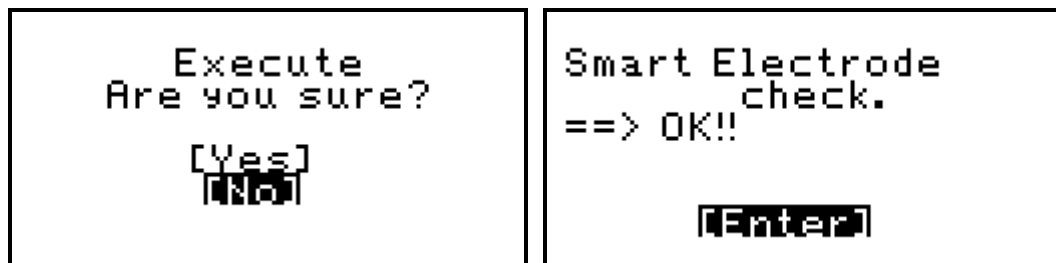

11-11. Other

Display/printout format and automatic setting of mean values can be set up.

Select "11.Other" with [↑][↓] and press [ENTER].



[Character Display]

Select the font size of measurement results on screen. Select with [←] [→] keys, and press [ENTER].

- Normal : Results are shown in normal size.
- Large : Results are shown in twice the size of "Normal."

[Print Header]

Make setting of header printing. The header includes 'Model name', 'Serial No.' and 'Print date'. Select with [←] [→] keys, and press [ENTER].

- Off : No header is printed.
- On : Header is printed.

[Print Footer]

Make setting of footer printing. The footer includes a printing operator. Select with [←] [→] keys, and press [ENTER].

- Off : No footer is printed.
- On : Footer is printed.

11. Setup

[Auto Set., mean]

The average value of a plural number of blank levels or factor that have been measured will be automatically set into the blank value(MENU-11.Blank List) to be used in sample setup or the factor value(MENU-12.Factor List) to be used in reagent information respectively. Select "Auto Set. mean" with [←] [→] keys, and press [ENTER].

- Off : No setting. Each measurement result is put in the blank or factor.
- On : Auto set in the blank or factor. A mean value of up to five (5) results is obtained. The value for "Auto Set. mean" is cleared when the method No. is changed on sample setting or when the titrator is turned off.

<Auto blank input>

Set "Calc. Type" to "Blank" on the calculation parameter of the method to perform titration.

A mean value will automatically be input in "MENU-9. Blank List" every time a measurement is performed. The mean value is put on the number which is set on "Blank Replace" in calculation formula.

<Auto factor input>

Set "Calc. Type" to "Factor" on the calculation parameter of the method to perform titration.

A mean value will automatically be input in "MENU-10. Factor List" every time a measurement is performed. The mean value is put on the number which is set on "Factor Replace" in calculation formula.

[Suction Speed]

Set the speed of filling the built-in burette with reagent or when reset. Slow down the speed for titration liquid like alcoholic solution that can easily generate air bubbles.

- Fast : Burette operates at its maximum speed. Ordinary setting.
- Medium : Burette operates at its medium speed.
- Slow : Burette operates at its low speed.

12. Option

12-1. Connecting a Printer

Titration results and method parameters can be printed out with a printer. A dot matrix printer or a thermal printer can be connected to the AT-710.

<DP-600>

Connect the DP-600 to the USB port.

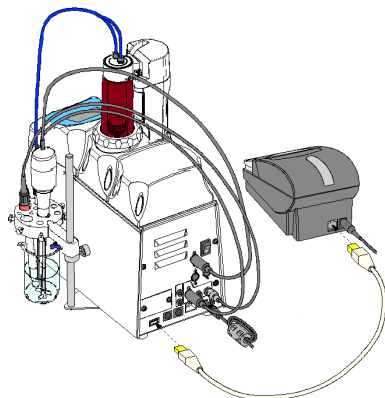

<IDP-100>

Connect the IDP-100 to COM1.

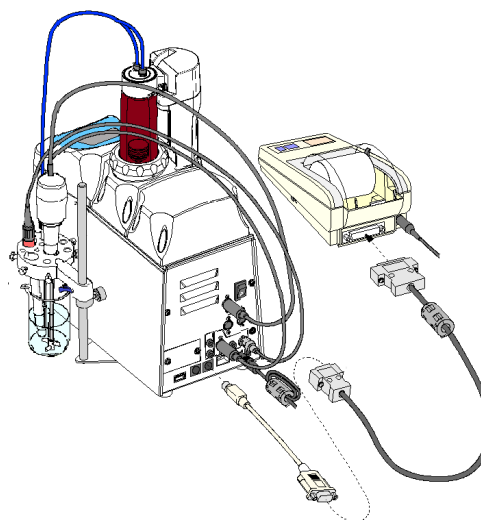

Note

See "11-2. Setting Up Interface" of this manual for how to set.

How to print

Printing out measurement results

Set the report format on "Method" to "Short" or "GLP."

When measurement is done, results will automatically be printed out.

Printing out parameters

Move the cursor to [Print] on wherever [Print] is shown. Press [ENTER] to start printing.



12-2. Balance setting

Connecting a balance enables the sample size (weight) to automatically be input. A correct setting of the balance is required for automatic input.



Note

Make sure to contact your local dealer to see if any particular connecting cable may be required.

Setting up balance

- 1) Press [MENU/HOME]
- 2) Select "11.Setup" and press [ENTER].
Select "2.Interface" and press [ENTER].

```
8.Sample
9.Blank List
10.Factor List
11.Setup
    [Exit]
```

- 3) Select "3.Balance" and press [ENTER].

```
[Interface]
1.RS-232C
2.Printer
3.Balance
4.USB
5.Other
    [Exit]
    [Print]
```

- 4) Select the manufacturer of the balance, and press [ENTER].

```
[Balance]
Balance
  < NONE >
    [Exit]
```

Balance maker

- 5) Select the COM port to which you wish to connect the balance, and press [ENTER].

```
[Balance]
Balance
  < COM2 >
```

Balance maker

- 6) Select the COM port to which you wish to connect the balance, and press [ENTER].

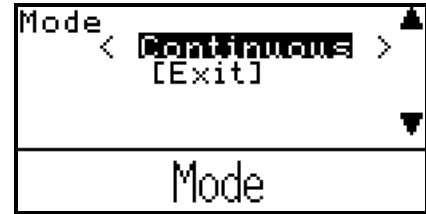

<Inputting sample size>

- 1) Select [Sample] on main screen. "Sample" screen will appear.



- 2) Move the cursor to "Size" and press [Enter].
 3) Tare the balance and then place the sample. Once the balance becomes stable, press [Enter] to fix the sample size. (When "Continuous" is selected on output mode of the balance.)

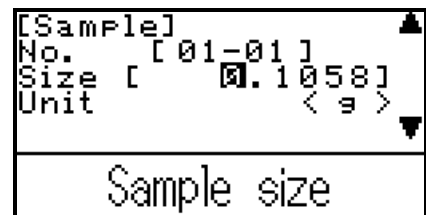

After tarring the balance, place the sample and then press the "Print" key of the balance. The sample size will be entered in "Size" of the current sample setting. (When "Print" is selected on output mode of the balance.)

12. Option

<Input at time of burette check>

- 1) Press [MENU/HOME].
- 2) Select "3. Manual Operation" and press [ENTER].
Then select [Validation] and press [ENTER].

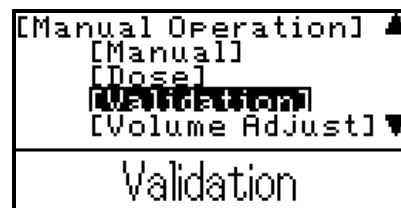

- 3) Place a 100mL container, such as a volumetric flask, on the balance and tare the balance. The weight reading will be 0.0000g.
- 4) Insert the nozzle in the container mentioned in above 3).
- 5) Move the cursor to [Execute] and press [ENTER] to conduct a burette capacity check. Burette will start to operate and dispense pure water into the container.

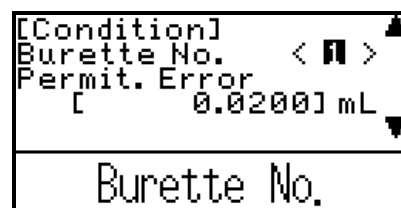

- 6) "Weight Input" screen will then appear. Place on the balance the container with pure water dispensed by burette.
Once the reading becomes stable, move the cursor to [Execute] and press [ENTER]. (When "Continuous" is selected on output mode of the balance.)
Once the reading becomes stable, press the "Print" key of the balance. (When "Print" is selected on output mode of the balance.)
The weight dispensed is entered at this point.

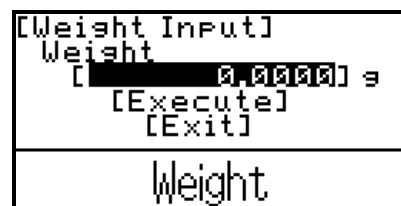

12-3. Connecting Multiple Sample Changer

Connecting the multiple sample changer enables you to perform consecutive titrations of a single sample or titrations of different samples repeatedly. Automatic rinsing of electrodes and draining of solutions in the beakers can also be achieved after titration by the multiple sample changer.

Note

See Operation Manual of the Multiple Sample Changer for how to connect and how to operate.

Setting up multiple sample changer

- 1) Connect the multiple sample changer.
- 2) Press [MENU/HOME]. Select "6. Changer" and press [ENTER].

```
[MENU]
1.Manual Operation
2.Data File
3.Method
4.Calibration
5.Data Copy
6.Changer
7.History
```

- 3) Set "Mode" to "On."
- 4) Set sequence time.

```
[Changer]
Mode < Off >
[Exit]
[Print]

Changer Mode
```

12-4. Connecting USB Devices

The AT-710 can be connected with various USB devices such as printers, keyboards and foot switches.

Connecting USB devices

Connect the devices you wish to use to the USB port at the back of the AT-710.
See below for details of USB devices which can be connected.

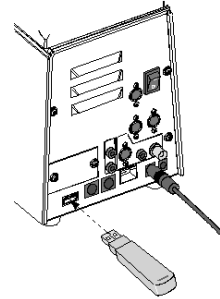

Connected device	Contents																
USB Flash Drive	Measurement results or methods can be transferred to a USB flash drive, which enables you to use the data on your PC.																
USB Keyboard (USB Numeric Keypad)	Parameters of methods can be entered with a keyboard. A 101-key PC keyboard can be used. <p style="text-align: center;">Table of Keys</p> <table border="1" style="margin-left: auto; margin-right: auto;"> <thead> <tr> <th>Key on AT-710</th> <th>Keyboard</th> </tr> </thead> <tbody> <tr> <td>START/STOP</td> <td>F5</td> </tr> <tr> <td>MENU/HOME</td> <td>Esc</td> </tr> <tr> <td>∧</td> <td>↑</td> </tr> <tr> <td>∨</td> <td>↓</td> </tr> <tr> <td><SAMPLE</td> <td>←</td> </tr> <tr> <td>STIRRER></td> <td>→</td> </tr> <tr> <td>ENTER</td> <td>Enter</td> </tr> </tbody> </table>	Key on AT-710	Keyboard	START/STOP	F5	MENU/HOME	Esc	∧	↑	∨	↓	<SAMPLE	←	STIRRER>	→	ENTER	Enter
Key on AT-710	Keyboard																
START/STOP	F5																
MENU/HOME	Esc																
∧	↑																
∨	↓																
<SAMPLE	←																
STIRRER>	→																
ENTER	Enter																
USB Printer	The Thermal Printer "DP-600" can be connected to print out parameters and measurement results.																
USB Barcode Scanner	A barcode scanner can be connected to import a sample ID. If you use a barcode scanner on main screen, a sample ID can be imported into the sample ID on current sample conditions.																
USB Foot Switch	Pressing the foot switch can start a measurement.																



Note

Make sure that the USB setup on MENU > 11. Setup > 2. Interface > 4. USB is "Host" when using USB devices.

Some USB devices may not be recognized. Do not use USB devices if performance of the AT-710 is slowed down after connecting such devices.



Several USB devices may be used at a time with a self-powered USB hub. Some USB hubs may not be recognized.

12-5. Connecting Android devices

Android devices can be connected to this instrument via USB port, and the weight can be input. A titration curve will be shown on the Android device during titration.

Android devices can be connected to the AT-710 via USB port, and the weight can be input with a special app.

System requirements

- **Android Ver. 4.0 or later**
- **USB port required**

* Internet access is required at the time of software installation.



Caution!

KEM warranty does not cover malfunction or breakdown of Android devices regardless of the cause. Operation check was performed per ADK (Ver.) stipulated in the Android specifications. Some Android devices, however, may not be connected.

12-5-1. Connecting to instrument

- 1) Connect an Android device and the AT-710 with a USB cable.
- 2) Some messages will appear on the display, and press "View."
- 3) When you access the download URL on the browser, a confirmation message will appear on the top. Press "OK" to start download. Description and position of the message may differ on some browsers.
- 4) When download is completed, an installer for the app will appear on the notification bar. Click the installer.

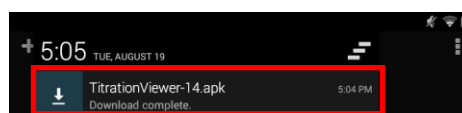
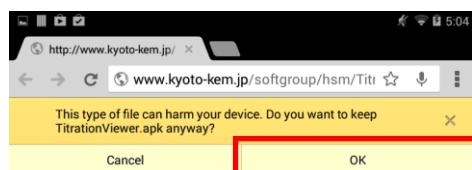
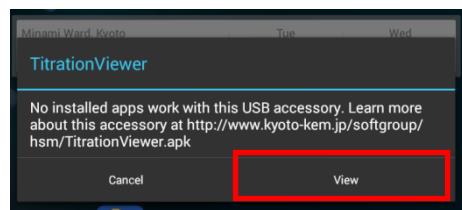

12. Option

- 5) A confirmation message for install will appear, and press "Install" to start installation of the app.
- 6) Press "OK" when installation is completed.

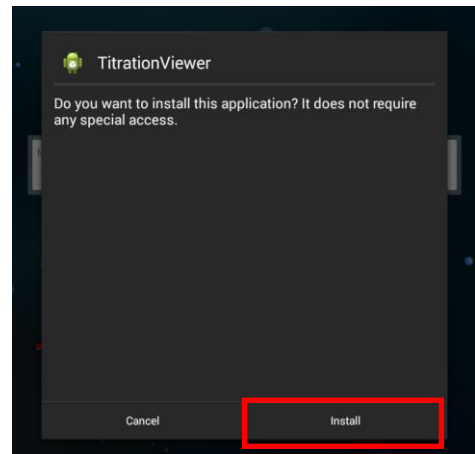

This app will not appear in the app list of the menu even after installation. (It will appear in the app management.)

12-5-2.Starting app

- 1) Connect an Android device and the AT-710 with a USB cable.
- 2) A confirmation message will appear when you start the TitrationViewer. Press "OK."
- 3) If you wish to start the TitrationViewer every time you connect the Android device to the AT-710, check "Use by default for this USB accessory."
- 4) The TitrationViewer will start.

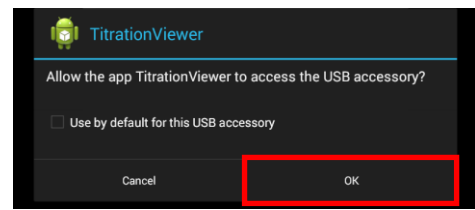

* This app cannot be started from the app list or start record (recently used apps). Always follow the steps above.

12-5-3.Starting measurement

- 1) Press "Titration start."
- 2) Titration will start. During titration, a titration curve will appear on the display.
- 3) If you press "Titration start" or "Reset," or if titration starts, display of titration results will be cleared.

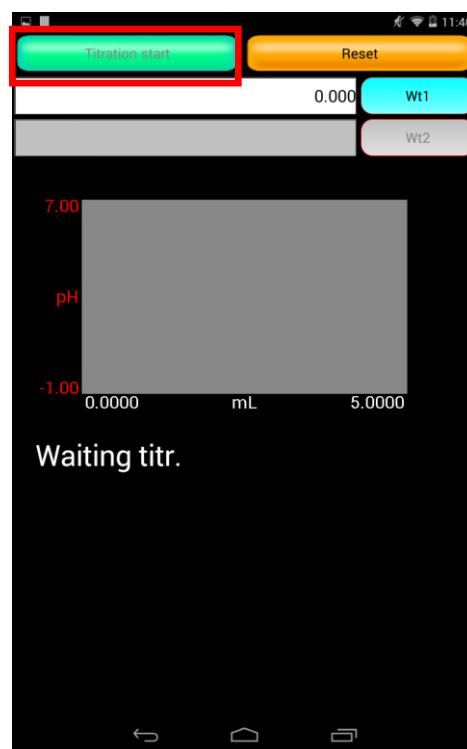

12. Option

12-5-4.Entering weight

- 1) If you touch the edit box on the top of the display, soft keys will appear. Enter the weight.
- 2) If the weight remains unsend, transmission button will turn light blue.
- 3) Once you have entered the weight, press "Wt1" button to send the weight.
- 4) Once the weight has been sent, the transmission button will turn gray.

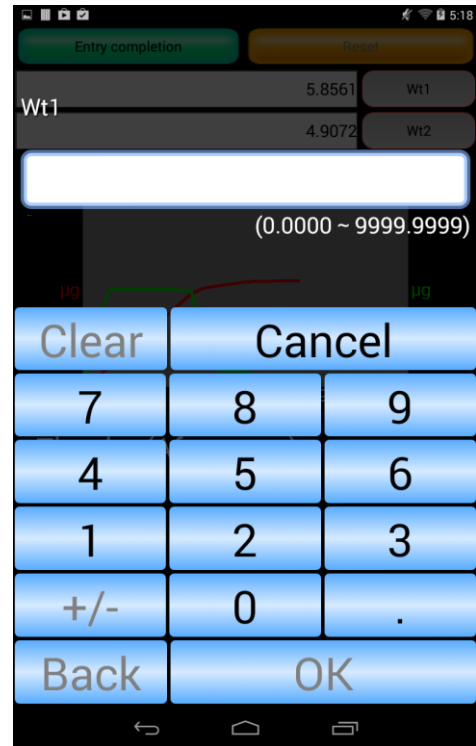

12-6. Adding a Built-in Burette

Up to two (2) burettes can be connected to the AT-710.

When your AT-710 has one (1) burette, one more burette can be added and controlled from the AT-710. Follow the steps below. See "1-1. Supplied parts" of AT-710 Operation Manual for details of the supplied parts.

- 1) Remove the rubber caps and the screws as shown below.
- 2) Remove the cover, and install the additional burette. Make sure that the address switch of the burette is No. 2 at this time.
- 3) Once you have put the burette thoroughly, fix it with the screws and then put the rubber caps.

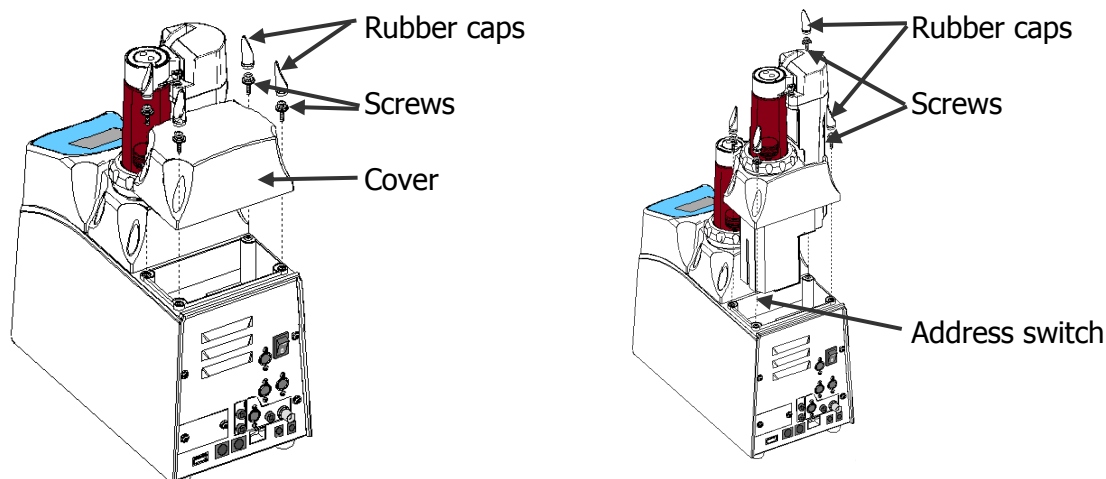

- 4) See "1-2-3. Assembly of burette unit" of AT-710 Operation Manual for how to assemble.
- 5) Turn on the equipment.
- 6) Confirm the capacity of the burette following "2-5. Setting Burette Volume" of AT-710 Operation Manual.

Caution!  **Be sure to turn off the unit before plugging in or out the cable.**

Note  The tube length connected to reagent bottle is the necessary length when the tube is connected to multiple sample changer (CHA-700). Adjust the tube length of inserted side to the reagent bottle with cutter when using only AT-710. Also adjust the cover length covered to the tube.

12-7. Connecting additional burette

This titration unit can command and activate up to 8 Auto piston burettes.

- 1) Connect each SS-BUS port on the back of measuring unit and additional burette with connection cable.
- 2) Select "APB No." switch on the back of additional burettes. For details, see the instruction manual for the Auto piston burette to be connected.
- 3) Turn on the power.

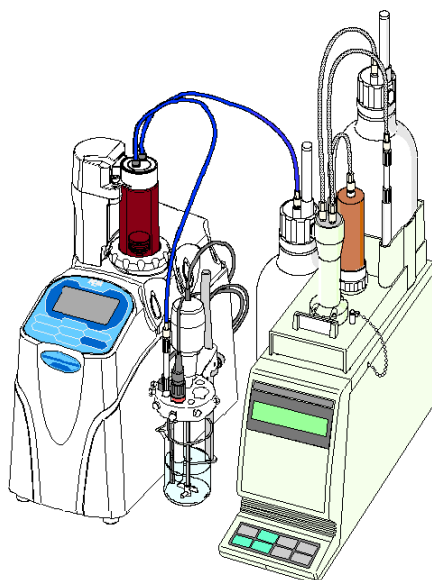
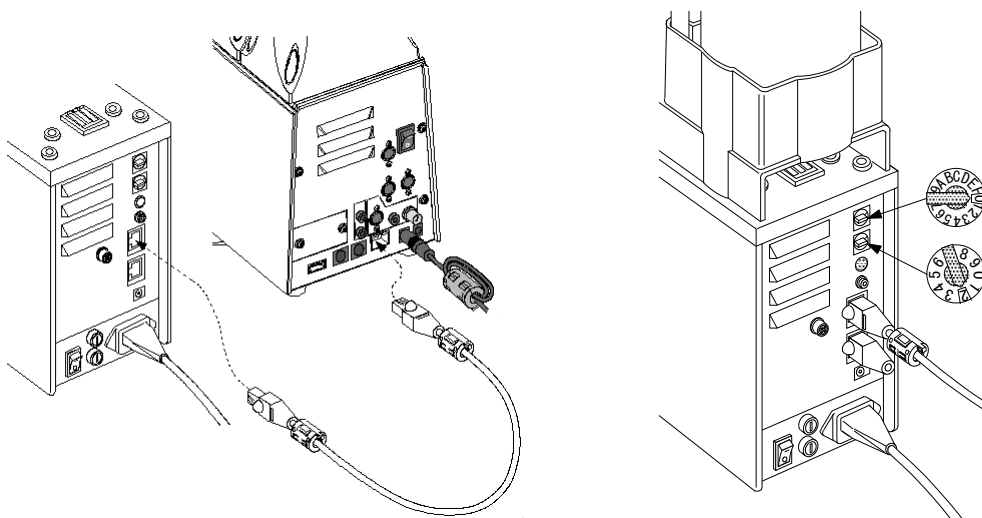

Be sure to turn off the unit before plugging in or out the cable.

12-8. Adding auto dispenser

One auto dispenser can be installed on this titrator, which is for dispensing solvents other than titrants.

The auto dispenser dispenses 50ml in ten (10) seconds with one operation, which enables you to dispense a lot of solvents in a short time.

12-8-1. Supplied parts

Part Number	Part Description	Qty	Remarks
-	Main Unit	1	
-	Switching Valve	1	
20-04052-00	Nozzle Cover	1	
-	PTFE Tubing 4×6 1m	2	
-	Silicon Rubber Cap	1	
-	Reagent Bottle Cap	1	
12-01260-01	Zeolite Tube	1	
-	Cable Cover	1	
69-00658	Screw Driver	1	
20-07468	Detaching tool	1	

12-8-2. Installation of auto dispenser

- 1) Remove the rubber caps and the screws as shown below.
- 2) Remove the cover, and install the auto dispenser. Make sure that the address switch of the burette is No. 2 at this time.
- 3) Once you have put the dispenser thoroughly, fix the cover with the screws and then put the rubber caps.

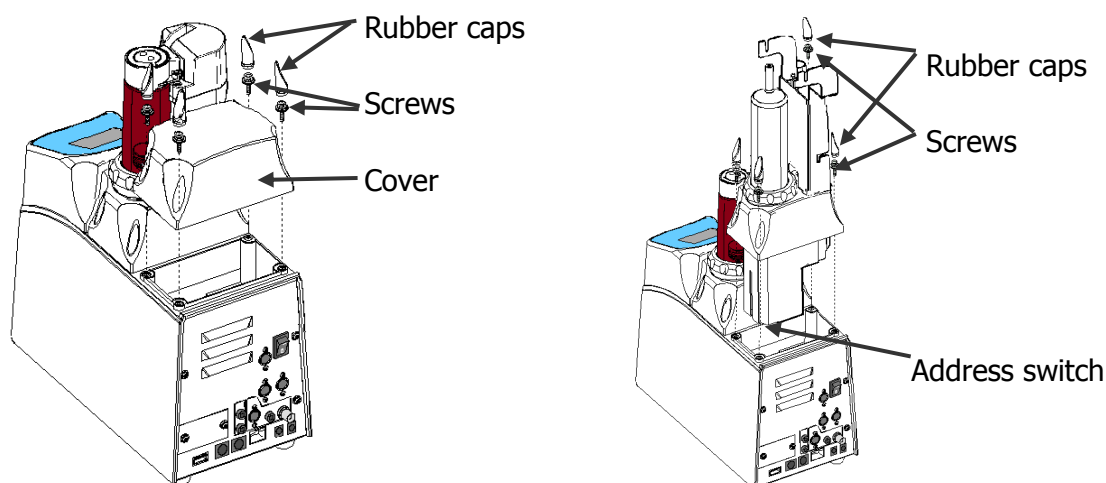

Caution!

Be sure to turn off the unit before plugging in or out the cable.

12. Option

12-8-3. Assembling burette unit

- 1) Loosen the hex cap nut on the switching valve. Match the positions of upper portion of the cylinder and two screws, and put the switching valve onto the titrator. Tighten the screws on the switching valve by hands. Afterwards, tighten more about 45 degrees with the supplied detaching tool. Tighten the cap nut on the cylinder.
- 2) Put the cable of switching valve into the titrator.
- 3) Place the cable cover on the titrator through the guide.

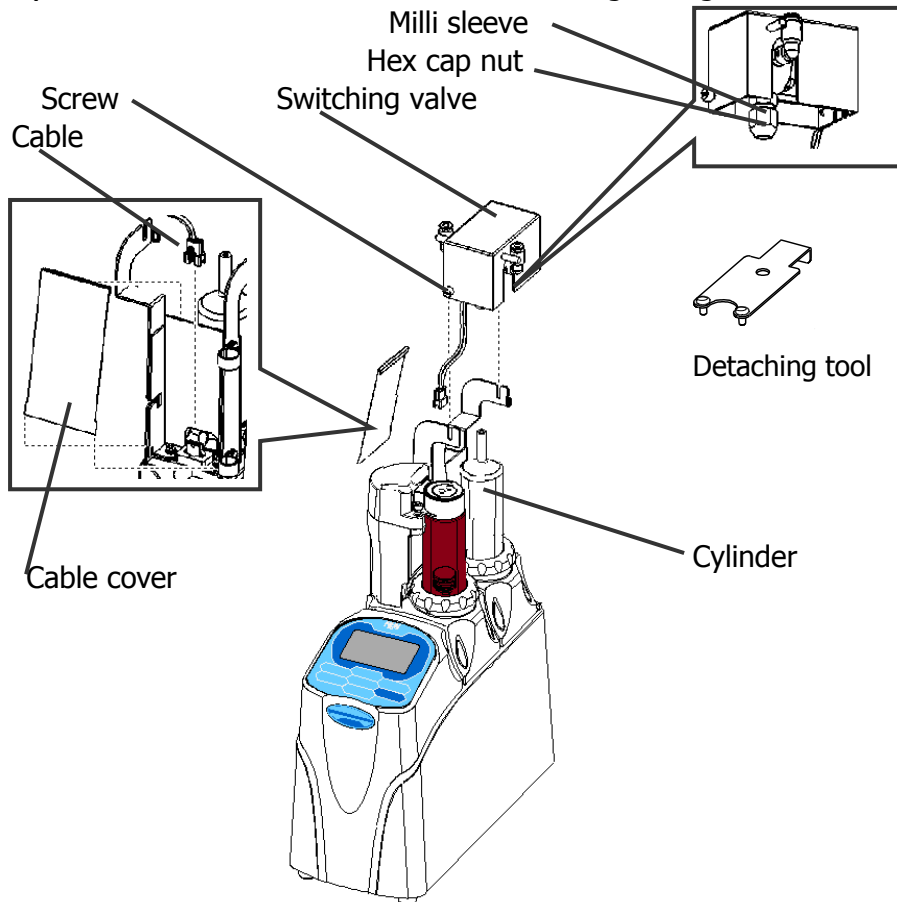

- 4) Install the nozzle cover to burette unit.
- 5) Insert the PTFE tubing into the joint on the right side of the switching valve. Put the other end to the multi electrode holder or the electrode holder on the CHA-700.
- 6) Put the PTFE tubing with the silicone rubber cap through the reagent bottle cap. Match the tube to the position that reaches the bottom of the reagent bottle. Put the other end to the joint on the left side of the switching valve.
- 7) Peel off the seal on Zeolite tube, and install it onto the reagent bottle cap.

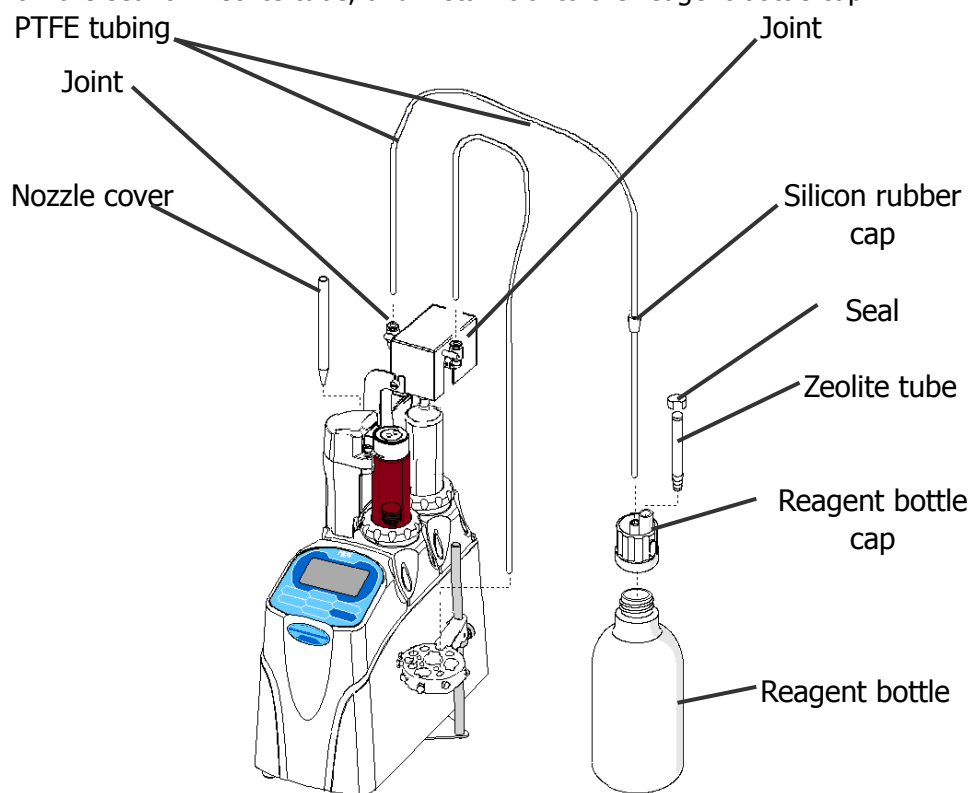
**Caution!**

Make sure to put the tubing so that the joint faces toward the upper surface of the equipment. If the tubing separates from the joint, reagents may spill and you may get them in your eye.

**Note**

Adjust the length of the PTFE tubing by cutting as necessary. Put the PTFE tubing on the uncut end into the joint. Make sure to remove the sticker on the zeolite container when in use.

- 8) Turn on the titrator.
- 9) Make sure that "Dispenser" is added from MENU > 11. Setup > 5. Serial No.

12. Option

12-8-4.Setting up operation

Auto dispenser can be used by selecting "Dispenser" from Method > PreDose Parameters > Mode.

If you wish to operate the automatic dispenser manually, select "D." on Burette No. of 1.Manual or 2.Dose from Manual Operation.

12-8-5.Maintenance

To remove the switching valve, loosen its cap nut. Then loosen its stop screws (2 pcs) with the supplied detaching tool. Lift the switching valve.

Follow "6-2-3.How to remove and assemble the burette unit" of AT-710 Operation Manual to remove the burette unit.

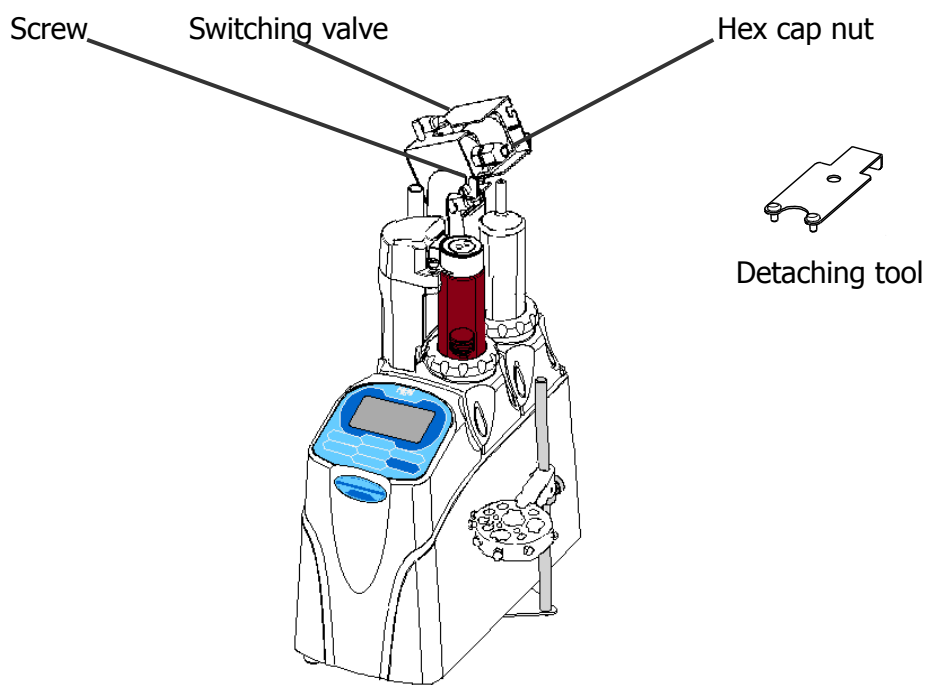

12-8-6.Specification

Part Description	Auto Dispenser
Burette capacity	50mL
Dispense speed	Approx.10seconds/50mL
Suction speed	Approx.10seconds/50mL
Burette accuracy	100mL±1mL ±2% when dispense volume is 100mL or more
Liquid contact part	Glass , fluorocarbon polymer , PP , PPS , PTFE, fluoro rubber
Dimensions(Overall imensions when installed to AT-710)	143 (W) × 309 (D) × 450 (H) mm(not incl. tubing)

12-9. PC

When the optional software SOFT-CAP in PC is installed, the measurement results to Microsoft® Excel® workbook can be export. And the data in CVS format can be stored.

12-9-1.Data acquisition software (SOFT-CAP)

The optional software SOFT-CAP is Windows®-based application and can download the measurement data to Microsoft® Excel® workbook or store in CSV format through RS232C port.

By this software, starting titration or reset can be commanded by the computer.

<Receiving data>

The SOFT-CAP software can export the measurement results as follows:

- 1) It transfers the data to Microsoft® Excel® workbook.
- 2) It stores the data in CSV format so that spreadsheet can be used.

<Sending data>

The personal computer can send commands including titration start and reset.

**Note**

For details, see the operation manual for Data Acquisition Software (SOFT-CAP).

12-9-2.RS-232C output

<Outline of RS232C>

This instrument is equipped with RS232C interface which is the standard bit serial data communication.

The RS232C interface is proved to correct communication between modem and terminal (peripheral).

This unit is set to terminal mode as a peripheral of computer. Most of the existing personal computers are equipped with RS232C interface and set to terminal mode.

However, even between the peripherals, data communication is possible by way of appropriate configuration. (some computers can switch modem from/to terminal mode)

12. Option

<Signal level>

It conforms to JIS C6361.

Logics	Signal level
1	-3 - -15[V]
0	+3 - +15[V]

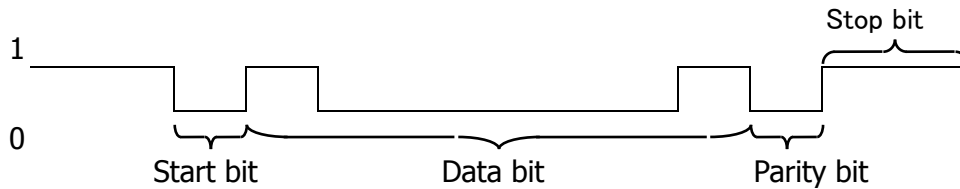

The above pattern shows the letter "A" (ASCII code 41H).

<Connector>

The connector conforms to JIS X5101 and male type 9 pins, and its configuration is as follows:

Pine number	Signal	Direction
2	RXD (Receiving Data)	IN
3	TXD (Sending Data)	OUT
4	DTR (Data terminal Ready)	OUT
5	SG (Signal Ground)	
6	DSR (Data Set Ready)	IN
7	RTS (Request To Send)	OUT
8	CTS (Clear To Send)	IN

【Caution】

The data signals for TXD and RXD are negative logic, and the control signals for RTS, DSR and DTR are positive logic.

<RS-232C data input/output>

For details of command and data format for input and output by RS232C, refer to the manual for RS232C.

