

Quad 4 — FX-1504 —



Model FX-1504 Four Channel Gas Detector Operation and Maintenance Manual

Important
Please Read Carefully and Save

The FX-1504 Gas Detector includes a manual and an instructional guide that contain important information about its operation. Purchasers who install this detector for use by others must leave this instruction manual or a copy with the user.

Every effort has been made to ensure the accuracy of this document at the time of printing. In accordance with the company's policy of continued product improvement Foxcroft reserves the right to make product changes without notice. No liability is accepted for any consequential losses, injury or damage resulting from the use of this document or from any omissions or errors herein.

Book # FX-1504-2001A

Table of Contents

Introduction	4 - 14
Mechanical Installation	15 - 19
Typical Installation	20
Electrical	21 - 39
Internal Wiring	40 - 43
Control Panel	44 - 47
System Startup	48
Sensor Test System	49
Calibration	50
Calibration Gas	51
Parts Listing	52
Monthly Sensor Test Log	53
Weekly Electronic Test Log	54 - 55

Warning

**All functions of this
Gas Detection
System must be
verified on a regular
basis.**

Important

Please read carefully and save.

This Gas Detector includes a manual that contains important information about its operation. Purchasers who install this detector for use by others must leave this manual or a copy of it with the user.

Introduction

General Description:

The FX-1504 Quad is an electronic system designed to rapidly detect and warn of hazardous toxic gas concentrations or low oxygen levels. The system consists of four toxic gas or oxygen sensors and a remote alarm unit that can be located up to 2000 feet away from the hazard area.

Specifications:

Sensor Inputs:	Four sensors (same type of sensors or two different types) 3 electrode, electrochemical fuel cell
Sensor Signal Types:	4-20 mA, 200 ohms
Warranty:	2 years (<i>electronics only</i>) Sensor Warranty; varies depending on gas type, see individual toxic gas specifications sheets, 10 years potential life.
Range and Alarm Trip Points:	See page 10 for specific gas trip levels and ranges.
Response Time:	Less than 8 seconds to full alarm
Accuracy: (ppm @ 20° C)	0.1 percent (<i>channel 1, 2, 3, and 4</i>)
Resolution:	0.1 (<i>channel 1, 2, 3, and 4</i>)
Repeatability:	1 (<i>channel 1, 2, 3, and 4</i>)
Operating Temperature Range:	-15° to +40° C (+5° to +104° F) (<i>channel 1, 2, 3, and 4</i>)
Operating Humidity:	15 to 90% (non - condensing) (<i>channel 1, 2, 3, and 4</i>)

Introduction

Drift:	Less than 2% per month (<i>channel 1, 2, 3, and 4</i>)
Operating Pressure:	900 to 1100 mBar (<i>channel 1, 2, 3, and 4</i>)
Digital Display Type:	Standard , Red LED 3 digits, .56" high (each channel displays independently direct ppm or percent of oxygen)
Output Signal:	4-20mA, 600 VDC (optional)
Auxiliary Relay Contacts:	Channel 1 (Danger) - 1 SPDT 10A @ 125VAC, latching Auxiliary Relay 1 (<i>channel 1</i>) 1 SPST, 10A @ 125VAC, selectable Channel 2 (Danger) - 1 SPDT 10A @ 125VAC, latching Auxiliary Relay 2 (<i>channel 2</i>) 1 SPST, 10A @ 125VAC, selectable Channel 3 (Danger) - SPDT 10A @ 125VAC, latching Auxiliary Relay 3 (<i>channel 3</i>) 1 SPST, 10A @ 125VAC, selectable Channel 4 (Danger) - 1SPDT 10A @ 125VAC, latching Auxiliary Relay 4 (<i>channel 4</i>) 1 SPST, 10A @ 125VAC, selectable

Introduction

Primary Sensitivity:	Direct PPM
Audible Alarm:	Pulsating piezo buzzer (90dB)
Visual Alarms:	Warning - Yellow LED <i>(channel 1, 2, 3, and 4)</i>
	Danger - Red Blinking LED <i>(channel 1, 2, 3, and 4)</i>
	Fault - Green Blinking LED <i>(channel 1, 2, 3, and 4)</i>
	Local Sensor - Danger Alarm, Red Blinking LED <i>(channel 1, 2, 3, and 4)</i>
Power:	110 or 220 VAC - 50/60 Hz @ 200mA
Sensor Distance:	25 Ft. Std. (2000 Ft. max.) <i>(channel 1, 2, 3, and 4)</i>
Enclosure:	Remote Unit - NEMA 4X
	Sensor Unit - NEMA 4X <i>(channel 1, 2, 3, and 4)</i>
Mounting:	Remote Unit - Wall
	Sensor Unit - Wall <i>(channel 1, 2, 3, and 4)</i>

Introduction

Warning

If the alarm buzzer sounds a loud pulsating sound and you are not testing the gas detector, it has sensed a gas leak. The alarm buzzer is warning of a possibly serious situation and it requires your immediate attention.

Basic Information About Your FX-1504

Put an FX-1504 in every place that it is needed to protect personnel.

Place it in the proper location according to what type of gas the air is being monitored for.

Warning

All functions of this gas detector must be checked and verified on a regular basis.

Even the ability for the gas sensor to sense toxic gas or low oxygen levels must be verified on a regular basis. It is recommended that the gas sensors be tested by means of a **certified gas standard** at least once **every six months**.

Warning

If the FX-1504 is altered in any way, warranty will be voided. Example: drilling additional holes in the enclosure to mount conduits, changing operating range of the gas sensors and altering the gas alarm trip points.

Warning

Never disconnect an AC powered gas detector to stop nuisance alarms. The source of the problem must be corrected.

Introduction

Warning

If the alarm buzzer sounds a loud pulsating sound and you are not testing the FX-1504 Gas Detector, it has sensed a toxic gas leak or low oxygen level. The alarm buzzer is warning of a possible serious situation and it requires your immediate attention.

Warning

If the FX-1504 does not work properly, do not try to fix the monitor yourself. This will void your warranty. Send the remote alarm unit and the sensor with cable prepaid to :

Foxcroft Equipment and Service Co., Inc.

Service Dept.

2101 Creek Road

Glen Moore, PA 19343

Phone (610) 942-2888

FAX (610) 942-2769

www.foxcroft.com

A Return Material Authorization Number (RMA) is required before shipping any products for service.

Notes

Introduction

Range and Alarm Trip Point Chart:

Standard Range (ppm or % for each channel)

Optional Ranges and Alarm Trip Points may be available.

Refer to the Serial Number label inside the remote unit for the type of gas its monitoring or labeling on the sensors.

GAS	Standard Range	Warning Trip Point	Danger Trip Point
Chlorine	0-10 ppm	1.0 ppm	3.0 ppm
Sulfur Dioxide	0-10 ppm	1.0 ppm	3.0 ppm
Carbon Monoxide	0-500 ppm	35 ppm	50 ppm
Hydrogen	0-200 ppm	35 ppm	50 ppm
Hydrogen Sulfide	0-10 ppm	1.0 ppm	3.0 ppm
Nitric Oxide	0-50 ppm	25 ppm	35 ppm
Nitrogen Dioxide	0-10 ppm	1.0 ppm	3.0 ppm
Oxygen	0-25%	18%	16%
Ammonia**	0-50 ppm	2.0 ppm	3.0 ppm
Hydrogen Cyanide	0-10 ppm	1.0 ppm	3.0 ppm
Ozone	0-10 ppm	1.0 ppm	3.0 ppm
Hydrogen Chloride	0-10 ppm	1.0 ppm	3.0 ppm

** Consult factory for precautions.

Introduction

What this Gas Detector Can Do:

The FX-1504 Quad, Four Channel Toxic Gas Monitor is the most sensitive and reliable dual channel toxic gas monitor of its kind. The Quad accepts four 4-20 mA signals from four of the same or four different toxic gas/oxygen sensors. Each channel will alarm independently in the event of a toxic gas leak.

The Four Channel Toxic Gas Monitor is designed to give an early warning of developing toxic gas leaks or low oxygen levels. The FX-1504 Quad monitors the air that enters each sensing chamber independently. When it senses toxic gas or low oxygen levels at the danger point, it sounds its built-in alarm horn and flashes its red blinking LED. An LED digital display for each channel indicates level of oxygen in percent or PPM for toxic gases.

This detector provides 2 alarm trip levels, with each level indicating a specific concentration of toxic gas or oxygen level per channel. These levels are fixed and cannot be adjusted. A toxic gas "Fault" indicator for each channel, provides warning of possible electronic signal problems.

Introduction

General Limitations:

The FX-1504 will not work without AC power. AC powered gas detectors will not work if the power is cut off for any reason. Some examples are a power failure at the power station, an open fuse or circuit breaker, corrosion of the electrical system that destroys the wires, a failure of an electrical switching device. If there are any concerns about the limitations of AC power, a battery backup should be installed.

The Red LED Digital Displays should be clearly illuminated at all times. This indicates the AC power is turned on.

The FX-1504 Gas Detector will not sense toxic gas or oxygen if the gas which it is monitoring for does not reach the sensing chambers.

Gas Detectors may not sense toxic leaks or low oxygen levels in another room or another floor of the building. For example: An outside mounted gas detector may not sense a toxic gas leak inside a building. Therefore, place a gas detector wherever it is needed to protect your personnel.

FX-1504 Gas Detectors may not be heard or seen. The loudness of the horn in the FX-1504 Gas Detector meets (or exceeds) current standards. However, if the FX-1504 Gas Detector is placed in a closed room, it may not be seen or heard by personnel, especially if the door does not have a window to see the visual alarm. Even normal noise such as traffic, motors running, radios, and air conditioners may prevent personnel from hearing the audible alarm. **FX-1504 Gas Detectors may not be heard or seen by persons who are hard of hearing or visually impaired.** It is recommended that the remote warning device be installed to alert personnel before entering a room. Several detectors are recommended both outside the building or in any room that contain personnel, where toxic gas or low oxygen levels can develop.

Warning

All functions of this FX-1504 Gas Detector must be checked and verified on a regular basis.

Introduction

General Limitations: *Continued*

FX-1504 Gas Detectors are not fool-proof. Like all other electronic devices, the FX-1504 Gas Detectors have limitations. Detectors cannot be expected to sense a dangerous toxic gas leak or low oxygen levels if the cavity is blocked by debris or the detector is carelessly tampered with by personnel.

The FX-1504 has a limited life. This equipment contains many parts. Just like with any other device any one of these parts could fail at any time. Therefore, you must test your detector on a regular basis. Be sure to have it repaired or replaced when it fails to test properly. In no case should the detector be used for more than 10 years. All functions of this detector must be checked and verified on a regular basis. Even the ability of the sensor must be verified by means of a **certified gas standard** at least 2 times a year.

Warning

To avoid possible severe personnel injury, observe all precautions.

Life and Replacement:

Most sensors are designed for a minimum life span of 2 years and are warranted for 1 year from the date of shipment. Life expectancy can be as high as 10 years. Oxygen sensors have a life span of 2 years and warranted for a period of 1 year from the date of shipment. *To verify expiration date, see serial number data tag or the data sheet provided*

Notes

Mechanical Installation

Sensor Placement:

Important

Proper placement of the sensors is essential to the operation of the FX-1504. Locations will either result in rapid alarming of hazardous leaks or low oxygen levels or it can delay or fail to warn of a hazardous condition.

Correct installation of the sensors depends mostly on what type of gas the detector is monitoring the air for. If the gas is heavier than air, then the sensors should be placed closer to the floor and vice versa for gases which are lighter than air.

Never mount the FX-1504 Gas Detector in direct sunlight or direct light.

Do not install in very dusty or dirty areas. Dust and dirt can build up on the sensing chamber, making it overly sensitive. Or dirt can block openings to the sensing chamber and keep the gas detector from sensing toxic gas or low oxygen levels.

Do not install in areas of wash down. The gas detector should not be washed with water or mounted in areas where water is used for cleaning.

Do not install near fresh air vents, or very drafty areas. Take into account ventilations air flow patterns. If installing in an outdoor area, the sensor should generally be placed downwind of the source. More than one system may be needed to efficiently protect some outdoor locations.

Warning

The detector cannot efficiently monitor the air if the sensing chamber is blocked in any way.

Mechanical Installation

Sensor Placement: *Continued*

Do not install in insect-infested areas. If insects enter a sensing chamber, they may cause a nuisance alarm. Also they can block the sensing chamber and prevent toxic gas or oxygen from entering the chamber.

Outdoor areas may require more than one FX-1504 Gas Detector for protection.

Warning

Do not install near fresh air vents, or in very drafty areas.

Mechanical Installation

Physical Installation:

Installation of the FX-1504 Gas Detector consists of physically mounting the remote alarm unit and sensors, wiring in AC power, sensor connections, and output alarm contacts.

Remote Alarm Unit

Mounting the remote alarm unit to the wall simply requires 4 screws. Open the door to the remote alarm unit and insert screws through the 4 corner holes to secure to the wall. Be sure the remote alarm unit is mounted in a location so it can be seen clearly by all personnel. **It is recommended that the remote alarm unit be mounted outside the hazard area.**

Optional mounting ears are available.

Sensor Location and Mounting

Proper location of the toxic gas sensors is essential to the operation of the gas detector. Location will either result in rapid alarming of hazardous toxic gas or low oxygen levels or it can delay or fail to warn of a hazardous condition.

Physical installation of the toxic gas sensors simply require the mounting of the sensors to a wall.

Warning

Correct installation of the sensors depends mostly on what type of gas the detector is monitoring the air for. If the gas is heavier than air, then the sensors should be placed closer to the floor and vice versa for gases which are lighter than air.

Mechanical Installation

Layout:



Important

It is recommended that the remote alarm unit be mounted outside the hazard area.

Mechanical Installation

Layout:



Important

Always mount the sensor chamber and enclosure with directional arrows pointing down.

Warning

Correct installation of the sensors depends mostly on what type of gas the detector is monitoring the air for. If the gas is heavier than air, then the sensors should be placed closer to the floor and vice versa for gases which are lighter than air.

Typical Installation

Physical Installation:

This drawing indicates recommended locations for minimum security and a higher degree of security.

Gas detectors will not sense a toxic gas leak or oxygen if the gas does not reach the sensing chamber.

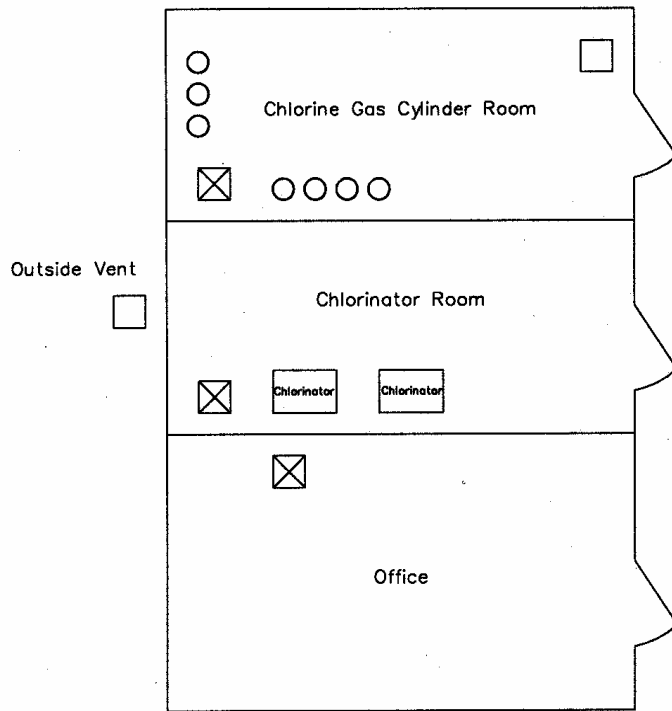

 FX-1504 Gas Detectors for minimum security.

 FX-1504 Gas Detectors for more security

Electrical

Wiring:

The FX-1504 should be wired to its own AC power source which is uninterrupted. **A battery backup is recommended where AC power may be interrupted.**

FX-1504 Gas Detectors will not work without AC power.

Use 14 gauge stranded wire only (maximum).

All electrical connections are made to a terminal strip located on the power supply card. The power supply card is located in the remote unit. To gain access to the terminal strip open the door and remove the yellow control panel by unscrewing 4 thumb screws. Next remove the 4 short standoff's, then remove the upper amplifier card. **Be careful not to pull the amplifier card out of the enclosure too far.** The cards are attached together by a ribbon cable. Set the amplifier card on top of the enclosure. The ribbon cable may also be disconnected from the amplifier card. **Be careful not to bend the pins on the connector.** Three conduit holes are provided. The power supply is wired to the conduit hole, back center. The unit is equipped to operate on 115VAC or 220VAC, 50/60 Hz. The other conduit holes are provided for relay outputs. The danger relays are non-configurable. Relay 1, relay 2, relay 3, and relay 4 are configurable. Factory set of these relays are Relay 1 (Warning Trip Alarm), Relay 2 (Warning Trip Alarm), Relay 3 (Warning Trip Alarm), and Relay 4 (Warning Trip Alarm). *Refer to Configuration Chart.*

The sensor wires come attached to the sensor input terminals. The sensor wires may be disconnected from the sensor input terminals only. **Do not disconnect the sensor wires from the Sensor Unit enclosure.** The sensor cable may be shortened or installed in a conduit. It is recommended the sensor cable be installed in a metal conduit where RF noise is present. The metal conduit must be secured to an earth ground. Do not splice the sensor cable. A continuous length of cable must be installed. **Do not earth ground the sensor unless instructed by factory.**

Use only 4 conductor, 22 gauge stranded wire only for sensor connections

Electrical

Wiring: *Continued*

Channel 1 and 2

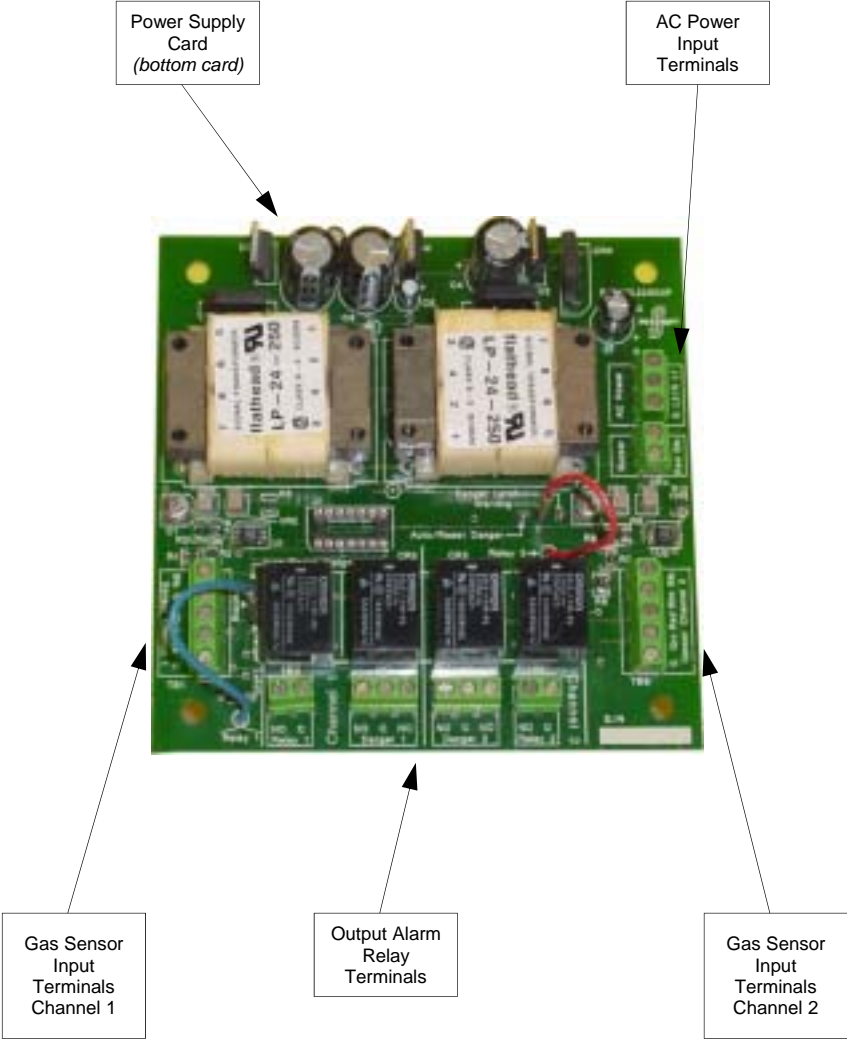

Electrical

Wiring: *Continued*

Channel 3 and 4

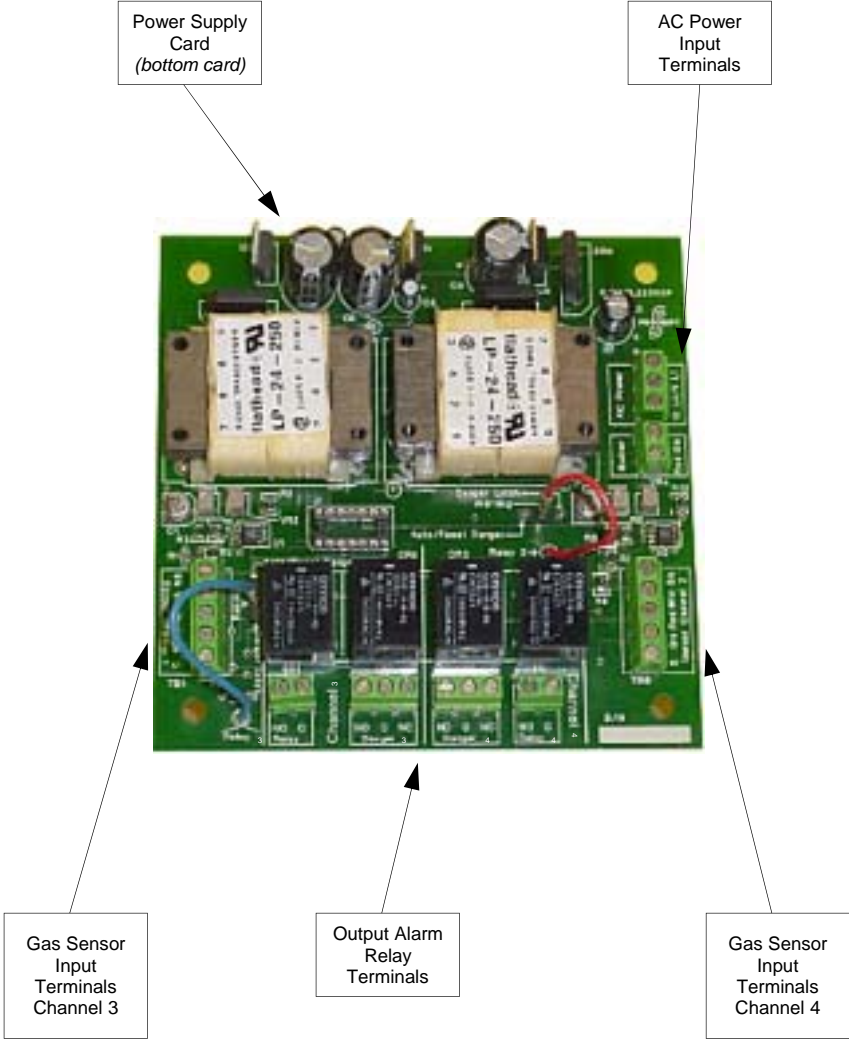

Electrical

Wiring: *Continued*

AC Power Connections

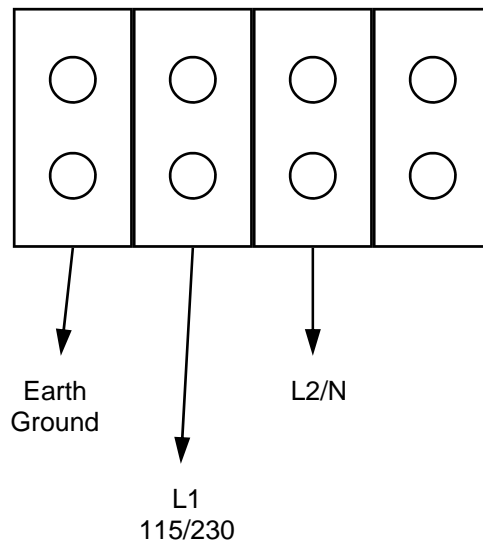

AC Power input terminal is shown above. Maximum 14 gauge stranded wire only. Do not use solid wire. Always connect to an earth ground.

Electrical

Wiring: *Continued*

Relay wiring schematic for channel 1, channel 2, channel 3, and channel 4.

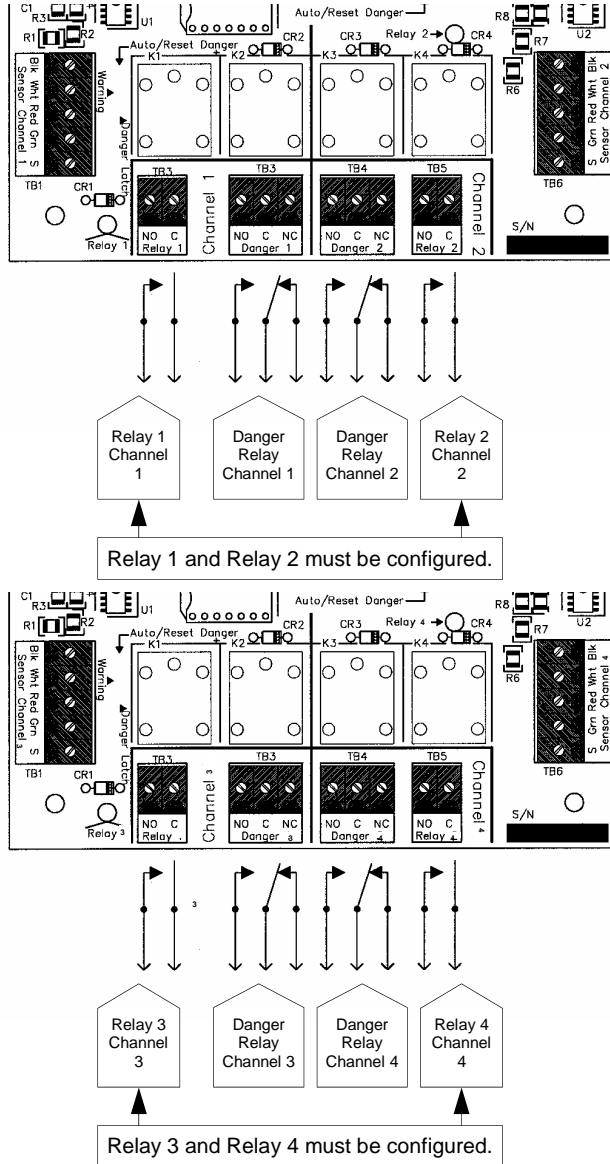

Electrical

Wiring: *Continued*

Finally, replace the amplifier card and standoffs and secure the control panel. **If the ribbon cable was removed, be very careful when reconnecting, be sure pins are lined up properly and polarity is observed**

Alarm relay terminals shown below. Located on bottom circuit board, power supply card.

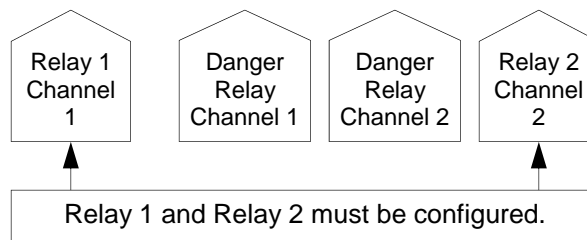

Electrical

Wiring: *Continued*

Alarm relay terminals shown below. Located on bottom circuit board, power supply card.

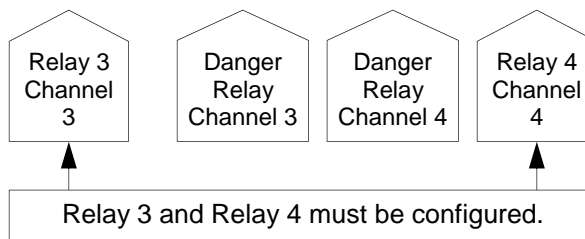

Electrical

Wiring: *Continued*

Danger Alarm Relays

One (1) latching relay is provided for the Danger Trip Point for each channel. This relay has a maximum rating of 10A @ 125 VAC. They are non-configurable and must be manually reset either by pressing the reset button.

**Do Not Over Load Relays
10 amp MAXIMUM, @ 125 VAC**

Circuit Board Damage will occur if relays are over loaded.

Auxiliary Relays

Four (4) auxiliary relays are provided, Relay 1 for channel 1, Relay 2 for channel 2, Relay 3 for channel 3, and Relay 4 for channel 4. They are normally open (NO) with a maximum rating of 10A @ 125 VAC. DO NOT OVER LOAD RELAY. Each relay is user configurable to one of any three combinations. To configure the relays simply move the blue relay 1, red relay 2, blue relay 3, and red relay 4 jumpers to the selection required. The selections are as follows:

Selections

1. Danger - 1 point provided per channel (*latching relay, this option allows one additional latching relay per channel or 2 total danger relays per channel. The alarm trip point for these relays are factory set. To unlatch these relays, they must be manually reset by locally pressing the reset button.*)

2. Danger Auto / Reset - 1 point provided per channel (*non-latching relay, this option allows the relay to trip at the danger alarm point for each channel. When the concentration of toxic gas falls below the alarm trip point, the relay will automatically reset.*)

3. Warning - 1 point provided for each channel (*non latching relay, this option allows the relay to trip at the warning point for each channel. When the concentration of toxic gas falls below the alarm trip point, the relay will automatically reset.*)

Electrical

Wiring: *Continued*

Please refer to page 10 for alarm trip points and gas ranges

Auxiliary Relay Configuration Chart

Before configuring the relays, the FX-1504 Gas Detector AC power supply **MUST** be turned off. Channel 1 and 3 relay configuration is located on the power supply card just to the left of the relays themselves. Channel 2 and 4 relay configuration is located on the power supply card to the right and above the relays themselves. To configure simply move the blue jumper wires for channel 1 and 3 and or the red jumper wires for channel 2 and 4 to any of the three selections. Be sure the plug is secured properly and the selection is what is required. After configuration is complete, the AC power may be turned back on.

Electrical

Wiring: *Continued*

Channel 1 and 2

Factory Configuration:

Relay 1 Channel 1 (blue jumper) - Warning Alarm

Relay 2 Channel 2 (red jumper) - Warning Alarm

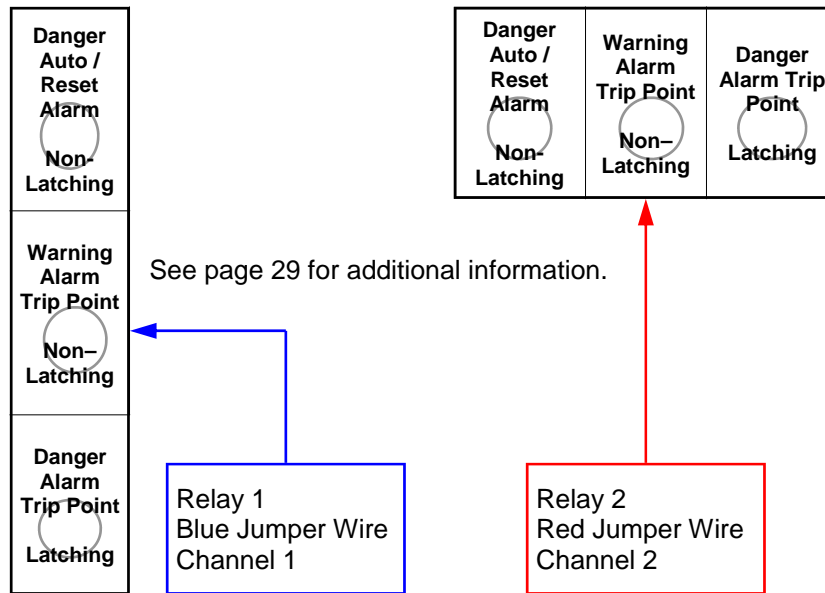

Electrical

Wiring: *Continued*

Channel 3 and 4

Factory Configuration:

Relay 3 Channel 3 (blue jumper) - Warning Alarm

Relay 4 Channel 4 (red jumper) - Warning Alarm

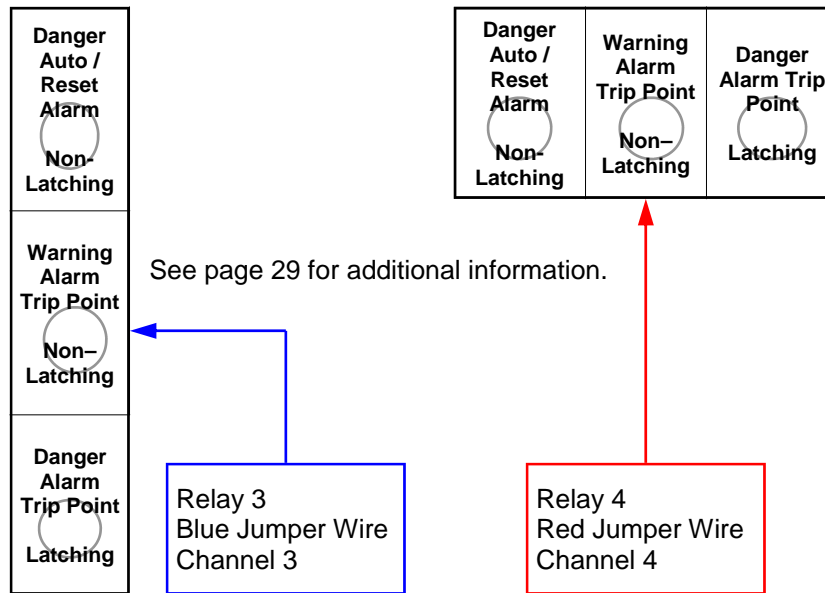

Electrical

Wiring: *Continued*

Below is shown the auxiliary configuration area for relay 1 and relay 2. Relay 1 blue jumper for channel 1 and Relay 2 red jumper for channel 2. 2. Select one configuration for each relay.



Channel 1



Channel 2

Factory relay configuration shown above.

Electrical

Wiring: *Continued*

Below is shown the auxiliary configuration area for relay 3 and relay 4. Relay 3 blue jumper for channel 3 and Relay 4 red jumper for channel 4. Select one configuration for each relay.



Channel 3



Channel 4

Factory relay configuration shown above.

Electrical

Wiring: *Continued*

Warning

**DO NOT OVER LOAD RELAYS
10 amp MAXIMUM, @ 125 VAC**

Circuit Board Damage Will Occur If Relays Are Over Loaded.

Important

The Danger Alarm Relays associated with the “Danger Alarm” LED is normally a latching relay. When the alarm is energized, the relay will hold in until it is manually reset using the “Reset” button on the front panel. However, relay 1, relay 2, relay 3, and relay 4 can be configured to a non-latching relay by selecting the auto/reset option.

Alarm trip points are factory set and calibrated. Warranty is automatically voided if any alarm trip points are adjusted.

Warning

Never create a toxic gas leak to test and verify the function of a Gas Detector. A certified method of testing is recommended.

Warning

All functions of this FX-1504 Gas Detector must be checked and verified on a regular basis.

Notes

Electrical

Wiring: *Continued*

4-20mA Retransmitter Card (optional)

4-20mA Output
12VDC Maximum
Channel 1

4-20mA Output
12VDC Maximum
Channel 2

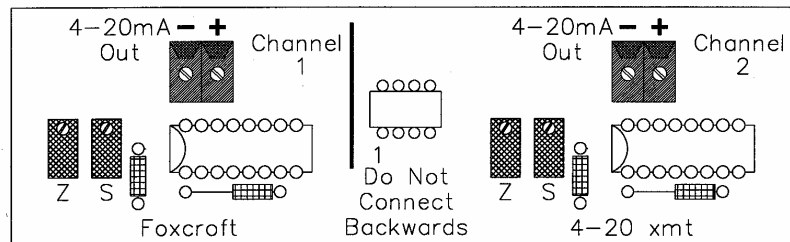

Important

Be careful not to connect the ribbon cable backwards. Follow all polarity markings on cable and printed circuit board. **Damage will occur if ribbon cable is connected backwards.**

Warning

Do not connect any external device to the 4-20mA sensor signal loop. Connecting an external device will prevent the monitor from alarming properly.

Electrical

Wiring: *Continued*

4-20mA Retransmitter Card (optional)

4-20mA Output
12VDC Maximum
Channel 3

4-20mA Output
12VDC Maximum
Channel 4

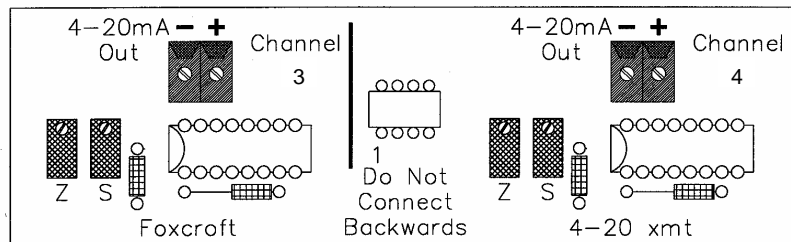

Important

Be careful not to connect the ribbon cable backwards. Follow all polarity markings on cable and printed circuit board. **Damage will occur if ribbon cable is connected backwards.**

Warning

Do not connect any external device to the 4-20mA sensor signal loop. Connecting an external device will prevent the monitor from alarming properly.

Electrical

Wiring: *Continued*

Battery Backup System

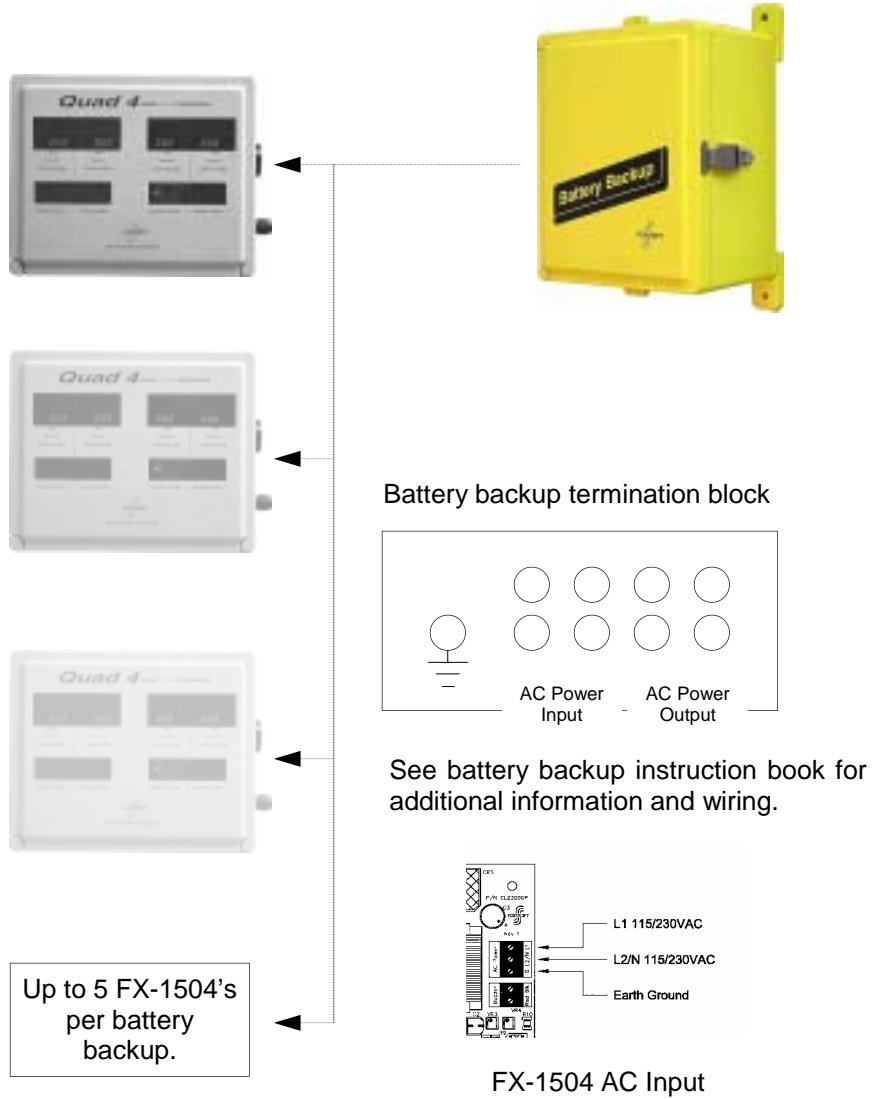

Electrical

Wiring: *Continued*

Refer to drawing below if the cable needs to be shortened or lengthened. **Do not cut sensor end of the cable.** Only use Beldon Cable number 2094 if sensor cable requires lengthening. It is recommended that the proper length of cable be factory installed prior to installation.

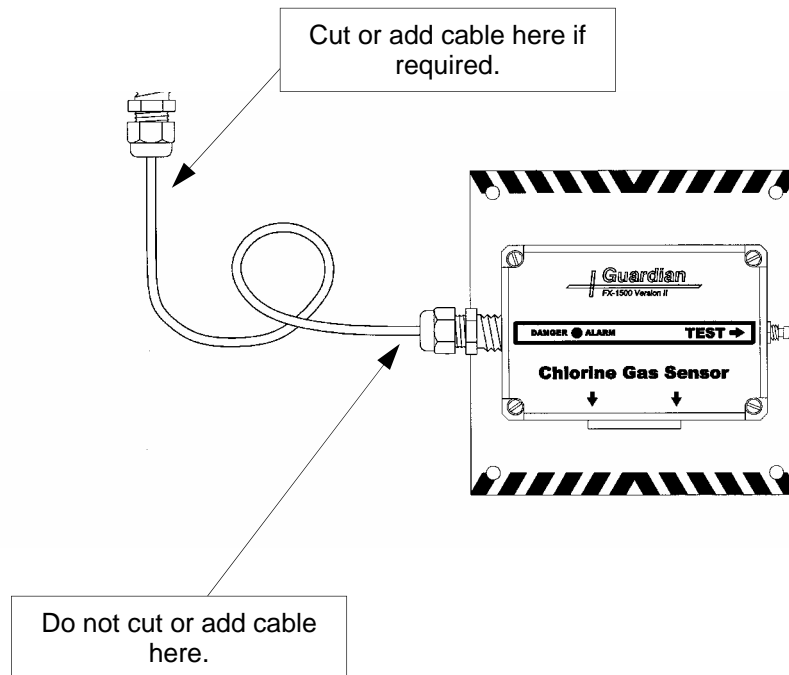

Internal Wiring

Sensor Input Wiring:

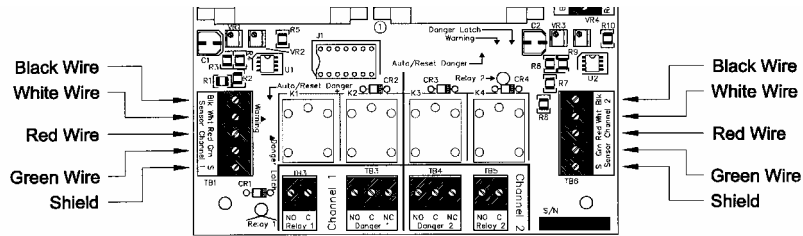

Channel 1

Channel 2

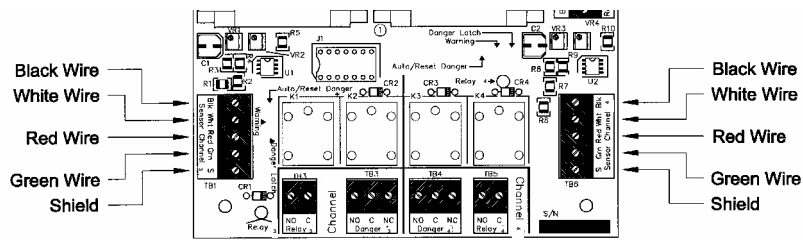

Channel 3

Channel 4

Warning

Do not connect any external device to the 4-20mA sensor signal loop. Connecting an external device will prevent the monitor from alarming properly.

Internal Wiring

Audible Alarm:

Audible Alarm (Buzzer)

*Never connect a audible alarm to the piezo buzzer output terminal.
This connection is only for the factory piezo buzzer provided.*

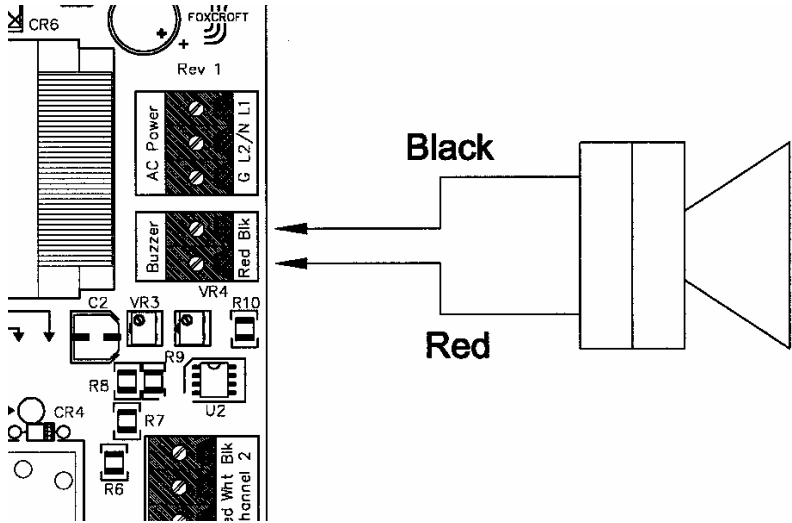

Notes

Notes

Control Panel

Remote Alarm Unit

Control Panel Layout

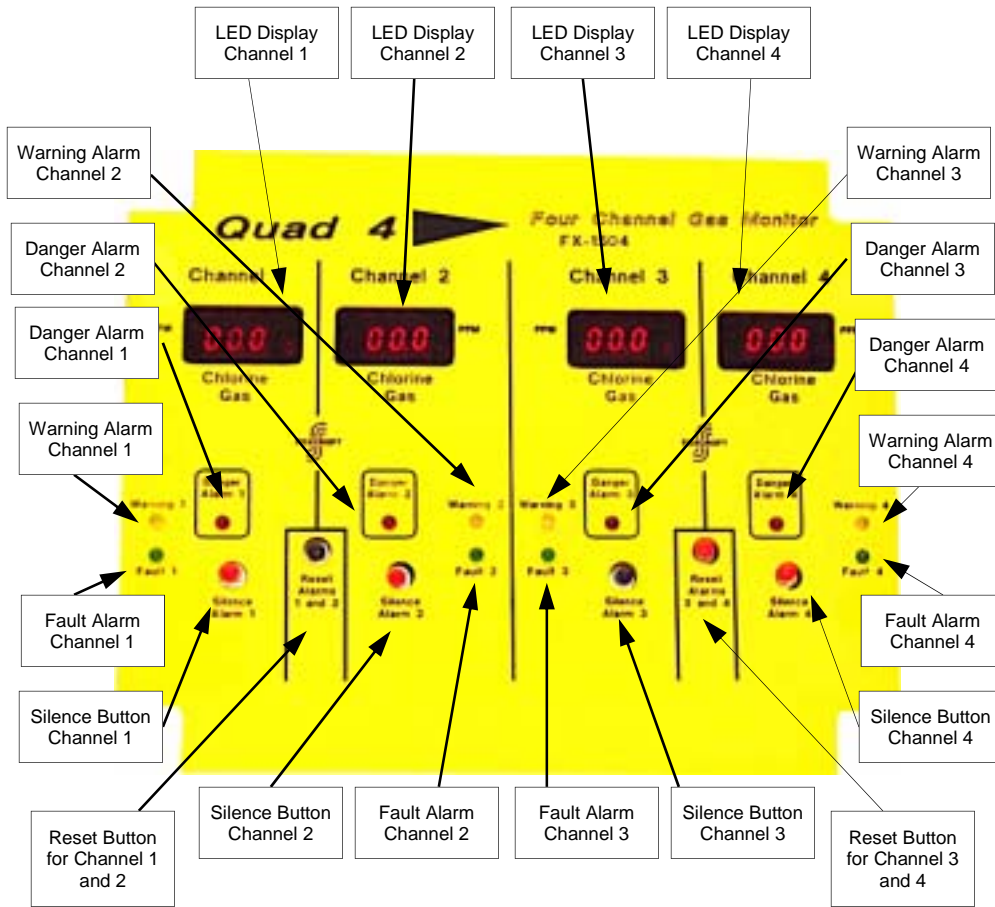

Refer to pages 44 and 45 for descriptions.

Control Panel

Sensor Enclosure

Layout for each channel



Refer to pages 44 and 45 for descriptions.

Control Panel

Descriptions:

Remote Alarm Unit

Digital Readouts Direct PPM

Red LED

Displays concentration of toxic gas in parts per million (ppm) or % of oxygen. Standard, 3 digits, .56" high.

Caution Alarms

Yellow LED

Please refer to page 10 for caution alarm trip point.

Warning Alarms

Yellow LED

Please refer to page 10 for warning alarm trip point

Danger Alarms

Red Blinking LED

Please refer to page 10 for danger alarm trip point.

Fault Alarms

Green Blinking LED

Indicates a possible problem with the sensor signal. **The fault indicating LED is not foolproof. Like all other electronic devices, it contains many parts. Any of these parts could fail at any time. Therefore, you must test your detector on a regular basis.**

Silence Buttons

Silences piezo buzzer

Piezo Buzzer

Audible alarm which sounds at 90 db. when toxic gas concentration reaches danger trip level.

Reset Button

Manually resets the danger alarms.

Control Panel

Descriptions: *continued*

Sensor Enclosures

Toxic Gas Sensor Chamber

Remote Danger Alarm

Red Blinking LED

Provides local sensor danger trip point indication. Indicating light only, no audible alarm provided with sensor enclosure.

Electronic Test Button

Tests all electronic functions. Does not check the ability of the sensor to sense toxic gas or oxygen levels.

Warning

Even the ability of the gas sensors to sense toxic gas or low oxygen levels must be verified on a regular basis. It is recommended that the gas sensors be tested by means of a certified gas standard at least once every six months.

Warning

All functions of this FX-1504 Gas Detector must be checked and verified on a regular basis.

System Startup

Preparation:

Remove the protective plug noses from each sensor cavities. The plugs are clearly marked with stickers. **“Remove protective plug before operating”**. Store protective noses in a safe place. They will be required for verification and calibration of the sensors.

Operations:

1. Apply AC power to the FX-1504 Guardian Gas Detector
2. Each Red LED Digital Display will illuminate and may start out with a negative number. The digital displays within 5 minutes should settle down and indicate 00.0 ppm.
3. The “fault” LED indicators will blink when you first apply AC power. They will go out in approximately 5 minutes.
4. The Danger Alarms may alarm during startup, press the reset buttons to reset alarms.
5. Wait 5 minutes for the monitor to warm up.
6. Press the “Test” button located on the sensor enclosures and hold 10 seconds.
7. All alarms should illuminate and the piezo buzzer should sound.
8. Silence the piezo buzzer by pressing the “Silence” buttons.
9. After 2 minutes press the “Reset” button.
10. Never operate the detector if any or all the alarm trip points fail to illuminate the LED’s or sound piezo buzzer.
11. System is now ready for operation.

Sensor Test System

Sensor Test System:

While the electronic "TEST" will only test all electronic functions, it is important that the sensors be tested periodically to ensure their gas sensitivity. A certified method is recommended.

Important

The electronic test should be conducted weekly while the sensor test should be done every six months.

Important

It is very important to maintain Weekly and Monthly Test Logs. Regular testing ensures the proper operation and life of the detector.

Warning

ALL FUNCTIONS OF THIS DETECTOR MUST BE CHECKED AND VERIFIED ON A REGULAR BASIS.

Calibration

Calibration:

The FX-1504 Gas Detector has been factory calibrated prior to shipment. If you wish to check the calibration of the detector, a low toxic gas standard is required. The best method for this is to use a certified calibration mixture.

It is recommended that the detector be verified by the use of a low level toxic gas standard every six months.

Important

It is very important to maintain Weekly and Monthly Test Logs. Regular testing ensures the proper operation and life of the detector.

All functions of this gas detection system must be checked and verified on a regular basis.

Calibration Gas

Safety 1st



- Retails \$137.00
- Small Volume
- No Waste
- Returnable Regulator

Essential part of our

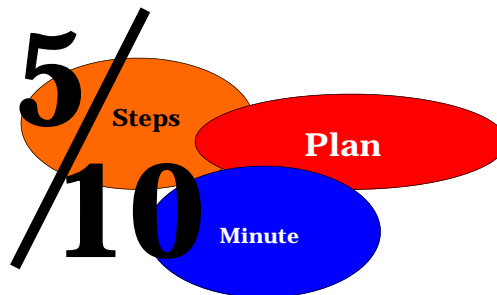

Parts Listing

Description	Part Number
Gas Sensor Only	<i>See Specific Gas Type</i>
Gas Sensor Transmitter Only	<i>See Specific Gas Type</i>
Gas Sensor with Transmitter	<i>See Specific Gas Type</i>
Amplifier Card	FX-CL22000A
Power Supply Card	FX-CL22000P
Ribbon Cable	FX-9431323-07
Control Panel	FX-M1502Y5X5
Remote Alarm Enclosure	FX-3034707-2
Sensor Enclosure	FX-532CF
Sensor Mounting Panel	FX-M1500Y6X6
Sensor Cable - (25 Feet standard)	FX-2W979-25
Additional Sensor - Specify length	FX-2W979
Sensor Cover	See specific gas type
Long Standoff	FX-MB15
Short Standoff	FX-MB75
Nylon Spacers	FX-RSN1012
Thumb Nut	FX-TN
Enclosure all-thread	FX-MS10321
Sensor Connector	FX-SC
Sensor Test Button	FX-6392315
Strain Relief	FX-2638
Knockout Plugs	FX-1451
Piezo Buzzer	FX-273066
Piezo Buzzer Mounting hardware	FX6/32x3-8
Sensor Mounting Screws	FX10/24x7-8
O-rings for sensor mounting screws	FX-007
Sensor enclosure mounting hardware	FX8/32x3-4

Monthly Sensor Test Log

Date	Initials	Date	Initials
Month of		Month of	
Month of		Month of	
Month of		Month of	
Month of		Month of	
Month of		Month of	
Month of		Month of	
Month of		Month of	

Important

It is very important to maintain Weekly and Monthly Test Logs. Regular testing ensures the proper operation and life of the detector.

Weekly Electronic Test Log

Date	Initials	Date	Initials
Week of		Week of	
Week of		Week of	
Week of		Week of	
Week of		Week of	
Week of		Week of	
Week of		Week of	
Week of		Week of	
Week of		Week of	
Week of		Week of	
Week of		Week of	
Week of		Week of	
Week of		Week of	
Week of		Week of	
Week of		Week of	
Week of		Week of	
Week of		Week of	
Week of		Week of	
Week of		Week of	
Week of		Week of	
Week of		Week of	
Week of		Week of	
Week of		Week of	
Week of		Week of	
Week of		Week of	
Week of		Week of	
Week of		Week of	
Week of		Week of	
Week of		Week of	
Week of		Week of	
Week of		Week of	
Week of		Week of	

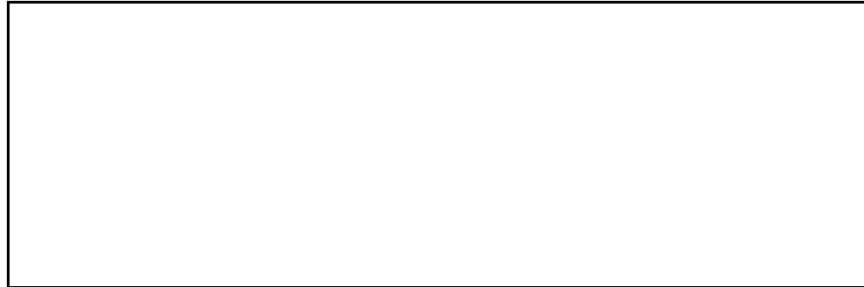

Foxcroft Equipment & Service Co., Inc.
2101 Creek Road
P.O. Box 39
Glen Moore, PA 19343
Phone: 800.874.0590
Fax: 610.942.2769
www.foxcroft.com