

Model FX-CL Amperometric Chlorine Residual Analyzer Instruction Manual



Document No. FXCL102014.1
April 2015
©2014 Foxcroft Equipment & Service Co. Inc.

Table of Contents

Section1 General Information	4
1.1 Safety Information	4
1.2 Precautionary Labels	4
1.3 System Description	5
1.4 Specifications	6
1.5 System Component Identification & Description	7
Section 2 Installation	9
2.1 Sample Point Selection Guidelines	9
2.2 Unpacking	10
2.3 Serial Number & Software Version	10
2.4 Locating the Analyzer & Dimensions	11
2.5 Wall mounting the analyzer	12
Section 3 Plumbing Installation	13
3.1 Recommended Plumbing Installation	14
Section 4 Electrical Installation	15
4.1 Electrostatic Warning	15
4.2 Power Connection	15
4.3 Circuit Board Layout and Identification	16
4.4 Factory Default Wiring	17
4.41 Bare Measuring Electrodes	17
4.42 Temperature Sensing Element	17
4.43 Pump & Mixing Motor Wiring	17
4.44 Flow Sensor Wiring	8
4.45 Display wiring	18
4.46 Power Input	18
4.5 Field Wiring	19
4.51 Current Output Wiring	19
4.52 RS485 Serial Output Wiring	19
4.53 Form C Alarm Relay Wiring TB-16	19
Section 5 Touch Screen Interface & Navigation	20
5.1 Main Screen Identification and Description	20
5.2 Menu Structure	21
5.3 Screen Navigation	22
5.4 Configuring the Operating Range & mA Output	23
5.5 Configuring the mA Output	24
5.6 Configuring the Alarm Relays	25
5.7 Calibration	27
5.71 Setting the Zero Point.	27

Table of Contents

5.72 Calibrating the Span (Standard)	28
	30
Section 6 Settings Submenu Screen	30
6.1 Buffer Pump Motor Speed Control	31
6.2 Turning the Mixer & Pump Motor Off / On	31
6.3 Setting pH Compensation Mode	31
6.4 Screen Settings	32
Section 7 Buffer Solution & Feed	33
7.1 Buffer Feed Tubing Selection	33
7.2 Routing the buffer feed tubing	33
7.3 Recommend Buffer Solution for Free Chlorine Determination	34
7.4 Vinegar Storage, Handling, Contamination	34
7.5 Recommend Buffer Solution for Total Chlorine Determination	35
7.6 Potassium Iodide Dosage	35
Section 8 Startup	36
Section 9 Maintenance	38
9.1 Maintenance Schedule	38
9.1.1 Required Tools	38
9.2 Weekly Inspection Checklist	38
9.3 Cleaning	39
9.4 Cleaning The Copper Electrode	40
9.5 Preventive Maintenance Kit Installation	42
9.6 Mixer Paddle Installation & Gap Adjustment	46
9.7 Mixing Motor Replacement	47
9.8 Temperature Sensor Replacement	49
9.9 Buffer Pump Tubing Replacement	50
9.10 Buffer Pump Head Replacement	51
9.11 Buffer Pump Coupling & Motor Replacement	52
9.12 Positive Electrode Replacement	54
Section 10 Troubleshooting	55
Section 11 Parts List	
11.1 Preventive Maintenance Kit, Standard Buffered Systems	56
11.2 Preventive Maintenance Kit Bufferless Systems	56
11.3 Wet Cell Parts	57
11.4 Mixing Motor Parts	57
11.5 Buffer Feed Parts	58
11.6 Electronics Parts	58
Section 12 Service Contact, Return Policy	59
Section 13 Product Warranty	60

Section1 General Information

Every effort has been made to ensure the accuracy of this document at the time of printing. In accordance with the company's policy of continuous product improvement, Foxcroft reserves the right to make product changes and changes in this manual at any time without notice or obligation. No liability is accepted for any direct, indirect, special, incidental or consequential damages resulting from any defect or omission in this manual.

Document No. FXCL102014.1

1.1 Safety Information

Please read this entire manual before unpacking, setting up, or operating this equipment.

Pay attention to all danger and caution statements. Failure to do so could result in serious injury to the operator or damage to the equipment.

Do not use or install this equipment in any manner other than that specified in this manual.

Be certain the unit is disconnected from the power source before attempting to service or remove any component.

HELPFUL IDENTIFIERS

In addition to information on installation and operation, this instruction manual contains WARNINGS pertaining to user safety, CAUTIONS regarding possible instrument malfunction, and NOTES on important, useful operating guidelines.

1.2 Precautionary Labels

	This symbol indicates a device sensitive to Electro-Static Discharge and indicates that care must be taken to prevent damage to the device
CAUTION	Alerts you to the possibility of instrument damage or malfunction
NOTE	Alerts you to important operating information

1.3 System Description

The Foxcroft model FX-CL uses the amperometric method to continuously monitor and control free or total residual chlorine without toxic reagents in a wide variety of process waters. Its bare electrode design makes it especially suited for water sources that foul membrane covered probes, including wastewater, ground water with elevated levels of iron, surface water and process waters with high levels of suspended solids.

The analyzer requires a constant flow from a pressurized line. The monitoring of reservoirs, basins or tanks requires a pump to deliver flow to the analyzer. Intermittent operation is possible within certain time limitations.

Residual measurements are determined and output continuously, the analyzer does not use a sample and hold method for residual determination.

The system uses a galvanic measuring cell which incorporates a gold cathode and copper anode while a continuous fixed head, gravity flow of sample water serves as the electrolyte before discharging to waste. Oxidants such as any chlorine present produce an electrical current proportional to its concentration that is measured and displayed.

Using the pH buffer (or without the buffer in select applications) the analyzer measures Free residual chlorine. It is capable of measuring from 0 to 1 ppm up to 0-20 ppm as standard. Ranges up to 0-60 ppm are available with a resistor change. The analyzer is not intended or recommended to ensure the absence of chlorine.

To determine total chlorine residual, potassium iodide is injected to convert all total chlorine to potassium chloride (KCl) which is then measured. KCl concentration is proportional to total chlorine concentration.

The analyzer cannot distinguish between various species of chloramines.

The gold cathode is continuously cleaned by a motor driven mixer and PVC balls to promote accurate readings.

Ordinary distilled white vinegar is automatically fed by peristaltic pump as a pH buffer to lower the measuring cell pH to between 4 and 5.5 pH so that the chlorine present will be in the measurable form of hypochlorous acid. The vinegar also acts as a cleaning agent.

The analyzer features a robust design to provide ease of use and to withstand continuous operation in the conditions found in typical water processing applications.

The microprocessor based electronics are designed with additional capacity to accept both software and hardware upgrades so that the analyzer can be converted over time into a multi-function and multi-parameter measurement system.

1.4 Model FX-CL Specifications

General	
Product Description	Amperometric free or total chlorine residual analyzer
Intended Use	Continuous monitoring and control of chlorine residual prior to dechlorination
Measurement Method	Amperometric bare electrode galvanic cell, gold cathode, copper anode
Parameters Measured	Free residual chlorine, total residual chlorine
Available Operating Ranges	Field selectable from 0 - 1.00 through 0 – 20 mg/L standard; up to 0 – 60 mg/L (ppm) optionally
Temperature Measurement & Compensation	Standard
Mechanical	
Dimensions	15.25" W x 12.468" H x 6" D, bottle bracket 6.75" dia.
Weight Approx.	15 lbs.
Enclosure & Ingress Protection	Wall mount molded fiberglass, UV resistant, NEMA 4X, IP65 Equivalent
Ambient Temperature and Humidity	32°-120° F (0° -49° C); 0-95% relative humidity, non-condensing
Electrical	
Conduit Openings	2
Operating Power & Consumption	24 VDC; less than 10 watts
Power Supply	Switching 88-264 Volts AC, 50/60 Hz. Single phase. 2.2A, 52.8W
Power Input Connection	External 6A fused module, IEC 320-C14 connector, with SPST switch, 2 meter detachable cord with IEC 60320 C13 & NEMA 5-15P connectors
Input Fuse	6 amp, 125V, fast acting, 5 x 20 mm glass tube, Designed to UL/CSA 248-14
Electronics	Microprocessor based
Touch Screen Display / Interface	4.3" resistive full color LCD, LED backlight, 65,356 colors, screen resolution 480 x 272, 4MB flash memory, rated min. 1 million touches on any one point
Inputs	(4) Digital, (4) 4-20mA
Signal Output	4-20mA DC 750 ohm max load, (1) standard, (4) optionally
Serial Output	(1) RS485 serial port
Relays	1-amp single pole form C, (3) standard for high & low chlorine; no flow alarms. Up to (8) available optionally. Each relay with red LED energized indicator
Motor, Mixing	Brushless 24 VDC, 0.8-1.0 full load amps, 24 watt max input
Motor, Buffer Feed Pump	Brushless 24 VDC variable speed, 0.4-0.5 full load amps, 12 watt max input
Sample Requirements	
Sample Supply	Continuous flow, electrodes must be kept wet
Flow Rate	250ml to 1000ml/min, 500 ml/min (8 GPH) recommended
Sample Cell Use	120 ml/min fixed
Sample Pressure	5 psig, 15 psig maximum
Sample Temperature	32°-120° F (0° -49° C)
Sample pH Range	3 – 10 pH
Sample Alkalinity	0.05 – 350 mg/L (ppm) total
Sample Turbidity	250 NTU or less

1.5 System Component Identification & Description



1	Mixing motor guard	12	Flushing plug & buffer input fitting
2	Mixing motor	13	Buffer feed tubing from buffer bottle
3	Mixing motor mounting plate	14	Buffer feed tubing to flow nozzle/input fitting
4	Sample inlet weir (big block)	15	Sample tubing holder
5	Measuring cell	16	Buffer tubing connector
6	Mixer paddle	17	Buffer pump tubing stop collar
7	Negative cell	18	Buffer pump tubing retainer
8	Lower block	19	Buffer pump tubing
9	Negative cell signal cable	20	Buffer pump head
10	Positive electrode signal cable	21	Touch screen interface
11	Flow nozzle	22	Power entry module with switch

1.5 System Component Identification & Description (cont.)

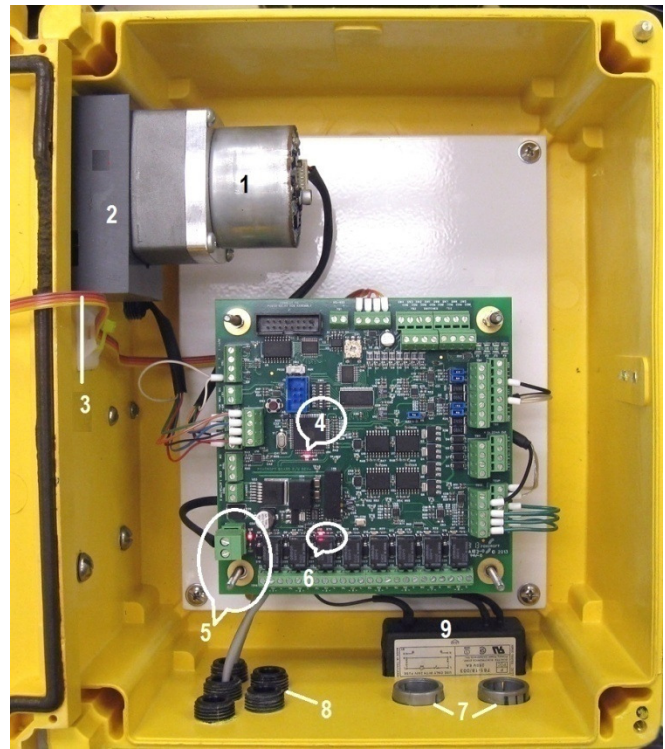

1	Buffer pump motor
2	Pump motor mounting block
3	Ribbon cable, touch screen display
4	Main circuit board flashing heartbeat LED indicator
	Power supply (under main circuit board, not shown)
5	Power input & red LED indicator
6	Relay energized red LED indicator
7	(2) Conduit holes, 7/8" diameter for 1/2" conduit
8	Spare conduit holes, number available depending on configuration
9	Power input module

 **CAUTION:** the printed circuit board is sensitive to Electro-Static Discharge. It can be irreparably damaged by static electricity, causing partial or total operational failure. You must take the following precautions before touching or making any connections to the circuit board

ALWAYS OPERATE THE ANALYZER WITH THE COVERPLATE IN PLACE

Section 2 Installation

2.1 Sample Point Selection Guidelines

General Considerations

The sample must be taken at a point after the chlorine has been thoroughly mixed and has had time to react completely with the process water. A sample point that is too close to the chlorine injection point will deliver a sample that is not mixed adequately or has not had sufficient time to complete the chemical reaction, thereby producing inaccurate readings. The supplied 3-ft long sample tubing may be cut to minimize distance.

The analyzer requires a continuous sample flow between 250 and 1000 ml per minute (500 ml/min recommended) at no more than 15 psig and a drain for sample waste. A flow control valve upstream of the sample flow cell inlet is required as well as a 10" carbon filter for zero point calibration. Carbon filters are available optionally with the analyzer.

Considerations for Control:

For residual control purposes the lag time between chemical injection and detection by the analyzer should be as short as possible, no more than 10 minutes. Longer lag times will result in a continuous cycle of over and under feeding the disinfectant.

Sample Line

The sample line should be run with 3/8" diameter rigid PVC tubing to minimize lag time between the process and analyzer. If a long sample line run is unavoidable, increase the flow rate to the analyzer to about 10-ft/sec. to reduce the sample transport time and then throttle down to the recommended rate.

When connecting the sample line into a larger process pipe, use corrosion resistant fittings only. The sample tap should be installed into the center of the pipe from either the top or side to minimize the chance of introducing air bubbles or sediment into the analyzer.

A submersible pump is required to sample from a reservoir or basin.

Filters are not recommended as the trapped material will develop a chlorine demand, resulting in the analyzer measuring a residual that is lower than is present in the process. Some applications may require a PVC flushing wye strainer to remove particulates from the sample.

In low residual applications biological growth can occur in the sample line, which will reduce the residual before it reaches the analyzer. Regular disinfection is required in such applications.

Sample Flow Consistency

Consistent flow and pressure is critical to accurate measurement. A change in flow rate during operation of a calibrated analyzer will require a recalibration of the analyzer.

Section 2 Installation

2.2 Unpacking

Inspect the equipment and packing materials for signs of shipping damage. If there is any evidence of damage, notify the transit carrier immediately.

After unpacking, it is recommended to save the shipping carton and packing materials in case the instrument must be stored or re-shipped.

The shipping container holds the following:

- 1- FX-CL Amperometric Chlorine Analyzer
- 1- Buffer Bottle Bracket
- 1 -Sample Tubing 1/4" ID x 3/8" OD x 3' long, clear flexible PVC tubing
- 1- Sample Drain Hose 5/8" ID x 3/4" OD x 3' long, clear flexible PVC tubing
- 1- Overflow Drain Hose 5/8" ID x 3/4" OD x 3' long, clear flexible PVC tubing
- 2- Buffer Pump Tubing #13 neoprene tubing x 9" (supplied loose) & buffer pump tubing #14 (installed)
- 1- Set of Four Mounting Feet with Four Screws
- 1- Inlet weir bypass fitting (to be used only for persistent entrained air bubble blockages)
- 1- Instruction Manual

2.3 Serial Number & Software Version Number

The FX-CL chlorine analyzer is shipped with two serial number labels found on the bottom right side of the enclosure, and on the inside of the enclosure door. The labels include the factory calibrated chlorine residual range. Should technical assistance be required, refer to the serial number to identify your system.

The serial number and software version number can also be found on the "Settings" main screen. This number is required if technical support service is needed.

Section 2 Installation

2.4 Locating the Analyzer & Dimensions

The FX-CL Amperometric Chlorine Analyzer is designed to be mounted on a vertical wall or panel.

Mount either indoors or outdoors in a location that is:

- Within ambient temperature and humidity limits (32-120°F, 0-49°C), 95% relative humidity or less, non-condensing
- Out of direct sunlight and away from any heat source
- Protected from direct contact with rain, snow, ice, or dust.
- Protected from corrosive fluids
- An area that is not subject to vibration
- As close to the sample point as possible to minimize sample lag time
- Accessible for viewing and maintenance
- Large enough to include the 6.75" dia. pH buffer bottle bracket and a 10" carbon filter for zero point calibration

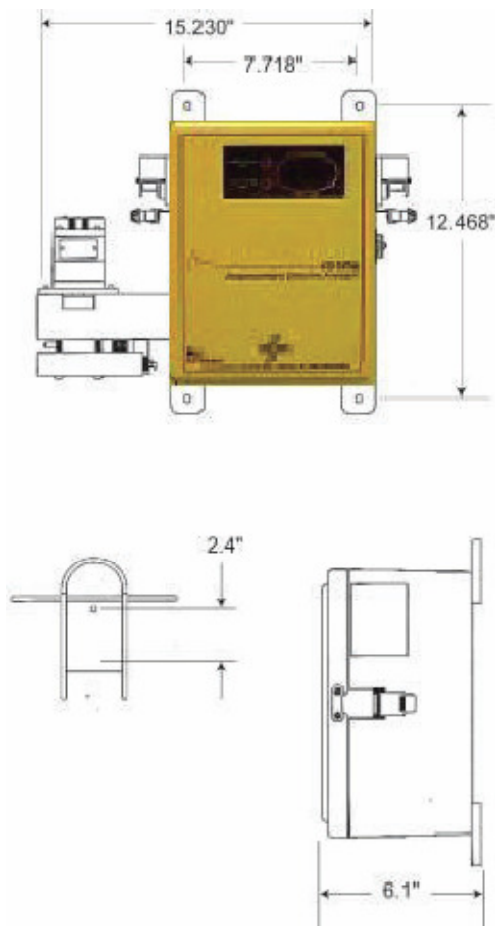

Section 2 Installation

2.5 Wall mounting the analyzer

Locate at approximate shoulder height for convenience. The FX-CL must be level from side to side and front to back to ensure that its integral weir operates properly.

1. Attach the four mounting feet to the rear of the electronics enclosure using the included 5/16"-18 x 1/2" flat head screws.
2. Orient the analyzer so that the sample flow cell drain outlets are pointing downward.
3. Anchor securely to the wall or panel. The analyzer weighs approximately 15 pounds
4. Attach the vinegar bottle bracket to the wall. The bottom of the bracket should be about 3" above the bottom surface of the electronics enclosure, and slightly below the height of the peristaltic pump.
 - a. NOTE: Do not mount the vinegar bottle higher than the peristaltic pump. This could lead to atmospheric siphoning of the buffer solution.
5. Assemble the carbon filter wall mount bracket to the filter housing and attach to the wall or panel.



Not Recommended

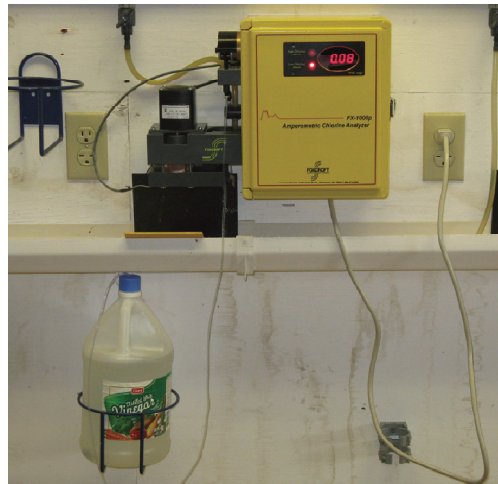

Better Arrangement

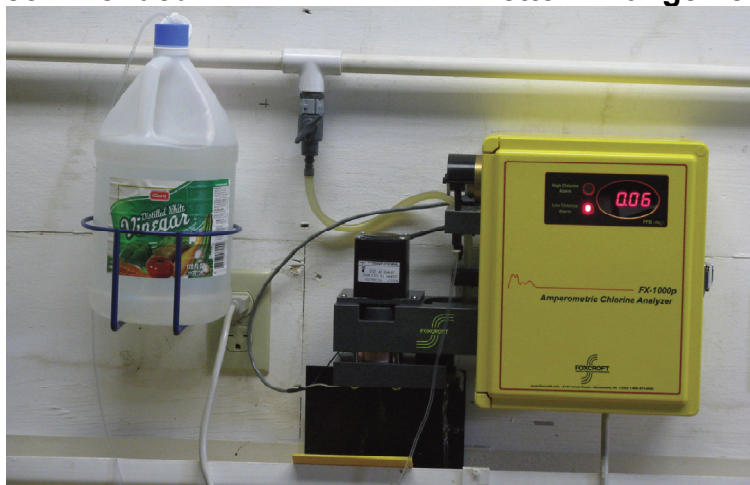

Best Arrangement

Section 3 Plumbing Installation

1. Connect the supplied 1/4" ID x 3/8" OD x 3' long, clear flexible PVC sample line to the customer supplied tubing tee and flow control valve and secure. Cut if necessary to keep the sample line as short as possible.
2. Route the sample tubing down to the analyzer, through the sample line holder guide and into the sample inlet weir. Insert the end of the tube about half way down from the top edge of the center drain cup in the inlet weir. **NOTE: Do not use the supplied inlet weir bypass fitting unless you have persistent flow blockage to the measuring cell caused by entrained air or dissolved gas bubbles. If the bypass fitting is used you must closely control both the pressure and flow rate to a minimum 130 ml/min.**
3. Install the carbon filter between two flow control valves shown in the diagram below. Connect the tubing from the carbon filter to the sample supply tee.
4. Connect the two supplied 5/8" ID x 3/4" OD x 3' long, clear flexible PVC drain lines to the overflow drain on the right side of the flow cell block and to the measuring cell drain on the left side. Route the hoses down to maintain gravity feed into a drain.

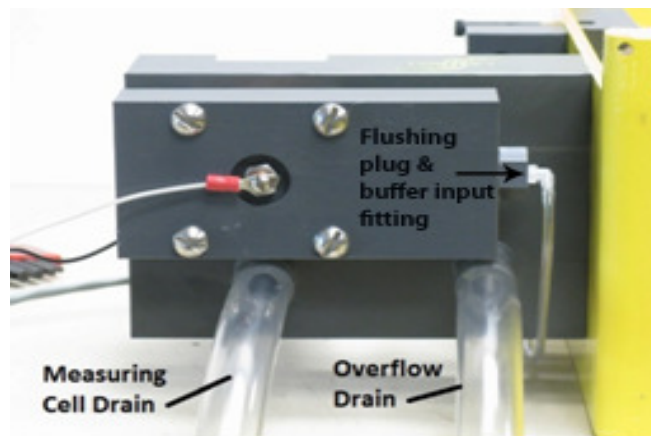

Section 3.1 Recommended Plumbing Installations

Recommended Installation with carbon filter

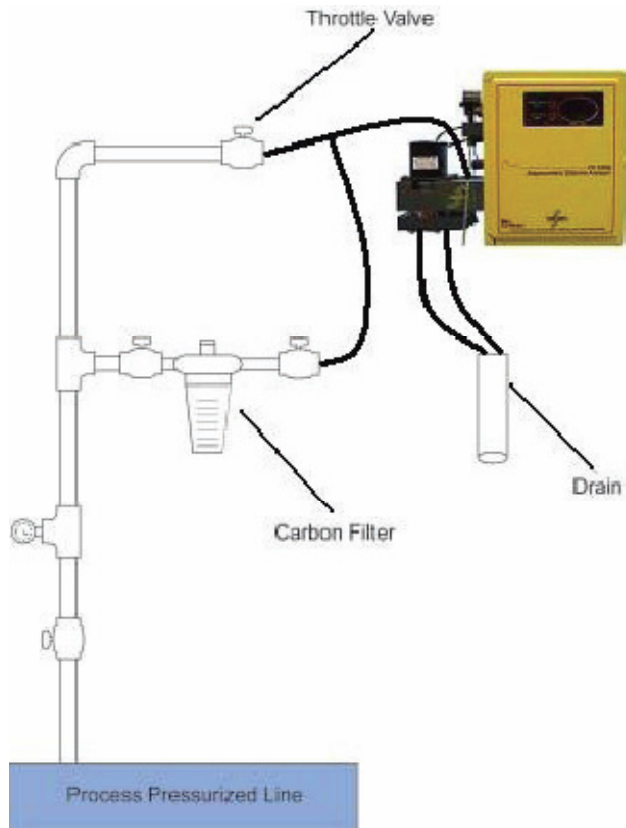

Dirty Water Application

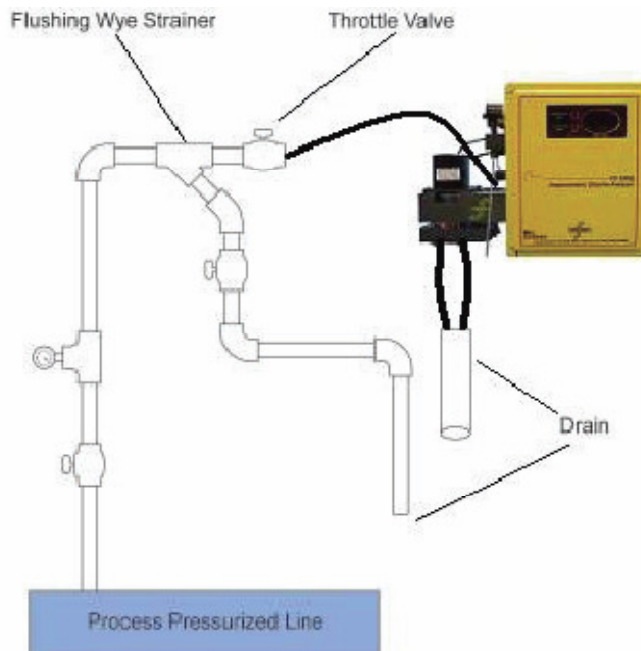

Section 4 Electrical Installation

4.1 Electrostatic Warning



 **CAUTION:** the printed circuit board is sensitive to Electro-Static Discharge. It can be irreparably damaged by static electricity, causing partial or total operational failure. You must take the following precautions before touching or making any connections to the circuit board

- Before touching the circuit board touch an earth grounded metal surface such as the analyzer's power supply guard, a metal pipe or conduit to discharge any static electricity from your body.
- Wear an anti-static wrist strap connected to an earth ground.

4.2 Power Connection

The FX-CL chlorine analyzer uses a universal switching power supply and can be connected to 100-260 Volts AC, 50/60 Hz. single phase power anywhere in the world. The power supply converts the line voltage to the analyzer's operating voltage of 24VDC.

The analyzer includes a 6 amp fused power input module that is pre-wired to the power supply at the factory so that no direct power input field wiring to the power supply is required. The analyzer is supplied with a 2 meter long power cord with IEC #60320 C13 and NEMA 5-15P connectors. The power input module has an IEC male inlet to accept an IEC #60320 C13 connector.

1. Install a 15 amp circuit breaker to disconnect the analyzer from the main power supply if regulations require.
2. Install a NEMA 5-15 type B grounded socket or a grounded socket to meet local electrical codes for international installations.
3. Plug the power cord into the inlet on the analyzer and then into the wall socket.

NOTE:

All electrical connections should comply with the National Electrical Code (NEC) and all local regulations.

Do not run power and signal wires together in the same conduit.

Section 4 Electrical Installation

4.3 Circuit Board Layout and Identification

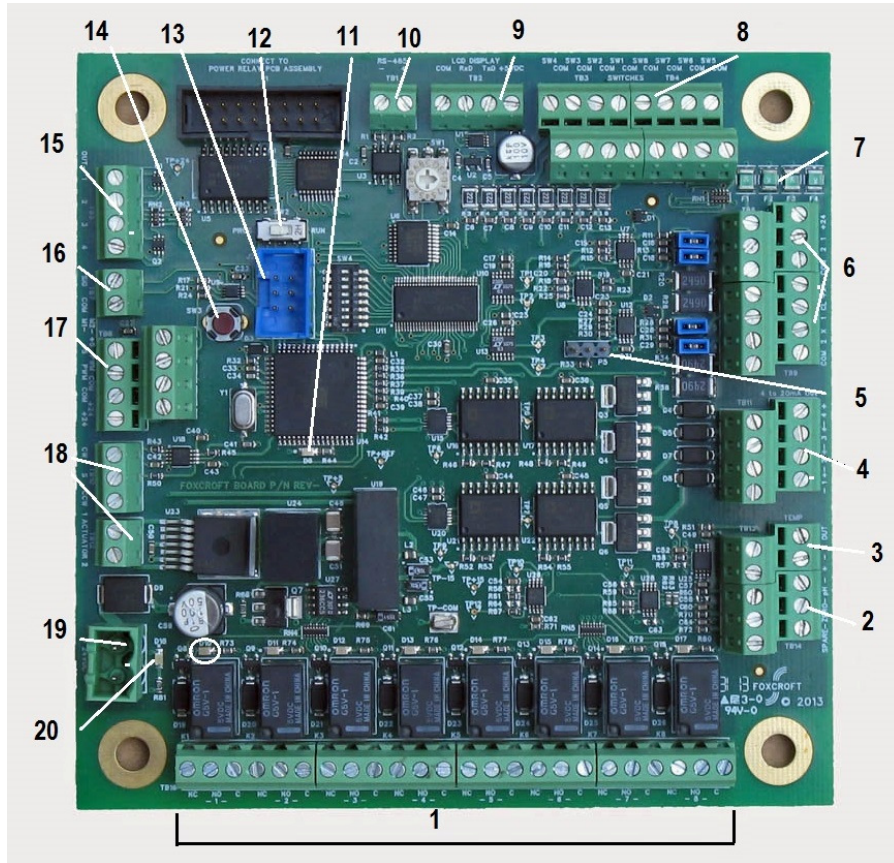

1	Relays NO / NC, each w/LED (circled)	11	Processor "heartbeat" flashing LED indicator
2	pH input (from raw pH input board)	12	Program / Run switch, factory use only
3	Temperature input	13	Programming input connector, factory use only
4	4-20mA outputs	14	Reset switch, factory use only
5	Jumper, Free / Total chlorine probe factory use only	15	Motor start / stop
6	Chlorine sensor inputs	16	Flow switch input
7	Fuses, non-replaceable	17	Motor PWM
8	Switch inputs	18	Reserved for FX-8D gas flow control valve
9	LCD display input	19	Power input
10	RS485 output	20	Power "On" indicator LED

Section 4 Electrical Installation

4.4 Factory Default Wiring

4.41 Bare Measuring Electrodes

Gold Electrode Black - Gnd	TB6-1
+ Input	TB6-2
+24V	TB6-3
Gnd	TB6-4
+ Input	TB6-5
+24V	TB6-6
Gnd	TB9-1
	TB9-2
Gold Electrode Clear - +	TB9-3
+24V	TB9-4
Gnd	TB9-5
+ Input	TB9-6
+ Input	TB9-7
+24V	TB9-8

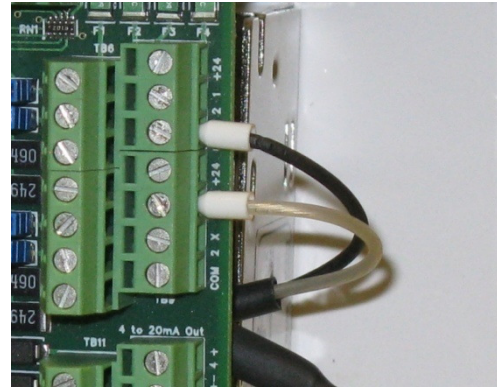

4.42 Temperature Sensing Element

Black		TB13-3
Clear		TB13-1
White		TB-13-2
Green, pH input jumper	(-) TB14-3	(+) TB14-6
Green, open input jumper	(-) TB14-2	(+) TB14-5
Green, spare input jumper	(-) TB14-1	(+) TB14-4

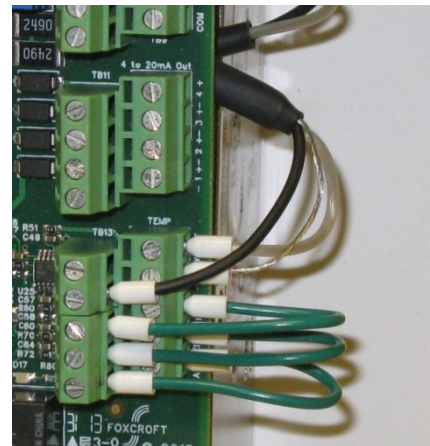

4.43 Pump & Mixing Motor Wiring

Pump Orange +5V	TB8-4
Pump Blue	TB8-3
Pump Green, Black	TB8-2
Pump Red +24V	TB8-1
Mix Orange, Green +5V	TB8-8
Mix Blue	TB8-7
Mix Black	TB8-6
Mix Red +24V	TB8-5
Pump White	TB5-1
Mix White	TB5-1

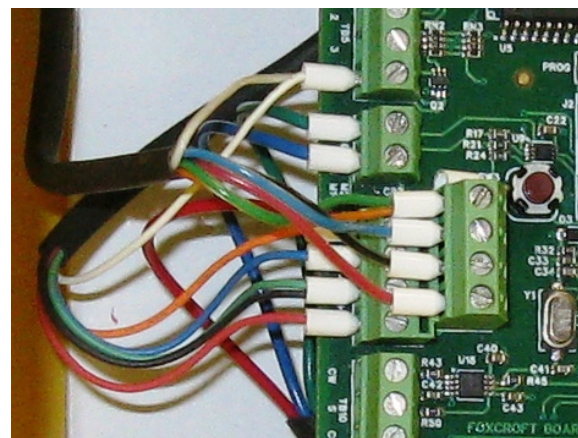

Section 4 Electrical Installation

4.4 Factory Default Wiring

4.44 Flow Sensor Wiring

Green - Sig	TB7-2
Blue - Gnd	TB7-1
Red - +5V	TB8-1

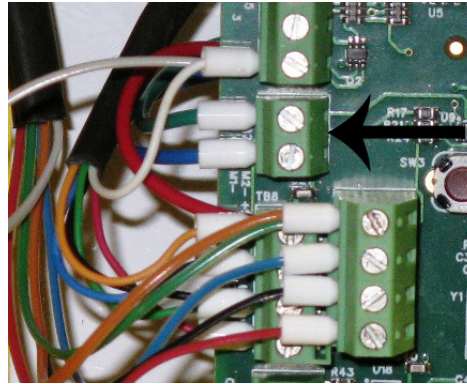

4.45 Display wiring

Brown (-)	TB2-4
Red	TB2-3
Orange	TB2-2
Yellow (+)	TB2-1

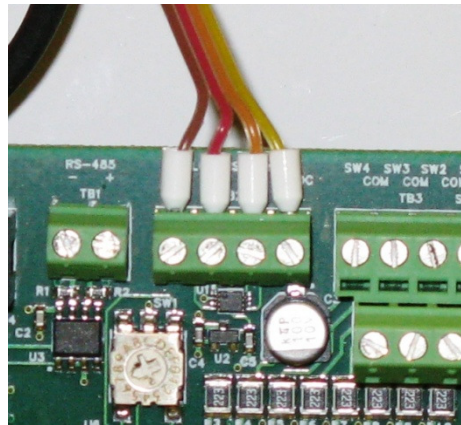

4.46 Power Input

+ 24V	TB-2
- Gnd	TB-1

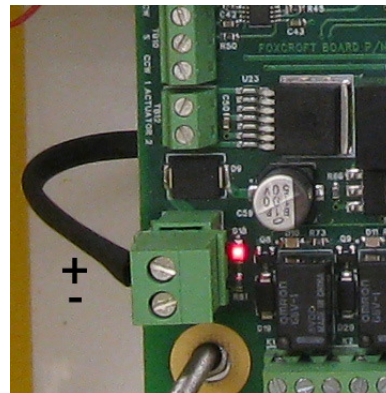

Section 4 Electrical Installation

4.5 Field Wiring

4.51 Current Output Wiring

Disinfectant (+) active	TB11-1
Disinfectant (-) active	TB11-5
pH (+) optional	TB11-2
pH (-) optional	TB11-6
Temperature (+) active	TB11-3
Temperature (-) active	TB11-7
Spare (+) optional	TB11-4
Spare (-) optional	TB11-8

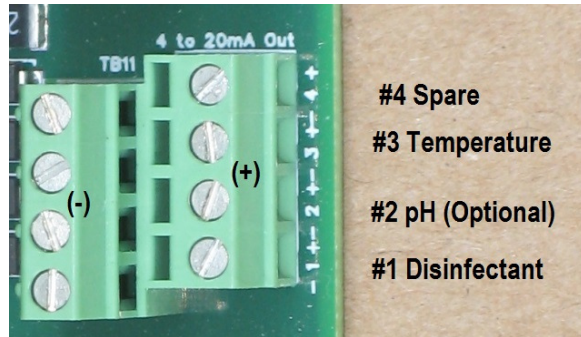

CAUTION: IF MULTIPLE GROUNDS ARE PRESENT THE CURRENT INPUTS OF EXTERNAL DEVICES MUST BE ISOLATED TO AVOID GROUND LOOPS WHICH CAN DISRUPT THE MEASURING ELECTRODE.

4.52 RS485 Serial Output Wiring

+	TB 1-1
-	TB 1-2

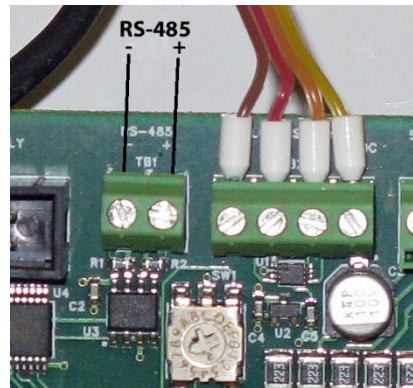

4.53 Form C Alarm Relay Wiring TB-16

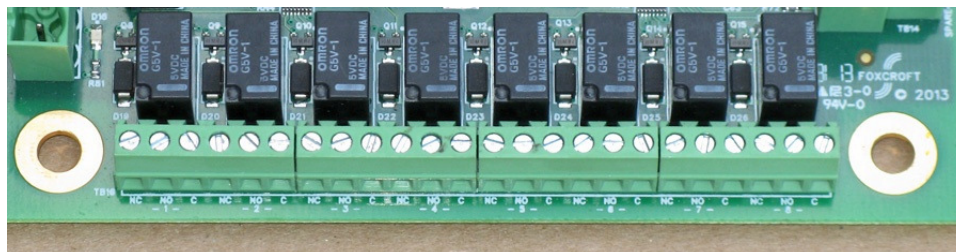

High Disinfectant - fixed/dedicated	Relay 1
Low Disinfectant - fixed/dedicated	Relay 2
No Flow - fixed/dedicated	Relay 3
Optional Relays Reserved Per Application	Relays 4 through 8

Section 5 Touch Screen Interface & Navigation

5.1 Main Screen Identification and Description

The main screen is both the home and run screen that will display automatically after the start up routine has completed and while the analyzer is in operation. Navigation through the menus is done simply by touching the item of interest. You will find that lightly tapping with your fingernail works the best. You will hear a beep when a selection is made.

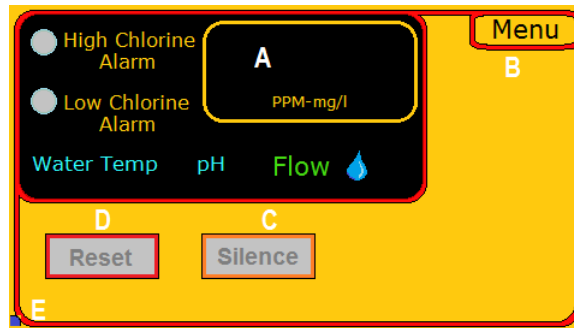

A	Non-interactive display of disinfectant concentration, water temperature, pH value if available, high and low disinfectant alarm status, flow status / no flow alarm
B	Active button to access setup menu items
C	Active button to silence disinfectant audible alarm if equipped
D	Active button to reset disinfectant alarm contacts
E	Flashing "heart beat" microprocessor status indicator

On the main screen white items with red borders are buttons that will actuate the indicated function by touching the screen. Items within the black field are displays only of live online measurements and alarm conditions. The large red values are the disinfectant concentration with unit of measurement below. If the residual exceeds the operating range only the maximum value of the range will be displayed.

The "High and Low Chlorine Alarm" indicators are blue if residual is within the alarm level settings. The indicators will turn red upon alarm condition and remain that color until the relay is reset by touching the RESET button. Touching the SILENCE button applies to an audible alarm if so equipped.

Normal flow status is indicated by **Flow** . Upon no flow alarm condition relay contact #3 will close, the water drop image will be replaced by a flashing **No Flow X**, and both the mixing motor and buffer feed motor will stop. When flow is re-established the relay will reset (it cannot be reset manually), the motors will restart automatically, and flow status indicator will return to normal mode. The "No Flow" alarm is not adjustable.

The "heart beat" microprocessor status indicator flashes continuously every half second during normal operation. Upon processor failure the indicator will not flash at all, main board replacement is required.

Section 5 Touch Screen Interface & Navigation

5.2 Menu Structure

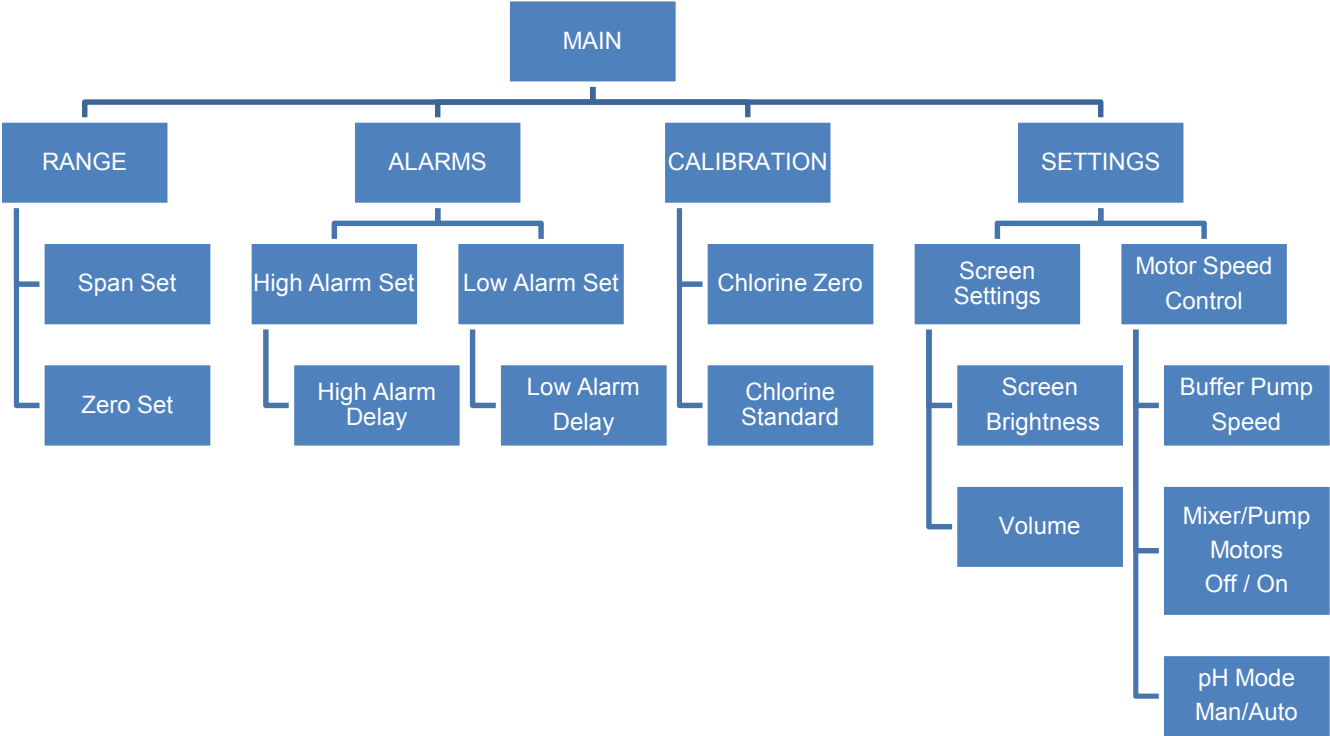

Section 5 Touch Screen Interface & Navigation

5.3 Screen Navigation

Navigation through the menus is done simply by touching the item of interest. After performing an adjustment you will return to the main home screen by touching menu. You will find that lightly tapping with your fingernail works the best. You will hear a beep when a selection is made.

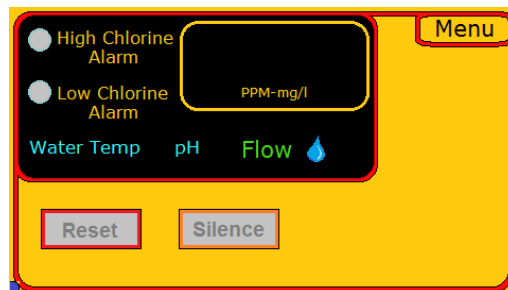

Touching the Menu button will display the main submenus available to configure the analyzer. The software is designed to provide simple operation, therefore some functions and or capabilities are programmed at the factory and are not field adjustable.

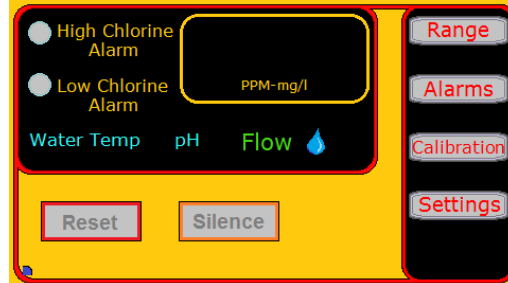

RANGE SUBMENU: Displays and sets the operating range of the analyzer. Setting the range automatically scales the 4-20 mA output to the selected range and is not further scalable. Setting the range also automatically sets the high and low alarm set points to 10% and 90% of the range. The alarm trip points can be configured to other values.

ALARMS SUBMENU: Is used to set the high and low disinfectant alarm levels; and to set a time delay for each alarm before it will energize.

CALIBRATION SUBMENU: Is used to perform the zero point calibration and span calibration to a grab sample or standard.

SETTINGS SUBMENU: These are used to adjust screen brightness and audio volume, to adjust the buffer feed pump motor speed in RPM, to turn off the motors for troubleshooting, and to set pH compensation to manual or auto if this feature is available (for systems with pH sensor only). This screen also contains the serial number, the software version number, and display version number.

Section 5 Touch Screen Interface & Navigation

5.4 Configuring the Operating Range & mA Output

Setting the operating range will automatically set the mA output of the disinfectant residual to match the operating range, set the high alarm to 90% of span, and low alarm to 10% of span. The alarms can later be configured as needed. **The range can be field adjusted lower than the original factory set range, but not higher. The analyzer must be returned to the factory to increase the operating range higher than originally ordered and configured.** It is best to operate at the range midpoint.

1. Touch the RANGE button to display the operating range configuration screen.
2. Touch the Edit button to display the Span Set screen.



3. To change the factory set range, touch "Clear", then use the keypad to enter a value equal to or less than the original factory set operating range. A check mark will appear next to the value under "Range-Span Set".

If the range you select is over the allowable maximum range an "Out of Range" error message will appear AND the value will be forced to the maximum range limit set at the time of original factory configuration.

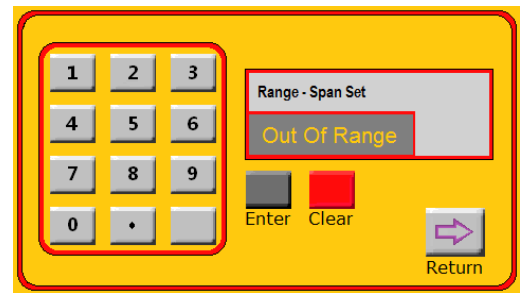
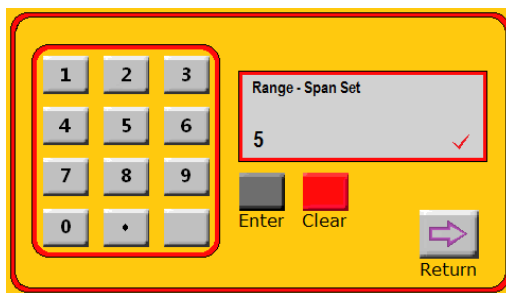

To clear the Out of Range message touch Clear and enter an acceptable value with the keypad, and touch Enter.

4. To accept the value touch the Enter button, or press Clear to re-enter the desired range, press Enter, and then Return to go back to the Range menu.

Section 5 Touch Screen Interface & Navigation

5.4 Configuring the Operating Range & mA Output (cont.)

5. Repeat the procedure above to enter the zero point.

NOTE: Even with zero disinfectant present the electrode will always generate a small residual current. The analyzer will compensate for this current by subtracting it in the zero set process to produce a zero ppm value. Maximum cell voltage is 5VDC.

When setting the zero point the cell voltage should be as low as possible and the residual should be as close to zero as possible. If too high determine & eliminate the cause of the residual. This may simply entail allowing more time for residual chlorine to be flushed from the system, reducing the flow through the carbon filter to allow sufficient time for chlorine removal, or replacing the carbon filter element to ensure complete disinfectant removal.

It is always best to set the zero point with dechlorinated process water. Do not use distilled or deionized water to set the zero point because the conductivity differs from the sample and will produce an inaccurate zero point (and subsequent residual measurements).

CAUTION: If you need to change a setting at any time, you must first touch the Clear button to erase the previous value AND enter a value AND touch the enter button.

All values are stored in memory until they are cleared and replaced with another value. Failure to clear an existing number before entering a new number will produce invalid results. Touching “Clear” and the “Enter” alone will not clear the value in the register.

5.5 Configuring the mA Output

CAUTION: In electrical systems with multiple grounds and or non-isolated RS485 signal wires, the current inputs of any external device connected to the analyzer current output must be isolated to prevent ground loop interference with the measuring electrode.

As stated above, in the standard software revision the mA output of the disinfectant residual is scaled automatically to match the operating range whenever the operating range is selected. As such it is not capable of being scaled further.

The mA output of temperature is active in the standard software version and is scaled at the factory, it is not field scalable. Connect to terminals TB11-3 and TB11-7 as shown in section 4.51.

Additional current outputs, up to a total of four outputs, are available depending upon the options selected for the analyzer at the time of purchase.

Section 5 Touch Screen Interface & Navigation

5.6 Configuring the Alarm Relays

There are a total of (8) 1A dry contact form C relays each with LED indicator installed on the circuit board, only (3) are active in the standard configuration. Relay 1 is dedicated to the High disinfectant alarm, Relay 2 for the Low disinfectant alarm, and Relay 3 for the No Flow alarm. Upon a relay energizing its LED indicator will light. Each relay can be wired as either NO or NC; no software set up is needed to configure the relay as NO or NC.

Upon setting the operating range the High alarm trip point will be automatically set at 90% of the range, and the Low alarm trip point at 10% of range in order to provide a degree of protection in case the alarms are not set. The alarm trip points can be configured as needed.

1. Touch the Alarms button to display the high and low disinfectant alarm configuration screen. The alarms will be set by default to 10% and 90% of range upon setting the operating range.

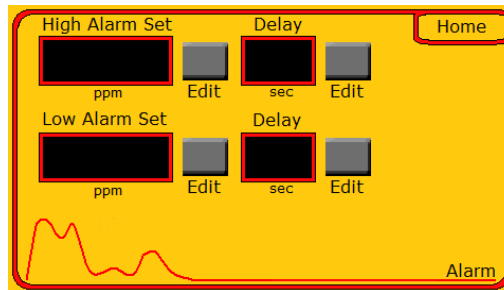

2. To set the High residual alarm, touch the Edit button. On the High Alarm Set screen touch the Clear button, then use the keypad to enter the set point. A check mark will appear with the value entered, press Enter to select, press return to go back to the Alarms screen.

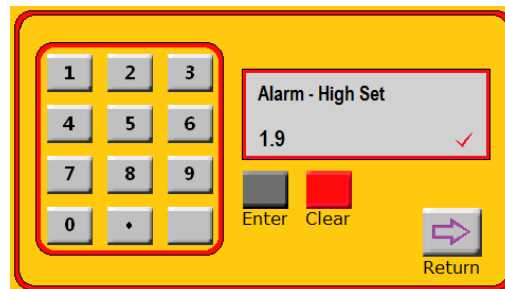

NOTE: If the high alarm is set above the upper limit of the operating range an “Out of Range” message will appear in the white box, and the high alarm set point will be forced to the upper limit of the operating range. Go back and enter a value no greater than the range limit.

CAUTION: If you need to change a setting at any time, you must first touch the Clear button AND enter a value AND touch the enter button to erase the previous value.

All values are stored in memory until they are cleared and replaced with another value. Failure to clear an existing number before entering a new number will produce invalid results. Touching “Clear” and the “Enter” alone will not clear the value in the register.

Section 5 Touch Screen Interface & Navigation

5.6 Configuring the Alarm Relays (cont.)

3. The “High Alarm Delay” is intended to prevent alarming during expected momentary deviations in residual levels. To set the delay in seconds first touch the Clear button, then use the keypad to enter the desired value and press the Enter key, a check mark will appear along with the selected value. The maximum value allowed is 300 seconds (5 minutes). Press Return to go back to the Alarms configuration screen.
4. To set the low disinfectant residual alarm repeat the process above using the Low Alarm Set “Edit” & “Delay” buttons.
5. Press Return to go back to the Alarms screen, then Menu to return to the main run screen.

Section 5.7 Calibration

Before attempting to calibrate the analyzer you must first ensure it is providing stable readings. Unstable or constantly fluctuating readings indicate either a problem with the disinfectant feed process or a problem with the measuring electrode. This must be first corrected if you hope to achieve an accurate calibration.

The most important factors in achieving an accurate calibration is allowing sufficient time for the cell to stabilize and setting an accurate zero point. Even with zero disinfectant present the electrode will always generate a small residual current. The analyzer will compensate for this current by subtracting it in the zero set process to produce a zero ppm value.

When setting the zero point the residual displayed should be as close to zero as possible. If too high determine & eliminate the cause of the residual.

- First allow more time for dechlorinated water to flow through the cell and flush the system.
- Reduce flow through the carbon filter to eliminate chlorine bleed through.
- Check and possibly replace the carbon filter element to ensure complete disinfectant removal.

NOTE: It is always best to set the zero point with dechlorinated process water. Do not use distilled or deionized water to set the zero point because the conductivity differs from the sample and will produce an inaccurate zero point (and subsequent residual measurements) for your process. A 5-gallon bucket and small submersible pump can be used if needed to make a circulation system for calibration.

CAUTION: All values are stored in memory until they are cleared and replaced with another value. Failure to clear an existing number before entering a new number will produce invalid results. Touching “Clear” and the “Enter” alone will not clear the value in the register.

Section 5 Touch Screen Interface & Navigation

5.7 Calibration

Calibration must be performed with an EPA or Standard Methods approved analytical method. The most accurate calibration method is amperometric titration. The DPD colorimetric method is also approved and is typically performed with portable hand held meters. Please note this method has a greater uncertainty than amperometric titration due to various interferences and inherent limitations of the method.

The accuracy of the FX-CL can never be greater than the instrument it is being calibrated against. Accuracy is a function of the method used, inherent tolerances in the calibration instrument, the quality and freshness of reagents, and the care taken to perform the calibration.

5.71 Setting the Zero Point.

1. Switch the sample supply to your dechlorinated process water source, which can be the process sample diverted through a carbon filter, or the dechlorinated process water pumped from a container. Ideally the flow rate should be the same as during operation. Allow the dechlorinated water to flow for 30 minutes to 1 hour until the readings stabilize at or as close as possible to zero. Make sure the flow rate is consistent.
2. From the main screen touch the Calibration button to go to the Calibration submenu screen.

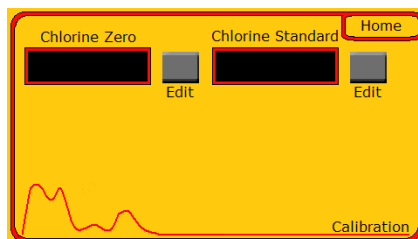

3. If the cell voltage and or residual appears to be too high you must determine & eliminate the cause of the excessive residual.
 - First allow more time for dechlorinated water to flow through the cell and flush the system.
 - Reduce flow through the carbon filter to eliminate chlorine bleed through.
 - Check and possibly replace the carbon filter element to ensure complete disinfectant removal.
4. Set the zero point by first touching the Chlorine Zero Edit button.

Section 5 Touch Screen Interface & Navigation

5.71 Setting the Zero Point (cont.)

5. Press Clear, then enter 0.00 by touching the keypad and pressing the Enter button. A check mark will appear next to the value. Press the Return button to return to the calibration screen.

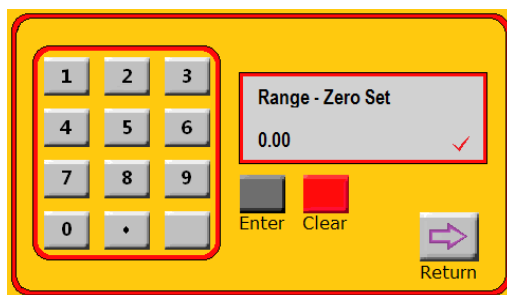

5.72 Calibrating the Span (Standard)

Stable chlorine standards do not exist; because of this the analyzer must be calibrated against a grab sample of the process fluid.

Since chlorine solution residual is so unstable, take the grab sample as close to the measuring cell as possible and process the sample as quickly as possible.

Do not interfere with the sample flow to the measuring cell when calibrating; always take the sample from the overflow drain or to a sample tap installed before the measuring cell.

To ensure optimum accuracy throughout the entire operating range you should calibrate using a residual that is as close as possible to the upper limit of the selected operating range. The slope produced by calibration will be linear. If you need always need to calibrate at less than 50% of the range then you should select a lower operating range.

1. Before attempting calibration be sure the analyzer is displaying a stable reading, allow 30 minutes to 1 hour after running dechlorinated water for the cell to stabilize. Make sure the flow rate is consistent.

Section 5 Touch Screen Interface & Navigation

5.72 Calibrating the Span (Standard)

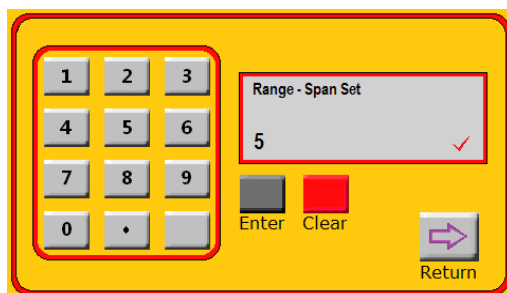

2. From the Calibration submenu screen touch the Chlorine Standard Set button. Press the Clear button, then enter the value determined by your grab sample instrument using the keypad and press Enter to both clear the previous standard and to enter the new value.

A check mark will appear next to the value.

NOTE: If the standard value entered exceeds the upper limit of the operating range, an out of range message will appear in the white box and the value for the calibration standard will be forced to the operating range upper limit. Go back and re-enter the desired value.

To enter a new calibration standard value you must first touch the Clear button AND enter a value AND touch the enter button to erase the previous value.

All values are stored in memory until they are cleared and replaced with another value. Failure to clear an existing number before entering a new number will produce invalid results. Touching "Clear" and the "Enter" alone will not clear the value in the register.

3. Press the Return button to go back to the Calibration submenu screen, and then press the Home button to return to the main Run screen.

Section 6 Settings Submenu Screen

The settings screen allows you to adjust the screen brightness and audio volume; to adjust the buffer feed pump motor speed in RPM, to manually turn all motors off or on, and to activate pH control if this option is available.

This screen also contains the serial number, the software version number, and display version number. These numbers are required for customer service and technical support.

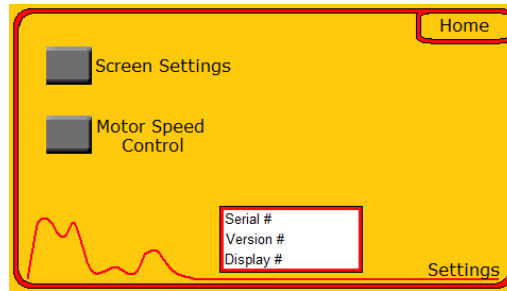

6.1 Buffer Pump Motor Speed Control

Although the speed of the mixing motor is fixed at 120 RPM, the speed of the buffer pump motor is adjustable in increments of 5%.

This feature can be used when the total alkalinity of the water sample prevents the 5% distilled white vinegar from lowering the measuring cell pH to the recommended 4 to 5.5 pH range.

In general, the buffer pump speed should not be increased more than 50% higher than standard speed of 15%. If additional pH buffering is needed then a higher grain, or concentration, of vinegar should be used and fed at the standard speed. It may be necessary to change the buffer pump tubing to the smaller #13 size when feeding vinegar with a higher concentration. Consult the factory for assistance if needed.

1. To change the buffer pump motor speed, touch the Motor Speed Control button from the Settings submenu.

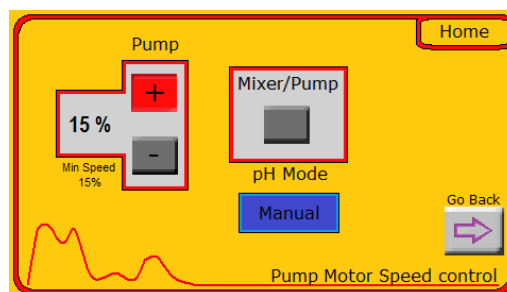

2. Touch the red + button to increase the speed in increments of 5%. The entered value will appear to the left of the buttons, and the motor speed will increase immediately.

Section 6 Settings Submenu Screen

6.2 Turning the Mixer & Pump Motor Off / On

The mixing and pump motor(s) can be manually turned off and back on for maintenance or troubleshooting purposes. Simply touch the Mixer/Pump square gray button to toggle the motors off (the button will turn red and display “Off”) or on (the button will turn green and display “On”). Touch the “Go Back” button to return to the settings screen, or Home to return to the Home / Main run screen.

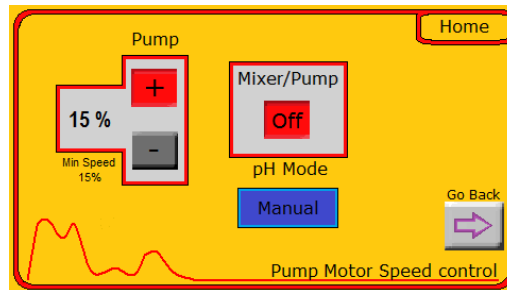

6.3 Setting pH Compensation Mode

If the analyzer is equipped with software produced pH compensation using a pH probe, auto pH compensation can be turned on or off. Upon start up the default mode is Manual.

pH compensation is required to produce a valid free chlorine residual determination if the sample pH is above 7pH due to the dissociation of hypochlorous acid at various pH and temperature levels. This subject is discussed in more detail later in this manual in the Chlorine Chemistry section.

To turn on automatic pH compensation (only available if the analyzer is purchased with this option) simply touch the blue pH mode button. It will turn green and display “Auto”. The measured chlorine residual will be compensated according to the hypochlorous acid dissociation curve. Touch the “Go Back” button to return to the settings screen, or Home to return to the Home / Main run screen.

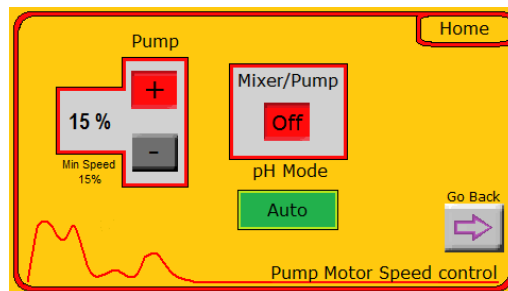

6 Settings Submenu Screen

6.4 Screen Settings

The screen brightness and audio volume can be adjusted to suit your needs. From the Settings submenu touch the “Screen Settings” button to display the adjustment screen.

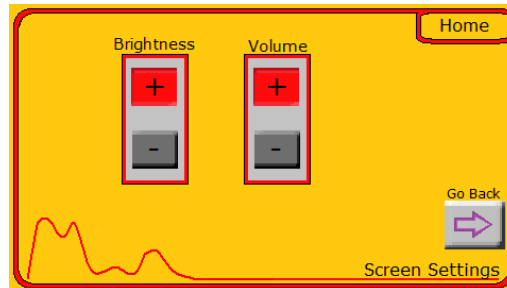

Simply touch the Plus or Minus buttons to adjust as needed. Touch the “Go Back” button to return to the settings screen, or Home to return to the Home / Main run screen.

Section 7 Buffer Solution & Feed

7.1 Buffer Feed Tubing Selection

The buffer feed pump is supplied with size #14 tubing factory installed. Smaller diameter #13 tubing is also supplied but should only be used if the sample pH and total alkalinity are low enough to allow the vinegar to buffer the sample to the proper range of 4 - 6pH.

Refer to the table below to determine which tubing size best suits your application.

	#13 Tubing (supplied)	#14 Tubing (factory installed)
Buffer Flow Rate	0.2 ml per minute 288 ml per day 13.125 days per gallon	0.6 ml per minute 864 ml per day 4.375 days per gallon
pH limit	Less than 7.5 pH	More than 7.5 pH
Total Alkalinity	Less than 50 ppm	More than 50 ppm

If you need to change to a different size tubing see Section 9.8 in the maintenance section of this manual.

7.2 Routing the buffer feed tubing

Buffer feed tubing is connected at the factory from the left hand buffer pump discharge side of the #14 tubing to the buffer input fitting in the flushing plug (located on the inner side of the lower block of the flow cell). It is also connected from the right hand buffer pump intake side of the #14 tubing and to the blue bottle cap.

With the vinegar bottle in the bracket, remove the original bottle cap. Insert the 1/8" clear tube with sinker attached into the bottom of the vinegar bottle and secure the cap.



Section 7 Buffer Solution & Feed

7.3 Recommend Buffer Solution for Free Chlorine Determination

For free chlorine determination the FX-CL is designed to use ordinary 5% food grade distilled white vinegar as a buffering agent to lower the pH in the measuring cell to between 4 and 6 pH. No other reagents are required.

The pH of recommended distilled white vinegar available in any food store generally ranges from pH 2.3 to pH 2.6. Specifications state its acidity must be at least 4% and no more than 7%.

Distilled white vinegar is used because distillation eliminates any chlorine demand. Therefore:

Do not use any other food grade vinegar or flavored vinegars; they will introduce a chlorine demand to the sample cell and thus provide inaccurate measurements.

The Food and Drug Administration has stated that diluted glacial acetic acid is not vinegar.

7.4 Vinegar Storage, Handling, Contamination

Store the vinegar unopened at room temperature; it does not need refrigeration because of its acidity. Studies by the Vinegar Institute have confirmed the shelf life of vinegar is almost indefinite and that distilled white vinegar will remain virtually unchanged over an extended period of time. The expiration date, typically two years, found on distilled white vinegar packaging is a requirement for a product classified as food.

Exposure to air can allow the biological organisms that produce vinegar, known as mother of vinegar, to thrive. The white slimy substance can block the feed tubing, resulting in lower than actual residual readings due to a high pH in the measuring cell.

To minimize the chances of contamination:

- Do not add new vinegar to the existing bottle when the vinegar runs out.

Always discard the old bottle and replace it with a new bottle.

- Minimize exposure to the air.
- Ensure that the supplied cap remains on the bottle.

Section 7 Buffer Solution & Feed

7.5 Recommend Buffer Solution for Total Chlorine Determination

To measure residual total chlorine, mix ACS reagent grade potassium iodide (KI) crystals directly into the bottle of 5% distilled white vinegar at the time of use. Mix only one batch of vinegar and potassium iodide at a time, and **never premix**. Thoroughly mix the crystals until they are completely dissolved in the vinegar.

Always use ACS reagent grade KI.

Once the potassium iodide crystals are mixed with distilled white vinegar, the potassium iodide has a limited life of no more than 7 days per gallon due to the acidity of the solution.

Solution useful life is also a function of temperature and light exposure. Solution life decreases as temperature and light exposure increase. Light exposure should be minimized by using a dark bottle or covering the bottle.

7.6 Potassium Iodide Dosage

To determine the potassium iodide dosage refer to the table below to find the range in which your typical total chlorine process value resides.

Add the listed amount of crystals to one gallon of distilled white vinegar. The amount of KI prescribed below applies to the upper part of the measurement range. You should be able to slightly reduce the KI dosage if you are operating below the upper limit of the residual range for dosage.

Range of Typical Value	Amount of (KI) Crystals
0 to 0.5 ppm	10 grams to one gallon
0.5 to 1.0 ppm	20 grams to one gallon
1.0 to 2.0 ppm	40 grams to one gallon
2.0 to 5.0 ppm	60 grams to one gallon
5.0 to 20 ppm	100 grams to one gallon

If you are measuring at 20 ppm or above, or using the #13 tubing, it is recommended that an auxiliary KI pump be installed to feed the solution separately from the vinegar.

When using the second auxiliary pump mix the potassium iodide crystals with distilled water, rather than the vinegar. This will extend the limited life of the buffer solution, and provide a more stable solution since it will be mixed with a non acidic pH solution.

Section 8 Startup

1. Ensure there is a fresh bottle of distilled white vinegar pH buffer and that the buffer feed tubing is routed and installed correctly.
2. Start the flow of water to the analyzer while observing both pressure and flow rate limits. The recommended flow rate range is 250 ml/min to 1,000 ml/min. 500 ml/min is recommended.
 - Water must be flowing without fluctuation through the sample flow cell's fixed overflow weir and discharged from the drain hoses on both the right-hand and left hand sides of the block.
 - *NOTE: make sure that water is flowing from the drain on the left hand side of the block beneath the measuring cell.* Minimum flow from this drain should be 130 ml/min. Insufficient flow from the measuring cell drain indicates that either the flow rate is set too low or there is an internal blockage to the measuring cell.
 - Internal flow blockage can be caused by air or entrained gas bubbles that expand when depressurized. Flow blockage can cause the positive electrode to overheat and become permanently damaged. **If insufficient flow is detected the No Flow alarm will indicate and turn off the mixing motor to prevent electrode overheating and the pump motor.**
 - Bubble blockage can be dislodged by inserting a wire into the hole in the sample weir that leads down into the lower block or by pulling out the flushing plug momentarily.
 - Bubble blockage can be a continual problem for those sampling groundwater with dissolved gases or oxygen. **For these cases only** take the gray PVC fitting provided with the analyzer and tap it into the hole referenced above. Attach the sample tubing with the supplied clamp. This will keep the sample pressurized and prevent bubble formation. **Since the constant head weir will be bypassed you must ensure constant pressure and flow. Minimum flow rate is 130 ml/min with the bypass fitting.** You may also contact the factory for the FX-1000-RM rotometer for flow control.

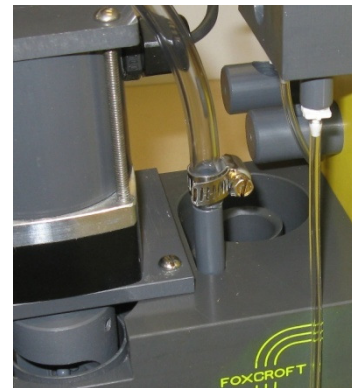

Section 8 Startup (cont.)

3. Turn on the analyzer by pressing the off/on rocker switch located on the bottom right underside surface of the analyzer enclosure.
4. The Foxcroft gray splash screen will appear as the software boots up,



followed by the Home operating screen.

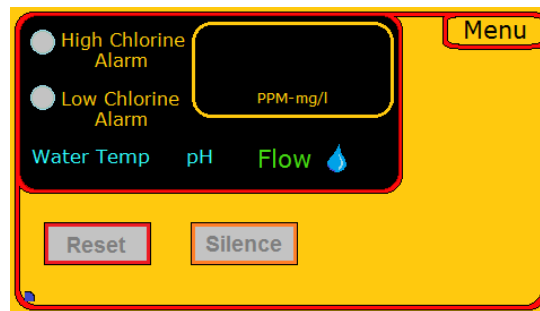

On the circuit board the heartbeat indicator below the processor will be flashing red, and the "Power On" red LED indicator will light.

The screen will display the current sample residual and water temperature. If the pH measurement option is included the sample pH will also be displayed. The heartbeat indicator will flash in the lower left corner.

5. Allow the measuring electrode to acclimate to the sample source at least several hours, ideally overnight. During this time and throughout operation do not allow the operating pressure or flow rate to fluctuate. The measured residual will increase or decrease with flow rate fluctuations.
6. After a stable residual has been displayed perform the zero point and standard set calibration as described in the Calibration section of this manual.
7. After 24 hours double check the displayed measurement and recalibrate if necessary.

Section 9 Maintenance

The FX-CL analyzer is designed to operate continuously, 24 hours a day, 365 days a year. The system requires little routine maintenance other than changing the vinegar bottle as the vinegar buffering agent becomes depleted and mandated calibration checks.

However, regular maintenance should be performed to ensure optimum performance and accuracy. Maintenance frequency required varies by water quality and the residual maintained.

The maintenance schedule below is recommended. Some applications may require more cell maintenance due to high levels of suspended solids, high calcium levels, or other characteristics of the sample liquid.

9.1 Maintenance Schedule			
	<i>Potable Water</i>	<i>Waste Water</i>	<i>Chlorine Residual 20 ppm or more</i>
<i>Visual Inspection</i>	Once per week	Once per week	Once per week
<i>Verify Calibration</i>	Once per week	Once per week	Once per week
<i>Clean the Negative Cell</i>	Every 6 months	At least once per month	Once per month if needed
<i>Install PM Kit</i>	Once per 12 months	Once per 12 months	Once per 12 months.
<i>Clean the Positive Electrode</i>	Once per 12 months if needed	Once per month if needed	Once per 12 months if needed
<i>Inspect Electric Connections for Corrosion</i>	Once per 12 months	Once per 12 months if needed	Once per 12 months if needed
<i>Clean Sample Flow Cell</i>	Once per 12 months if needed	Once per 6 months if needed	Once per 12 months if needed

9.1.1 Tools Required for Maintenance	
Small adjustable wrench	3/32" Hex Key (Allen wrench) for mixer
Medium Slotted Screwdriver	5/64" Hex Key (Allen wrench) for coupling
#2 Phillips screwdriver	Medium Scotch Brite pad
Jewelers slotted screwdriver for wiring	7/16" socket for positive electrode nut
Medium channel lock pliers	

9.2 Weekly Inspection Checklist

1. Check the condition of the negative cell to make sure the mixing balls are not becoming trapped between the mixing paddle and negative electrode. Running in this condition will damage the mixing paddle and eventually stall or damage the mixing motor.
 - Listen for a noticeably louder sound than normal from the measuring cell.
 - If the mixing balls are trapped between the mixer and negative electrode the mixing motor may stall or run in reverse.

Section 9 Maintenance

9.2 Weekly Inspection Checklist (cont.)

The presence of chlorine erodes the inner surface of the electrode, enlarging the inside diameter. The higher the residual the faster the rate of erosion will be. In typical drinking water residuals the negative electrode can last between 1-2 years depending on the aggressiveness of the water sample. Residuals of about 10ppm may require negative cell replacement every 6 months, higher residuals may require quarterly replacement.

2. Check that the buffer solution is feeding normally at the rate of one full drop every 3-4 seconds.
3. Look for blockage in the clear buffer feed tubing and fittings.
4. Check the black buffer pump tubing to see if it's flattened or worn out.
5. Make sure the occlusion ring on the buffer pump head tightens securely and squeezes the tubing.
6. Look for wear in the buffer pump head roller assembly. If the sleeve bearing is worn the roller assembly will tilt downward. You can also grab the roller assembly and try to move it up and down; if there is movement replace the peristaltic pump. Movement in and out is normal.
7. Ensure that the buffer pump is rotating smoothly.
8. Listen for abnormal sounds from the mixing motor.
9. Visually check for leaks.
10. Visually check for dirt or deposits in the flow cell, clean if needed.

9.3 Cleaning

High levels of suspended solids may collect in the bottom of the measuring cell or coat the copper electrode ring. This condition can produce a false chlorine demand and should be removed on a regular basis as dictated by the application. Solids accumulation can be reduced or eliminated by installing a flushing wye strainer in the sample line before it reaches the analyzer.

High calcium and iron levels in the sample can precipitate out onto the copper electrode ring and other surfaces contacting the sample. This can adversely affect conductivity and the accuracy of chlorine residual measurements.

Deposits can be removed with caustic or muriatic acid depending on the deposit. (Use all applicable safety procedures when using any strong acid.) Any buildup on the copper electrode ring can be removed by polishing with a medium Scotch Brite pad.

NOTE: Do not use any cleaning compounds that contain chlorine.

Section 9 Maintenance

9.4 Cleaning the Copper Electrode

Always polish the copper electrode ring whenever the electrode:

- Is exposed to the atmosphere for more than a week (oxide/tarnish buildup occurs on new or out of service systems).
- Has been used for about 12 months of normal operation (electrode usually oxidizes/tarnishes enough during this period to degrade measurement performance).
- Acquires a precipitate buildup due to sample characteristics such as high calcium hardness.

Follow these steps to clean the copper electrode.

1. Turn off the power source and stop the sample flow to the system.
2. Remove the flushing plug and allow the sample flow cell lower block to drain.
3. Disconnect the wires from the copper electrode ring and the gold electrode.
4. While holding the bottom block of the flow cell, unfasten and remove the four bottom screws of the assembly.
5. **NOTE:** *Do not loosen or remove the nut centered between the four bottom screws that fastens the positive electrode. This could damage or break the seal of the electrode that is press fit and specially sealed onto the lower block.*
6. Carefully pull the bottom block, together with the copper electrode ring, down from the top block. This should help prevent losing any of the 150 small PVC mixing balls contained within the copper ring electrode.
7. Pour the PVC balls into a container.
8. Remove and set aside the upper and lower O-ring seals. If they are damaged, replace them.
9. Use a medium Scotch Brite pad to shine the inner surface of the copper electrode ring.

Section 9 Maintenance

9.4 Cleaning the Copper Electrode (cont.)

NOTE: Do not use any commercial abrasive cleaning powders or liquids that contain chlorine. These will leave a residual coating that will adversely affect system performance.

NOTE: If the copper electrode ring is excessively scratched or has an uneven surface, it should be replaced.

10. Inspect the PVC balls for flat spots or dents. Replace any damaged balls.
11. Inspect the flow nozzle orifice for any precipitate buildup or obstructions, and clean if necessary.
12. Inspect the flushing plug orifice and check for any precipitate buildup or obstructions, and clean if necessary. Inspect the O-rings for damage and replace if needed.

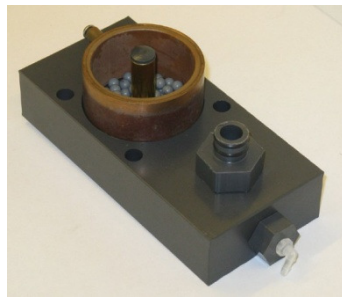

Before Cleaning

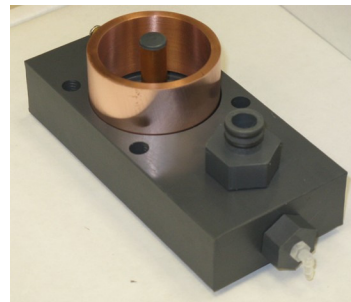

After Cleaning

13. Re-assemble the measuring cell.
14. To replace the item #31 O-rings: in the lower block for the negative cell, stretch it slightly before putting it into the block. To replace the second item #31 O-ring place it into the counter bore of the large block which covers the top of the negative cell.
15. Inset the copper negative cell into the counter bore in the lower block. Make sure the O-ring is in place.
16. Pour the new mixing balls into the negative cell.
17. Reinsert the (4) 1/4"-20 screws, tighten into the upper block just enough to keep the lower block from falling.
18. Rotate the mixer while inserting the bottom block into the top block. This ensures that no mixing balls get jammed under the mixer arms. Continue to rotate the mixer by hand until the mixer turns freely.
19. Tighten the four screws evenly. Make sure the lower block is level and parallel with the upper block.
20. Re-attach the buffer feed tubing to the fitting in the flushing plug.
21. Re-connect the signal wires to the cell unit, black wire to the copper electrode and white wire to the gold electrode.
22. Recalibrate the analyzer before returning it to service.

Section 9 Maintenance

9.5 Preventive Maintenance Kit Installation

The easiest way to install the preventive maintenance kit is to remove the analyzer from the wall and place it upside down on a table. Even with the disconnections needed to remove the analyzer you will be able to work more quickly and efficiently.

Parts Removal

1. Turn off the power source and stop the sample flow to the system.
2. Disconnect the signal wires from the positive and negative electrodes.
3. Disconnect the clear buffer feed tubing from the flushing plug.
4. If you prefer to leave the analyzer mounted on the wall follow steps 4 - 5. Otherwise go to step 7.
5. While holding the bottom block of the flow cell, remove the (4) 1/4"-20 slotted screws that fasten the lower block to the upper block.
6. Carefully pull the bottom block together with the copper electrode ring down from the top block. Be careful not to lose any of the 150 PVC mixing balls contained within the copper ring electrode. Proceed to step 14.
7. Disconnect the power cord and the signal wires at the main circuit board, and pull them out of the conduit holes.
8. Pull out the 3/8" sample supply tubing.
9. Remove the (4) mounting screws that hold the analyzer to the wall.
10. Place the analyzer upside down on a work bench or table.
11. Remove the (4) 1/4"-20 slotted screws that fasten the lower block to the upper block.
12. Lift the lower block and lay it on the table.
13. Tilt the analyzer and pour the mixing balls into a container.

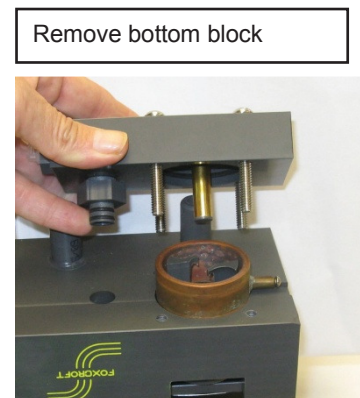
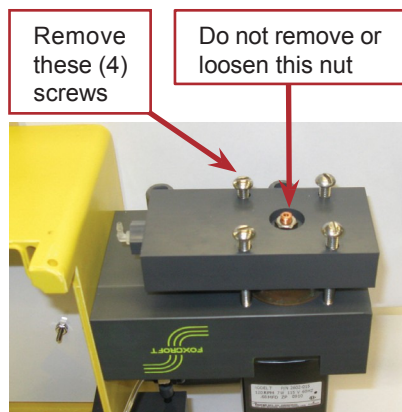

14. Remove the mixer retaining set screw with a 3/32" Allen wrench.
15. Pull out the mixer. If it's not damaged keep it for a spare.

Section 9 Maintenance

9.5 Preventive Maintenance Kit Installation (cont.)

16. Clean the upper block of any deposits. Do not use chlorinated cleansers.
17. From the lower block remove the flushing plug and flow nozzle. Clean if necessary.
18. Remove the copper negative cell and discard.
19. Inspect and clean the lower block if necessary, including the internal ports. Do not use chlorinated cleansers.
20. Check the positive electrode (gold) and clean with a soft cloth (not an abrasive cleaning pad or sandpaper) if needed. Do not loosen or remove the electrode. If the O-ring seal is broken water can seep in between the gold tube and copper stud and prevent electrode operation. The electrode is made of pure gold tubing pressed onto a copper stud and is very easily damaged, especially by over tightening the nut that secures the electrode to the block.
21. Remove all O-ring seals: (2) for the negative cell, (4) on the flow nozzle, and (2) on the flushing plug as shown below.

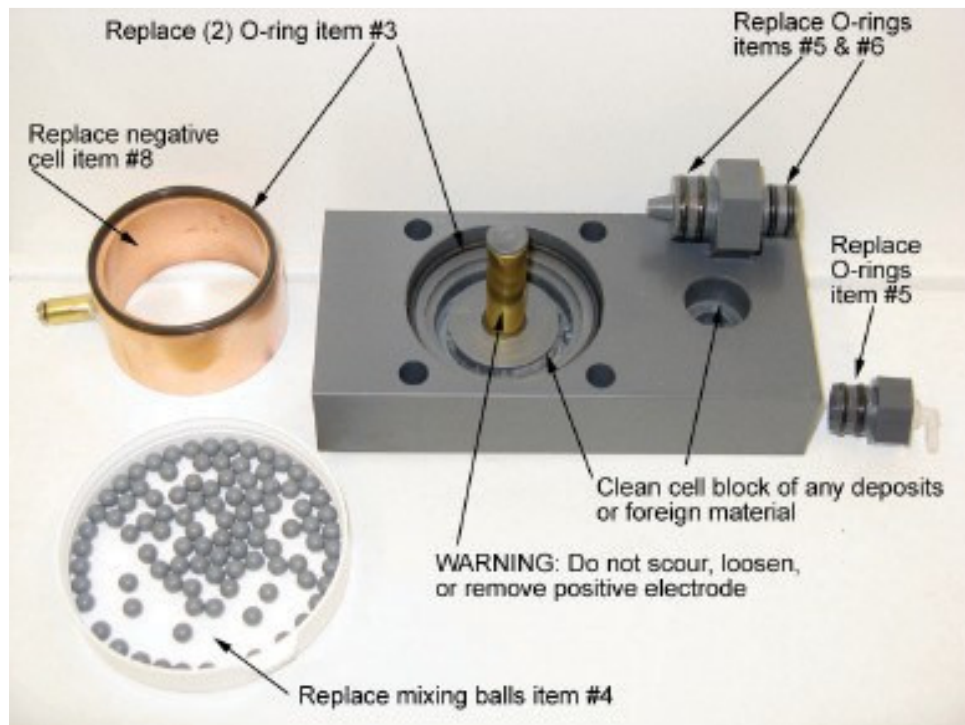

Section 9 Maintenance

9.5 Preventive Maintenance Kit Installation (cont.)

Parts Replacement

1. Replace all of the O-rings removed. A light coating of silicone grease may be applied to the O-rings.
2. To replace the item #31 O-rings for the negative electrode: stretch the O-ring slightly before putting it into the lower block. To replace the second O-ring place it into the counter bore in the large block which covers the top of the negative cell.
3. Reinsert the flushing plug and flow nozzle (tip down) into the lower block.
4. Slide the mixer onto the mixing motor shaft. Make sure the set screw lines up with the flat on the shaft.
5. To set the mixer gap place a 5/32" spacer (e.g., a drill bit) between the end of the mixer hub and the bottom of the mixing motor mounting plate. Tighten the set screw in the mixer firmly.
6. Inset the copper negative cell into the counter bore of the large block. Make sure the O-ring in the block is in place.
7. Pour the new mixing balls into the negative cell.
8. Making sure the item #31 O-ring in the lower block is in place, place the lower block onto the negative cell, push the block down until the negative cell and flow nozzle are seated with the upper block. When the flow nozzle is completely inserted into the upper and lower blocks you will still see a 1/16" gap above and below the hex portion of the nozzle.
9. Reinsert the (4) 1/4"-20 screws, tighten evenly and firmly; do not over-tighten to avoid stripping the threads in the upper block. Make sure the lower block is level and parallel with the upper block.

Re-assembling the bottom block if the analyzer is mounted on the wall:

10. Rotate the mixer while inserting the bottom block into the top block. This ensures that no mixing balls get jammed under the mixer arms. Continue to rotate the mixer by hand until mixer turns freely. Insert the four mounting screws, tighten evenly and firmly. Rotate the mixer to be sure it is rotating freely. Make sure the lower block is level and parallel with the upper block.
11. Re-attach the buffer feed tubing.
12. Re-mount the analyzer on the wall.
13. Re-connect the signal wires to the cell unit, black wire to the copper electrode and white wire to the gold electrode.
14. Remove and install new buffer pump tubing, see the following page.

Section 9 Maintenance

9.5 Preventive Maintenance Kit Installation (cont.)

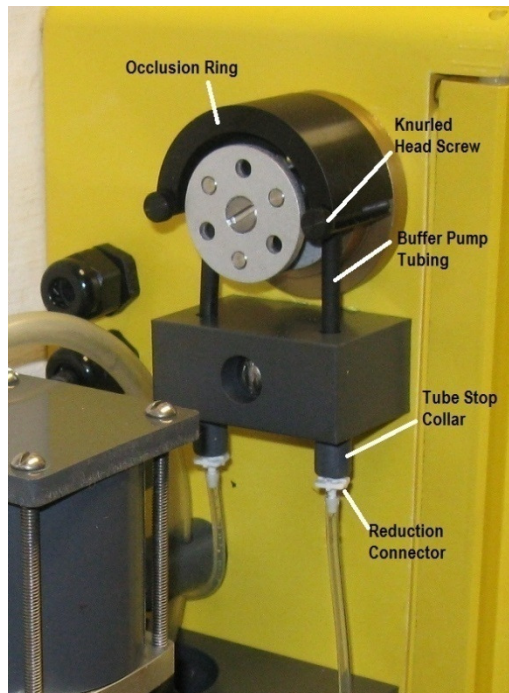

15. Unfasten the knurled head screw and swing open the curved occlusion ring, exposing the three pump rollers.
16. Disconnect and remove the two pieces of 1/8" diameter clear tubing with reduction connectors from the black buffer tubing and remove the tube stop collars.
17. Remove the buffer feed tubing and route the new piece around the three rollers and through the holes in the buffer tube holder. Position it centrally (front to rear) on the rollers.
18. Close the curved occlusion ring over the tubing, slightly compressing the tubing onto the pump rollers. Secure the ring by finger tightening the knurled-head screw.
19. Place the tube stop collars onto the buffer tubing.
20. Insert the white reduction connector fittings into the black buffer tubing. They can be difficult to insert, but do not use any lubricant on the white reduction connectors.
21. Connect the new piece of 1/8" diameter x 9" long clear buffer tubing to the left end of the black buffer tubing and to the flushing plug.
22. Connect the new piece of 1/8" diameter x 5-ft long clear tubing for the vinegar bottle to the fitting in the flushing plug. Place the other end of the tubing with new blue bottle cap and new sinker into the vinegar bottle and secure the cap.
23. Recalibrate the analyzer before returning it to service.

Section 9 Maintenance

9.6 Mixer Paddle Installation & Gap Adjustment

Maintaining the proper clearance between the bottom tips of the mixer and the floor of the sample cell is critical to prevent premature mixing motor failure.

If the gap is too high the mixing balls can become jammed under the tips of the mixer. If the mixer is set too low it will rub against the floor of the sample cell. Either situation can damage the mixing motor. Intermittent mixer motor stopping or reversal can be a symptom of these problems.

These same symptoms can also be caused by a worn copper ring, where the wall thickness has diminished such that the mixing balls get jammed between the side of the mixer and the inside wall of the copper ring. This latter condition would require replacement of the copper ring, in addition to the gap adjustment described here.

The mixer clearance gap must be checked and adjusted to $5/32$ " whenever any integral part of the sample cell has been replaced such as the mixing motor and the copper ring.

1. Turn off the power source and stop the sample flow to the system.
2. Remove the (3) screws that secure the mixing motor mounting plate to the flow cell block.
3. Remove the mounting plate with the lower half of the motor and mixing paddle attached.
4. Remove the mixing paddle with a $3/32$ " hex key (Allen Wrench) and discard.
5. Attach the mixer paddle and tighten the set screw securely against the flat on the motor shaft, ensure there is a $5/32$ " space between the top of the mixer and the mixing motor mounting plate as shown below. You can use a $5/32$ " drill bit to set the proper spacing.

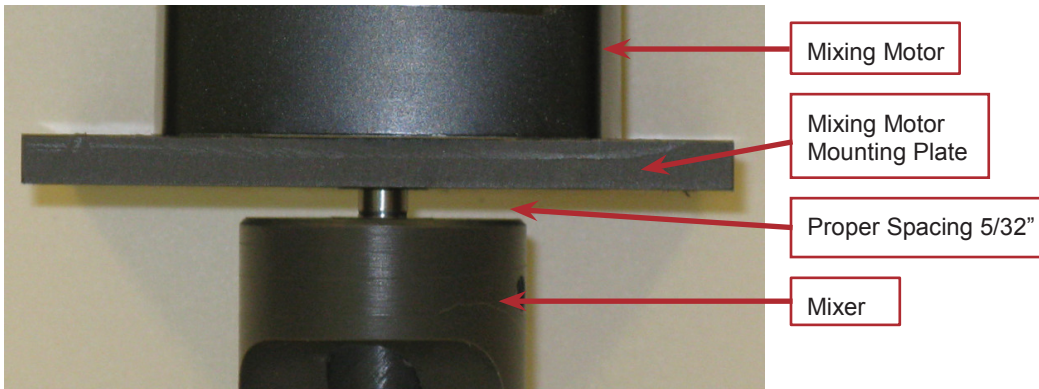

NOTE: The mixer tips should be just above the top surface in the measuring cell within the lower block to prevent rubbing, and high enough to prevent mixing balls from becoming trapped.

6. Re-insert and tighten the (3) mounting plate retaining screws.

Section 9 Maintenance

9.7 Mixing Motor Replacement

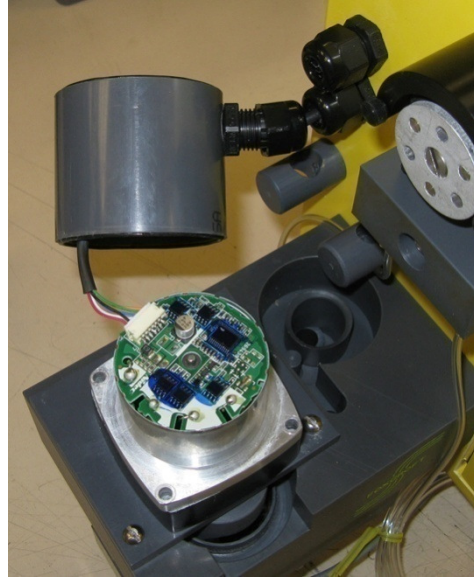

Disassembly

1. With the power turned off remove the four screws that retain the mixing motor guard, remove the square cap. Loosen the cable grip nut so that the cable can be pulled through for handling ease.
2. Pull the cable through the round motor guard, and slide the guard back away from the motor.
3. Grab the tabs on the white cable connector and pull off the connector.

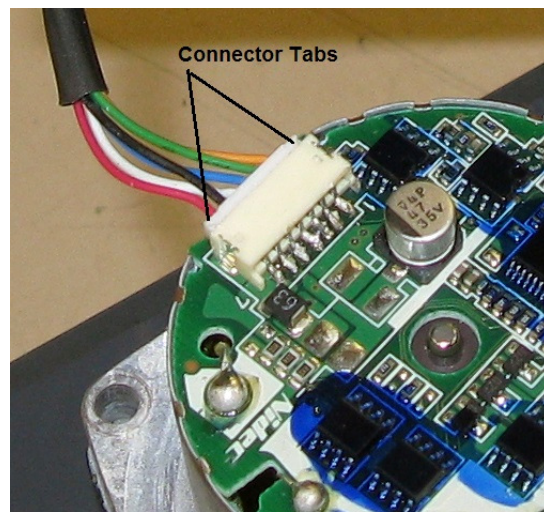

Section 9 Maintenance

9.7 Mixing Motor Replacement (cont.)

4. Set the round motor guard aside and discard the motor top half.
5. Remove the (3) screws that secure the mixing motor mounting plate to the flow cell block.
6. Remove the mounting plate with the lower half of the motor and mixing paddle attached.
7. Remove the mixing paddle with a 3/32" hex key (Allen Wrench) and set aside.
8. Note the orientation of the motor to the mounting plate, then remove the (2) screws from the underside of the mounting plate that retains the motor. Discard the motor.

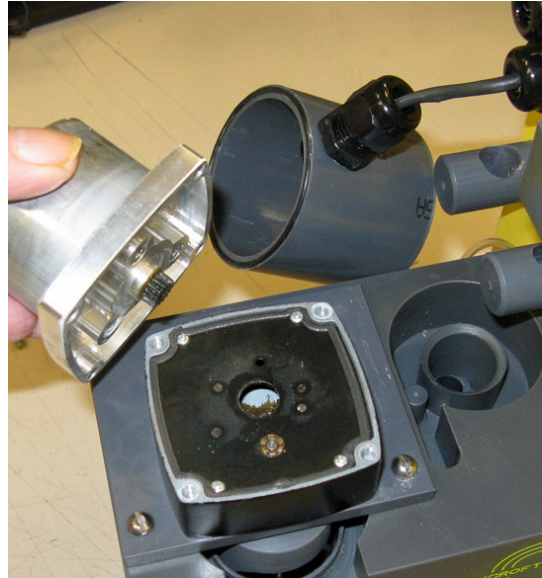

Assembly

9. Replace the (4) screws that hold the motor halves together with the 8-32 x 3" screws supplied with the analyzer that retain both the guard and the motor.
10. Secure the bottom half (gear head) of the new motor to the mixing motor mounting plate.
11. Attach the mixer paddle and tighten the set screw securely, ensure there is a 5/32" space between the top of the mixer and the mixing motor mounting plate as shown below. You can use a 5/32" drill bit to set the proper spacing.

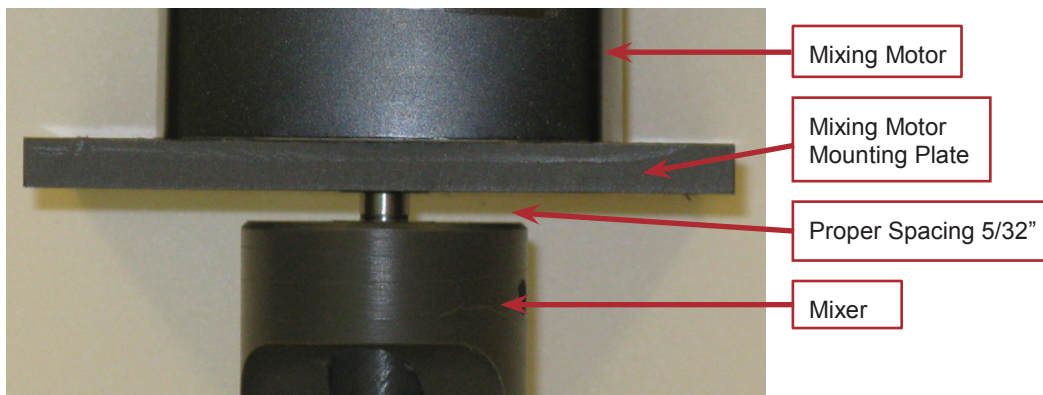

12. Lower this assembly with mixer into the measuring cell. Rotate the mixer while lowering until the mounting plate sits flat on the large flow cell block.

Caution: Make sure there are no mixing balls trapped underneath the mixing paddle.

Section 9 Maintenance

9.7 Mixing Motor Replacement (cont.)

13. Make sure the mixer rotates freely, re-insert and tighten the (3) mounting plate retaining screws.
14. Pull the cable through the hole in the round motor guard and plug the cable connector into the receptacle on the new motor. The solid white surface of the connector should face up to match the receptacle.
15. Place the top half of the new motor and round guard onto the bottom half of the motor. Make sure the O-rings are in place on the top and bottom of the guard.
16. Place the square motor guard cap on top of the motor, re-insert the (4) retaining screws and tighten so as not to squeeze out the O-rings.

9.8 Temperature Sensor Replacement

The thermistor is located in the sample weir large block between the overflow and the port that leads to the lower block.

1. Open the analyzer door and remove the protective cover plate.



CAUTION: the printed circuit board is sensitive to Electro-Static Discharge. It can be irreparably damaged by static electricity, causing partial or total operational failure. You must take the following precautions before touching or making any connections to the circuit board

2. Touch a grounded metallic object to discharge any static electricity. Disconnect the Clear, Black and White leads from terminal block TB13. See section 4.42 Temperature Sensing Element Wiring.
3. Loosen the cable gland and pull the leads out of the analyzer enclosure.
4. Pull the thermistor out with pliers.
5. Feed the wire leads of the new thermistor down through hole.
6. Put a light bead of silicone caulk around the bottom lip of the new thermistor and press into place.
7. Touch a grounded metallic object to discharge any static electricity and reconnect the leads per the photo and chart in section 4.42.

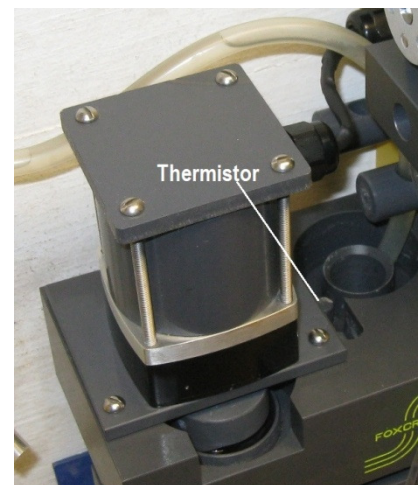

Section 9 Maintenance

9.9 Buffer Pump Tubing Replacement

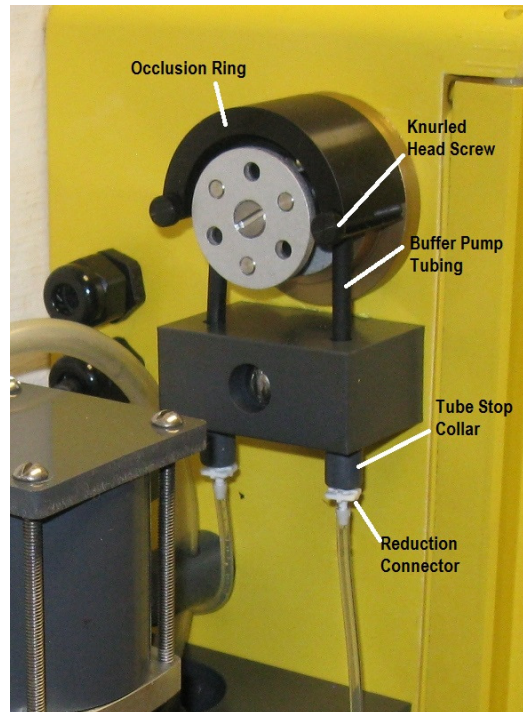

1. Unfasten the knurled head screw on the pump and swing open the curved occlusion ring, exposing the three pump rollers.
2. Remove the white reduction connectors and tube stop collars from the black buffer tubing.
3. Remove and discard the black buffer tubing.
4. Thread the 9" long piece of new buffer tubing through the buffer tube holder and around the three rollers on the buffer pump.
5. Place the tube stop collars onto the buffer tubing.
6. Insert the white reduction connector fittings into the black buffer tubing. They can be difficult to insert, but do not use any lubricant other than water on the connectors.
7. Connect one end of the 9" long piece of clear 1/8" diameter tubing to the left end of the buffer tubing, and the other end to the fitting in the flushing plug in the lower block.
8. Connect one end of the 5-ft long piece of clear 1/8" diameter tubing to the right end of the black buffer pump tubing.
9. Center the black tubing on the pump head rollers. Gently pull both ends of the tubing to remove any slack.
10. Close the curved occlusion ring and secure it by finger tightening the knurled head screw.

Section 9 Maintenance

9.10 Buffer Pump Head Replacement

The pump motor is linked internally to the peristaltic pump via a brass coupling with a slot in the end. The slot matches up with a drive pin that runs perpendicularly through the pump shaft.

If the brass coupling is mounted on the shaft too close to the motor gearbox, it could bind on the back of the pump head, or the drive pin could bind on the bottom of the brass coupling end slot.

1. Turn off power to the analyzer.
2. On the pump head loosen the knurled head screw and flip open the occlusion ring.
3. Slide the buffer pump tubing off of the roller assembly.
4. Open the enclosure door and remove the thumbnuts and main circuit board cover plate.
5. Touch the pump motor case or a grounded object to discharge any static electricity.

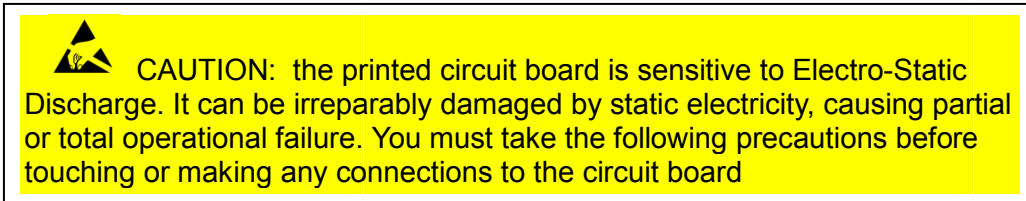

6. Remove the white cable connector from the pump motor
7. Remove the two slotted/Phillips head screws that hold the motor to the mounting block and remove the motor with coupling.
8. Loosen the (2) #4-40 x 7/8" flat head screws that secure the peristaltic pump head and remove the pump.
9. Insert the new pump head through the 7/8" diameter hole in the enclosure.
10. Ensure that the drive pin in the pump head will align with the slot in the coupling and re-insert the motor and coupling assembly.
11. Re-insert the motor mounting screws and tighten lightly.
12. To make sure the coupling is engaged and the pump will turn freely, use a slotted screwdriver to turn the screw in the face of the pump. The pump will be somewhat difficult to turn because of the gear reduction in the motor gearbox. If the coupling slot and drive pin in the pump weren't aligned, you may hear a "click" and feel the pump move in as they align and engage.
13. If the pump turns freely, finish tightening the pump motor mounting screws.
14. Connect the white cable connector to the receptacle in the pump motor.
15. Place the buffer pump tubing over the pump rollers and center.
16. Close the occlusion ring and fasten with the knurled head screw.

Section 9 Maintenance

9.11 Buffer Pump Coupling & Motor Replacement

1. Turn off power to the analyzer.
2. Open the enclosure door and remove the thumbnuts and main circuit board cover plate.
3. Touch the pump motor case or a grounded object to discharge any static electricity.

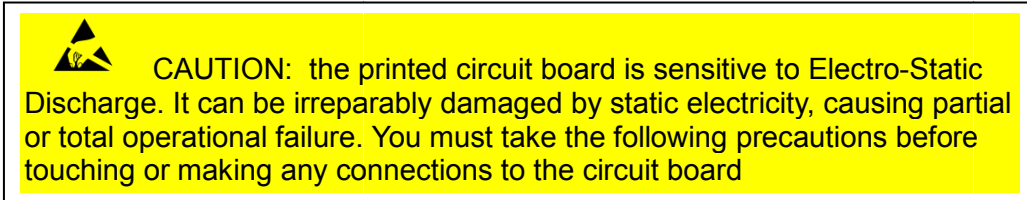

4. Remove the white cable connector from the pump motor
5. Remove the two #8-32 x 1-1/2" slotted head screws that hold the motor to the mounting block (these are the screws in the top left and bottom right corners when looking at the end of the motor) and remove the motor with coupling.
6. Use a 5/64" hex key (Allen wrench) to remove the coupling set screw.
7. Insert a new coupling onto the motor shaft leaving a 1/16" space between the back of the coupling and the motor hub as shown below and tighten the set screw.

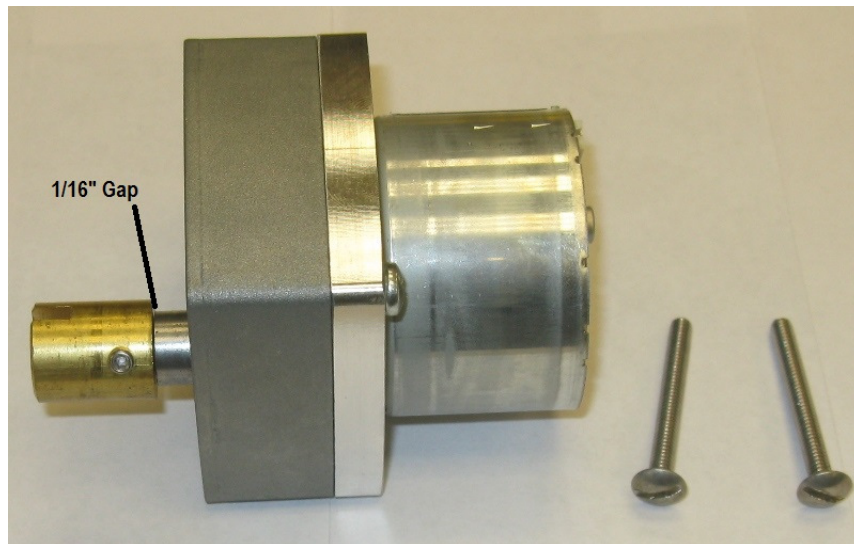

Section 9 Maintenance

9.11 Buffer Pump Coupling & Motor Replacement (cont.)

8. Ensure that the drive pin in the pump head will align with the slot in the coupling and re-insert the motor and coupling assembly.
9. Re-insert the motor mounting screws and tighten lightly.
10. To make sure the coupling is engaged and the pump will turn freely, use a slotted screwdriver to turn the screw in the face of the pump. The pump will be somewhat difficult to turn because of the gear reduction in the motor gearbox. If the coupling slot and drive pin in the pump weren't aligned, you may hear a "click" and feel the pump move in as they align and engage.
11. If the pump turns freely, finish tightening the pump motor mounting screws.
12. Connect the white cable connector to the receptacle in the pump motor. The solid white surface should be up, to match the receptacle.

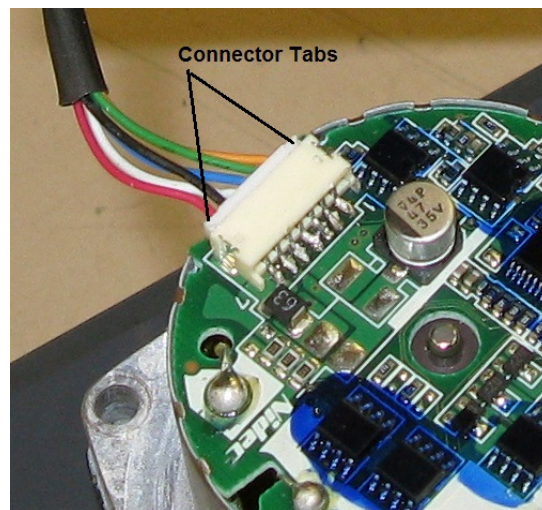

Section 9 Maintenance

9.12 Positive Electrode Replacement

The positive electrode consists of a 99.95% pure gold tube pressed onto a copper stud and sealed with solder. Being so pure, the gold tube is extremely soft and malleable. It will become distorted if the retaining nut is tightened more than is recommended. It is also subject to heat deformation. Always use extra care when working with the electrode.

1. Turn off power to the analyzer.
2. While holding the bottom block of the flow cell, remove the (4) 1/4"-20 slotted screws that fasten the lower block to the upper block.
3. Carefully pull the bottom block together with the copper electrode ring down from the top block. Be careful not to lose any of the 150 PVC mixing balls contained within the copper ring electrode. Pour the PVC balls into a container.
4. If replacing the electrode only, unscrew the retaining nut that holds the electrode with a 7/16" socket. **Note that the threads are left hand, turn clockwise to loosen.**
5. Pull out the electrode and O-ring and replace with new parts.
6. Tighten the retaining nut only until it touches the lower block. Turn an additional 3/4 turn more and stop.

CAUTION: Over tightening the retaining nut will distort and destroy the positive electrode.

7. If replacing the entire lower block and positive electrode, assemble the existing flushing plug, negative cell, negative cell O-rings, and flow nozzle to the new lower block.
8. To re-install, rotate the mixer while inserting the bottom block into the top block. This ensures that no mixing balls get jammed under the mixer arms. Insert the four mounting screws, tighten evenly and firmly. Rotate the mixer to be sure it is rotating freely. Make sure the lower block is level and parallel with the upper block.
9. Re-attach the buffer feed tubing.
10. Re-connect the signal wires to the cell unit, black wire to the copper electrode and white wire to the gold electrode.

Section 10 Troubleshooting

Problem	Probable Cause	Corrective Action
Residual fluctuates	Inconsistent flow and or pressure Improper disinfectant mixing Positive electrode damaged, poor cable connection, ground loop in mA signal	Ensure flow and pressure is regulated per specifications. Improve mixing or move the sampling point. Replace the positive electrode. Clean the cable connection. Isolate SCADA/PLC mA inputs
Residual doesn't match test kit	Insufficient time for cell to acclimate, improper calibration, high cell pH, dirty electrodes, debris in measuring cell, dirty sample supply line, interfering compounds	Allow more time for cell to acclimate, recalibrate, check vinegar feed, clean system to eliminate chlorine demand. Eliminate or filter interferences
No or low residual	Poor electrode connections No flow to the measuring cell due to bubble blockage or flow is too low Cell pH is too high Electrodes are dirty or coated Faulty test meter or reagents	Clean connections and tighten Install the flow bypass fitting or FX-1000-RM rotometer. Check for blockage in buffer feed tubing and fittings. Replace worn buffer pump tubing or pump. Increase buffer feed rate or use higher concentration vinegar Clean the electrodes Verify testing method & reagents
Cell pH is too high / above 5.5 pH	Blockage in buffer feed tubing and fittings. Worn buffer pump tubing Worn buffer pump and or motor Sample pH and alkalinity is too high for standard 5% vinegar	Clean & disinfect tubing and fittings in a chlorine solution. Replace tubing Replace buffer pump and or motor Increase buffer feed rate or use higher concentration of vinegar
Sluggish, slow reaction to residual changes	Coating on the electrodes, dirt in the measuring cell pH is above 5.5	Clean the electrodes and measuring cell. See "cell pH is too high"
Mixing motor stalls, mixing paddle is scored on the sides, unusual noise in measuring cell	Hole in negative cell is enlarged, trapping the mixing balls between mixing paddle and negative cell	Replace negative cell. Replace damaged mixer and deformed mixing balls
Mixing motor stalls, mixing paddle tips are broken, scoring on lower block	Mixing paddle set too high	Set gap between mixer and mixing motor mounting plate to 5/32"
Mixing motor is noisy	Negative cell is worn, motor lacks lubricant, motor worn	Replace negative cell, motor, damaged mixer and mixing balls
Vinegar depletes too quickly	Occlusion ring not set or loose Worn pump head Vinegar bottle mounted too high	Secure the occlusion ring Replace buffer pump head See installation instructions
Insufficient vinegar feed	Blockage in tubing & fittings Worn buffer pump and or tubing	Clean and disinfect, do no re-use vinegar bottles Replace buffer pump / tubing
Display is blank	Display failure Main circuit board failure	If main card heartbeat is flashing replace display. If main card heartbeat is not flashing replace card. Replace display if still blank with new card installed.

Section 11 Parts List

11.1 Items in Preventive Maintenance Kit 100-100P-2007-1

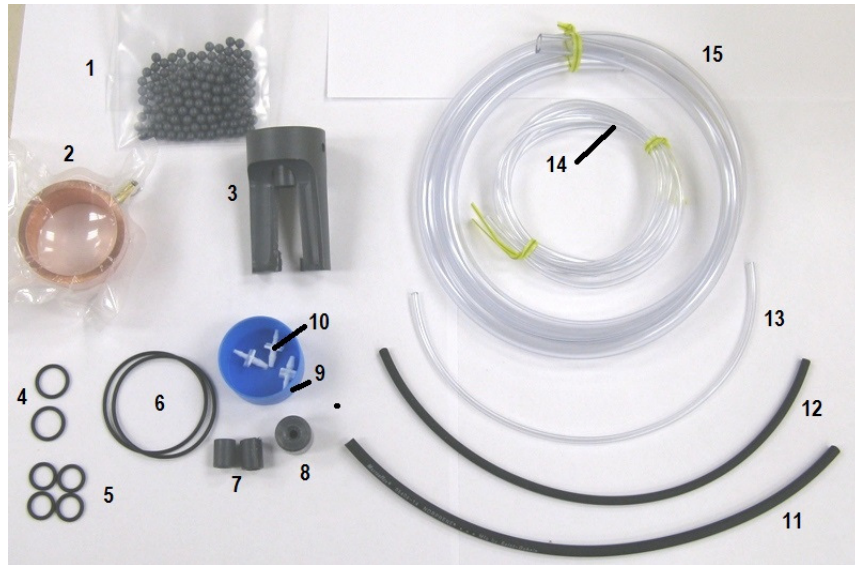

Item	Description	Part No.
1	Mixing balls, 150 pcs/bag	119-0371-0001-1
2	Negative cell	159-0263-0001-2
3	Mixer (paddle)	300040
4	#14 O-ring, 2 pcs.	129-0014-0001-1
5	#12 O-ring , 4 pcs.	129-0012-0001-1
6	#31 O-ring, 2 pcs.	129-0031-0121-1
7	Stop collar, buffer pump tubing	120-6072-0001-2
8	Sinker, buffer feed tubing	120-6072-0002-1
9	Bottle cap, vinegar bottle	177-1828-0009-1
10	Reduction connector fittings	130-0266-0016-1
11	#14 Buffer pump tubing x 9" lg.	130-0488-1400-2
12	#13 Buffer pump tubing x 9" lg.	130-0488-1300-2
13	Buffer feed tubing, 1/8" OD x 9" lg	130-0488-1200-1
14	Buffer feed tubing, 1/8" OD x 5-ft llg	130-0488-1205-1
15	Sample tubing 3/8" OD	130-1438-0001-1

11.2 Items in Preventive Maintenance Kit 100-100B-0000-2

Item	Description	Part No.
1	Mixing balls, 150 pcs/bag	119-0371-0001-1
2	Negative cell	159-0263-0001-2
3	Mixer (paddle)	300040
4	#14 O-ring, 2 pcs.	129-0014-0001-1
5	#12 O-ring , 4 pcs.	129-0012-0001-1
6	#31 O-ring, 2 pcs.	129-0031-0121-1
15	Sample tubing 3/8" OD	130-1438-0001-1

Section 11 Parts List

11.3 Wet Cell Parts

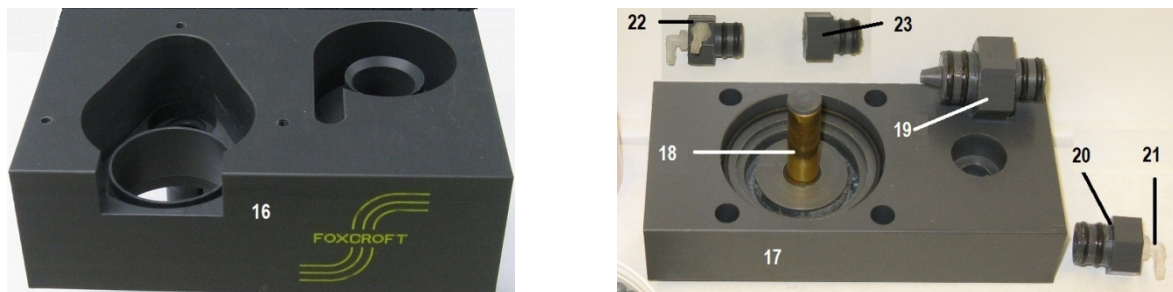

Item	Description	Part No.
16	Top block (sample inlet weir)	300102
17	Lower block	162-0441-0121-2
18	Positive electrode	300104
	Signal cable (not shown)	300100
19	Flow Nozzle (shown w/ #12 & #14 O-rings)	130-0488-0010-1
20	Flushing Plug (shown w/ #12) rings	113-0472-0121-1
21	Buffer input fitting	130-0266-0014-2
22	Flushing Plug for double pump analyzer	113-0472-0002-2
23	Flushing Plug for bufferless analyzer	113-0472-0003-3

11.4 Mixer Motor Parts

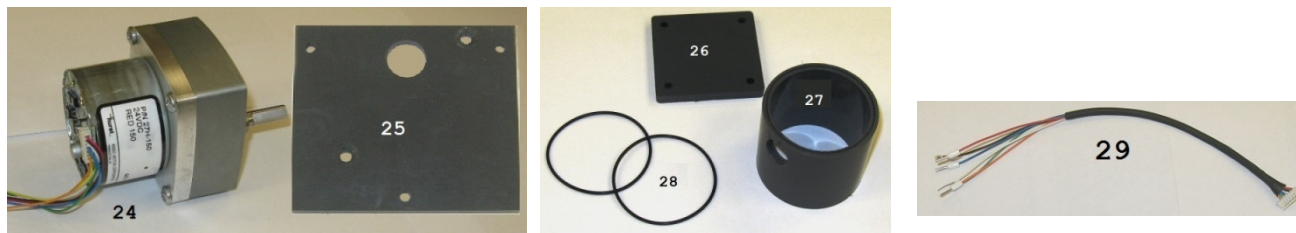

Item	Description	Part No.
24	Mixing motor (cable not supplied)	300020
25	Mixing motor mounting plate	158-0439-0002-1
	Mixing motor guard assembly	300030
26	Mixing motor guard cap	300029
27	Mixing motor guard	300028
28	Mixing motor guard O-rings	300027
	Mixing motor guard screws, 3" long	300026
29	Mixing motor cable	300021

Section 11 Parts List

11.5 Buffer Feed Parts

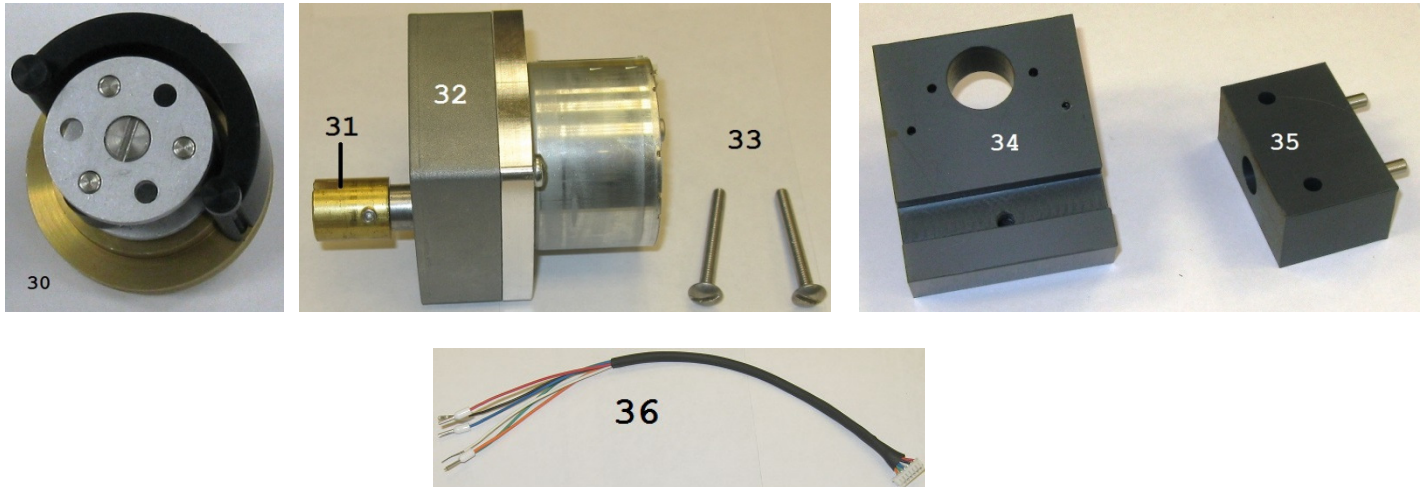

Item	Description	Part No.
30	Buffer (peristaltic) pump head less motor & coupling	257-1000-0003-2
31	Coupling	300004
32	Buffer pump motor, less cable	300001
33	Pump motor screws	300002
34	Pump motor mounting block	158-0730-0121-1
35	Buffer pump tubing holder/guide	257-1110-0121-2
36	Pump motor cable	300003

11.6 Electronics Items (not pictured)

	Description	Part No.
	Touch Screen Display	400001
	Display Cable	400002
	Circuit Board	400003
	Power Supply	400004
	Power Cable	400005

Section 12 Service Contact, Return Policy

Customer Service Department

If you need spare parts, assistance in troubleshooting, or repair service, please contact Foxcroft Customer Service at:

Foxcroft Equipment and Service, Co. Inc.
2101 Creek Road, P.O. Box 39
Glenmoore, PA 19343

Tel: (800) 874-0590
(610) 942-2888
Fax: (610) 942-2769
Email: service@foxcroft.com
Website: www.foxcroft.com

Customer Repair / Returns Policy

All systems returned for repair or replacement must be freight prepaid and include the following information:

1. A clearly written description of the malfunction.
2. Name of person to contact and the phone number where they can be reached.
3. Proper return address for shipping system back. Include preferred shipping method.
4. A purchase order if the system is out of warranty to cover costs of repair.
5. A Return Material Authorization Number (RMA) is required before shipping any products for service. Call telephone number above to receive a RMA number.

NOTE: *Returns will only be held at Foxcroft for 90 days. If a decision is not made regarding the repair, the product will be returned.*

Section 13 Product Warranty

Foxcroft Equipment & Service warrants all products obtained hereunder to be free from defects in material and workmanship for a period of one year from the date of shipment. In the event of a product failure or defect requiring warranty repair, the customer must obtain an RMA number by calling 1-800- 874-0590, before returning the product, at the customer's expense to Foxcroft for repair. Warrantor (Foxcroft Equipment and Service) will repair the unit, without charges for parts, labor and return freight.

Foxcroft Equipment & Service is not responsible for damage to its products through improper installation, maintenance, act of God, use or attempts to operate such products beyond their functional capacity, intentionally or otherwise, or for any unauthorized repair.

Buyer agrees to hold Foxcroft Equipment & Service harmless from all claims for damages arising out of injury or death to any person or damage to any facility, or any other property, or loss of use of any such property, whether such person or property is on or off the installation or activity site for which the equipment or material furnished hereunder is destined and whether such damage, loss destruction or loss of use, injury or death results directly or indirectly from a nuclear incident or for any other cause.

Statements and instructions set forth herein are based upon the best information and practices known to Foxcroft Equipment & Service but it should be assumed that every acceptable safety procedure is contained herein. Of necessity this company cannot guarantee that actions in accordance with such statements and instructions will result in the complete elimination of hazards and it assumes no liability for accidents that may occur.



Serial Number Label for FX-CL
Amperometric Chlorine Residual Analyzer

Foxcroft Equipment & Service Co. Inc.
2101 Creek Road, P.O. Box 39
Glenmoore, PA 19343

Tel: (800) 874-0590
(610) 942-2888
Fax: (610) 942-2769
Email: service@foxcroft.com
www.foxcroft.com