

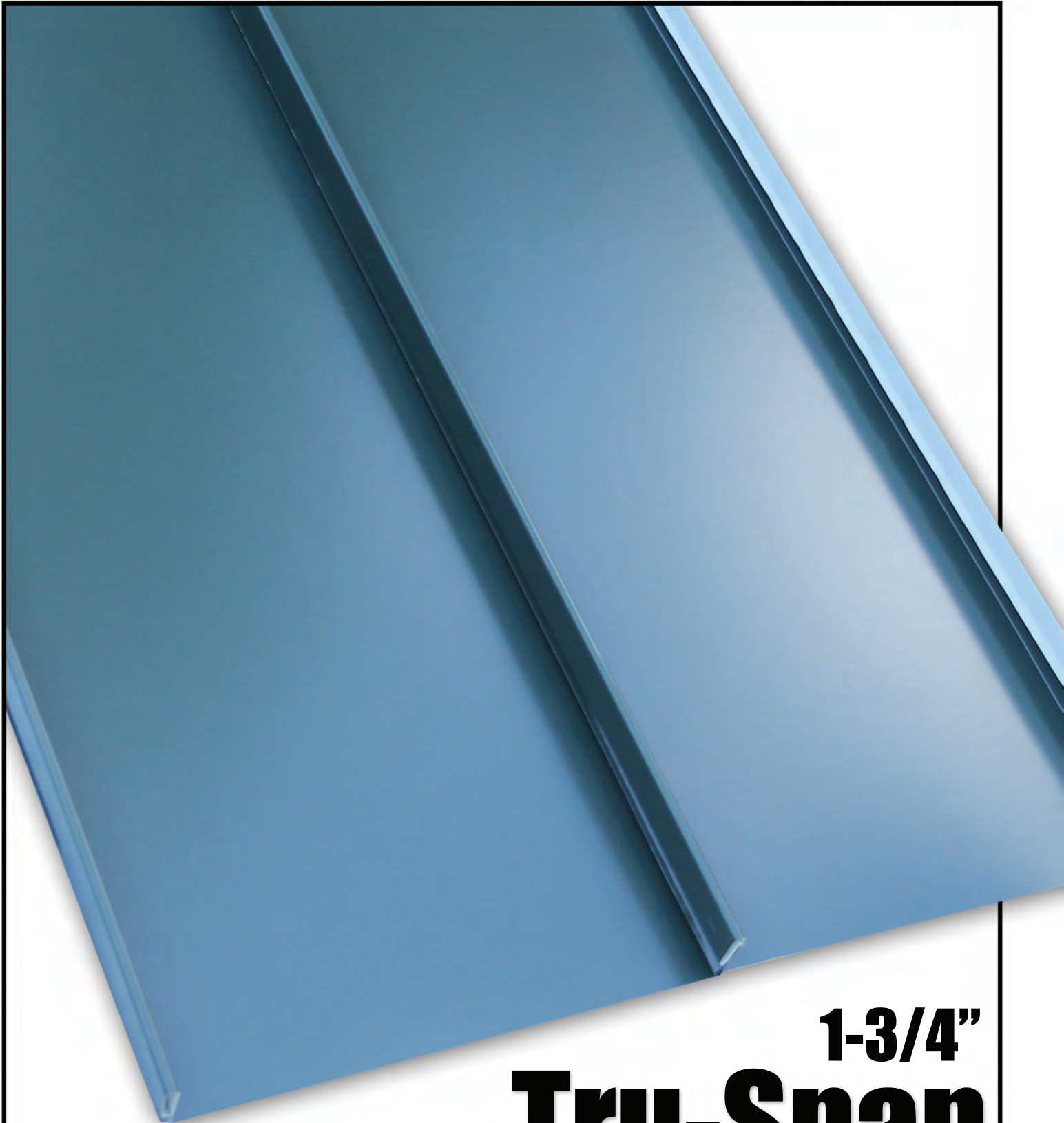

BRIDGERSTEEL
CREATE LASTING BEAUTY



1-3/4"

Tru-Snap

www.bridgersteel.com

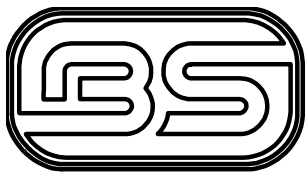

BRIDGERSTEEL

CREATE LASTING BEAUTY

Table of Contents

General Notes

| | |
|---|-------|
| Handling and Storage | 1 |
| Tools and Equipment, Field Cutting Panels | 2 |
| Safety | 3 |
| Preparing to Install your New Roofing | 4 |
| Reroofing Existing Structures | 5 |
| Panel Installation | 6 |
| Fastener Installation | 7 |
| Roof Maintenance | 8-9 |
| Panel Profiles | 10-11 |
| Panel Profile / Panel Laps | 12 |
| Flashing Profiles | 13 |

Flashing Details

| | |
|--------------------------------|-------|
| Vented Ridge Cap | 14 |
| Non-Vented Ridge Cap | 15 |
| Hip - Ridge | 16 |
| 2 x 6 Top Cap | 17 |
| 2 x 4 Top Cap | 18 |
| 2 x 6 Gable | 19 |
| 2 x 4 Gable | 20 |
| 2 x 4 Eave | 21 |
| 2 x 6 Eave | 22 |
| Style D Eave | 23 |
| Fascia Trim | 24 |
| F & J Style Trim / 1/2" J Trim | 25 |
| Endwall | 26 |
| Sidewall | 27 |
| Snow Break | 28 |
| Inside Corner | 29 |
| Outside Corner | 30 |
| Base Trim | 31 |
| Transition Low - High | 32 |
| Transition High - Low | 33 |
| 28" W-Valley | 34 |
| Prow Gable | 35 |
| Overall Dormer | 36 |
| Dormer Tie-Ins | 37-38 |

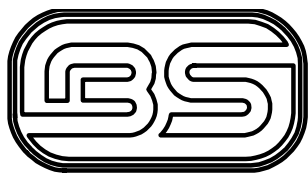

BRIDGERSTEEL
CREATE LASTING BEAUTY

Congratulations on your Customized Metal Package from Bridger Steel! We hope we have helped you *Create Lasting Beauty*

When picking up or receiving your metal package check the parts you received against the invoice. If there are any discrepancies notify Bridger Steel Personnel right away.

Handling

Handle your panels and trim with care to avoid damage. Longer panels may need more than one pickup point when lifting on or off a trailer. Trim bundles can be heavy and awkward. Don't lift more than you can safely handle. Break open the bundle if needed.

Storage

Bridger Steel recommends you should have your structure built before ordering metal. With actual building measurements, your materials can then be ordered. Because of our quick turnaround time you will have the material in a matter of one to three days. The longer the metal package is stored at your work site, the more opportunity for damage to occur.

If for some reason you cannot install the metal right away, proper storage is a must. Store metal panels and other materials in a covered, dry, well ventilated area ensuring moisture and direct sunlight are kept away from panels. If stored outside, wrap a tarp loosely around the panel bundles so air can circulate freely to avoid moisture build-up. One end of the bundle should be elevated so any accumulated moisture can run off. Never store materials in direct contact with the ground. The trim package you receive has a protective plastic film on it. The film should be removed within 90 days.

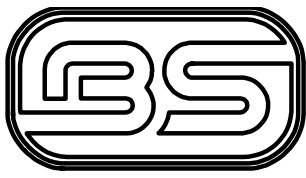

Tools and Equipment

- Screw Gun
- Tin Snips
- Tape Measure
- Pop Rivet Tool
- Chalk Line
- Hemming Tool
- Locking Pliers
- Nibbler
- Circular Saw*

****When using a circular saw to cut metal panels, always cut from the back side of the metal panel to keep the metal shavings from marring the paint. Always wear hearing and eye protection when using saws to cut metal.***

Field Cutting panels

Tin snips or nibblers are recommended for cutting metal panels and trim. All cut metal shavings should be removed from the panel to prevent damage to the finish. One way to prevent shavings on the finish side of the panel is to cut from the primer side of the panel. Never cut panels on top of existing panels. Always wear gloves and eye protection when cutting metal panels. If using a circular saw always wear hearing protection! All installed products should be wiped free of any debris at the end of each workday.

CAUTION! Clean all metal shavings and particles off of roof to avoid unsightly rust stains.

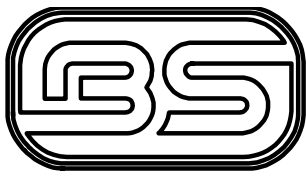

Safety

Safety is always your first consideration when installing your metal package. Hazards exist on the ground as well as on the roof.

- Always be aware of where you are on the roof. Openings, edges, electrical lines and tripping hazards (cords and equipment) are a constant danger.
- Watch electrical lines when maneuvering panels.
- Never install metal roofing on windy or stormy days. The wind can get under the panel and force you off the roof. Once the panel is loose and airborne it can become a sharp projectile.
- Roofing can be very slick when dusty, wet, or covered with frost. Avoid being on the roof when these conditions are present.
- Never step on panels until they are in place and secured with fasteners. Then only step in the flat areas and not on the panel ribs.
- Wearing soft soled shoes will help with traction while preventing scratching the panels.
- Use fall protection where needed.
- Be aware of your coworker. Make sure they are not putting themselves in danger.
- If your building has an open purlin system make sure to walk on the purlin not in between the purlin this may result in injury.

Preparing to Install Your New Roofing

Bridger Steel quality light gauge material can be used for new or existing structures.

Prepping New Construction

1. If you need openings cut for venting through the ridge or plumbing vents or electrical conduits, now is the time to add them before panel installation.
2. It is very important to check for protruding nails and other objects which may puncture the underlayment and roofing panels. Be sure to clean all foreign materials from the roof.
3. Cover the deck with a moisture barrier such as a minimum 30 # pound felt or other approved underlayment. Begin at the eave and roll the underlayment horizontally (along the eave). Overlap the next strip at least 3 inches. (Place a hi-temp ice & water membrane underlayment in areas which snow, ice, and rain can accumulate, such as valleys and eaves. This will be applied to the roof before rolling the 30 # felt out).
4. Place an alignment line along the gable end where the first panel will be installed. This line must be parallel to the gable edge of the roof and square with the eave edge. Check the roof for squareness by making a 3 foot line across the eave. (See illustration) Completing the 3' x 4' x 5' triangle should place the 4' line parallel along the gable edge. The first panel will be placed along this line. Any out of square conditions up to 3" can be covered by the gable trim.

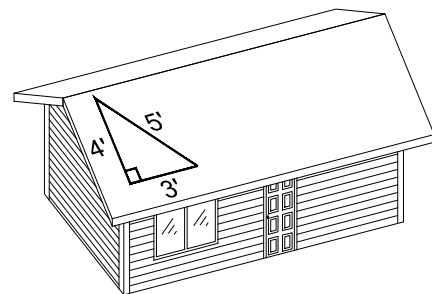

It is important to measure the roof from gable to gable. Proper placement of panels will allow the panel ribs on each side to be covered by the gable trim while creating a symmetrical appearance on the roof.

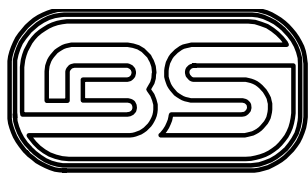

Reroofing Existing Structures

It's best if existing roofing such as shingles, cedar shakes be removed so there is a smooth flat substrate for installing metal roofing panels. Metal roofing should never be installed over an uneven surface.

Another good reason for stripping a roof is to look for any defects which need repair or replacement.

Never apply metal roofing over a damaged substrate.

(If you are going to strip the roof go back to new roof installation, see Page 4)

If you do decide to apply over existing roofing, inspect the roof for defects and repair so the new roofing has a flat surface to be applied to.

1. Secure or remove any warped roofing.
2. Make sure there are no protruding nails or other objects which may affect the new underlayment or roofing panels.
3. Remove all moss and other debris.
4. Remove all hip cap, ridge cap, and penetration flashing.
5. Cover the deck with a moisture barrier such as a minimum 30 # pound felt or other approved underlayment. Begin at the eave and roll the underlayment horizontally (along the eave). Overlap the next strip at least 3 inches. (Place a hi-temp ice & water membrane underlayment in areas which snow, ice, and rain can accumulate, such as valleys and eaves. This will be applied to the roof before rolling the 30 # felt out).
6. Place an alignment line along the gable end where the first panel will be installed. This line must be parallel to the gable edge of the roof and square with the eave edge. Check the roof for squareness by making a 3 foot line across the eave. (See illustration, Page 4) Completing the 3' x 4' x 5' triangle should place the 4' line parallel along the gable edge. The first panel will be placed along this line. Any out of square conditions up to 3" can be covered by the gable trim.

It is important to measure the roof from gable to gable. Proper placement of panels will allow the panel ribs on each side to be covered by the gable trim while creating a symmetrical appearance on the roof.

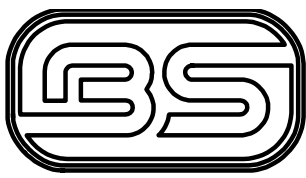

Panel Installation

Study the trim details in this manual before installing the panels. Pay close attention to Valleys, Eaves, and Transitions. Follow these basic guidelines

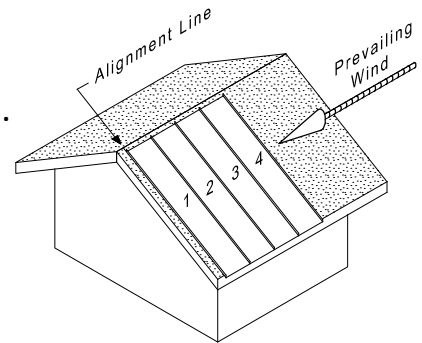

1. Install eave trim, valley trim prior to panel installation.

2. Always install your panels into the prevailing wind.

3. Align the edge of the first panel with the alignment line constructed along the gable end. Allow the panel to overhang the eave 1 to 2".

(If venting through the ridge make sure you hold the underlayment down 2" from the ridge. Also make sure your decking is 2" down from the top of the ridge on both sides. Doing this will allow for air circulation in the attic space.)

4. After the first panel is properly aligned, Fasten per the fasteners placement and spacing guide on page 7.

a. (Lay down second and third panels, check the alignment, and be sure they are square.) You may have to stretch or shrink the panel by either pulling the top or bottom of the panel to make up the distance needed to be square. If you have over a ¼" to make up it is best to stretch or shrink the panel over the next few panels.

| FASTENERS | | |
|--|---|---|
| CORRECT | TOO LOOSE | TOO TIGHT |
| | | |
| EPDM MATERIAL IS COMPRESSED AND VISIBLE AT WASHER. FASTENER IS PROPERLY INSTALLED. | EPDM NOT AT VISIBLE JOINT. NOT ENOUGH COMPRESSION TO MAKE A SEAL. | FASTENER IS OVER-DRIVEN AND EPDM IS PROTRUDING BEYOND EDGE OF FASTENER. |

5. After the panels are installed, you can install the rest of your trim and flashing. Start at the eave edges and work your way up. For example, place your gable trim starting at the bottom edge and work towards ridge. If pieces must be overlapped; a 2" minimum is recommended. Once the gable trim is installed, you may then install the ridge cap. Please see trim details on how each piece of trim is installed.

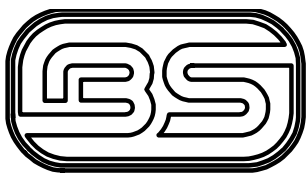

Fastener Installation

Screw fasteners have been proven to have 2 to 3 times the holding power of nails. For maximum holding power, it is recommended that the minimum wood penetration be 1 inch. Utilizing pancake head screw fasteners have an excellent quality and are specifically designed for fastening clips to the metal roofing panels. For OSB and plywood 1/2" or less, use #14 x 1" wood screws.

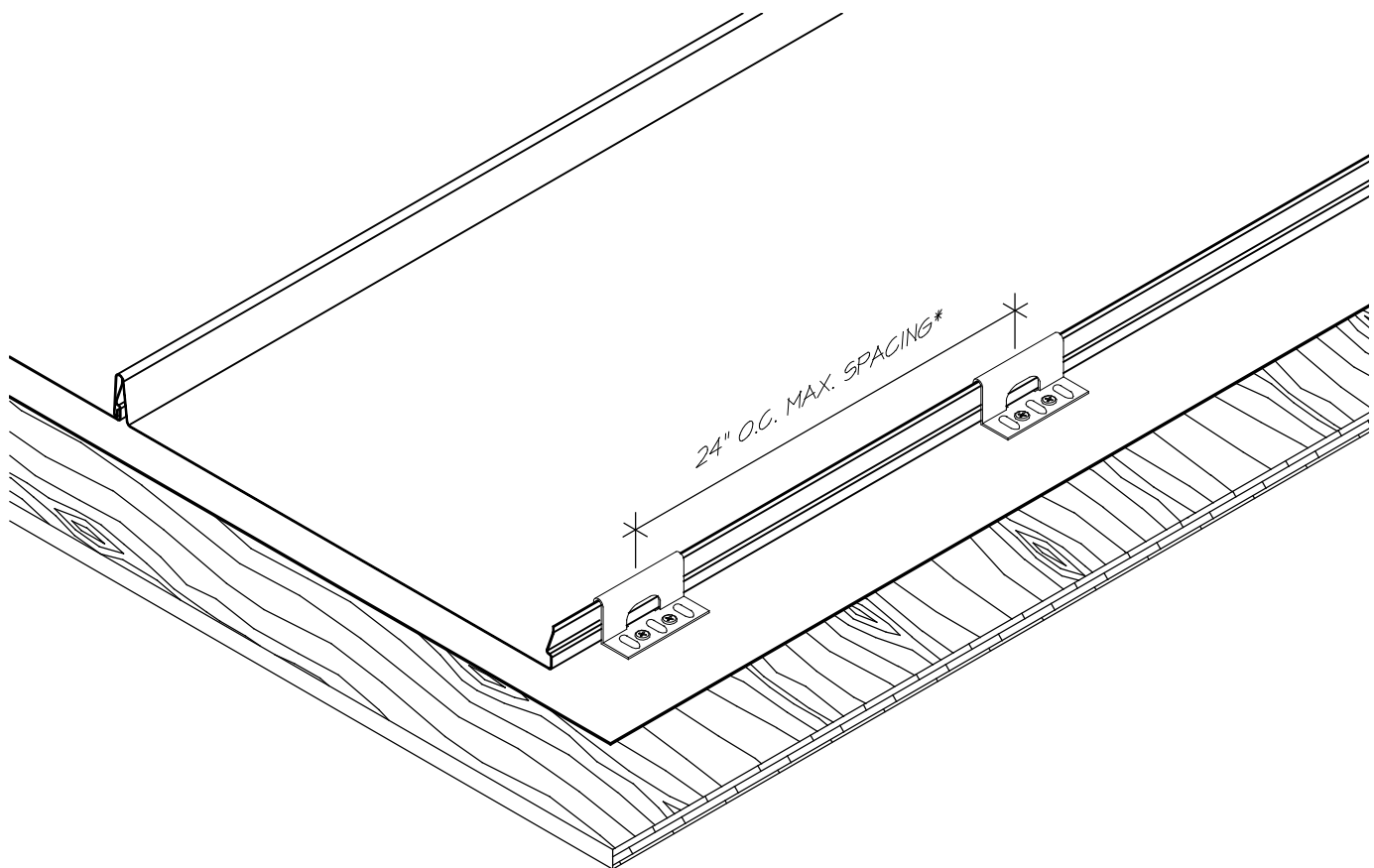

To prevent damage to panels and trim, install immediately or store in a cool dry area. Carbonized Steel, Galvanized Steel, Aluminized Steel, Galvalume and all alloys of Aluminum are susceptible to what is commonly referred to as "White" or "Black" rust and water stain. These are caused by electrolysis, which occurs when moisture exists between stacked sheets. Painted metal products are also susceptible to a change of or loss of paint gloss discoloration, delaminating, disintegrating, and other accelerated defects of the paint as a result of moisture between the panels sheets. Bridger Steel assumes no responsibility of liability for damage to our product which occurs in the possession of the consignee or which we deem to be improper handling and storage. If panels are to be cut or drilled be certain to wipe free any metal filings that may accumulate. Protective plastic film on the trim should be removed within 90 days. Failure to follow these instructions may void the warranty.

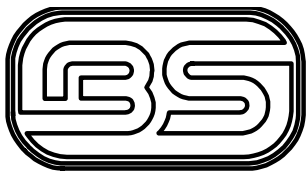

All roofs, metal or shingle, require periodic maintenance. Obviously, an expert should perform any complex repair or addition; however, there are certain items that an owner can perform in order to maintain his or her roof in excellent condition.

PERSONAL SAFETY

Safety is the top priority, climbing ladders and walking on any roof can be dangerous. Always use some method of fall protection that is approved by OSHA. Failure to provide the required safety equipment can result in serious injury or death.

During the roof inspection, remember to take the following precautions:

- Use fall protection and all required safety equipment.
- Keep foot traffic to a minimum. Only walk on the roof if absolutely necessary.
- Never walk on eave or rake flashings, gutters, hip, or ridge flashings.
- Never walk on any skylight or fiberglass type panels.
- Always walk in the flat area of the panel and near the roof panel supports.
- Don't wear black soled shoes; the marks they leave are almost impossible to remove.
- Soft soled shoes are recommended.

Roof Maintenance (Annually)

The following are a few of the actions to complete (yourself or professionally). Failure to do so could decrease your roof's life dramatically:

- Clean gutters, down spouts, and drain boxes. Leaves and debris can back up an entire gutter system and the overflowing gutters can cause leaks and damage.
- Inspect for tree branches or other items which are touching the roof. Remove items.

< Cont'd >

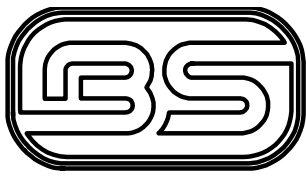

- Clear the valleys and waterways on flat roofs and pooling areas. Leaves and other debris can block the flow of water in valleys or drainage paths. This must be cleaned out regularly, especially if you have trees that overhang your roof. Pooling areas from dirt piles or rotted debris literally eats through your roof and sometimes plants grow in these areas. This will ruin your roof.
- Check roof penetrations for possible leaks. Leaks most often come from heat or air vents and skylights. Some leaks are caused by the shrinking or hardening of applied silicones as they dry out. If there is a crack or a suspected area, fill it using a Metal Roofing Sealant such as **Titebond** which is permanently flexible and won't crack.
- Inspect areas around chimneys, heat vents, oil condensers above cooking areas and air conditioners, these areas can expose your roofing to chemicals that will break down the paint system and can corrode the metal.
- Look for loose flashings, roof sheets, fasteners, or punctures from falling objects.
- Inspect your roof paint for scratches. Should this occur, clean the area with mineral spirits, Rinse completely with water and allow to dry. Using paint supplied from the manufacturer of the panel, apply a minimum amount of paint to cover the scratched area. This may need to be touched up again in several years.

If exposed fasteners have been used on your roof, it is imperative that they are inspected annually. The inspection entails several key points:

- Are the fasteners installed correctly? Sometimes fasteners are tightened down too much which may cause them to cut or split the neoprene washers.
- Other fasteners may not be tightened properly which will not create a seal between the fastener and the metal panel or flashing.
- Neoprene washers may break down over time due to expansion and contracting of the metal panels or from exposure to ultraviolet rays. By rubbing your finger nail over the washer you will notice if it is still flexible or has hardened and is breaking apart.

Finally, look at the closures or venting materials under the ridge caps, transitions, end walls and valleys. At times this material can come loose or break down from sun exposure and cause leaks. Replace as necessary.

The main idea is to be aware of the environment surrounding your roof. If you find any problems and you cannot repair them yourself, contact your installer or the roof manufacturer to see how the problem can be resolved.

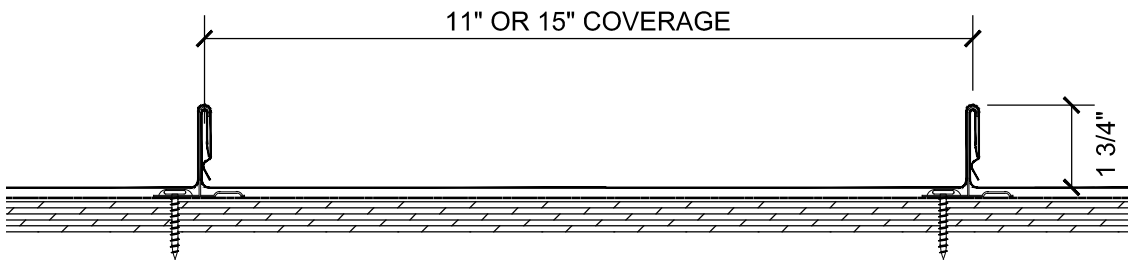
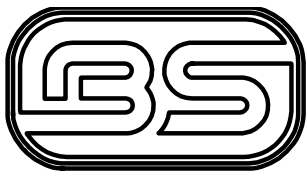

1 3/4" Panel Profile

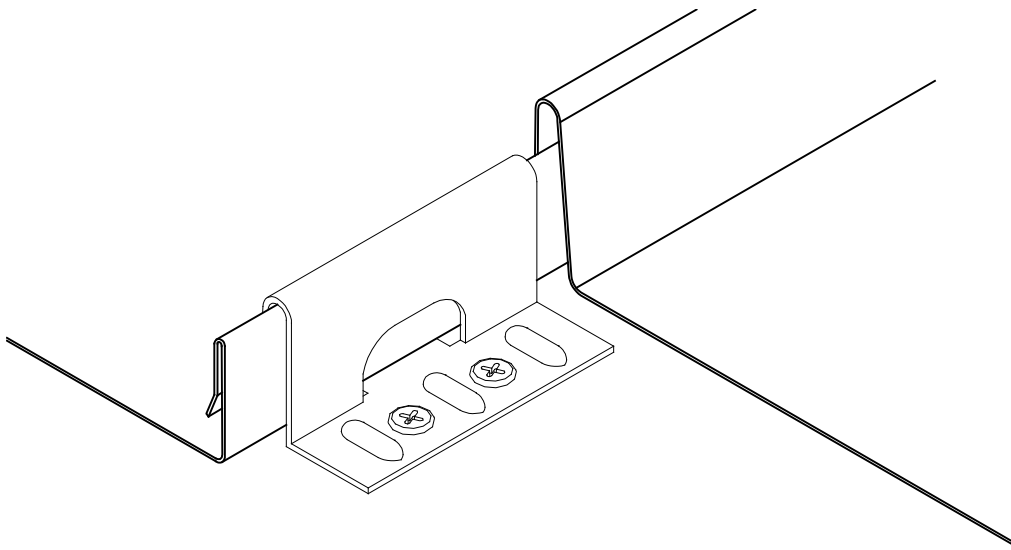

Seams

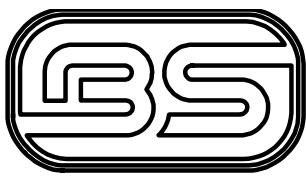

BRIDGERSTEEL

CREATE LASTING BEAUTY

Flashings

FLASHINGS

1a) VENTED RIDGE CAP

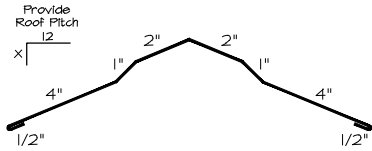

1b) NON VENTED RIDGE CAP

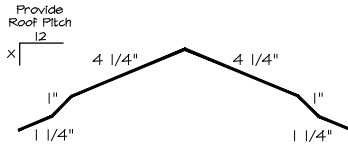

2) HIP RIDGE

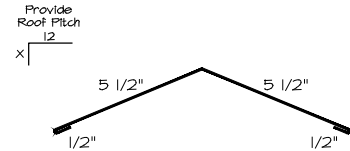

3a) 2x6 TOP CAP

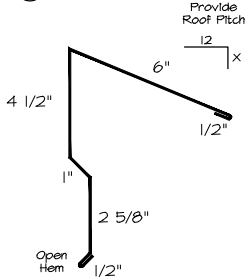

3b) 2x4 TOP CAP

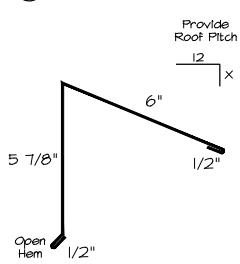

4a) 2x4 GABLE

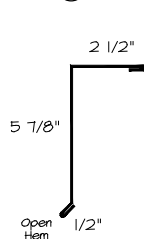

4b) 2x6 GABLE

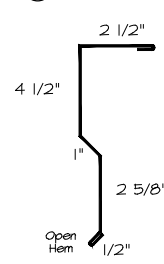

5a) 2x6 EAVE

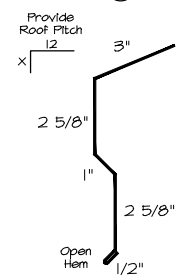

5b) 2x4 EAVE

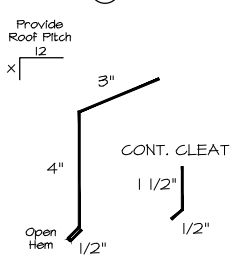

5c) STYLE D EAVE

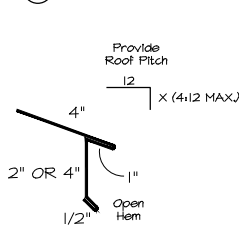

9) ENDWALL

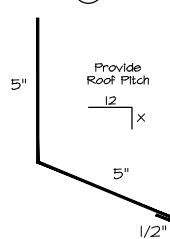

10a) SIDEWALL

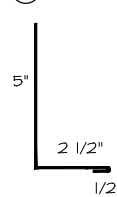

20a) TRANSITION HIGH LOW

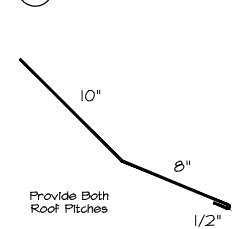

20b) TRANSITION LOW HIGH

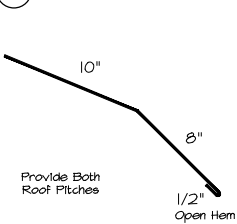

14) INSIDE CORNER

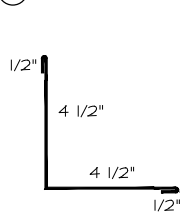

15) OUTSIDE CORNER

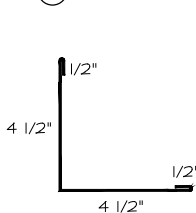

8a) F & J TRIM

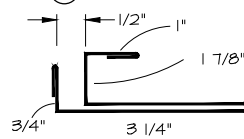

18) 2\" J TRIM

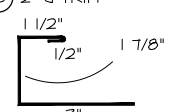

13) Z METAL

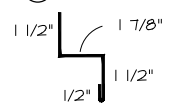

23) Z TRIM



6) FASCIA



11) SNOW BREAK

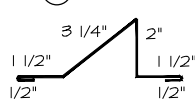

19) F TRIM FOR SOFFIT

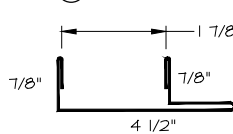

22) OFFSET CLEAT

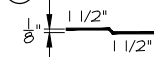

8b) 1/2\" J TRIM

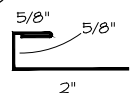

12) DOOR CAP

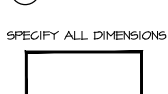

16) BASE DRIP

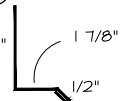

17) 24\" W-VALLEY

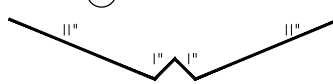

22) OFFSET CLEAT

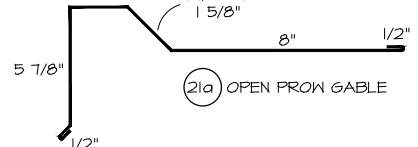

21a) OPEN PROW GABLE

1-3/4\" Tru-Snap

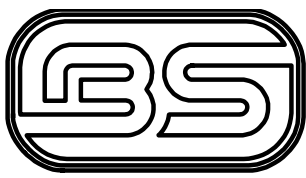

BRIDGERSTEEL

CREATE LASTING BEAUTY

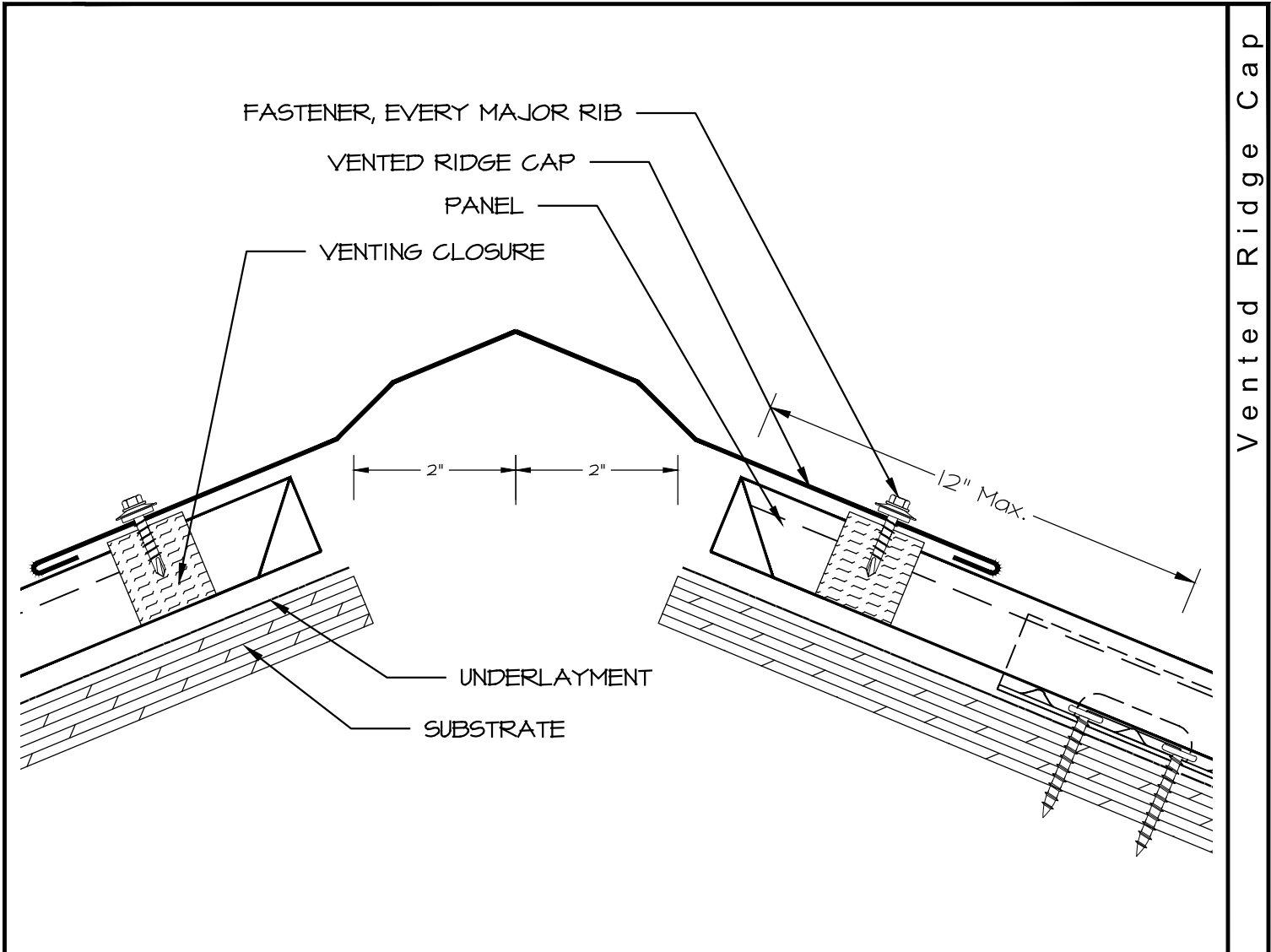

Vented Ridge Cap

NOTES:

1. Make sure to leave a 2" gap from both sides of the ridge.
2. Install roof panels on both sides of the ridge, making sure not to cover up the 2" opening at the ridge.
3. Place vented closures on roof panel and fasten down both sides of the ridge on every major rib.

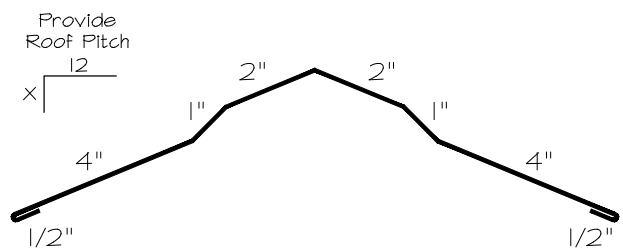

Vented Ridge Cap
10'-2" Pcs.

1-3/4" Tru-Snap

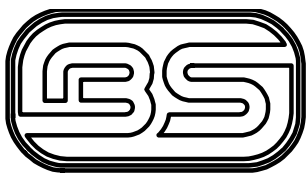

BRIDGERSTEEL

CREATE LASTING BEAUTY

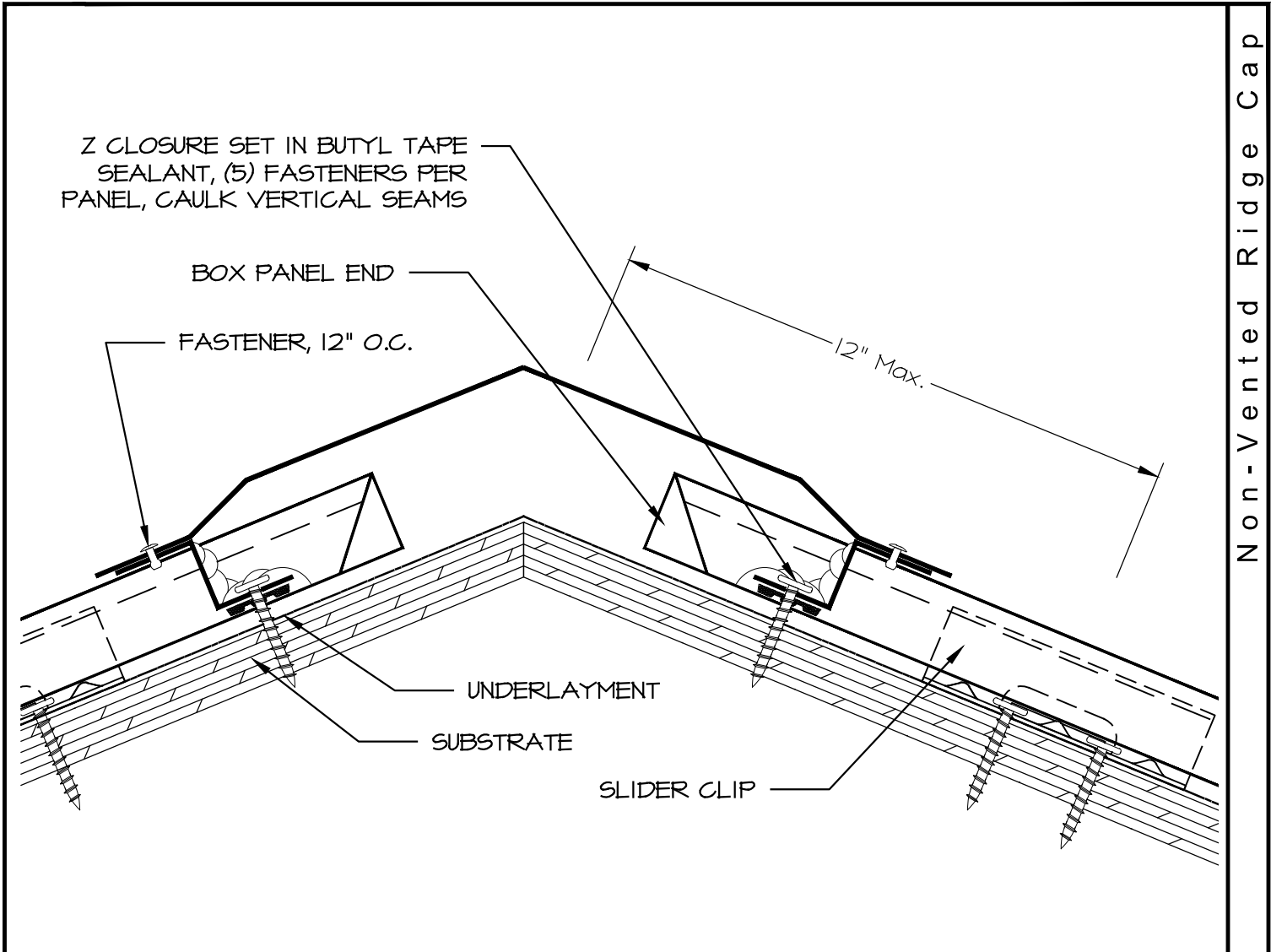

Non-Vented Ridge Cap

NOTES:

1. Install roof panels on both sides of ridge.
2. Cut Z closure to fit between seams.
3. Set Z closure in butyl tape sealant.
4. Fasten Z closure with (5) fasteners per panel.
5. Place ridge on Z closure and fasten 12" O.C.

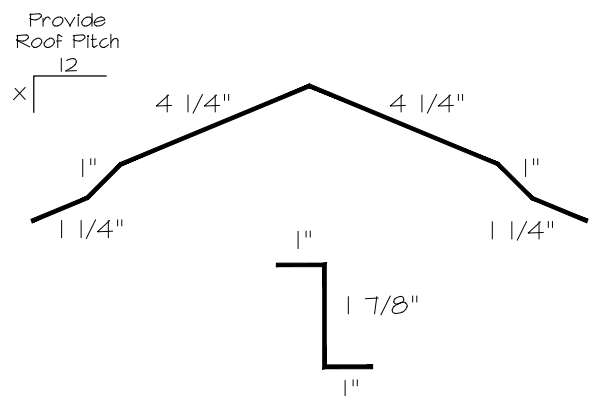

Non-Vented Ridge Cap

10'-2" Pcs.

1-3/4" Tru-Snap

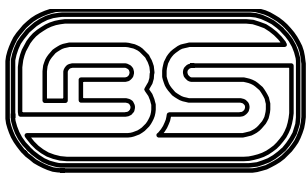

BRIDGERSTEEL

CREATE LASTING BEAUTY

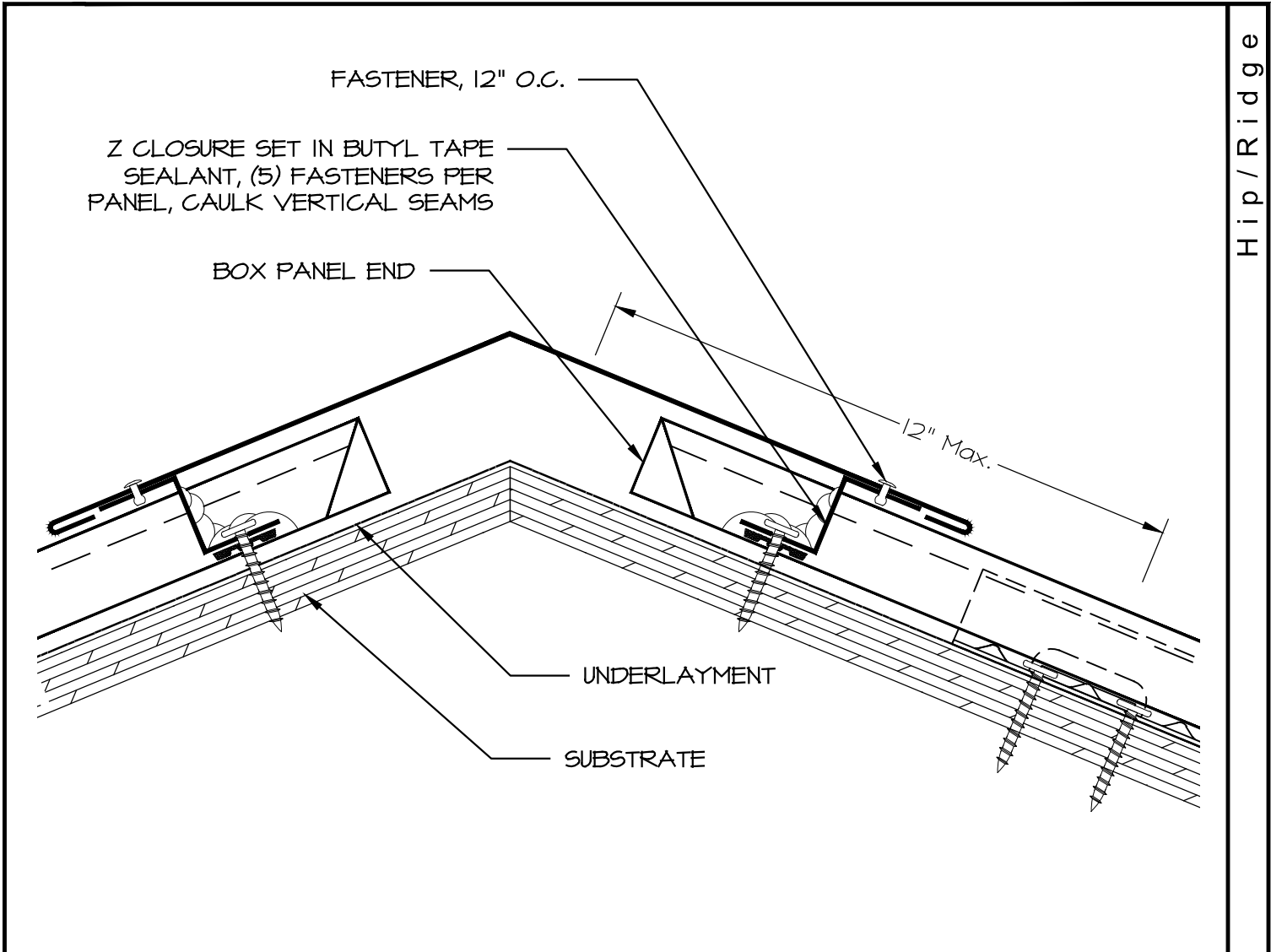

Hip / Ridge

NOTES:

1. Install roof panels on both sides of ridge.
2. Cut Z closure to fit between seams.
3. Set Z closure in butyl tape sealant.
4. Fasten Z closure with (5) fasteners per panel.
5. Place ridge on Z closure and fasten 12" O.C.

Provide Roof Pitch
12

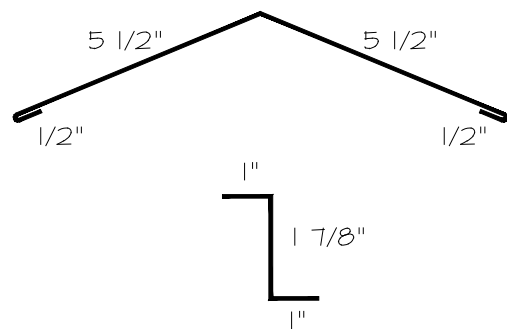

Hip / Ridge
10'-2" Pcs.

1-3/4" Tru-Snap

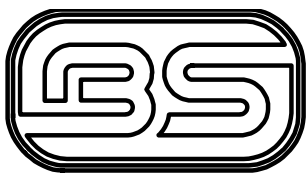

BRIDGERSTEEL

CREATE LASTING BEAUTY

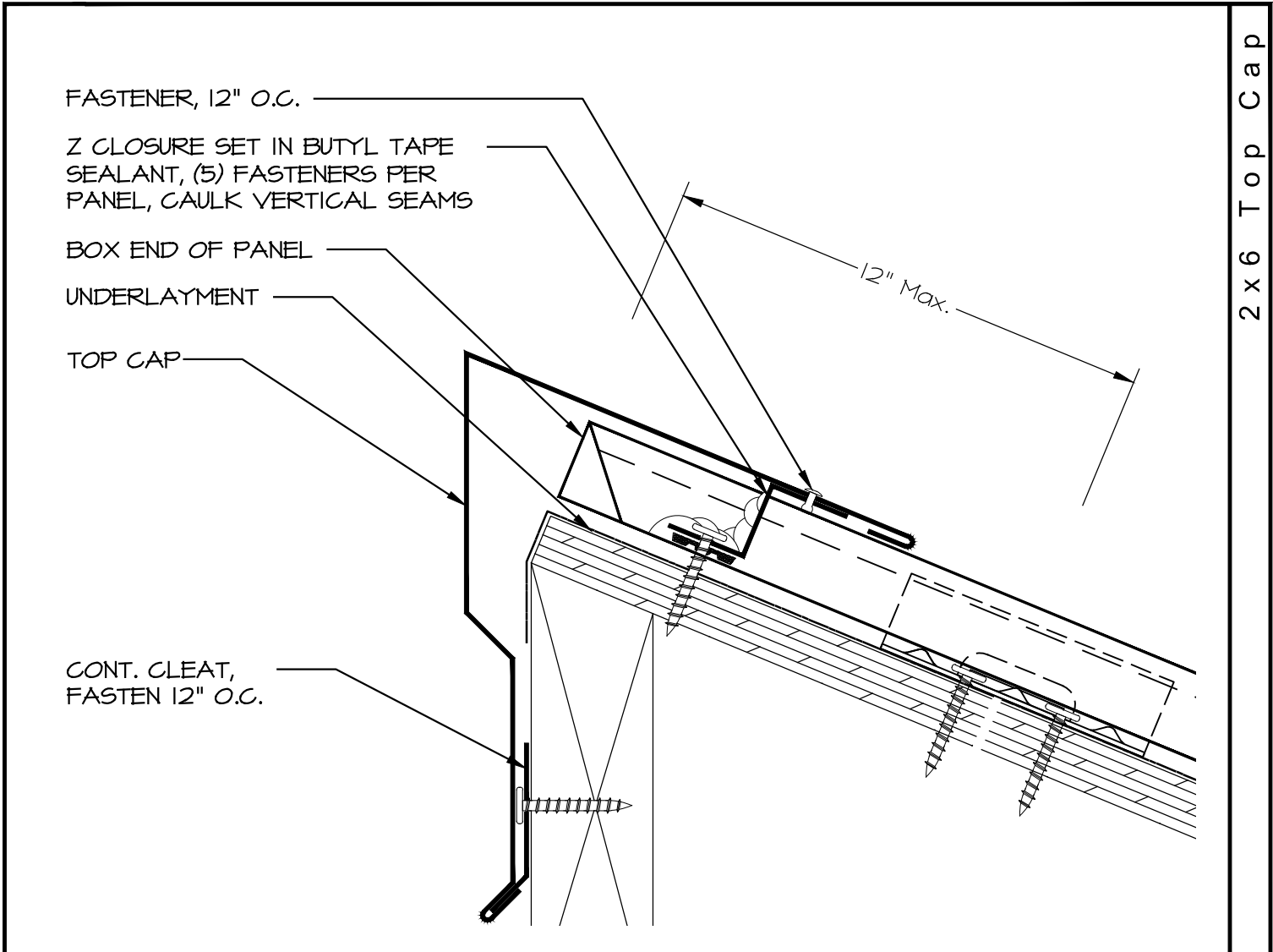

2 x 6 Top Cap

NOTES:

1. Box end of panel.
2. Install roof panels.
2. Cut Z closure to fit between seams.
3. Set Z closure in butyl tape sealant.
4. Fasten Z closure with (5) fasteners per panel.
5. Place Top Cap on Z closure and fasten 12" O.C.

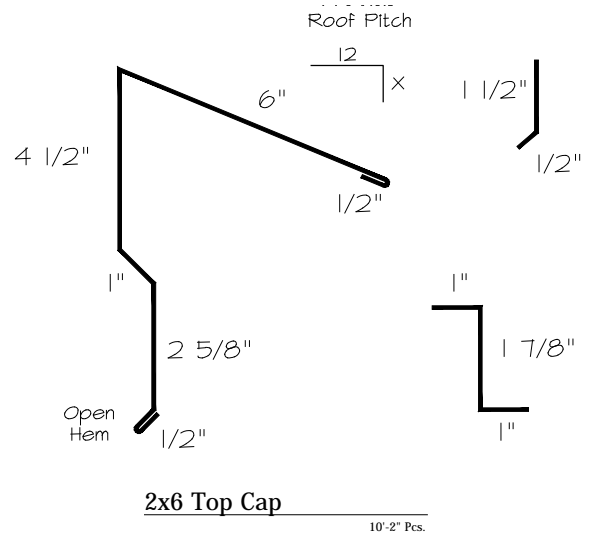

1 - 3/4\" Tru-Snap

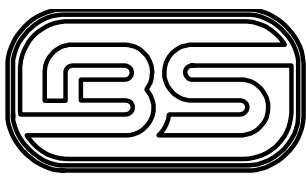

BRIDGERSTEEL

CREATE LASTING BEAUTY

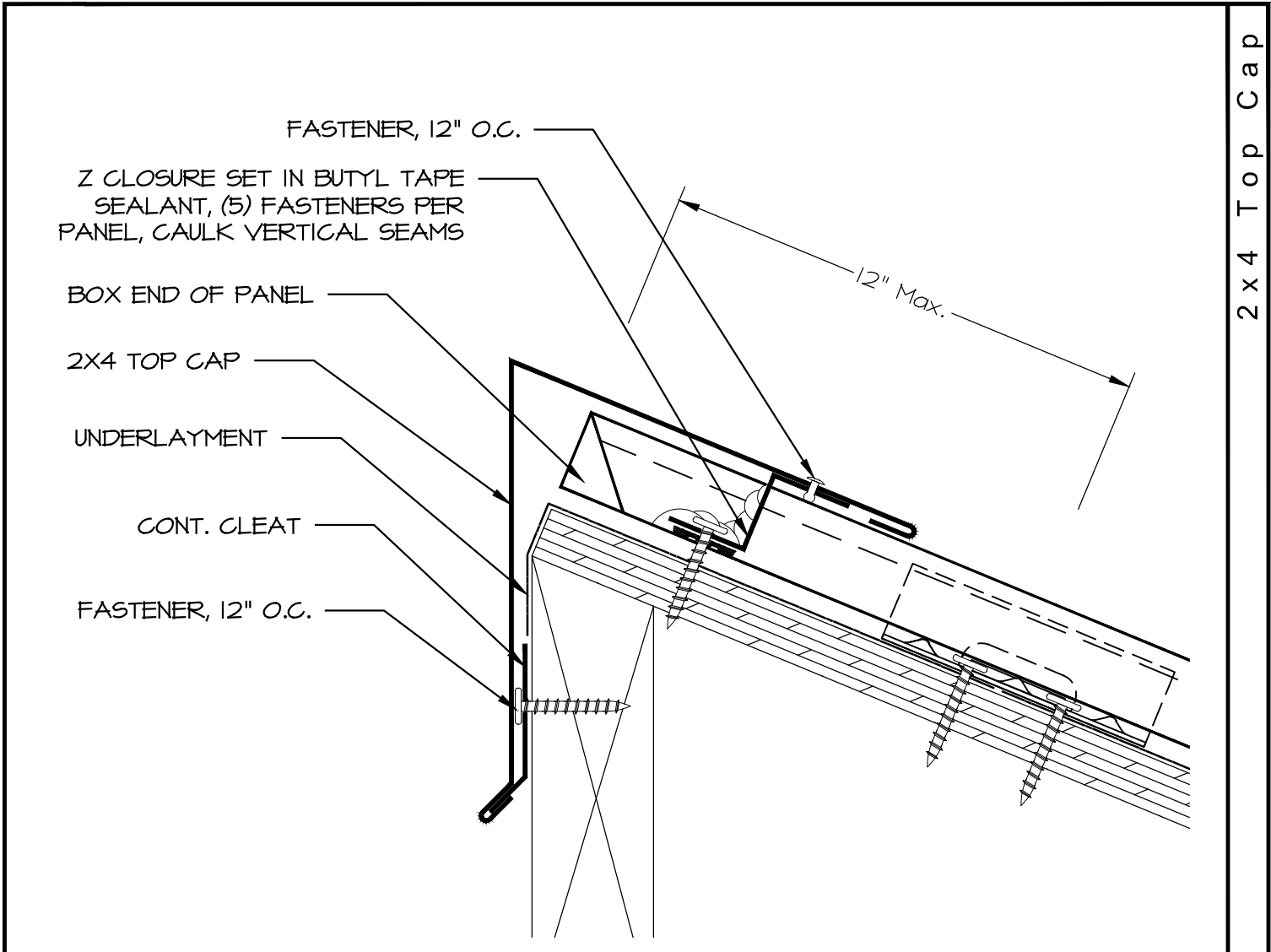

2 x 4 Top Cap

NOTES:

1. Box end of panel.
2. Install roof panels.
2. Cut Z closure to fit between seams.
3. Set Z closure in butyl tape sealant.
4. Fasten Z closure with (5) fasteners per panel.
5. Place Top Cap on Z closure and fasten 12" O.C.

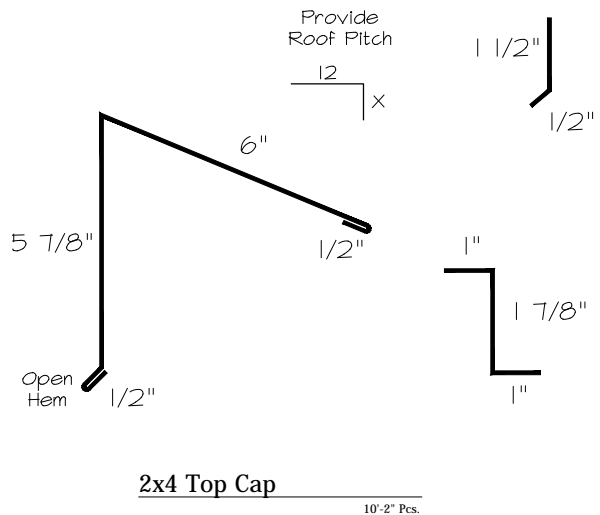

1 - 3/4" Tru-Snap

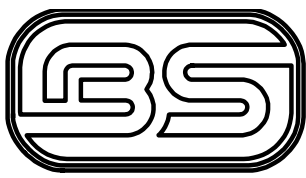

BRIDGERSTEEL

CREATE LASTING BEAUTY

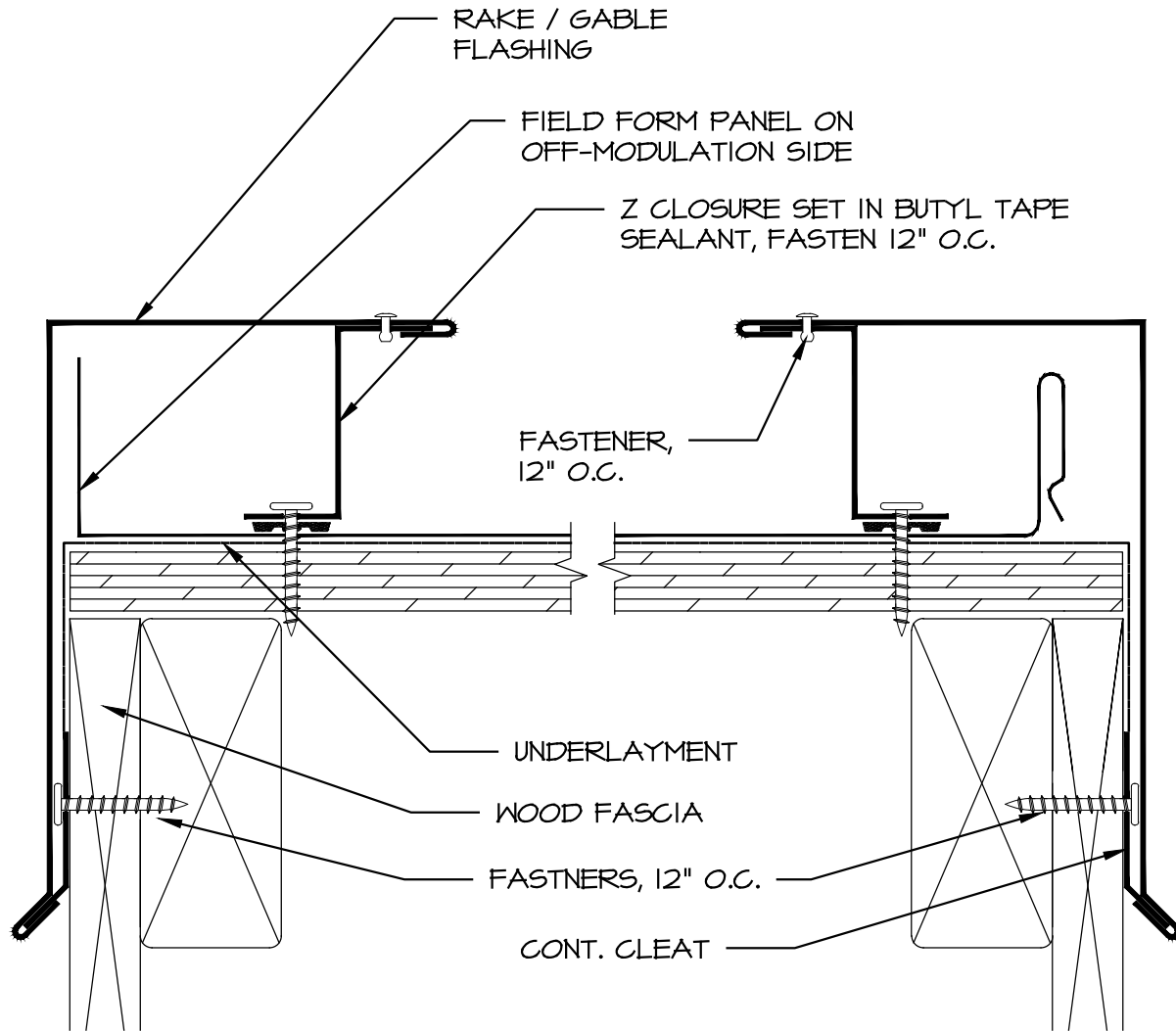

2 x 4 Gable

NOTES:

1. Run panels across roof deck cutting and field bending last panel to fit.
2. Install Z closure in continuous butyl tape along rake/gable edge on top of roof panel.
3. Install continuous cleat along fascia.
4. Install rake/gable trim hooking onto cleat.
5. Install rake/gable on Z closure fastening 12" o.c.

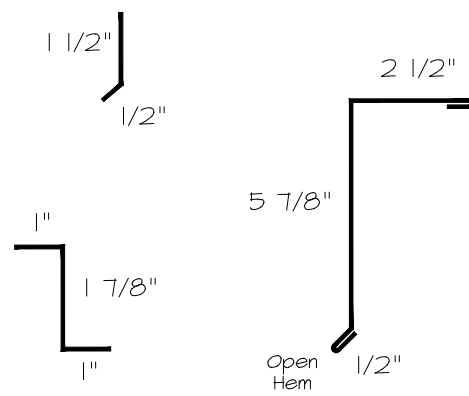

2x4 Gable

10'-2" Pcs.

1 - 3/4" Tru-Snap

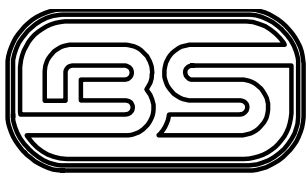

BRIDGERSTEEL

CREATE LASTING BEAUTY

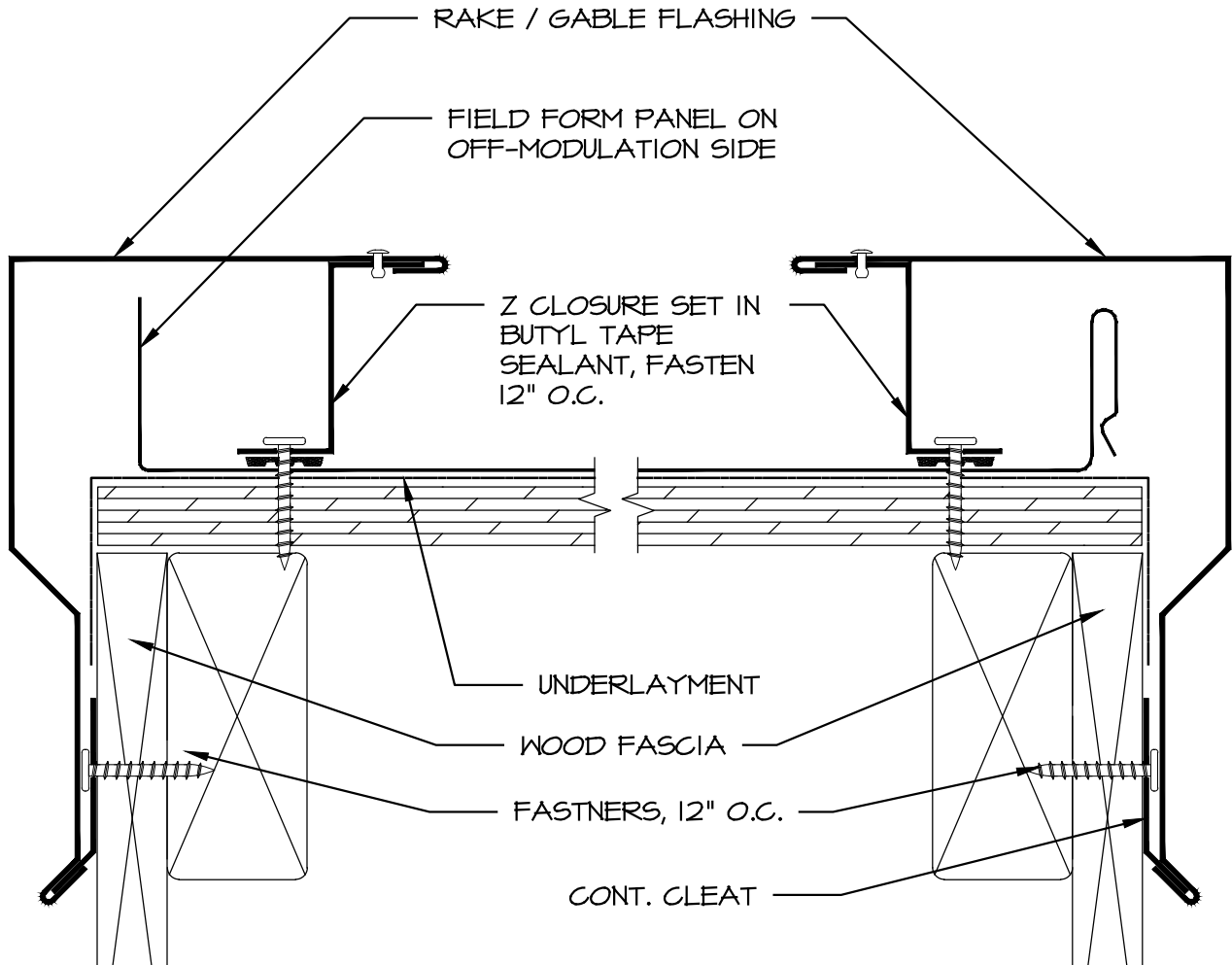

2 x 6 Gable

NOTES:

1. Run panels across roof deck cutting and field bending last panel to fit.
2. Install Z closure in continuous butyl tape along rake/gable edge on top of roof panel.
3. Install continuous cleat along fascia.
4. Install rake/gable trim hooking onto cleat.
5. Install rake/gable on Z closure fastening 12" o.c.

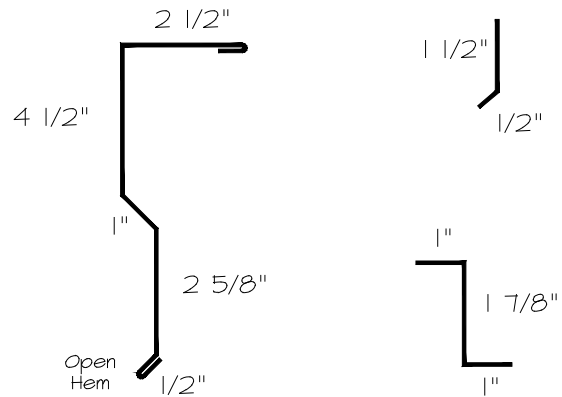

2x6 Gable

10'-2" Pcs.

1 - 3/4" Tru-Snap

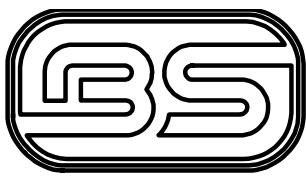

BRIDGERSTEEL

CREATE LASTING BEAUTY

2 x 4 Eave

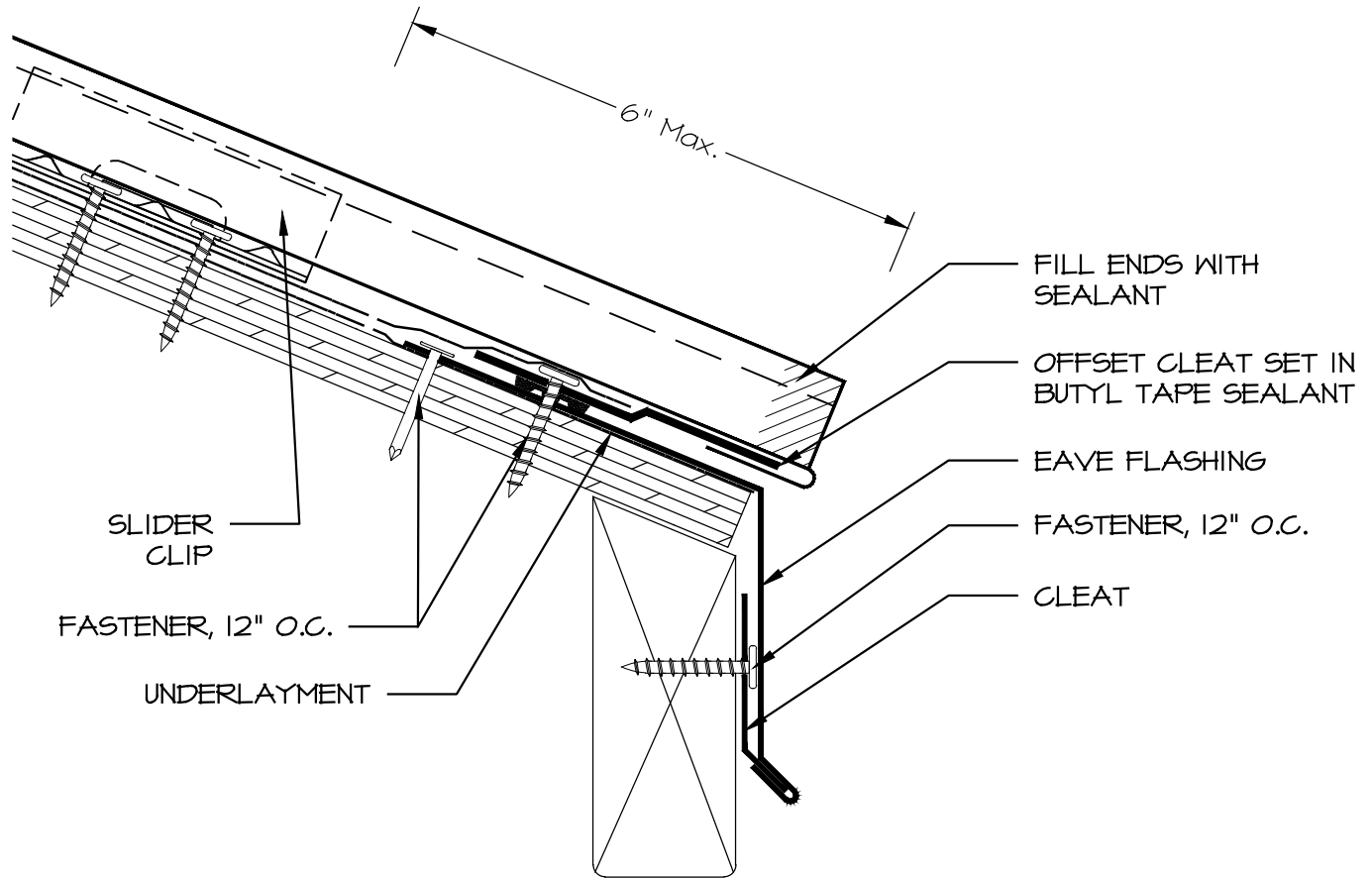

NOTES:

1. Install continuous cleat along fascia.
2. Install eave trim hooking onto drip edge.
3. Nail upper flange of eave flange to roof deck 12" o.c.
4. Apply offset cleat in continuous butyl tape sealant on eave flashing fastening through the sealant at 12" o.c.
5. Apply underlayment over top of nailing flange.
6. Notch upper roof panel 1" and form around offset cleat.

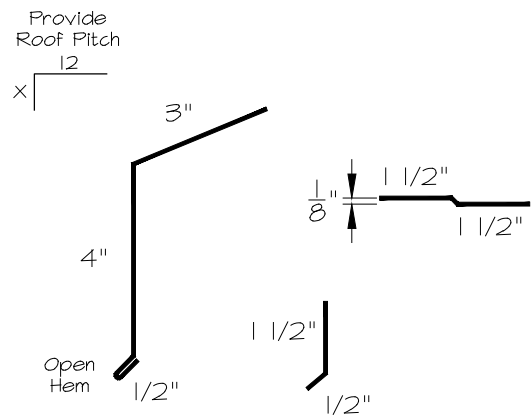

2x4 Eave
10'-2" Pcs.

1 - 3/4" Tru-Snap

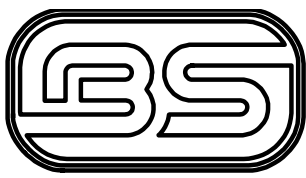

BRIDGERSTEEL

CREATE LASTING BEAUTY

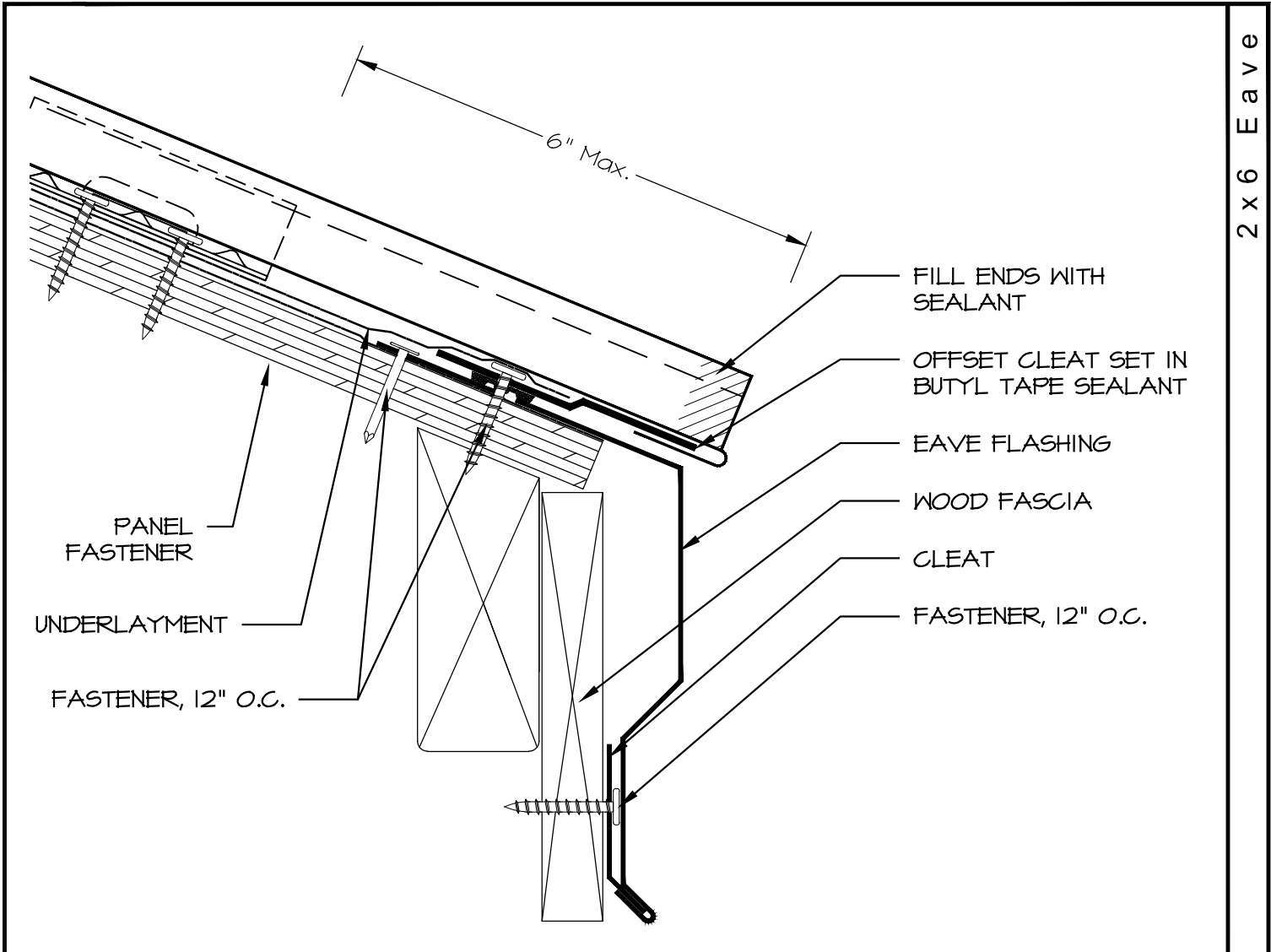

2 x 6 Eave

NOTES:

1. Install continuous cleat along fascia.
2. Install eave trim hooking onto drip edge.
3. Nail upper flange of eave flange to roof deck 12" o.c.
4. Apply offset cleat in continuous butyl tape sealant on eave flashing fastening through the sealant at 12" o.c.
5. Apply underlayment over top of nailing flange.
6. Notch upper roof panel 1" and form around offset cleat.

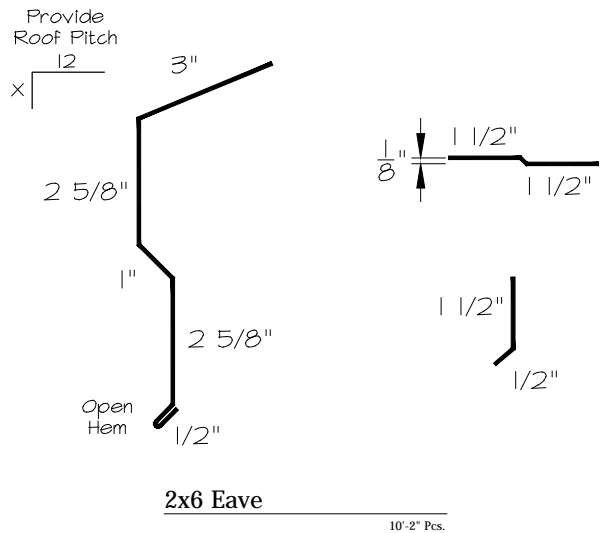

1 - 3/4" Tru-Snap

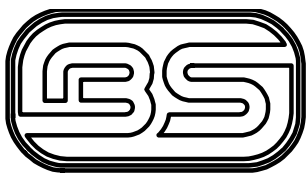

BRIDGERSTEEL

CREATE LASTING BEAUTY

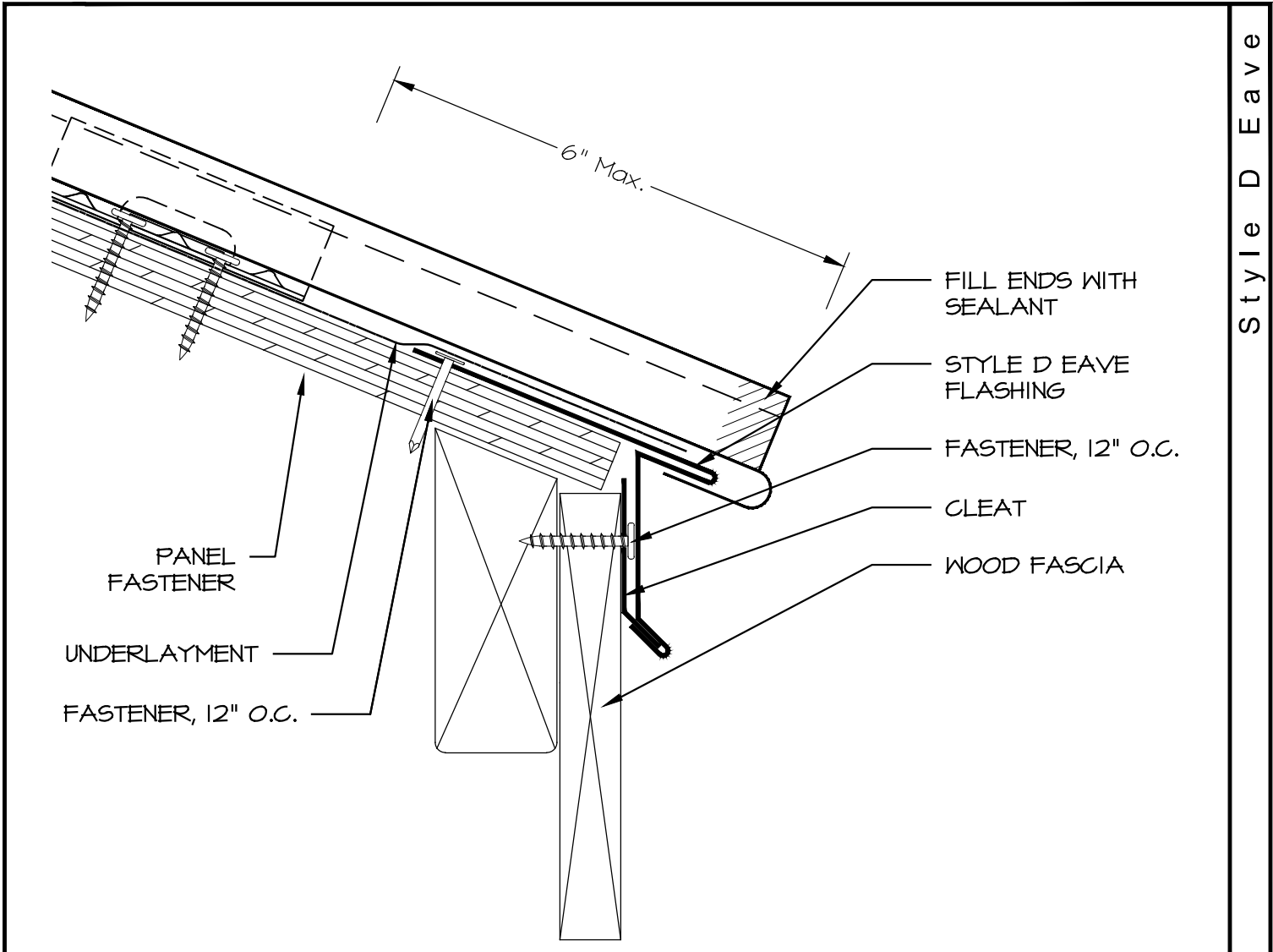

Style D Eave

NOTES:

1. Install continuous cleat along fascia.
2. Install eave trim hooking onto drip edge.
3. Nail upper flange of eave flange to roof deck 12" o.c.
4. Apply underlayment over top of nailing flange.
5. Notch upper roof panel 1" and form around style D eave.

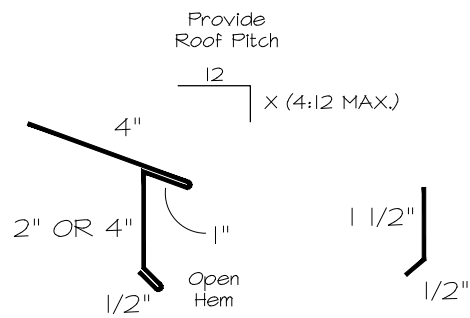

Style D Eave

10'-2" Pcs.

1-3/4" Tru-Snap

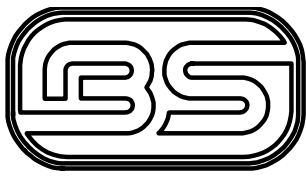

BRIDGERSTEEL

CREATE LASTING BEAUTY

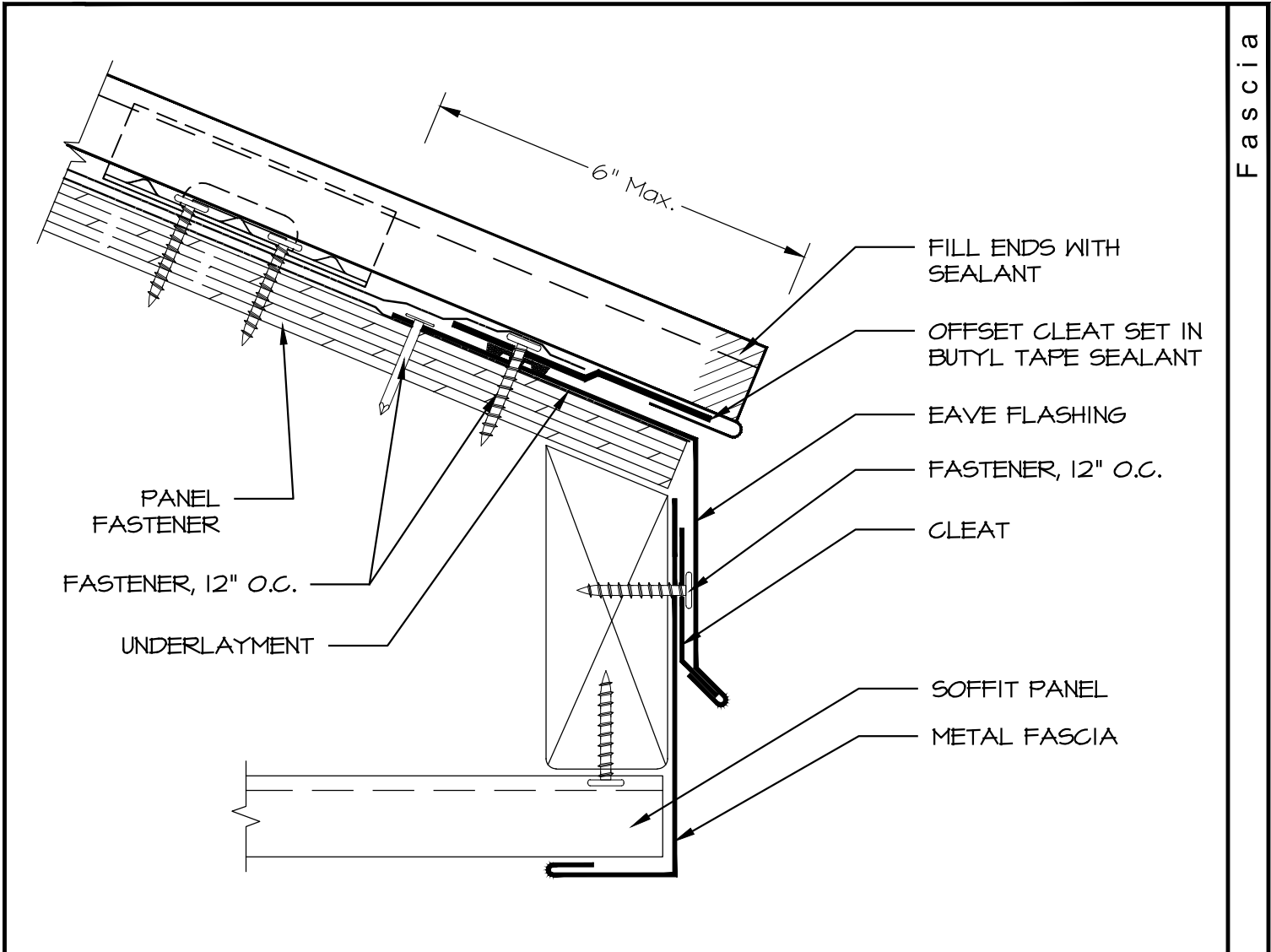

Fascia

NOTES:

1. Apply metal fascia over soffit and over fascia material.
2. Fasten metal fascia to fascia board every 12".

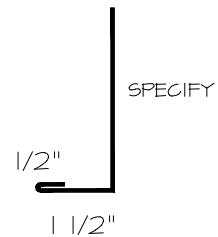

Fascia _____
10'-2" Pcs.

1-3/4" Tru-Snap

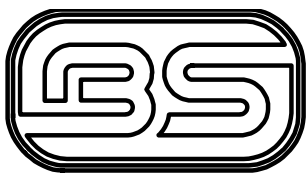

BRIDGERSTEEL

CREATE LASTING BEAUTY

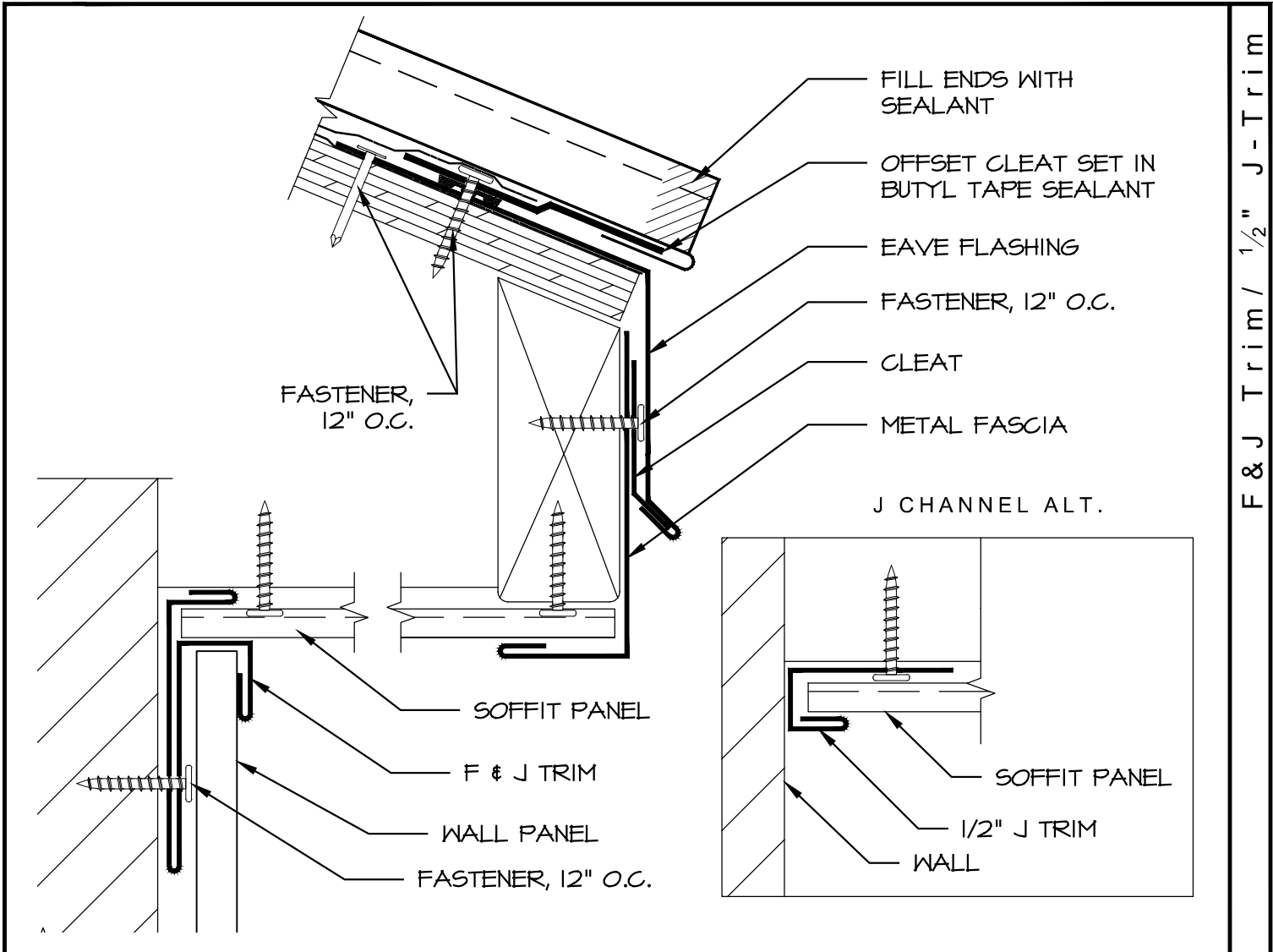

NOTES:

1. Place either F&J or 1/2" J Trim on wall of the building.
2. Make sure that the F&J or 1/2" J Trim is parallel with your fascia.
3. Once F&J or 1/2" J Trim is installed either install wall panels or soffit panel.

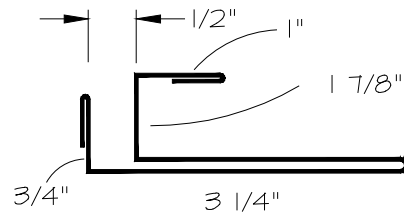

F & J Trim
10'-2" Pcs.

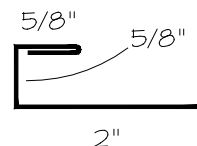

1/2" J Trim
10'-2" Pcs.

F & J Trim / 1/2" J-Trim

1-3/4" Tru-Snap

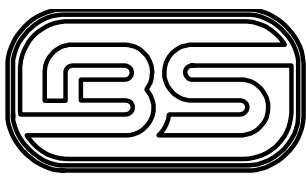

BRIDGERSTEEL

CREATE LASTING BEAUTY

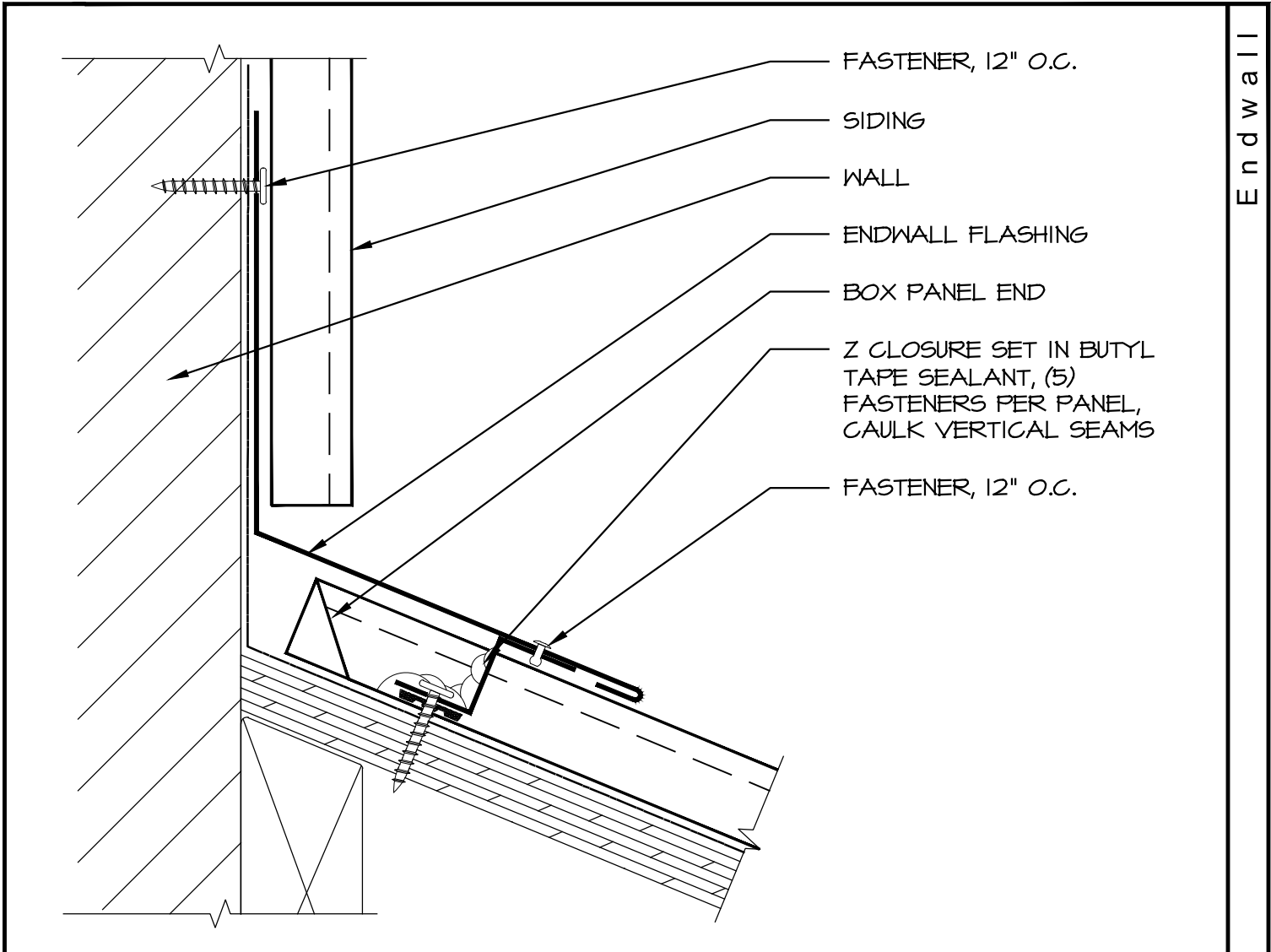

End wall

NOTES:

1. Box panel end.
2. Install roof panels.
3. Install Z closure on roof panels in continuous butyl tape sealant.
4. Place endwall on Z closure and fasten endwall trim every 12" o.c.
5. Fasten upper flange to wall every 12".

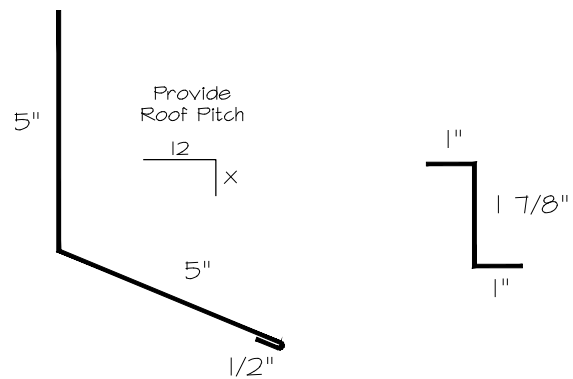

Endwall

10'-2" Pcs.

1 - 3/4" Tru-Snap

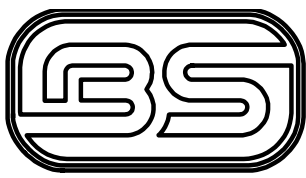

BRIDGERSTEEL

CREATE LASTING BEAUTY

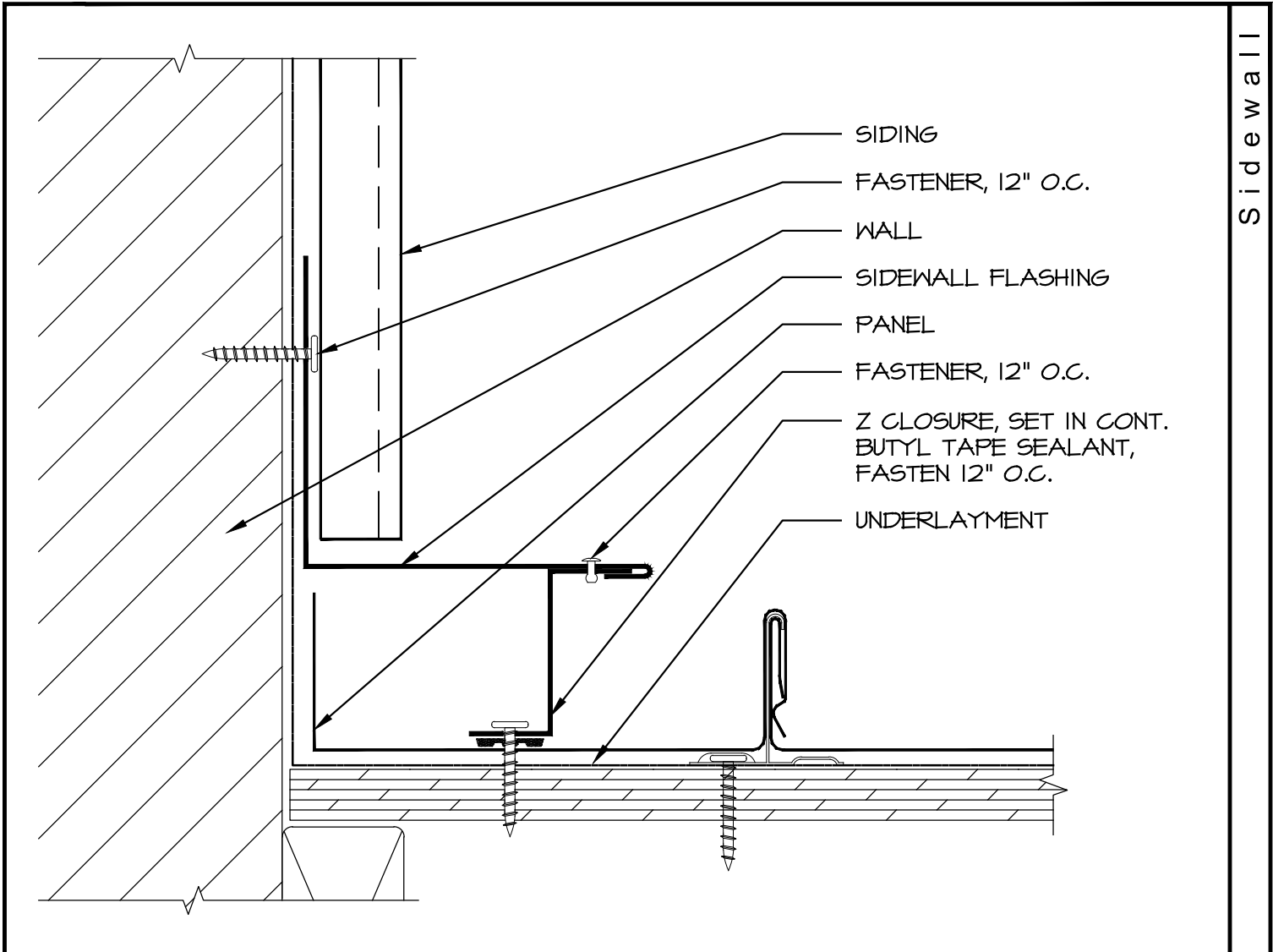

Sidewall

NOTES:

1. Run panels across roof deck, cutting and field bending last panel to fit.
2. Install panel.
3. Install Z closure on roof panel in continuous butyl tape sealant.
4. Install Sidewall Flashing on top of Z closure.
5. Fasten sidewall to Z closure every 12" o.c.
6. Fasten upper sidewall flange to wall every 12" o.c.

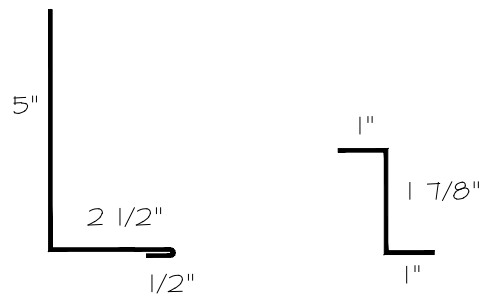

Sidewall

10'-2" Pcs.

1 - 3/4" Tru-Snap

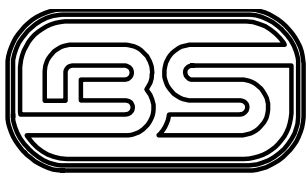

BRIDGERSTEEL

CREATE LASTING BEAUTY

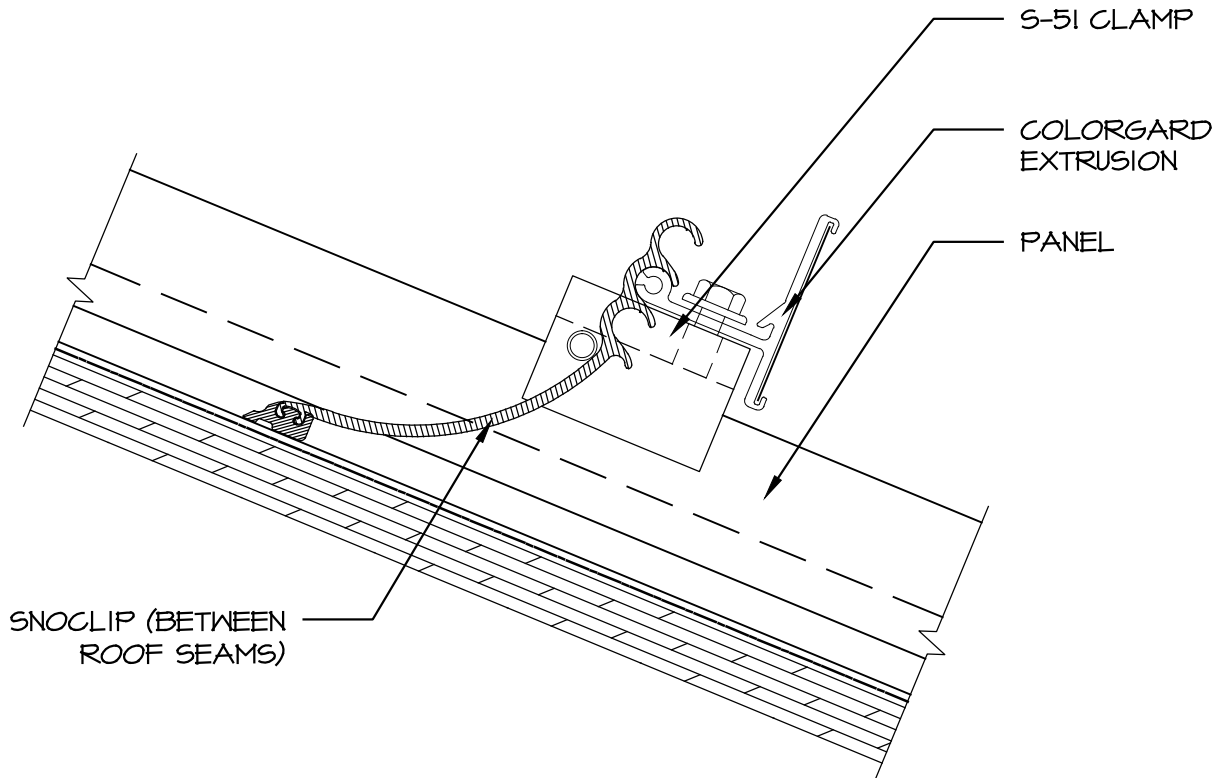

S - 5 ColorGard

NOTES:

1. Install all roof panels.
2. Snow retention runs in perpendicular direction of roof panels.
3. If building has an overhang, place snow retention over the exterior load-bearing wall.
4. If structure has no overhang, place snow retention approximately 2 ft. from eave.

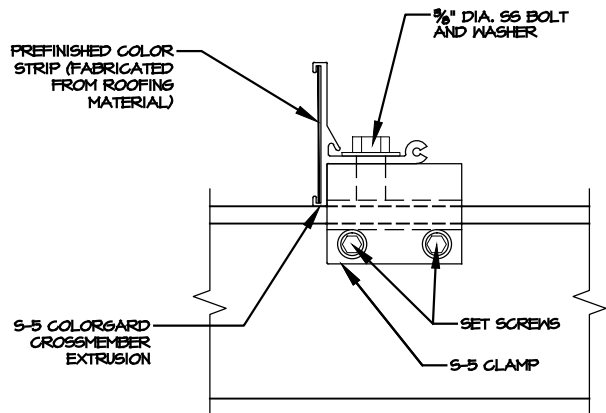

S-5 ColorGard

1 - 3/4" Tru-Snap

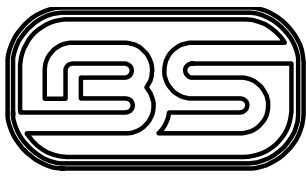

BRIDGERSTEEL

CREATE LASTING BEAUTY

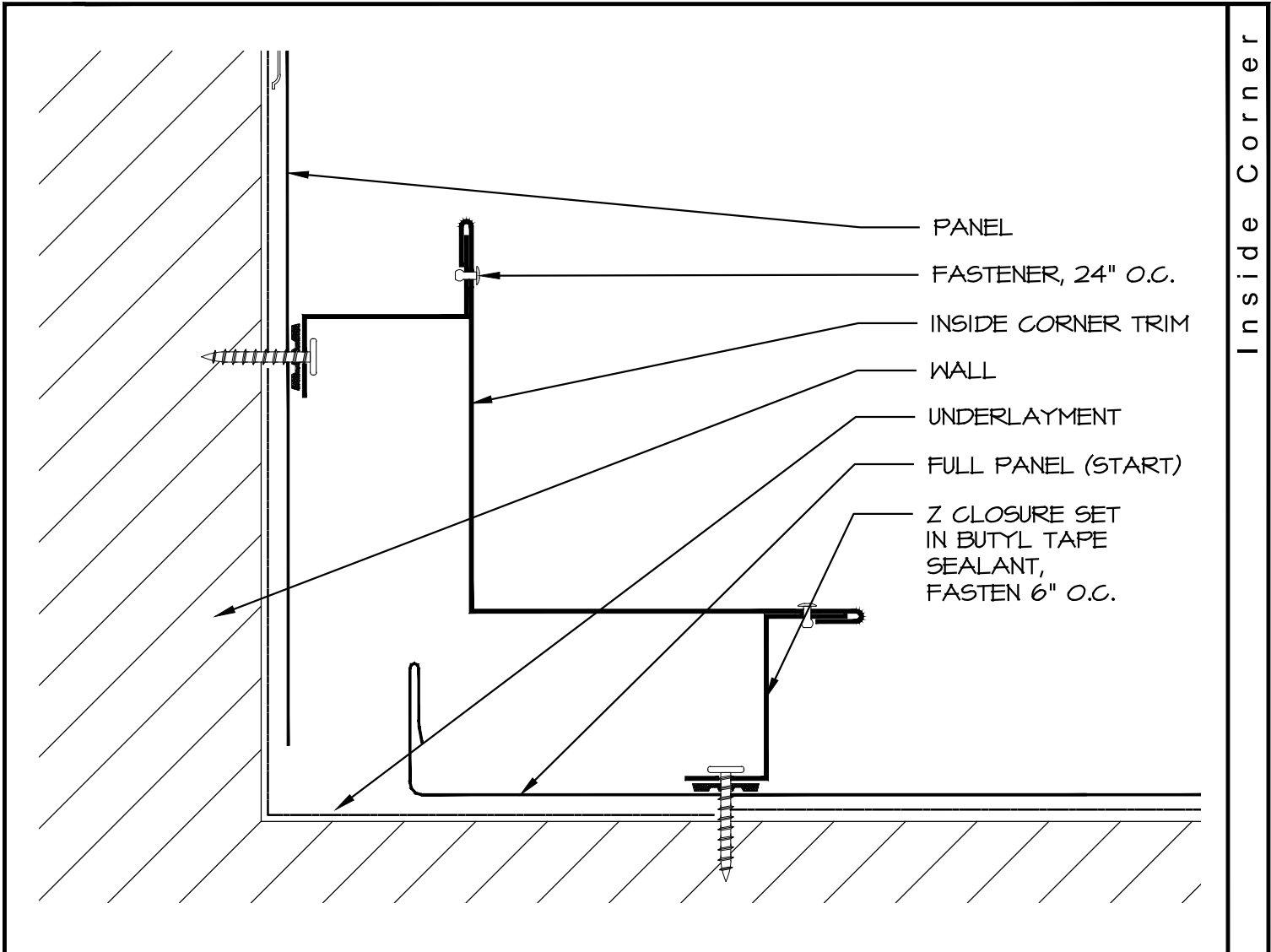

Inside Corner

NOTES:

1. Install wall panels.
2. Install Z closure on top of panels in continuous butyl tape sealant.
3. Install corners on Z closures, always working from base of wall to roof. Fasten every 24" on both sides of corner.

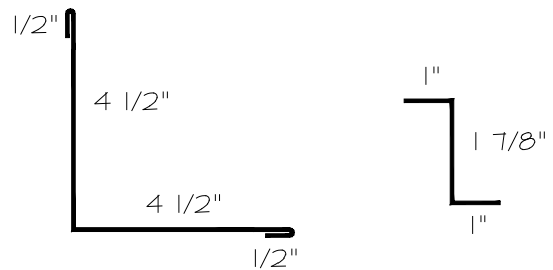

Inside Corner

10'-2" Pcs.

1-3/4" Tru-Snap

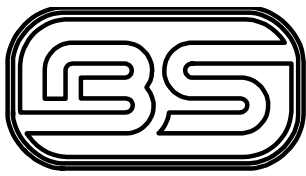

BRIDGERSTEEL

CREATE LASTING BEAUTY

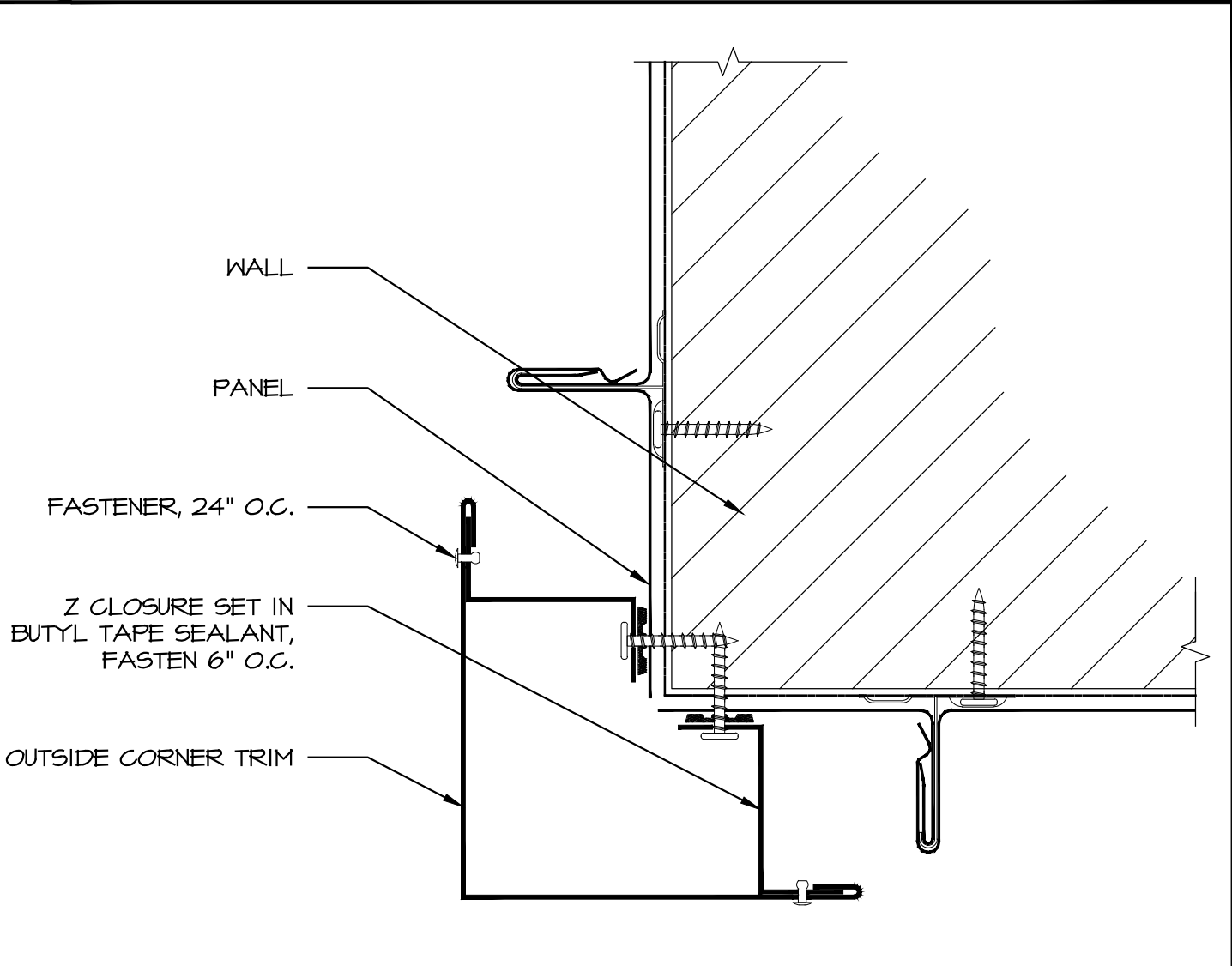

Outside Corner

NOTES:

1. Install wall panels.
2. Install Z closure on top of panels in continuous butyl tape sealant.
3. Install corners on Z closures, always working from base of wall to roof. Fasten every 24" on both sides of corner.

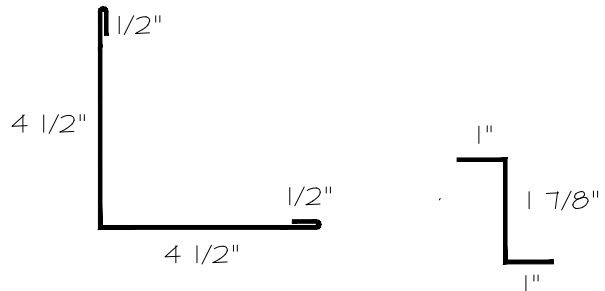

Outside Corner

10'-2" Pcs.

1-3/4" Tru-Snap

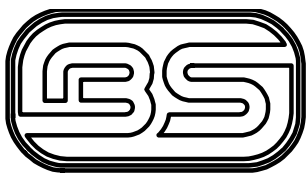

BRIDGERSTEEL

CREATE LASTING BEAUTY

Base Trim

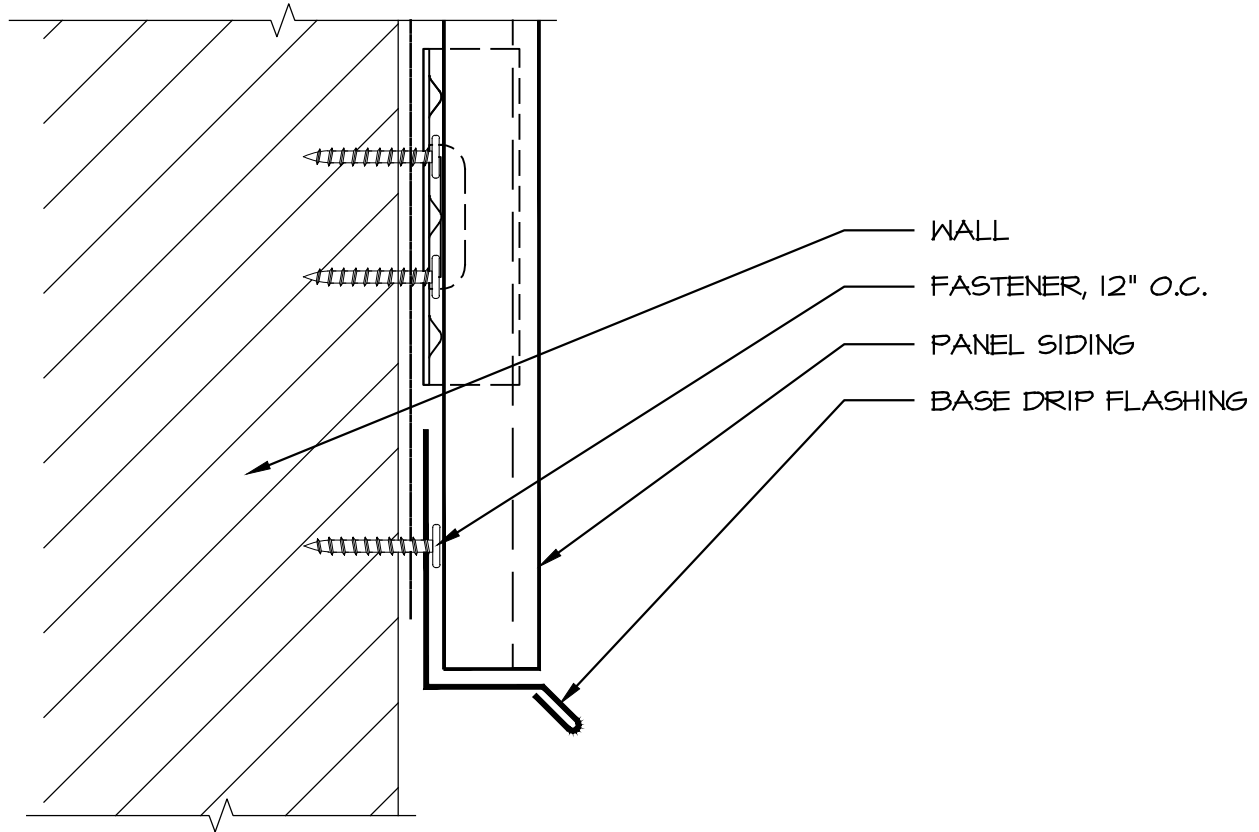

NOTES:

1. Apply Base Trim to bottom of wall to keep panels straight.
2. Base trim must be installed above ground and fastened every 12" o.c. on nailing flange.

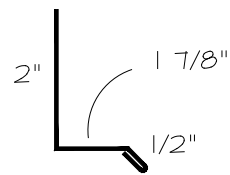

Base Trim
10'-2" Pcs.

1 - 3/4" Tru-Snap

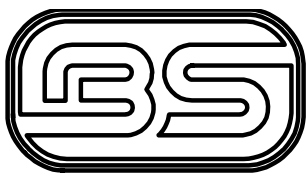

BRIDGERSTEEL

CREATE LASTING BEAUTY

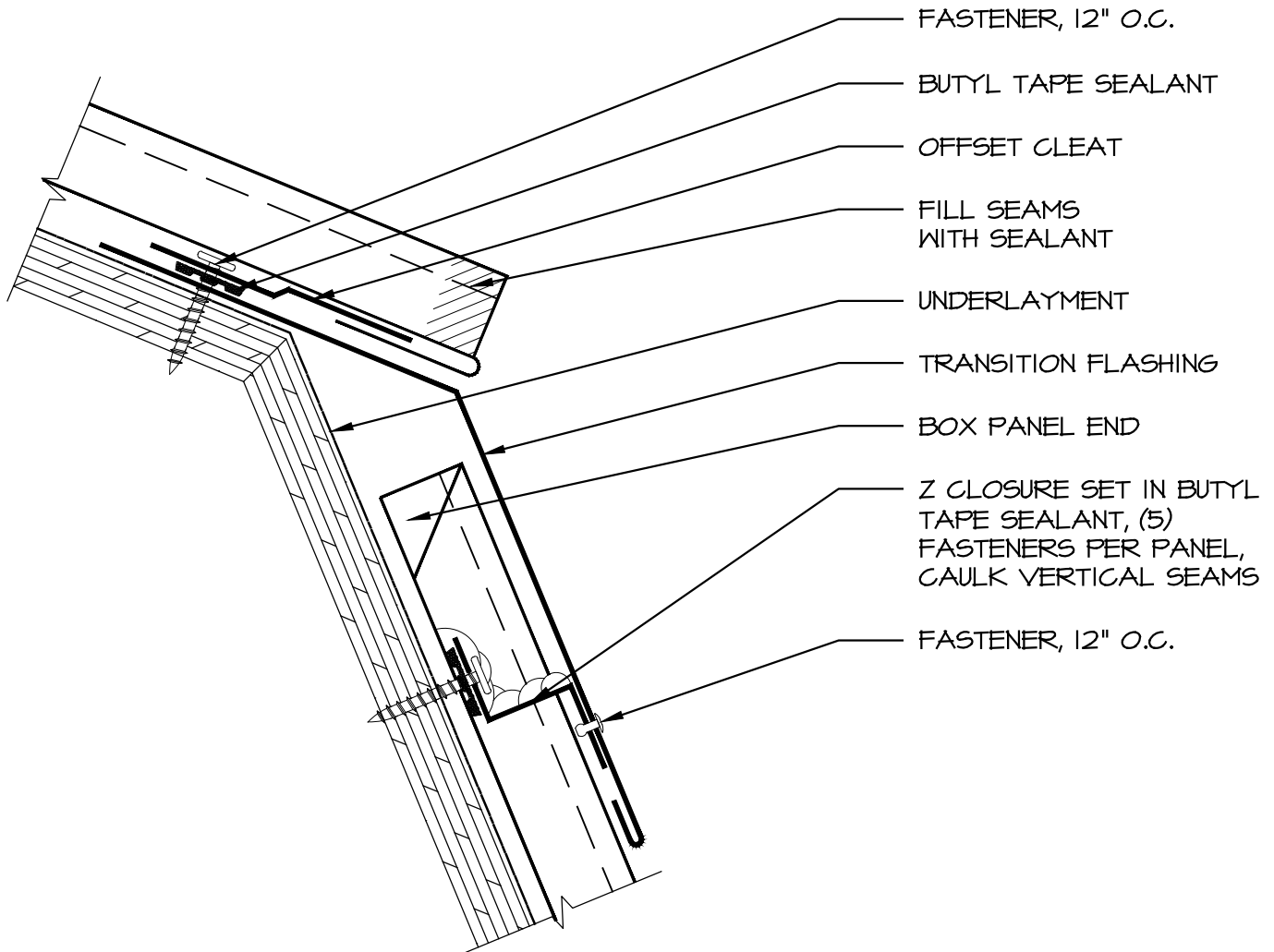

Transition Low-High

NOTES:

1. Install lower roof panels.
2. Install Z closures to lower roof panels.
3. Install Low High Transition over Z closure, make sure the transition covers closures. Fasten 12" o.c.
4. Fasten upper leg of transition every 12".
5. Install offset cleat on upper leg of transition.
6. Notch upper roof panel 1" and form around offset cleat.

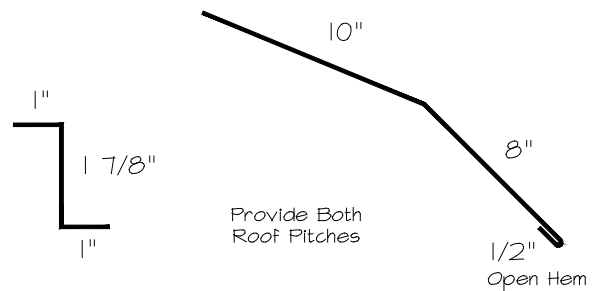

Transition Low High

10'-2" Pcs.

1-3/4" Tru-Snap

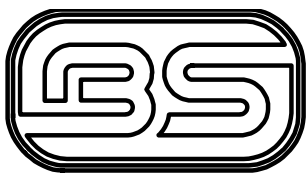

BRIDGERSTEEL

CREATE LASTING BEAUTY

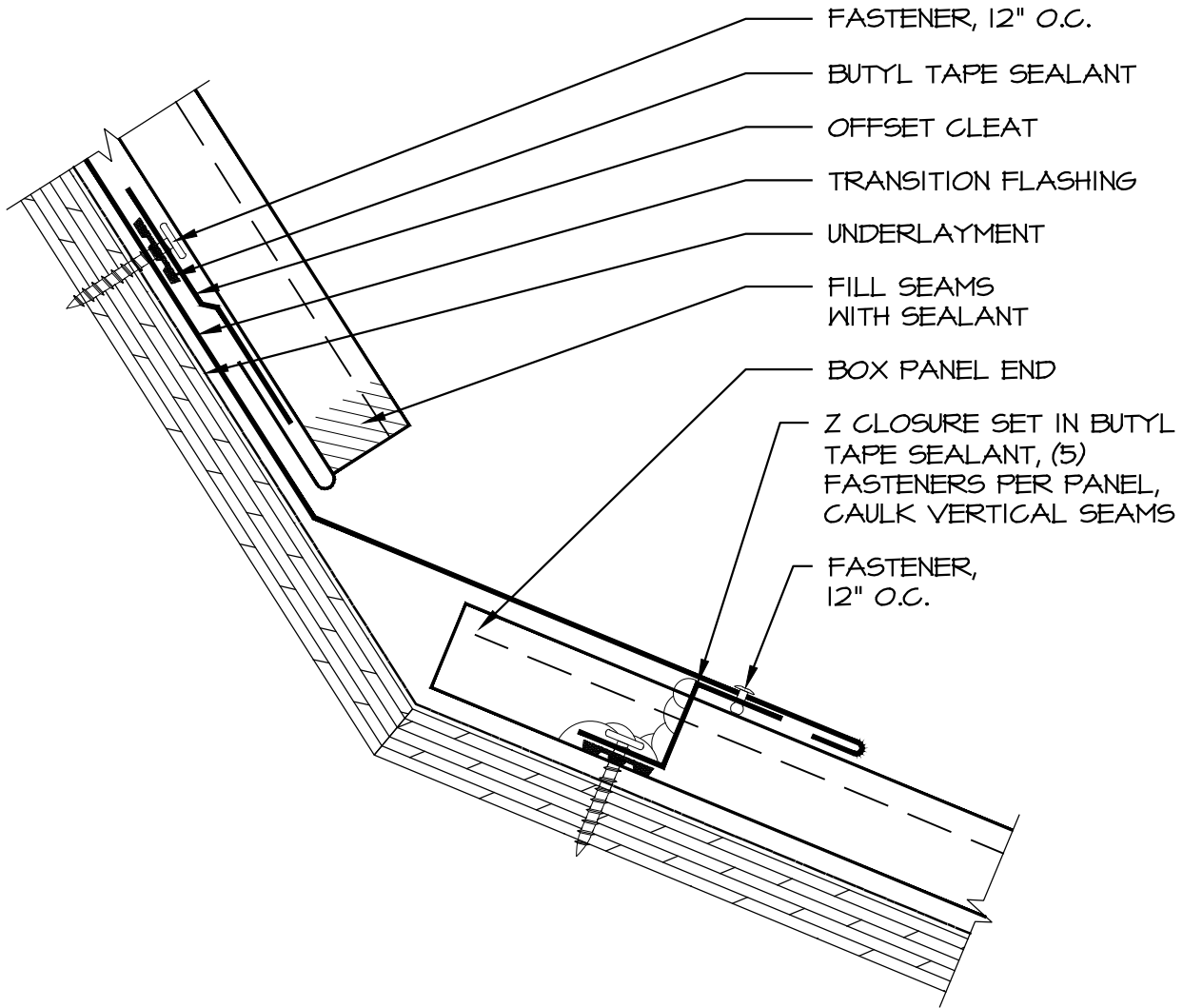

NOTES:

1. Install lower roof panels.
2. Install Z closures to lower roof panels.
3. Install High Low Transition over Z closure, make sure the transition covers closures. Fasten 12" o.c.
4. Fasten upper leg of transition every 12".
5. Install offset cleat on upper leg of transition.
6. Notch upper roof panel 1" and form around offset cleat.

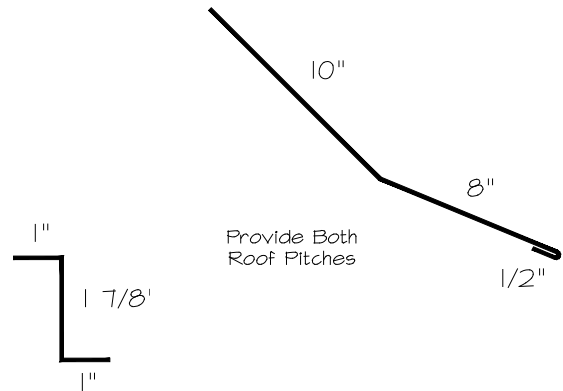

Transition High Low

10'-2" Pcs.

Transition High - Low

1 - 3/4" Tru-Snap

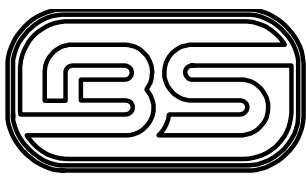

BRIDGERSTEEL

CREATE LASTING BEAUTY

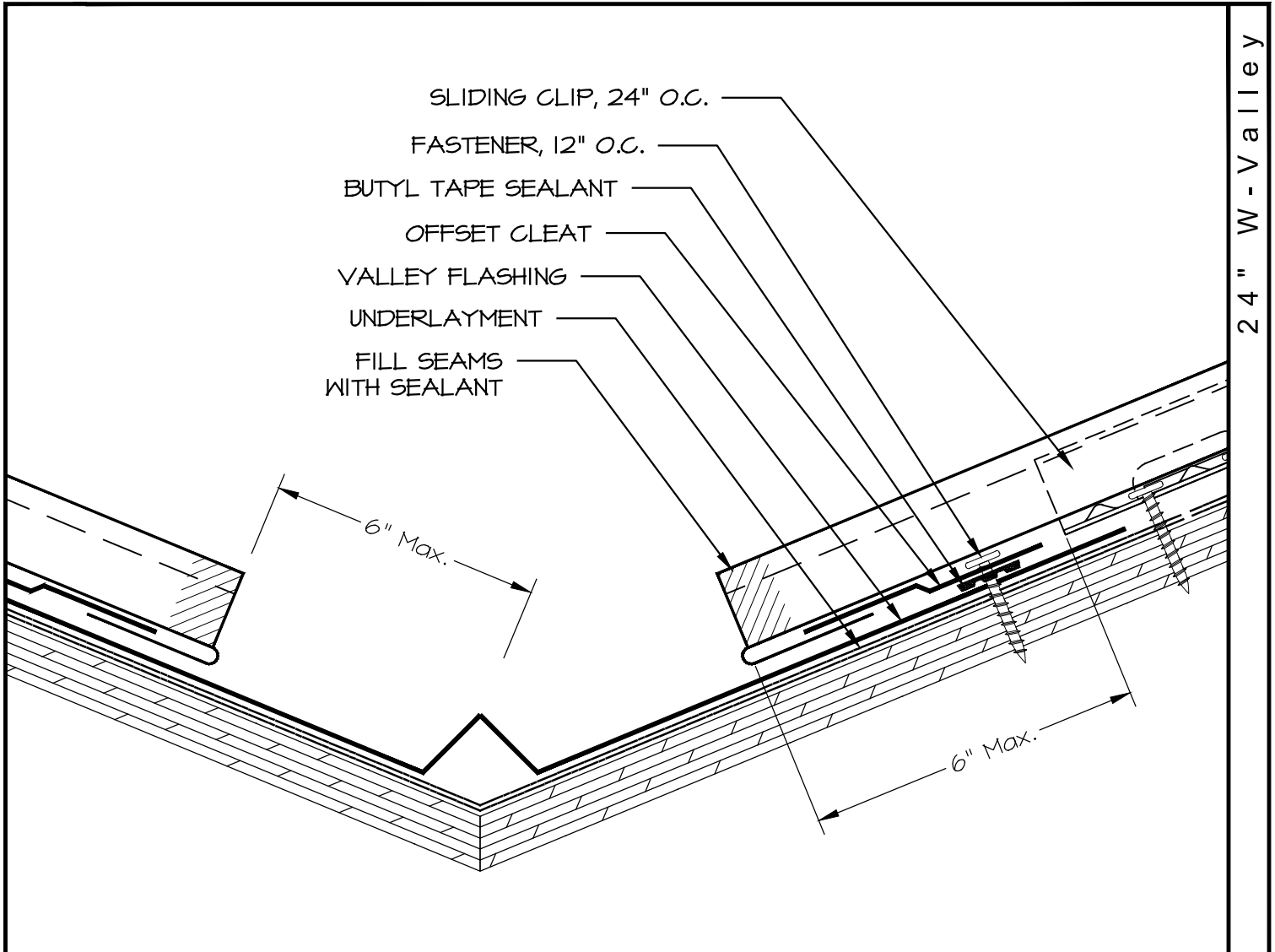

NOTES:

1. Install underlayment in bottom of the valley.
2. Lay valley panel down and fasten 2" from the outside edge every 12" o.c.
3. Apply second layer of underlayment over outer edge of valley, approximately 3" down on both sides of the valley.
4. Install offset cleats on both sides of valley.
5. Notch panels 1" and form around offset cleat.

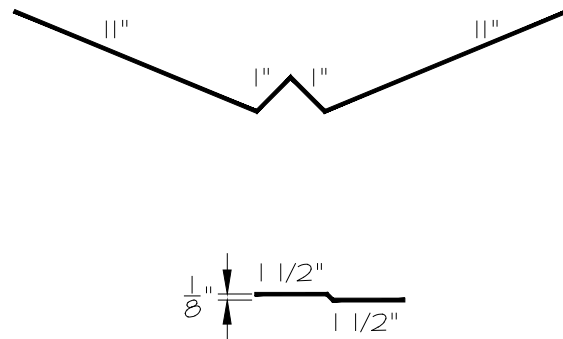

24" W-Valley

10'-2" Pcs.

24" W-Valley

1-3/4" Tru-Snap

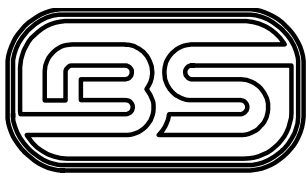

BRIDGERSTEEL

CREATE LASTING BEAUTY

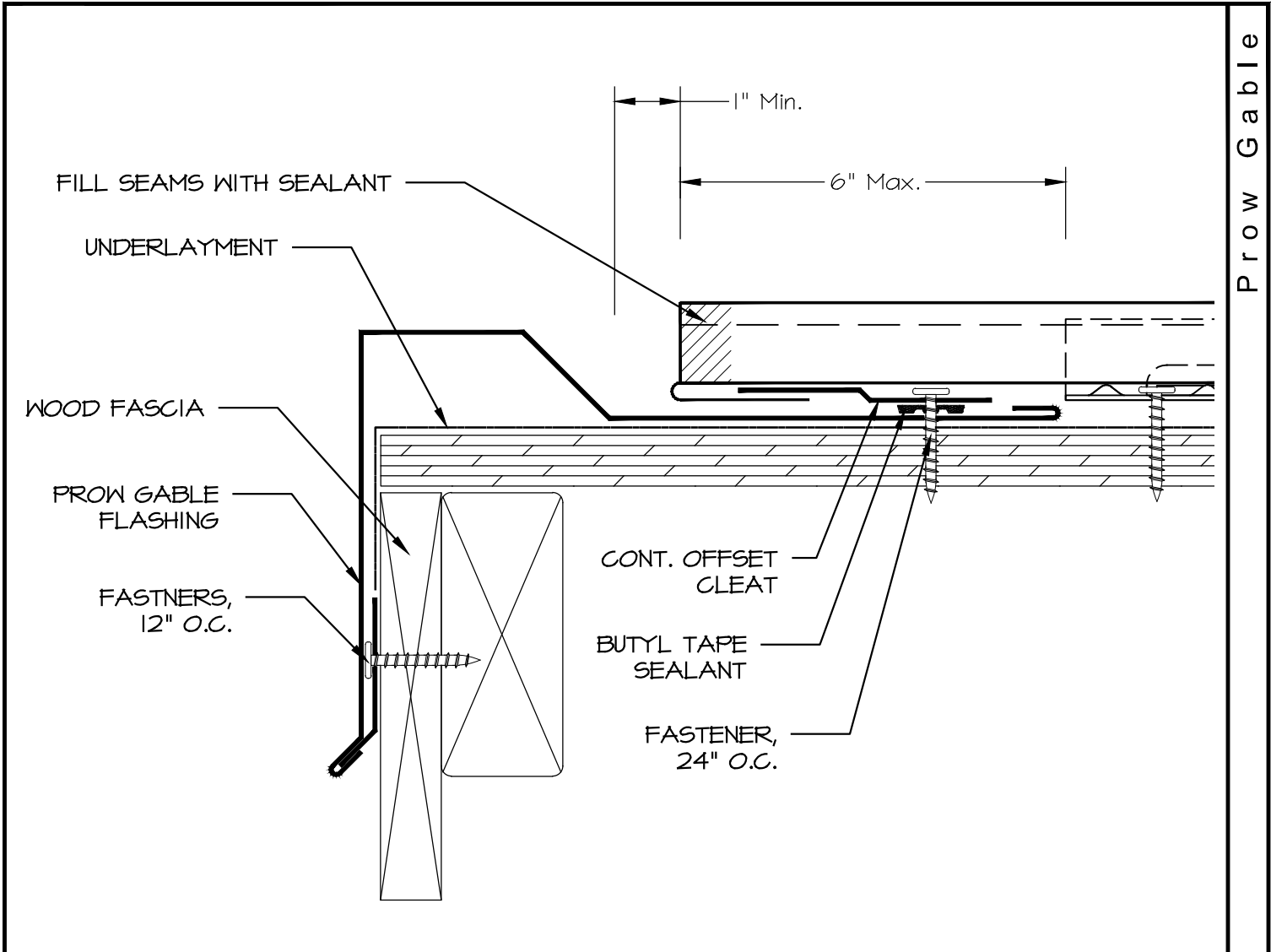

Prow Gable

NOTES:

1. Install underlayment over edge of prow gable.
2. Lay prow gable trim down and fasten 2" from the outside edge every 12" o.c.
3. Apply universal closure under panel leaving panel 1" from flashing closure.
4. Install offset cleat.
5. Notch panels 1" and form around offset cleat.

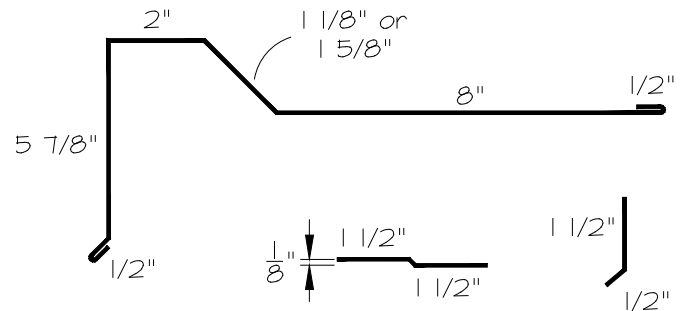

Open Prow Gable

10'-2" Pcs.

1-3/4" Tru-Snap

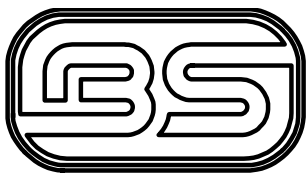

BRIDGERSTEEL

CREATE LASTING BEAUTY

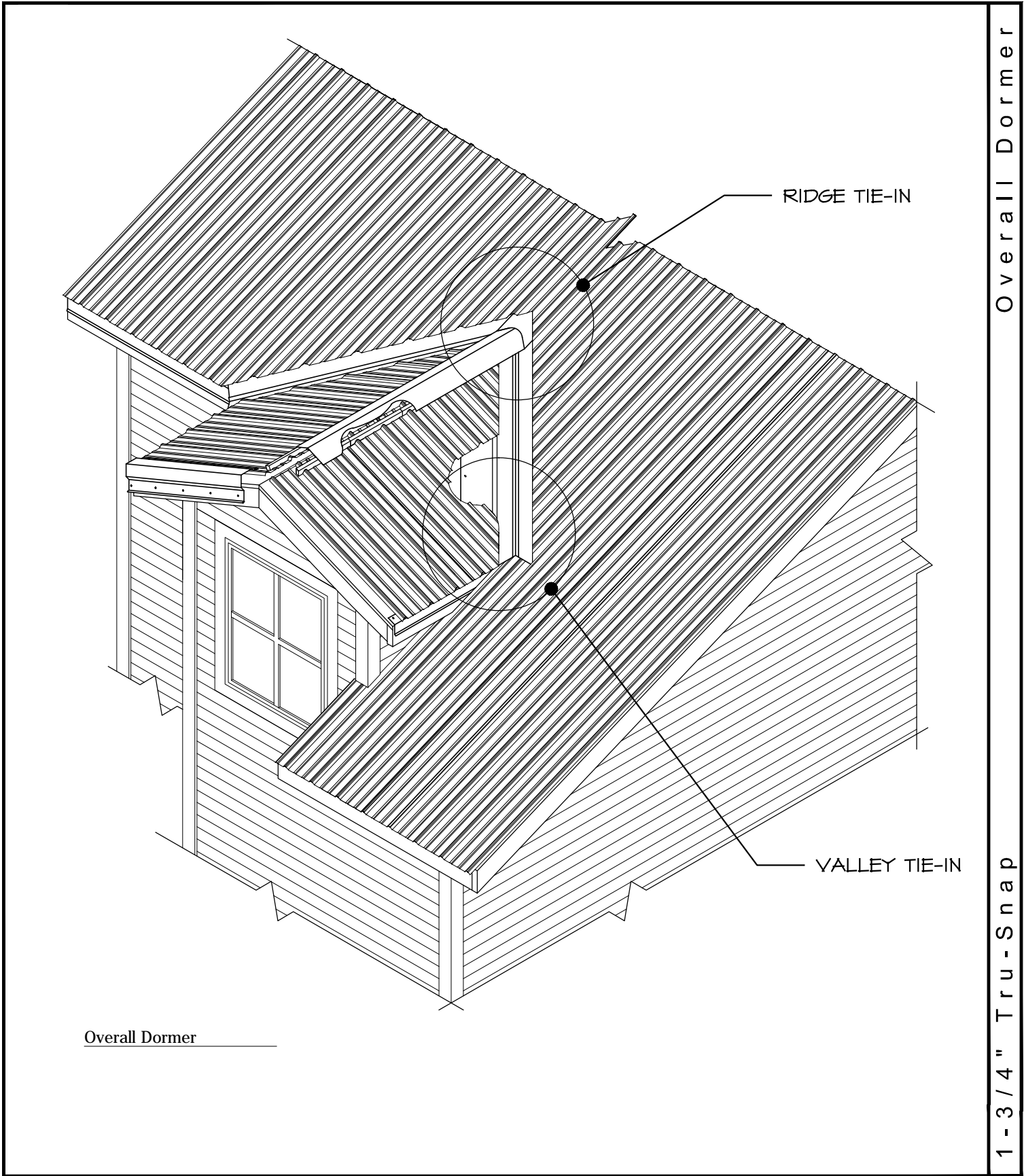

Overall Dormer

Overall Dormer

1-3/4" Tru-Snap

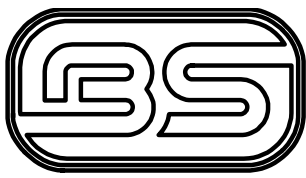

BRIDGERSTEEL

CREATE LASTING BEAUTY

Ridge Tie-In

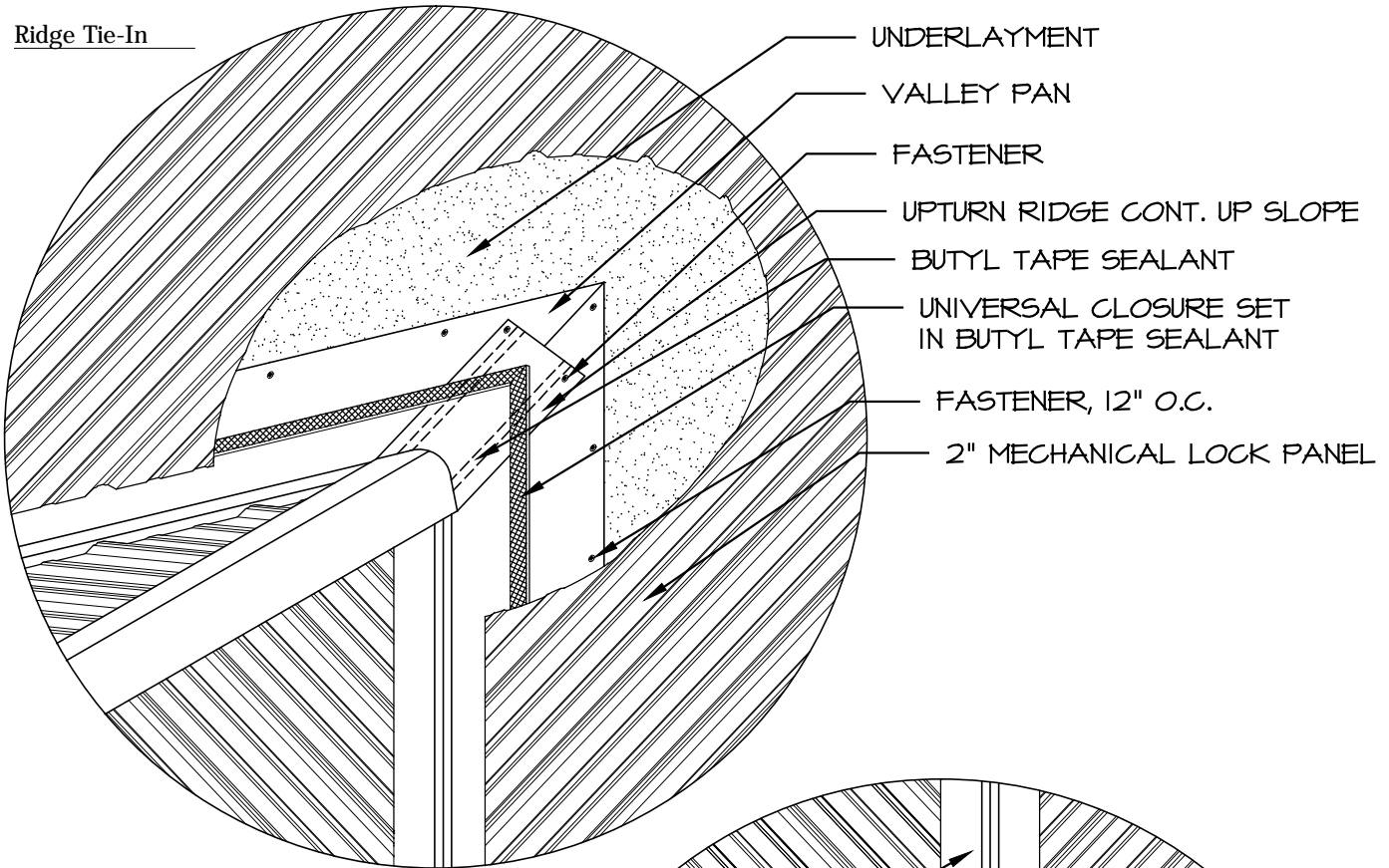

Valley Tie-In

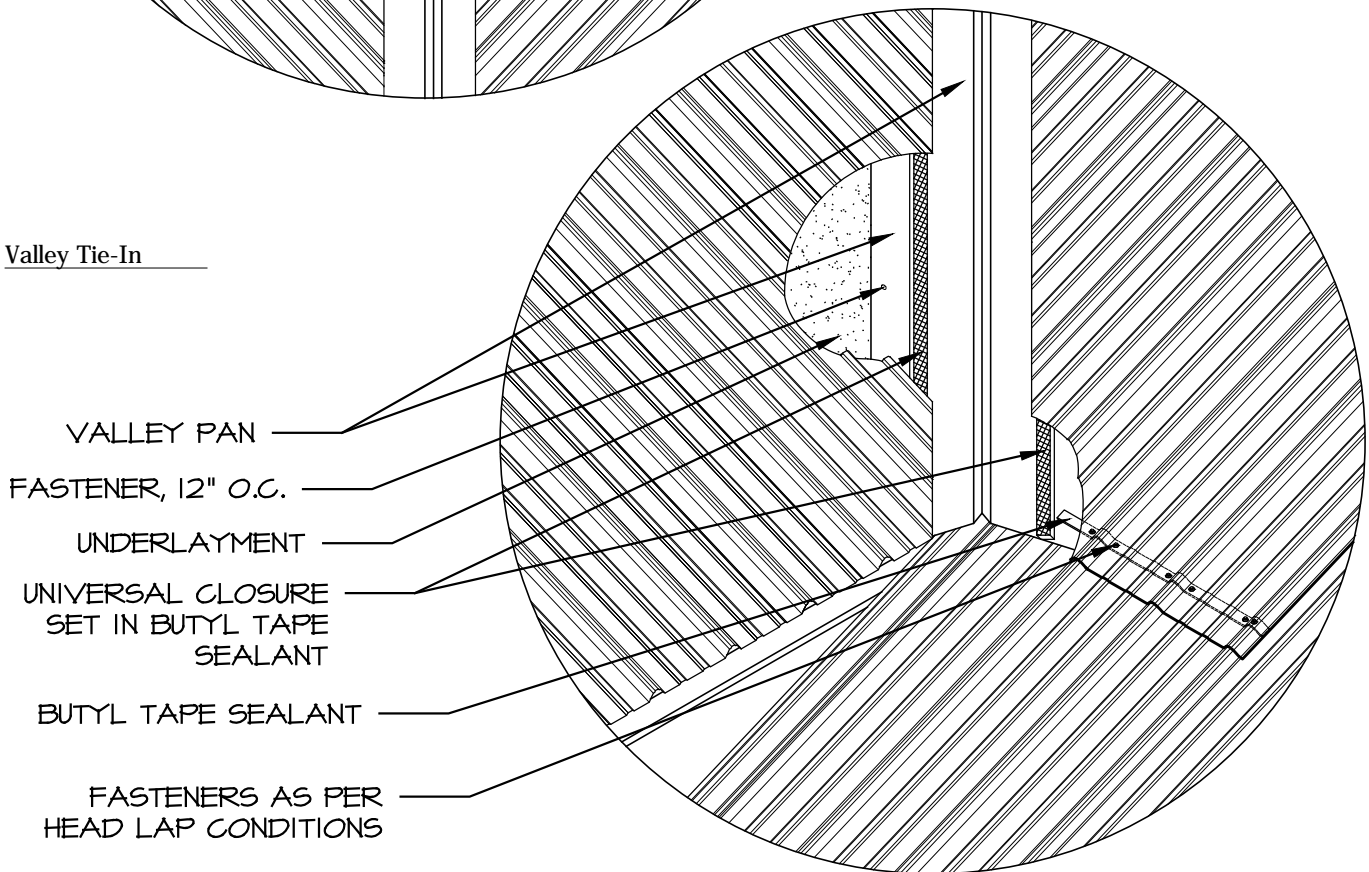

Dormer Tie-In

1-3/4" Tru-Snap

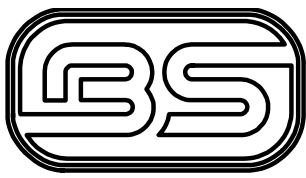

BRIDGERSTEEL

CREATE LASTING BEAUTY

