

Motors

Specification of Electric Motors

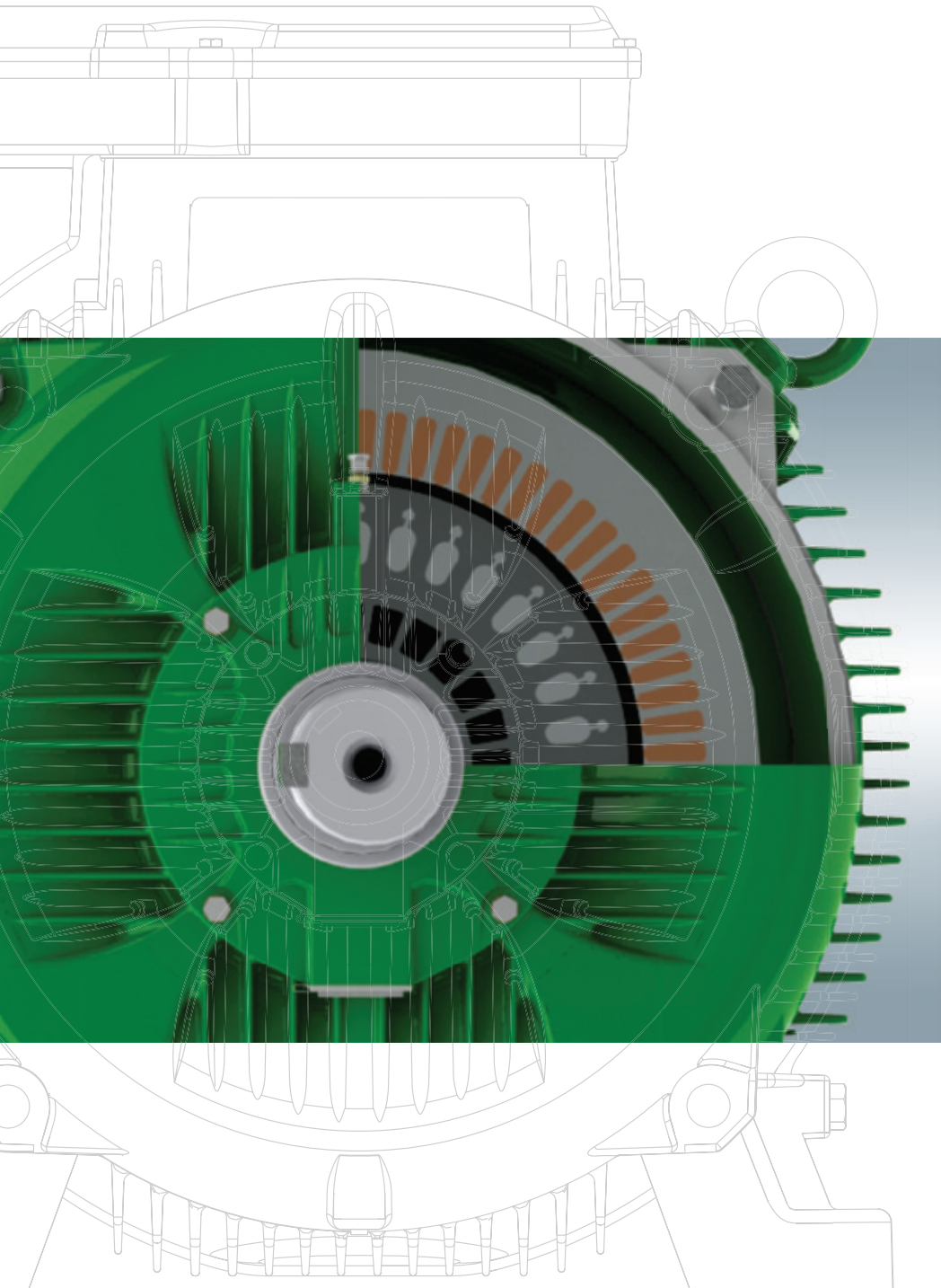

Specification of Electric Motors

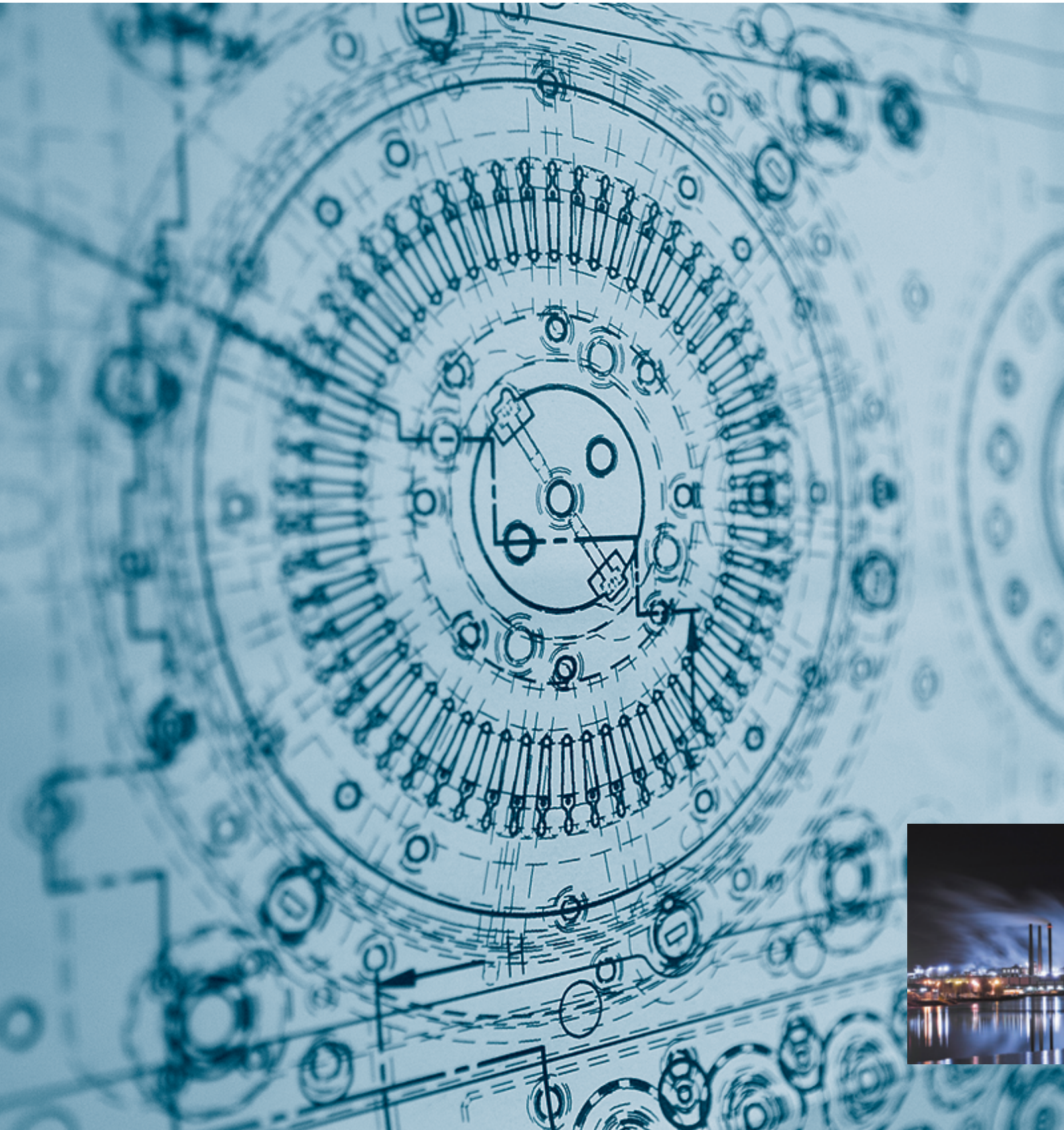



WEG, which began in 1961 as a small factory of electric motors, has become a leading global supplier of electronic products for different segments. The search for excellence has resulted in the diversification of the business, adding to the electric motors products which provide from power generation to more efficient means of use.

This diversification has been a solid foundation for the growth of the company which, for offering more complete solutions, currently serves its customers in a dedicated manner. Even after more than 50 years of history and continued growth, electric motors remain one of WEG's main products. Aligned with the market, WEG develops its portfolio of products always thinking about the special features of each application.

In order to provide the basis for the success of WEG Motors, this simple and objective guide was created to help those who buy, sell and work with such equipment. It brings important information for the operation of various types of motors. Enjoy your reading.



Table of Contents

1. Fundamental Concepts.....	6	5. Speed Regulation of Asynchronous Motors	30
1.1 Electric Motors	6	5.1 Changing the Number of Poles.....	30
1.2 Basic Concepts.....	7	5.1.1 Two Speed Motors with Independent Windings.....	30
1.2.1 Torque.....	7	5.1.2 Dahlander	30
1.2.2 Mechanical Energy & Power.....	7	5.1.3 Motors with Two or More Speeds.....	31
1.2.3 Electrical Energy & Power	7	5.2 Slip Variation	31
1.2.4 Apparent, Active and Reactive Power	8	5.2.1 Rotor Resistance Variation.....	31
1.2.5 Power Factor.....	9	5.2.2 Stator Voltage Variation	31
1.2.6 Efficiency.....	11	5.3 Frequency Inverters	31
1.2.7 Torque Versus Power Ratio	11		
1.3 Single-Phase AC Systems.....	11	6. Brake Motor.....	31
1.3.1 Connection: Parallel and Series	11	6.1 Brake Operation.....	32
1.4.2 Star Connection	12	6.2 Connection Diagram	32
1.4 Three-Phase AC System.....	12	6.3 Brake Coil Power Supply	33
1.4.1 Delta Connection	12	6.4 Brake Torque	33
1.5 Three-Phase Induction Motor.....	13	6.5 Air Gap Adjustment.....	33
1.5.1 Working Principle - Rotating Field	13		
1.5.2 Synchronous Speed (ns)	14	7. Operating Characteristics	34
1.5.3 Slip (s).....	15	7.1.1 Winding Heating Up.....	34
1.5.4 Rated Speed	15	7.1.2 Motor Lifetime	35
1.6 Insulation Materials and Insulation Systems	15	7.1.3 Insulation Classes	35
1.6.1 Insulation Material	15	7.1.4 Winding Temperature Rise Measurement	35
1.6.2 Insulation System	15	7.1.5 Electric Motor Application	36
1.6.3 Thermal Classes	15	7.2 Thermal Protection of Electric Motors.....	36
1.6.4 Insulating Materials in Insulation Systems.....	16	7.2.1 Resistance Temperature Detector (Pt-100).....	36
1.6.5 WEG Insulation System	16	7.2.2 Thermistors (PTC and NTC)	36
		7.2.3 Bimetal Thermal Protectors - Thermostats	37
2. Power Supply Characteristics	18	7.2.4 Phenolic Thermal Protection System	38
2.1 Power Supply System	18	7.3 Service Duty	39
2.1.1 Three-Phase System.....	18	7.3.1 Standardized Service Duties.....	39
2.1.2 Single-Phase System	18	7.3.2 Duty Type Designation.....	42
		7.3.3 Rated Output	43
3. Characteristics of the Electric Motor Power Supply.....	18	7.3.4 Equivalent Power Ratings for Low Inertia Loads	43
3.1 Rated Voltage.....	18	7.4 Service Factor (SF).....	44
3.1.1 Multiple Rated Voltage	18		
3.2 Rated Frequency (Hz)	19	8. Environment Characteristics.....	44
3.2.1 Connection to Different Frequencies.....	19	8.1 Altitude.....	44
3.3 Voltage and Frequency Variation Tolerance.....	20	8.2 Ambient Temperature	44
3.4 Three-Phase Motor Starting Current Limitation	20	8.3 Determining Useful Motor Output at Different Temperature and Altitude Conditions.....	44
3.4.1 D.O.L Starting.....	20	8.4 Environment.....	45
3.4.2 Starting with Star-Delta Switch (Y - Δ).....	21	8.4.1 Aggressive Environments.....	45
3.4.3 Compensating Switch	23	8.4.2 Environments Containing Dusts and Fibers	45
3.4.4 Comparing Star-Delta Starters and	24	8.4.3 Explosive Atmospheres	45
3.4.5 Series-Parallel Starting.....	24	8.5 Degree of Protection	45
3.4.6 Electronic Start (Soft-Starter)	25	8.5.1 Identification Codes	45
3.5 Direction of Rotation of Three-Phase Induction Motors	25	8.5.2 Usual Degrees of Protection	46
		8.5.3 Weather Protected Motors.....	46
4. Acceleration Characteristics	25	8.6 Space Heater	46
4.1 Torque.....	25	8.7 Noise Levels.....	47
4.1.1 Torque X Speed Curve	25		
4.1.2 Designs - Minimum Standardized Torque Values.....	26		
4.1.3 Characteristics of WEG Motors	28		
4.2 Load Inertia	28		
4.3 Acceleration Time	28		
4.4 Duty Cycles	29		
4.5 Locked Rotor Current	29		
4.5.1 Standardized Maximum Values.....	29		

9. Explosive Atmosphere48

9.1 Hazardous Area..... 48
 9.2 Explosive Atmosphere..... 48
 9.3 Classification of Hazardous Areas 48
 9.3.1 Classes and Groups of the Hazardous Areas.... 48
 9.3.2 Protection by Enclosure..... 49
 9.4 Temperature Classes..... 50
 9.5 Equipment for Explosive Atmospheres..... 50
 9.6 Increased Safety Equipment..... 50
 9.7 Explosion-Proof Equipment..... 51

10. Mounting Arrangements.....51

10.1 Dimensions..... 51
 10.2 Standardized Type of Construction and Mounting Arrangement 52
 10.3 Painting 54
 10.3.1 Tropicalized Painting..... 54

11. Three-Phase Electric Motor Selection and Application54

11.1 Motor Type Selection for Different Loads..... 56
 11.2 WMagnet Drive System® 58
 11.3 Application of Induction Motors with Variable Frequency Drives..... 58
 11.3.1 Normative Aspects 58
 11.3.2 Induction Machine Speed Variation by Frequency Inverter 58
 11.3.3 Characteristics of the Frequency Inverter 59
 11.3.3.1 Control Types 59
 11.3.3.2 Harmonics 60
 11.3.4 Inverter Influencing Motor Performance..... 60

12. Environmental Information.....63

12.1 Packaging 63
 12.2 Product..... 63

13. Tests63

13.1 Variable Frequency Drive Motors 63

14. Appendix.....64

14.1 International System of Units 64
 14.2 Unit Conversion..... 65
 14.3 Standards..... 66

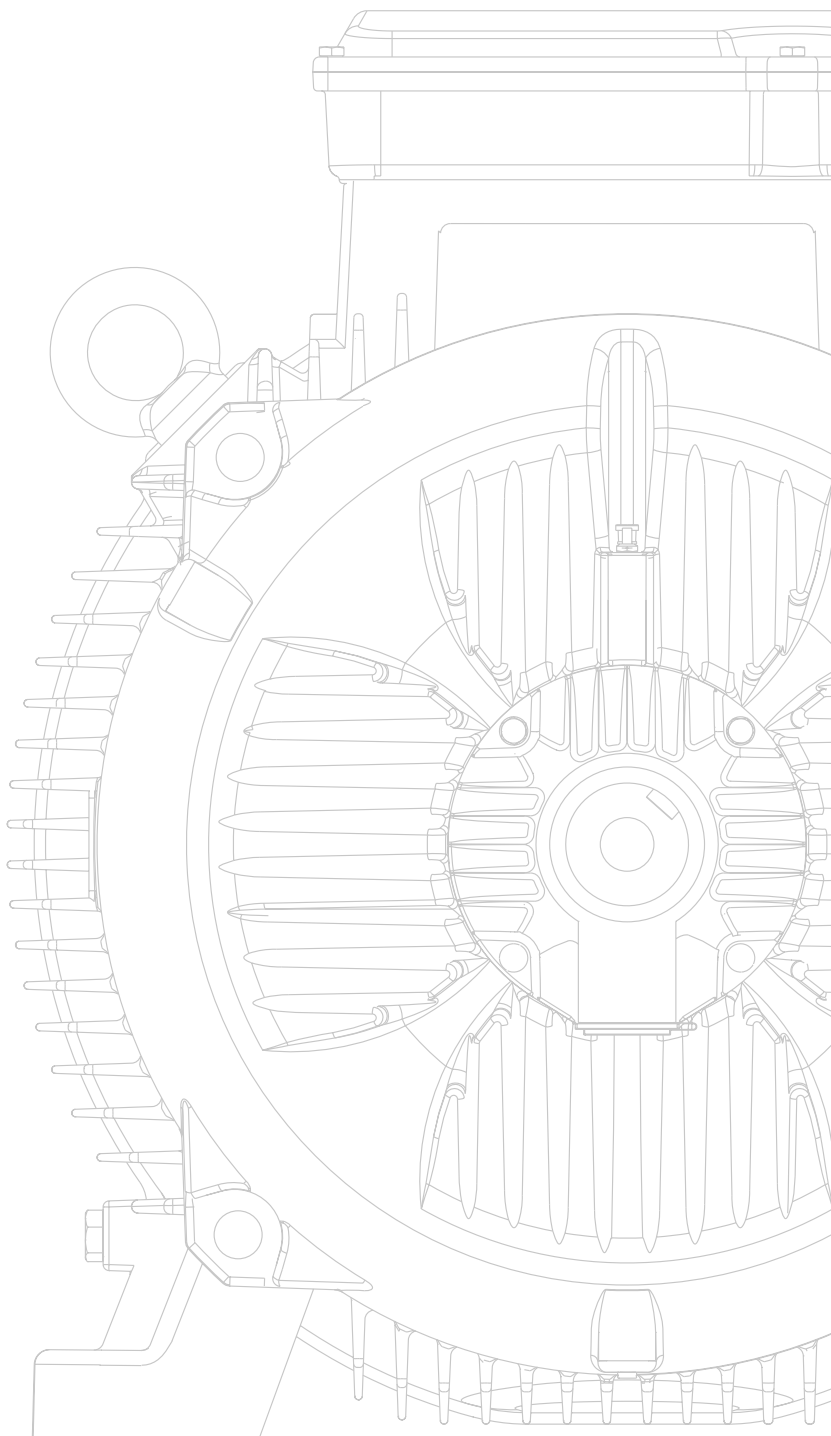

1. Fundamental Concepts

1.1 Electric Motors

The electric motor is a machine capable of converting electrical energy into mechanical energy. The induction motor is the most widely used type of motor, because it combines all the advantages offered by the electrical energy such as low cost, easy of supply and distribution, clean handling and simple controls - together with those of simple construction and its great versatility to be adapted to wide ranges of loads and improved efficiencies. The most common types of electric motors are:

a) Direct current motors

These motors are quite expensive requiring a direct current source or a converting device to convert normal alternating current into direct current. They are capable of operating with adjustable speeds over a wide range and are perfectly suited for accurate and flexible speed control. Therefore, their use is restricted to special applications where these requirements compensate the much higher installation and maintenance costs.

b) Alternating current motors

These are the most frequently used motors because electrical power is normally supplied as alternating current. The most common types are:

Synchronous motors: synchronous motors are three-phase AC motors which run at fixed speed, without slip, and are generally applied for large outputs (due to their relatively high costs in smaller frame sizes).

Induction motor: these motors generally run at a constant speed which changes slightly when mechanical loads are applied to the motor shaft. Due to its simplicity, robustness and low cost, this type of motor is the most widely used and, in practical terms, is quite suitable for almost all types of machines. Currently it is possible to control the speed of induction motors by frequency inverters.

Technological Universe of Electric Motors

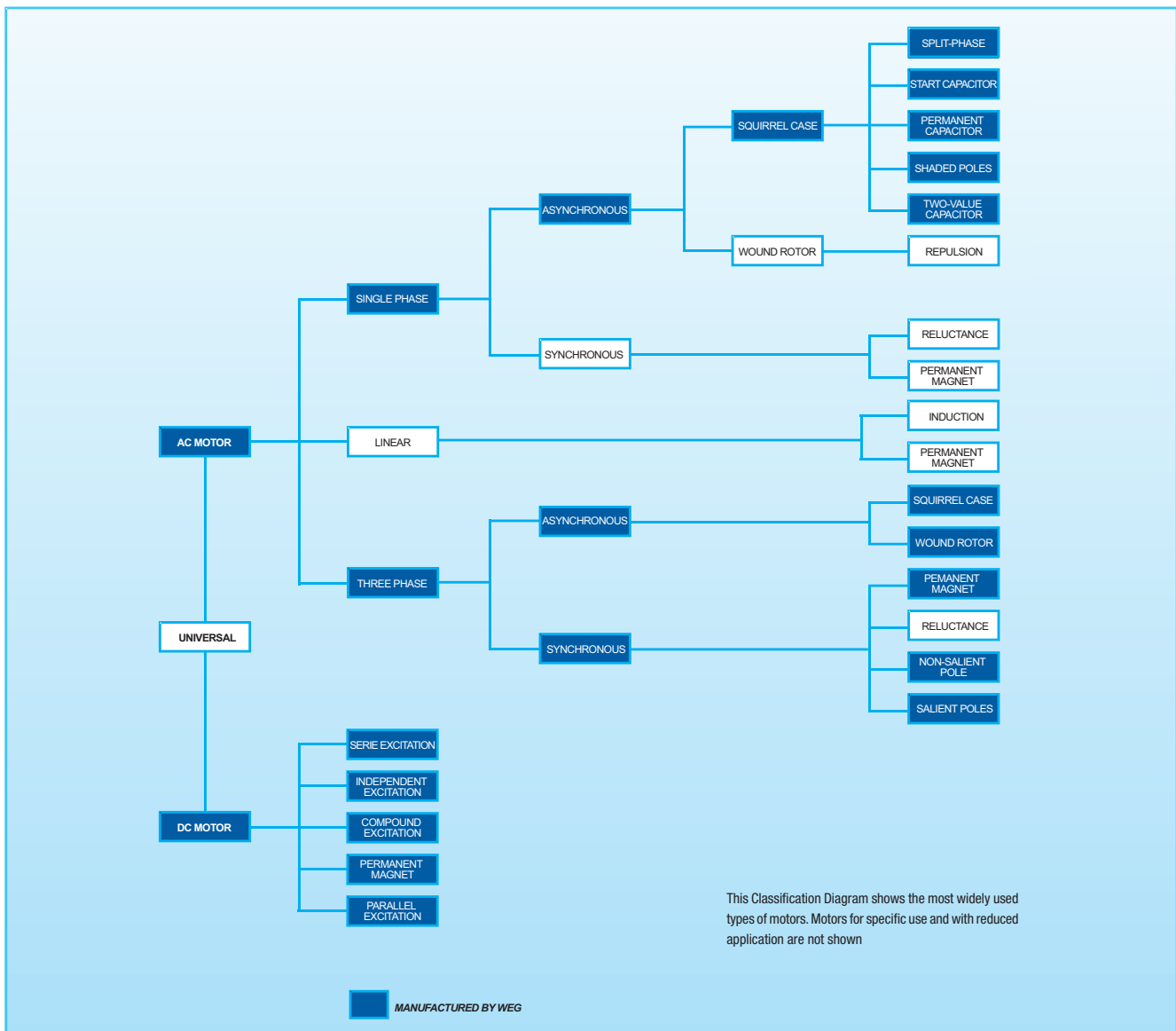

Table 1.1

1.2 Basic Concepts

For better understanding of the following sections we will now review some principles of Physics concerning energy and forces.

1.2.1 Torque

Torque, also known as moment of force, is the measure of energy required to rotate a shaft. Through practical experience we can note that for lifting a weight similar to the one used in water wells (see fig. 1.1). the required force “F” to be applied on the winch depends on the length “E” of the crank handle. The longer the crank handle the less force is required. By doubling the length “E” of the crank handle, the required force “F” is reduced by half.

Figure 1.2.1 a shows that the bucket weights 20 N while the diameter of the drum is 0.20 m, thus permitting the rope to transmit a force of 20 N on the drum’s surface, i.e. at 0.10 m from the axis centre. In order to counterbalance this force, 10 N is must be applied on the crank handle if “E” has a length of 0.20 m. If “E” is twice as much, i.e. 0.40 m, force “F” becomes half, or 5 N. As you can see, to measure the “energy” required to make the shaft rotate, it is not sufficient to define the force applied but it is also necessary to indicate at what distance from the shaft center the force is applied. You must also inform at what distance from the shaft center the force is applied. The “energy” is measured by the torque. that is the result of “F” (force) x “E” (distance). F x E. In the given example, the torque is:

$$C = 20 \text{ N} \times 0.10 \text{ m} = 10 \text{ N} \times 0.20 \text{ m} = 5 \text{ N} \times 0.40 \text{ m} = 2.0 \text{ Nm}$$

$$C = F \cdot E \quad (\text{N} \cdot \text{m})$$

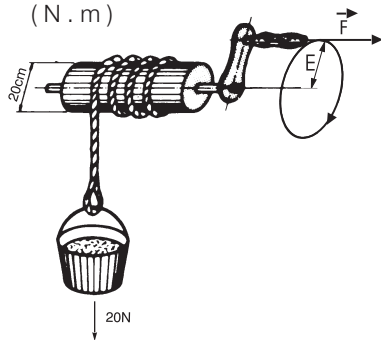

Figure 1.1

1.2.2 Mechanical Energy & Power

Power is a measure of how fast energy is applied or consumed. In the previous example, if the well is 24.5 m deep the work or energy (W) spent to lift the bucket from the bottom of the well up to the wellhead will always be the same: 20 N x 24.6 m = 490 Nm

Note: the measuring unit for the mechanical energy. Nm, is the same that is used for torque - however the values are of different nature and therefore should not be confused.

$$W = F \cdot d \quad (\text{N} \cdot \text{m})$$

OBS.: 1 Nm = 1 J = Power x time = Watts x second

Power expresses how quick the energy is applied, it is calculated by dividing the total energy or work by the time in which it is done.

Therefore by using an electric motor to lift a water bucket in 2.0 seconds, the required Power will be:

$$P_{\text{mec}} = \frac{F \cdot d}{t} \quad (\text{W})$$

$$P_1 = \frac{490}{2.0} = 245 \text{ W}$$

If we use a higher power rating motor, able to do this work in 1.3 seconds, the required power will be:

$$P_2 = \frac{490}{1.3} = 377 \text{ W}$$

The most common used unit in Brazil for measuring the mechanical power is HP (horsepower), equivalent to 0.736 kW (measuring unit used internationally for the same purpose).

Relationship between power units

$$P (\text{kW}) = 0.736 \cdot P (\text{cv})$$

$$P (\text{cv}) = 1.359 P (\text{kW})$$

In this case the outputs of the above mentioned motors will be:

$$P_1 = \frac{245}{736} = \frac{1}{3} \text{ cv} \quad P_2 = \frac{377}{736} = \frac{1}{2} \text{ cv}$$

For circular movements

$$C = F \cdot r \quad (\text{N.m})$$

$$v = \frac{\pi \cdot d \cdot n}{60} \quad (\text{m/s})$$

$$P_{\text{mec}} = \frac{F \cdot d}{736 \cdot t} \quad (\text{cv})$$

Where: C = torque (Nm)

F = force (N)

r = pulley radius (m)

v = angular speed (m/s)

d = part diameter (m)

n = speed (rpm)

1.2.3 Electrical Energy & Power

Although energy is always one and the same thing, it can be presented in several forms. By connecting a resistance to a voltage supply, an electric current will flow through the resistance that will be heated. The resistance absorbs energy, transforming it into heat which is also a form of energy. An electric motor absorbs electric energy from the power supply, transforming it into mechanical energy available at the end of the shaft.

DC Circuits

The “electric power” on DC circuits can be obtained by the ratio among voltage (U), current (I) and resistance (R) involved in such circuit, that is:

$$P = U \cdot I \quad (W)$$

or,

$$P = \frac{U^2}{R} \quad (W)$$

or,

$$P = R \cdot I^2 \quad (W)$$

Where: U = voltage (V)
 I = current (Amperes)
 R = resistance (Ω)
 P = average Power (W)

AC Circuits

a) Resistance

In the case of “resistances”, the higher the supply voltage, the higher the current that results in faster heating of the resistance. This means that the electric power will be higher. The electric energy absorbed from the line, in case of resistance, is calculated by multiplying the line voltage by the current, if the resistance (load) is single-phase.

$$P = U_f \cdot I_f \quad (W)$$

In a three-phase system, the power in each phase of the load is $P_f = U_f \times I_f$ as it were an independent single-phase system. The total power is the sum of the power of the three-phases, i.e.:

$$P = 3P_f = 3 \cdot U_f \cdot I_f$$

Considering that the three-phase system can be delta or star connected, we will have following relationships:

Star-connection: $U = \sqrt{3} \cdot U_f$ e $I = I_f$

Delta-connection: $U = U_f$ e $I = \sqrt{3} \cdot I_f$

Thus, the total power for both connections will:

$$P = \sqrt{3} \cdot U \cdot I \quad (W)$$

Note: this formula applies to resistive loads only, i.e. where there is no phase shift of the current.

b) Reactive loads

For “reactive” loads, i.e. where there is phase shifting in the case of induction motors, the phase shift must be taken into account and the formula then becomes

$$P = \sqrt{3} \cdot U \cdot I \cdot \cos \varphi \quad (W)$$

Where: U = Line voltage
 I = Line current
 $\cos \varphi$ = Phase shift angle between voltage and current.

Electric power is normally measured in watts (W) corresponding to 1 volt x 1 ampere or its multiple kilowatt (kW) = 1000 watts. This unit may also be used to measure the output of mechanical power. Electric energy is normally measured by kilowatt-hour (kWh) corresponding to the energy supplied by a power of 1 kW over a period of 1 hour (this is the unit appearing on electricity bills).

1.2.4 Apparent, Active and Reactive Power

Apparent power (S)

It is the multiplication result of the voltage by the current ($S = U \cdot I$ for single-phase systems and $S = \sqrt{3} \cdot U \cdot I$, for three-phase systems. This corresponds to the effective power which exists when there is no phase displacement of the current, i. e. for the resistive loads. Then,

$$S = \frac{P}{\cos \varphi} \quad (VA)$$

Evidently, for resistive loads, $\cos \varphi = 1$, and the effective power can then be interpreted as apparent power. The measuring unit for apparent power is volt-ampere (VA) or its multiple, kilovolt-ampere (kVA).

Active power (P)

It is the portion of apparent power that performs work, that is, the portion that is converted into energy.

$$P = \sqrt{3} \cdot U \cdot I \cdot \cos \varphi \quad (W) \quad \text{ou} \quad P = S \cdot \cos \varphi \quad (W)$$

Reactive power (Q)

It is the portion of apparent power that does “not” perform work. It is only transferred and stored on passive elements (capacitors and inductors) of the circuit.

$$Q = \sqrt{3} \cdot U \cdot I \cdot \sin \varphi \quad (VAr) \quad \text{ou} \quad Q = S \cdot \sin \varphi \quad (VAr)$$

Power triangle

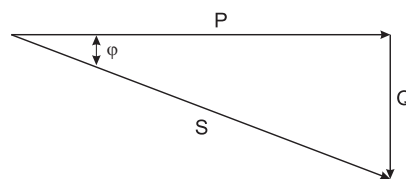

Figure 1.2 - Power Triangle (inductive load)

1.2.5 Power Factor

Power factor is indicated by $\cos \varphi$, where φ is the angle of voltage displacement relating to the current. It is the relationship between active (P) and the apparent power (S): (figure 1.2).

$$\cos \varphi = \frac{P}{S} = \frac{P \text{ (kW)} \cdot 1000}{3 \cdot U \cdot I}$$

Then we can state that,

- Resistive load: $\cos \varphi = 1$
- Inductive load: $\cos \varphi$ (delayed)
- Capacitive load: $\cos \varphi$ (advanced)

Note: the terms "delayed" and "advanced" refers to the current angle relating to the voltage angle.

A motor does not draw only active power, transformed after in mechanical power and heat (losses), but also absorbs reactive power needed for magnetization, but that does not produce work. On the diagram of figure 1.3, the vector P represents the active power and Q the reactive Power, which added results in the apparent power S.

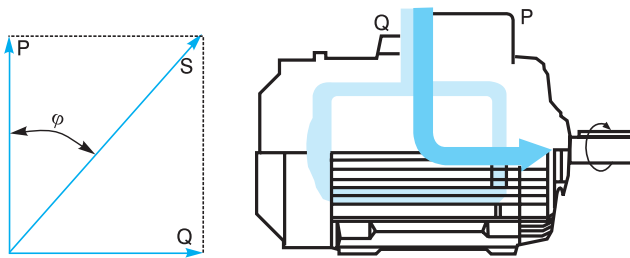

Figure 1.3 - The Power factor is determined measuring the input power, the voltage and the rated load

The electric motor plays a very important role in the industry, since it represents more than 60% of the energy consumption. Therefore, it is essential to apply motors with outputs and features well adapted to its function since the power factor changes with motor load.

Power factor correction

The increase of power factor is made by the connection of a capacitive load, in general, a capacitor or a synchronous motor with overexcitation, in parallel with the load.

For example:

A three-phase electric motor, 100 HP (75 kW), 4 poles, running at 100% of the rated power, with original Power Factor of 0.87 and efficiency of 93.5%. Now a reactive power should be determined to raise the power factor to 0.95.

Solution:

Using the table 1.2, on the intersection of 0.87 line with the column of 0.95, we get the value 0.238 that multiplied by the motor absorbed power from the line in KW, gives the amount of reactive power necessary to increase the power factor from 0.87 to 0.95.

$$\begin{aligned} \text{kVAr} &= \frac{P \text{ (HP)} \times 0.736 \times F \times 100\%}{\text{Eff. \%}} \\ &= \frac{100 \times 0.736 \times 0.238 \times 100\%}{93.5\%} \\ \text{kVAr} &= 18.735 \text{ kVAr} \end{aligned}$$

Where; kVAr = Three-phase power of the capacitor bank to be installed
 P(hp) = Motor rated output
 F = Factor obtained in the Table 1.2
 Eff. % = Motor efficiency



1.2.6 Efficiency

The efficiency defines how efficient is made the conversion of the line absorbed electric energy into mechanical energy available at the shaft end. The efficiency defines how this transformation is made. By calling mechanical power available at the shaft end “output” (P_u) and electric energy absorbed by the motor from the supply “input” (P_a), the efficiency is the ratio between these two, i.e.,

$$\eta = \frac{P_u \text{ (W)}}{P_a \text{ (W)}} = \frac{736 \cdot P \text{ (cv)}}{\sqrt{3} \cdot U \cdot I \cdot \cos \varphi} = \frac{1000 \cdot P \text{ (kW)}}{\sqrt{3} \cdot U \cdot I \cdot \cos \varphi}$$

ou

$$\eta\% = \frac{736 \cdot P \text{ (cv)}}{\sqrt{3} \cdot U \cdot I \cdot \cos \varphi} \cdot 100$$

1.2.7 Torque Versus Power Ratio

When mechanical energy is applied in the form of a rotating movement, the developed output depends on the torque C and on the rotational speed n. The ratio is as follows:

$$P \text{ (cv)} = \frac{C \text{ (kgfm)} \cdot n \text{ (rpm)}}{716} = \frac{C \text{ (Nm)} \cdot n \text{ (rpm)}}{7024}$$

$$P \text{ (kW)} = \frac{C \text{ (kgfm)} \cdot n \text{ (rpm)}}{974} = \frac{C \text{ (Nm)} \cdot n \text{ (rpm)}}{9555}$$

Inversely

$$C \text{ (kgfm)} = \frac{716 \cdot P \text{ (cv)}}{n \text{ (rpm)}} = \frac{974 \cdot P \text{ (kW)}}{n \text{ (rpm)}}$$

$$C \text{ (Nm)} = \frac{7024 \cdot P \text{ (cv)}}{n \text{ (rpm)}} = \frac{9555 \cdot P \text{ (kW)}}{n \text{ (rpm)}}$$

1.3 Single-Phase AC Systems

Alternating current is distinguished by that voltage, which (instead of being a steady one, as for instance between the poles of a battery) varies with time, alternately reversing its direction.

In the single-phase systems, the alternating voltage U (Volts) is generated and applied between two wires to which the load absorbing current I (amperes) is connected - see Fig. 1.4a.

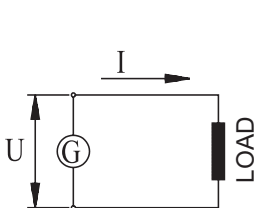

Figure 1.4a

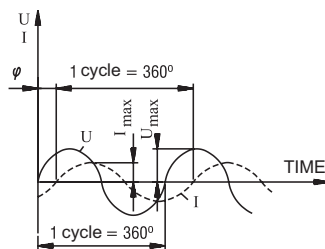

Figure 1.4b

By representing the values U and I in a graph at successive instants, we obtain Fig. 1.3.1.b. Fig. 14b also shows some values which will be defined further on. It can be noted that the voltage and current waves are not “in phase”, i.e. they do not pass the zero point simultaneously, notwithstanding the fact that they are of the same frequency. This occurs with many types of electrical loads e.g. electric motors (reactive loads).

Frequency

Is the number of time per second the voltage changes its direction and returns to the initial condition. It is expressed in “cycle per second ” or “hertz”, and is represented by Hz.

Maximum voltage (U_{máx})

This is the “peak value” of the voltage, i.e. the instantaneous crest value achieved by the voltage during one cycle (one half of the cycle being positive and the other half negative, this is reached twice per cycle).

Maximum current (I_{máx})

This is the “peak” of the current.

Effective value of voltage and current (U and I)

It is the value of the continuous voltage and current which generate an output corresponding to that generated by the alternated current. We can identify the effective value as:

$$U = \frac{U_{\max}}{\sqrt{2}} \quad e \quad I = \frac{I_{\max}}{\sqrt{2}}$$

For example:

If we connect a “resistance” to an AC circuit ($\cos \varphi = 1$) with $U_{\max} = 311$ V and $I_{\max} = 14.14$ A.

the developed output power will be:

$$P = U \cdot I \cdot \cos \varphi = \frac{U_{\max}}{\sqrt{2}} \cdot \frac{I_{\max}}{\sqrt{2}} \cdot 1 = 311 \cdot 14.14 \cdot 1$$

$$P = 2.200 \text{ Watts} = 2.2 \text{ kW}$$

Note: usually, when referring to voltage and current, for example, 220 V or 10 A, without mentioning any other factor, we are referring to voltage or current effective values, which are normally applied.

Phase displacement (φ)

Phase displacement means “delay” of the current wave with respect to the voltage wave (see fig. 1.4). Instead of being measured in time (seconds), this delay is usually measured in degrees, corresponding to the fraction of a complete cycle, taking 1 cycle = 360°. However, phase displacement is usually expressed by the angle cosine (see Item 1.2.5 - Power Factor).

1.3.1 Connection: Parallel and Series

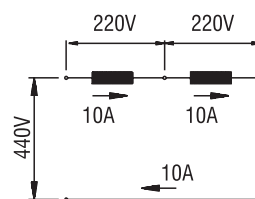

Figure 1.5a

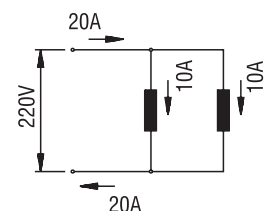

Figure 1.5b

Two equal loads can be connected, for example, to a single-phase system, in two different ways:

- By making a series connection (fig. 1.5a), where the total current flows through the two loads. In this case, the voltage across each load is the half of the circuit voltage.
- By making a parallel connection (fig. 1.5b), where the voltage is applied across each load. In this case, the current in each load is half of the total circuit current.

1.4 Three-Phase AC System

A three-phase system is formed by associating three single-phase voltage system, U_1 , U_2 and U_3 which so the phase displacement between any two of them is 120° , which means, the “delays” of U_2 relating to U_1 , U_3 relating to U_2 , relating to U_3 , are equal to 120° (considering a complete cycle = 360°). The system is balanced if the three voltages have the same effective value, $U_1 = U_2 = U_3$, as shown in Fig. 16

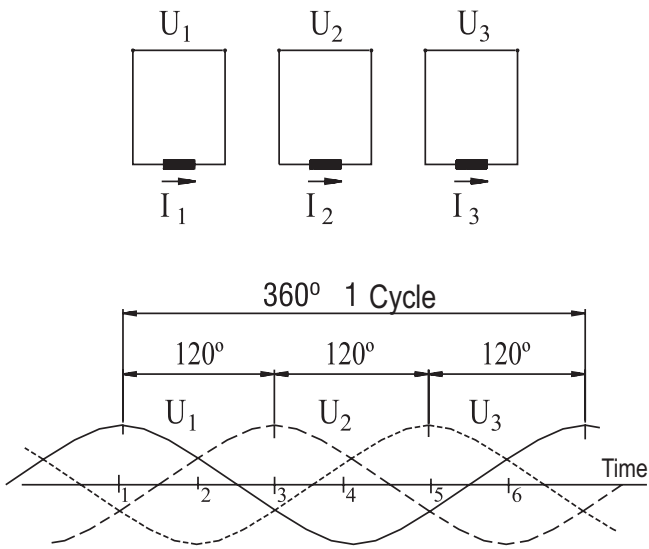

Figure 1.6

By interconnecting the three single-phase systems and by eliminating the unnecessary wires, we have a three-phase system: three balanced voltages U_1 , U_2 and U_3 the phases of which are reciprocally displaced by 120° and applied between the three wires of the system. There are two different ways of making a connection, as shown in the following diagrams. In these diagrams the voltage is usually shown by inclined arrows or rotating vectors and maintaining between them the angle corresponding to the phase displacement (120°), according to figures 1.7a, b and c, e figures 1.8a, b and c.

1.4.1 Delta Connection

By connecting the three single-phase systems, as shown in fig.1.7a, b and c, we can eliminate the three wires, leaving only one at each connecting point. Thus three-phase system can be reduced to three-wires, L_1 , L_2 and L_3 .

Line voltage (U)

Is the rated voltage of the three-phase system applied between any two of these three wires L_1 , L_2 and L_3 .

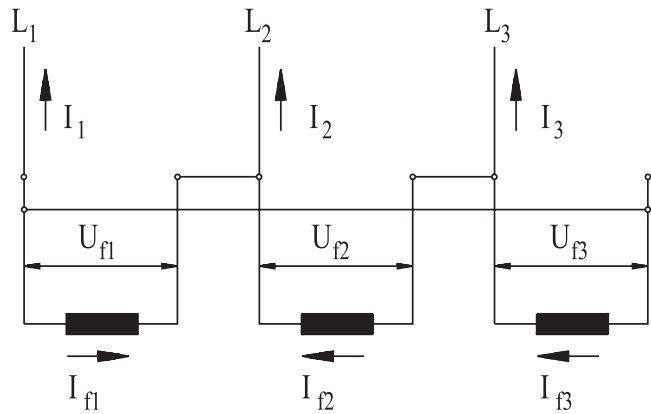

Figure. 1.7a - Connections

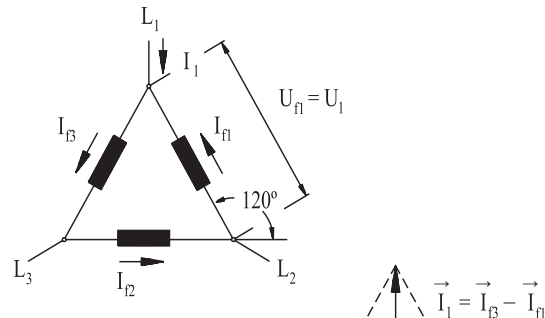

Figure 1.7b - Electrical diagram

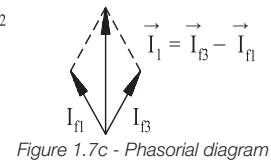

Figure 1.7c - Phasorial diagram

Line current (I)

The current in any one of the three wires L_1 , L_2 and L_3 .

Phase voltage and current (U_f and I_f)

Is the voltage and current of each one of the considered single-phase systems.

Looking at the diagram in fig. 1.7b, one can see that:

$$U = U_f$$

$$I = \sqrt{3} \cdot I_f \cdot I_f = 1.732 I_f$$

$$\vec{I} = \vec{I}_{f3} - \vec{I}_{f1} \text{ (Figure 1.7c)}$$

Example:

Consider a balanced three-phase system with a rated voltage of 220 V. The measured line current is 10 amperes. By connecting a three-phase load to this system, composed of three equal loads connected in delta, what is the voltage across, and the current in each load?

We have $U_f = U_1 = 220$ V in each load.

if $I = 1.732 \cdot I_f$, we have $I_f = 0.577 \cdot I = 0.577 \cdot 10 = 5.77$ A in each one of the load.

1.4.2 Star Connection

By connecting one of the wires of each single-phase system to a common point, the three remaining wires will form a three-phase star system (see fig. 1.8). Sometime the three-phase star system is made as a “four wire” or with the “neutral wire” system. The fourth wire is connected to the common point for the three-phases.

The line voltage, or rated voltage of the three-phase system - and the line current - are defined in the same way as for delta-connections.

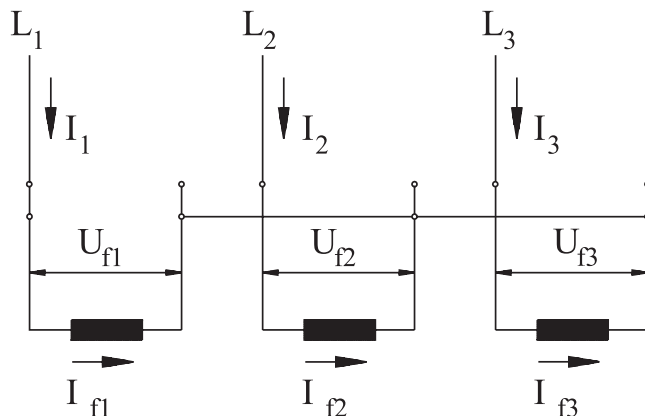

Figure 1.8a - Connections

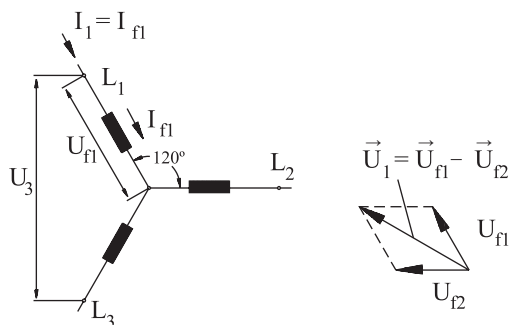

Figure 1.8b - Electrical wiring diagram

Figure 1.8c - Phasor diagram

By analyzing the wiring diagram in Fig.1.8b, one can note that:

$$I = I_f$$

$$U = \sqrt{3} \cdot U_f = 1.732 \cdot U_f$$

$$\vec{U} = \vec{U}_{f1} - \vec{U}_{f2} \text{ (figure 1.8c)}$$

Example:

Consider a three-phase load composed of three equal loads. Each load is connected to a voltage of 220 V, absorbing 5.77 A. What is the rated voltage of the three-phase system feeding this load under normal conditions (220 and 5.77 A)? What is the line current?

$$\text{We have } U_f = 220 \text{ V (rated voltage for each load)}$$

$$U = 1.732 \cdot 220 = 380 \text{ V}$$

$$I = I_f = 5.77 \text{ A}$$

1.5 Three-Phase Induction Motor

Fundamentally a three-phase induction motor consist of two parts: stator and rotor.

Stator Consists of

- The frame (1) - is the supporting structure of the assembly; manufactured of iron, steel, die-cast aluminum, resistant to corrosion and with cooling fins.
- The lamination core (2) - constructed with magnetic steel plates.
- The three-phase winding (8) - comprises three equal sets of coils, one se set for each phase, forming a balanced three-phase system when connected to a three-phase power supply.

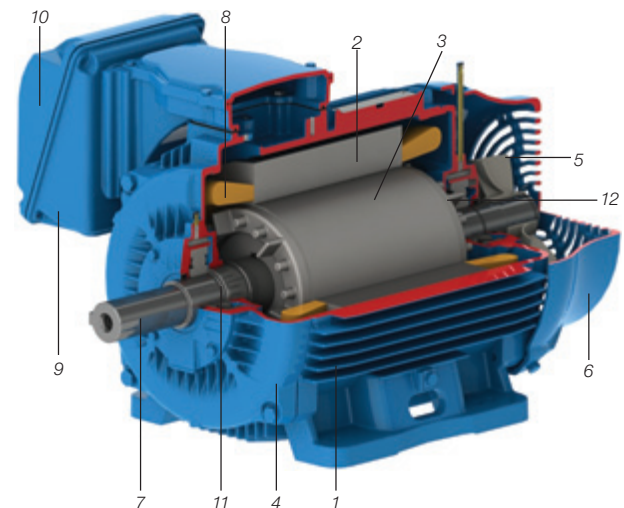

Figure 1.9

The rotor consists of:

- The shaft (7) - which transmits the mechanical output developed by the motor.
- The laminated magnetic core (3) - the rotor laminations have the same characteristics of the stator laminations.
- Bars and short-circuit rings (12) - are aluminum die castings formed as one piece.

Other components of the three-phase induction motor:

- End shields (4)
- Fan (5)
- Fan cover (6)
- Terminal box (9)
- Terminals (10)
- Bearings (11)

This manual covers “squirrel cage rotor motor” where the rotor consists of a set of non-insulated bars that are interconnected by short-circuit rings. What characterizes an induction motor is the fact that only the stator is connected to the power supply. The rotor is not power supplied externally and the currents that flow through it are induced electromagnetically by the stator from which comes the induction motor name.

1.5.1 Working Principle - Rotating Field

When an electric current flows through a coil, a magnetic field is generated, the direction of which is along the coil axis and proportional in value to the current.

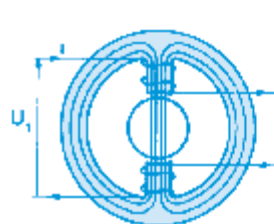

Figure 1.10a

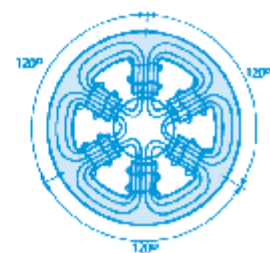

Figure 1.10b

a) Figure 1.10.a. shows a single-phase winding through which flow the current I , and the field H , generated by the current. The winding is composed of one pair of poles, a North pole and a South pole, the effects of which are added to produce field H . The magnetic flux passes through the rotor, across both poles and links up with itself by means of the stator core. When I is an alternating current, field H is established in the same way, so that its value is represented at every instant, by the same chart shown in Fig.1.4b., also reversing its direction at every half cycle. The field H is pulsating, its intensity "varies" proportionally to the current, always in the same direction - North-South.

b) Figure 1.10b shows a three-phase winding consisting of three single-phase windings displaced 120° each other. If this winding is fed from a three-phase system, currents I_1 , I_2 and I_3 will generate their own magnetic fields H_1 , H_2 and H_3 in a similar way. The displacement between these fields is 120° ; moreover, since they are proportional to the respective currents, the phase displacement in time between them will equally be 120° , which can be represented in a chart similar to Fig. 1.6. At any instant, the total resulting field H will be equal to the graphical sum of field H_1 , H_2 and H_3 .

Figure 1.11 shows this graphic sum for six successive steps

Phasor diagram

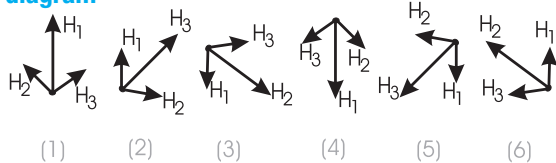

Phasor / vector

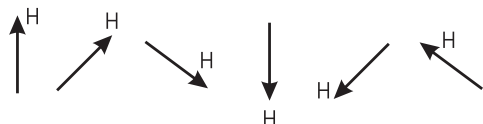

Figure 1.11

At instant (1), Fig. 1.11 shows that the field H_1 is at its maximum whereas fields H_2 and H_3 are negative and have the same value: 0.5. The resulting field (graphic sum) is shown in the upper part of Fig. 1.11(1) and has the same direction of the winding of the phase 1.

Repeating this procedure for the instants 2, 3, 4, 5 and 6 of Fig. 1.6 we can see that the resulting field H presents a constant intensity, but its direction keeps rotating to complete a whole turn at the end of a cycle.

We can therefore conclude that a three-phase winding fed from three-phase currents generates a rotating field as if one single pair of poles was present, rotating and fed with a constant current. This rotating field, generated by the three-phase stator winding, induces certain voltages into the rotor bars (magnetic flux lines go through the rotor bars) which, being short-circuited, generate currents and, as a consequence, create a field on the rotor with reverse polarity if compared with the rotating field polarity. Since opposite fields attract each other and considering the stator field

(rotating field) is rotative, the rotor tends to follow the speed of this field. The result of this is that a motor torque is created in the rotor that makes it rotate and then drive the load.

1.5.2 Synchronous Speed (n_s)

The synchronous speed of the motor is defined by the rotation speed of the rotating field which depends on the number of poles ($2p$) of the motor and on the line frequency (f) in Hertz. The field makes a complete revolution at each cycle and "f" is the system frequency in cycles per second (Hertz). Windings may have more than one pair of poles which can be alternately distributed (one "North" and one "South") along the circumference of the magnetic core. Since the rotating field runs through one pair of poles at each cycle and the winding has poles or "p" pair of poles, the speed of the field is:

$$n_s = \frac{60 \cdot f}{p} = \frac{120 \cdot f}{2p} \quad (\text{rpm})$$

Examples:

a) What is the synchronous speed of a six-pole motor, 50 Hz?

$$n_s = \frac{120 \cdot 50}{6} = 1000 \text{ rpm}$$

b) A twelve-pole motor, 60 Hz?

$$n_s = \frac{120 \cdot 60}{12} = 600 \text{ rpm}$$

It must be remembered that the number of poles of a motor must always be an even number in order to form pairs of poles. The table below shows the synchronous speed of the more common number of poles at 60 Hz and 50 Hz.

Number of poles	Synchronous speed per minute	
	60 Hertz	50 Hertz
2	3.600	3.000
4	1.800	1.500
6	1.200	1.000
8	900	750
10	720	600

Table 1.3 - Synchronous speed

For 2-pole motors, as in item 1.5.1, the field turns by one complete revolution at each cycle. Thus the electrical degrees are equivalent to the mechanical degrees. For motors with more than 2 poles, a smaller "geometrical" revolution is realized by the field.

For example:

For a 6-pole motor, we will have, in a complete cycle, a field revolution of $360^\circ \times 2/6 = 120$ geometrical degrees. This is equivalent to 1/3 of the speed in 2 poles. We conclude, then, that:

$$\text{Geometrical degrees} = \text{Mechanical degrees} \times p$$

1.5.3 Slip (s)

If the motor runs at a speed different from the synchronous speed, i.e. differing from the speed of the rotating field, the rotor windings “cut” the magnetic force lines of the field and so, according to the electromagnetism laws, induced currents will flow through the rotor windings. The heavier the load the higher must be the required torque to move it.

To obtain a higher torque, the speed difference must be greater so that induced current and generated field become higher. Therefore, as the load increases, the motor speed decreases. When the load is at zero (motor at no-load) the rotor practically rotates at its synchronous speed.

The difference between motor speed (n) and synchronous speed (n_s) is called slip (s), expressed as rpm or fraction of the synchronous speed or as a percentage of the synchronous speed:

$$s \text{ (rpm)} = n_s - n; \quad s = \frac{n_s - n}{n_s}; \quad s \text{ (%) } = \frac{n_s - n}{n_s} \cdot 100$$

Therefore, for a given slip s (%), the motor speed will be:

$$n = n_s \cdot \left(1 - \frac{s \text{ (%)}}{100} \right)$$

Example:

What is the slip of a 6-pole motor when the speed is 960 rpm?

$$s \text{ (%) } = \frac{1000 - 960}{1000} \cdot 100$$

$$s \text{ (%) } = 4\%$$

1.5.4 Rated Speed

Is the motor speed (rpm) operating at rated power, at rated voltage and frequency. As described in item 1.5.3, it depends on the slip and on the synchronous speed.

$$n = n_s \cdot \left(1 - \frac{s \text{ (%)}}{100} \right) \text{ rpm}$$

1.6 Insulation Materials and Insulation Systems

Considering that an induction motor is a simple designed and rugged construction machine, its life time will exclusively depend on the quality level of the insulation materials. Motor insulation is affected by several factors including moisture, vibration, corrosive environments and others. Among all these factors, operating temperature of the insulating materials is the most critical.

The motor life time is reduced by half when subject 8% to 10 °C in operation above the rated temperature of the class of insulating material. To ensure a longer lifetime for the electric motor, the use of thermal sensors is recommended

for the winding protection.

When we refer to motor life time reduction, we do not refer specifically to excessively high temperatures resulting in sudden insulation burn out. Insulation life time (in terms of operating temperature much below than the one affecting the insulation) refers to permanent aging of the insulation material which becomes dry and loses its insulation properties. As a result, it will not withstand the voltage applied to it, thus causing short-circuit.

If operating temperature is kept below its limit, experiences have proved that the motor insulation can practically last for ever. Any increasing value above such limit will reduce insulation life time proportionally. Such limit of temperature is much lower than the temperature that causes insulation burn out and it depends on the type of used material. This limit of temperature refers to insulation hottest spot and not necessarily to the whole insulation. On the other hand, a single weak spot in the insulation is enough to damage the winding completely.

With increasing use of frequency inverters for the speed control of induction motors, other application criteria must also be considered for the preservation of the insulation system. For more details see “Influence of the frequency inverter on the motor insulation”.

1.6.1 Insulation Material

The insulation material prevents, limits and directs the electric current flux. Although the insulating material is primarily intended to block the current flux from a cable to ground or to the lowest potential, it also serves to provide mechanical support, protect the cable from degradation caused by environment influences and to transfer the heat to the external environment.

Based on system requirements, gases, liquids and solid materials are used to insulate electric equipment. Insulation systems affect the quality of the equipment, and type and quality of the insulation affect the cost, weight, performance and its useful lifetime.

1.6.2 Insulation System

A combination of two or more insulation materials applied to an electric equipment is designated insulation system. This combination on an electric motor consists in magnet wire, insulation of the slot, insulation of the slot closing, face to face insulation, varnish and/or impregnation resin, insulation of the connection leads and welding insulation. Any material or component that is not in contact with the coil is not considered as part of the insulation system.

1.6.3 Thermal Classes

Since the temperature of electro-mechanical products is basically the predominant factor for the aging of the insulation material and insulation system, certain basic thermal classifications are recognized and applied all over the world.

Insulation materials and insulation system are classified based on the resistance to temperature for a long period of time. The standards listed below refers to the classification of materials and insulation systems:

Material	Systems	Material and System
UL 746B	UL 1446	IEC 60085
IEC 60216	UL 1561 / 1562	
	IEC 60505	
	IEEE 117	

Table 1.4 - Standards for materials and insulation system

The thermal classes defined for the materials and insulation systems are the following:

Temperature (°C)	Temperature Class	
	IEC 60085	UL 1446
90	Y (90 °C)	-
105	A (105 °C)	-
120	E (120 °C)	120 (E)
130	B (130 °C)	130 (B)
155	F (155 °C)	155 (F)
180	H (180 °C)	180 (H)
200	N (200 °C)	200 (N)
220	R (220 °C)	220 (R)
240	-	240 (S)
above 240°C	-	above 240 (°C)
250	250	

Table 1.5 - Thermal classes

IEC - International Electrotechnical Commission - non-governmental organization for standards in the related electrical, electronic and technology areas

UL - Underwriters Laboratories - American product certification body

It is understood that the thermal class represents the maximum temperature that the electromechanical equipment can reach on its hottest spot when operating at rated load without reducing its lifetime. The thermal classification of a material or system is based on a comparison with well-known reference systems or materials. However, for those cases where there is not any reference material, the thermal class can be obtained by exploiting the damage curve (Arrhenius Graphic) for a certain time period (IEC 216 specifies 20,000/hours).

1.6.4 Insulating Materials in Insulation Systems

The specification of a product within a certain thermal class does not mean that each insulating material used has the same thermal capacity (thermal class). The temperature limit for an insulation system can not be directly related to the thermal capacity of the individual materials in this system. In a system the thermal performance of a material can be improved by protective characteristics of certain material used with this material. For example: a 155 °C class material can have its performance improved when the set is impregnated with varnish for class H (180 °C).

1.6.5 WEG Insulation System

In order to meet different market requirements and specific applications, associated to an excellent technical performance, nine insulation systems are used for WEG motors.

The round enameled wire is one of the most important components used in the motor since the electric current flows through it and creates the magnetic field required for motor operation. During the production process, the wires are submitted to mechanical traction efforts, flexion and abrasion electrical effects that also affect the wire insulating material. During the operation, the thermal and electrical effects act on the wire insulation material. For this reasons, the wire requires an outstanding mechanical, thermal and electrical insulation resistance.

The enamel used currently on the wire ensures such properties, where the mechanical property is assured by the outside enamel coat that resists to abrasion effects while inserting it into the stator slots. The internal enamel coat ensures high dielectric resistance and the set provides thermal class 200 °C to the wire (UL File E234451). This wire is used for all Class B, F and H motors. Smoke Extraction Motors are built with special wire for extremely high temperatures.

Films and laminated insulating materials are intended to isolate thermally and electrically all motor winding parts. The thermal class is indicated on the motor nameplate. These films are aramid and polyester based films and also laminated films are applied to the following areas:

- between the coils and the slot (slot bottom film) to insulate the lamination core (ground) from the enameled wire coil;
- between phases: to isolate electrically one phase from the other phase
- Closing of the stator slot to insulate electrically that coil placed on the top of the stator and for mechanical purposes so as to keep the wires inside the stator slot.

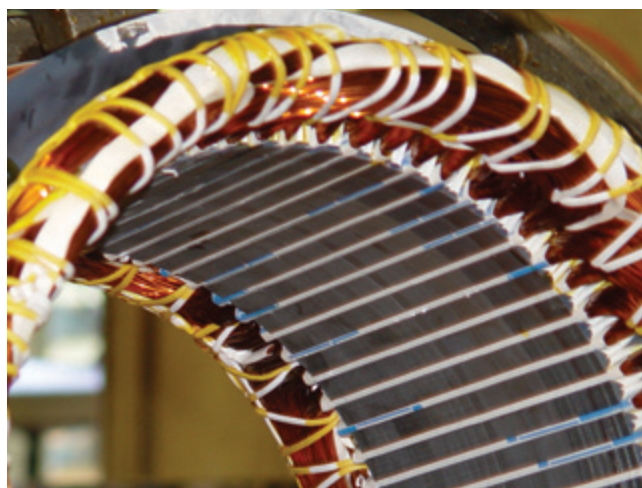

Figure 1.12a - Wires and films used on the stator

The impregnation varnishes and resins are mainly intended to maintain all enameled wire coil as a block with all stator components through agglutination of such materials and to fill all voids inside the slot.

This agglutination avoids vibration and friction between the wires. Such friction could cause failures on the wire enamel, then resulting in a short-circuit.

The agglutination (filling of voids) also helps the heat dissipation generated by the wire and mainly, when motors are fed by frequency inverter, prevents/reduces the formation of partial discharges (corona effect) inside the motor.

Two types of varnishes and two types of impregnation varnishes are currently used; all of them are polyester varnishes so as to meet motor construction and application requirements. Silicon resin is only used for special motors designed for very high temperatures.

Varnishes and resins usually improve thermal and electrical characteristics of the impregnated materials in such a way to classify these impregnated materials in higher thermal class if compared to the same materials without impregnation.

The varnishes are applied by the immersion impregnation process and then oven-dried. Solventless resins are applied by the continuous flow process.

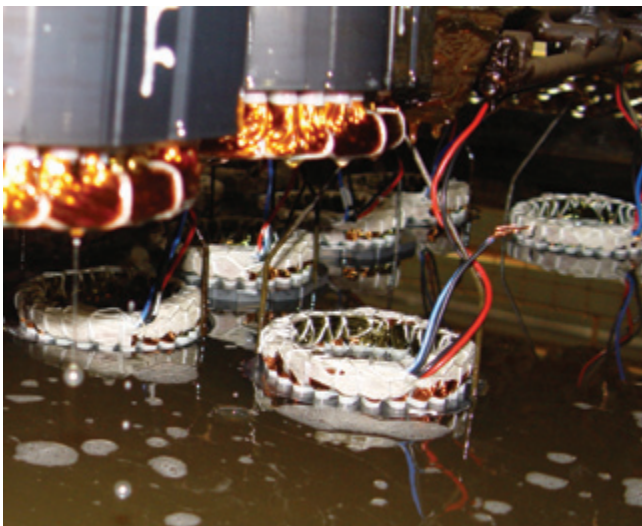

Figure 1.12.b - Immersion impregnation process



Figure 1.12.c - Resin applied by continuous flow process

The connection leads consist of elastomeric insulation materials that have the same thermal class as the motor. These materials are exclusively used to insulate electrically the lead from the external environment. They have high electric resistance and proper flexibility to allow easy handling during manufacturing process, installation and motor maintenance.

For certain applications, such as submersible pumps, the leads must be chemically resistant to the oil of the pump. The flexible pipes are intended to cover and insulate electrically the welded connections between the coils wires and the leads and the connections between wires. They are flexible to allow them to get shaped to welding points and to the coil head tying. Three types of pipes are currently used:

- Heat-shrink polyester tubing - Class of 130 °C
- Polyester tube coated with acrylic resin - Class of 155 °C
- Fiberglass tube coated with silicon rubber - Class of 180 °C



2. Power Supply Characteristics

2.1 Power Supply System

The power supply system can be single or three-phase. Single-phase system is mostly used in homes, commercial centers, farms, while three-phase system is used in industries. Both operate at 60 Hz or 50 Hz.

2.1.1 Three-Phase System

The three-phase voltages mostly used in industries are:

- Low voltage: 220 V, 380 V and 440 V
- High voltage: 2.300 V, 4.160 V and 6.600 V

The star connected three-phase low voltage system consists of three phase leads (L_1, L_2, L_3) and a neutral conductor (N). The last one is connected to the generator star point or to the transformer secondary winding (as shown in figure Figure 2.1).

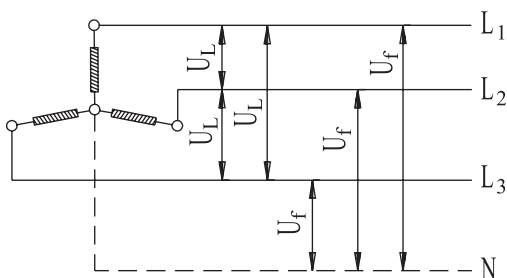

Figure 2.1 - Three-phase system

2.1.2 Single-Phase System

Single phase motors are connected to two phases (U_L line voltage) or to one phase and to neutral conductor (U_f phase voltage). So the single-phase motor rated voltage must be equal to U_L or U_f system voltage. When several single-phase motors are connected to a three-phase system (formed by 3 single-phase systems), care must be taken in order to distribute them uniformly so as to avoid unbalance between phases.

Single wire earth return (SWER)

The single-phase earth return (SWER) is na electric system where the ground lead operates as return lead for the load current. This is applied as solution for the use of single-phase motors from power supply not having neutral available. Depending on the available electric system and on the characteristics of the soil where it will be installed (usually on farm power supply), we have:

a) Single cable system

The single wire earth return (SWER) system is considered the practical and economical option. However, it can be used only where the origin substation outlet is star grounded.

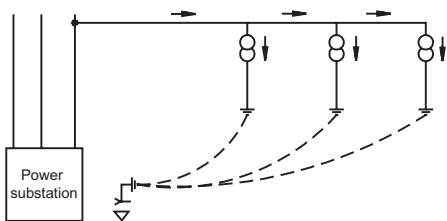

Figure 2.2 - Single cable system

b) Single cable system with insolation transformer

Besides requiring a transformer, this system has a few disadvantages such as:

- Link power limitation to isolation transformer rated power;
- the grounding system of the isolation transformer must be reinforced. Lack of this will result in absence of energy to the whole link.

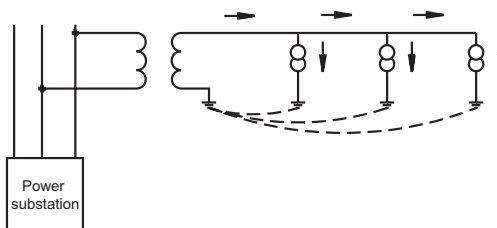

Figure 2.3 - Single cable system with isolation transformer

c) Single wire earth return (SWER) system with partial neutral

It is applied as a solution of the use of single wire earth return (SWER) system in regions with land (soil) of high resistivity when it is difficult to get ground resistance values of the transformer within the maximum design limits.

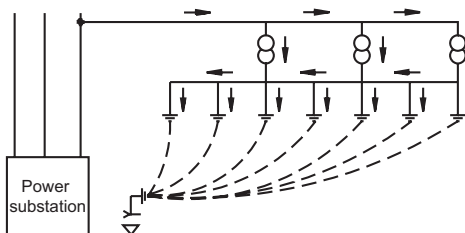

Figure 2.4 - Single wire earth return system with partial neutral

3. Characteristics of the Electric Motor Power Supply

3.1 Rated Voltage

This is the line voltage for which the motor has been designed.

3.1.1 Multiple Rated Voltage

Motors are generally supplied with sufficient terminals to enable alternative connections. This means that they can operate on at least two different voltages. The main types of alternative terminal connections are:

a) Series-parallel connection

The winding of each phase is divided into two equal parts (halves) (please consider that the number of poles is always a multiple of two, so this type of connection is always possible).

- By connecting the two halves in series, each half will have a voltage to the half rated phase voltage of the motor;
- By connecting the two halves in parallel, the motor can be supplied with a voltage equal to one half of the previous voltage, without affecting the voltage applied to each coil. (refer to examples given in figures 3.1a and b).

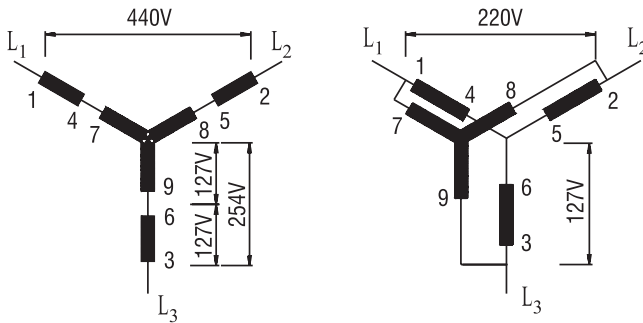

Figure 3.1a - Series-parallel connection Y

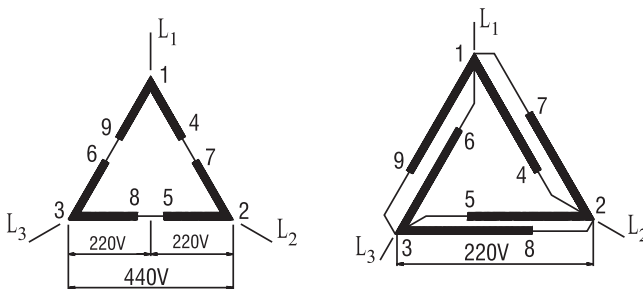

Figure 3.1b - Series-parallel connection Δ

This type of connection requires nine terminals on the motor. The most common dual voltage system is 220/440 V, i. e. the motor is parallel connected when supplied for 220 V, or alternatively, it is series connected when supplied for 440 V. Fig. 3.1a and 3.1b show normal terminal numbering, as well as connection diagrams for this type of motor - both for star or delta connected motors. The same diagrams apply to any other two voltages, provided that one is the double of the other, e.g. 230/460 V.

b) Star-delta connection

Two ends of each phase winding are brought out to terminals. By connecting the three-phases in delta, each phase receives total line voltage, e.g. 220 volts (Fig. 3.2). By connecting the three-phases in star, the motor can be connected to a line voltage of $220 \times \sqrt{3} = 380$ V. The winding voltage remains at 220 volts per phase.

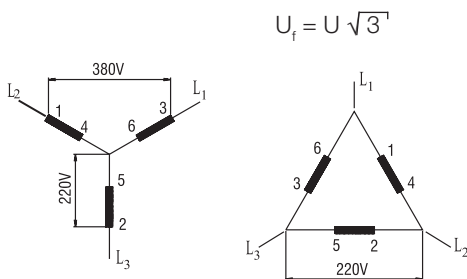

Figure 3.2 - Star-delta connection Y - Δ

This type of connection requires six terminals on the motor and is suitable for any dual voltage provided that the second voltage be equal to the first voltage multiplied by $\sqrt{3}$.

Examples: 220/380 V - 380/660 V - 440/760 V

In the example 440/760 V, the stated higher voltage is used to indicate that the motor can be driven by star-delta switch.

c) Triple rated voltage

The two previous alternative connection arrangements can be obtained in one motor if the winding of each phase is divided into two halves enabling series-parallel connection. All terminals have to be accessible so that the three phases can be connected in star or delta. This means that there can be four alternatives for rated voltage:

- 1) Parallel-delta connection;
- 2) Star-parallel connection, being the rated voltage equal to $\sqrt{3}$ x the first one;
- 3) Series-delta connection, i. e. the rated voltage being twice the value of the first one;
- 4) Series-star connection, the rated voltage is equal to $\sqrt{3}$ x the third one. However as this voltage would be higher than 690 V, it is only indicated as reference for star-delta connection.

Example: 220/380/440(760) V

Note: 760 V (only for starting)

This type of connection requires twelve terminals and Fig. 2.7 shows the normal numbering on the terminals as well as the connection diagram for the three rated voltages.

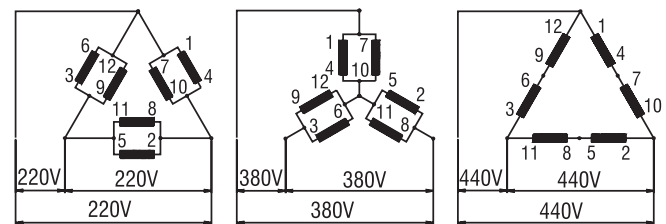

Figure 3.3

3.2 Rated Frequency (Hz)

This is the network frequency for which the motor has been designed.

3.2.1 Connection to Different Frequencies

Three-phase motors wound for 50 Hz can also be connected to a 60 Hz network,

a) By connecting a 50 Hz motor, of the same voltage, to a 60 Hz network, the motor performance will be as follows:

- same output;
- same rated current;
- starting current decreases 17%;
- starting torque decreases 17%;
- breakdown torque decreases 17%;
- rated speed increases 20%.

Note: please consider the required outputs for motors that drive machines with variable torque and speed.

b) If voltage changes proportionally to frequency, the performance will be:

- motor output increase 20%;
- rated current is the same;
- starting current will be approximately the same;
- starting torque will be approximately the same;
- breakdown torque will be approximately the same;
- rated speed increases 20%.

3.3 Voltage and Frequency Variation Tolerance

As per standard ABNT NBR 17094 (2008) and IEC 60034-1, for induction motors, the combinations of voltage and frequency variations are classified as Zone A or Zone B (figure 3.4).

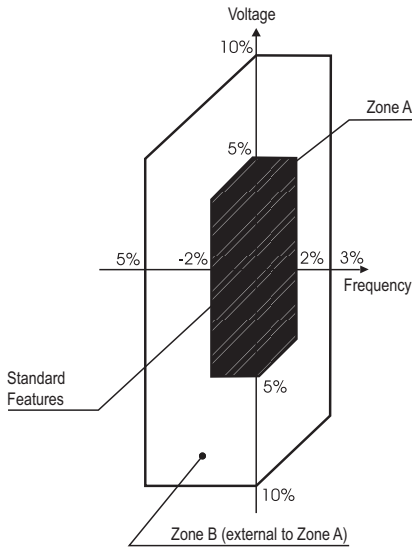

Figure 3.4 - Limits of voltage and frequency variations under operation

A motor must be capable of performing its main function continuously at Zone A, however it may not develop completely its performance characteristics at rated voltage and frequency (see rated characteristics point in figure 3.4.a) showing few deviations. Temperature rises can be higher than those at rated voltage and frequency.

A motor must be capable of performing its main function at Zone B, however it may present higher deviations than those of Zone A in reference to performance characteristics at rated voltage and frequency. Temperature rises can be higher than those at rated voltage and frequency and probably higher than those of Zone A. The extended operation at Zone B is not recommended.

Source: ABNT NBR 17094 (2008)

3.4 Three-Phase Motor Starting Current Limitation

Whenever possible a squirrel cage three-phase motor should be started direct-on-line (D.O.L.) by means of contactors.

It must be taken into account that for a certain motor the torque and current values are fixed, irrespective the load, for a constant voltage. In cases where the motor starting current is excessively high, harmful consequences may occur:

- a) High voltage drop in the power supply system. Due to that, equipment connected to the system may be affected;
- b) The protection system (cables, contactors) must be oversized resulting in higher cost;
- c) Utilities regulations limiting the line voltage drop.

If D.O.L starting is not possible due to these problems, indirect connection system can be used so as to reduce starting current

- Star-delta switch
- Compensating switch
- Series-parallel switch
- Electronic start (Soft-Starter)

3.4.1 D.O.L Starting

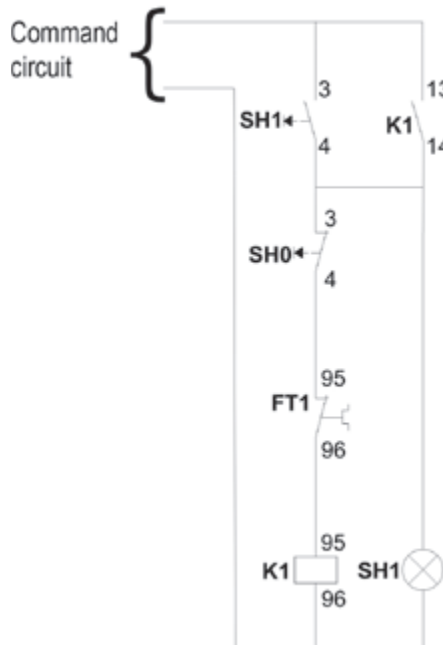

Figure 3.5 - Command circuit - direct starting

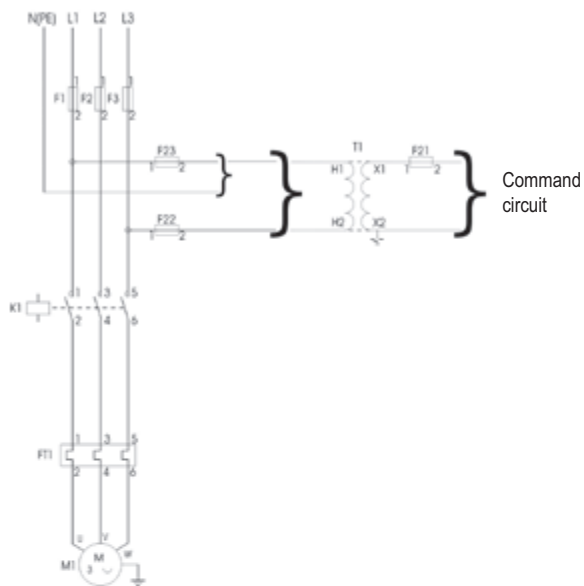

Figure 3.6 - Power circuit - direct starting

- F1. F2. F3** - Power fuses
- F21. F22. F23** - Control fuses
- T1** - Control transformer
- K1** - Contactors
- FT1** - Overload relay
- SH1** - Controllbutton
- KT1** - Time relay
- M1** - Motor

- Optional accessories**
- Phase fault relay
 - Minimum/maximum voltage relay
 - Ammeter
 - Voltmeter
 - Ohmmeter

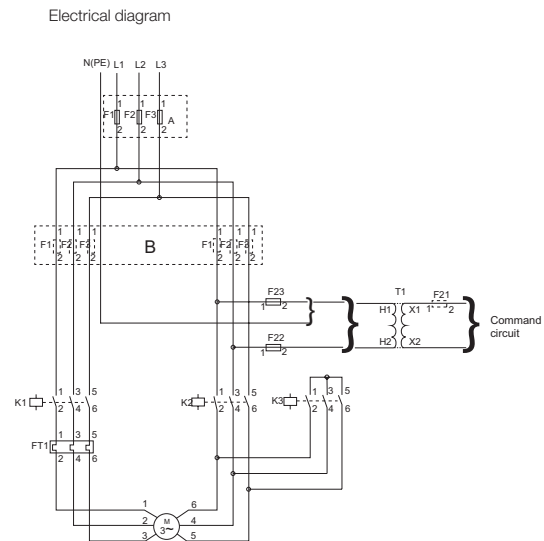

Figure 3.8 - Power circuit - starting with star-delta switch

Note: for outputs up to 75 HP (220 V), 125 HP (380 V) and 175 HP (440 V) You must use connection "A" (protection by 3 fuses). For higher outputs you must use the connection "B" (protection by 6 fuses), where the fuse set F1, F2, F3 is equal to the fuse set F4, F5, F6.

- F1. F2. F3** - Power fuse
- (F1. F2. F3 and F4. F5. F6)** - Power fuse
- F21. F22. F23** - Control fuse
- T1** - Control transformer
- K1. K2. K3** - Contactors
- FT1** - Overload relay
- SH1** - Control button
- KT1** - Time relay
- M1** - Motor

- Optional accessories**
- Phase fault relay
 - Minimum/maximum voltage relay
 - Ammeter
 - Voltmeter
 - Ohmmeter

3.4.2 Starting with Star-Delta Switch (Y - Δ)

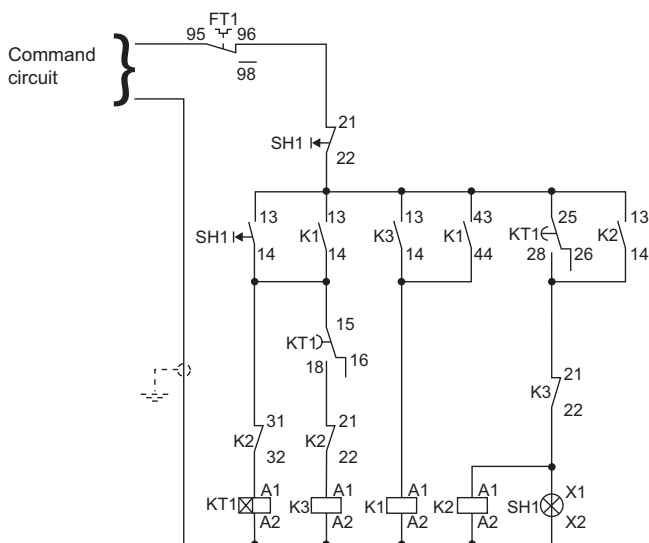

Figure 3.7 - Command circuit - starting with star-delta switch

When starting by the Star-Delta method it is essential that the motor windings are suitable for operating on a dual voltage, e.g. 220/380 V, 380/660 V or 440/760 V. Motors must have at least six connection terminals. Star-Delta starting can be used if the torque is high enough to ensure the machine acceleration with reduced current. When star-connected, the current is reduced to 25-33% of the starting current reached when Delta connected.

The resistive load torque can not exceed the motor starting torque (figure 3.9) and during the delta commutation process the achieved values can not exceed the allowed one. On the other hand, there are cases where this starting method can not be used, as shown in Fig. 3.10.

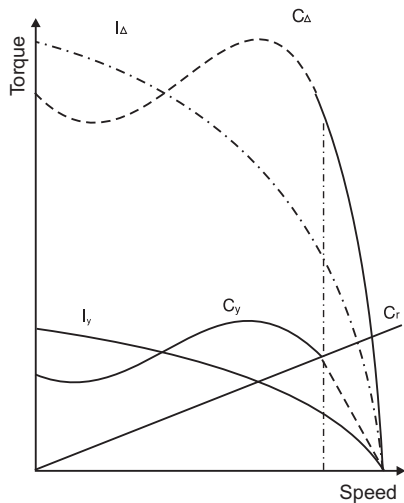

Figure 3.9 - Current and torque for star-delta starting of a squirrel cage motor driving a load with resistive torque C_r

- I_{Δ} - current in delta
- I_{γ} - current in star
- C_{γ} - torque in star
- C_{Δ} - torque in delta
- C_r - resistive torque

Figure 3.11 shows a high resistive torque C_r . If the motor is started in star connection it will accelerate the load up to approximately 85% of the rated speed. At this point the starter must be switched to delta. In this example, the current (which is close to its rated value - e.g. 100%) jumps suddenly to 320% which is of no advantage since the starting current was only 190%.

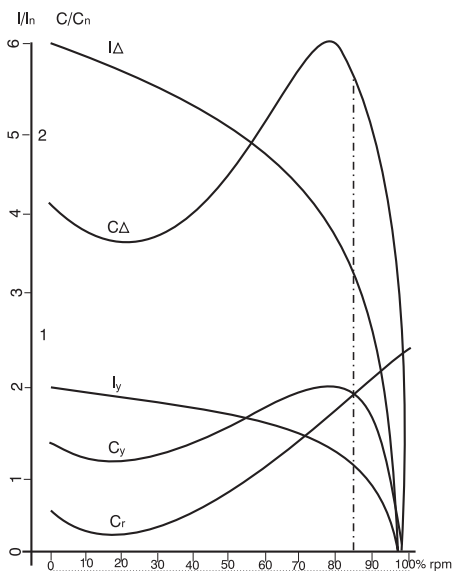

Figure 3.10

Fig. 3.11 shows a motor with the same characteristics, however, the resistive torque C_r is much lower. When connected to Y the motor accelerates the load up to 95% of the rated speed. When the starter is switched to Δ , the

current, which was approximately 50%, increases to 170%, i. e., practically equal to the starting current in Y. In this case, the star-delta connection has some advantages, because if it was D.O.L. connected, it would absorb 600% of the rated current. The Star-Delta starter can only be used for starting machines at no loads. In the case of starting at no load, the load can only be applied after the motor has reached 90% of its rated speed. The commutation point from star to delta connection must be determined carefully in order to ensure that this starting method is effectively advantageous in cases where D.O.L starting is not possible. For triple rated voltage motors (220/380/440/760 V, connection must be at 220/380 V or 440 (760) V, depending on the power supply.

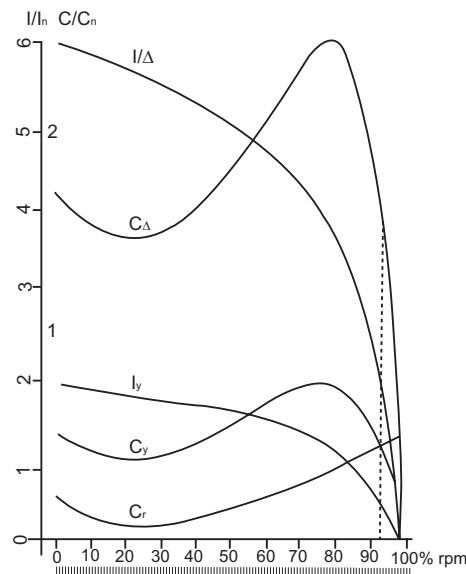

Figure 3.11

- I_{Δ} - current in delta
- I_{γ} - current in star
- C_{Δ} - torque in delta
- C_{γ} - torque in star
- C/C_n - ratio between motor torque and rated torque
- I/I_n - ratio between motor current and rated current
- C_r - resistive torque

Figure 3.12 shows how to connect a motor for Star-Delta starting on a 220 V power supply and indicates that voltage per phase is reduced to 127 V during starting.

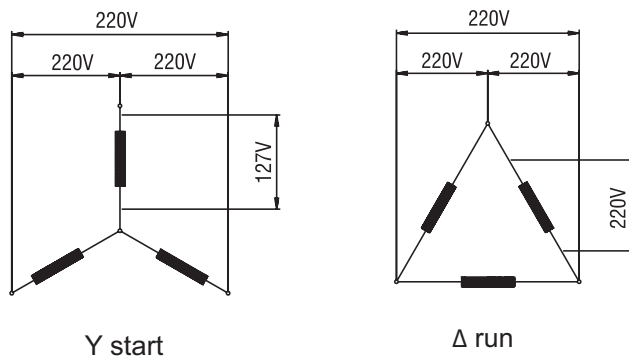

Figure 3.12

3.4.3 Compensating Switch (Autotransformer)

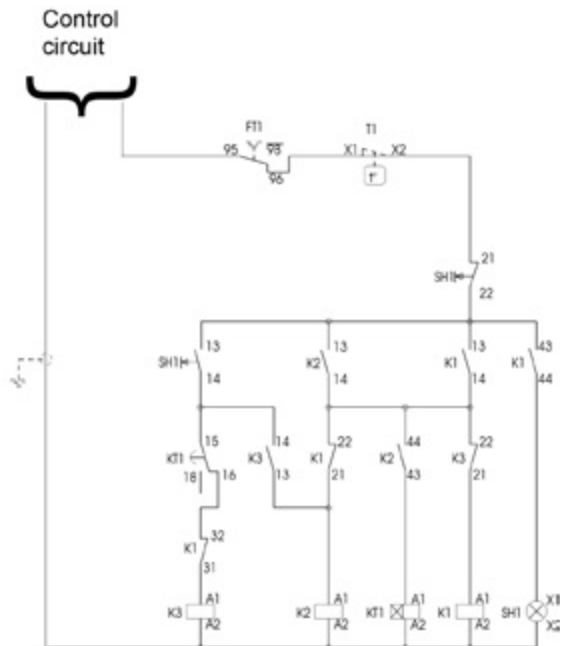

Figure 3.13 - Control circuit - starting by compensating switch

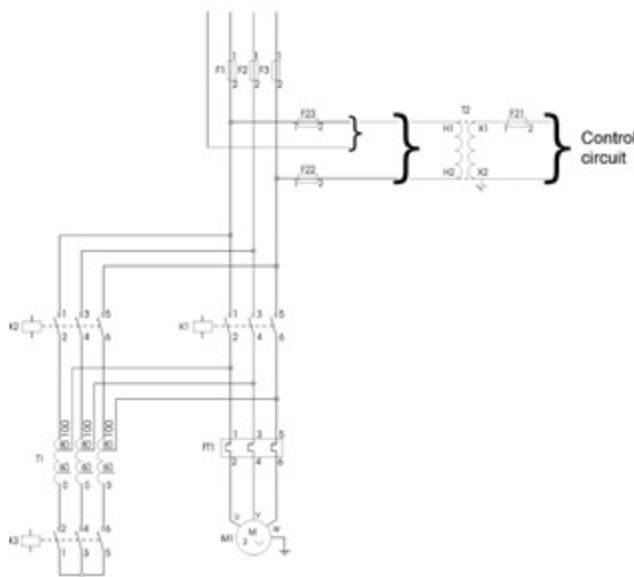

Figure 3.14 - Power circuit - starting by compensating switch

- F1, F2, F3** - Power fuses
- (F1, F2, F3 e F4, F5, F6)** - Power fuses
- F21, F22, F23** - Control fuses
- T1** - Control transformer
- K1, K2, K3 e K4** - Contactors
- 1FT1 e 2FT1** - Overload relay
- SH1** - Control button
- KT1** - Time relay
- M1** - Motor

Optional accessories

- Phase fault relay
- Minimum/maximum voltage relay
- Ammeter
- Voltmeter
- Ohmmeter

The compensating switch can be used to start motors under load. This switch reduces the starting current preventing overload on the circuit, however ensures that the motor has sufficient torque to start and accelerate the load.

The voltage on the compensating switch is reduced by the autotransformer which has taps of 50%, 65% and 80% of the rated voltage.

For motor starting with voltage below the rated one, starting current and torque must be multiplied by factor K_1 (current multiplying factor) and K_2 (torque multiplying factors) obtained on the chart of figure 3.15.

Example: for 85% of the rated voltage

$$\left(\frac{I_p}{I_n}\right)_{85\%} = K_1 \cdot \left(\frac{I_p}{I_n}\right)_{100\%} = 0.8 \left(\frac{I_p}{I_n}\right)_{100\%}$$

$$\left(\frac{C_p}{C_n}\right)_{85\%} = K_2 \cdot \left(\frac{C_p}{C_n}\right)_{100\%} = 0.66 \left(\frac{C_p}{C_n}\right)_{100\%}$$

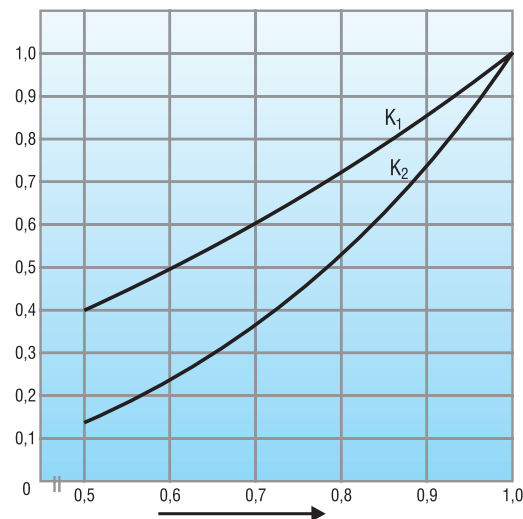

Figure 3.15 - K_1 and K_2 reduction factors as function of the motor and power supply U_m/U_n ratios

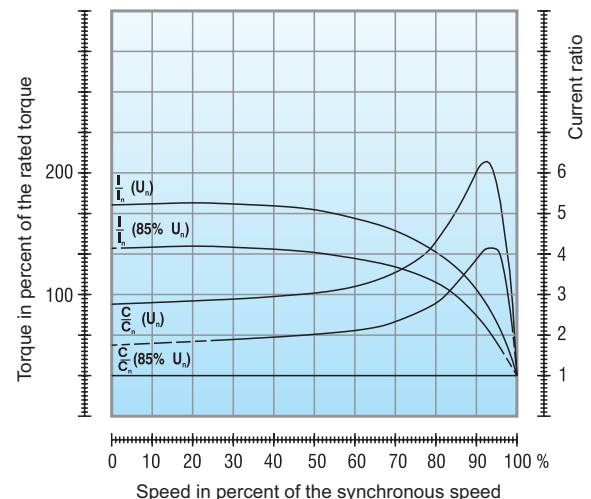

Figure 3.16 - Example performance characteristics of a 425 HP, VI pole motor when starting with 85% of the rated voltage.

3.4.4 Comparing Star-Delta Starters and “Automatic” Autotransformers

1) Star-delta (automatic)

Advantages

- a) Star-Delta starters are widely used due to their relatively low price.
- b) There are no limits to the number of times they can be operated.
- c) The components require very little space.
- d) The starting current is reduced to approximately one-third.

Disadvantages

- a) The starter can only be applied to motors where the six leads or terminals can be accessed.
- b) The supply voltage must be the same as the rated motor voltage for Delta connection.
- c) Because the starting current is reduced to approximately one-third of the rated current, the starting torque is also reduced to one-third.
- d) If the motor does not reach at least 90% of its rated speed at the time of switching from Star to Delta the current peak will be as high as in a D.O.L. start, thus causing harmful effects to the contacts of the contactors and the connection system brings no advantage to the electrical system.

2) Auto-transformer (automatic)

Advantages:

- a) On the 65% tapping the line current is approximately equal to that of a Star-Delta starter, however, at the time of switching from reduced voltage to the full supply voltage, the motor is not disconnected so that the second peak is very much reduced since the transformer is converted into reactance for a short time.
- b) It is possible to vary the tapping from 65% to 80% or even up to 90% of the supply voltage in order to ensure that the motor starts satisfactorily.

Disadvantages:

- a) One of its great disadvantages is the limitation of its operation frequency. It is always necessary to know the operation frequency in order to determine a suitably rated auto-transformer.
- b) The compensating switch is much more expensive than a Star-Delta starter due to the auto-transformer.
- c) Due to the size of the auto-transformer starter, much larger control panels are required which increases the price.

3.4.5 Series-Parallel Starting

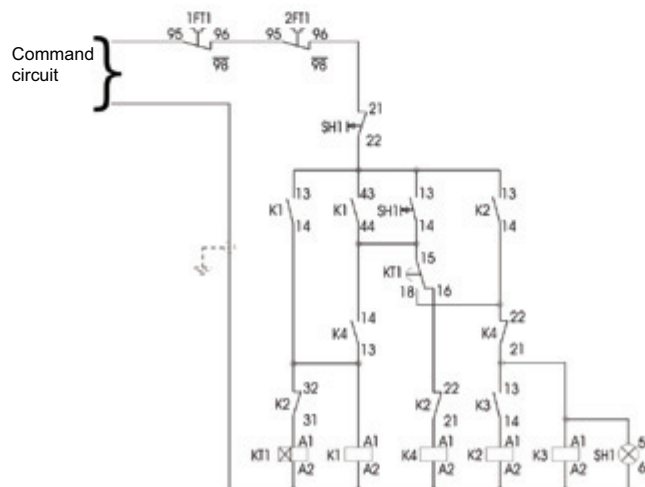

Figure 3.17 - Control circuit - series-parallel starter

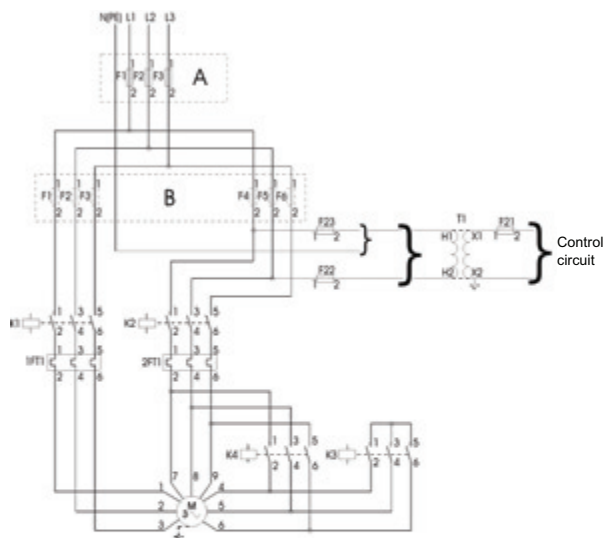

Figure 3.18 - Power circuit - series-parallel starter

- F1. F2. F3** - Power fuses
- F21. F22. F23** - Control fuses
- T2** - Control transformer
- K1. K2. K3** - Contactors
- FT1** - Overload relay
- T1** - Autotransformer
- SH1** - Command button
- KT1** - Time relay
- M1** - Motor

Optional accessories

- Phase fault relay
- Minimum/maximum voltage relay
- Ammeter
- Voltmeter
- Ohmmeter

The series-parallel connection requires the motor to be designed for two rated voltages, the lowest one is equal to the power supply voltage and the other is two times higher.

For this starting method the most common voltage is 220/440 V, i. e., on starting the motor is series connected until it reaches its rated speed and then it is switched to parallel connection.

3.4.6 Electronic Start (Soft-Starter)

New discoveries in electronics have allowed the creation of the solid state starters consisting of a set of pairs of thyristors (SCR) or (combination of thyristors / diodes), one on each motor power terminals.

The trigger angle of each pair of thyristors is controlled electronically for applying a variable voltage to the motor terminals during the “acceleration”. At the end of the start period, adjustable typically between 2 and 30 seconds, the voltage reaches its rated value with a smooth acceleration ramp instead of being submitted to increments or sudden peaks. Applying such starting method the starting current (line current) remains close to the rated current with only smooth variation. Besides the advantage of the voltage (current) control during the start, the electronic switch also has the advantage of not having movable parts or parts that generate electric arcs as the mechanical switches. This is one of the strengths of the electronic switches, since their lifetime becomes longer.

Motor voltage	Operating voltage	Star-Delta Starter	Autotransformer Starter	Series-Parallel Starter	Soft-Starter
220/380 V	220 V 380 V	YES NO	YES YES	NO NO	YES YES
220/440 V	220 V 440 V	NO NO	YES YES	YES NO	YES YES
380/660 V	380 V	YES	YES	NO	YES
220/380/ 440 V	220 V 380 V 440 V	YES NO YES	YES YES YES	YES YES NO	YES YES YES

Table 3.1 - Starting methods x Motors

3.5 Direction of Rotation of Three-Phase Induction Motors

Depending on the electric connection configuration, a three-phase induction motor can operate at any direction of rotation. The direction of rotation can be reversed by exchanging the position of two of the connecting leads. WEG motors are supplied with bi-directional fans unless only one direction of rotation is informed on the data sheet or on additional nameplates. In general the motor allow the operation at any direction of rotation without affecting the motor cooling. Motors without fan, but ventilated by the own load (the fan is the load) must meet the cooling requirements of the motor, independent of the direction of rotation. In case of doubt, contact WEG

4. Acceleration Characteristics

4.1 Torque

4.1.1 Torque X Speed Curve

Definition

The induction motor has zero torque at synchronous speed. As the load increases, the motor speed will decrease gradually until the torque reaches the maximum value which the motor is capable of developing at normal speed. If the load torque continues to increase, the motor speed will suddenly decrease and may even lock the rotor. By graphically representing the torque variation with the speed for a normal motor, we obtain a curve as shown in Figure 4.1.

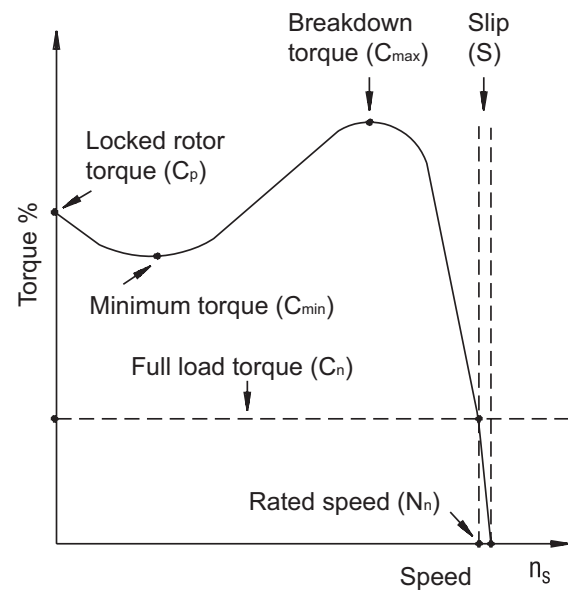

Figure 4.1 - Torque x speed curve

Figure 4.1 highlights and defines some important points. The torque values relative to these points are specified in the standard ABNT NBR 17094 and IEC 60034-1, as shown below:

C_o : basic torque - This is the calculated torque relating to the rated output and synchronous speed.

$$C_o \text{ (Kgfm)} = \frac{716 \cdot P \text{ (cv)}}{n_s \text{ (rpm)}} = \frac{974 \cdot P \text{ (kW)}}{n_s \text{ (rpm)}}$$

$$C_o \text{ (Nm)} = \frac{7024 \cdot P \text{ (cv)}}{n_s \text{ (rpm)}} = \frac{9555 \cdot P \text{ (kW)}}{n_s \text{ (rpm)}}$$

C_n : rated torque or full load torque - This is the torque developed by the motor at rated output at rated voltage and frequency.

C_p : locked rotor torque or starting torque, also called breakaway torque - this is the minimum torque developed by the locked rotor for different angular positions of the rotor at rated voltage and frequency.

This torque can be indicated in Nm or more frequently as percentage of the rated torque.

$$C_p \text{ (%)} = \frac{C_p \text{ (Nm)}}{C_n \text{ (Nm)}} \cdot 100$$

In practice, the locked rotor torque should be as high as possible to enable the rotor to overcome the initial load inertia, and quickly accelerate it, especially when started with reduced voltage.

C_{min} : minimum torque or pull up torque: - This is the smallest torque developed by the motor when accelerating from rest or zero speed to the speed corresponding to maximum torque. In practice this value must not be very low, i.e. the speed torque curve should not have a strong depression during acceleration otherwise starting time is too long, resulting in overheating of the motor, especially in cases of high inertia, or starting on reduced voltage.

C_{max} : maximum torque or breakdown torque - This is the maximum torque developed by the motor at rated voltage and frequency, without abrupt drop in speed.

In practice maximum torque must be as high as possible for two reasons:

- 1) The motor must be able to easily overcome loading peaks which can occasionally occur with crushers, calandering machines, mixers, etc.
- 2) The motor speed should not oscillate, i. e., the speed should not drop abruptly when momentary and excessive voltage drops occur.

4.1.2 Designs - Minimum Standardized Torque Values

Based on their torque characteristics in relation to the speed and starting current, three-phase squirrel cage induction motors are classified into designs, each one complying with a specific type of load. Defined by IEC 60034-1 Standard, the designs are the following:

Design N

Regular locked rotor torque, regular locked rotor current, low slip. These are the most common motors in the market and are used in applications such as pumps, machine tools fans, etc.

Design H

High locked rotor torque, regular locked rotor current, low slip. The motors with this design are used on applications that require high starting torques such as screens, conveyors, high inertia loads, crushers, etc.

Design D

High locked rotor torque, regular locked rotor current, high slip (above 5%). Used on applications such as eccentric presses and similar machines that have periodic load peaks. These motors are also used on elevators and loads that require high starting torque and limited locked rotor current. Figure 4.2 shows the torque curves x speed of the different designs.

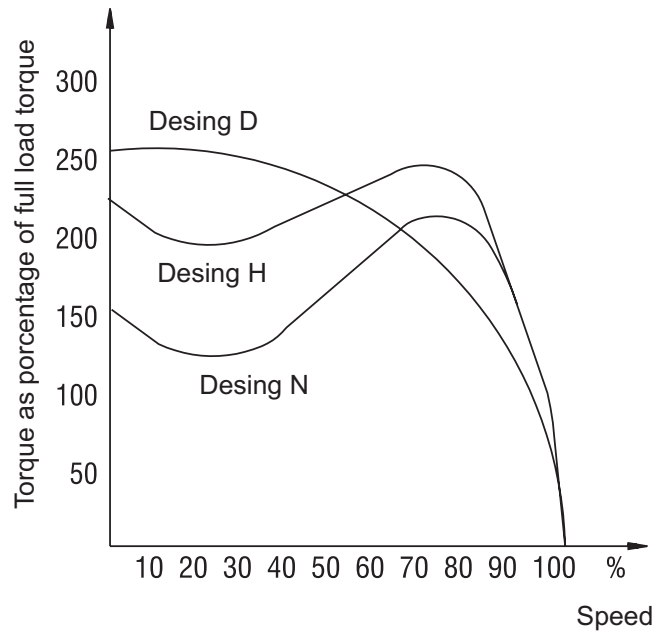

Figure 4.2 - Torque x speed curves for the different designs

Design NY

This design includes motors similar to those of N design; however they are designed for star-delta starting. For these motors at star connection, the minimum torque values with locked rotor and the pull-in torque values are equal to 25% of the values indicated for Design N motors.

Design HY

This design includes motors similar to those of design N; however they are designed for star-delta starting. For these motors at star connection, the minimum torque values with locked rotor and the pull-in torque values are equal to 25% of the values indicated for H Design motors.

The minimum torque values required for design N and design H motors, as specified in IEC 60034-1 standard, are shown in tables 4.1 and 4.2.

For 4, 6 and 8-pole design D motors and rated power of 150 HP and below, IEC 60034 -1 states that: the locked rotor torque (C_p) shall not be lower than 2.75 of the motor rated torque (C_n). Pull-up torque (C_{min}) and breakdown torque (C_{max}) are not regulated by this standard.

IEC 60034-1 does not specify minimum torque values required for 2-poles, design H and design D motors.

Number of Poles		2			4			6			8		
Rated Power Range		C_p/C_n	C_{min}/C_n	C_{max}/C_n	C_p/C_n	C_{min}/C_n	C_{max}/C_n	C_p/C_n	C_{min}/C_n	C_{max}/C_n	C_p/C_n	C_{min}/C_n	C_{max}/C_n
kW	cv	pu											
> 0.36 ≤ 0.63	> 0.5 ≤ 0.86	1.9	1.3	2.0	2.0	1.4	2.0	1.7	1.2	1.7	1.5	1.1	1.6
> 0.63 ≤ 1.0	> 0.86 ≤ 1.4	1.8	1.2	2.0	1.9	1.3	2.0	1.7	1.2	1.8	1.5	1.1	1.7
> 1.0 ≤ 1.6	> 1.4 ≤ 2.2	1.8	1.2	2.0	1.9	1.3	2.0	1.6	1.1	1.9	1.4	1.0	1.8
> 1.6 ≤ 2.5	> 2.2 ≤ 3.4	1.7	1.1	2.0	1.8	1.2	2.0	1.6	1.1	1.9	1.4	1.0	1.8
> 2.5 ≤ 4.0	> 3.4 ≤ 5.4	1.6	1.1	2.0	1.7	1.2	2.0	1.5	1.1	1.9	1.3	1.0	1.8
> 4.0 ≤ 6.3	> 5.4 ≤ 8.6	1.5	1.0	2.0	1.6	1.1	2.0	1.5	1.1	1.9	1.3	1.0	1.8
> 6.3 ≤ 10	> 8.6 ≤ 14	1.5	1.0	2.0	1.6	1.1	2.0	1.5	1.1	1.8	1.3	1.0	1.7
> 10 ≤ 16	> 14 ≤ 22	1.4	1.0	2.0	1.5	1.1	2.0	1.4	1.0	1.8	1.2	0.9	1.7
> 16 ≤ 25	> 22 ≤ 34	1.3	0.9	1.9	1.4	1.0	1.9	1.4	1.0	1.8	1.2	0.9	1.7
> 25 ≤ 40	> 34 ≤ 54	1.2	0.9	1.9	1.3	1.0	1.9	1.3	1.0	1.8	1.2	0.9	1.7
> 40 ≤ 63	> 54 ≤ 86	1.1	0.8	1.8	1.2	0.9	1.8	1.2	0.9	1.7	1.1	0.8	1.7
> 63 ≤ 100	> 86 ≤ 136	1.0	0.7	1.8	1.1	0.8	1.8	1.1	0.8	1.7	1.0	0.7	1.6
> 100 ≤ 160	> 136 ≤ 217	0.9	0.7	1.7	1.0	0.8	1.7	1.0	0.8	1.7	0.9	0.7	1.6
> 160 ≤ 250	> 217 ≤ 340	0.8	0.6	1.7	0.9	0.7	1.7	0.9	0.7	1.6	0.9	0.7	1.6
> 250 ≤ 400	> 340 ≤ 543	0.75	0.6	1.6	0.75	0.6	1.6	0.75	0.6	1.6	0.75	0.6	1.6
> 400 ≤ 630	> 543 ≤ 856	0.65	0.5	1.6	0.65	0.5	1.6	0.65	0.5	1.6	0.65	0.5	1.6

Table 4.1 - Three-phase motors - Locked rotor torque (C_p), pull-in torque (C_{min}) and breakdown torque (C_{max}), for design N motors, relating to the rated torque (C_n).

Number of poles		4			6			8		
Rated Power Range		C_p/C_n	C_{min}	C_{max}	C_p/C_n	C_{min}	C_{max}	C_p/C_n	C_{min}	C_{max}
kW	cv	pu								
> 0.4 ≤ 0.63	> 0.54 ≤ 0.63	3.0	2.1	2.1	2.55	1.8	1.9	2.25	1.65	1.9
> 0.63 ≤ 1.0	> 0.86 ≤ 1.4	2.85	1.95	2.0	2.55	1.8	1.9	2.25	1.65	1.9
> 1.0 ≤ 1.6	> 1.4 ≤ 2.2	2.85	1.95	2.0	2.4	1.65	1.9	2.1	1.5	1.9
> 1.6 ≤ 2.5	> 2.2 ≤ 3.4	2.7	1.8	2.0	2.4	1.65	1.9	2.1	1.5	1.9
> 2.5 ≤ 4.0	> 3.4 ≤ 5.4	2.55	1.8	2.0	2.25	1.65	1.9	2.0	1.5	1.9
> 4.0 ≤ 6.3	> 5.4 ≤ 8.6	2.4	1.65	2.0	2.25	1.65	1.9	2.0	1.5	1.9
> 6.3 ≤ 10	> 8.6 ≤ 14	2.4	1.65	2.0	2.25	1.65	1.9	2.0	1.5	1.9
> 10 ≤ 16	> 14 ≤ 22	2.25	1.65	2.0	2.1	1.5	1.9	2.0	1.4	1.9
> 16 ≤ 25	> 22 ≤ 34	2.1	1.5	1.9	2.1	1.5	1.9	2.0	1.4	1.9
> 25 ≤ 40	> 34 ≤ 54	2.0	1.5	1.9	2.0	1.5	1.9	2.0	1.4	1.9
> 40 ≤ 63	> 54 ≤ 86	2.0	1.4	1.9	2.0	1.4	1.9	2.0	1.4	1.9
> 63 ≤ 100	> 86 ≤ 140	2.0	1.4	1.9	2.0	1.4	1.9	2.0	1.4	1.9
> 100 ≤ 160	> 140 ≤ 220	2.0	1.4	1.9	2.0	1.4	1.9	2.0	1.4	1.9

Table 4.2 - Three-phase motors - Locked rotor torque (C_p), pull-in torque (C_{min}) and breakdown torque (C_{max}), for design H motors, relating to the rated torque (C_n).

- Notes: a) The locked rotor torques (C_p / C_n) are 1.5 times the corresponding values of design N; however, not below 2.0;
 b) The pull-up torques (C_{min} / C_n) are 1.5 times the corresponding values of design N; however, not below 1.4;
 c) The breakdown torques (C_{max} / C_n) are the same of corresponding values of design N; however, not below 1.9 or the corresponding values of pull-up torques (C_{min} / C_n).



4.1.3 Characteristics of WEG Motors

Although WEG states that their motors usually comply with Design N, in many cases their typical actual torque values far exceed the minimum required by the standard. In most cases the values even exceed the minimum requirements of Design H. This means a very high speed-torque curve, bringing the following benefits:

- 1) Quick acceleration under heavy starting conditions, e.g. for piston pumps, loaded conveyers, high inertia loads, compressors with open valves, etc.
- 2) Quick responsiveness for special supplies such as those mentioned since standard motors are always readily available from stock, with price benefits and quick delivery.
- 3) The possibility of using reduced voltage starting methods, e.g. Star-Delta Starters, in normal cases, without affecting perfect load acceleration.
- 4) Due to the high value of the breakdown torque, momentary load peaks and temporary voltage drops are accepted without any sudden speed loss. This is a fundamental requirement for the performance of machines which are subjected to heavy load peaks, such as crushers, calender machines, etc.

4.2 Load Inertia

The driven load inertia is one of the most important characteristics to be checked during the acceleration time to ensure that the motor will be able to drive the load within the ambient requirements or the thermal capabilities of the insulation materials.

Inertia is the way how we measure the resistance of an object to change its rotation movement around a shaft. It also depends on the shaft around which it is rotating, the shape of the object and the way its mass is distributed. The unit of the inertia moment is given by kgm².

The total inertia of the system is given by the load inertia plus motor inertia ($J_t = J_c + J_m$).

In cases where the machine has "different speed than the motor" (ex.: belt/pulley assembly or gearboxes), inertia has to be considered for the motor rated speed as indicated below:

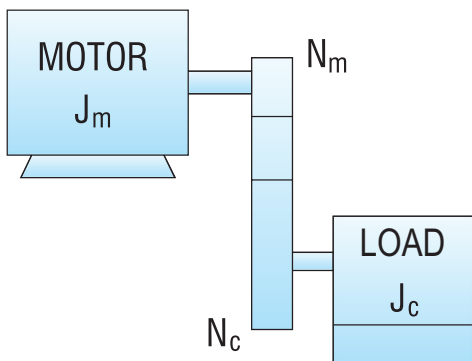

Figure 4.3 - Inertia at different speeds

$$J_{ce} = J_c \left(\frac{N_c}{N_m} \right)^2 \quad (\text{kgm}^2)$$

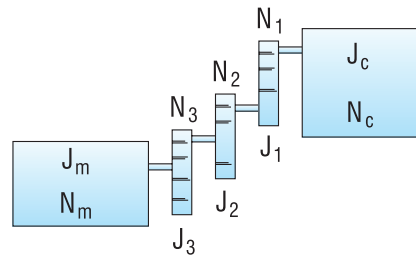

Figure 4.4 - Inertia at different speeds

$$J_{ce} = J_c \left(\frac{N_c}{N_m} \right)^2 + J_1 \left(\frac{N_1}{N_m} \right)^2 + J_2 \left(\frac{N_2}{N_m} \right)^2 + J_3 \left(\frac{N_3}{N_m} \right)^2$$

where: J_{ce} - Load inertia related to the motor shaft

J_c - Load inertia

N_c - Load speed

N_m - Motor rated speed

$$J_t = J_m + J_{ce}$$

The total inertia of the load is essential for determining the acceleration time.

4.3 Acceleration Time

In order to check if the motor is suitable to drive the load, or when designing the installation, starting or protection system, the acceleration time must be known (from the moment the motor starts and accelerates up to the rated speed). The starting time can be determined approximately by the average acceleration torque.

$$t_a = \frac{2 \pi \cdot \text{rps} \cdot J_t}{C_a} = \frac{2 \pi \cdot \text{rps} \cdot (J_m + J_{ce})}{(C_{mmed} - C_{rmed})}$$

t_a - acceleration time in seconds

J_t - total load inertia in kgm²

rps - rated speed in revolutions per second

C_{mmed} - motor average acceleration torque in Nm.

C_{rmed} - load average resistive torque related to the motor shaft in Nm.

J_m - Motor inertia

J_{ce} - Load inertia related to the motor shaft

C_a - Average acceleration torque

The average acceleration torque can be obtained from the difference of motor torque and the load torque. It should be calculated for each rotation interval (the sum of the intervals would give the total acceleration time). In practical terms, it is enough to calculate graphically the average torque, i.e., the difference between motor average torque and load average torque. This average can be obtained graphically, by ensuring that the sum of the areas A_1 and A_2 is the same of area A_3 and that the area B_1 is the same of the area B_2 (see figure 4.5).

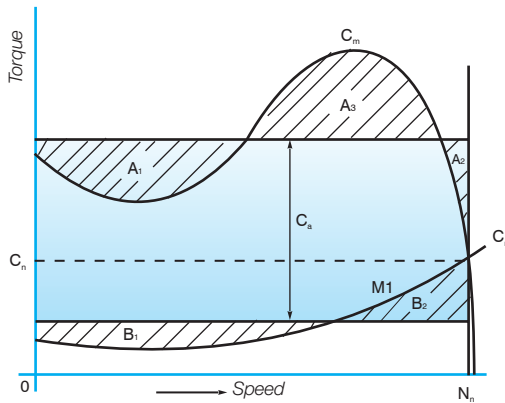

Figure 4.5 - Graphic determination of the average acceleration torque

- C_n = Rated torque
- C_m = Motor torque
- C_r = Load torque
- C_a = Average acceleration torque
- N_n = Rated speed

4.4 Duty Cycles

Due to high starting currents on electric induction motors, the time required to accelerate high inertia loads will result in a sudden motor temperature rise. If the interval between successive starts is very short, motor windings can experience some overheating that will cause some damage or reduce their lifetime. IEC 60034-1 Standard establishes a minimum number of starts (S1) that the motors should withstand in the following conditions:

- a) Two consecutive starts: first start with the motor in cold state, i.e., with the windings at ambient temperature and the second start right after, but with de-energized motor and at rest.
- b) One hot start, i.e., with the windings at running temperature.

The first condition simulates the case when first start fails, for example, the protection system trips, allowing a second start right after. The second condition simulates the case of an accidental motor shutdown during normal operation, for example, due to a power supply fault, allowing to start the motor again right after the power supply is re-established. As the motor temperature rise depends on the inertia of the driven load, the standard establishes the maximum load inertia to which the motors should withstand in order to comply with the conditions above. Table 4.3 shows the inertia values for 2, 4, 6 and 8-pole motors.

Rated Power		Number of Poles			
kW	cv	2	4	6	8
kgm ²					
0.4	0.54	0.018	0.099	0.273	0.561
0.63	0.86	0.026	0.149	0.411	0.845
1.0	1.4	0.040	0.226	0.624	1.28
1.6	2.2	0.061	0.345	0.952	1.95
2.5	3.4	0.091	0.516	1.42	2.92
4.0	5.4	0.139	0.788	2.17	4.46
6.3	8.6	0.210	1.19	3.27	6.71
10	14	0.318	1.80	4.95	10.2
18	22	0.485	2.74	7.56	15.5
25	34	0.725	4.10	11.3	23.2
40	54	1.11	6.26	17.2	35.4
63	86	1.67	9.42	26.0	53.3
100	140	2.52	14.3	39.3	80.8
160	220	3.85	21.8	60.1	123
250	340	5.76	32.6	89.7	184
400	540	8.79	49.7	137	281
630	860	13.2	74.8	206	423

Table 4.3 - Moment of inertia (J)

- a) The values are given as a function of the mass-radius squared. They were calculated by the following formula:

$$J = 0.04 \cdot P^{0.9} \cdot p^{2.5}$$

where: P - rated Power in kW
p - number of pole pairs

- b) For intermediate rated power ratings the external inertia moment should be calculated by the formula above. For loads with higher inertia than the reference values given in table 4.3, which can happen mainly in higher rated power ratings or for the determination of maximum number of starts per hour, our Application Engineering Department should be contacted informing the following application data:
 - Power required by the load. If the duty is intermittent, see last last item: "Duty cycle".
 - Speed of the driven machine.
 - Transmission: direct, flat belts, V-belts, chain, etc.
 - Transmission ratio with dimensional sketches and distances between pulleys, if transmission is realized by pulley.
 - Abnormal radial loads applied to the shaft end: belt traction in special transmissions, heavy parts coupled to the shaft end, etc.
 - High axial loads applied to the shaft end: transmission by helical gears, hydraulic thrusts of pumps, heavy rotating parts mounted vertically, etc.
 - Mounting different from B3D, indicate mounting code of the application.
 - Required starting torque and breakdown torque
 - Description of the driven equipment and operation.
 - Moment of inertia or GD2 of the movable parts of the equipment and the related speed.
 - Duty cycle, if not continuous duty, provide detailed description of the operation cycles and specify:
 - a) Required power and the duration of each load period;
 - b) Duration of the no-load periods (motor at no-load or de-energized);
 - c) Reversals of the direction of rotation;
 - d) Counter current braking.

The motors must have their number of starts per hour limited according to their duty indicated on the nameplate and / or as agreed for the design.

Excessive starts can cause overheating and consequent burning of the electric motor.

In case of doubt, please contact WEG.

4.5 Locked Rotor Current

4.5.1 Standardized Maximum Values

The maximum limits for the locked rotor current, as function of the rated motor output are valid for any number o poles, are shown in Table 4.4, indicated in terms of apparent power absorbed with locked rotor relating to the rated output, kVA / HP or kVA / kW.

$$\text{kVA/cv} = \frac{\text{Locked rotor apparent power}}{\text{Rated power}}$$

$$\text{kVA/cv} = \frac{\sqrt{3} \cdot I_p \cdot U}{P(\text{cv}) \cdot 1000}$$

$$\text{kVA/kW} = \frac{\sqrt{3} \cdot I_p \cdot U}{P(\text{kW}) \cdot 1000}$$

where: I_p - Locked rotor current or starting current
 U - Rated voltage (V)
 P - Rated power (HP or kW)

Power range		S_p / P_n	
kW	HP	kVA/kW	kVA/cv
> 0.37 ≤ 6.3	> 0.5 ≤ 8.6	13	9.6
> 6.3 ≤ 25	> 8.6 ≤ 34	12	8.8
> 25 ≤ 63	> 34 ≤ 86	11	8.1
> 63 ≤ 630	> 86 ≤ 856	10	7.4

Table 4.4 - Maximum values of the locked rotor apparent Power (S_p / P_n), expressed as per unit value of the rated output (P_n)

Note: to obtain the ratio I_p / I_n , multiply kVA/kW by the performance product and by the Power factor at full load.

I_p = Locked rotor current;
 I_n = Rated current

5. Speed Regulation of Asynchronous Motors

The relationship between speed, frequency, number of poles and slip is given by:

$$n = \frac{2}{2p} \cdot f \cdot 60 \cdot (1 - s)$$

where: n = rpm
 f = frequency (Hz)
 $2p$ = number of poles
 s = slip

The formula shows that for the speed regulation of asynchronous motors, we can change the following parameters:

- a) $2p$ = number of poles
- b) s = slip
- c) f = frequency (Hz)

5.1 Changing the Number of Poles

There are three ways to change the number of poles of an asynchronous motor, as follows:

- separated stator windings;
- one winding with pole commutation;
- combination of the two options above.

In all these cases, the speed regulation will be smooth, without losses, but frame size will be larger than for a single speed motor.

5.1.1 Two Speed Motors with Independent Windings

This type of motor has the advantage of combining windings with any number of poles; however it is limited by core dimensioning (stator / rotor) and by the frame size that is usually far greater than the frame of a single speed motor.

5.1.2 Dahlander

Two-speed motors with commutating pole windings is the most used system, also called "Dahlander connection." This connection provides a ratio of number poles ratio of 1:2 with consequent speed ratio 2:1.

It can be connected as follows (Figure 5.1):

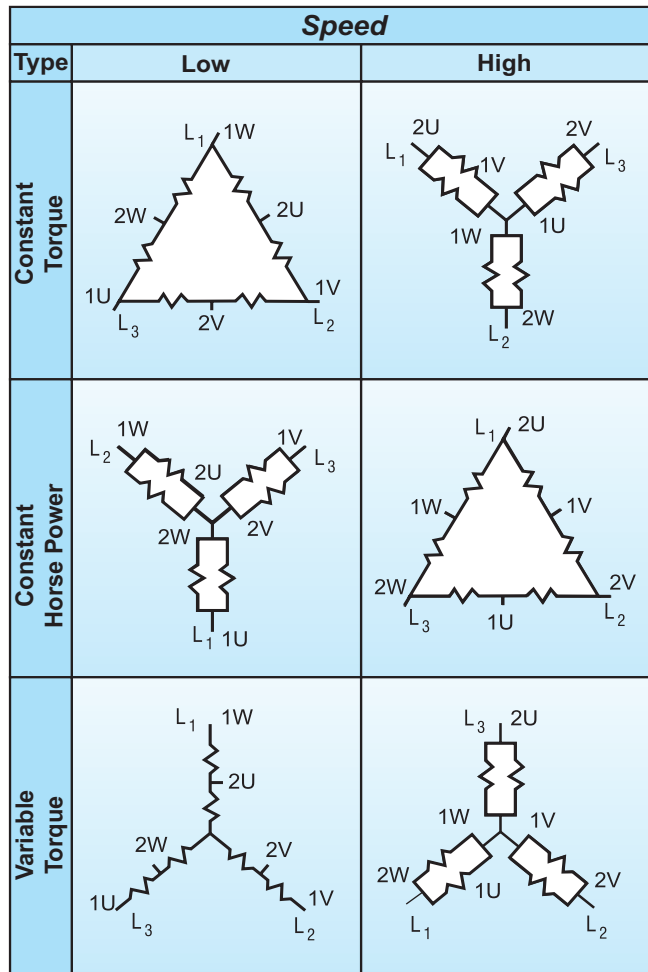

Figure 5.1 - Summary of the Dahlander connection

■ Constant torque

Torque is constant on both speeds and power ratio is 0.63:1. In this case, the motor is D/YY connected.

Example:

0.63/1HP motor - 4/2 poles - D/YY.

This connection is suitable for applications where the load torque curve remains constant with the speed variation.

■ Constant power

In this case, the torque ratio is 2:1 and horse power remains constant. The motor is YY/D connected.

Example: 10/10 HP - 4/2 poles - YY/Δ.

■ **Variable torque**

In this case, the power ratio will be approximately 1:4. It is applied to loads such as pumps and fans. The connection in this case is Y/YY.

Example: 1/4 HP - 4/2 poles - Y/YY.

5.1.3 Motors with Two or More Speeds

It is possible to combine a Dahlander winding with a single winding or more. However, this type of motor is not usual and it is used only for special applications.

5.2 Slip Variation

In this case, the rotating field speed is maintained constant, and the rotor speed is changed according to the conditions required by the load, which can be:

- a) rotor resistance variation
- b) stator voltage variation
- c) variation of both simultaneously.

These variations are achieved by increasing rotor losses which limits the use of this system.

5.2.1 Rotor Resistance Variation

This method is used for slip ring motors and is based on the following equation:

$$s = \frac{p_{j2}}{\omega_o \cdot T} = \frac{3 \cdot R_2 \cdot I_2^2}{\omega_o \cdot T}$$

- where:
- p_{j2} = Rotor losses (W)
 - ω_o = Synchronous speed in rd/s
 - T = Rotor torque
 - R_2 = Rotor resistance (Ohms)
 - I_2 = Rotor current (A)
 - s = slip

The connection of an external resistance to the rotor increases the motor slip (s) and results in speed variation. Figure below shows the effect of the increase of R2.

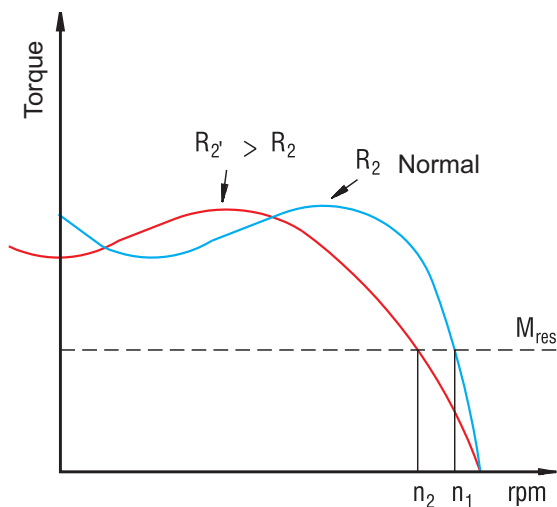

Figure 5.2 - Torque curve with rotor resistance variation

5.2.2 Stator Voltage Variation

This is not an usual method, since it also generates rotor losses and speed variation range is small.

5.3 Frequency Inverters

For further information about the use of frequency inverters for speed control, see chapter "Application of induction motors fed by frequency inverters".

6. Brake Motor

The brake motor consists of an induction motor coupled to a single-disc brake, forming an integral, compact unit. The induction motor is a totally enclosed fan cooled machine with the same mechanical and electrical performance of WEG general purpose motors.

The brake is built with few movable parts which gives long life with reduced maintenance. The two faces of the brake pads create a large contact area, requiring only little pressure during the braking process, which reduces the brake heating and the wear is minimum. Besides that, brake is cooled by the motor cooling system. The electromagnet drive coil, protected with epoxy resin, can be operated continuously with voltages varying 10% above and below the rated voltage.

The electromagnet drive coil is DC powered, supplied by a bridge rectifier made of silicon diodes and varistors, that suppress undesirable voltage spikes and allow a fast current shutdown. The DC power supply provides faster and smoother brake operation.

Typical application for brake motors:

- Machine-tools
- Looms
- Packing machines
- Conveyors
- Bottle washing and filling machines
- Winding machines
- Bending machines
- Hoists
- Cranes
- Lifts
- Roll adjustment of rolling machines
- Graphic machines

In general terms, brake motors are used on equipment requiring quick stops based on safety, positioning and time saving factors.



6.1 Brake Operation

When motor is disconnected from power supply, the control also switches off the coil current and the electromagnet stops operating. The pressure springs force the armature towards the motor non drive-end shield. Fitted in the braking disc, the braking pads are compressed between the two friction surfaces, the armature and the endshield braking the motor until it stops. When the motor is switched on, the coil is powered and the armature is pulled against the electromagnet frame by eliminating the spring force. Once they are free, the braking pads move axially in their seatings and they remain out of the friction area. Now the braking process is ended and allows starting the motor freely.

As option, WEG can supply the motors with brake lining.

6.2 Connection Diagram

The WEG brake motor allows 3 types of connection diagrams supplying slow, medium and quick braking.

a) Slow braking

The power supply of the brake coil bridge rectifier is applied directly from the motor terminals, without interruption, as shown below:

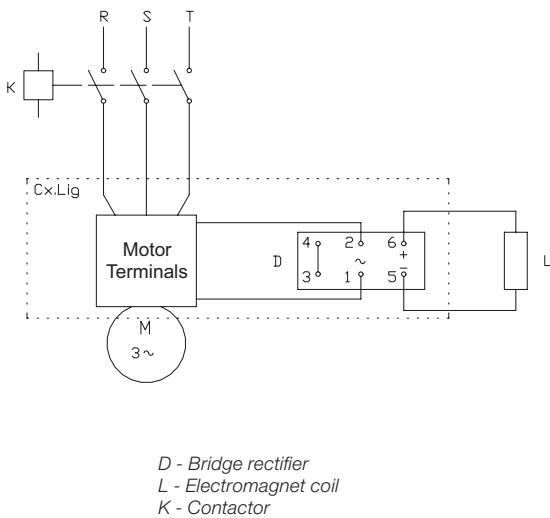

Figure 6.1 - Connection diagram for slow braking

b) Medium braking

In this case a contact for interruption of the bridge rectifier supply current in the AC circuit is interconnected. It is essential that this is a NO auxiliary contact (S1) of the contactor itself or of the motor magnetic switch in order to allow switching on and off of the brake and motor simultaneously.

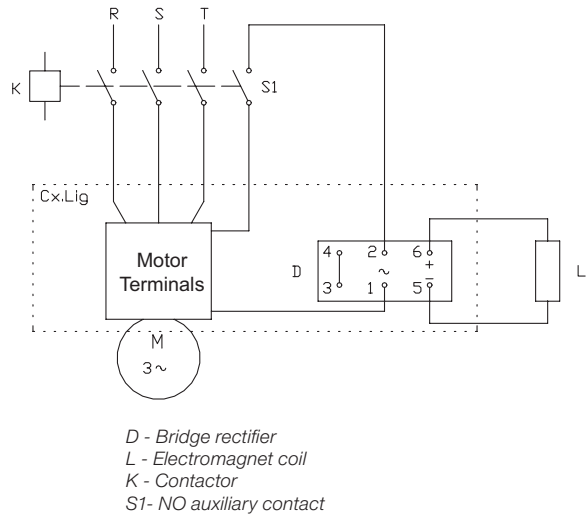

Figure 6.2 - Connection diagram for medium braking

c) Fast braking

A contact for interruption is directly connected to one of the coil supply cables in the DC circuit. It is essential that this is a NO auxiliary contact of the contactor itself or a magnetic switch of the motor.

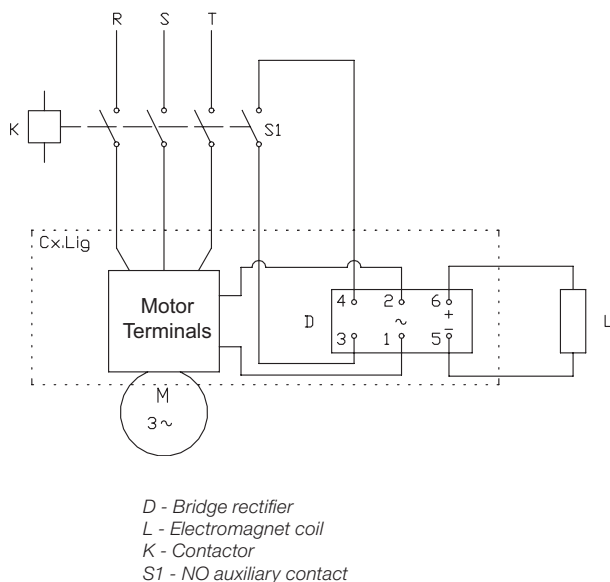

Figure 6.3 - Connection diagram for fast braking

6.3 Brake Coil Power Supply

The power supply of the bridge rectifier with AC-current, can be obtained from an independent source or from the motor terminals. This power supply may be in 110/220 V, 440 V or 575 V, according to the characteristics of the bridge rectifier / brake coil set.

The brake coil can also be supplied for 24 V DC, but in this case the power supply should be provided through an independent source (direct current), eliminating the use of bridge rectifier (RB).

Through motor terminals

- a) Motor 220/380 V: connect motor terminal 1 and 2 of the RB (220 V AC) between the terminals 1 and 4 of the motor.
 - b) Motor 380/660 V: connect motor terminal 1 and 2 of the RB (220 V AC) between the terminal 2 and the neutral.
 - c) Motor 220/380/440/760 V: connect the motor terminals 1 and 2 of the RB (220 V AC) between the terminals 1 and 4 of the motor.
 - d) Motor with 3 leads (single voltage): connect the terminals 1 and 2 of the RB between the 1 and 2 of the motor (if the RB has the Same voltage of the motor).
 - e) Two speed motor 220 V (RB 220 V AC):
 1. High speed: connect between the motor terminals 4 and 6.
 2. Low speed: connect between the motor terminals 1 and 2.
- Motor 440 V: connect the terminals of the rectifier bridge (440 V AC) to the motor terminals.

Independent power supply (AC):

For motor that are wound for other voltages, connect the terminals of the rectifier bridge to the independent 220 V power supply; however, always with simultaneous interruption when the motor power supply is switched off. With independent power supply it is possible to electrically release the brake, as shown in figure below.

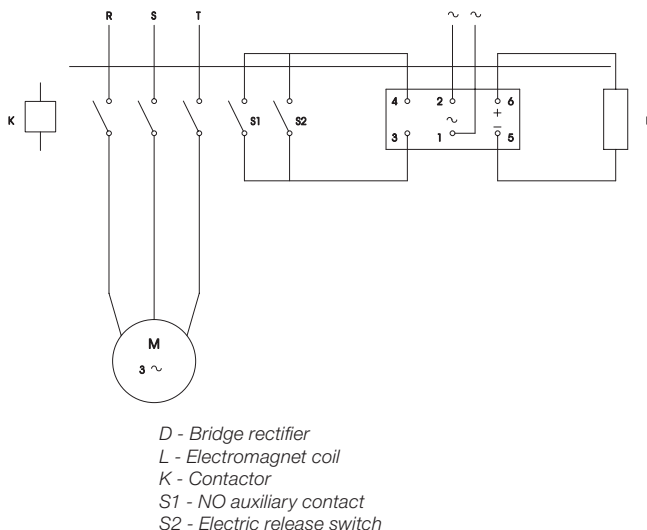

Figure 6.4 - Connection diagram for independent power supply

6.4 Brake Torque

It is possible to obtain a smoother motor stop by reducing the braking torque value. This is achieved by removing some brake pressure springs.

Important!

The springs must be removed in such a way that the remaining ones stay symmetrically disposed, avoiding in this way any friction even after operating the motor and thus avoid uneven wear of the braking pads.

6.5 Air Gap Adjustment

WEG brake motors are supplied with an initial factory set air gap, that is, the gap between the armature and the frame with the energized brake, is pre-adjusted at the factory to the minimum value as indicated in Table 6.1.

As they are simple construction machines, brake motors require low maintenance. Only a periodical air gap adjustment is required. It is recommended to clean internally the brake motor in cases of penetration of water, dust, etc. or at the time motor when the periodical maintenance is carried out.

Frame size	Initial air gap (mm)	Maximum air gap (mm)
71	0.2 - 0.3	0.6
80	0.2 - 0.3	0.6
90S - 60L	0.2 - 0.3	0.6
100L	0.2 - 0.3	0.6
112M	0.2 - 0.3	0.6
132S - 132M	0.3 - 0.4	0.8
160M - 160L	0.3 - 0.4	0.8

Table 6.1

Due to the natural wear of the braking pads, the size of the air gap gradually increases without affecting the performance of the brake until it reaches the maximum value shown on Table 6.1. To adjust the air gap to its initial value, proceed as follows:

- a) Unfasten the bolts and remove the fan cover;
- b) Remove the seal ring;
- c) Measure the air gap at three points, near the adjustment screws, using a set of feeler gauges;
- d) If the gap width is equal to or greater than the maximum indicated dimension, or if the three readings are not the same, proceed the adjustment as follows:
 1. loosen the locknuts and the adjustment screws;
 2. adjust the air gap to the initial value indicated in Table 6.1 tightening by equally the three adjustment screws. The value of the air gap must be uniform at the three measured points, and must be such that the feeler gauge corresponding to the minimum gap, moves freely and the feeler gauge corresponding to the maximum gap cannot be inserted into the measured points;
 3. tighten the locking bolts screws until the ends touch the motor endshield. Do not overtighten them;

4. Tighten the locknuts;
5. Re-check the air gap to ensure the measurements are as per Item 2 above;
6. Remount the seal ring;
7. Remount the fan cover and fasten it with its fixing bolts.

The interval between periodical adjustments of the air gap, i.e., the number of braking cycles until brake pads wear to their maximum allowed value depends on the load, the frequency of operations, and the cleanness of working environment, etc. The ideal interval can only be determined by closely following up the performance of the brake motor during the first months of operation under actual working conditions. The wear of the brake pads also depends on the moment of inertia of the load.

WEG is also able to supply other brake options for more severe applications (e.g., cranes, tractioners, gear boxes, etc.). In case of doubt, please contact WEG.

7. Operating Characteristics

7.1.1 Winding Heating Up

Losses

The effective or useful power output supplied by the motor at the shaft end is lower than the power input absorbed by the motor from the power supply, i. e., the motor efficiency is always below 100%. The difference between input and output represents the losses that are transformed into heat. This heat warms up the windings and therefore must be removed from the motor to avoid excessive temperature rise. This heat removal must be ensured for all types of motors. In the automobile engine, for example, the heat generated by internal losses has to be removed from the engine block by water flow through radiator or by fan, in the case of air-cooled engines.

Heat dissipation

The heat generated by internal losses is dissipated to the ambient air through the external surface of the frame. In totally enclosed motors this dissipation is usually aided by a shaft mounted fan. Good heat dissipation depends on:

- Efficiency of the ventilating system;
- Total heat dissipation area of the frame;
- Temperature difference between the external surface of the frame and the ambient air ($t_{ext} - t_a$).

a) A well designed ventilation system, as well as having an efficient fan capable of driving a large volume of air, must direct this air over the entire circumference of the frame to achieve the required heat exchange.

A large volume of air is absolutely useless if it is allowed to spread out without dissipating the heat from the motor.

b) The dissipation area must be as large as possible.

However, a motor with a very large frame require a very large cooling area and consequently will become too expensive, too heavy, and requires too much space for installation. To obtain the largest possible area while at the same time keeping the size and weight to a minimum (an economic requirement), cooling fins are cast around the frame.

c) An efficient cooling system is one that is capable of dissipating the largest possible amount of heat through the smallest dissipation area. Therefore, it is necessary that the internal drop in temperature, shown in figure 7.1, is minimized. This means that a good heat transfer must take place from the inside to the outer surface of the motor.

As explained, the objective is to reduce the internal drop in temperature (i.e. to improve the heat transfer) in order to obtain the largest possible drop of the outside temperature necessary for good heat dissipation. Internal drop in temperature depends on different factors which are indicated in Fig. 7.1 where the temperatures of certain important areas are shown and explained as follows:

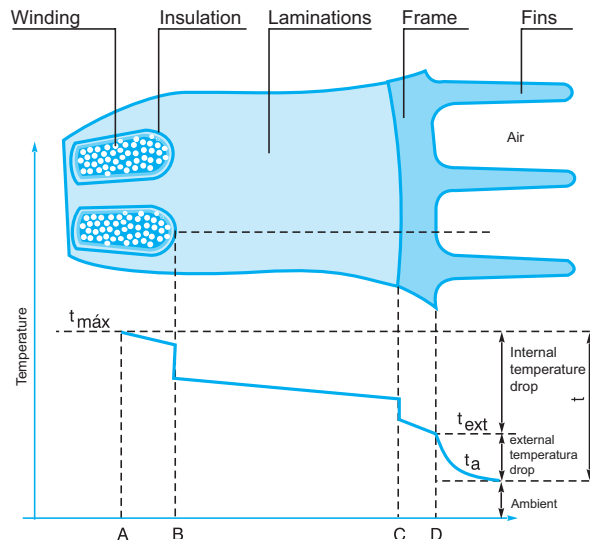

Figure 7.1

- A - The winding hottest spot is in the centre of the slots where heat is generated as a result of losses in the conductors.
- AB - The drop in temperature is due to the heat transfer from the hottest spot to the outer wires. As the air is a very poor conductor of heat it is very important prevent voids inside the slots, i.e. the windings must be compact and perfectly impregnated with varnish.
- B - The drop in temperature through the slot insulation and through the contact of the insulation material with the conductors and by contact with the core laminations. By employing modern material far better heat transfer is obtained through the insulation materials. Perfect impregnation improves the contact of the inner side by eliminating voids. Perfect alignment of the laminations improves the contact to the outer side, eliminating layers of air, which have a negative effect on heat transfer.

- BC - Drop in temperature by the transmission through the stator lamination material.
- C - Drop in temperature by contact between the stator core and the frame. Heat transmission depends on the perfect contact between the parts, good alignment of the laminations, and accuracy in the machining of the frame. Uneven surfaces leave empty spaces, resulting in poor contact and consequently bad heat transmission.
- CD - Drop in temperature by the transmission through the frame thickness.

Due to modern design, use of first class material, improved manufacturing processes, and continuous quality control, WEG motors ensure excellent heat transfer properties from the motor inside to the outside thus eliminating “hot spots” in the windings.

Outer surface temperature of the motor

Figure below shows the recommended places where the outer surface temperature of an electric motor should be checked with calibrated temperature measuring instruments:



Figure 7.2

Important!

Measure also the ambient temperature (at a max. distance of 1 m from the motor)

7.1.2 Motor Lifetime

As already informed in the Item “Insulation materials and insulation systems” its useful lifetime of the motor depends almost exclusively on the life of the winding insulation. The lifetime of a motor is affected by many factors, such as moisture, vibration, corrosive environments and others. Among all these factors, the most important is the working temperature of the employed insulation materials. An increase from 8 to 10 degrees above the rated temperature class of the insulation system can reduce the motor lifetime by half.

When speaking about decreasing the useful lifetime of the motor, we are not talking about high temperatures where the insulation system burns and the winding is suddenly destroyed. For the insulation lifetime this means a gradual ageing of the insulation material which becomes dry, losing its insulation properties until it cannot withstand the applied voltage. This results in a breakdown of the insulation system and a consequent short-circuit of the windings. Experience shows that the insulation system has practically an unlimited lifetime if the temperature is kept below a certain limit if this temperature limit is exceeded,

the insulation lifetime will shorten as the temperature increases. This temperature limit is well below the “burning” temperature of the insulation system and depends on the type of used insulation material.

This temperature limit refers to the hottest spot in the insulation system, but not necessarily to the whole winding. One weak point in the inner part of the windings will be enough to destroy the insulation system.

It is recommended to use temperature sensors as additional protection devices for the electric motor. These protection devices will ensure a longer lifetime and more process reliability.

The alarm and / or shutdown setting should be performed according to the motor temperature class. In case of doubt, contact WEG.

7.1.3 Insulation Classes

Insulation class definition

As previously mentioned the temperature limit depends on the type of used material used. In order to comply with the standards the insulation material and insulation systems (each one formed by a combination of several materials) are grouped in INSULATION CLASSES. Each one is defined by the particular temperature limit, i.e. by the highest temperature that the insulation material or system can withstand continuously without affecting its useful life.

The insulation classes used for electrical machines and their respective temperature limits is accordance with IEC 60034-1 are as follows:

- Class A (105 °C)
- Class E (120 °C)
- Class B (130 °C)
- Class F (155 °C)
- Class H (180 °C)

7.1.4 Winding Temperature Rise Measurement

It would be rather difficult to measure the temperature of the winding with thermometers or thermocouples since the temperature differs from one spot to another and it is impossible to know if the measurement point is near the hottest spot. The most accurate and reliable method for determining the winding temperature is by measuring the variation of the winding resistance as function of the temperature.

The temperature rise measurement by the resistance method, for copper conductors, is calculated according to the following formula:

$$\Delta t = t_2 - t_a = \frac{R_2 - R_1}{R_1} (235 + t_1) + t_1 - t_a$$

where: Δt = temperature rise;

t_1 = winding temperature prior to testing, which should be practically equal to the cooling medium, measured by thermometer;

t_2 = winding temperature at the conclusion of the test;

t_a = temperature of the cooling medium at the conclusion of the test;

R_1 = winding resistance prior to testing;

R_2 = winding resistance at the end of the test.

7.1.5 Electric Motor Application

The hottest spot temperature in the winding should be maintained below the maximum allowed temperature for the insulation class. The total temperature is the sum of the ambient temperature, plus temperature rise (Δt), plus the difference existing between the average winding temperature and the hottest spot. Motor standards specify the maximum temperature rise Δt , so the temperature of the hottest spot remains within the allowable limit based on the following considerations:

- a) Ambient temperature should not exceed 40 °C, as per standard; above this value, working conditions are considered as special operating conditions.
- b) The difference between the average temperature of the winding and the hottest spot does not vary very much from motor to motor and its value specified by standard, is 5 °C for Classes A and E, 10 °C for Class B and F and 15 °C for Class H.

Therefore, motor standards specify a maximum allowed ambient temperature, as well as a maximum allowed temperature rise for each insulation class. Thus, the temperature of the hottest spot is indirectly limited. The figures and the allowable temperature composition for the hottest spot are shown on Table 7.1 below:

Insulation Class		A	E	B	F	H
Ambient temperature	°C	40	40	40	40	40
Δt = temperature rise (resistance method)	°C	60	75	80	105	125
Difference between the hottest spot and average temp.	°C	5	5	10	10	15
Total: temperature of the hottest spot	°C	105	120	130	155	180

Table 7.1 - Temperature composition as function of the insulation class

For marine motors all requirements specified by the classification societies must be considered, as shown in Table 7.2.

Classification societies for marine motors	Maximum ambient temperature (°C)	Maximum allowable temperature rise for insulation class, Δt in °C (resistance variation method)			
		A	E	B	F
Germanischer Lloyd	45	55	70	75	96
American Bureau of Shipping	50	55	65	75	95
Bureau Véritas	50	50	65	70	90
Norske Veritas	45	50	65	70	90
Lloyds Register of Shipping	45	50	65	70	90
RINA	45	50	70	75	—

Table 7.2 - Temperature correction for marine motors

7.2 Thermal Protection of Electric Motors

Motors used for continuous duty must be protected against overloads by a device integrated to the motor, or an independent device, usually fitted with a thermal relay having rated or setting current equal to or below the value obtained by multiplying the rated motor power supply current (I_n) by the Service Factor (SF), as shown in table below:

Motor Service Factor (SF)	Relay current setting
1.0 to 1.15	$I_n \cdot SF$
≥ 1.15	$(I_n \cdot SF) - 5\%$

Table 7.3 - Power supply current \times Service Factor

The thermal protection is provided by means of thermoresistances (calibrated resistances), thermistors, thermostats or thermal protectors. The temperature detectors to be used are defined in accordance with the temperature class of the insulation materials used for each type of machine as well as based on customer requirements.

7.2.1 Resistance Temperature Detector (Pt-100)

The temperature detectors operate on the principle that the electrical resistance of a metallic conductor varies as function of the temperature (generally platinum, nickel or copper conductors). The temperature detectors are fitted with calibrated resistance which varies linearly with the temperature, allowing continuous follow up of motor heating on the controller display, with high degree of accuracy and response sensitivity.

The same detector can be used for alarm (when motor is operated above the normal working temperature) and for tripping operation (usually set to the maximum temperature of the insulation class). The resistance of the cables, contacts, etc. can interfere with the measurement so there are different types of configurations that can be carried out to minimize these effects.

- The two-wire configuration is usually satisfactory in places where the cable length to the sensor instrument does not exceed 3.0 m, using cables 20 AWG.
- For the three-wire configuration (commonly used in industry) there will be a compensation of the electrical resistance by the third wire.
- For the four wire configuration (more accurate assembly) there are two connections for each bulb terminal (two cables for voltage and two cables for current), thus obtaining a total balancing of the resistance (this configuration is used where high accuracy is required).

Disadvantage

High cost of the sensor elements and control circuits.



Figure 7.3 - Internal and external view of the thermoresistors

The temperature for the Pt-100 can be obtained from the formula below or on tables provided by manufacturers.

$$t \text{ } ^\circ\text{C} = \frac{r - 100}{0.385}$$

r - resistance measured in Ohms

7.2.2 Thermistors (PTC and NTC)

Thermistors are temperature sensors consisting of semiconductor materials that vary its resistance very fast when reaching certain temperature.

- PTC - positive temperature coefficient
- NTC - negative temperature coefficient

The “PTC” thermistors increase their resistance very fast with temperature increase and some are characterized by the abrupt resistance increase which makes them useful for thermal protection devices. The “NTC” thermistors reduce their resistance when temperature increases. Thus these thermal protection devices are used mostly to protect the motor against overheating.

The sudden change in resistance interrupts the current in PTC, activates an output relay, which turns off the main circuit. Thermistors can be used for alarm and tripping purpose. For this purpose two thermistors are required. They must be series connected, per phase.

The thermistors have reduced size, do not have mechanical wear, and provide faster response when compared to other temperature sensors. However they do not allow continuous monitoring of the motor heating process. Thermistors with their electronic circuit controls ensure complete protection against overheating caused by phase-fault, overload, under/overvoltages or frequent reversals of direction of rotation or on-off cycles. They have low cost, when compared to the Pt-100. However, they require a relay to control the alarm or operation activation.



Figure 7.4 - External view of a thermistor

Please find in the table below the main PTC types used for electric motors. The table shows the colors of the PTC cables with their respective activation temperature.

Cable colors	Temperature °C
Dark red	110
Grey	120
Light blue	140
Blue	160
Red	180

Table 7.4 - Cable colors

WEG also supplies electronic relay RPW that has the specific function to acquire the signal from the PTC and activates its output relay. For further information, please contact WEG.

7.2.3 Bimetal Thermal Protectors - Thermostats

These bimetal thermal protectors (thermostat) with NC silver contacts open when pre-determined temperature rise is reached. When the activation temperature of the bimetal thermal protector decreases, the thermostat will return to its original form instantaneously allowing to close the contacts again. The thermostats can be used on three-phase electric motors for alarm or tripping purposes or both (alarm and tripping).

These thermostats are inserted into the winding heads of different phases and are series connected to the contactor coil where, depending on the required protection and on the customer specifications, three thermostats (one per phase) or six thermostats (two per phase) can be used.

For alarm and tripping operation (two per phase), the alarm thermostats should be suitable for the activation at the high expected motor temperature, while the tripping thermostats should activate at the maximum temperature allowed for the insulation material.

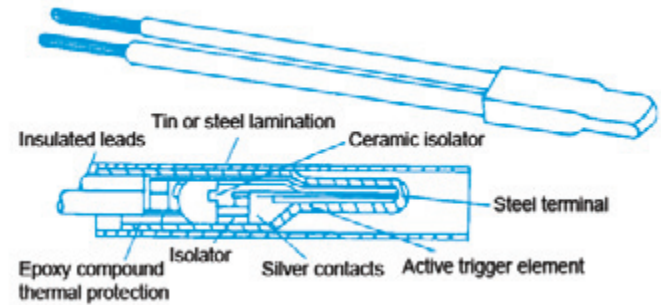

Figure 7.5 - Internal and external view of a thermostat

The thermostats are also used for special applications of single-phase motors. In these applications, the thermostat can be series connected with the motor power supply, provided the motor current does not exceed maximum current allowed for the thermostat. If this occurs, the thermostat must be series-connected with the contactor coil. The thermostats are installed in the winding heads of different phases.



Figure 7.6 - Thermostat installation in the winding

Note: WEG recommends the installation of temperature sensors to protect the windings and bearings of the electric motor and so increase its useful life during operation.

7.2.4 Phenolic Thermal Protection System

These bimetal temperature sensors are fitted with NC contacts and are applied mainly for overheating protection of single-phase induction motors, caused by overloads, locked rotor conditions, voltage drops, etc.

The thermal protector is basically formed by one bimetallic disc that has two moving contacts, one resistance and one pair of fixed contacts. The thermal protector is series-connected with the power supply and, due to the thermal dissipation caused by the current flowing through its internal resistance, the disc is submitted to a deformation that opens the contacts and motor power supply is interrupted.

After the temperature drops below the specified one, the thermal protector will reset. Depending on reset method, two types of thermal protectors may be used:

- a) Auto-reset thermal protector
- b) Manual reset thermal protector

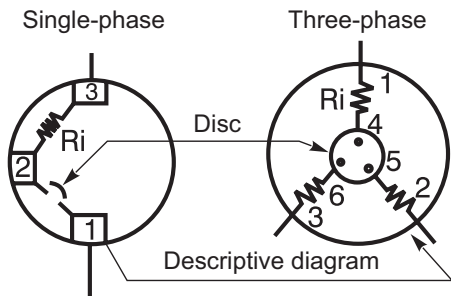
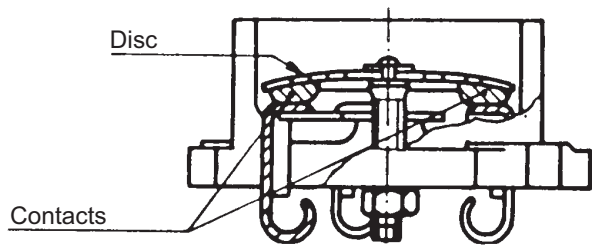

Figure 7.7 - Internal view of the thermal protector

Thermal protectors can also be used for three-phase motors, but only when Y connected. The following connection diagram can be used:

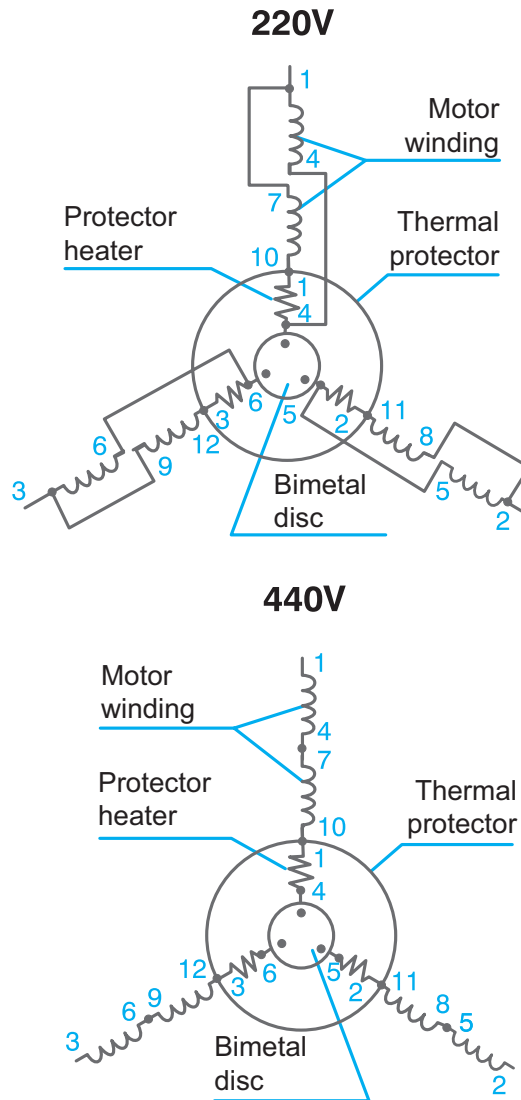

Figure 7.8 - Thermal protector connection diagram for three-phase motors

Advantages

- Combination of a thermal protector sensitive to temperature and current;
- Possibility of automatic reset.

Disadvantages

- Current limitation, since the thermal protector is directly connected to the winding of the single-phase motor;
- Application on three-phase motors only when star-connected.

Note: WEG recommends the installation of temperature sensors to protect the windings and bearings of the electric motor and so increase its useful life during operation.

	Thermoresistor (Pt-100)	Thermistor (PTC e NTC)	Thermostat	Phenolic Thermal protector
Protection device	Calibrated resistance	Semiconductor	<ul style="list-style-type: none"> Moving contacts Bimetal cont. 	Moving contacts
Disposition	Winding head	Winding head	<ul style="list-style-type: none"> Inserted in the Inserted in the winding head 	Inserted in the circuit
Operation	External control of the protection system	External control of the protection system activation	<ul style="list-style-type: none"> Direct activation External control of the protection system active. 	Direct activation
Current limitation	Control current	Control current	<ul style="list-style-type: none"> Motor current Control current 	Motor current
Type of sensitivity	Temperature	Temperature	Current and temperature	Current and temperature
Number of Units per motor	3 or 6	3 or 6	3 or 6 1 or 3	1
Type of control	Alarm and/or tripping	Alarm and/or tripping	<ul style="list-style-type: none"> Tripping Alarm and/or tripping 	Tripping

Table 7.5 - Thermal protection

Causes of overheating	Current based protection		Protection with thermal probes and thermal relay
	Only fuse or Circuit breaker	Fuse and thermal relay	
Overload with 1.2 times rated current	○	●	●
Duty cycles S1 to S10	○	◐	●
Braking, reversals and frequent starts	○	◐	●
Operating with more than 15 starts per hour	○	◐	●
Locked rotor	◐	◐	●
Phase fault	○	◐	●
Excessive voltage oscillation	○	●	●
Line frequency oscillation	○	●	●
Excessive ambient temperature	○	○	●
External heating caused By bearing, belts, pulleys, etc	○	○	●
Obstructed ventilation	○	○	●

Table 7.6 - Comparison between motor protection systems

Caption: Unprotected ○
Partially protected ◐
Totally protected ●

We do not recommend using “molded case circuit-breaks for distribution and miniature circuit breakers for the protection of electric motor starting since these devices do not meet the electric motor protection standard due to the following reasons:

- Usually these circuit-breakers do not have regulation/setting possibilities for their thermal current/rated overload, having only fixed values of this rated current and in most cases it is not equal to the rated current of the motor.
- In case of three-phase systems, the thermal device of the circuit-breakers does not have the protection against “phase fault” as its thermal device does not have the “typical bipolar overload” - 2 phases - provided on the normal and the electronic overload relays.

7.3 Service Duty

According to IEC 60034-1, the service duty is the degree of regularity of load to which the motor is submitted. Standard motors are designed for continuous running duty. The load is constant during an indefinite period of time, and it is equal to the rated motor output. It is purchaser responsibility to state the duty as accurately as possible. In cases where there are no load variations or when variations can be predicted, the duty can be indicated by numbers or by means of charts representing the load variations over time. Whenever the actual load variation in real time cannot be determined a fictitious sequence, no less severe than the actual duty should be indicated by the customer. When another starting duty is used than the informed one on the motor nameplate this may result in motor overheating and consequent motor damage. In case of doubt, contact WEG.

7.3.1 Standardized Service Duties

According to IEC 60034-1, the duty types and the assigned alphanumeric symbols are explained below:

a) Duty type (S1) - continuous running duty

Operation at a constant load maintained for sufficient time to allow the machine to reach the thermal equilibrium, see Figure 7.9.

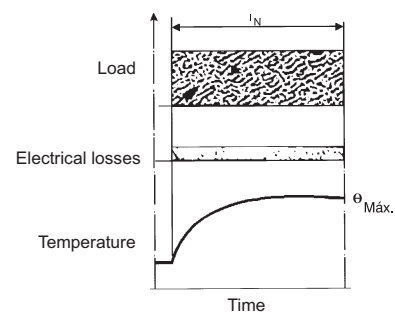

Figure 7.9

t_N = operation time at constant load
 $\theta_{m\acute{a}x}$ = maximum temperature attained

b) Duty type (S2) - Short-time duty

Operation at constant load for a given time, less than that required to reach thermal equilibrium, followed by a time de-energized and at rest of sufficient duration to re-establish machine temperature within +2 K of the coolant temperature, see Figure 7.10.

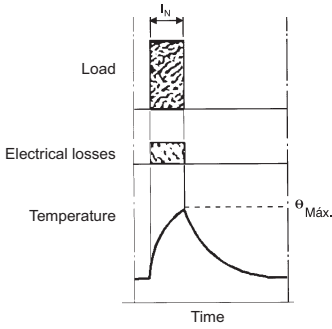

Figure 7.10

t_N = operation time at constant load
 θ_{max} = maximum temperature attained

c) Duty type S3 - Intermittent periodic duty

A sequence of identical duty cycles, each including a time of operation at constant load and a time de-energized and at rest. These periods are so short that the thermal equilibrium is not reached during one duty cycle and the starting current does not significantly affect the temperature rise (see Figure 7.11)

$$\text{Cycle duration factor} = \frac{t_N}{t_N + t_R} \cdot 100\%$$

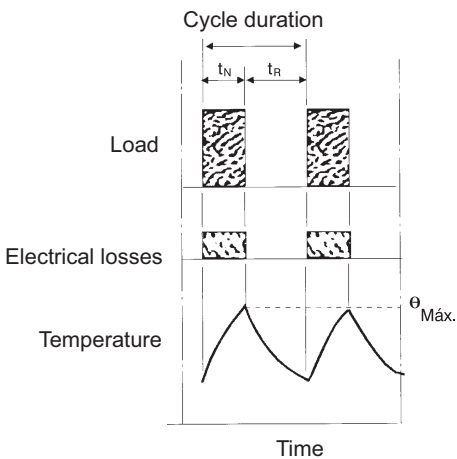

Figure 7.11

t_N = operation time at constant load
 t_R = time at rest
 θ_{max} = maximum temperature attained

d) Duty type S4 - Intermittent periodic duty with starting

A sequence of identical duty cycles, each cycle consisting of a starting, a time of operation at constant load and a time de-energized and at rest. These periods are so short that the thermal equilibrium is not reached, see Figure 7.12.

$$\text{Cycle duration factor} = \frac{t_D + t_N}{t_D + t_N + t_R} \cdot 100\%$$

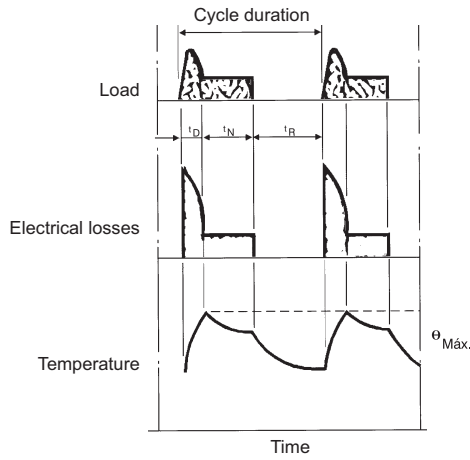

Figure 7.12

t_D = starting/accelerating time
 t_N = operation time at constant load
 t_R = time at rest
 θ_{max} = maximum temperature attained

e) Duty Type S5 - Intermittent periodic duty with electric braking

A sequence of identical duty cycles, each cycle consisting of a starting time, A time of operation at constant load, a time of electric braking and a time de-energized and at rest. These periods are so short that the thermal equilibrium is not reached, see Figure 7.13.

$$\text{Cycle duration factor} = \frac{t_D + t_N + t_F}{t_D + t_N + t_F + t_R} \cdot 100\%$$

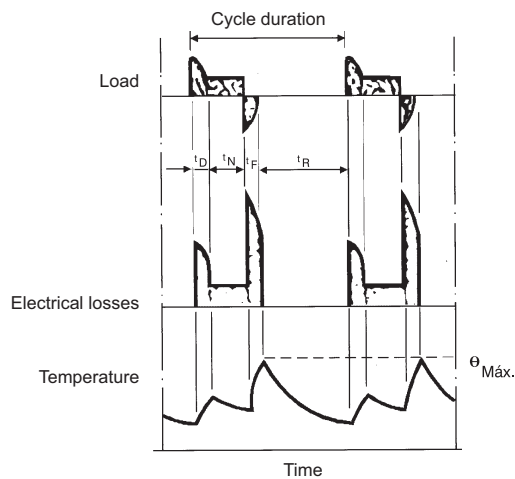

Figure 7.13

t_D = starting/accelerating time
 t_N = operation time at constant load
 t_F = time of electric braking
 t_R = time at rest
 θ_{max} = maximum temperature attained

f) Duty Type S6 - Continuous operation periodic duty

A sequence of identical duty cycles, each cycle consisting of a time of operation at constant load and a time of operation at no-load. There is no time de-energized and at rest, see Figure 7.14.

$$\text{Cycle duration factor} = \frac{t_N}{t_N + t_V} \cdot 100\%$$

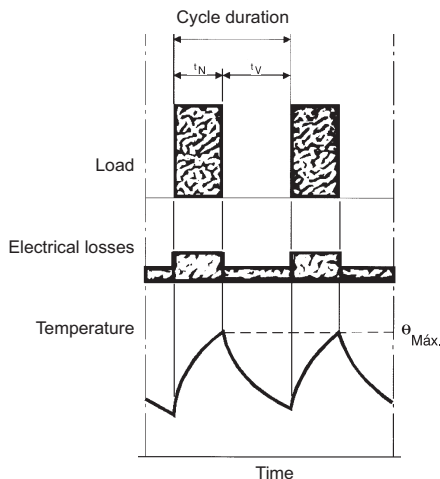

Figure 7.14

t_N = operation time at Constant load
 t_V = operation time at no-load
 $\theta_{\text{máx}}$ = maximum temperature attained

g) Duty type S7 - Continuous operation periodic duty with electric braking

A sequence of identical duty cycles, each cycle consisting of a starting time, a time of operation at constant load and a time of electric braking. There is no time de-energized and at rest, see Figure 7.15.

Cycle duration factor = 1

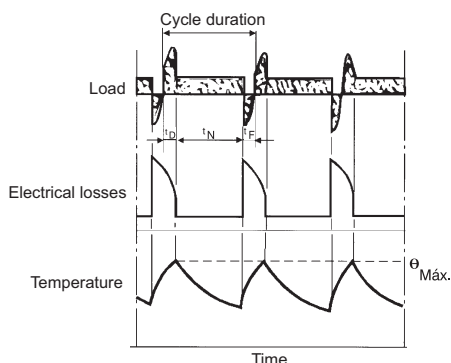

Figure 7.15

t_D = starting/acceleration time
 t_N = operation time at constant load
 t_F = time of electric braking
 $\theta_{\text{máx}}$ = maximum temperature attained

h) Duty type S8 - Continuous operation periodic duty with related load/speed changes

A sequence of identical duty cycles, each cycle consisting of a time of operation at constant load corresponding to a predetermined speed of rotation, followed by one or more times of operation at other constant loads corresponding to different speeds of rotation. There is no time de-energized and at rest (see Figure 7.16).

Cycle duration factor:

- For N1 = $\frac{t_D + t_{N1}}{t_D + t_{N1} + t_{F1} + t_{N2} + t_{F2} + t_{N3}} \cdot 100\%$
- For N2 = $\frac{t_{F1} + t_{N2}}{t_D + t_{N1} + t_{F1} + t_{N2} + t_{F2} + t_{N3}} \cdot 100\%$
- For N3 = $\frac{t_{F2} + t_{N3}}{t_D + t_{N1} + t_{F1} + t_{N2} + t_{F2} + t_{N3}} \cdot 100\%$

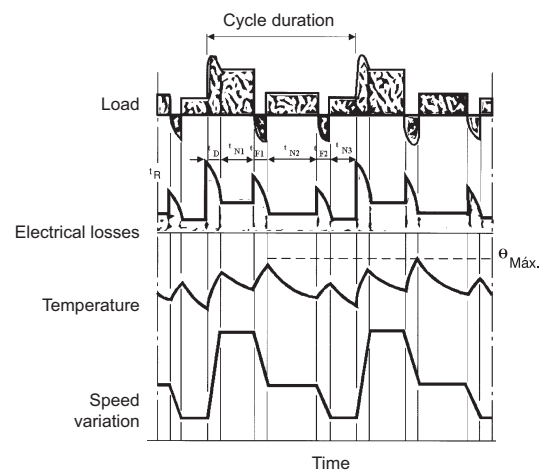

Figure 7.16

$t_{F1} - t_{F2}$ = time of electric braking
 t_D = starting/accelerating time
 $t_{N1} - t_{N2} - t_{N3}$ = operation time at constant load
 $\theta_{\text{máx}}$ = maximum temperature attained

i) Duty type S9 - Duty with non-periodic load and speed variations

A duty in which generally load and speed vary non=periodically within the permissible operating range. This duty includes frequently applied overloads that may greatly exceed the reference load (see Figure 7.17).

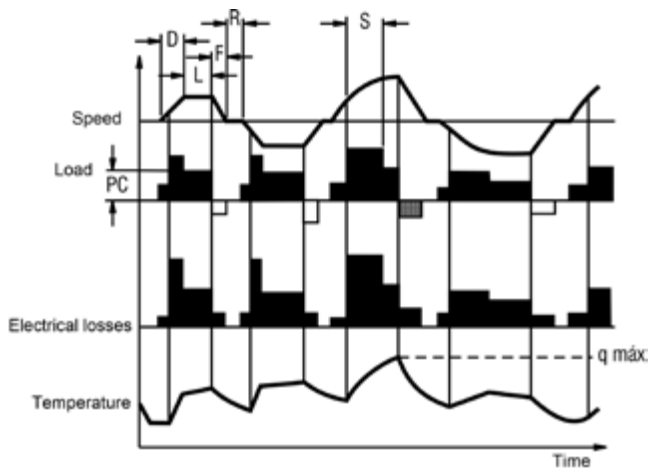

Figure 7.17

j) Duty type S10 - Duty with discrete constant loads and speeds

A duty consisting of a specific number of discrete values of loads (or equivalent loading) and if applicable, speed, each load/speed being maintained for sufficient time to allow the machine to reach thermal equilibrium, see Figures 7.18a, b and c. The minimum load within a duty cycle may have the zero value (no-load or de-energized and at rest).

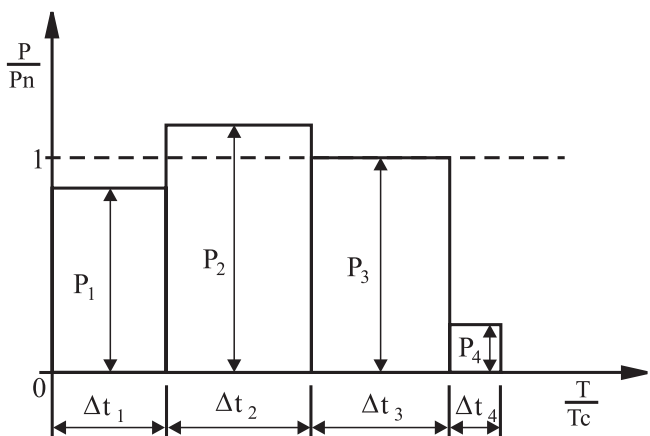

Figure 7.18a

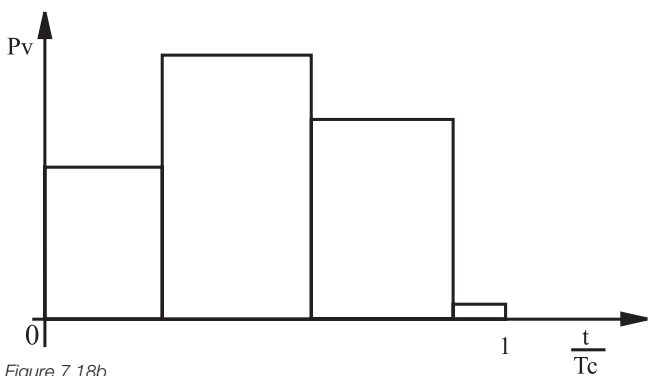

Figure 7.18b

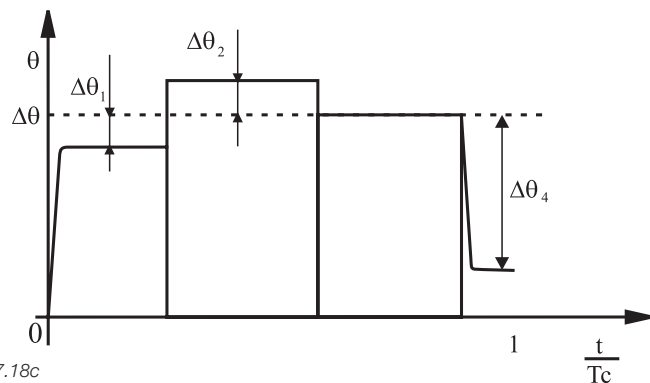

Figure 7.18c

Note: with respect to duties S3 through to S8, the time of operation is generally too short to reach the thermal equilibrium. The motor heats up partially and cools down at every cycle. Only after a large number of cycles the motor reaches the thermal equilibrium.

k) Special duties

The load can vary during operation time or when reversal or counter-current braking, etc. is activated. The proper motor selection can only be ensured after contacting the factory and providing a complete description of the cycle:

- Motor output required to drive the load. If the load varies cyclically, provide a load x time diagram (as example see Figure 7.15).
- Resistive torque of the load.
- Total moment of inertia (GD2 or J) of the driven machine with reference to its rated speed.
- Number of starts, reversals, countercurrent braking, etc.
- Operation time with load and time at rest/no-load.

7.3.2 Duty Type Designation

The duty type shall be designated by the symbol described in item 7.3. The continuous running duty can be indicated alternatively by the word “continuous”. Examples for the duty type designation:

1) S2 60 seconds

The designation of the duties S2 to S8 is given by the following indications:

- a) S2, operation time at constant load;
- b) S3 to S6, cycle duration factor;
- c) S8, each one of the rated speeds that are part of the cycle, followed by its respective rated output and its duration time.

For the duty types S4, S5, S7 and S8 other indications can be added to the designation, however these indications should be agreed previously between the manufacturer and the customer.

Note: as example of the indications to be added, previously agreed relating to the duty type designation different from the continuous running duty, following indications can be made relating to the considered duty type:

- a) Number of start per hour;
- b) Number of braking per hour;
- c) Type of braking;
- d) Constant of kinetic energy (H), rated speed of motor and load. The last one can be changed by the inertia factor (FI).

Where: constant of kinetic energy is the ratio between the kinetic energy (stored in the rotor at rated speed) and the rated apparent power. Inertia factor is the ratio between the sum of total inertia moment of load (referred to the motor shaft) and the rotor moment of inertia.

2) S3 25%; S6 40%

3) S8 motor H.1 Fl. 10 33 cv 740rpm 3min

Where: - H.1 is a Constant of kinetic energy of 1s;
- Fl.10 is na inertia factor of 10.

4) S10 para Δt = 1.1/0.4; 1.0/0.3; 0.9/0.2; r/0.1; TL = 0.6.

Where: Δt is in p.u. (per unit) for the different loads and their respective operations. The TL value is given p.u. for the expected lifetime of the thermal insulation system. During the time at rest the load must be indicated by the letter "r".

7.3.3 Rated Output

Rated output is the mechanical power available at shaft end, within its characteristics at continuous running duty. The rated output concept, i. e., the mechanical power available at shaft end, is directly related to the temperature rise of the winding. As you know, the motors can drive much higher power loads than its rated output, until it almost reaches the breakdown torque. However, if the overload exceeds motor output for which it has been designed, overheating will be generated and the motor lifetime will be reduced significantly, or may even result in motor burn out.

Consider that the required motor power is always defined by the load characteristics, for example: a load of 90 HP required from the motor, will be always 90 HP even if the motor has been designed for 75 HP or 100 HP.

7.3.4 Equivalent Power Ratings for Low Inertia Loads

It is assumed that the electric motor must supply to the driven machine the required power. It is also recommended that the motor provides some extra power for eventual overloads; depending on the duty cycle, the motor can occasionally supply more or less power. Although there are the many standardized ways to describe the running conditions of a motor, it is often necessary to evaluate the load conditions imposed on the motor by more complex duty cycles than those described in the standards. The formula below gives an usual method to calculate the equivalent power rating:

$$P_m^2 = \frac{1}{T} \sum_{t=0}^T P(t)^2 \Delta t$$

Where: P_m = equivalent power required from the motor
 $P(t)$ = power, variable with time, required from the motor
 T = total cycle time (period)

This method is based on the hypothesis that the effective load applied to the motor will provide the same thermal requirements than a fictitious equivalent load, that requires continuously the power P_m .

It is also based on the fact that load losses vary according

to the square of the load, and that the temperature rise is directly proportional to losses. This is true for motors that run continuously but drive intermittent loads.

So:

$$P_m = \sqrt{\frac{P_1^2 \cdot t_1 + P_2^2 \cdot t_2 + P_3^2 \cdot t_3 + P_4^2 \cdot t_4 + P_5^2 \cdot t_5 + P_6^2 \cdot t_6}{t_1 + t_2 + t_3 + t_4 + t_5 + t_6}}$$

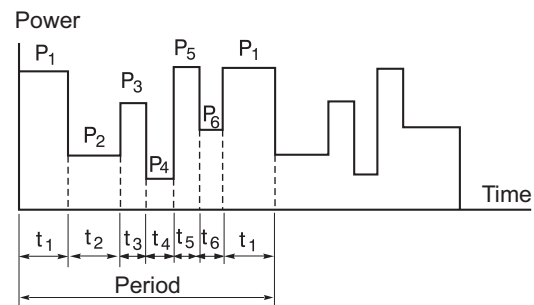

Figure 7.19 - Continuous running with intermittent loads

If the motor is at rest between the operation times, the motor cooling will be reduced. Thus, for motors where the cooling efficiency is directly related to motor operation (for example, TEFC motors), the equivalent power is calculated by the following formula:

$$(P_m)^2 = \frac{\sum (P_i^2 \cdot t_i)}{\sum (t_i + \frac{1}{3} t_r)}$$

where: t_i = load time
 t_r = time at rest
 P_i = corresponding loads

$$P_m = \sqrt{\frac{P_1^2 \cdot t_1 + P_3^2 \cdot t_3 + P_5^2 \cdot t_5 + P_6^2 \cdot t_6}{t_1 + t_3 + t_5 + t_6 + \frac{1}{3} (t_2 + t_4 + t_7)}}$$

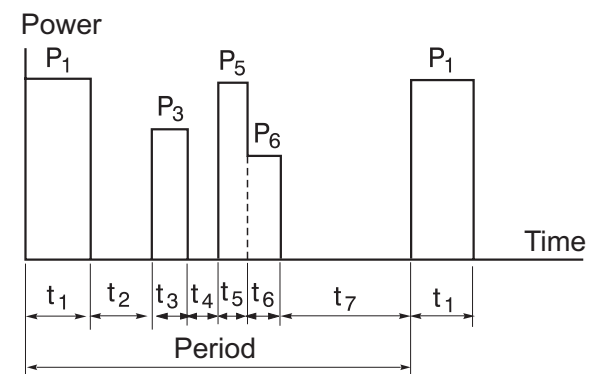

Figure 7.20 - Operation with variable load and at rest between the operations times

7.4 Service Factor (SF)

Service factor (SF) is the factor that, when applied to rated output, represents the allowable load that can be applied to motor continuously, under specified operating conditions. Note that this refers to continuous overload conditions, i.e., a power reserve that gives the motor a better capacity to withstand adverse operating conditions. Service factor should not be confused with momentary overload capacity during few minutes. A service factor = 1.0 means that the motor has not been designed for continuous operation above its rated output. However, this does not change its capacity to withstand instantaneous overloads. NBR 17094 specifies the most common Service Factors per motor output.

8. Environment Characteristics

The selection of electric motor for particular applications should consider some parameters such as:

- Altitude where motor will be installed;
- Temperature of the cooling medium.

According to ABNT NBR 17094 and IEC 60034-1, the usual service conditions are:

- a) Altitude not exceeding 1.000 masl;
- b) Cooling medium (in most case, the ambient air) with temperature not exceeding 40 °C and free from harmful substances.

Up to altitudes not exceeding 1.000 masl and ambient temperatures not exceeding 40 °C, the operating conditions are considered normal and the motor must supply its rated output without overheating.

8.1 Altitude

Motors operating at altitudes above 1000 m.a.s.l will have overheating problems caused by the rarefaction of the air which results in reduction of the cooling capacity. Poor heat exchange between the motor and cooling air will require a loss reduction which will also reduce the motor output.

The motor heating is directly proportional to losses and these vary quadratically with the motor outputs.

There are some application alternatives to be evaluated:

- a) The installation of a motor at altitudes above 1000 masl can be made by using insulating material of higher thermal class;
- b) As per IEC 60034-1, temperature rise limits must be reduced by 1% for every 100m of altitude above 1000 masl. This rule is valid for altitudes up to 4.000masl. For higher altitudes, please contact WEG.

Example:

A class B, 100 HP motor, Δt 80 K, operating at an altitude of 1500 masl, the ambient temperature of 40 °C must be reduced by 5 °C, resulting in a maximum stable temperature of 36 °C. The ambient temperature may be evidently higher provided that temperature rise is lower than the temperature class of the insulating materials.

$$T_{amb} = 40 - 80 \cdot 0.05 = 36 \text{ °C}$$

8.2 Ambient Temperature

Motors operating at temperatures below 20°C will have the following problems:

- a) Excessive condensation, requiring additional condensed water drains or installation of space heaters when motor remains out of service for long periods;
- b) Bearing frosting which causes grease or lubricant hardening requiring the use of special lubricants or antifreezing grease (please check our website).

Motors operating continuously at ambient temperatures above 40 °C, their insulation system can be damaged. A possible solution for this problem is to build the motor with special design using special insulating materials or oversizing the motor.

8.3 Determining Useful Motor Output at Different Temperature and Altitude Conditions

Combining effects of temperature and altitude variation, the dissipation capacity of motor output can be obtained multiplying the useful output by the multiplying factor of table 8.1 below:

T/H	1000	1500	2000	2500	3000	3500	4000
10	1.16	1.13	1.11	1.08	1.04	1.01	0.97
15	1.13	1.11	1.08	1.05	1.02	0.98	0.94
20	1.11	1.08	1.06	1.03	1.00	0.95	0.91
25	1.08	1.06	1.03	1.00	0.95	0.93	0.89
30	1.06	1.03	1.00	0.96	0.92	0.90	0.86
35	1.03	1.00	0.95	0.93	0.90	0.88	0.84
40	1.00	0.97	0.94	0.90	0.86	0.82	0.80
45	0.95	0.92	0.90	0.88	0.85	0.82	0.78
50	0.92	0.90	0.87	0.85	0.82	0.80	0.77
55	0.88	0.85	0.83	0.81	0.78	0.76	0.73
60	0.83	0.82	0.80	0.77	0.75	0.73	0.70

Table 8.1 Multiplying factor for the usefull output as function of the ambient temperature (T) at "°C" and altitude (H) in "m"

Example:

A Class F Insulation motor, 100 HP, operating at an altitude of 2.000 masl and ambient temperature of 55 °C.

Based in table 8.1 - α = 0.83 thus P" = 0.83 , Pn
The motor can only supply 83% of its rated output.

8.4 Environment

8.4.1 Aggressive Environments

Aggressive environment such as shipyards, port facilities, fish industries, marine applications, chemical and petrochemical industries require that all equipment operating at such environments are suitable and reliable to withstand such harsh conditions without presenting any problem.

For the application of electric motors in these aggressive environments, WEG has a specific line for each motor type duly designed to meet specific and standardized requirements for the most adverse operating conditions. These motors can be delivered with the following special characteristics:

- Double impregnated winding
- Anticorrosive alkyd paint (inside and outside)
- Galvanized mounting bolts
- Oil seal between shaft and endshield (may be lip seal, W3Seal, etc.)
- Additional protection by sealing joints.

For environments with temperature range between -16 °C and 40 °C and relative air humidity $\leq 95\%$, anticorrosive coating for internal surfaces is recommended. For environments with temperatures between 40 °C and 65 °C also anticorrosive coating for internal surfaces is recommended, however, a derating factor to 40 °C should be considered.

Note: for environments with relative air humidity $\geq 95\%$, anticorrosive coating for internal surfaces with connection of space heater is recommended.

For marine motors, the specific operating characteristics are defined by the type of driven load on board. However, all motors offer the following special features:

- Reduced temperature rise for operation in ambient up to 50 °C
- Capacity to withstand without any problem, sudden overload conditions of short duration up to 60% above the rated torque, as specified in standards of Certification Bodies.

WEG rigid control during production process ensures reliable operation to the marine motors. They meet the construction and inspection requirements as well as the tests specified in the standards of the Certification Bodies, such as:

- AMERICAN BUREAU OF SHIPPING
- BUREAU VERITAS
- CHINA CERTIFICATION SOCIETY
- DET NORSKE VERITAS
- GERMANISCHER LLOYD
- LLOYD'S REGISTER OS SHIPPING
- RINA S.p.A.

8.4.2 Environments Containing Dusts and Fibers

To analyze whether motors are suitable to operate in these environments, the following information should be available: approximate size and amount of fibers present in the environment. This information is since along the time, the fibers can obstruct the ventilation system resulting in motor overheating. If fiber content is excessive, air filters should be applied or the motor must be cleaned frequently.

Prevent motor cooling impairment

For this case there are two solutions:

- 1) Use motors without ventilation system;
- 2) For motor with cooling by ducts, calculate the volume of air to be displaced by the motor fan, by establishing the airflow required for perfect the motor cooling.

8.4.3. Explosive Atmospheres

Explosion-proof, non-sparking, increased safety and dust-proof motors are intended for use in explosive atmospheres containing combustible gases, vapors, or explosive dusts or fibers. Chapter 9 (explosive atmospheres) deals specifically with this subject.

8.5 Degree of Protection

Enclosures of electrical equipment, according to characteristics where they will be installed and their maintenance accessibility, should offer a certain degree of protection. Thus, for example, an equipment to be installed in a location subjected to water jets must have housing capable of withstanding the water jets under determined pressure and angle of incidence, without water penetration.

8.5.1 Identification Codes

Standard IEC 60034-5 defines the degrees of protection of electrical equipment by means of the characteristic letters IP, followed by two characteristic numerals.

First characteristic numeral	
1 st charact. numeral	Definition
0	No-protected machine
1	Machine protected against solid objects greater than 50 mm
2	Machine protected against solid objects greater than 12 mm
3	Machine protected against solid objects greater than 2,5 mm
4	Machine protected against solid objects greater than 1,0 mm
5	Dust-protected machine
6	Dust-tight machine

Table 8.2 - First characteristic numeral indicates the degree of protection against the ingress of solid objects and accidental or inadvertent contact.

Second characteristic numeral	
2 nd charact. numeral	Definition
0	No-protected machine
1	Machine protected against dripping water
2	Machine protected against dripping water when tilted up to 15°
3	Water falling as a spray at any angle up to 60° from the vertical
4	Water splashing against the machine from any direction
5	Water protected by nozzle against the enclosure from any direction
6	Water from heavy seas or water projected in powerful jets
7	Machine protected against the effects of immersion
8	Machine protected against the effects of continuous submersion

Table 8.3 - Second characteristic numeral indicates the degree of protection against the ingress of water in the machine

The combination of the two characteristic numerals, i. e., between The two degrees of protection, is shown in Table 8.4. According to standards the qualification of a motor is clearly defined for each for each degree of protection by standardized testes which do not leave any scope of misinterpretation.

Motor	Degree of Protection	First characteristic numeral		Second char. numeral
		Protected against Accidental contact	Protected against solid object	Protected against water
Open motors	IP00	Non-protected	Non-protected	Non-protected
	IP02	Non-protected	Non-protected	Protection against dripping water even when tilted 15° vertically
	IP11	Protection against accidental contact with the hand	Ingress of solid objects exceeding 50 mm in diameter	Protection against dripping water falling vertically
	IP12	Protection against accidental contact with the hand	Ingress of solid objects exceeding 50 mm in diameter	Protection against dripping water even when tilted 15°
	IP13	Protection against accidental contact with the hand	Ingress of solid objects exceeding 50 mm in diameter	Protection against dripping water even when tilted 60°
	IP21	Protection against the touching with the finger	Ingress of solid objects exceeding 12 mm in diameter	Protection against dripping water falling vertically
	IP22	Protection against the touching with the finger	Ingress of solid objects exceeding 12 mm in diameter	Protection against dripping water even when tilted 15°
	IP23	Protection against the touching with the finger	Ingress of solid objects exceeding 12 mm in diameter	Protection against dripping water even when tilted 60°
Closed motors	IP44	Protection against the touching with tools	Ingress of solid objects exceeding 1 mm in diameter	Protection against splashing water from any direction
	IP54	Protection against contacts	Protection against accumulation of harmful dust	Protection against splashing water from any direction
	IP55	Protection against touches	Protection against accumulation of harmful dust	Protection against water jets from any direction

Table 8.4 - Degree of Protection

8.5.2 Usual Degrees of Protection

Although some characteristic numerals to indicate the degree of protection can be combined in different ways, only a few degrees of protection are usually employed. They are: IP21, IP22, IP23, IP44 and IP55.

The first three numerals apply to open motors and the other two refer to enclosed motors. For special and more dangerous areas there are other commonly used degrees of protection such as IPW 55 (weather protection) IP56 (protections against water jets), IP65 (totally protected against dust) and IP66 (totally protected against dust and water jets).

Bearing sealing

Frame sizes 225S/M to 355A/B can be supplied with sealing system WSeal®, as serial item This sealing system consists of a V'Ring ring with double lips and metal cap mounted on this ring.

Among the other available sealing systems for the line W22, is the revolutionary sealing system W3 Seal®, formed by three seals: V'Ring, O'Ring and Taconite Labyrinth. This sealing system has been developed by WEG to protect the motor against accumulation of solid and liquid impurities present in environment, which provides to the motor the protection degree IP66.

Other degrees of protection for motors are not so common. Any of the above mentioned degree of protection fully meets the lower requirements of the lower (smaller figures). Thus, for example, an motor with degree of protection IP55 replaces with advantages the motors with degree of protection IP12, IP22 or IP23, ensuring higher protection against accidental exposure to dust and water. This allows the production standardization with a single type of motor that meets all the cases, with an additional advantage for user in the case of less demanding environments.

8.5.3 Weather Protected Motors

According to IEC 60034-5, the motor will be weather protected when due to its design (technical discussion between customer and WEG), the defined protections provide a correct operation of the motor against rain, dust and snow.

WEG also uses the letter W to indicate the degree of protection of the motor to indicate that the motor has a special paint plan (weather protected). The painting plans may vary according to the environmental severity, which should be informed by the customer during motor specification/order.

Aggressive environments require that equipment be perfectly suitable to support such conditions ensuring high reliability in service without showing any problems.

WEG manufacturers a wide range of electric motors with special characteristics, suitable for use in shipyards, ports, fishing plants and several naval applications, as well as in chemical and petrochemical industries and other aggressive environments. So WEG motors are suitable to operate under the most severe operational conditions.

8.6 Space Heater

The space heater are installed inside the motor when it operates in high-humidity environments, (humidity > 95%) and / or when it remains out of operation for long periods (longer than 24 h), thus preventing water accumulation water inside the motor by the condensation of humid air.

The space heater heats up the motor inside few degrees above the ambient temperature (5-10 °C), when the motor is switched off. The supply voltage of the space heaters must be specified by customer. The space heaters can be supplied for following supply voltage: 110 V, 220 V and 440 V.

Depending on the frame size, following space heaters will be installed. See Table 8.5:

Frame size	Quantity	Power (W)
63 to 80	1	7.5
90 to 100	1	11
112	2	11
132 to 160	2	15
180 to 200	2	19
225 to 250	2	28
280 to 315	2	70
355 to 315B	2	87

Table 8.5 - Space heaters

WARNING: the space heaters should only be powered on when motor is off, otherwise the motor may overheat, resulting in potential damages. Disconnect input power to the motor before performing any maintenance. Also space heaters must be disconnected from input power.

8.7 Noise Levels

WEG Motors comply with NEMA and IEC standards which specify the maximum sound pressure levels in decibels. The values of Table 8.6 comply with IEC 600034-9 standard.

Frame size	2 poles		4 poles		6 poles		8 poles	
	Sound power level	Sound pressure level	Sound power level	Sound pressure level	Sound power level	Sound pressure level	Sound power level	Sound pressure level
90	83	71	69	57	66	54	66	54
100	87	75	73	61	67	55	67	55
112	88	76	75	63	73	61	73	61
132	90	78	78	66	76	64	74	62
160	92	79	80	67	76	63	75	62
180	93	80	83	70	80	67	79	66
200	95	82	86	73	83	70	82	69
225	97	84	87	74	83	70	82	69
250	97	83	88	74	85	71	83	69
280	99	85	91	77	88	74	85	71
315	103	88	97	82	92	77	91	76
355	105	90	98	83	97	82	95	80

Table 8.6 - Maximum sound power and sound pressure levels for three-phase motors (IC411,IC511,IC611), at no-load, in dB(A), 60 Hz.

Note 1: motors with cooling method IC01,IC11,IC21 may present higher sound Power levels: 2 and 4 poles +7dB(A), - 6 and 8 poles +4dB(A).

Note 2: the sound Power levels for 2 and 4 poles, frame size 355 are valid for unidirectional fans. The other sound Power levels are valid for bidirectional fans.

Note 3: the values for 50 Hz motors should be decreased by : 2 poles -5dB(A) ; 4, 6 and 8 poles -3dB(A).

Table 8.7 shows the increments to be considered for the sound power and sound pressure levels, in dB (A), for motors operating at load conditions.

Frame size	2 poles	4 poles	6 poles	8 poles
90 to 160	2	5	7	8
180 to 200	2	4	6	7
225 to 280	2	3	6	7
315	2	3	5	6
355	2	2	4	5

Table 8.7 - Maximum estimated increment for the sound power and sound pressure levels, in dB (A)

Note 1: this table provides the maximum expected increment at rated load conditions.

Note 2: the values are valid for 50 Hz and 60 Hz.



9. Explosive Atmosphere

9.1 Hazardous Area

An installation where inflammable products are continually handled, processed or stored requires special care to ensure the maintenance of property and the personnel safety.

Based on their characteristics, electric equipment can become ignition sources causing sparks, when opening or closing contacts or due to overheating of any component, caused intentionally or originated by fault currents.

9.2 Explosive Atmosphere

An atmosphere is considered explosive when the proportion of gas, vapor, dust, fibres, or flyings is such that after sparking caused by short-circuit or overheating of one component causes an ignition and explosion. Three elements are required for an explosion to occur:

$$\text{Fuel} + \text{oxygen} + \text{ignition} = \text{explosion}$$

9.3 Classification of Hazardous Areas

According to IEC Standards, hazardous areas are classified as follows:

Zone 0:

Area in which and explosive atmosphere is present continuously, or for long periods of frequently. For example, inside a fuel tank the explosive atmosphere is always present.

Zone 1:

Area in which an explosive gas atmosphere is likely to occur in normal operation occasionally. The explosive atmosphere is frequently present.

Zone 2:

Area in which an explosive gas atmosphere is not likely to occur in normal operation, but if it does occur, will persist for a short period only. This conditions associated with abnormal operation of equipment and process, losses or negligent use. The explosive atmosphere may accidentally be present.

According to NEC/API 500 Standards, the hazardous areas are classified as follows:

- Division 1 - Area where there is HIGH probability of occurring an explosion.
- Division 2 - Area where there is lower explosion probability.

Standards	Occurrence of flammable mixtures		
	Continuously present	Under normal conditions	Under abnormal conditions
IEC	Zone 0	Zone 1	Zone 2
NEC/API	Division 1		Division 2

Table 9.1 - Comparison between ABNT/IEC and NEC/API

The process of dust storage in confined spaces offers potentially explosive atmospheres. This occurs when dust is mixed with air in the form of a dust cloud or when the dust is deposited on the electrical equipment. Areas where dust, flyings and fibres in air occur in dangerous quantities are classified, according to IEC 61241-10, as hazardous and are divided into three zones according to the level of risk.

Zone 20:

Area in which an explosive atmosphere in the form of a cloud of combustible dust in air is present continuously, or for long periods or frequently.

Zone 21:

Area in which an explosive atmosphere in the form of a cloud of combustible dust in air is likely to occur, occasionally, in normal operation.

Zone 22:

Area in which an explosive atmosphere in the form of a cloud of combustible dust in air is not likely to occur in normal operation but, if it does occur, will persist for a short period only.

Among the products where their powders or dusts create potentially explosive environments inside confined ambient are the coal, wheat, cellulose, fibers and plastics in finely divided particles, etc.

9.3.1. Classes and Groups of the Hazardous Areas

Classes - refer to the nature of the mixture. The concept of classes is only adopted by the NEC standard.

Groups - The definition of groups is associated with the composition of the mixture.

Class I

Explosive gases or steams. Based on the type of gas or steam, we will have following classification:

- GROUP A - acetylene
- GROUP B - hydrogen, butadiene, ethane oxide
- GROUP C - ethyl ether, ethylene
- GROUP D - gasoline, naphtha, solvents in general.

Class II

Combustible of conductive dust. Based on the type dust, we will have following classification:

- GROUP E
- GROUP F
- GROUP G

Class III

Light and flammable fibers and particles.

According to IEC 60079-0, Hazardous areas are divided into three separate classifications:

- Group I - For mines containing methane gas.
- Group II - For application in other areas with gass explosive atmospheres. These areas are divided in IIA, IIB and IIC.
- Group III - For application in explosive dust atmospheres. These group is divided in:
 - III A - Combustible fibres
 - III B - Non-conductive dust
 - III C - Conductive dust

Gases Standards	Group of Acetylene	Group of Hydrogen	Group of ethane	Group of propane
IEC	II C	II C	II B	II A
NEC/API	Class I Gr A	Class I Gr B	Class I Gr C	Class I Gr D

Table 9.2 - Comparison between IEC and NEC/API for gases

Explosive atmosphere	ABNT / IEC	NEC
Gases or steams	Zone 0 and Zone 1	Class I Division 1
	Zone 2	Class I Division 2
Combustible dusts	Zone 20 and Zone 21	Class II Division 1
	Zone 22	Class II Division 2

Table 9.4 - Classification per area according to IEC and NEC

Dust and fibres Standards	High conductive dust	Light conductive dust	Non-conductive dust	Combustible fibers
NBR IEC	III C	III C	III B	III A
NEC/API	Class II Gr E	Class II Gr F	Class II Gr G	Class III

Table 9.3 - Comparison between Standards IEC and NEC/API for combustible dust and fibers

9.3.2 Protection by Enclosure







Symbol	Description	Representação simplificada
"d"	Explosion-proof Type of protection in which the parts capable of igniting an explosive gas atmosphere are provided with an enclosure which can withstand the pressure developed during an internal explosion of an explosive mixture, and which prevents the transmission of the explosion to the explosive gas atmosphere surrounding the enclosure.	
"e"	Increased safety Type of protection applied to electrical apparatus in which additional measures are applied so as to give increased security against the possibility of excessive temperatures and of the occurrence of arcs and sparks in normal service or under specified abnormal conditions	
"i"	Intrinsic safety "ia", "ib", "ic" Type of protection, in which any spark or any thermal effect produced in the conditions specified in the standard, including normal operation and specified fault conditions, are not capable of causing ignition of a given explosive gas atmosphere.	
"m"	Encapsulation "ma", "mb", "mc" Type of protection whereby parts that are capable of igniting an explosive atmosphere by either sparking or heating are enclosed in a compound in such a way that the explosive atmosphere cannot be ignited under operating or installation condition.	
"n"	Tipo de proteção "n" "nA", "nC", "nR" Type of protection applied to electrical apparatus such that, in normal operation and in certain specified abnormal conditions, it is not capable of igniting a surrounding explosive gas atmosphere. There are three categories of materials: no spark generation (nA), spark generation (nC), encapsulated with limited breathing (nR).	
"o"	Oil immersion Type of protection in which the electrical apparatus or parts of the electrical apparatus are immersed in a protective liquid in such a way that an explosive gas atmosphere which may be above the liquid or outside the enclosure cannot be ignited.	
"p"	Pressurization "px", "py", "pz", Type of protection for guarding against the ingress of the external atmosphere into an enclosure or room by maintaining a protective gas therein at a pressure above that of the external atmosphere.	
"q"	Sand filling Type of protection in which the parts capable of igniting an explosive gas atmosphere are fixed in position and completely surrounded by filling material to prevent the ignition of an external explosive atmosphere.	
"t"	Protection by enclosure Type of protection where parts that can cause ignition of an explosive atmosphere are protected by an enclosure providing partially or totally protection against dust ingress and a means to limit surface temperature	

Table 9.5 - Type of protection by enclosure

9.4 Temperature Classes

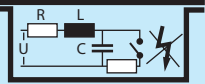
The maximum temperature on the outer and/or inner surface of an electric equipment must always be lower than the ignition temperature of the gas or steam. Gases can be classified for temperature classes based on their ignition temperature, where the maximum surface temperature of the corresponding class must be lower than the corresponding temperature of the gases.

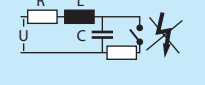
IEC		NEC		Ignition temperature of gases and/or steams
Temperature classes	Maximum surface temperature	Temperature classes	Maximum surface temperature	
T1	450	T1	450	> 450
T2	300	T2	300	> 300
		T2A	280	> 280
		T2B	260	> 260
		T2C	230	> 230
		T2D	215	> 215
T3	200	T3	200	> 200
		T3A	180	> 180
		T3B	165	> 165
		T3C	160	> 160
T4	135	T4	135	> 135
		T4A	120	> 120
T5	100	T5	100	> 100
T6	85	T6	85	> 85

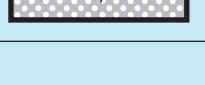
Table 9.6 - Temperature classes

9.5 Equipment for Explosive Atmospheres

The tables below show the selection of equipment for hazardous areas classified according to IEC 60079-14:

ABNT NBR IEC 60079-14	
Zone	Possible types of protection
Zone 0	Ex "iA"
	Ex "mA"
	Equipment specially approved for Zone 0
Zone 1	Equipment certified for Zone 0
	Ex "d"
	Ex "de"
	Ex "e"
	Ex "px". Ex "py"
	Ex "iB"
	Ex "q"
	Ex "o"
Ex "mB"	
Zone 2	Equipment certified for Zone 0 and Zone 1
	Ex "pZ"
	Ex "iC"
	Ex "n"
	Ex "mC"

Table 9.7 - Types of protection for explosive atmospheres with inflammable gases.

Table below shows the list of equipment according to standard NEC:

DIVISION 1	Equipment with type of protection: <ul style="list-style-type: none"> ■ explosion-proof Ex"d" ■ presurization Ex"p" ■ oil immersion Ex"o" ■ intrinsic safety Ex"i"
DIVISION 2	<ul style="list-style-type: none"> ■ any equipment certified for Division 1 ■ equipment that do not generate sparks of hot surfaces on general purpose enclosures

Table 9.8

9.6 Increased Safety Equipment

his electrical equipment, under normal operating conditions, does not generate arcs, sparks or sufficient heat to cause ignition of the explosive atmosphere for which it was designed.

Time t_E - time taken for an a.c. rotor or stator winding, when carrying the initial starting current I_A , to be heated up to the limiting temperature from the temperature reached in rated service at the maximum ambient temperature. Figures below show how to proceed for correct time " t_E " determination. (Figures 9.1 and 9.2).

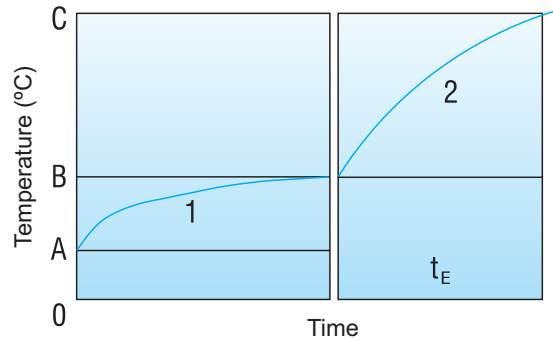

Figure 9.1 - Schematic diagram explaining the method for the time " t_E " determination

- A - maximum ambient temperature
- B - temperature at rated service condition
- C - limit temperature
- 1 - service temperature rise
- 2 - locked rotor temperature rise

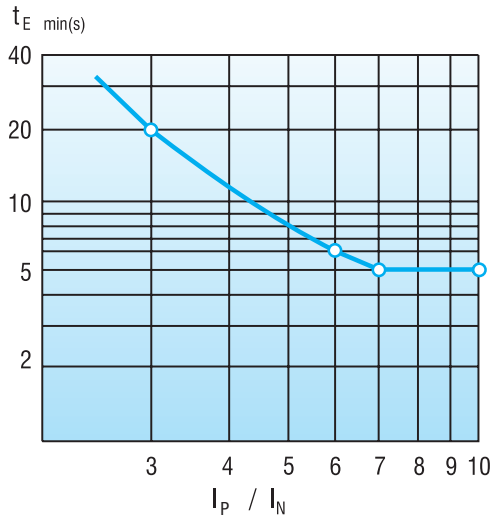

Figure 9.2 - Minimum time " t_E " as function of the starting current ratio I_P / I_N

9.7 Explosion-Proof Equipment

It is a type of protection where the parts that may ignite an explosive atmosphere are confined within enclosures that can withstand the pressure caused by an internal explosion of an explosive atmosphere and prevents the transmission of the explosion to an explosive atmosphere.

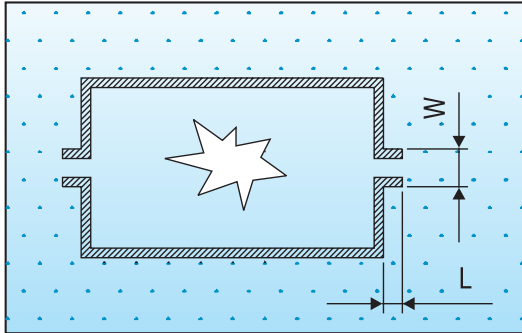

Figure 9.3 - Protection principle

The induction motor (with any type protection) is not tight protected, i. e., there is air exchange with the nvironment. During operation, the motor heats up and the inside air will have higher pressure than the outside (air is then blown out); when the power supply is turned off, motor cools down and, as a consequence, the inside pressure decreases allowing penetration of air (which is contaminated). The Ex-d enclosure will not allow any eventual internal explosion to propagate to the external environment. For the system safety, WEG controls all air gaps - flame paths (tolerances between joints) and the finishing joint since they are responsible for the volume of gases exchanged between the inside and outside of the motor.

10. Mounting Arrangements

10.1 Dimensions

Dimensions of WEG electric motors are standardized according to the standard *International Electrotechnical Commission - IEC-60072*. In these standards the basic dimension for the standardization of the assembly dimensions of electric machines is the height from the base to the shaft end center, designated by the letter H (se Figure 10.1 below).

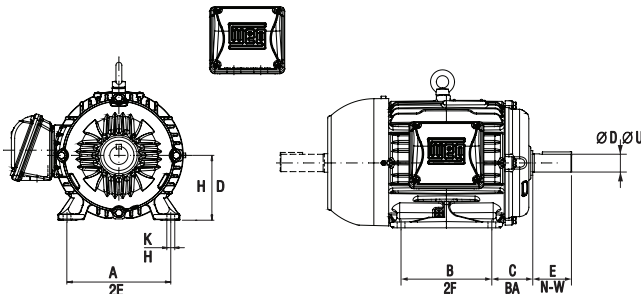

Figure 10.1

To each height of shaft end H, a C dimension is associated, distance from the centerline of mounting hole in the nearest foot to the shoulder on drive end shaft. However, to each H dimension, several B dimension can be associated (distance between centerlines of mounting holes in feet), allowing to have either “longer” or “shorter” motors.

The A dimension, distance between centerlines of mounting holes in the feet or base of machine, on the front side, is unique for H values up to 315, however it can have multiple values from frame size H equal to 35 mm. For those customers who require standardized frames size according to NEMA standard, table 10.1 makes a comparison between dimensions H-A-B-C-K-D- E of IEC standard and D; 2E; 2F; BA; H; U-N-W of NEMA standard.

ABNT / IEC NEMA	H D	A 2E	B 2F	C BA	K H	Ø D Ø U	E N-W
63	63	100	80	40	7	11j6	23
71	72	112	90	45	7	14j6	30
80	80	125	100	50	10	19j6	40
90 S	90	140	100	56	10	24j6	50
143 T	88.9	139.7	101.6	57.15	8.7	22.2	57.15
90 L	90	140	125	56	10	24j6	50
145 T	88.9	139.7	127	57.15	8.7	22.2	57.15
100L	100	160	140	63	12	28j6	60
112 S	112	190	140	70	12	28j6	60
182 T	114.3	190.5	139.7	70	10.3	28.6	69.9
112 M	112	190	140	70	12	28j6	60
184 T	114.3	190.5	139.7	70	10.3	28.6	69.9
132 S	132	216	140	89	12	38k6	80
213 T	133.4	216	139.7	89	10.3	34.9	85.7
132 M	132	216	178	89	12	38k6	80
215 T	133.4	216	177.8	89	10.3	34.9	85.7
160 M	160	254	210	108	15	42k6	110
254 T	158.8	254	209.6	108	13.5	41.3	101.6
160 L	160	254	254	108	15	42k6	110
256 T	158.8	254	254	108	13.5	41.3	101.6
180 M	180	279	241	121	15	48k6	110
284 T	180	279.4	241.3	121	13.5	47.6	117.5
180 L	180	279	279	121	15	48k6	110
286 T	177.8	279.4	279.4	121	13.5	47.6	117.5
200 M	200	318	267	133	19	55m6	110
324 T	203.2	317.5	266.7	133	16.7	54	133.4
200 L	200	318	305	133	19	55m6	110
326 T	203.2	317.5	304.8	133	16.7	54	133.4
225 S	225	356	286	149	19	60m6	140
364 T	228.6	355.6	285.8	149	19.0	60.3	149.2
250 S	250	406	311	168	24	65m6	140
404 T	254	406.4	311.2	168	20.6	73	184.2
250 M	250	406	349	168	24	65m6	140
405 T	254	406.4	349.2	168	20.6	73	184.2
280 S	280	457	368	190	24	65m6	140
444 T	279.4	457.2	368.4	190	20.6	73	184.2
280 M	280	457	419	190	24	75m6	140
445 T	279.4	457.2	419.1	190	20.6	85.7	215.9
315 S	315	508	406	216	28	80m6	170
504 Z	317.5	508	406.4	215.9	31.8	92.1	269.9
315 M	315	508	457	216	28	80m6	170
505 Z	317.5	508	457.2	215.9	31.8	92.1	269.9
355 M	355	610	560	254	28	100m6	210
586	368.3	584.2	558.8	254	30	98.4	295.3
355 L	355	610	630	254	28	100m6	210
355 L	355	610	630	254	28	100m6	210
587	368.3	584.2	635	254	30	98.4	295.3

Table 10.1 - Dimension comparison between IEC and e NEMA



10.2 Standardized Type of Construction and Mounting Arrangement

The types of construction and mounting arrangements designate the arrangement of the machine components with regard to fixings, bearing arrangement and shaft extension, as standardized in IEC 60034-7, DIN-42955 and NEMA MG 1-4.03. Standard IEC 60072 determines the location of the terminal box on the motor that shall be situated with its centre-line within a sector ranging from the top to 10° below the horizontal centre-line of the motor on the right-hand side, when looking at the D-end of the motor.

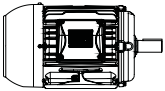
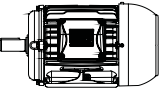
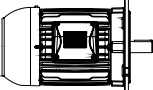

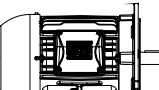
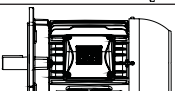

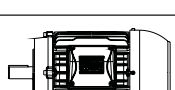
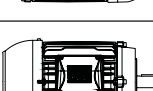
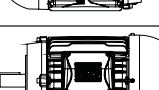

Figure	Symbol for					Mounting conFiguretion
	WEG Designation	DIN 42950	IEC 60034 Part 7		Frame	
			Code I	Code II		
	B3D	B3	IM B3	IM 1001	with feet	mounted on substructure (*)
	B3E					
	B5D	B5	IM B5	IM 3001	footless	fixed by "FF" flange
	B5E					
	B35D	B3/B5	IM B35	IM 2001	with feet	mounted on substructure by feet, with additional fixation by "FF" flange
	B35E					
	B14D	B14	IM B14	IM 3601	footless	fixed by "C" flange
	B14E					
	B34D	B3/B14	IM B34	IM 2101	with feet	mounted on substructure by feet, with additional fixation by "C" flange
	B34E					
	B6D	B6	IM B6	IM 1051	with feet	wall mounted, feet on the right side, looking at the D-en of the motor
	B6E					

Table 10.2a - Standardized mounting arrangements (horizontal mounting)

(*) Substructure: bases, base plate, foundation, rails, pedestals, etc.



Figure	Symbol for					Mounting conFiguretion
	WEG Designation	DIN 42950	IEC 60034 Part 7		Frame	
			Code I	Code II		
	B7D	B7	B7	IM 1061	with feet	wall mounted, feet on the right side, looking at the D-en of the motor
	B7E					
	B8D	B8	IM B8	IM 1071	footless	fixed to ceiling
	B8E					

Table 10.2b - Standardized mounting arrangements (horizontal mounting)







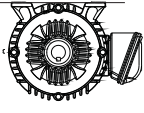
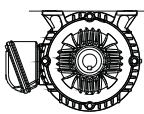

Figure	Symbol for					Mounting conFiguretion
	WEG Designation	DIN 42950	IEC 60034 Part 7		Frame	
			Code I	Code II		
 (*)	V5	V5	IM V5	IM 1011	with feet	wall mounted or mounted n substructure
	V6	V6	IM V6	IM 1031	with feet	wall mounted or mounted n substructure
 (*)	V1	V1	IM V1	IM 3011	footless	fixed by "FF" flange, shaft end down
	V3	V3	IM V3	IM 3031	footless	fixed by "FF" flange shaft end up
 (*)	V15	V1/V5	IM V15	IM 2011	with feet	wall mounted, with additional fixation by "FF" flange shaft end down
	V36	V3/V6	IM V36	IM 2031	with feet	wall mounted, with additional fixation by "FF" flange shaft end up
 (*)	V18	V18	IM V18	IM 3611	footless	fixed by the "C" flange - shaft end down
	V19	V19	IM V19	IM 3631	footless	fixed by the "C" flange - shaft end up

Table 10.3 - Standardized mounting arrangements (vertical mounting)

Note: "We recommend to use drip cover for vertical mounted motors with shaft end down and non-weather protected".

We recommend to use drip cover and slinger at the shaft end (coupling side for vertical mounted motors with shaft end with shaft end up).

10.3 Painting

The painting plan below shows the adopted solutions for each application.

Plan	Recommended use
201 A	Regular environment, not too severe, sheltered or not, for industrial purpose with low relative humidity, normal temperature variations and SO ₂ presence. <i>Note: not recommended for direct exposure to acid vapors, alkalis and solvents.</i>
202 E	Severe industrial environment, sheltered or not. SO ₂ , vapors and solid contaminants and high humidity may be present. This painting plan is indicated for pulp and paper, mining and chemical industries. <i>*This painting plan is not recommended for coating of aluminum surface.</i>
202 P	Severe industrial environments, sheltered or not. SO ₂ , vapors and solid contaminants and high humidity may be present. Specific use recommendations: Indicated for application on food processing motors - USA. <i>* This painting plan is not recommended for coating of aluminum surface.</i>
203 A	Regular environment, not too severe, sheltered or not, for industrial purpose, with low relative humidity, normal temperature variations and SO ₂ presence. <i>Notes: 1- Not recommended for direct exposure to acid vapors, alkalis and solvents. 2- Do not apply this painting Plan on motors with steel plate frames.</i>
205 E	Severe industrial environment, sheltered or not. SO ₂ , vapors and solid contaminants and high humidity may be present. This painting plan is indicated for pulp and paper, mining and chemical industries.
205 P	Severe industrial environments, sheltered or not. SO ₂ , vapors and solid contaminants and high humidity may be present . Specific use recommendations: Indicated for application on food processing motors - USA.
207 A	Regular environments, not too severe and sheltered, for industrial purpose, with low relative humidity, and normal temperature variations and SO ₂ presence. <i>Note: not recommended for direct exposure to acid vapors, alkalis and solvents.</i> Application: The Painting Plan 207 A is indicated for the motors of normal manufacturing line which require quick drying painting for the packaging process.
207 N	Regular environments, not too severe and sheltered, for domestic purpose, with low relative humidity, and normal temperature variations. <i>Note: not recommended for direct exposure to acid vapors, alkalis and solvents.</i> Specific use recommendation: For application on motors with steel plate frames, which packaging process demands quick drying painting.
211 E	Severe industrial environment, sheltered, may have presence of SO ₂ , vapors and solid contaminants, high humidity and alkalis and solvent spills. It is indicated for motors destined to Petrobrás and its suppliers, for refineries purpose, as well as petrochemical industries that adopt the Petrobrás specifications.
211 P	Severe industrial environment sheltered or not, may have presence of SO ₂ , vapors and solid contaminants and high humidity and alkalis and solvent spills. It is indicated for motors destined to Petrobras and its suppliers, for refineries purpose, as well as petrochemical industries that adopt the Petrobras specifications.
212 E	Aggressive marine or naval industry environments, sheltered, may have high humidity and alkalis and solvents spills. It is indicated for applications in pulp and paper, mining and petrochemical industries.
212 P	Aggressive marine or naval industry environments, sheltered, may have high humidity and alkalis and solvents spills. It is indicated for applications in pulp and paper, mining and petrochemical industries.
213 E	Aggressive marine or naval industry environments, sheltered or not, may have high humidity. It is indicated for oil exploration & production on platforms.
214 P	Severe industrial environments, sheltered or not. SO ₂ , vapors and solid contaminants and high humidity and alkalis and solvents spills may be present.

Table 10.4 - Painting Plan

Note: WEG Painting Plans meet the Petrobras standards

10.3.1 Tropicalized Painting

High humidity indexes can result in premature insulation system deterioration which is the main component that ensures the motor life time. Any ambient with up to 95% of relative humidity does not require additional protection, other than space heaters to avoid water condensation inside the motor. However, for any ambient with relative humidity above 95%, an epoxy painting is applied on all inside motor components which is known as tropic-proof painting.

11. Three-Phase Electric Motor Selection and Application

On application engineering of electric motors it is common to compare load requirements with motor characteristics. A lot of applications can be correctly driven by more than one type of motor.

This means that selection of a specific type of motor does not necessarily exclude other types.

Application of computers has improved significantly motor calculation resulting in more accurate results along with more economical designs of machines.

WEG induction motors, squirrel cage or slip rings, low or high voltage, can be used on a wide range of applications, specially in steel plants, mines, pulp and paper industries, sanitation, chemical and petrochemical areas, cement plants, among others, requiring more and more correct motor selection for each particular application. Proper motor selection with respect to the type, torque, power factor, efficiency, temperature rise, insulation system, voltage and mechanical degree of protection can only be made after careful overall analysis that takes into consideration certain parameters such as:

- Initial cost
- Power supply capacity
- Requirements for Power factor correction
- Required torques
- Effect of load inertia
- Speed control requirements or not
- Exposure of the machine to wet, polluted and/or aggressive environments.

Squirrel cage asynchronous motor is the most commonly used in any industrial application due to its rugged and simple construction characteristics along with economical factors in reference to the motor itself, as control and protection.

Using WEG Premium line motors is regarded the most convenient current means to reduce energy consumption. It has been proved by tests that these motors have 30% less of losses representing a major energy saving. Designed and manufactured with the state-of-the-art technology, these motors are intended to reduce losses and increase efficiency resulting in low energy consumption and reduced energy bills. These motors are also highly recommended for applications with voltage variation. They are tested in conformance with IEC 60034-1 Standard and their efficiency is indicated on the motor nameplate. The efficiency is determined by the test method B of the IEEE STD 112. Efficiency values are obtained through the loss separation method in accordance with IEC 60034-1.

The Premium line motors are standardized according to IEC standards, maintaining the power/frame ratio and are therefore interchangeable with all standard motors available on the market. Although more expensive than the squirrel cage motors, the application of slip ring motors is necessary for starting heavy loads (high inertia), or when variable speed drives or starting current limitation is required while a high starting torque must be maintained.

Type	Squirrel Cage induction motor	Slip ring motor
Design	Squirrel cage rotor	Wound rotor
Starting current	High	Low
Starting torque	Low	High
Starting/rated current	High	Low
Breakdown torque	> 160% of the rated torque	> 160% of the rated torque
Efficiency	High	High
Starting switch	Simple for DOL starting	Relatively simple
Protection device	Simple	Simple
Required space	Small	Rheostat requires large space
Maintenance	Small	For slip rings and brushes
Cost	Low	High

Table 11.1 - Comparison between different types of machines

For correct motor selection it is essential to consider all technical application characteristics, specially load, environment and power supply characteristics allowing the designer to calculate the following:

a) Starting torque

The starting torque required to move and overcome the static inertia of the machine. For any load to be accelerated from zero speed to its rated speed, motor torque must be always higher than the load torque.

b) Acceleration torque

This torque is required to accelerate the load to the rated speed. At all points between zero and rated speed, the motor torque must always be higher than load torque. Right over the intersection point of the two curves, acceleration torque is zero, i.e., the balance point from which the speed remains constant is reached.

This intersection point between the two curves should correspond to the rated speed.

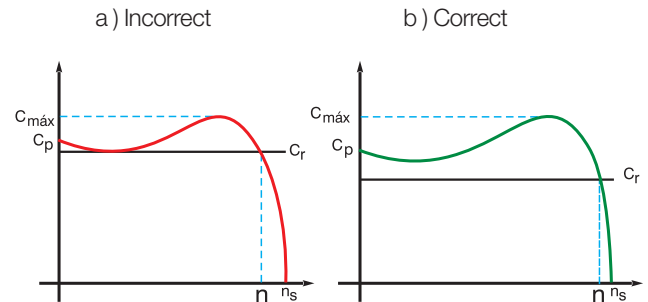

Figure 11.1 - Motor selection considering the resistive load torque

- where: C_{max} = breakdown torque
- C_p = starting torque
- C_r = resistive torque
- n_s = synchronous speed
- n = rated speed

The acceleration torque assumes very different values during the starting stage. The average acceleration torque (C_a) is obtained from the difference between motor torque and resistive load torque.

c) Rated torque

It is the torque required to accelerate the load when operating at a specific speed. The torque required for normal operation of a machine can be constant or can vary between wide limits. For variable torques, the breakdown torque should be sufficiently high to withstand momentary overloads. The operating characteristics of a machine, related to torque, can be divided into three classes:

■ **Constant torque**

On this type of machine, torque remains constant during speed variation and the output increases proportionally with the speed.

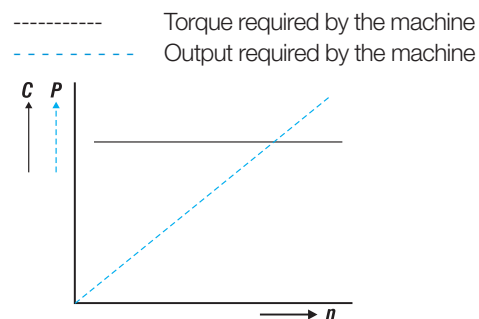

Figure 11.2

- C = Constant resistive torque
- P = Power: proportional to the speed (n)

■ **Variable torque**

Variable torques can be found in pumps and fans.

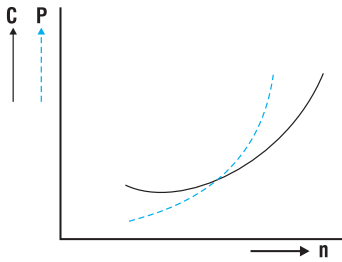

Figure 11.3

C = Resistive torque: proportional to the square of the speed (n^2)
 P = Output: proportional to the cube of the speed (n^3)

■ **Constant power**

Constant Power applications require a power equal to the rated Power for any speed.

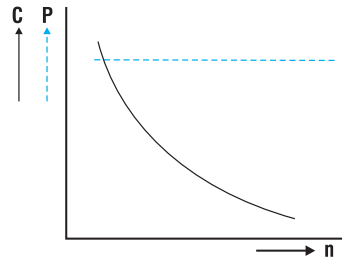

Figure 11.4

C = Resistive torque: inversely proportional to the square of the speed (n^2)
 P = Constant power

11.1 Motor Type Selection for Different Loads

	Required torque		Load characteristics	Used motor type
	Starting	Breakdown		
 Centrifugal pump, fans, drilling machines, compressors, milling machines, crushers.	Between 1 and 1,5 Times the rated torque	Maximum values between 220% and 250% of the rated torque.	<ul style="list-style-type: none"> Easy starting conditions such as intermediate gear boxes, low inertia or application of special couplings simplify starting. Centrifugal machines such as pumps where torque increases with the square of the speed up to a maximum stage reached at rated speed. At rated speed it may be subject to slight overloads. 	<ul style="list-style-type: none"> Normal torque Normal starting current Design N
 Alternating pumps, compressors, conveyors, feeders, bar milling machines	Between 2 and 3 Times the rated torque	Not higher than two times rated torque	<ul style="list-style-type: none"> High starting torque to overcome the high inertia, counter pressure, stop friction, strict material process or similar mechanical conditions. During acceleration, required torque decreases to rated torque. It is inadvisable to subject the motor to overloads at rated speed. 	<ul style="list-style-type: none"> High starting torque Normal starting current Design N
 Punching presses, cranes, overhead cranes, hoists, mechanical scissors, oil well pumps	3 times the rated torque	It requires two or three times the rated torque. They will be considered as losses during load peaks.	<ul style="list-style-type: none"> Intermittent loads requiring high or low starting torque. They require frequent stops, starts and reversals. Driven machines like punching presses that may require fly wheels to withstand the power peaks. Slight regulation may be required to smooth power peaks and reduce mechanical forces on the driven machine. Power supply must be protected from power peaks resulting from load fluctuations. 	<ul style="list-style-type: none"> High starting torque Normal starting current High slip Design D
 Fans, machine tools	Sometimes only part of the rated torque is required, and other times the full rated torque is required.	Once or twice the rated torque at each speed.	<ul style="list-style-type: none"> Two, three or four fixed speeds are sufficient. Speed control is not required. Starting torque can be low (fans) or high (conveyors) Operating characteristics at several speeds may vary between constant power, constant torque or variable torque. Metal cutting machines have constant output power Friction loads are typical examples of constant torque. Fans are typical examples of variable torque. 	<ul style="list-style-type: none"> Normal or high torque (multi-speed)

Table 11.2 - Characteristics of different loads.



11.2 WMagnet Drive System®

WMagnet Drive System® consists of a three-phase synchronous AC motor fitted with high energy magnets in their rotor and driven by a variable frequency drive (VFD)*.

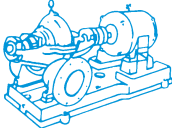
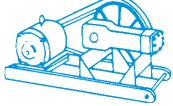
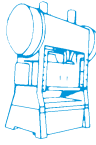
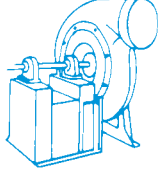
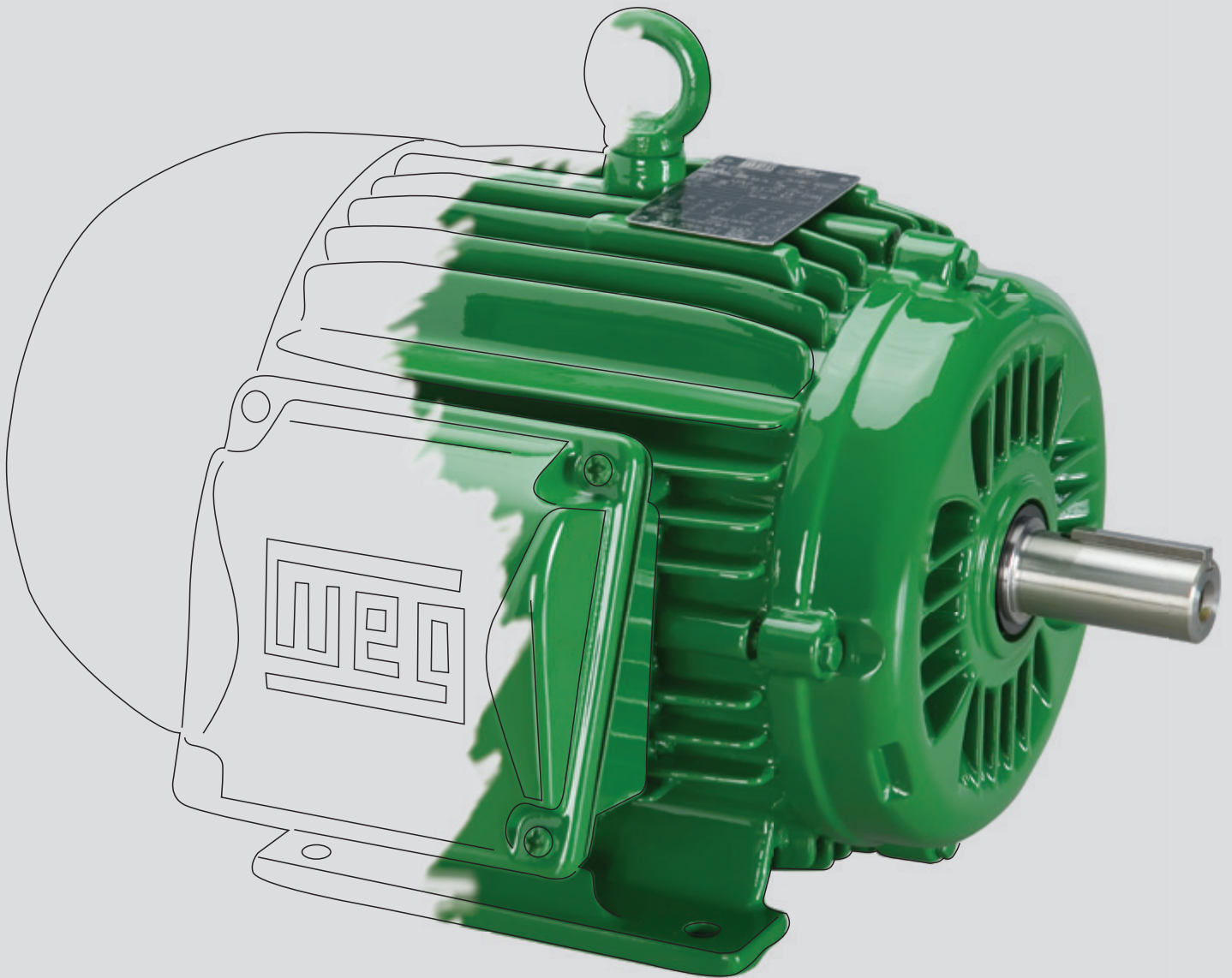
The use of permanent magnets eliminates the Joule losses in the rotor thus ensuring higher efficiency levels than the IE4 efficiency level. As the Joule losses are eliminated, the motor operates colder enabling the use of smaller frame size and increases its lifetime.

The use of frequency inverter enables a continuous control of the motor speed and provides constant torque in the whole speed range, including 0 rpm, without requiring forced ventilation at low frequencies. Due to the rotor design, the used balancing process and the frame size reduction, the vibration and noise levels of WMagnet Motors could be reduced when compared to the induction motors with the same output.



Figure 11.5

*WMagnet motors must be driven only by the CFW-11 frequency inverter line developed with specific software for this function.

11.3 Application of Induction Motors with Variable Frequency Drives

Inverter fed induction motor drives (also called static frequency converters) are the most common solution used in the industry and is currently the most efficient method for the speed control of induction motors. These applications provide several benefits when compared to other speed control methods. However, these applications depend on a suitable design to take advantage when compared between energy efficiency and costs. Among the many benefits are the cost reduction, remote control, versatility, increased quality and productivity and better use of the energy performance.

11.3.1 Normative Aspects

The breakthrough occurred in the electric motor application with frequency inverters requires increasingly standards development and standards adoption to standardize the procedures for evaluating these drives.

The main International Standards that deal with this subject are:

- **IEC: 60034-17** - Rotating Electrical Machines - Part 17: Cage induction motors when fed from converters - application guide
- **IEC 60034-25** - Rotating Electrical Machines - Part 25: Guide for the design and performance of cage induction motors specifically designed for converter supply
- **NEMA MG1** - Application considerations for constant speed motors used on a sinusoidal bus with harmonic content and general purpose motors used with adjustable-voltage or adjustable-frequency controls or both
- **NEMS MG1** - Part 31: Definite purpose inverter-fed polyphase motor

11.3.2 Induction Machine Speed Variation by Frequency Inverter

The relationship between the rotor speed, the supply frequency, the number of poles and the slip of a induction motor is given by the following equation: number of poles and the slip of a induction motor is given by the following equation:

$$n = \frac{120 \cdot f_1 \cdot (1 - s)}{p}$$

where: n = mechanical speed [rpm]
 f = line frequency [Hz]
 p = number of poles
 s = slip

The analysis of the formula shows that the best way to vary the speed of an induction motor is by varying the supply frequency. The frequency inverters transform the line voltage, with constant amplitude and frequency, into a voltage with variable amplitude and frequency. The speed of the rotating field and consequently the mechanical speed of the motor is changed by varying the frequency of the supply voltage. Thus, the inverter operates as a source of variable frequency to the motor. According to the induction motor theory, the electromagnetic torque developed by the motor is given by the following equation:

$$T = K_1 \cdot \Phi_m \cdot I_2$$

When the voltage drop is neglected due to the impedance of the stator winding, the magnetization flux will be:

$$\Phi_m = K_2 \cdot \frac{V_1}{f_1}$$

where: T : torque available on the shaft end (N.m)
 Φ_m : magnetization flux (Wb)
 I_2 : rotor current (A) (depends on the load)
 V_1 : rotor voltage (V)
 $k1$ e $k2$: constants (depend on the material and on the machine design)

However, to operate the motor in a speed range it is not sufficient to change only the supply frequency. Also the voltage amplitude must be proportionally changed to the frequency variation. Thus, the current flux and consequently the electromagnetic torque of the motor remain constant, while the slip is maintained. The change of the V/f variation rate is linear up to the base frequency (rated) of motor operation. Above this value, the voltage, that is equal to the rated motor voltage, remains constant and only the stator frequency is changed.

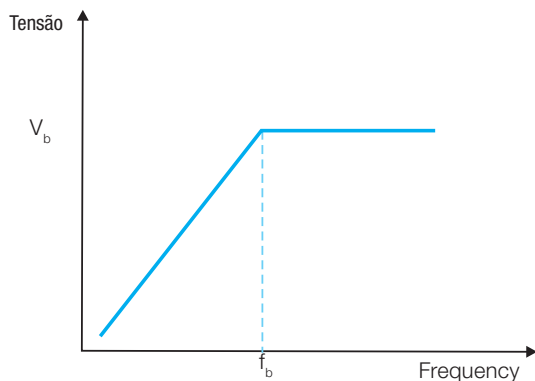

Figure 11.6

Thus, the region above the base frequency is referred to as field weakening, in which the flux decreases causing the motor torque decrease. The torque supplied by the motor remains constant up the base frequency of the operation, decreasing gradually when operating frequencies are increased.

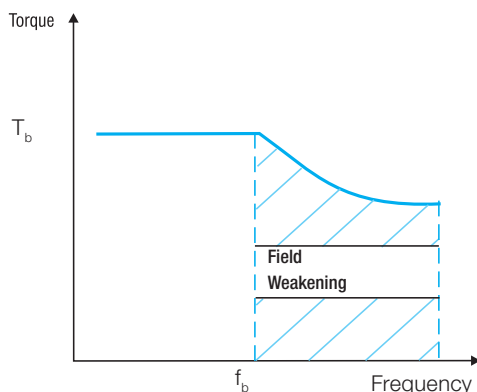

Figure 11.7

Since the output is proportional to torque multiplied by speed, the useful output power of the motor increases linearly up to the base frequency and from that point upwards it is maintained constant.

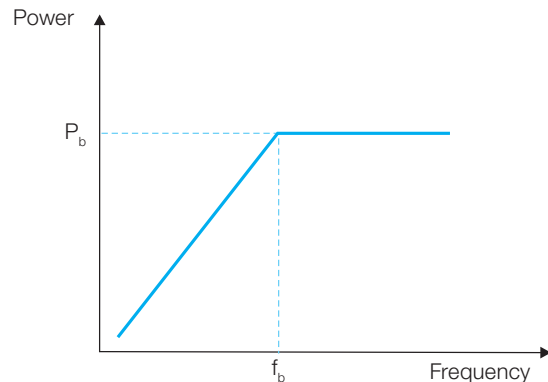

Figure 11.8

11.3.3 Characteristics of the Frequency Inverter

In order to obtain an output signal of desired voltage and frequency, the input signal must accomplish three stages within the frequency inverter:

- Diode bridge - Rectification (converting AC to DC) - voltage coming from the power supply;
- Filter or DC Link - Regulation/smoothing of the rectified signal with storage in a capacitor bank;
- IGBT power transistors - Inversion (converting AC to DC) of the DC link voltage by the Pulse-Width Modulation (PWM) technique. This modulation technique allows the output voltage/frequency variation by means of transistors (electronic switches) without interfering with the DC-voltage link.

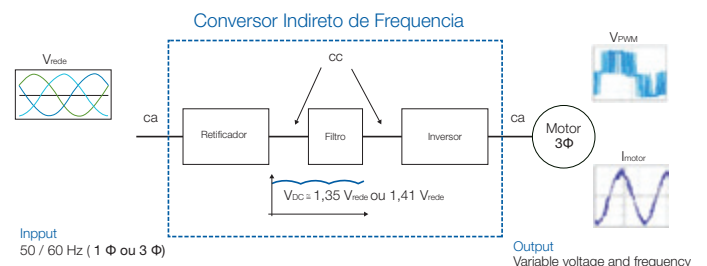

Figure 11.9

11.3.3.1 Control Types

There are basically two electronic inverter control types: scalar and vector.

The scalar control is based on the original concept of a frequency inverter: a signal of certain voltage/frequency ratio is imposed onto the motor terminals and this ratio is kept constant throughout a frequency range, in order to keep the magnetizing flux of the motor practically unchanged. It is generally applied when there is no need of fast responses to torque and speed commands and is particularly interesting when there are multiple motors connected to a single drive. The control is by open loop and the obtained speed precision is a function of the motor slip, which depends on the motor load. To improve the performance of the motor at low speeds, some drives use special functions such as slip compensation (attenuation of the speed variation as function of the load) and voltage boost (increase of the V/f ratio to compensate for the voltage drop due to the stator resistance and maintain the torque capacity of the motor) at low speeds.

This is the most used control type owing to its simplicity and also due to the fact that the majority of applications do not require high precision or fast responses during the speed control.

The vector control enables fast responses and high precision levels on the motor speed and torque control. Essentially the motor current is decoupled into two vectors: one to produce the magnetizing flux and the other to produce the torque, each one regulating the torque and the flux separately. The vector control can be realized by open loop (sensorless) or closed loop (feedback) control.

- Speed feedback - a speed sensor (for instance, an incremental encoder) is required on the motor. This control mode provides great accuracy on both torque and speed of the motor even at very low (and zero) speeds.
- Sensorless control is simpler than the closed loop control, but its action is limited particularly to very low speeds. At higher speeds this control mode is practically as good as the feedback vector control.

11.3.3.2 Harmonics

For the AC power line, the system (frequency inverter + motor) is a non-linear load which current include harmonics. The characteristic harmonics generally produced by the rectifier are considered to be of order $h = np \pm 1$ on the AC side, thus, in the case of a 6 diode (6 pulses) bridge, the most pronounced generated harmonics are the 5th and the 7th ones, which magnitudes may vary from 10% to 40% of the fundamental component, depending on the power line impedance. In the case of rectifier bridges of 12 pulses (12 diodes), the most harmful harmonics generated are the 11th and the 13th ones. The higher the order of the harmonic, the lower can be considered its magnitude. So higher order harmonics can be filtered more easily. The most commercially available drives have 6-pulses.

The harmonic distortion of the power system can be quantified by the THD (Total Harmonic Distortion), which is informed by the inverter manufacturer and is defined as:

$$THD = \sqrt{\sum_{h=2}^{\infty} \left(\frac{A_h}{A_1} \right)^2}$$

where: A_h : are the rms values of the non-fundamental harmonic components
 A_1 : is the rms value of the fundamental component
 h : harmonic order

The IEEE Std.512 recommends maximum values for current harmonics generated by electric equipment. Most manufacturers of inverters take care during the design of their equipment to ensure that the THD limits established by this standard are fulfilled.

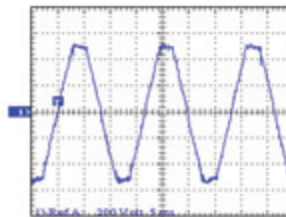

Typical voltage waveform at input of a PWM inverter with 6 pulses (frequency: 50 Hz or 60 Hz)

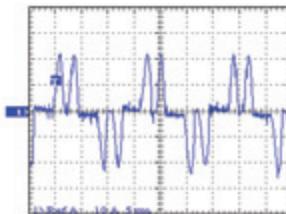

Typical current waveform current at input of a 6-pulse PWM inverter

Figure 11.10

11.3.4 Inverter Influencing Motor Performance

Induction motors driven by PWM inverter are subjected to harmonics that can increase the losses and the temperature as well as the noise and vibration levels, when compared to the sinusoidal supply condition. The inverter influence on the motor depends on several factors related to the control, such as switching frequency, the effective pulse width, pulse number, among others.

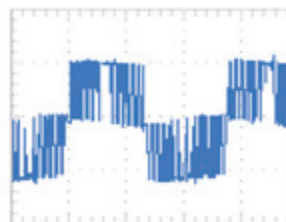

Typical current waveform current at motor terminals fed by PWM voltage

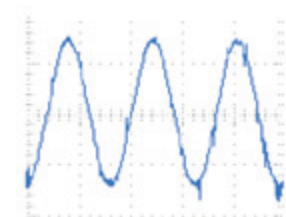

Typical PWM voltage waveform at inverter output

Figure 11.11

There are basically the following solutions to mitigate the harmonics generated by a PWM frequency inverter: Installation of output filters (load reactance, dV/dt filters, sinusoidal filters, etc.), use of multi-level inverters (more sophisticated topology), Pulse Width Modulation quality improvement (optimization of pulse patterns) and increase of the switching frequency.

Furthermore other effects may appear when induction motors are fed by inverters. Although not produced specifically by the harmonics, other important effects may appear and should not be neglected, such as dielectric stress of the insulation system and shaft currents that reduce bearing life.

Considerations regarding energy efficiency

The lack of international standards that specify test procedures to evaluate the system (motor + inverter) efficiency allows such tests to be carried out in many different ways. Therefore, the results obtained should not influence the acceptance (or not) of the motor, except under mutual accordance between customer and manufacturer, as specified by international standards.

Experience shows the effectiveness of the considerations below:

- An induction motor fed by PWM voltage provides a lower efficiency level than when fed by purely sinusoidal voltage, due to the losses increase caused by harmonics.
- In applications of motors with frequency inverters, the whole system must be evaluated (inverter + motor), rather than the motor efficiency only.
- Each case must be properly analyzed, taking into account following characteristics: operating frequency, switching frequency, load conditions, motor power, THD supplied by the inverter, etc.
- Special measuring instruments must be used for the correct evaluation of electrical quantities (True RMS meters).
- Higher switching frequencies increase the motor efficiency and decrease the inverter efficiency.

Influence of the inverter on the temperature rise of the windings

Induction motors may heat up more when fed by frequency inverter than when fed by sinusoidal voltage supply. This higher temperature rise results from the motor losses growth owing to the high harmonic components of the PWM signal and the often reduced heat transfer resulting from speed variation of self-ventilated motors operating at low frequencies. Basically there are following solutions to prevent motor overheating:

- Rated torque derating (frame oversize);
- Use of independent cooling system;
- Utilization of the “Optimal Flux Solution” (exclusive to applications using WEG drives and motors).

Criteria for torque derating

In order to keep the temperature rise of WEG motors, when supplied by PWM, within acceptable levels and the loadability, limits shown in Fig. 11.13 and 11.14 must be met.

Note: motors rated for explosive atmospheres should be evaluated on a case by case basis - in such case please contact WEG.

Optimal flux condition

The “Optimal Flux” solution was developed for the purpose of making WEG induction motors able to operate at low speeds with constant torque loads still keeping an acceptable temperature rise level, without the need of neither oversizing the machine nor blower cooling it.

The study of the composition of the motor losses and their relation with the frequency, magnetic flux, current and the speed variation allowed the determination of an optimal flux condition for each speed.

The incorporation of the solution obtained for WEG CFW09 and CFW11 inverters allows a continuous mitigation of the motor losses throughout the whole operating range, which is performed automatically by the inverter.

Important!

- This solution can only be used for variable torque loads or when applied above the base frequency and when:
- Class IE2 High-Efficiency or Class IE3 Premium Efficiency motors are used;
 - The motor is fed by WEG frequency inverter (CFW11 or CFW09 version 2.40 or above);
 - Sensorless vector control is used.

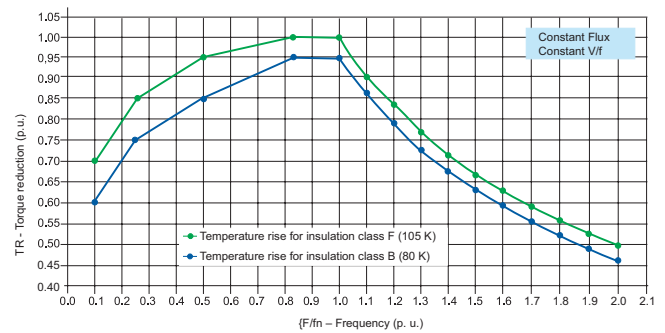

Figure 11.12 - Constant flux condition

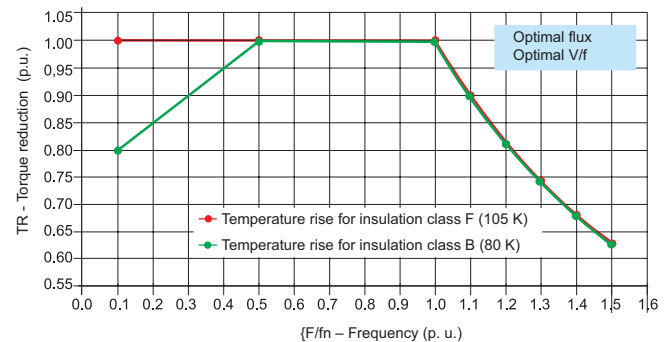

Figure 11.13 - Optimal flux condition

Modern frequency inverters use power transistors (typically IGBTs), whose switching process occurs at very high speed - at kHz frequencies. To achieve such switching, the transistors have very fast times for conducting initiation and blocking which result in voltage pulses with a high dV/dt (rate of voltage change over time). When squirrel cage induction motors are fed by frequency, those pulses combined with the cable and motor impedances may cause repetitive overvoltages (overshoots) at the motor terminals. This pulse train may degrade the motor insulation system and may hence reduce the motor lifetime. The overshoots affect especially the interturn isolation of random windings and its value is determined primarily by following factors: rise time of the voltage pulse, cable length and type, minimum time between pulses, switching frequency and multimotor operation.

Criteria regarding the insulation system

When WEG low voltage induction motors are used with frequency inverters, the following criteria must be met to protect the insulation system of the motor: if any of the conditions below are not met, filters must be installed between the frequency inverter and the motor.

Note: motors rated for explosive atmospheres should be evaluated on a case by case basis - in such case please contact WEG.

Motor rated voltage	Voltage spikes at motor terminals (phase-phase)	dV/dt* at motor terminals (phase-phase)	Rise Time*	MTBP
$V_{NOM} \leq 460 \text{ V}$	$\leq 1600 \text{ V}$	$\leq 5200 \text{ V}/\mu\text{s}$	$\geq 0.1 \mu\text{s}$	$\geq 6 \mu\text{s}$
$460 \text{ V} < V_{NOM} \leq 575 \text{ V}$	$\leq 1800 \text{ V}$	$\leq 6500 \text{ V}/\mu\text{s}$		
$575 \text{ V} < V_{NOM} \leq 690 \text{ V}$	$\leq 2200 \text{ V}$	$\leq 7800 \text{ V}/\mu\text{s}$		

Table 11.4

* Definition in accordance with NEMA MG1- Part 30

The phenomenon of induced shaft voltage/current is caused fundamentally due to unbalanced waveforms present in the magnetic circuit of the motor. The usual causes of this problem that primarily affect large machines are eccentricities and other imperfection resulting from the manufacturing process. The advent of PWM inverters aggravated this problem, now occurring also with lower power machines, since the motors are now fed with unbalanced waveforms that have high frequency components. The causes of shaft induced voltage owing to the PWM inverters supply is added to those intrinsic voltages of the motor which also causes current circulation through the bearings.

The basic reason for bearing currents to occur within a PWM inverter fed motor is due to the common mode voltage. The high frequency of the common mode voltage generated by the frequency inverter ensures that the capacitive reactances within the motor become low, allowing the current to pass through the coupling formed by the rotor, shaft and bearing toward the earth.

Common mode voltage and motor equivalent circuit for high frequencies

The three-phase voltages supplied by the PWM inverter, different than the pure sinusoidal voltage, is not balanced, i.e., the vector sum of the instantaneous voltages at the three phases of the frequency inverter output is not equal to zero, but it is equal to an electric potential of high frequency. This high frequency common mode voltage may result in undesirable common mode currents. Existing stray capacitances between motor and earth may allow current flowing to the earth, passing through rotor, shaft and bearings and reaching the end shield (earthed).

The high frequency model of the motor equivalent circuit, in which the bearings are represented by capacitances shows the paths through which the common mode currents flow. At high speed operation there is no contact between the rotor and the (earthed) outer bearing raceway, due to the plain distribution of the grease.

The electric potential of the rotor may then increase with respect to the earth until the dielectric strength of the grease film is disrupted, occurring voltage sparking and flow of discharge current through the bearings. This current that circulates whenever the grease film is momentarily broken down is often referred to as the “capacitive discharge component”.

These discontinuous electric discharges wear the raceways and erode the rolling elements of the bearings, causing small superimposing punctures. Long term flowing discharge currents result in furrows (fluting), which reduce bearings life and may cause the premature machine failure. There is still another current component that circulates permanently through the characteristic conducting loop comprising the shaft, bearings, end shields and the housing/ frame, that is often called the conduction component.

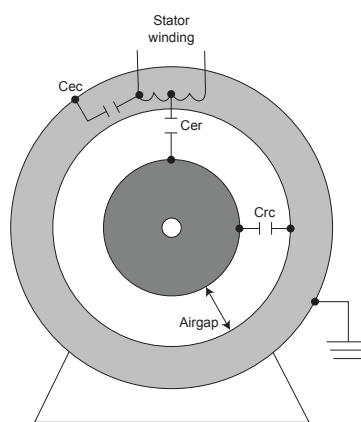

Figure 11.14 - Capacitive discharge current.

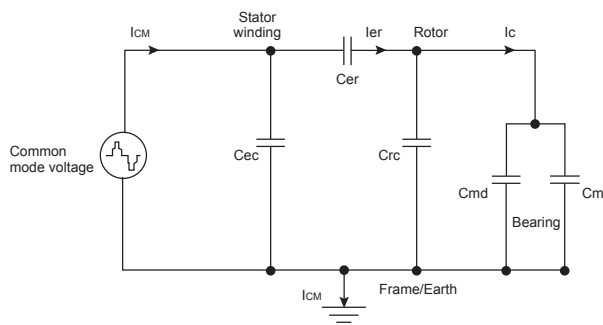

Figure 11.16 - Motor capacitance.

Equivalent circuit for high frequencies:

- C_{er} : capacitor formed by the stator winding and the rotor lamination
- C_{rc} : capacitor formed by rotor and stators cores
- C_{ec} : capacitor formed by the stator winding and the frame
- $C_{md/mt}$: capacitance of the DE/NDE bearings, formed by the inner and the outer bearing raceways with the metallic rolling elements
- I_{CM} : total common mode current
- I_{er} : capacitive discharge current flowing from the stator to the rotor
- I_c : capacitive discharge current flowing through the bearings

Protection criteria against bearing currents of WEG motors fed by VSD

When WEG low voltage three-phase induction motors are fed by frequency inverters, following criteria must be met for the bearing protection:

Note: motors rated for explosive atmospheres should be evaluated on a case by case basis - in such case please contact WEG.

LINE W22		
Frame size (IEC)	Standard	Opcional
225 ≤ mod < 315	<ul style="list-style-type: none"> ■ No protected 	<ul style="list-style-type: none"> ■ Insulated NDE bearing ■ Insulated DE bearing ■ Earthing system with brush between frame and NDE-shaft
315 and 355	<ul style="list-style-type: none"> ■ Insulated NDE bearing ■ Earthing system with brush between frame and DE-shaft 	<ul style="list-style-type: none"> ■ Both bearings are insulated

Table 11.5 - Bearing protection

The rotating electrical machines have basically three noise sources: the ventilation system, the rolling bearings and the electromagnetic excitation. Bearings in perfect operating conditions produce practically despicable noise, in comparison with other sources of the noise generated by the motor.

In motor fed by sinusoidal supply, especially those with reduced number of poles (higher speeds), the main noise source is the ventilation system. On the other hand, in motors with higher number of poles and lower operation speeds often stands out the electromagnetic noise.

However, in variable speed drive systems, especially at low operating speeds when ventilation is reduced, the electromagnetically excited noise can be the main source of noise whatever the motor polarity, owing to the harmonic content of the voltage.

Criteria regarding the noise level generated by WEG motors with VSD applications

Results of laboratory tests (4 point measurements accomplished in semi-anechoic chamber with the frequency inverter installed outside the chamber) carried out with several WEG motors and frequency inverters using different switching frequencies have shown that WEG three-phase induction motors, when fed by PWM frequency inverters and operating at rated frequency (typically 50 or 60 Hz) present an increment in the sound pressure level of 11 dB(A) at most.

Notes:

- O switching frequency increase tends to reduce the noise level of electromagnetic origin generated by the motor.
- The noise criteria above apply only to motor frame sizes ≤ 355.

12. Environmental Information

12.1 Packaging

WEG electric motors are supplied in cardboard, plastic or wooden packaging. These materials can be recycled or reused. All wood used in the packaging of WEG motors comes from reforestation and is not submitted to chemical conservation treatment.

12.2 Product

As far as constructive aspects are concerned, electric motors are basically manufactured with ferrous metals (steel, cast iron) non-ferrous metals (copper, aluminum) and plastic.

13. Tests

This chapter defines the witnessed or unwitnessed tests that can be performed by WEG upon customer request.

As defined by IEC 60034-1, the tests are grouped in ROUTINE, TYPE and SPECIAL tests. The test procedures are specified in IEC 60034-2. Other tests not listed below can be performed by the manufacturer provided there is an agreement between the parties.

List of tests					
Description	Routine Test	Type test	Special test	According to Standard	
1 Winding resistance - cold	X	X		IEEE 112	IEC 60034-1
2 Tests with locked rotor	X	X		IEEE 112	IEC 60034-1
3 Temperature rise test	N.A.	X		IEEE 112	IEC 60034-1
4 Load test	N.A.	X		IEEE 112	IEC 60034-2-1
5 Breakdown torque test	N.A.	X		IEEE 112	IEC 60034-1
6 No-load test	X	X		IEEE 112	IEC 60034-2-1
7 Mechanical Vibration -measurement	Optional	Optional	X	NEMA MG1 Part 7	IEC 60034-14
8 Noise level-measurement	Optional	Optional	X	NEMA MG1 Part 9	IEC 60034-9
9 High-potential test	X	X		IEEE 112	IEC 60034-1
10 Insulation resistance test	X	X		IEEE 43	IEC 60204-1
11 Polarization index	Optional	Optional	X	IEEE 43	IEC 60204-1
12 Speed-torque curve	N.A.	Optional	X	IEEE 112	-
13 Overspeed	Optional	Optional	X	NEMA MG1 Part 12.52	IEC 60034-1
14 Shaft voltage	Optional	Optional	X	IEEE 112	-
15 Bearing insulation resistance	Optional	Optional	X	IEEE 112	-
16 Momentary excess torque	Optional	Optional	X	NEMA MG1	IEC60034-1
17 Occasional excess current	Optional	Optional	X	NEMA MG1 Part 12.48	IEC60034-2-1

Note: N.A. - Not applicable

Optional - upon request

13.1 Variable Frequency Drive Motors

When motors are driven by frequency inverters the tests are performed directly on the power line (sinusoidal voltage source) except for the temperature rise test that can be carried out with PWM supply, on request.

14. Appendix

14.1. International System of Units

Quantity	Name	Symbol
Acceleration	Meter squared per second	m/s ²
Angular acceleration	Radian per second squared	rad/s ²
Flat angle	Radian	rad
Solid angle	Steradian	sr
Area	Square meter	m ²
Specific heat	Joule per kilogram per kelvin	J/kgK
Capacitance	Farad	
Flow	Cubic meter per second	m ³ /s
Conductance	Siemens	S
Thermal conductivity	Watt per meter per kelvin	W/mK
Conductivity	Siemens per meter	S/m
Energy flux density	Watt per square meter	W/m ²
Absorbed dose	Joule per kilogram	J/kg
Energy	Joule	J
Entropy	Joule per kelvin	J/K
Mass flow	Kilogram per second	kg/s
Magnetic flux	Weber	Wb
Frequency	Hertz	Hz
Force	Newton	N
Temperature gradient	Kelvin per meter	K/m
Impulsion	Newton-second	Ns
Magnetic induction	Tesla	T
Inductance	Henri	H
Electric field intensity	Volt per meter	V/m
Magnetic field intensity	Ampère per metro	A/m
Current intensity	Ampère	A
Frequency interval	Octave	
Length	Meter	m
Mass	Kilogram per cubic metre	kg
Specific mass	Kilogram/cubic meter	kg/m ³
Moment of force	Newton-meter	Nm
Moment of kinetic	kilogram-square meter-second	kgm ² /s
Moment of inertia	Kilogram/square meter	kgm ²
Power	Watt	W
Presssure	Newton per square meter	N/m ²
Reluctance	Ampère per Weber	A/Wb
Elwectric resistance	Ohm	Ω
Mass resistivity	Ohm-kilogram per sqauw meter	Ωkg/m2
Resistivity	Ohm-meter	Ωm
Thermodynamic temperature	Kelvin	K
Voltage	Volt	V
Surface tension	Newton per meter	N/m
Time	Second	s
Angular speed	Radian per second	rad/s
Speed	Meter per second	m/s
Dynamic viscosity	Newton-second per square meter	Ns/m ²
Kinematic viscosity	Square meter per second	m ² /s
Volume	Cubic meter	m ³

Table 14.1

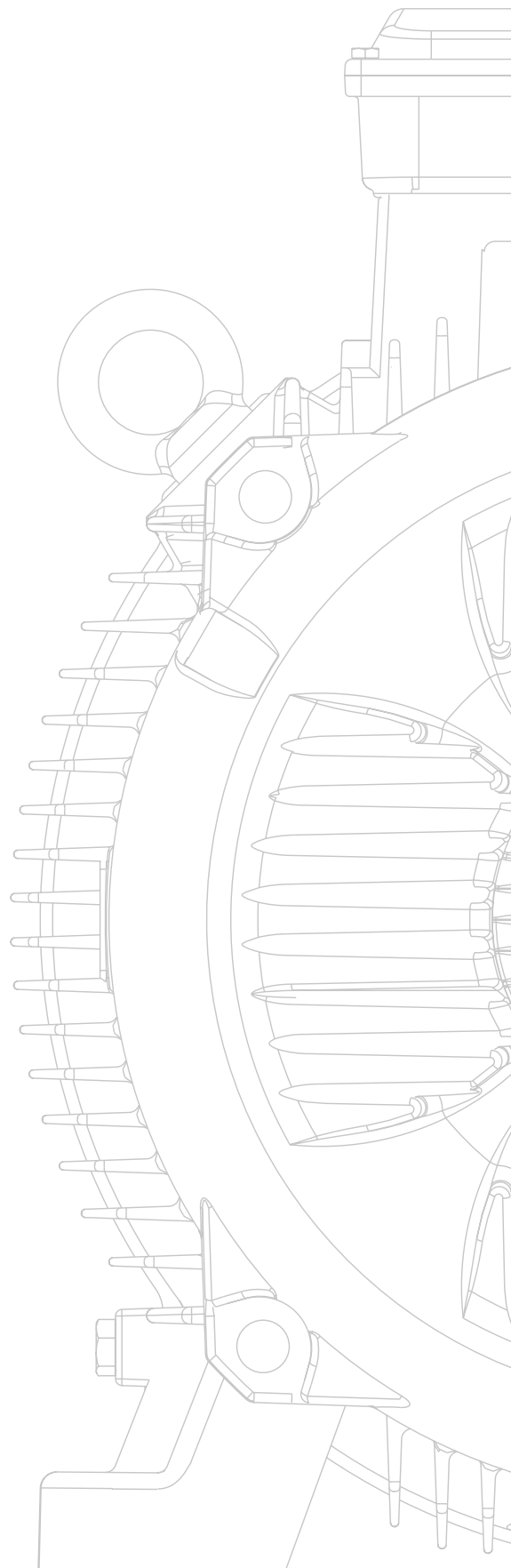

14.2 Unit Conversion

From	Multiply by	To obtain
BTU	$3.94 \cdot 10^{-4}$	HP.h
BTU	$2.928 \cdot 10^{-4}$	kW.h
BTU/h	107.5	kgm/s
BTU/h	0.2931	W
BTU/h ² ($\frac{^{\circ}\text{F}}{\text{Pie}}$)	0.0173	W/cm ² ($\frac{^{\circ}\text{C}}{\text{cm}}$)
BTU/h ² ($\frac{^{\circ}\text{F}}{\text{Pé}}$)	0.0833	BTU/h.pé ² ($\frac{^{\circ}\text{F}}{\text{Pie}}$)
BTU/h.Pé ² .°F	$5.68 \cdot 10^{-4}$	W/cm ² .°C
BTU/h.Pé ² .°F	$3.94 \cdot 10^{-4}$	HP/pé ² .°F
BTU/min	0.01758	kW
BTU/min	17.58	W
BTU/s	$2.93 \cdot 10^{-4}$	kW
BTU/s	$3.93 \cdot 10^{-4}$	HP
BTU/s	$3.94 \cdot 10^{-4}$	cv
C		
Calorie (gram)	$3.9683 \cdot 10^{-3}$	BTU
Calorie (gram)	$1.5596 \cdot 10^{-6}$	HP.h
Calorie (gram)	$1.1630 \cdot 10^{-6}$	kW.h
Calorie (gram)	3600/860	Joule
Cal/s.cm ² ($\frac{^{\circ}\text{C}}{\text{cm}}$)	4.19	W/cm ² ($\frac{^{\circ}\text{C}}{\text{cm}}$)
cv	75	kg.m/s
cv	735.5	W
cm	0.3937	pol.
cm ³	$1.308 \cdot 10^{-6}$	jarda ³
cm ³	$3.531 \cdot 10^{-6}$	pé ³
cm ³	0.06102	pol. ³
cm ²	$1.076 \cdot 10^{-3}$	pé ²
cm ²	0.1550	pol. ²
cm/s	0.036	km/h
G		
Degree Celsius	$(^{\circ}\text{C} \frac{9}{5}) + 32$	F
Degree Celsius	$(^{\circ}\text{C}) + 273.15$	K
Degree Fahrenheit	$(\text{F} - 32) \frac{5}{9}$	°C
Trigonometric degree	0.01745 radian	
H		
HP	42.44	BTU/min
HP	1.014	cv
HP (boiler)	33479	BTU/h
HP	10.68	kcal/min
HP	76.04	kg.m/s
HP	0.7457	kW
HP	550	pound/force-foot /s
HP.h	$2.684 \cdot 10^6$	J
HP.h	0.7457	kW.h
HP.h	$1.98 \cdot 10^6$	Pound/force-foot
HP.h	$2.737 \cdot 10^5$	kgm
J		
Yard ³	0.7646	m ³
Joule	$9.480 \cdot 10^{-4}$	BTU
Joule	0.7376	Pound/force-foot kcal
Joule	$2.389 \cdot 10^{-4}$	Pound
Joule	22.48	Pound
Joule	1	W

Table 14.2

From	Multiply by	To obtain
K		
kcal/h.m ² ($\frac{^{\circ}\text{C}}{\text{m}}$)	0.671	BTU/h.pé ² ($\frac{^{\circ}\text{F}}{\text{Pie}}$)
kg	2.205	Pound
kgf/cm ²	14.22	Pound/force-inch ²
kgf/cm ³	$3.613 \cdot 10^{-5}$	Pound/pol ³
km	1094	Yard
km	3281	Foot
km	0.6214	Mile
km ²	0.3861	Mile ²
km ²	$10.76 \cdot 10^{-6}$	Foot ²
km/h	27.78	cm/s
km/h	0.6214	Mile/h
km/h	0.5396	Knot
km/h	0.9113	foot/s
kgf	9.807	J/m (N)
kW	56.92	BTU/min
kW	1.341	HP
kW	14.34	kcal/min
kW/h	3413	BTU
kW/h	859850	Cal
kW/h	1.341	HP.h
kW/h	$3.6 \cdot 10^6$	J
kW/h	$2.655 \cdot 10^6$	Pound/foot
kW/h	$3.671 \cdot 10^5$	kgm
L		
Pound-force.foot/s	$1.356 \cdot 10^{-3}$	kW
Pound-force.foot/s	0.01602	g/cm ³
Pound-force.foot ²	16.02	kg/m ³
Pound-force.inch	17.86	kg/m
Pound-force.inch ²	0.07301	kg/cm ²
Pound-force.foot /min	$3.24 \cdot 10^{-4}$	kcal/min
Pound-force.foot /min	$2.260 \cdot 10^{-5}$	kW
Pound-force-foot /s	0.0717	BTU/min
Pound-force	16	ounce
Liter	0.2642	gallon
Liter/min	$5.886 \cdot 10^{-4}$	foot/s
Pound-force/foot	$3.24 \cdot 10^{-4}$	kcal
Pound-force/foot	1.488	kg/m
Pound-force/foot	$3.766 \cdot 10^{-7}$	kW.h
Pound-force/foot	0.1383	kgfm
Pound-force.foot ²	0.0421	kg/m ²
Pound-square inch (sq.in.lb)	2.93×10^{-4}	Kilogram-square meter (kgm ²)
M		
m	1.094	Yard
m	$5.396 \cdot 10^{-4}$	Nautical mile
m	$6.214 \cdot 10^{-4}$	Land mile
m	39.37	Inch.
m ³	35.31	Foot ³
m ³	61023	Inch ³
m	1.667	cm/s
m/min	0.03238	Knot
m/min	0.05408	Foot/s
m ²	10.76	Foot ²
m ²	1550	Inch ²
m.kg	7.233	pound/force-foot
m/s	2.237	mile/h
m/s	196.8	Foot/min
Micrómetro	10^{-6}	m
Milha/h	26.82	m/min
Milha/h	1467	foot
Milha quadrada	2.590	km ²
Milha	0.001	inch
Milimetro	0.03937	inch

From	Multiply by	To obtain
N		
Newton	1.10 ⁵	Dina
Knot	1.8532	km/h
Knot	1.689	foot
Newton	0.1019	kilogram-force (kgf) or kilopund (kp)
Newton-meter	0.1019	kilogram-force (mkgf) or kilopound meter (mkp)
Newton-meter	0.7376	Pound.force-foot (lbf. ft)
O		
Ounce	28.349	gram
P		
Foot	0.3048	m
Foot/min	0.508	cm/s
Foot/min	0.01667	foot/s
Foot/s	18.29	m/min
Foot/s	0.6818	mile/h
Foot/s	0.5921	nó
Foot/s	1.097	km/h
Foot ²	929	cm ²
Foot	30.48	cm
Foot ³	28.32	liter
Foot ³ /Lb	0.06242	m ³ /kg
Foot ³ /min	472	cm ³ /s
Inch	25.40	mm
Inch ³	0.01639	liter
Inch ³	1.639.10 ⁻⁵	m ³
Inch ³	5.787.10 ⁻⁴	foot ³
Q		
Kilocalorie	3.9685	BTU
Kilocalorie	1.560.10 ⁻²	HP.h
Kilocalorie	4.186	J
Kilocalorie	426.9	kgm
Kilocalorie	3.088	Pound-force foot
Kilogram-meter	9.294.10 ⁻³	BTU
Kilogram-meter	9.804	J
Kilogram-meter	2.342.10 ⁻³	kcal
Kilogram-meter	7.233	Pound-force foot
Kilogram -force (kgf) or kilopound (kp)	2.205	Pound-force (lb)
Kilogram-force meter (mkgf) or Kilopound-meter (mkp))	7.233	Pound-force foot (ft.lb)
Kilogram-square meter (kgm ²)	1.358 23.73	Pound-sqre foot (sq. ft. lb)
R		
Radian	3438	min.
rpm	6.0	degree/s
rpm	0.1047	radian/s
Radian/s	0.1592	rpm
W		
Watt	0.05688	BTU/min
Watt	1.341.10 ⁻³	HP
Watt	0.01433	kcal/min
Watt	44.26	Pound-force foot/min
Watt	0.7378	Pound-force foot/s

Table 14.2

14.3 Standards

Main standards used for Rotating Electrical Machines			
IEC	Title	NEMA	Title
IEC 60034-7	Rotating. Electrical Machines: Part 7: Classification types of construction, mounting, arrangements and terminal box position (IM Code)	NEMA MG 1 Part 4	Motor and Generators - Part 4: Dimensions, tolerances, and mounting
IEC 60034-6	Rotating. Electrical Machines: Part 6: Methods of cooling(IC Code)	NEMA MG 1 Part 6	Motor and Generators - Part 6: Rotating electrical machines - Method of cooling (IC code)
IEC 60034-1	Rotating Electrical Machines - Part 1: Rating and Performance	IEEE 112	Test procedures for polyphase induction motors and generators
IEC 60072-1/2	Dimensions and output series for rotating electrical machines- Part 1 and Part 2	NEMA MG 1 Part 4	Motor and Generators - Part 4: Dimensions, tolerances, and mounting
IEC 60085	Electrical insulation - Thermal evaluation and designation	IEEE 1	General Principles for Temperature Limits in the Rating of Electric Equipment and for the Evaluation Electrical Insulation
IEC 60034-9	Rotating Electrical Machines: Part 9: Noise limits	NEMA MG 1 Part 9	Motor and Generators - Part 9: Sound power limits and measurement procedures
IEC 60034-1	Rotating Electrical Machines: Part 1: Rating and performance	NEMA MG 1	Motor and Generators
IEC 60079	Safety standard series applied to explosive atmospheres	UL 60079 UL 674 CSA C22.2 N°145	Electrical Apparatus for Explosive Gas Atmospheres Electric Motors and Generators for Use in Division 1 Hazardous (Classified) Locations Motors and Generators for Use in Hazardous Locations
IEC 60529	Degrees of protection provided by enclosures (IP Code)	NEMA MG 1 Part 5	Motor and Generators - Part 5: Classification of degrees of protection provided by enclosures for rotating machines

WEG Worldwide Operations

ARGENTINA

WEG EQUIPAMIENTOS
ELECTRICOS
San Francisco - Cordoba
Phone: +54 3564 421 484
info-ar@weg.net
www.weg.net/ar

WEG PINTURAS - Pulverlux
Buenos Aires
Phone: +54 11 4299 8000
tintas@weg.net

AUSTRALIA

WEG AUSTRALIA
Victoria
Phone: +61 3 9765 4600
info-au@weg.net
www.weg.net/au

AUSTRIA

WATT DRIVE - WEG Group
Markt Piesting - Viena
Phone: +43 2633 404 0
watt@wattdrive.com
www.wattdrive.com

BELGIUM

WEG BENELUX
Nivelles - Belgium
Phone: +32 67 88 84 20
info-be@weg.net
www.weg.net/be

BRAZIL

WEG EQUIPAMENTOS ELÉTRICOS
Jaraguá do Sul - Santa Catarina
Phone: +55 47 3276-4002
info-br@weg.net
www.weg.net/br

CHILE

WEG CHILE
Santiago
Phone: +56 2 784 8900
info-cl@weg.net
www.weg.net/cl

CHINA

WEG NANTONG
Nantong - Jiangsu
Phone: +86 0513 8598 9333
info-cn@weg.net
www.weg.net/cn

COLOMBIA

WEG COLOMBIA
Bogotá
Phone: +57 1 416 0166
info-co@weg.net
www.weg.net/co

FRANCE

WEG FRANCE
Saint Quentin Fallavier - Lyon
Phone: +33 4 74 99 11 35
info-fr@weg.net
www.weg.net/fr

GERMANY

WEG GERMANY
Kerpen - North Rhine Westphalia
Phone: +49 2237 9291 0
info-de@weg.net
www.weg.net/de

GHANA

ZEST ELECTRIC GHANA
WEG Group
Accra
Phone: +233 30 27 664 90
info@zestghana.com.gh
www.zestghana.com.gh

INDIA

WEG ELECTRIC INDIA
Bangalore - Karnataka
Phone: +91 80 4128 2007
info-in@weg.net
www.weg.net/in

WEG INDUSTRIES INDIA
Hosur - Tamil Nadu
Phone: +91 4344 301 501
info-in@weg.net
www.weg.net/in

ITALY

WEG ITALIA
Cinisello Balsamo - Milano
Phone: +39 02 6129 3535
info-it@weg.net
www.weg.net/it

JAPAN

WEG ELECTRIC MOTORS
JAPAN
Yokohama City - Kanagawa
Phone: +81 45 550 3030
info-jp@weg.net
www.weg.net/jp

MEXICO

WEG MEXICO
Huehuetoca
Phone: +52 55 5321 4231
info-mx@weg.net
www.weg.net/mx

VOLTRAN - WEG Group
Tizayuca - Hidalgo
Phone: +52 77 5350 9354
www.voltran.com.mx

NETHERLANDS

WEG NETHERLANDS
Oldenzaal - Overijssel
Phone: +31 541 571 080
info-nl@weg.net
www.weg.net/nl

PERU

WEG PERU
Lima
Phone: +51 1 472 3204
info-pe@weg.net
www.weg.net/pe

PORTUGAL

WEG EURO
Maia - Porto
Phone: +351 22 9477705
info-pt@weg.net
www.weg.net/pt

RUSSIA

WEG RUSSIA
Saint Petersburg
Phone: +7 812 363 2172
info-ru@weg.net
www.weg.net/ru

SOUTH AFRICA

ZEST ELECTRIC MOTORS
WEG Group
Johannesburg
Phone: +27 11 723 6000
info@zest.co.za
www.zest.co.za

SPAIN

WEG IBERIA
Madrid
Phone: +34 91 655 30 08
info-es@weg.net
www.weg.net/es

SINGAPORE

WEG SINGAPORE
Singapore
Phone: +65 68589081
info-sg@weg.net
www.weg.net/sg

SCANDINAVIA

WEG SCANDINAVIA
Kungsbacka - Sweden
Phone: +46 300 73 400
info-se@weg.net
www.weg.net/se

UK

WEG ELECTRIC MOTORS U.K.
Worcestershire - England
Phone: +44 1527 596 748
info-uk@weg.net
www.weg.net/uk

UNITED ARAB EMIRATES

WEG MIDDLE EAST
Dubai
Phone: +971 4 813 0800
info-ae@weg.net
www.weg.net/ae

USA

WEG ELECTRIC
Duluth - Georgia
Phone: +1 678 249 2000
info-us@weg.net
www.weg.net/us

ELECTRIC MACHINERY
WEG Group
Minneapolis - Minnesota
Phone: +1 612 378 8000
www.electricmachinery.com

VENEZUELA

WEG INDUSTRIAS VENEZUELA
Valencia - Carabobo
Phone: +58 241 821 0582
info-ve@weg.net
www.weg.net/ve

For those countries where there is not a WEG own operation, find our local distributor at www.weg.net.



Grupo WEG - Motors Business Unit
Jaraguá do Sul - SC - Brazil
Phone: +55 47 3276 4000
motores@weg.net
www.weg.net

