

EL-USB-4 4-20mA Current Loop USB Data Logger

ORDERING INFORMATION

Standard Data Logger (Data Logger, Software on CD, Battery)	EL-USB-4
Replacement Battery	BAT 3V6 1/2AA

FEATURES

- 4-20mA current loop measurement range
- Logging rates between 1s and 12hr
- Stores 32,510 readings
- Connection via two screw terminals
- USB interface for set-up and data download
- User-programmable alarm thresholds
- Status indication via red and green LEDs
- Supplied with replaceable internal lithium battery and Windows control software

This standalone data logger measures and stores up to 32,000 current loop readings over a 4-20mA measurement range. The user can easily set up the logging rate and start time, and download the stored data by plugging the data logger into a

PC's USB port and running the purpose designed software under Windows 2000, XP, Vista & 7. The data can then be graphed, printed and exported to other applications. The data logger is supplied complete with a long-life lithium battery. Correct functioning of the unit is indicated by a flashing red and green LED. The data logger features a pair of screw terminals and is supplied complete with a set of measurement leads terminating in crocodile clips.



Specifications	Minimum	Typical	Maximum	Unit
0-40mA d.c. measurement range	4		20	mA d.c.
Internal resolution		0.05		mA d.c.
Accuracy (overall error)		±1		% ±1count
Logging rate	every 1s		every 12 hr	-
Operating temperature range	-35 (-31)		+80 (+176)	°C (°F)
1/2AA 3.6V Lithium Battery Life		1*		Year

* depending on ambient temperature, logging rate and use of alarm LEDs.

EL-WIN-USB (CONTROL SOFTWARE)

Lascar's EasyLog USB control software is supplied free of charge with each data logger. Easy to install and use, the control software runs under Windows 2000, XP, Vista & 7. The software is used to set-up the data logger as well as download, graph and export data to Excel.

The software allows the following parameters to be configured:

- Logger name
- Logging rate (1s, 10s, 1m, 5m, 30m, 1hr, 6hr, 12hr)
- High and low alarms
- Start date and start time

The latest version of the control software may be downloaded free of charge from www.lascarelectronics.com

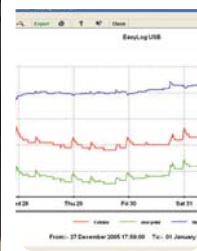

EL-USB-4











4-20mA Current Loop USB Data Logger

LED FLASHING MODES

EL-USB-4 features a red and a green LED.

By default hold is disabled. In this mode the red LED will no longer continue to flash after the logged reading has returned to normal from an alarm condition.

Hold can be turned on via the control software. In this mode the red LED that indicates an alarm condition will continue to flash, even after the logged reading has returned to normal. This feature ensures that the user is notified that an alarm level has been exceeded, without the need to download the data from the logger.

 <p>Green LED Red LED</p>		Green single flash (10 seconds) The data logger is currently logging. No alarm.
		Green single flash (20 seconds) The data logger is currently logging. No alarm. However, the battery is low and should be replaced before logging important data.
		Green single flash (30 seconds) The data logger is not currently logging, but is primed to start at a later date and time (delayed start).
		Green double flash (20 seconds) The data logger is full and has stopped logging. No alarm.
		Red single flash (10 seconds) The data logger is currently logging. Low alarm.
		Red single flash (20 seconds) The data logger is currently logging. Low alarm. However, the battery is low and should be replaced before logging important data.
		Red double flash (10 seconds) The data logger is currently logging. High alarm.
		Red double flash (20 seconds) The data logger is currently logging. High alarm. However, the battery is low and should be replaced before logging important data.
		Red/Green single flash (20 seconds) The data logger is full and has stopped logging. Alarm (high, low or both).
	No LEDs flash The data logger is stopped, the battery is empty or there is no battery fitted.	

EL-USB-4

4-20mA Current Loop USB Data Logger

DIMENSIONS

All dimensions in mm (inches)



CONNECTION AND APPLICATIONS

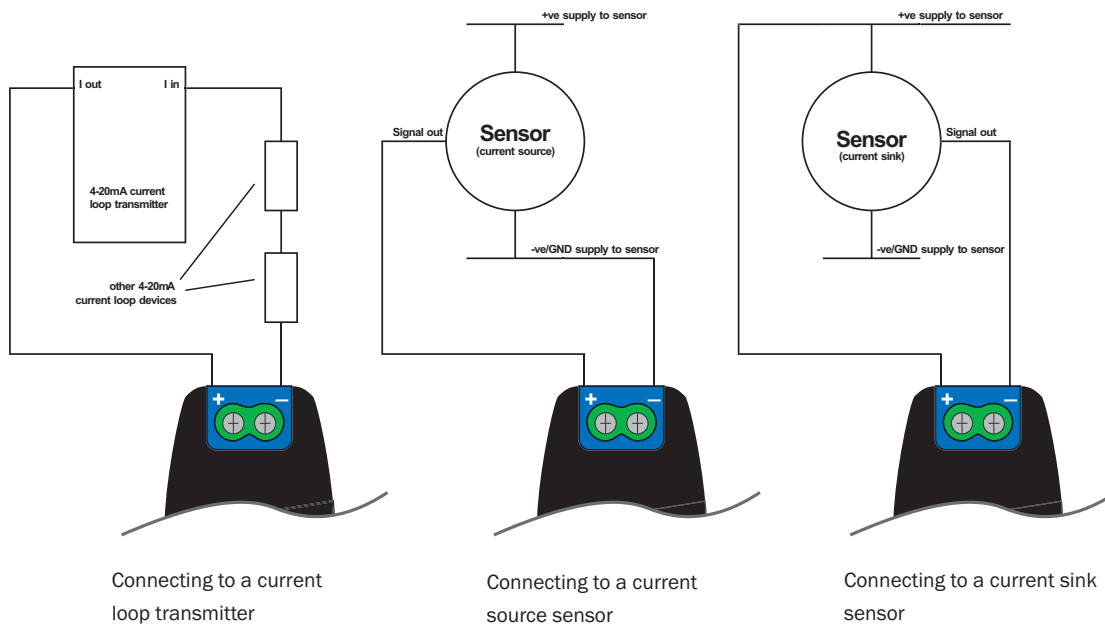

EL-USB-4

4-20mA Current Loop USB Data Logger

BATTERY REPLACEMENT

We recommend that you replace the battery every 12 months, or prior to logging critical data.

The EL-USB-4 does not lose its stored readings when the battery is discharged or when the battery is replaced; however, the data logging process will be stopped and cannot be re-started until the battery has been replaced and the logged data has been downloaded to a PC.

Only use 3.6V 1/2AA lithium batteries. Check with your supplier that the battery you are ordering is 'press fit' and is not fitted with solder tags. Before replacing the battery, remove the EL-USB-4 from the PC.

Note:

Leaving the EL-USB-4 plugged into the USB port for longer than necessary will cause some of the battery capacity to be lost.

WARNING

Handle lithium batteries carefully, observe warnings on battery casing. Dispose of in accordance with local regulations.

EL-USB-4

4-20mA Current Loop USB Data Logger

THE EASYLOG USB RANGE

Each EL-USB data logger features the direct-to-USB connection and easy-to-use functionality that the range is known for. The range comprises 14 data loggers as detailed in the following table:

Part No	Function	Range	Accuracy (overall error)		Readings	Battery	Battery Life*
			Typ.	Max.			
EL-USB-1	Temperature	-35 to +80 °C (-31 to +176 °F)	±1°C (±2°F)		16,382	3.6V ½AA	1 Year
EL-USB-1-PRO	High Temperature	-40 to +125 °C (-40 to +257 °F)	±0.2°C (±0.4°F)	±0.5°C (±1°F)	32,510	3.6V ¾AA	3 years
EL-USB-1-RCG	Temperature with rechargeable battery	-20 to +60 °C (-4 to +140 °F)	±1°C (±2°F)		32,510	Lithium Ion	1 month (rechargeable)
EL-USB-2	Temperature, humidity & dew point	-35 to +80 °C (-31 to +176 °F) 0 to 100%RH	±0.5°C (±1°F) ±3%RH	±2°C (±4°F) ±6.0%RH	16,382	3.6V ½AA	1 year
EL-USB-2+	Increased accuracy temperature, humidity & dew point	-35 to +80 °C (-31 to +176 °F) 0 to 100%RH	±0.3°C (±0.6°F) ±2.0%RH	±1.5°C (±3°F) ±4.0%RH	16,382	3.6V ½AA	1 year
EL-USB-2-LCD	Temperature, humidity & dew point with LCD	-35 to +80 °C (-31 to +176 °F) 0 to 100%RH	±0.5°C (±1°F) ±3.0%RH	±2°C (±4°F) ±6.0%RH	16,379	3.6V ½AA	1 year
EL-USB-2-LCD+	Increased accuracy temperature, humidity & dew point with LCD	-35 to +80 °C (-31 to +176 °F) 0 to 100%RH	±0.3°C (±0.6°F) ±2.0%RH	±1.5°C (±3°F) ±4.0%RH	16,379	3.6V ½AA	1 year
EL-USB-3	Voltage	0 to 30V d.c.	±1%		32,510	3.6V ½AA	1 year
EL-USB-4	Current loop	4 to 20mA	±1%		32,510	3.6V ½AA	1 year
EL-USB-5	Counter, Event & State	N/A		±3 secs/24 hrs	32,510	3.6V ½AA	1 year
EL-USB-TC	Thermocouple (J, K and T-type) K-type probe included	-200 to +1350°C (-328 to +2462°F) (K-type) -200 to +1190°C (-328 to +2174°F) (J-type) -200 to +390°C (-328 to +734°F) (T-type)	±1°C (±2°F)		32,510	3.6V ½AA	6 months
EL-USB-TC-LCD	Thermocouple with LCD (J, K and T-type) K-type probe included	-200 to +1350°C (-328 to +2462°F) (K-type) -200 to +1190°C (-328 to +2174°F) (J-type) -200 to +390°C (-328 to +734°F) (T-type)	±1°C (±2°F)		32,510	3.6V ½AA	6 months
EL-USB-CO	Carbon monoxide	0 to 1000ppm NOT A LIFE SAVING DEVICE	±6ppm		32,510	3.6V ½AA	3 months
EL-USB-CO300	Carbon monoxide	0 to 300ppm NOT A LIFE SAVING DEVICE	±4ppm		32,510	3.6V ½AA	3 months
EL-USB-LITE	Low cost temperature	-10 °C to +50 °C (+14 to +122 °F)	±1°C (±2°F)		4,080	CR1620 Lithium coin cell	1 month
EL-USB-RT	Real-time temperature & humidity monitor	-20 to +70 °C (-4 to +158 °F)	±1.5°C (±3°F) ±4.5%RH		7 days	N/A	N/A

*Depending on logging rate, ambient temperature, and use of alarm LED

T&C Plastics
10-B Timber Lane, Marlboro, NJ 07746
732-780-5300
www.tandcplastics.com