



TOWN & COUNTRY PLASTICS

Customized For Precision

10B Timber Lane, Marlboro, NJ 07746 • (732) 780-5300 • FAX: (732) 294-0001 • www.tandcplastics.com

NEW PRODUCT PREVIEW

ECP Series Glass Filled Polypropylene Electric Actuators

FOR BALL VALVES 1/2" - 6" AND BUTTERFLY VALVES 2" - 6"

KEY FEATURES AND BENEFITS

- Ideal for Corrosive Atmosphere and Environments
- Corrosion-Resistant GFPP Housing
- LED Status Light
- Anti-Condensation Heater
- Manual Override
- Position Indicator
- 4 SPDT Micro Limit Switches
- Lightweight - Easy for Installation
- ISO 5211 Mounting Base
- Stainless Steel Fasteners 303 SS
- 100% Factory Tested
- CE Mark

OPTIONS

- Digital Positioner 0-20mA, 4-20mA or 0-10V
- Battery Fail Safe Kit

SPECIFICATIONS

- Operation: 1/4 Turn
- Duty Rating: 75%
- Enclosure: NEMA 4/4X
- Protection: IP-67
- Voltage: Single Phase 120/230V and 12/24V
- Thermal Overload Protection
- Housing: GFPP (Glass Filled Polypropylene) per ASTM D4101 Cell Class 85580
- Output Shaft: 303 Stainless Steel per ASTM A314

AUTOMATED VALVES AND ACTUATORS



EXPLODED VIEWS

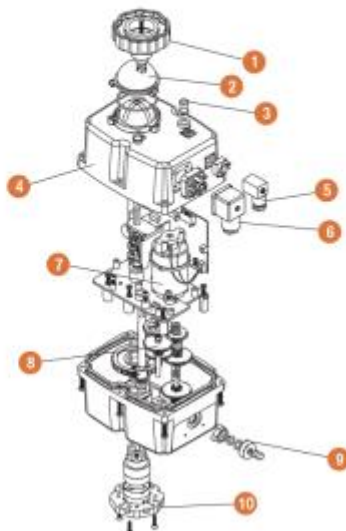

GFPP ECP Series Electric Actuators

FOR BALL VALVES 1/2" - 6" AND BUTTERFLY VALVES 2" - 6"

PARTS LIST

- | | |
|--------------------------------|-----------------------|
| 1. Manual Override | 6. Power Supply Plug |
| 2. Position Indicator Assembly | 7. Motor |
| 3. LED Indicator | 8. Gear Assembly |
| 4. Housing | 9. Manual/Auto Switch |
| 5. Auxiliary Plug | 10. ISO Multi Flange |

DIMENSIONS

MODEL	A in/mm	B in/mm	C in/mm	ISO PATTERN
ECP2	6.96/177	6.73/171	4.33/110	F05 X 14 mm
ECP3	6.96/177	6.73/171	4.33/110	F05 X 14 mm
ECP5	6.96/177	7.72/196	4.33/110	F07 X 14 mm
ECP8	6.96/177	7.72/196	4.33/110	F07 X 14 mm

ACTUATOR SPECIFICATIONS

	ECP2	ECP3	ECP5	ECP8
Torque Output (in/lbs/Nm)	221/25	359/40	530/60	796/90
Enclosure Material	Class Filled Polypropylene			
Output Shaft	303 Stainless Steel			
Cycle Time	11 sec.		14 sec.	30 sec.
Operating Temperature	4° F to 160° F/16° C to 71° C			
Weight (lbs/kg)	1.80/0.82	1.90/0.86	2.40/1.09	3.00/1.36

VALVE SELECTION CHART

VALVE TYPE	SIZE	ECP2	ECP3	ECP5	ECP8
TB Series Ball Valves	1/2"	•			
	3/4"	•			
	1"	•	•		
	1-1/4"	•	•		
	1-1/2"	•	•		
	2"	•	•	•	•
TW/LA Series Three Way Valves	2-1/2" - 3"	•	•	•	•
	4" - 6"	•	•	•	•
	1/2"	•			
	3/4"	•			
	1"	•	•		
	1-1/4"	•	•	•	
BYV Series Butterfly Valves	1-1/2"	•	•	•	
	2"	•	•	•	•
	2-1/2" - 3"	•	•	•	•
	4" - 6"	•	•	•	•
	2"	•			
	3"		•		
	4"			•	
	6"				•



Hayward is a registered trademark of Hayward Industries, Inc. © 2014 Hayward Industries, Inc.

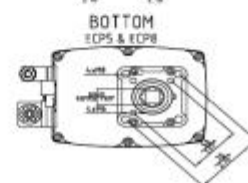
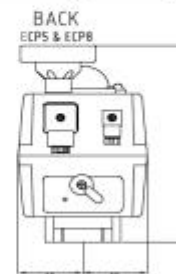
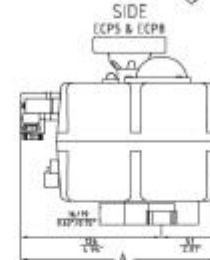
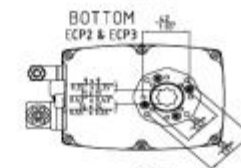
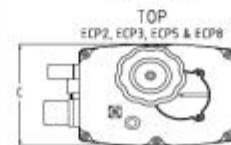
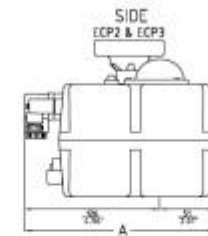

NPP1014