

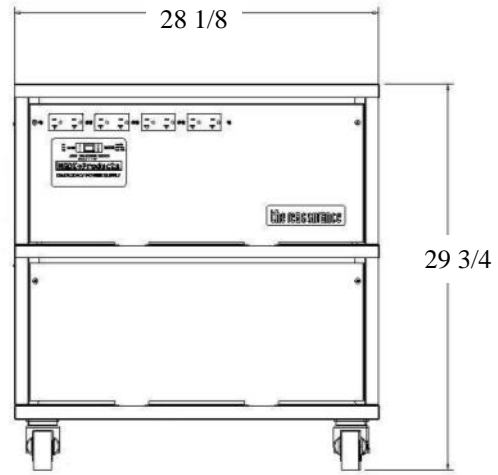

Model Number: M2020T



Specifications:

Electrical Input	120 volt 15 Amp male plug
Electrical Output (watts)	2000
Surge Output	4000 watts
Electrical Output (volts)	120 volts
Battery Capacity	200 amp hours
Number of Outlets	6 -15 amp & 2 -20 amp
Waveform	Modified
Physical Size	28.25 x 16.5 x 29.75
Approx. Shipping Weight	290 lbs

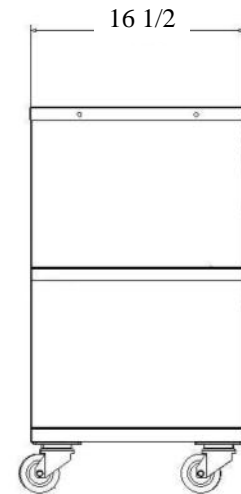

MEDI+PRODUCTS

BACK-UP POWER SYSTEMS

Products by Medicanix

30 Nurney Street
 Stamford, CT 06902
 203-348-2886 ph
 203-487-7423 fax
www.mediproducts.net
sales@mediproducts.net