

ExpertALERT™ Setup Guide for PdM



Triaxial Accelerometer

Triax Sensors Measures 3 Simultaneous Channels

1. Channel 1 in line with captive screw.
2. Channel 2 in direction of screw and alignment key.
3. Channel 3 is perpendicular to Channel 2.



A sensor attachment pad ensures collection repeatability while offering the highest quality data.

Note: Plastic caps will prolong the life of the attachment pad.

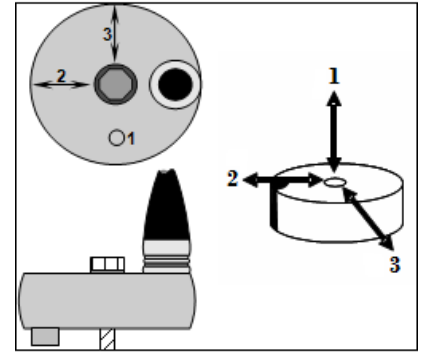

Selecting Test Locations

Selecting Test Locations

1. Sensor can be installed in a number of different ways.
2. Minimum of 1 location needed per machine component.
 - a. If >30" between bearings, each bearing should be monitored.
3. Location is established by counting each bearing from motor free end to driven free end (See Sensor Location Numbering).
4. Document sensor location & orientation for reference.
5. Be aware of vibration transmission path to sensor.
6. Location must be repeatable and easily accessible

Correct

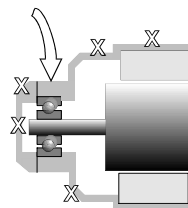

The accelerometer must be mounted as close to the bearing as possible, on solid metal foundation.

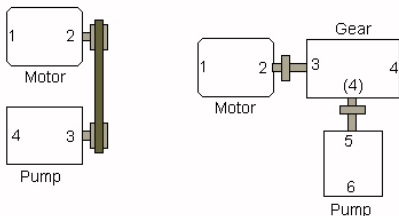
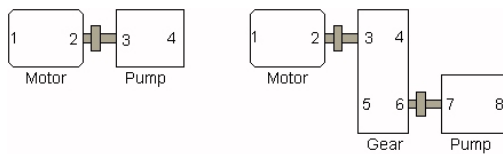
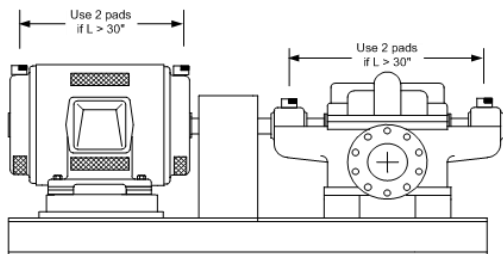

Sensor Location Numbering

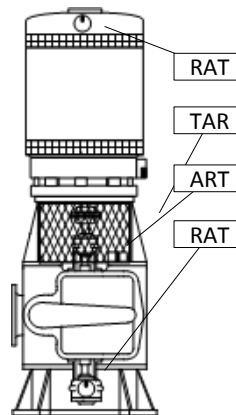

Vertical Machine

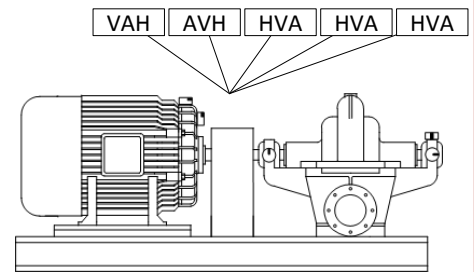

Horizontal Machine

ExpertALERT Directional Labeling as HVA, RTA, or ZXY

1. Must first understand orthogonal directions of machine.
2. Label relates to 3 channel inputs as they relate to the sensor mounting.
3. All machine components should follow consistent reference.
4. Horizontal machines general labeled Horizontal, Vertical, Axial labeling.
5. Vertical machines generally labeled Radial, Tangential, Axial labeling.
6. ExpertALERT allows for Z, X Y (channel 1, 2, 3) labeling if desired.

Sensors

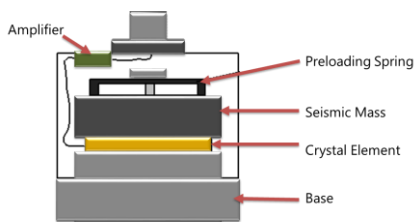

Single Axis Accelerometer

Connecting your sensor to machine

An accelerometer has a useful range based on the natural frequency of the crystal element, generally 8-10 KHz. However, the effective range of the sensor is diminished by the way the sensor is mounted. The highest quality data is through a stud mount.

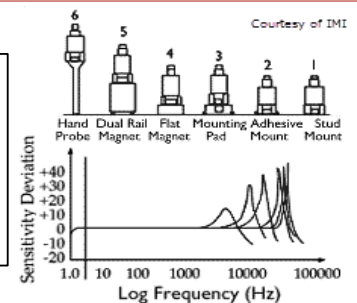



ALERT has three levels to the DB. There can be multiples of each. Organization can be based on physical location, process, etc. Users should consider ease of use for data collection and reporting when deciding.

- First Tier - PLANT, Company, etc.
- Second Tier - AREA, Process System, etc.
- Asset Tier - MACHINE, Asset, etc.
- Triaxial Test Location
- Process Point Location
- Calculated Process Point
- User Defined Point (IR, Oil, PDF, etc)

ALERT uses a Sybase Engine to manage the interface with the database.



ALERT Database Setup

To setup the ExpertALERT System, a Database Design Wizard will walk through the basic steps. After the first machine is created, it is important to follow the FINE TUNING steps to validate settings.

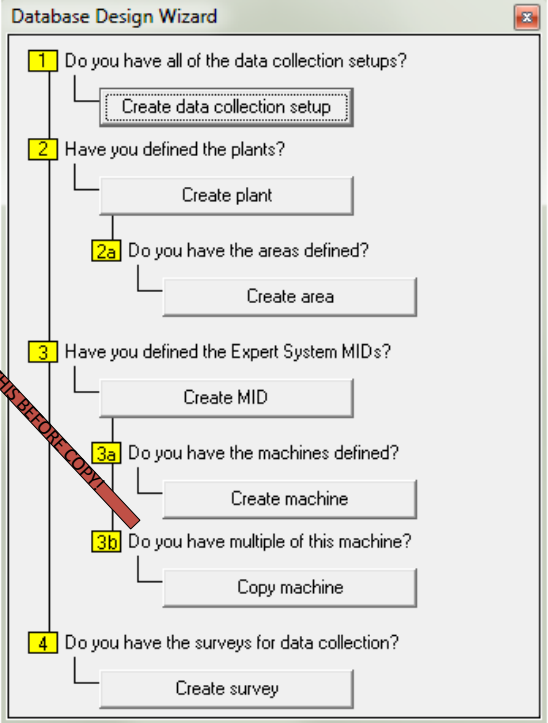

FINE TUNING THE MID / MACHINE FILE AFTER COLLECTING FIRST SET OF DATA

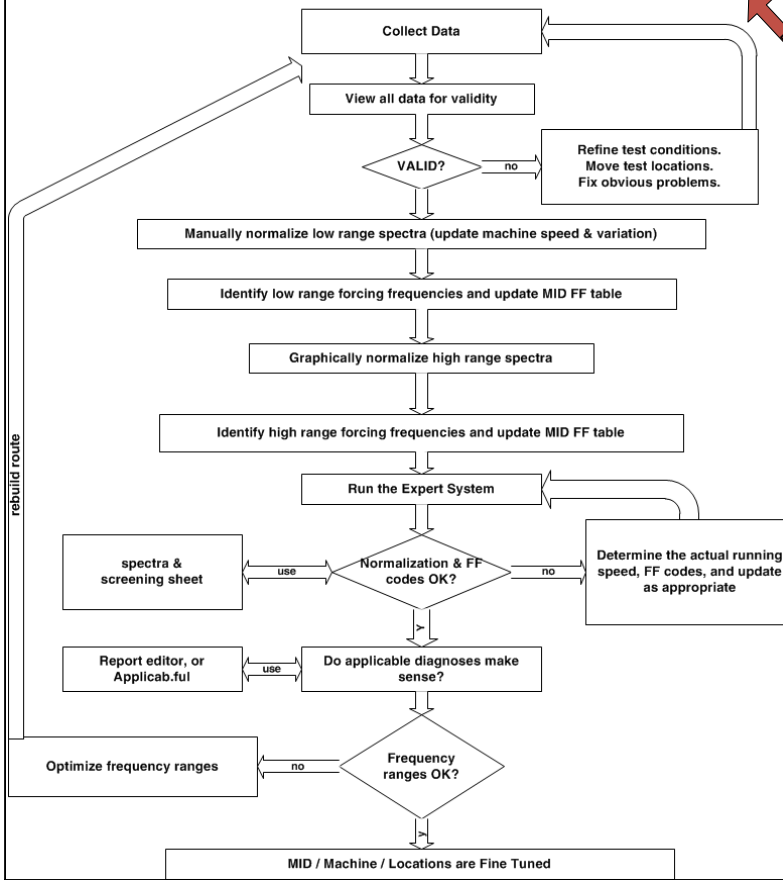

ExpertALERT uses a 500-line narrowband average plus 1 Sigma baseline to diagnosing machine fault conditions. Data added to the average should be consistent (+/- 5 db) as compared when overlaid.

Sample	1x in (VdB)	1x in (in/sec)
1	105	0.1
2	105	0.1
3	105	0.1
4	105	0.1
5	105	0.1
6	105	0.1
AVG	0.1	
Sigma	0.0	
Avg + Sigma	0.1	

Sample	1x in (VdB)	1x in (in/sec)
1	111	0.20
2	108	0.14
3	106	0.11
4	101	0.06
5	101	0.06
6	99	0.05
AVG	0.10	
Sigma	0.06	
Avg + Sigma	0.16	

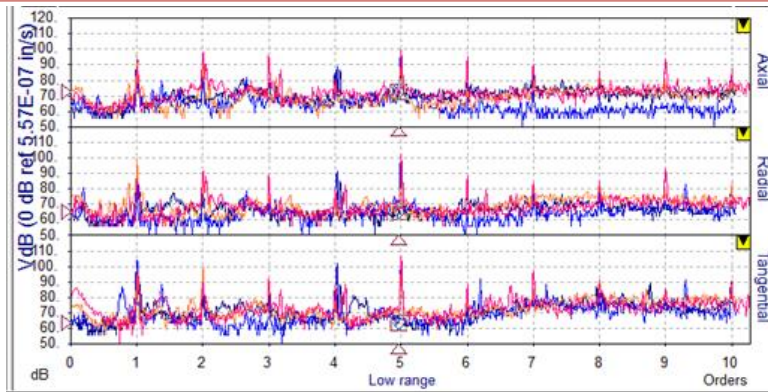

Overlay Data. Validate samples +/- 5 DB for inclusion into average baseline.

