

Pump 11 Elite & Pump 11 Pico Plus Elite

USER'S MANUAL



Harvard Apparatus Pump 11 Elite
& Pump 11 Pico Plus Elite Series

Publication 5420-002 Rev B

www.harvardapparatus.com

HARVARD
APPARATUS

phone 800.272.2775

email bioscience@harvardapparatus.com

Table of Contents

SUBJECT	PAGE NO.
General Information	6
Safety Information	6
Warranty and Repair Information	7
Manual Description	7
Warranty	7
Repair Facilities and Parts	7
Serial Numbers	7
Calibrations	7
Specifications	8
Product Overview	9
Pump Models	10
Pump 11 Elite Series Touch Screen Button Reference	11
Selecting an Item from a Menu List	12
Messages	12
Entering Values	12
Operating Instructions	13
Power Connections	13
Syringe Loading	14
Configuring the Pump 11 Elite Series	15
Method Selection	15
Syringe Selection	16
Flow Rate Selection	17
Target Volume/Time Selection	18
Previewing the Quick Start	19
Configuring the Pump's General Parameters	19
Setting the Audible Alarms	20
For Near End of Run Selection	21
For a Custom	21
Locking the Touch Screen	22

SUBJECT	PAGE NO.
Setting the Password	22
Turning the Touch Screen Lock on	22
Turning the Touch Screen Lock off	22
Setting the Force Limits	23
Setting Display Backlight	24
Setting the Pump Address	25
Setting the Baud Rate	25
Power-Up Running	26
Setting and Viewing Pump Information	26
Tilt	27
Operating the Pump 11 Elite Series	28
Running the Pump.....	28
Custom Method Workflow	29
Configuring Custom Methods	31
Configuring a New Custom Method	31
Configuring Custom Methods	32
Setting a Delay	33
Creating a New Custom Method	34
To Create a New User-Defined Method	34
Modifying an Existing/User-Defined Method	36
Changing the Order of Steps in a Method	36
Deleting a Step from a Method	36
Defining Method Step Parameters	36
Pump Operation Profiles	37
Constant Rate Profile	38
Ramp Profile	39
Gradient Profile.....	40
Autofill Cycling Profile	42
Incorporating Advanced Options Into a Method	43
Delay	44
Repeat Step	44
Stop	44

SUBJECT	PAGE NO.
I/O Event Triggers	45
I/O Trigger (OUT)	45
I/O Event (IN)	46
Managing Pump 11 Elite Series Methods	47
Saving a Copy of a Method	47
Renaming a Method	47
Appending a Method	47
Deleting a Method	47
Method Import and Export	48
Exporting a Method to an External Computer	49
Importing a Method from an External Computer	49
External Pump Control	50
Setting up HyperTerminal	50
Pump Chain Commands	51
Using the Pump 11 Elite Series Pump Chain Commands	51
Error Messages	52
Command Errors	52
Argument Errors	52
System Commands	52
Run Commands	54
Rate Commands	54
Volume Commands	55
Time Commands	56
Digital I/O Commands	57
Internal Commands	57
Serial Command Notes	57

SUBJECT	PAGE NO.
Appendices	58
Appendix A: Syringe Volume/Diameter Reference Table	58
Appendix B: Min/Max Flow Rates	59
Appendix C: External Connections	60
User I/O Connector Specifications	60
Utilizing USB Interface	61
RS-485	63
Legacy RJ-11 Option	64
Appendix D: Maintenance	65
Maintenance	65
Upgrading Pump 11 Elite Series Software	66
Troubleshooting	67
Appendix E: Ordering Information	68

General Information

SAFETY INFORMATION

Please read the following safety precautions to ensure proper use of your syringe pump. If the equipment is used in a manner not specified, the protection provided by the equipment may be impaired.

To Prevent Hazard or Injury:

USE PROPER POWER SUPPLY

The pump is supplied with an approved power supply and line cord. To maintain the safety integrity of the device, use only the following power supplies:

Cui Inc.

Model: 3A – 242DB24
Output: 24V – 1.0A
Input: 100–240V, 50–60 Hz 0.8A

Globtek Inc.

Model: GT–41062–T3
Output: 24V – 0.75A
Input: 100–240V, 50–60 Hz 0.6A

USE PROPER LINE CORD

Use only the specified line cord for this product and make sure line cord is certified for country of use. The operating voltage range for the Pump 11 Elite Series is 12-30 VDC. The universal power supply operating voltage range is 100-240 VAC, 50/60 Hz.

GROUND THE PRODUCT

This product is grounded through the grounding conductor of the power cord. To avoid electric shock, the grounding conductor must be connected to earth ground. Before making any connections to the input or output terminals of the product, ensure that the product is properly grounded.

MAKE PROPER CONNECTIONS

Make sure all connections are made properly and securely. Any signal wire connections to the unit must be no longer than 3 meters.

OBSERVE ALL TERMINAL RATINGS

Review the operating manual to learn the ratings on all connections.

AVOID EXPOSED CIRCUITRY

Do not touch any electronic circuitry inside of the product.

AVOID PINCH HAZARD

A pinch hazard may exist between the pusher block and end blocks. Avoid placing fingers between these points while the pump is running.

DO NOT OPERATE WITH SUSPECTED FAILURES

If damage is suspected on or to the product do not operate the product. Contact qualified service personnel to perform inspection.

ORIENT THE EQUIPMENT PROPERLY

Do not orient the equipment so that it is difficult to operate the disconnection device.

PLACE PRODUCT IN PROPER ENVIRONMENT

Review the operating manual for guidelines for proper operating environments.

OBSERVE ALL WARNING LABELS ON PRODUCT

Read all labels on product to ensure proper usage.



CAUTION
Refer to Manual



Protective
Ground Terminal

WARRANTY AND REPAIR INFORMATION



CAUTION: REFER TO SAFETY INFORMATION AND SETTING UP THE HARVARD APPARATUS PUMP 11 ELITE SERIES BEFORE PLUGGING IN THE PUMP.

Manual Description

This manual is designed to provide all operational and Method information required to operate and maintain the Pump 11 Elite Syringe Pumps. The functions and features are described in the Technical Specifications section.

Warranty

Harvard Apparatus warranties this instrument for a period of two years from date of purchase. At its option, Harvard Apparatus will repair or replace the unit if it is found to be defective as to workmanship or materials. This warranty does not extend to damage resulting from misuse, neglect or abuse, normal wear and tear, or accident. This warranty extends only to the original consumer purchaser.

IN NO EVENT SHALL HARVARD APPARATUS BE LIABLE FOR INCIDENTAL OR CONSEQUENTIAL DAMAGES. Some states do not allow the exclusion or limitation of incidental or consequential damages so the above limitation or exclusion may not apply to you. **THERE ARE NO IMPLIED WARRANTIES OF MERCHANTABILITY, OR FITNESS FOR A PARTICULAR USE, OR OF ANY OTHER NATURE.** Some states do not allow this limitation on an implied warranty, so the above limitation may not apply to you.

If a defect arises within the warranty period, promptly contact **Harvard Apparatus, 84 October Hill Road, Holliston, Massachusetts 01746** using out toll free number 1-800-272-2775 or outside the US call 1-508-893-8999. Email address is bioscience@harvardapparatus.com. Goods will not be accepted for return unless an RMA (returned materials authorization) number has been issued by our customer service department. The customer is responsible for shipping charges for non-warranty repairs. Please allow a reasonable period of time for completion of repairs or replacement. If the unit is replaced, the replacement unit is covered only for the remainder of the original warranty period dating from the purchase of the original device.

This warranty gives you specific rights, and you may also have other rights which vary from state to state.

Repair Facilities and Parts

Harvard Apparatus stocks replacement and repair parts. When ordering, please describe parts as completely as possible, preferably using a part number obtained from our Technical Support department. If practical, enclose a sample part or sketch. We offer a complete reconditioning service.

Serial Numbers

All inquiries concerning our product should refer to the serial number of the unit, located on the rear panel.

Calibrations

All electrical apparatus are calibrated at rated voltage and frequency. While the flow and volume will stay calibrated, the peak pressure may vary. Harvard Apparatus recommends an annual calibration of the pump.



CAUTION: FOR RESEARCH USE ONLY. NOT FOR CLINICAL USE ON PATIENTS.

Specifications	Pump 11 Elite	Pico Plus Elite
Accuracy	± 0.5%	± 0.35%
Reproducibility	± 0.05%	± 0.05%
Syringes (Min./Max.)	0.5 µl / 60 ml (10 ml dual)	0.5 µl / 10 ml
Flow Rate:		
Minimum (0.5 µl syringe)	1.28 pl/min	0.54 pl/min
Maximum (10 ml syringe)	25.99 ml/min	11.70 ml/min
Maximum (60 ml syringe)	88.28 ml/min	N/A
Display	4.3" WQVGA TFT Color Display with Touch Screen	4.3" WQVGA TFT Color Display with Touch Screen
Non-Volatile Memory	Stores all settings	Stores all settings
Connectors:		
RS-485	IEEE-1394, 6 pos	IEEE-1394, 6 pos
USB	Type B	Type B
I/O & TTL	15 pin D-Sub Connector	15 pin D-Sub Connector
Footswitch	mini phono jack	mini phono jack
Linear Force (Max)	16 kg (35 lbs) @ 100% Force Selection	16 kg (35 lbs) @ 100% Force Selection
Drive Motor	0.9° Stepper Motor	0.9° Stepper Motor
Motor Drive Control	Microprocessor with 1/16 microstepping	Microprocessor with 1/16 microstepping
Number of Microsteps per one rev. of Lead Screw	15,360	20,480
Step Resolution	0.069 µm/µstep	0.031 µm/µstep
Step Rate:		
Minimum	27.5 sec/µstep	27.5 sec/µstep
Maximum	26 µsec/µstep	26 µsec/µstep
Pusher Travel Rate:		
Minimum	0.15 µm/min	0.02 µm/min
Maximum	159.00 mm/min	71.55 mm/min
Input Power	12-30 VDC	12-30 VDC
Input Power Connection	2.5mm ID x 5.5mm OD male plug	2.5mm ID x 5.5mm OD male plug
Power Supply	100-240 VAC, 50/60 Hz, 8 Watts Universal Power Supply, Use Only a Harvard Apparatus Approved Power Supply and Line Cord	100-240 VAC, 50/60 Hz, 8 Watts Universal Power Supply, Use Only a Harvard Apparatus Approved Power Supply and Line Cord
Dimensions	22.6 x 17.78 x 15 cm (9 x 7 x 6 in)	22.6 x 17.78 x 15 cm (9 x 7 x 6 in)
Weight	2.1 kg (4.6 lbs)	2.1 kg (4.6 lbs)
Atmospheric Specifications:		
Operating Temperature	4°C to 40°C (40°F to 104°F)	4°C to 40°C (40°F to 104°F)
Storage Temperature	-10°C to 70°C (14°F to 158°F)	-10°C to 70°C (14°F to 158°F)
Humidity	20% to 80% RH, non condensing	20% to 80% RH, non condensing
Method of Operation	Continuous	Continuous
Classification	Class I	Class I
Pollution Degree	1	1
Installation Category	II	II
Supplier Name	Harvard Apparatus	Harvard Apparatus
Supplier Address	84 October Hill Rd., Holliston, MA 01746	84 October Hill Rd., Holliston, MA 01746
Supplier Phone Number	(508) 893-8999	(508) 893-8999
Regulatory Certifications	CE, ETL (UL, CSA), WEEE, EU RoHS & CB Scheme	CE, ETL (UL, CSA), WEEE, EU RoHS & CB Scheme
Safety Declarations	ANSI/UL 61010-1:2004 ED. 2 Rev. 2005 ; CAN/CSA C22.2 No. 61010-1:2004 Ed 2 ; IEC 61010-1:2001 Ed 2 Corrigendum 1:2002, Corrigendum 2:2003 ; CENELEC EN 61010-1:2001 ; CB Scheme	ANSI/UL 61010-1:2004 ED. 2 Rev. 2005 ; CAN/CSA C22.2 No. 61010-1:2004 Ed 2 ; IEC 61010-1:2001 Ed 2 Corrigendum 1:2002, Corrigendum 2:2003 ; CENELEC EN 61010-1:2001 ; CB Scheme
EMC Declaration	CENELEC EN 61326-1:2006	CENELEC EN 61326-1:2006

Product Overview

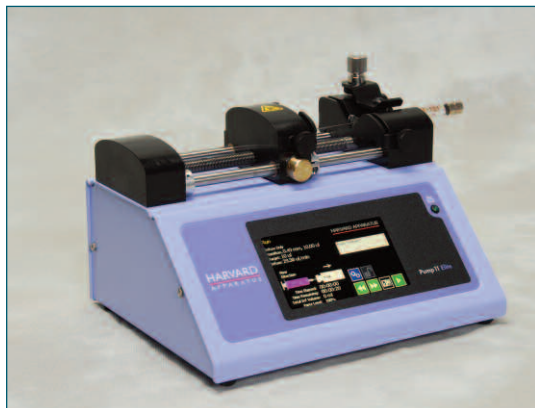

The Harvard Apparatus Pump 11 Elite Series is the next generation of syringe pumps. The series offers unparalleled ease of use through the high resolution color touch screen user interface. The full touch screen interface enables the user to quickly create configurations and recall them for easy use. The TFT color display presents all the pump operating parameters on an easy to view run screen. The touch screen “lock” feature prevents accidental configuration changes ensuring the Methods integrity is retained.

A green led light on the front panel makes it easy to see if the pump is running. Once the pump starts to run, the display shows the pumps is running and the LED turns on. This will make it easy to see the pump’s status.

The pumps are versatile and can be interconnected through the RS-485 interface. Pump 11 Elite Series models can be mixed and matched in the daisy chain offering maximum flexibility. Up to 99 pumps can be linked together through the RS-485 interface. This interface is easy to use provided each pump is assigned its own unique pump address.

For limited laboratory space the Pump 11 Elite Series can be placed on its side to reduce the footprint by 55%. The display can also be tilted to allow the user to operate the pump vertically.

Notifications and error messages are displayed for the user to acknowledge, eliminating any guesswork about problems.

Flow performance is optimized with a small step angle stepping motor that drives a precision lead screw and pusher block. The syringe mechanism is easy to use and securely holds the syringes for smooth flow performance.



Advanced microstepping techniques are employed to further reduce the step angle to eliminate flow pulsation. The accuracy is 0.5% (0.35% for Pico Plus Elite). A wide dynamic flow range from 1.28 $\mu\text{l}/\text{min}$ to 88.28 ml/min (0.54 $\mu\text{l}/\text{min}$ to 11.70 ml/min for the Pico Plus Elite) can be programmed into the pump. Flow rates are selectable with user selected engineering units from ml , μl , nl , pl , and hours, minutes and seconds.

Up to 16 kg (35 lbs) of linear force is available. This force is user adjustable to ensure the right force is applied for the various syringe sizes.

The spill dam is designed to prevent fluids from ingressing into the sealed display or electrical connections.

Easy external connections to a computer or other control devices are made through USB interface. Simple ASCII commands make communication with the pump easy. For direct control of the pump, the user can use the I/O interface (15pin Dsub). One trigger output and a trigger input in for external events such as a process parameter are available. The footswitch input will allow the control of the pump through an external device. The unit also has an output for run indication allowing connection to a remote LED.

The Basic and Programmable 11 Elite Pumps are available with single and dual syringe options. Complete flexibility is offered with the ability to use ANY manufacturers syringes ranging from 0.5 µl to 60 ml single syringe and 5 µl to 10 ml dual syringe.

The programmable models offer maximum flexibility and capability for configuring and running different Methods. Methods can be configured and stored in the unit, and recalled quickly with the touch of the screen. The Methods are identified with a 15 character alphanumeric name for easy identification and can be stored on the computer and downloaded at future dates. Extensive programming options allow the user to duplicate configurations, append one configuration to another, rename Methods, delete Methods, export Methods to a PC or export a Method to another pump. This feature can ensure consistency and accuracy of multiple pumps.

Preprogrammed profiles are selectable from Constant Rate, Ramp, Autofill and Gradient. These standard profiles make configuration easy to set up. If more complexity is needed the user can select from advanced Method programming options including:

- Time delays
- Repeating steps
- Stopping the pump
- Triggering the pumps TTL output
- Accepting an event input in such as a user touch or motor stall
- Events can trigger the pump to withdraw or infuse

The pump Information/settings screen shows the pump's software version, maintenance interval and pump address. The pump's alarm configurability includes alarms for near end of run (user selectable), completion of run, power up, keypad clicks and stall detection.

Pump Models

Infusion Only –

(single and dual syringe models): These two models support infuse only Quick Start Methods with user-defined flow rates and selectable target volume or target time values to control the total infusion time.

Infusion/Withdrawal Programmable –

(single and dual syringe models): These two models support infuse only, withdraw only, infuse/withdraw and withdraw/infuse Quick Start Methods with user-defined flow rates and selectable target volume or target time values to control the total infusion time. These models also support two user-defined Methods up to 50 steps each. Two Methods can be stored.

Pico Plus Infusion/Withdrawal Programmable –

(dual syringe only): Supports all four Quick Start Methods and two user-defined Methods up to 50 steps each.

PUMP 11 ELITE SERIES TOUCH SCREEN BUTTON REFERENCE

The following buttons are part of the Pump 11 Elite Series software:



Settings: Access the settings menu used to adjust the following parameters: Audible Alarms, Pusher Block Force, Backlighting, Baud Rate, etc.



Fast Forward: Advances the Pusher Block in the forward (infuse) direction.



Fast Reverse: Advances the Pusher Block in the reverse (withdraw) direction.



Accept: Used to accept the parameters/settings on a screen and advance to next screen in the menu.



Cancel: Used to cancel any changes/entries on a screen and return to the previous screen in the menu.



Back: Used to go back one screen.



Set Delay Parameters: Used to set the time values for delayed operation. This permits the pump to start automatically after a preset time.



Set Delay Parameters: Indicates the Delay Timer has been set. The pump will start automatically after the preset delay expires.



Run Preview: Access the Method Preview screen that shows a summary of steps and operating parameters.



Run/Resume: Used to Run or Resume a Method.



Re-Run: Clears counters/timers and runs the selected Method from the beginning.



Stop: Used to stop running a Method.



Clear: Clears the counters/timers.



Minimum Value Allowed: Used to select minimum value allowed.



Maximum Value Allowed: Used to select maximum value allowed.



Page Down: Used to page down in a display list.



Page Up: Used to page up in a display list.



Scroll Up: Used to scroll up in a display list.



Scroll Down: Used to scroll down in a display list.



Insert Step: Used to insert a new Step in a Method while editing/creating the Method. The new Step is inserted after the Step that is currently selected.



Delete Step: Used to delete the selected Step in a Method while editing/creating the Method. To confirm deletion, you must select the Delete Step button a second time.



Move Step Up: Moves the currently selected Step in a Method up one position in the Method Order (e.g. Step 3 becomes Step 2).



Move Step Down: Moves the currently selected Step in a Method down one position in the Method Order (e.g. Step 2 becomes Step 3).



Copy Step: Creates a duplicate (copy) of the currently selected Step in a Method and inserts it as the last Step in the Method being created/edited.



Touch Screen Unlocked: Indicates that the Pump is unlocked. Pressing the button twice locks the touch screen.



Touch Screen Locked: Indicates that the Pump set-up screens are locked from editing. Press the button and enter password to unlock the touch screen.



File Options: Access the File Options menu that is used to manage the list of Methods and to export Method information to an externally linked pump or to a connected computer.

Selecting An Item From a Menu List

Selecting items is easy with the Pump 11 Elite Series.

Touch the item to select/highlight the item, then touch again to accept it or press 

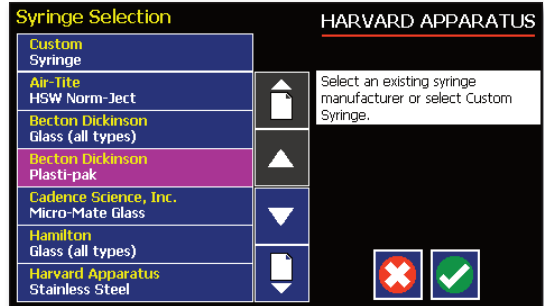

Canceling a Selection

Canceling selections is easy.

Press 

Messages

There are different types of messages. Error messages are shown in yellow.

- Critical
- Run--mode
- Method
- Settings

Notices, alarms, confirming, and verified messages are show in green.

- Alarms
- Confirm
- Verified

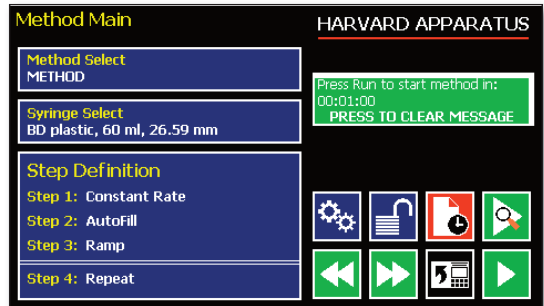
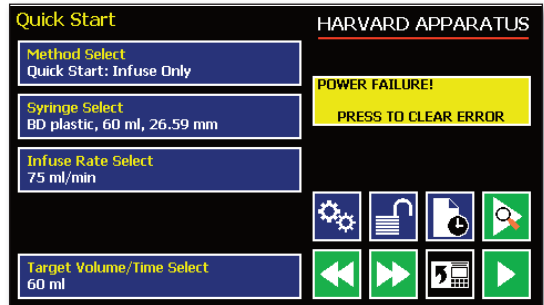

Entering Values

Entering new values is easy.

Use the keypad to enter the number

Backspace key

Decimal point

Cancel and go back to the previous screen.

Accept the value and go back to the previous screen.

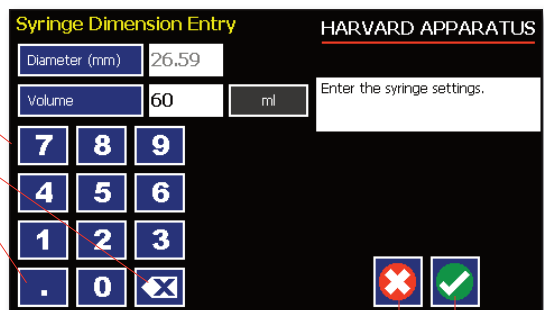

OPERATING INSTRUCTIONS

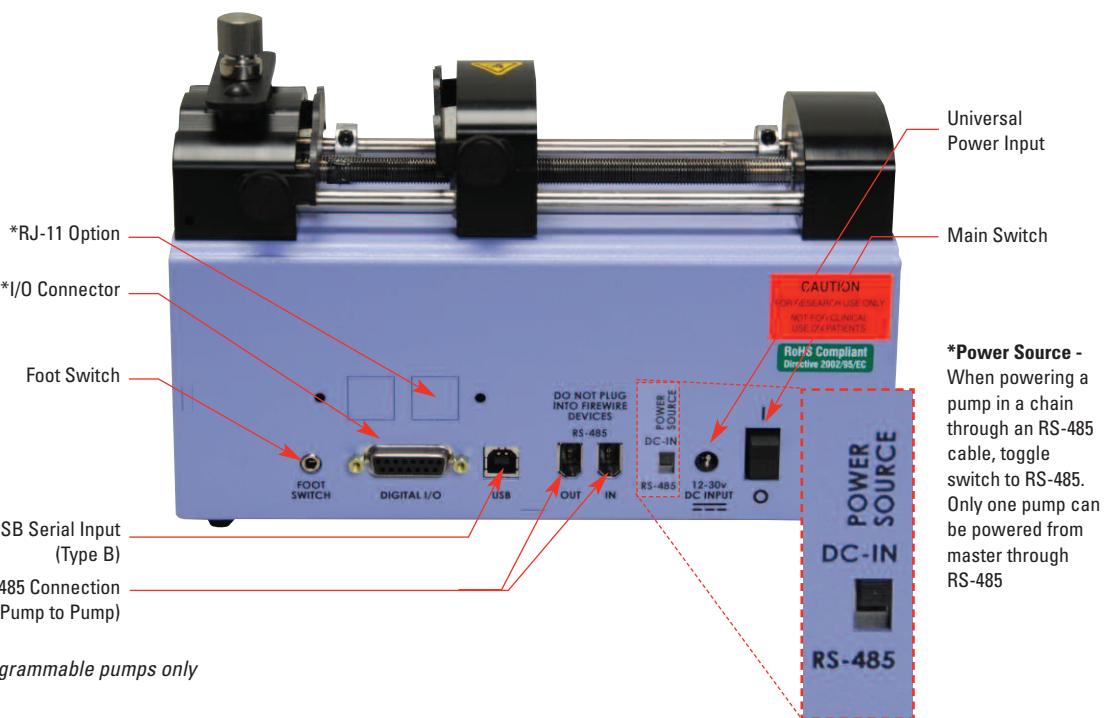
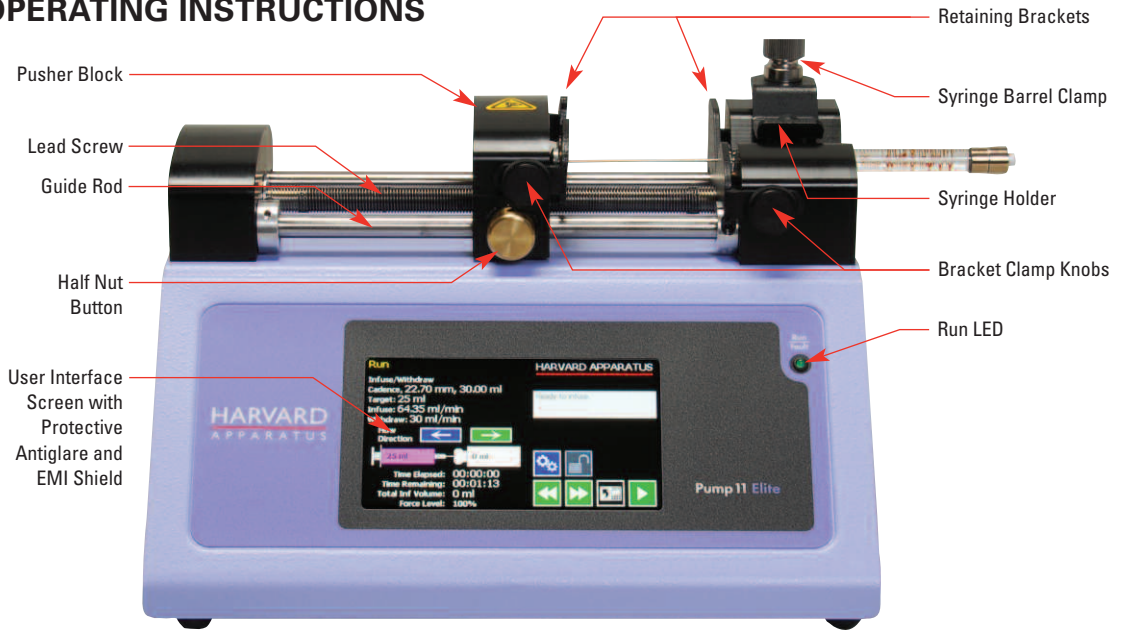

* Programmable pumps only

***Power Source -**
When powering a pump in a chain through an RS-485 cable, toggle switch to RS-485. Only one pump can be powered from master through RS-485

POWER CONNECTIONS

1. Plug the power cord in. The Pump 11 Elite Series has a universal power input connector on the rear of the unit. The operating range for the Pump 11 Elite Series series is 12-30 Vdc.
2. Turn on the main power switch.

NOTE Best performance guaranteed when using 24V power supply.

CAUTION: DO NOT CONNECT TO FIREWIRE PORTS ON A COMPUTER. DAMAGE MAY OCCUR TO THE PUMP OR COMPUTER.

SYRINGE LOADING

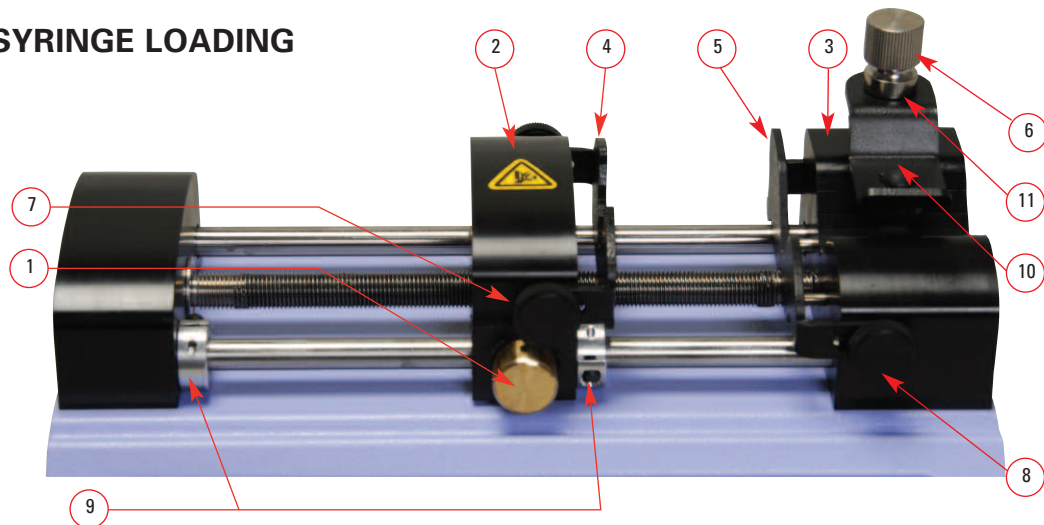

The Pump 11 Elite Series can accommodate up to two syringes. Depending on the mechanism, any type of syringe, glass, plastic or stainless steel can be used. The Pump 11 Elite can accommodate from 0.5 μ l to 60 ml single syringe and 0.5 μ l to 10 ml dual syringe. The syringe barrel clamp should be flipped for syringes smaller than 30 ml. For syringes larger than 30 ml the syringe clamp should be used as shown.

1. Press the release button (1) and move the pusher block (2) to the approximate length of the syringe.
2. Unscrew the bracket clamping knobs (7,8) to loosen the retaining brackets (4,5) on the pusher block (2) and the Syringe holder block (3).
3. Unscrew the syringe barrel clamp by unscrewing the syringe barrel clamp knob (6).
4. Place the syringe on the syringe holder block (3). Ensure the barrel flange is with in the syringe holder's block's retaining bracket (5) and the plunger flange is in the pusher block's retaining bracket.

*The Pico Plus Elite can accommodate from 0.5 μ l to 10 ml.

5. Screw down the syringe clamp knob (6) until the syringe barrel clamp (10) is tight against the syringe barrel. Do not overtighten, especially when using glass syringes.
6. Secure the syringe flanges by pushing the retaining brackets (4,5) tightly against the syringe flanges using the bracket clamping knobs (7,8). The syringe plunger should be secured by the pusher block retaining bracket and the flange of the syringe should be secured by the syringe holder block retaining bracket.
7. Tighten the mechanical stop collars (9) using allen wrench (12) to prevent excess travel of the pusher block.

NOTE

The syringe barrel clamp (10) may need to be flipped depending on your syringe size. To do so, completely unscrew and remove the syringe barrel clamp knob from the syringe block. Then remove lock nut (11). Flip the bracket and reassemble.

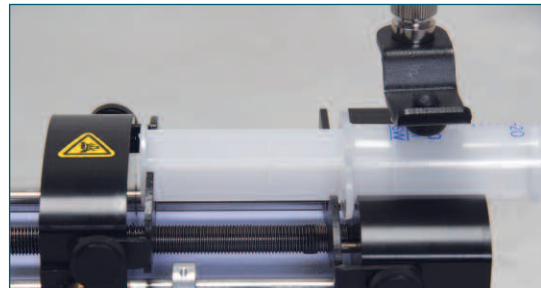
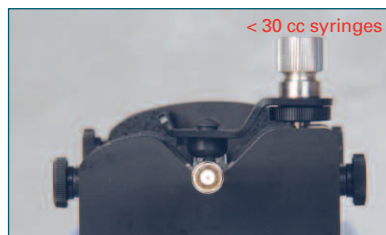

CAUTION: BE SURE MECHANICAL STOP COLLARS ARE POSITIONED PROPERLY TO PREVENT THE PLUNGER FROM BOTTOMING OUT ON GLASS SYRINGES.

Configuring the Pump 11 Elite Series

A Method is easy to set up.

The Pump 11 Elite Series is easily configured. When the unit is powered up, the Quick Start Screen will be displayed.

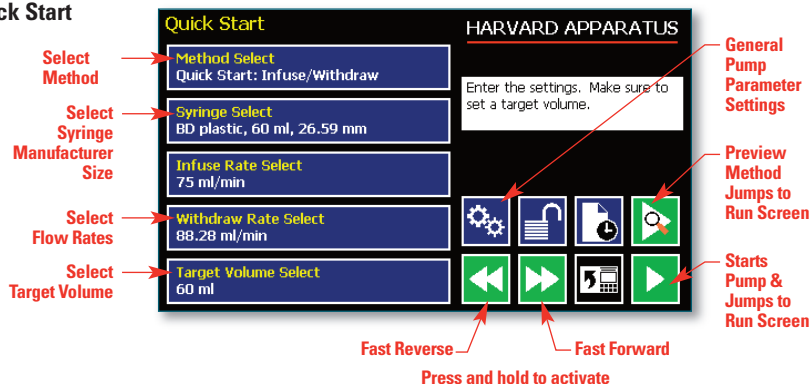

Method Selection

In the Quick Start Screen select Method (available Methods depend on the pump model)

- Infuse Only
- Withdraw Only
- Infuse/Withdraw
- Withdraw/Infuse
- Custom Method

The Method Selection Screen will be displayed. The available Methods will be displayed based on the model of syringe pump.

Press the Method to select

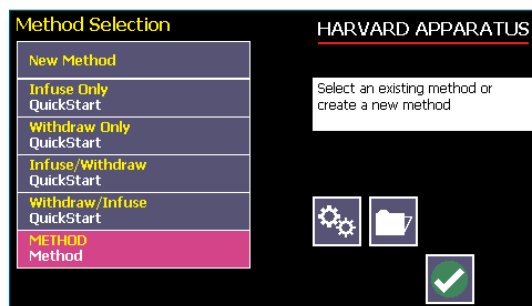
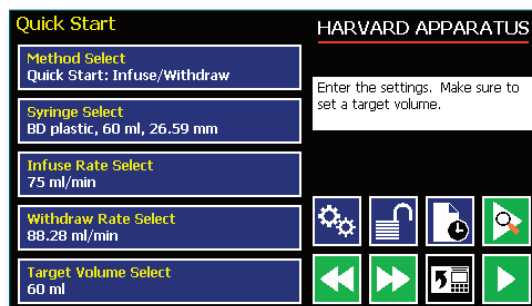

Syringe Selection

1. In the **Quick Start Screen** select the syringe button.

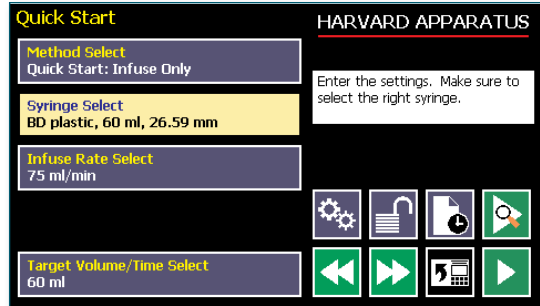

2. Select the manufacturer type. Then the available syringe sizes will be displayed. In this example we have selected a Becton Dickinson Syringe.

Press →

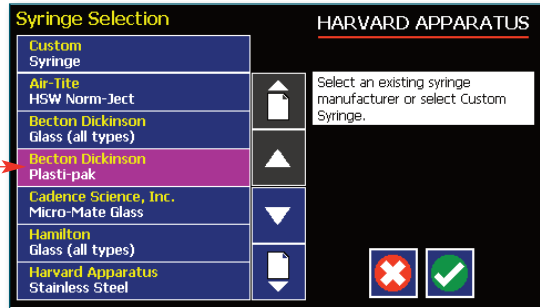

3. For a Custom Syringe use this selection if syringe manufacturer is not listed.

Press to enter a custom syringe

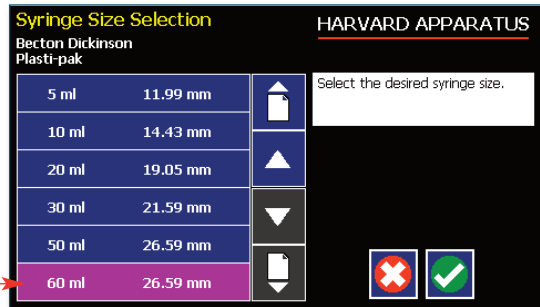

Press →

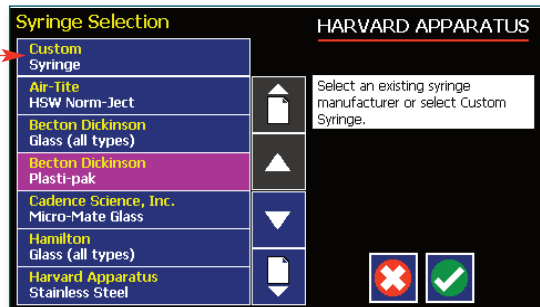

Custom Syringe Definition Display

Press to enter the inside diameter of the syringe
 Press to enter the total syringe volume
 Press to change the units (µl, ml)

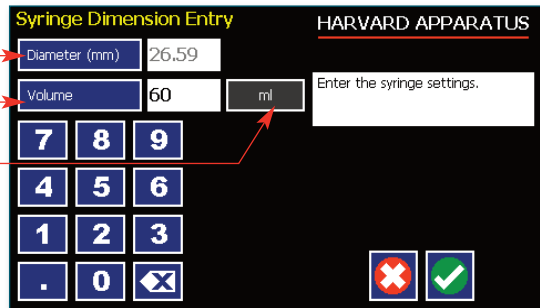

CAUTION: BE SURE TO LOWER THE FORCE VALUE WHEN USING GLASS SYRINGES.

Flow Rate Selection

1. In the **Quick Start Screen** enter the flow rate(s). In this example we want to enter 75 ml/min.

Press →



2. Depending on the Method, the appropriate set rate screen will be displayed. To change the units, press the units.

Enter the flow rate →

Press to change the units →

Press to select the maximum flow rate for the syringe size selected

Press to select the minimum flow rate for the syringe size selected

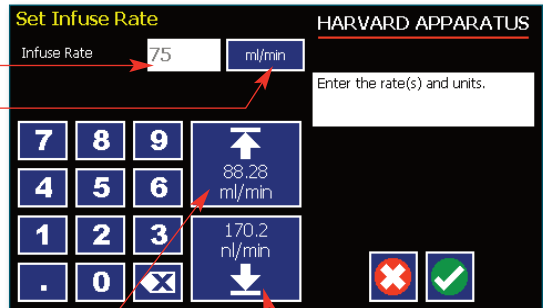

3. In the **Units Selection Screen** select the volume and the time base.

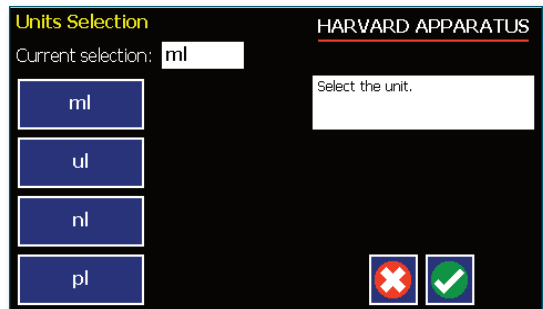

Target Volume/Time Selection

1. In the **Quick Start Display** enter the target volume or time. In this example we want a volume of 60 ml.

NOTE Target time is only allowed in infuse only or withdraw only Methods.

2. Depending on the Method either Target Volume (I/W or W/I) will appear or Target Volume or Target Time Selection (I only or W only).

NOTE For time enter h:m:s. or press again to select secs. Time is accurate to ± 0.01 secs. Remember to enter the :

3. To change the units, press the units.

Press to select target volume

Press to select target time

Press to select the maximum volume for the syringe size selected

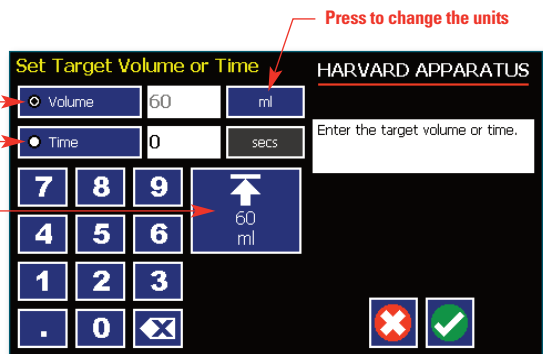
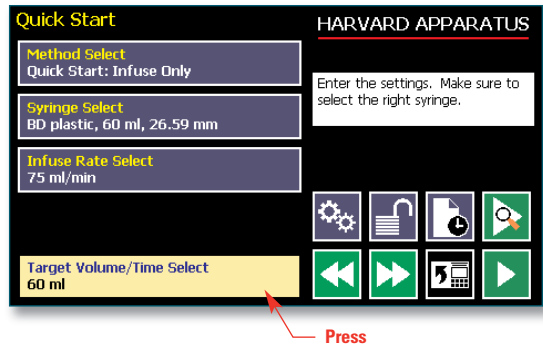

4. In the **Units Selection Screen** select the volume units.

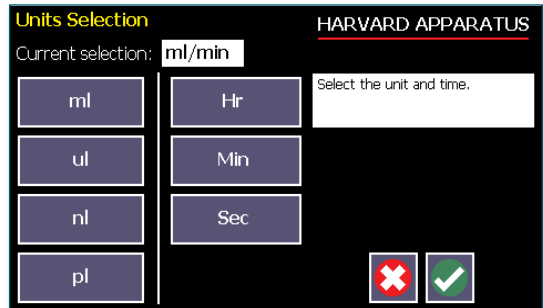

Previewing the Quick Start

It is simple to view the Pump Quick Start on the RUN display.

Press  to view Pump Quick Start

After you have verified the configuration.
Press  to run the displayed configuration.



Press to preview configuration

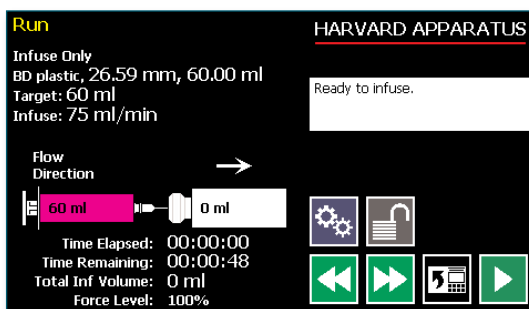

Configuring the Pump's General Parameters

The pump has basic parameters that should be configured during initial start-up. Once these parameters are entered they probably won't be changed.

To enter the settings screen press 

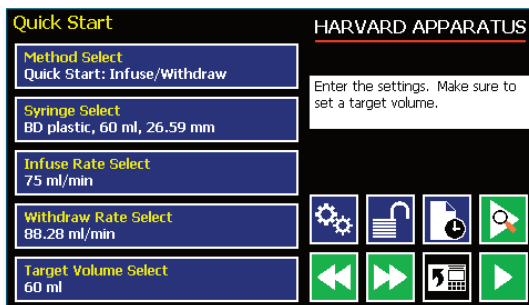

Setting the Audible Alarms

In the Settings screen , press **Audible Alarms**.

Select the alarms, a check mark will indicate the alarms selected.

If these alarms are selected the pump will provide an audible alarm.

Accept the changes made by pressing and go back to the Settings screen.



Cancel the changes made by pressing and go back to the Settings screen.

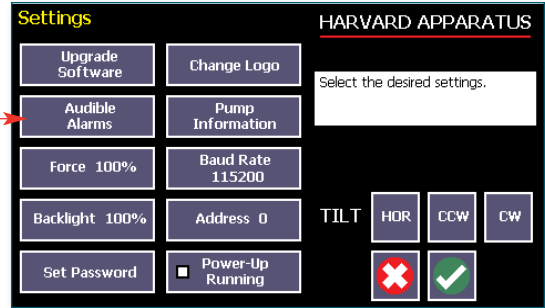

Power Up – Alarm when pump is power cycled while running

Keypad Clicks – When the keypad is touched the unit will provide audible feedback

End of Run – Alarm when the Method is finished

Stall – Motor stalls

Near End of Run – When the volume dispensed is reached for the specified %

Mute All – No audible sounds

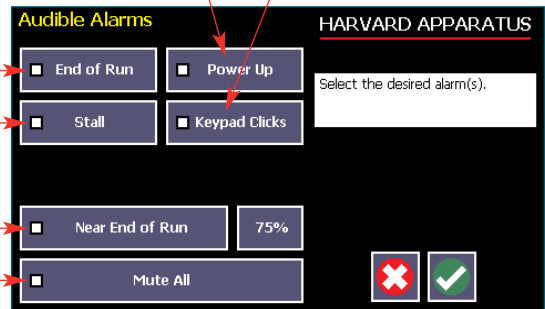

For Near End of Run Selection

Select the % volume dispensed. For example, if you select 80%, the pump will sound an alarm (3 short beeps) when 80% of the volume is dispensed.

Accept the changes made by pressing  and go back to the Settings screen.

Cancel the changes made by pressing  and go back to the Settings screen.

Press to select % volume dispensed

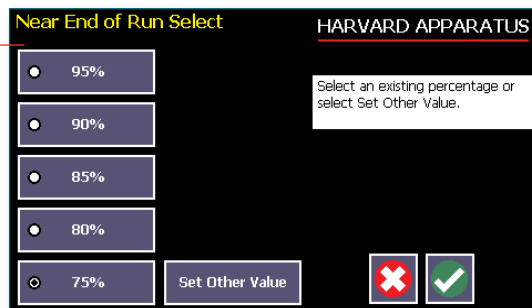

For a Custom %

Use this selection if the % is not listed.

Press **Set Other Value** to enter a custom %

Enter the percentage.

Accept the changes made by pressing  and go back to the Settings screen.

Cancel the changes made by pressing  and go back to the Settings screen.

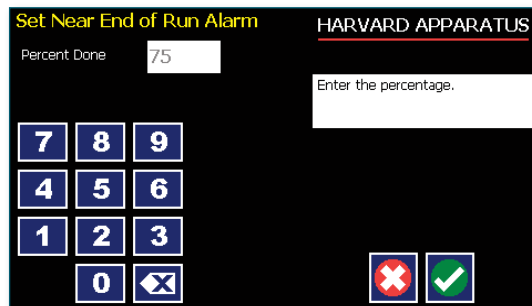
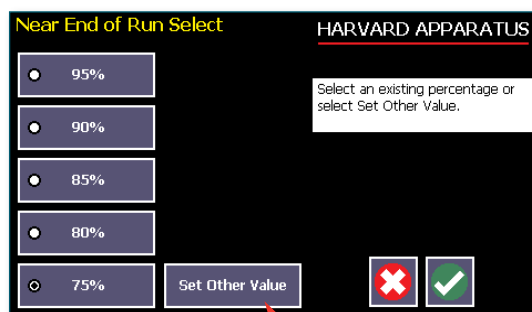

Locking the Touch Screen

A touch screen lock function can be enabled to prevent accidental operation or interruption of operation. Unlocking the touch screen requires a password, defined by the user.

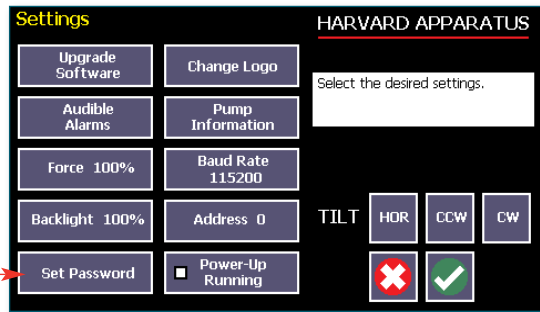

Setting the Password

To set the Password go to the Settings screen. Press the Set Password button.

Enter your desired password, up to 8 digits, and press the "ACCEPT" button.

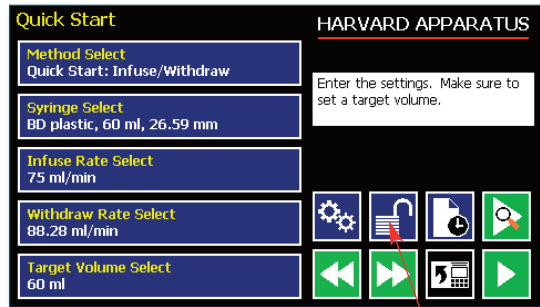

Turning the Touch Screen Lock On

Press the Lock button twice to lock the touch screen.

Turning the Touch Screen Lock Off

Press the "LOCK" button to bring up the Enter the Pump Password screen.

Enter your password and press the "ACCEPT" button.

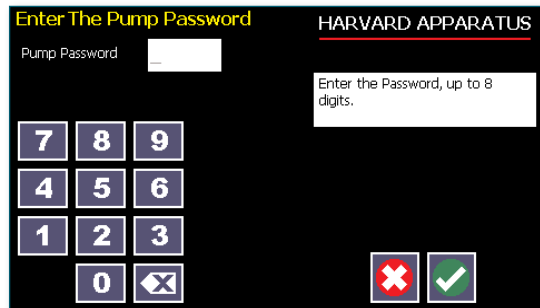

NOTE

If you forget your password contact Harvard Apparatus Technical Support at 508-893-8999.

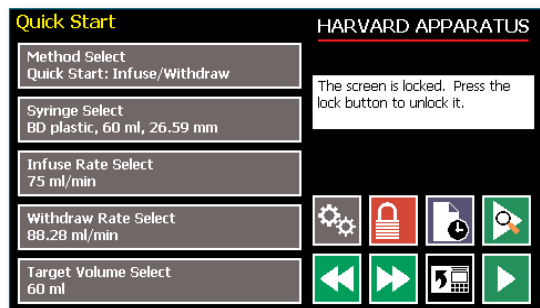

Setting the Force Limits

The maximum linear force of the syringe pump is 35 lbs or 16 kgs. This force is sufficient to damage delicate, low volume syringes, as well as many standard syringes if pumping viscous fluids. The % of maximum force applied by the pusher block can be changed.

In the settings screen, press **Force**.

NOTE A minimum value of approximately 20% is required to overcome friction forces in the mechanism. You may have to set the force level to a higher value depending on the back pressure/friction in your system.

Set the **Force Level**.

Select the Force Level %

Accept the changes made by pressing and go back to the Set Force screen. 

Cancel the changes made by pressing and go back to the Set Force screen. 

For a Custom Force %

Press **Set Other Value** to enter a custom force %

Enter the percentage

Accept the changes made by pressing and go back to the Set Force screen. 

Cancel the changes made by pressing and go back to the Set Force screen. 

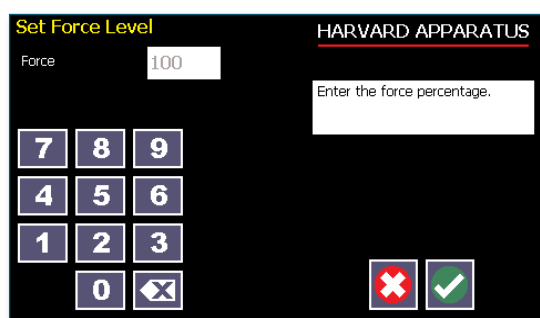
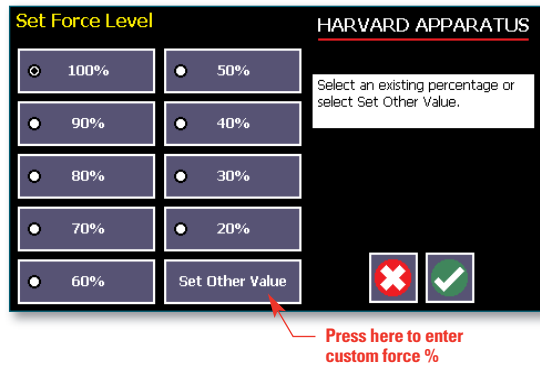
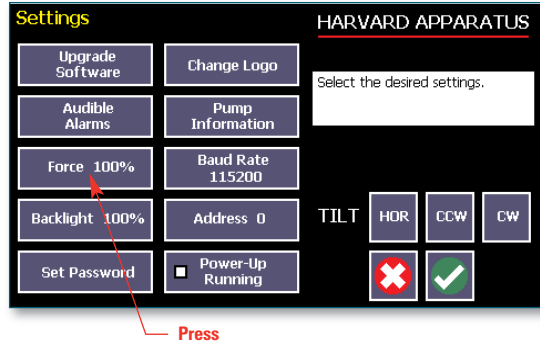

Suggested Force Level Settings for Common Syringes			
Syringe Type/Material	Capacity	Force Setting	Common Manufacturer(s)
Plastic Syringes	≤20ml	50%	BD plastic, Sherwood, Airtite, Terumo
	>20ml	100%	
Stainless Steel	All	100%	Harvard Apparatus
Glass/Glass	≤20ml	20%	Cadence (Popper)
	>20ml	30%	
Glass/Plastic	≤1000µl	30%	Hamilton, SGE
	≤5ml	50%	
	>5ml	100%	

NOTE The Pump 11 Elite can accommodate syringes ranging from 0.5 µl to 60 ml single syringe and 0.5 µl to 10 ml dual syringe.

NOTE The Pico Plus Elite can accommodate syringes ranging from 0.5 µl to 10 ml.

Setting Display Backlight

The backlight can be adjusted.

In the Settings screen, select **Backlight**

Select the % Backlight. For example, if you select 80%, the brightness of the display will be 80% of the maximum.

Accept the changes made by pressing  and go back to the Settings screen.

Cancel the changes made by pressing  and go back to the Settings screen.

For a Custom Value

Use this selection if the % is not listed.

Press **Set Other Value** to enter a custom %

Enter the percentage.

Accept the changes made by pressing  and go back to the Settings screen.

Cancel the changes made by pressing  and go back to the Settings screen.

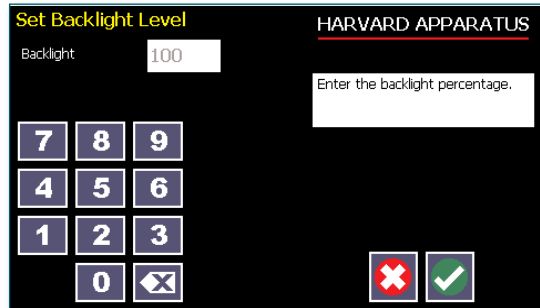
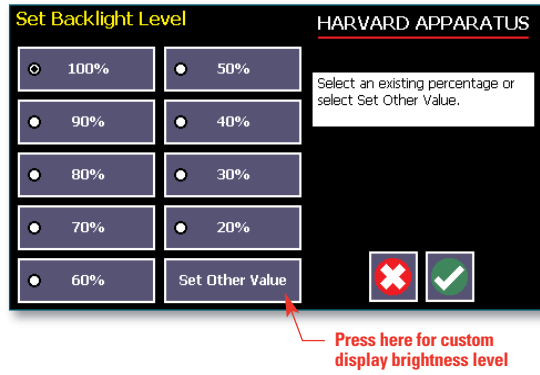
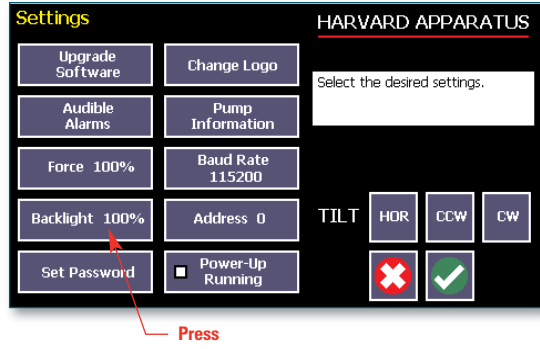

Setting the Pump Address

Up to 100 pumps can be linked together. Each pump can be given a unique address.

In the **Settings Screen** press **Pump Address**.
Valid entries are 00 to 99.

Enter the pump address.

Accept the changes made by pressing and go back to the Settings screen. 

Cancel the changes made by pressing and go back to the Settings screen. 

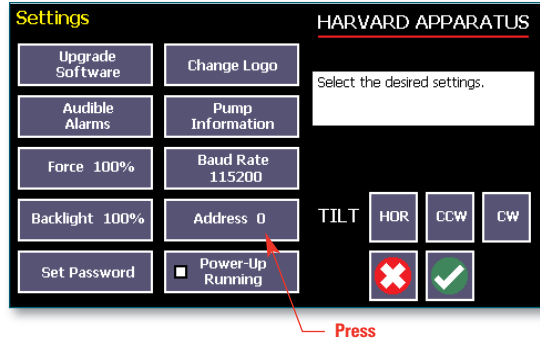

Setting the Baud Rate

The Pump 11 Elite Series have an RJ-11 option for serial communications.

To adjust the baud rate from 9600 to 115,200 in the **Settings screen** press **Baud Rate**

Select the Baud Rate.

Accept the changes made by pressing and go back to the Settings screen. 

Cancel the changes made by pressing and go back to the Settings screen. 

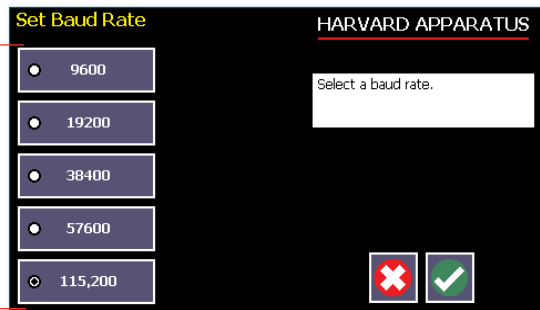
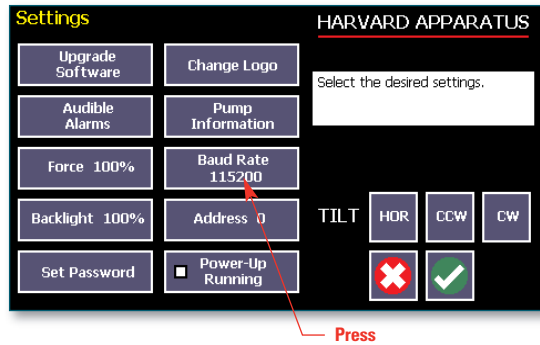



Press here to select Baud Rate

Power-Up Running

If Power-Up Running is selected the pump will power up running when power resumes.

In the Settings screen, select Power-Up Running

-  **Accept** the changes made and go back to the previous screen before Settings Method was selected.
-  **Cancel** and go back to the previous screen before Settings Method was selected.

NOTE This feature is only valid in Infuse Only or Withdraw Only Methods. This feature will only execute if the pump is running at the time when power is lost, and was running with no target set.

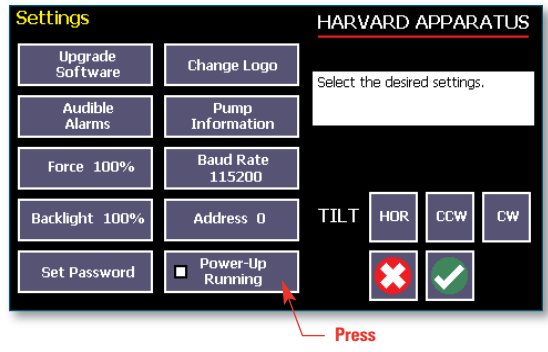

NOTE Elapsed Timers and Total Infused Volume will be reset when power resumes. Counters and timers information prior to loss of power are lost

Setting and Viewing Pump Information

The information on the pumps parameters are displayed in the Pump Information Screen.



In the Settings screen, select Pump Information

The current information on the pump will be displayed.

- The Model type
- The Software Version
- The Maintenance Due
- The Current Pump Address

Press **Maintenance Reset** to reset the # of hours for maintenance. This will reset it to 100 hours.

Confirm the Maintenance Reset by pressing the Maintenance Reset again.

-  **Accept** the changes made by pressing and go back to the Settings screen.
-  **Cancel** the changes made by pressing and go back to the Settings screen.

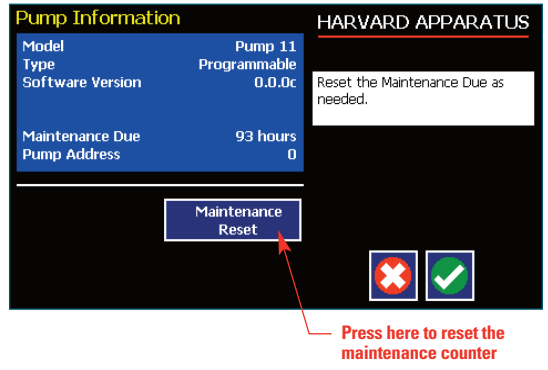
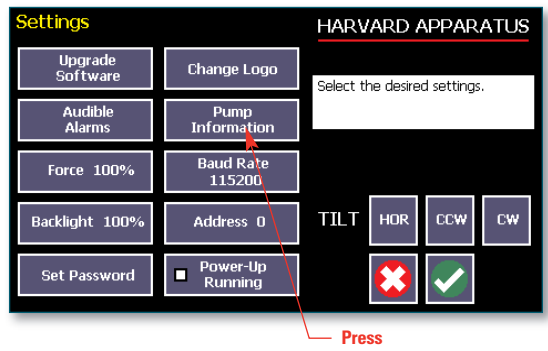

NOTE Free RTOS v6.0.1 (www.freertos.com)

Tilt

The touch screen can be tilted for ease of use when the pump is placed on its side.

In the Settings screen:

Press  to rotate the touch screen counter-clockwise.

Press  to rotate the touch screen clockwise.

Press  to return the touch screen to its original orientation.

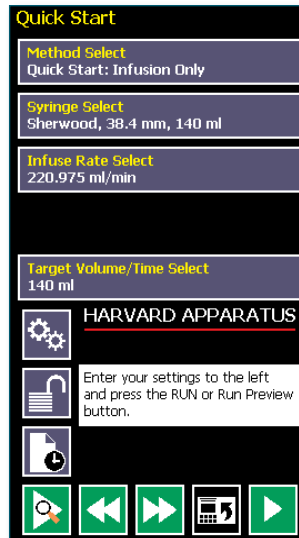
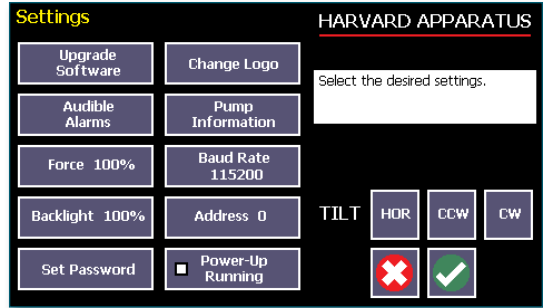

Operating the Pump

The Pump 11 Elite Series is easy to operate because all the pump parameters are shown on the RUN Screen. Depending on the Method of the pump, different parameters will be shown on the display.

The Pump 11 Elite Series Run Screen is shown below.

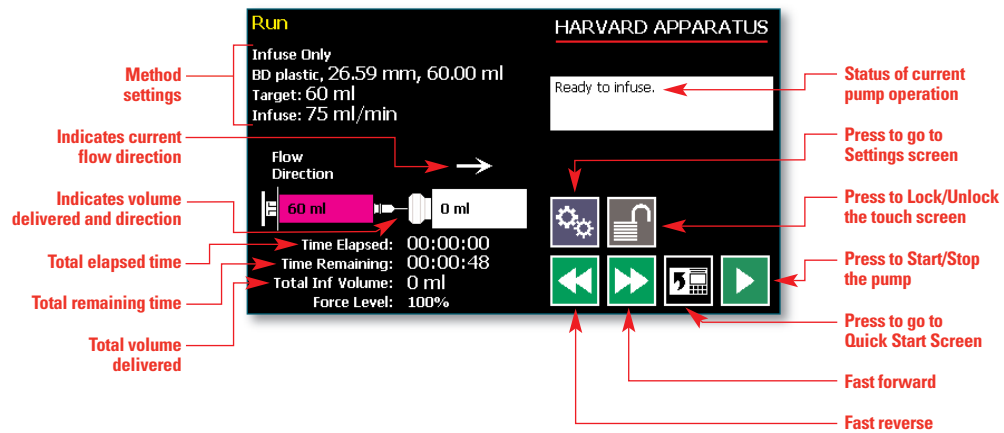

Running the Pump

Simply press the  button to start the pump.

When the pump is running the  button is shown.

Press the  button to pause the Method.

Press the  to resume running the pump.

Press the  to clear the counters and timers.

The fast forward and fast reverse key are not active when the pump is running.

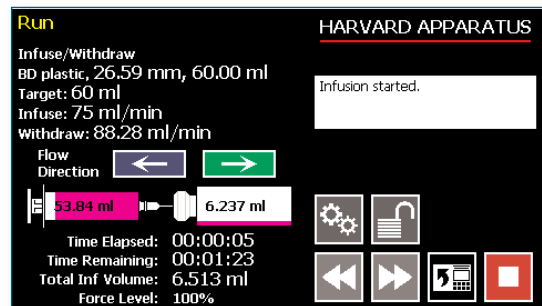
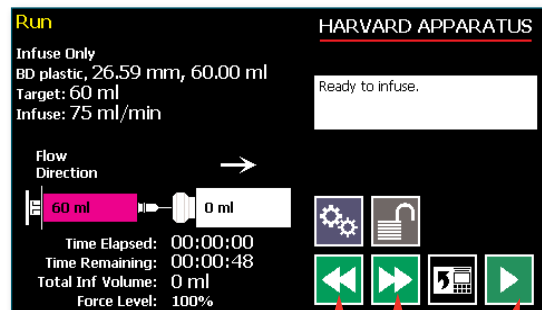

Custom Method Workflow

The following flow diagram describes the use of a Custom Method:

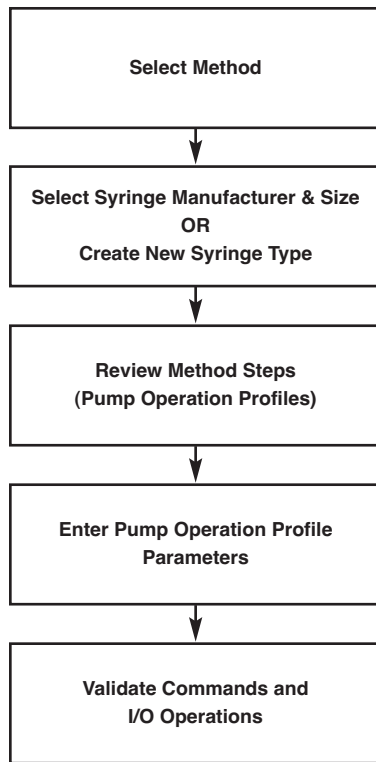

The software provides the user with a variety of prompts and warnings to help guide the setup of Methods. For example, if a pump Method incorporates steps that exceed the capacity of the defined syringe, the system will prompt you that parameters are out-of-range. The system also prompts users if required values are not entered.

NOTE *The pump will check the validity of parameters entered for each Step in the Method, but will not review the Method in its entirety to verify that it is logical and can be fully executed*

STEP-BY-STEP OPERATION EXAMPLE: USING A CUSTOM METHOD

The following steps describe operation using a Custom Method.

In the following description, we are assuming the use of a Method that is already saved on the Pump 11 Elite Series. Note that if you make any changes to the Method's operating parameters and choose Accept on the page where the changes are made, the changes automatically become part of the stored Method for future use.

1. From the Method Quick Start screen, the Method you wish to use should be displayed in the Method Select button. If the Method is not displayed, select the correct Method using the procedure outlined in Running The Pump.
2. Choose the Syringe Select button to enter the Syringe Selection screen.
3. Follow the instructions in the Syringe Selection section of this Guide to complete the selection of a syringe from the built-in syringe definition list, or to create a new syringe definition. When finished, choose the Accept button to save your changes, or choose the Cancel button to cancel your changes, and return to the Method Quick Start screen.
4. Review the Pump Control Profile Steps described in the Step Definition button. Note that the software will display the first three Steps in the Method in the main button area. If the Method uses more than three Steps, the last Step in the Method will be displayed in the box that is still part of the button beneath the Step Definition button.
5. To review the Method Steps in detail or to update/modify any of the stored Pump Control Profile Parameters, choose the Step Definition button to enter the Method Steps Summary Screen. The name of the Method is listed at the top of the screen, and the complete list of Steps is listed in a series of buttons is on the left of the screen.

6. To review details for any individual Step in the Method, select the Step you wish to review, then press the Step button again to enter the Step Definition screen for that Step.
7. To edit the parameters for any Pump Control Profile, follow the instructions supplied in the applicable Pump Operation Profile description contained in the Setting Method Parameters section later in this Guide.
8. To return to the Method Steps Summary screen when finished reviewing or editing the Step parameter details, choose the Accept button to save your changes or choose the Cancel button to cancel any changes you made.
9. When you are finished reviewing the operating details for all Steps, choose the Back button to return to the Method Main screen.
10. To preview the Method, choose the Preview Method button, or to run the Method, choose the Method Run button.

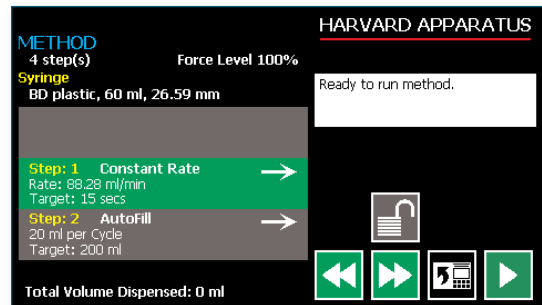

Press to Run Method

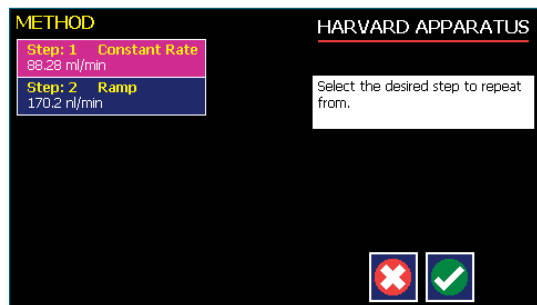
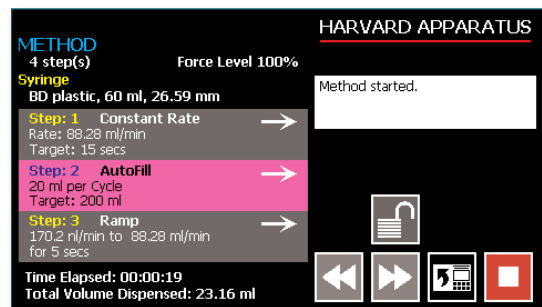

Step Definition Screen showing the list of Steps currently defined for the Method

Configuring Custom Methods

The Pump 11 Elite Series Programmable Models offer the flexibility of configuring custom Methods including multistep Methods. The Methods and steps can also be triggered to start and stop with events and external I/O, and user defined inputs.

To determine if your pump is programmable go to the pump information screen. The Model Type should say Programmable.



Press to see the pump information screen

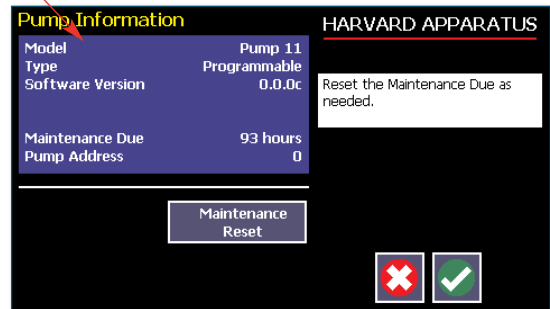
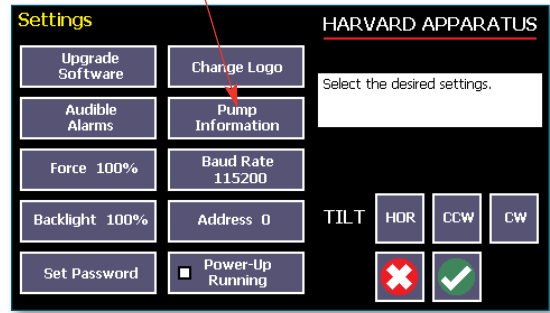

Configuring a New Custom Method

To display the Method Selection screen press Method.

Select Method

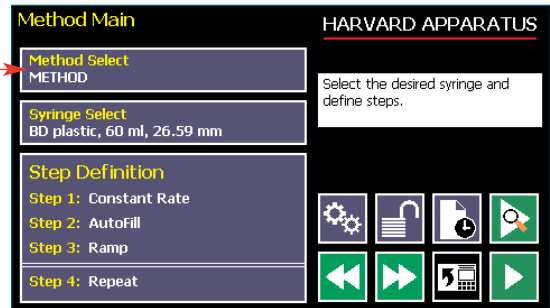

The Method Selection screen will be displayed

Select New Method

View Methods up a page

View the Methods down a page

Views up the Method

Views down the Method

Press

Select Method

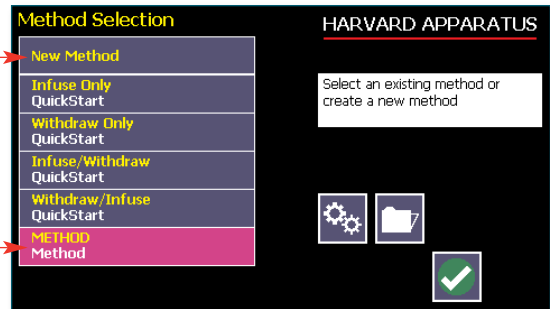

Configuring Custom Methods

The first thing to do on a custom Method is to name the Method.

Enter any 15 character alphanumeric name.

Accept the new name 

Go back to the Method Selection screen 

Select the Syringe manufacturer and Size.

To define the steps for the custom Method press Step Definition

Below are some predefined steps including:

Constant Rate - a single continuous rate of flow

Ramped Rate - a linearly changing flow rate between a starting and ending flow rate

Autofill - continuous infuse/withdraw or withdraw/infuse operation

Gradient - combined flow streams from multiple pumps into a common output stream

In addition to these you can repeat steps or set a delay within a Method as well as send signals to external devices or react to signals received from external devices. This package of pumping profiles and commands provides users with an extremely broad array of applications that can be easily configured with complex external programming.

Methods can be edited and saved under a new name, simply edited to fit another application. Steps can be copied, moved, inserted or deleted.

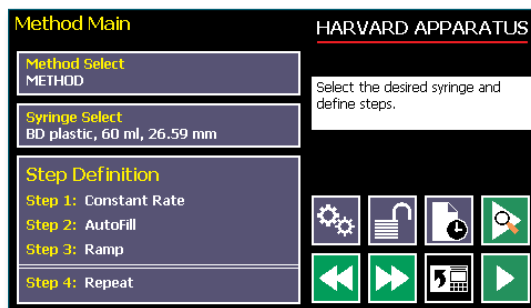
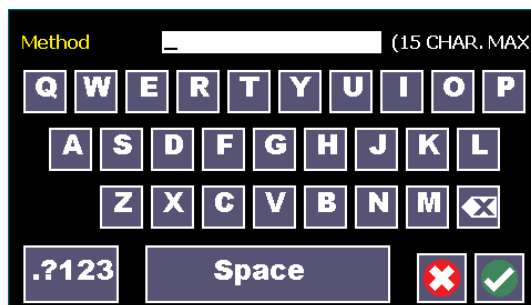

Setting A Delay

You can set the Pump 11 Elite Series to run after a delay. This delayed run function allows you to set up all the parameters for operation, then have the pump start unattended after a specified amount of time.

SETTING A DELAY FOR METHOD OPERATION:

1. From the Quick Start or Method Main screen, choose the Set Delay Parameters button to enter the Set Delay.
2. Enter the desired Time using the keypad.
3. If the Units of your Time are not correct for your application, select the Units button to toggle between sec (seconds) and hh:mm:ss (hours:minutes:seconds). To use hh:mm:ss option, enter your time value in hours, minutes, and seconds, separating each value with a colon. You can enter a value up to 99:99:99.
4. When the desired values are entered, choose the Accept button to save your Changes and return to the Method Quick Start screen. When a Time Delay value is active, the Time Delay Parameters button is displayed in Red on the screen to alert the user that a delay has been set.
5. Press the Run button to activate the Delay.

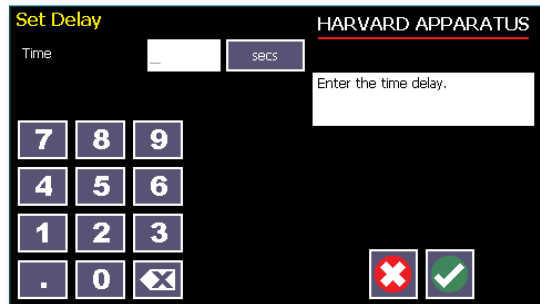
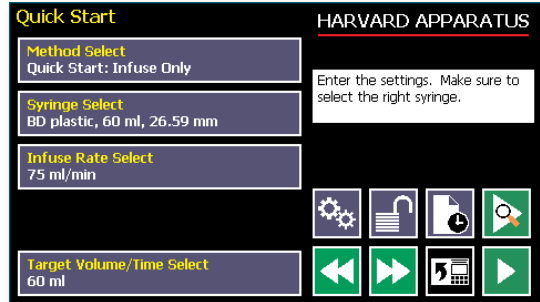

Set Delay Time screen

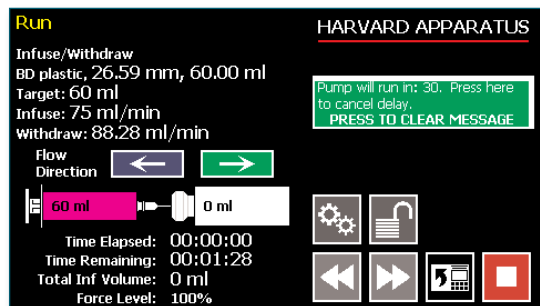

Quick Start run screen with a Time Delay Set

Creating a New Custom Method

If none of the Methods stored on the Pump 11 Elite Series match your requirements, you can create a new Method and store the Method for use. The following flow diagram outlines the basic steps you will follow to create a new Method:

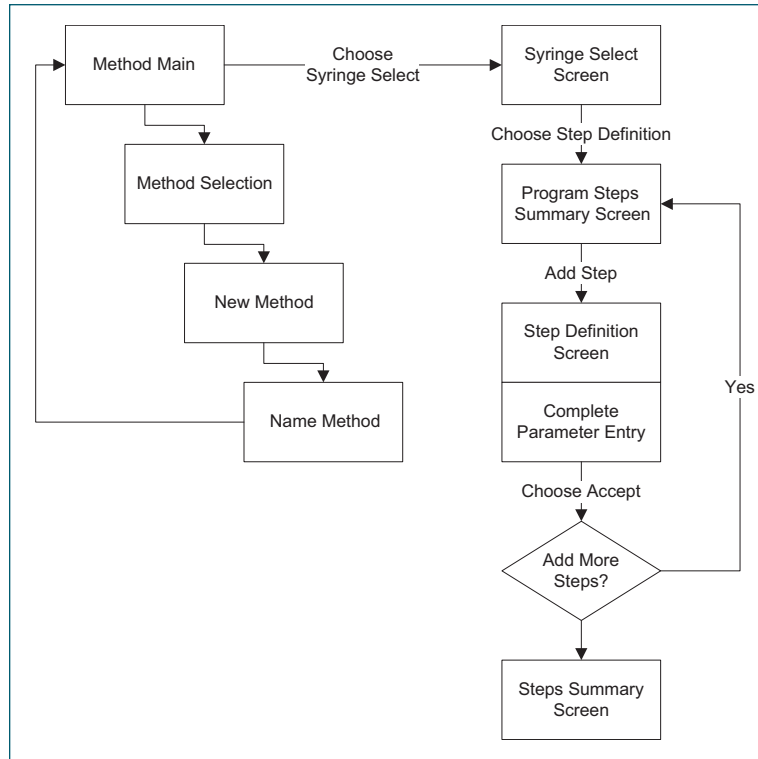

New User-Defined Method creation workflow

TO CREATE A NEW USER-DEFINED METHOD

1. From the Method Quick Start or Method Main screen, choose the Method Select button to enter the Method Selection screen.
2. Select New Method then choose Accept or press New Method again.
3. On the Method Name screen, type the name of your Method using the onscreen keyboard. Choose the Symbols/Numbers button **.?123** to display the list of available numbers and symbols that can be included in the Method Name. To switch the keyboard back to letters Method, choose the Letters button (ABC).

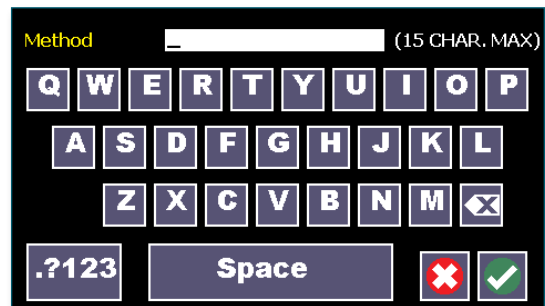

New Method Name Entry screen showing letter keys. To view numbers/symbols, choose the **.?123** use button in the lower left corner

TO CREATE A NEW USER-DEFINED METHOD (CONTINUED)

4. When you have entered the desired name for your Method, choose the Accept button to go to the Method Main screen. Your new Method will now be listed in the Method Select button.
5. Choose the **Syringe Select** button and complete the description of the syringe by following the procedure outlined previously in the Syringe Selection section of this Guide.
6. To begin creating Pump Control Profile Steps, choose the **Step Definition** button to enter the Method Steps Summary screen.
7. To add a Step to your Method, choose the Add Step button to access the Method Steps Menu screen. The available options include:
 - a. Constant Rate
 - b. Ramp
 - c. Gradient
 - d. Autofill
 - e. Repeat
 - f. Delay
 - g. I/O (in) Event
 - h. I/O (out) Trigger
 - i. Stop
9. Complete the parameter entry applicable to the selected Pump Operation Profile, follow the detailed instructions supplied in the Pump Operation Profiles (Existing and User-Defined Methods) section later in this Guide.

NOTE *If you do not complete the required parameter entry for a Step, subsequent Step additions may be ignored. You should enter all required parameters for a Step when creating it to ensure that the application software can assemble your Method without errors.*

- | | |
|------------------|----------------------|
| a. Constant Rate | f. Delay |
| b. Ramp | g. I/O (in) Event |
| c. Gradient | h. I/O (out) Trigger |
| d. Autofill | i. Stop |
| e. Repeat | |

10. When you have completed all parameter entries on the Step Definition screen, choose the **'ACCEPT'** button to save your changes and return to the Method Steps Summary screen.
11. Repeat items 7-10 in this procedure to include additional Steps in the Method.



NOTE *When adding a Step to a Method, the Step is added after the currently selected Step (i.e. the Step that is highlighted in magenta)*

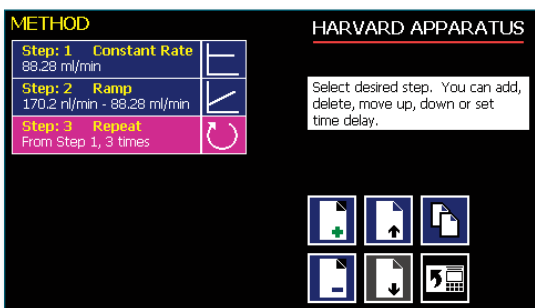

Method Steps Profile Menu screen

12. When you are done adding all required Steps to the Method, choose the **'BACK'** button to return to the Method Main screen.



8. Choose the Method Step type that you want to add to the Method. If you choose a pumping profile (e.g. Constant Rate, Ramp, etc.) you will be taken to the Step Definition screen for the selected profile.

Modifying an Existing User-Defined Method

Once you have created a Method or have reviewed an Existing Method, you may have a need to modify the structure of the Method (i.e. the types of Steps and Commands included, not just changes in the operating parameters for a specific Step. The following procedures will help you to efficiently modify a stored Method.

CHANGING THE ORDER OF STEPS IN A METHOD

1. From the Method Main screen, choose the **Step Definition** button to enter the Method Steps Summary screen.

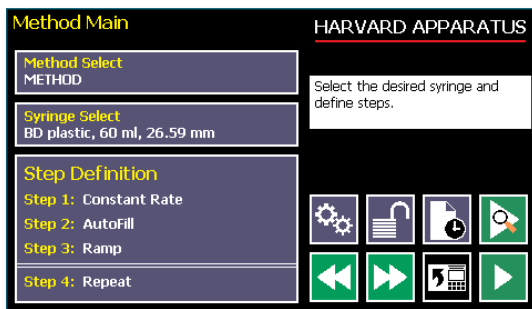

2. Highlight (select with a single touch) the Step for which you want to change the order.
3. Choose the Move Step Up or Move Step Down button, as required, to move the Step into the position that you want it executed.

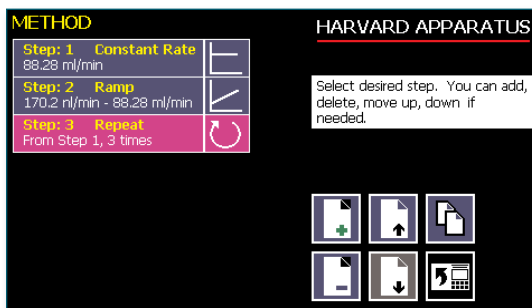

DELETING A STEP FROM A METHOD

1. From the Method Main screen, choose the **Step Definition** button to enter the Method Steps Summary screen.
2. Highlight (select with a single touch) the Step that you want to delete.
3. Choose the Delete Step button. The application will display a warning message in the Message Area asking you to confirm your deletion request.
4. To confirm the deletion, choose the Delete Step button again.

Defining Method Step Parameters

This section of the User Guide describes each of the functions available for use in Pump 11 Elite Series Existing and User-Defined Methods. The information in this section is designed to help you set the individual parameter values in each of the Method Step options and to properly use the Advanced Options commands.

The information that follows is organized into two sections:

- Pump Operation Profiles
- Advanced Options (Commands and I/O)

PUMP OPERATION PROFILES

The Pump 11 Elite Series Existing Methods and all User-Defined Methods use Pump Operation Profiles as part of the Methods controlling the pump. These profiles are combined with a syringe selection and any Commands or Input/Output triggers to create a complete Method. The following sections describe each profile along with instructions for setting up the profile. The following Pump Operation Profiles are available on the Pump 11 Elite Series:

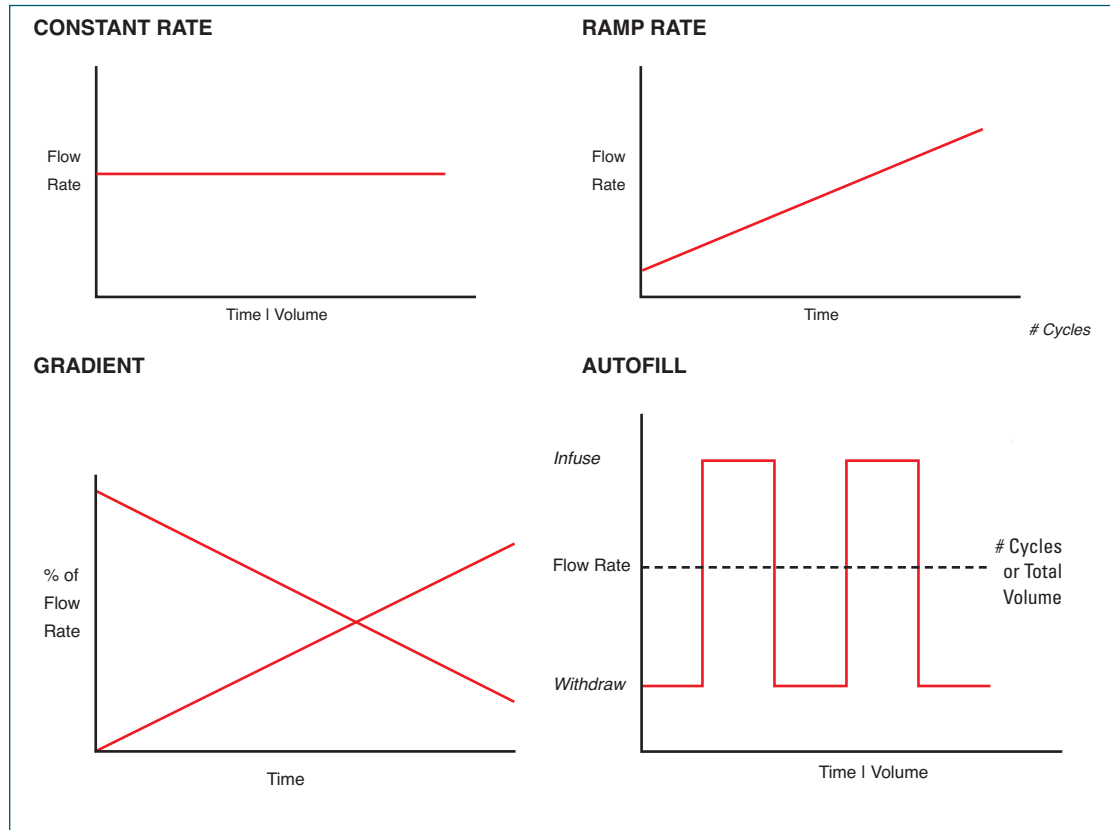

Pump Operation Profiles available on the Pump 11 Elite Series

Constant Rate Profile

The Constant Rate profile is used to run the pump at a defined flow rate and for a specific pumping mode (infuse or withdraw) up to a target volume or for a defined time period.

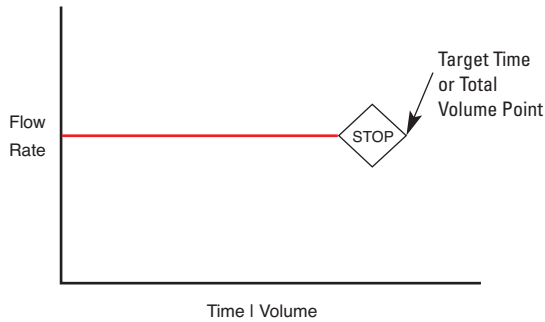

Constant Rate Pump Operation Profile

When creating or editing a Constant Rate profile, you will define three primary operating parameters:



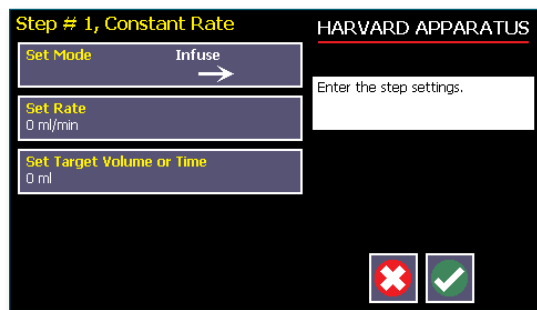

- The Flow Method defining the direction of flow: infuse or withdraw
- The Flow Rate to define the rate of uptake or dispensing
- The Target Volume or Run Time that determine how long the pump will operate at the set rate

When creating or editing a Constant Rate profile, you can set the rate in ml, µl, nl or pl units of volume using sec, min or hr as the units of time. The system automatically calculates a minimum and maximum flow rate based on the syringe selected or custom-defined. The min/max values are made available as button selection options on the Set Infuse and Withdraw Rate screens.



Constant Rate Profile Setup Screen

TO SET UP/EDIT A CONSTANT RATE PROFILE:

1. From the Step Definition screen for a Constant Rate profile, choose the **Set Mode** button to toggle the Flow Method between Infuse and Withdraw operation.
2. Choose the **Set Rate** button to enter the Set Rate screen.
3. Enter the flow rate value desired using the keypad or select the **Minimum Rate** or **Maximum Rate** button.
4. If the Units of Rate are not correct for your application, choose the **Units** button.
5. On the Units Selection screen, select the unit of measure (ml, µl, nl or pl) and the unit of time(sec, min, hr) as appropriate, then choose **'ACCEPT'** to confirm your selections. 
6. When all parameters are correctly set on the Set Rate screen, choose **'ACCEPT'** to confirm your settings and return to Constant Rate Definition screen. 
7. Choose the **Set Target Volume or Time** button to enter the Set Volume or Time screen.
8. On the Set Volume or Time screen, select the **Volume** or **Time** button, as desired.
9. Enter the desired value using the keypad, or select the **Maximum Volume** button.
10. If the Units of Volume/Time are not correct for your application, choose the **Units** button to the right of the parameter entry box. For the Units of Volume, this choice takes you to the Units Selection screen. For the Units of Time option, this choice will toggle the button between sec (seconds) and h:m:s (hours:minutes:seconds). To use the h:m:s option, enter your time value in hours, minutes and seconds, separating each value with a colon.
11. If you are changing the Units of Volume, on the Units Selection screen, select the unit of measure (ml, µl, nl or pl) as appropriate, then choose **'ACCEPT'** to confirm your selection. 
12. When all parameters are correctly set on the Set Target Volume or Time screen, choose **'ACCEPT'** to confirm your settings and return to the Constant Rate Definition screen. 
13. Choose **'ACCEPT'** again to return to the Step Definition screen. 

Ramp Profile

The Ramp Rate profile is used to create a linearly increasing or decreasing flow rate for a single pumping Method (infuse or withdraw) over the course of a defined time period.

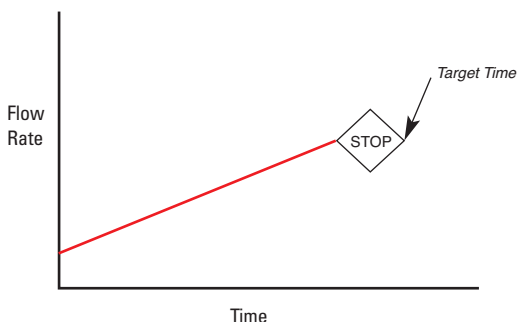

Ramp Rate Pump Operation Profile

When creating or editing a Ramp Rate profile, you will define three primary operating parameters:

- The Flow Method defining the direction of flow: infuse or withdraw
- The Flow Rate at the beginning and end of the pumping cycle
- The Target Time that determines the total length of time over which the ramp will be calculated

During a Ramp Rate profile, the Pump 11 Elite Series varies the flow rate linearly between the starting rate and ending rate over the full time period entered. A Ramp Rate profile can be applied to an increasing or decreasing rate application.

When creating or editing a Ramp Rate profile, you can set the rate in ml, µl, nl or pl units of volume using sec or h:m:s (hours:minutes:seconds) as the units of time. The system automatically calculates a minimum and maximum flow rate based on the syringe selected or custom-defined. The min/max values are made available as button selection options on the Set Infuse and Withdraw Rate screens.

TO SET UP/EDIT A RAMP RATE PROFILE:

1. From the Step Definition screen for a Ramp Rate profile, choose the **Set Mode** button to toggle the Flow Method between Infuse and Withdraw operation.

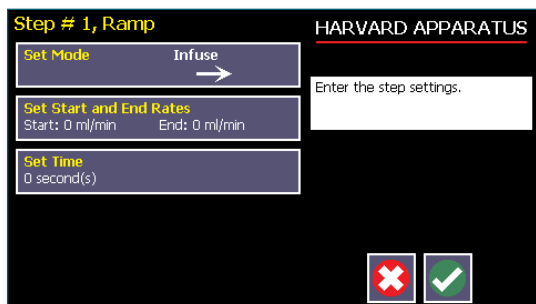

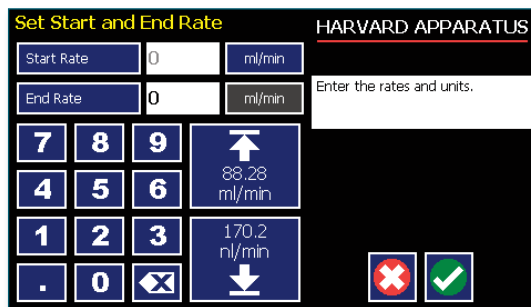

Step Definition screen for a Ramp Rate profile

2. Choose the **Set Start** and **End Rate** button to enter the Set Start & End Rates screen.



Set Start and End Rates screen

3. Select the **Set Start** and **End Rate** button (it should be selected by default as indicated by the active data entry box to the right of the button). Enter the flow rate value desired using the keypad or select the **Minimum Rate** or **Maximum Rate** button.
4. If the Units of Rate are not correct for your application, choose the **Units** button.
5. On the Units Selection screen, select the unit of measure (ml, µl, nl or pl) and the unit of time (sec, min, hr) as appropriate, then choose **'ACCEPT'** to confirm your selections. 
6. Repeat Steps 3 to 5 for the End Rate by selecting the **End Rate** button and continuing data entry.
7. When all parameters are correctly set on the Set Rate screen, choose **'ACCEPT'** to confirm your settings and return to Ramp Definition screen. 
8. Choose the Time button to enter the Set Time screen.
9. Enter the desired Time value using the keypad.
10. If the Units of Time are not correct for your application, select the **Units** button to toggle between sec (seconds) and h:m:s (hours:minutes:seconds). To use the h:m:s option, enter your time value in hours, minutes and seconds, separating each value with a colon.
11. When all parameters are correctly set on the Set Target Time screen, choose Accept to confirm your settings and return to the Ramp Definition screen.
12. Choose Accept again to return to the Step Definition screen.

NOTE Ramps ≤ 2 seconds from min to max rates may cause motor stalls.

Gradient Profile

The Gradient profile is used to combine multiple flow streams from different pumps into a common output stream. The flow profiles can be constant, ramped or stepped.

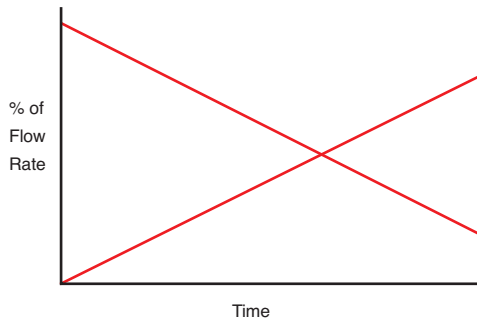

When creating or editing a Gradient profile you will define 4 primary operating parameters:

- The combined Flow Rate
- The Target Starting and Ending Percentages for each pump in the system.
- The Target Time that determines the total length of time over which the Gradient profile will be calculated
- The Number of Steps that will be created in the profile

NOTE See Appendix C: RS-485 for physical gradient connections

NOTE Master address must be set to 00. Ensure that the satellite's address matches the address set in the gradient step.



CAUTION: ALL PUMPS MUST USE THE SAME SYRINGE SIZE AND TYPE. IF THERE IS A SYRINGE CHANGE AT MASTER THEN SAME CHANGE MUST OCCUR AT ALL SATELLITES.

NOTE Make all cable connections, then power-up the satellite pump before powering-up the master pump.

TO SET UP/EDIT A GRADIENT PROFILE:

1. From the Step Definition screen for Gradient, choose **Set Combined Flow Rate** to enter the Set Rate screen.

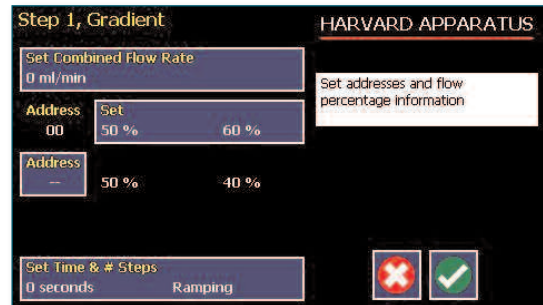

2. Enter the desired combined flow rate value for both pumps using the keypad or select the **Minimum Rate** or **Maximum Rate** button.

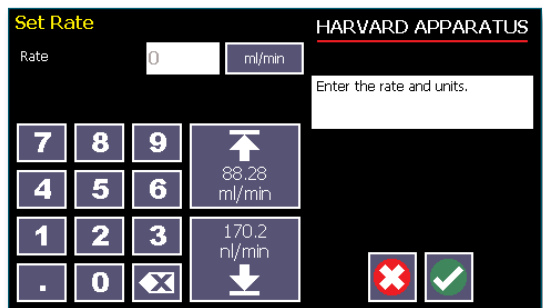

3. If the Units of Rate are not correct for your application, choose the **Units** button.
4. On the Units Selection screen, select the unit of measure (ml, µl, nl, or pl) and the unit of time (sec, min, hr) as appropriate, then choose Accept to confirm your selections.
5. When all parameters are correctly set on the Set Rate screen, choose Accept to confirm your settings and return to the Step Definition screen.
6. Choose the **Set Percentage** button for pump 00.
7. Set the Start and End Percentages for pump 00 then choose Accept.
8. Choose the **Address** button, and then set the address of the second pump. Choose Accept to return to the Step Definition screen.

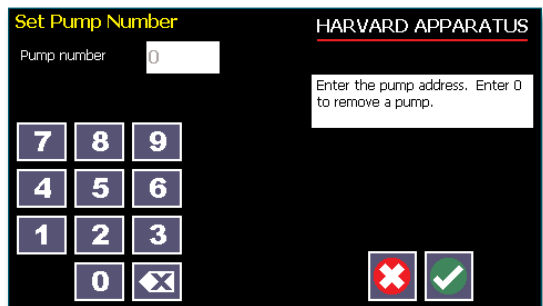

9. The pump will calculate the remaining percentages for the second pump.
10. Choose the **Set Time and # Steps** button. Enter the total amount of time and the number of steps desired and then choose Accept.

Running a Gradient Profile

The pump control button's background color indicates the status of the satellite unit.

Blue Background= Connected / Motor Stopped

Red Background= Comm Error

Yellow Background= Motor Stall

Green Background= Motor Running

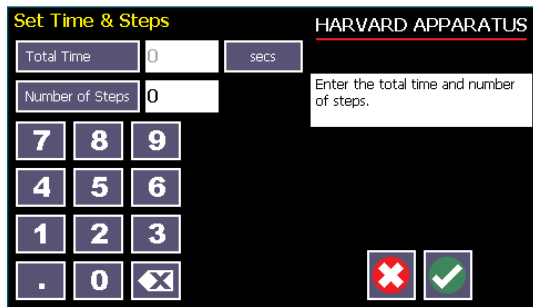

NOTE For a Constant rate or Ramp profile choose 0 steps. For a Stepped profile select the number of steps desired.

NOTE When running a gradient step, ensure that no unused pumps are included in the pump chain.

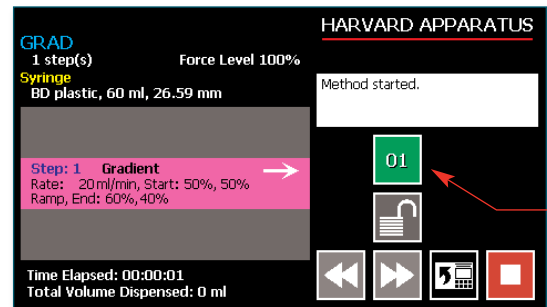

Pump Control button showing the satellite's address

NOTE When running a Gradient step, the satellite pump's screen will display "Satellite" followed by its pump address. A stop button will be active on the satellite when the pump is running.

Autofill Cycling Profile

The Autofill Cycling Profile is an automated Infuse/Withdraw or Withdraw/Infuse step that operates at constant, but separately defined, flow rates for the withdraw and infuse operations. The Autofill profile is designed to work in conjunction with an autofill valve that controls the switching of flows from a reservoir for refilling the syringe, to the target infusion subject.

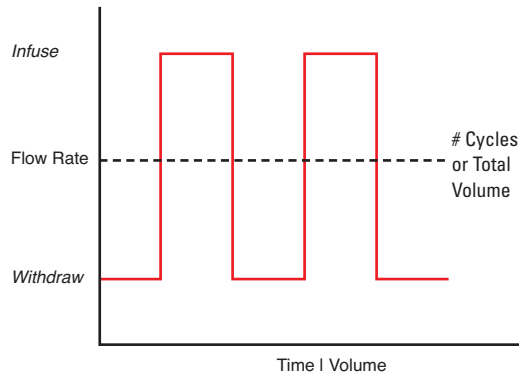

When creating or editing an Autofill Cycling profile, you will define the following operating parameters:

- The Flow Mode defining the cycle: Infuse/Withdraw (INF/WD) or Withdraw/Infuse (WD/INF)
- The Flow Rates to be used during Infuse/Withdraw operations
- The infusion volume to be delivered during each pump cycle
- The total volume to be delivered during all cycles or the total number of Infuse/Withdraw or Withdraw/Infuse cycles that you want the pump to execute. For example, if you want to pump 100 ml using a 10 ml syringe, the pump will execute 10 Infuse/Withdraw or Withdraw/Infuse cycles, depending upon the chosen flow mode.

During an Autofill profile, the Pump 11 Elite operates at a constant pump rate during the infusion and withdrawal stages, although the rate can be different for each direction (i.e. infuse vs. withdraw).

When creating or editing an Autofill Cycling profile, you can set the rate in ml, µl, nl or pl units of volume using sec, min or hr as the units of time. The system automatically calculates a minimum and maximum flow rate based on the syringe selected or custom-defined. The min/max values are made available as button selection options on the Set Rate and Concentration screen.

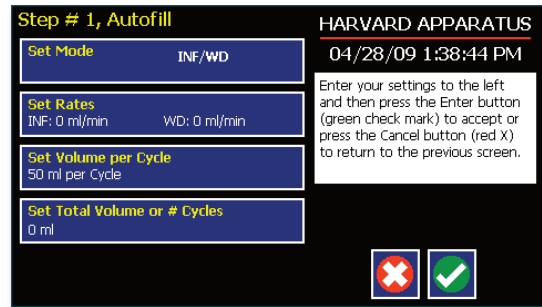

TO SET UP/EDIT AN AUTOFILL CYCLING PROFILE:

1. From the Step Definition screen for an Autofill Cycle, choose the **Set Mode** button to toggle between the Withdraw/Infuse (WD/INF) and Infuse/Withdraw (INF/WD) modes. Withdraw/Infuse begins by withdrawing into the syringe, following by infusing into the target.
2. Choose the **Set Rates** button to enter the Set Infuse/Withdraw Rate screen.
3. Select the Infuse Rate (it should be selected by default as indicated by the active data entry box to the right of the button). Enter the desired rate using the keypad or select the Minimum Rate or Maximum Rate button.
4. If the Units of Rate are not correct for your application, choose the **Units** button.
5. On the Units Selection screen, select the unit of measure (ml, μ l, nl or pl) and the unit of time (sec, min, hr) as appropriate, then choose Accept to confirm your selections.
6. Select the Withdraw Rate and enter the desired rate using the keypad or select the Minimum Rate or Maximum Rate button.
7. When all parameters are correctly set on the Set Infuse/Withdraw Rate screen, choose Accept to confirm your settings and return to Step Definition screen.
8. Choose the **Set Volume per Cycle** button to enter the Set Volume per Cycle screen.
9. Enter the Volume using the keypad.
10. If the Units of Measure associated with Volume are not correct for your application, choose the **Units** button to enter the Units selection screen. Select the unit of measure button (ml, μ l, nl, pl) appropriate for your application, then choose the Accept button to return to the Set Target Volumes screen.
11. When all parameters on the Set Volume per Cycle screen are correct, choose the Accept button to return to the Step Definition screen.
12. Choose the **Set Total Volume or # Cycles** button to enter the Set Total Volume or # Cycles screen.
13. Select either Total Volume or # Cycles to define how the pump will control pumping activity. Total Volume will cycle the pump the correct number of times to deliver the total volume according to the Volume per Cycle setting. For example, if you set a 10 ml Volume per Cycle and set 100 ml in Total Volume, the pump will cycle 10 times.
14. If you select Total Volume, enter the volume desired using the keypad. If you select # Cycles, enter the total number of Infuse/Withdraw or Withdraw/Infuse cycles that you wish to perform.
15. If the Units of Measure associated with Volume are not correct for your application, choose the **Units** button to enter the Units selection screen. Select the unit of measure button (ml, μ l, nl, pl) appropriate for your application, then choose the Accept button to return to the Set Target Volumes screen.
16. When all parameters on the Set Total Volume or # Cycles screen are correct, choose the Accept button to return to the Step Definition screen.

NOTE

Using maximum rate may not be appropriate during the Withdraw stage of an Autofill profile, since air can be drawn into the syringe, or a high vacuum pressure can be produced depending on the syringe and/or tubing being used, or the fluid viscosity.

Incorporating Advanced Options (Commands and I/O) Into A Method

Pump 11 Elite Series Methods can incorporate a variety of commands that expand the versatility of the system by permitting convenient looping, chaining of events, sending signals to external devices, or accepting inbound signals from external devices. These Advanced Options controls are described in this section of the Guide.

Delay

The Delay Command is used to insert a time delay in a procedure. You can set a time delay between 0.2 seconds up to 99:99:99 (99 hours, 99 minutes, 99 seconds).

TO INSERT A TIME DELAY IN A METHOD:

1. From the Method Main screen, choose Step Definition to enter the Step Definition screen.
2. Highlight (select once) the Method Step that you want the time delay to follow.
3. Choose the Insert Step button to access the Method Steps Menu screen.
4. Choose Delay to enter the Set Delay Time screen.

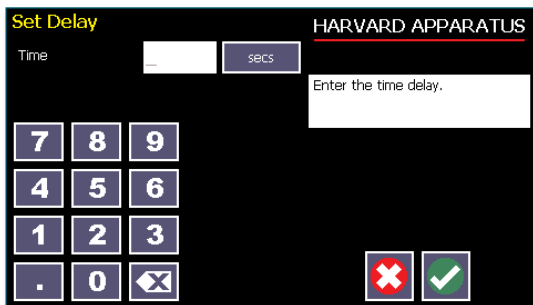

Advanced Options Set Delay Time screen

5. Enter the desired Time using the keypad.
6. If the Units of Time associated with Time are not correct for your application, select the Units button to toggle between sec (seconds) [0.2 seconds minimum allowable value] and h:m:s (hours:minutes:seconds). To use the h:m:s option, enter your time value in hours, minutes and seconds, separating each value with a colon. You can enter a value up to 99:99:99.
7. When your Time entry is correct, choose the Accept button to insert the Delay Step in the Method and return to the Step Definition screen.

Repeat Step

The Repeat Command is used to repeat Steps in a procedure a defined number of times. To use this Command, you will tell the application what Steps you want to Repeat and how many times you want them repeated. The Repeat Step command creates a “jump” back to a specific Step in a Method that executes the defined Step plus all following Steps up to the Repeat command (i.e. it creates a Method loop).

When defining a Repeat jump in a Method, the Command targets the Step sequence position and not the function that currently occupies that position. For example, if you create a Repeat jump to Step 4 in a Method (currently a Ramp Pump Operation Profile) and subsequently move a Constant Rate profile into the Step 4 position, the Repeat jump will then connect to the Constant Rate operation and not to the Ramp operation.

TO INSERT A STEP REPEAT SEQUENCE IN A METHOD:

1. From the Method Main screen, choose Step Definition to enter the Step Definition screen.
2. Highlight (select once) the Method Step that you want the repeat step to follow.
3. Choose the 'ADD STEP' button to access the Method Steps Menu screen.
4. Choose Repeat to insert the Repeat Step function into the Method.
5. Select the Step(s) you would like to repeat from by selecting the Step button twice or selecting once and then choosing Accept.

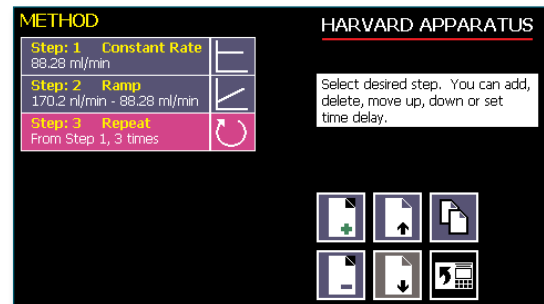

Advanced Options Repeat Step screen. Choosing Repeat brings you to a listing of the available steps in the Method

6. Enter the number of repeats using the keypad then choose the Accept button to save your change and return to the Step Definition screen.

NOTE

This command creates a loopback to the designated Step in a Method, executing the selected Step, plus all subsequent Steps up to the point of insertion of the Repeat command. For example, if the Repeat command is set to repeat Step 2 one time, the system will loop back to Step 2 and execute both Steps 2 and 3 one additional time.

Stop

The Stop Command is used to instruct the pump to stop operation. This Command can be used in conjunction with I/O Events to control pump operation based on external events.

TO INSERT A STOP COMMAND IN A METHOD:

1. From the Method Main screen, choose Step Definition to enter the Step Definition screen.
2. Highlight (select once) the Method Step that you want the Stop Command to follow.
3. Choose the 'ADD STEP' button to access the Method Steps Menu screen.
4. Choose Stop to insert the Stop Command into the Method.



I/O EVENT TRIGGERS

The Pump 11 Elite Series pump permits easy connection to external I/O devices via a variety of interfaces, including a built-in 15-pin D-sub connector. The Pump 11 Elite Series software incorporates simple commands for incorporating I/O controls into your pump Methods. General trigger signals are integrated in the software. The following procedure describes the use of the Advanced Options I/O commands. Following the procedure is a description of the selection menu options for each of the I/O command types. Details for the electrical connection controls and pin-out description for the 15-pin User I/O Connector are provided in Appendix C of this manual.

The Pump 11 Elite Series manages trigger events through specific pins on the I/O Connector port on the back of the pump. The following details define pin logic:

- Trigger is communicated via Pin 4.
- Event signal are communicated via Pin 2.

I/O (OUT) Trigger

The I/O (OUT) Trigger command is used to send a signal to an external device when the Step in the Method is reached.

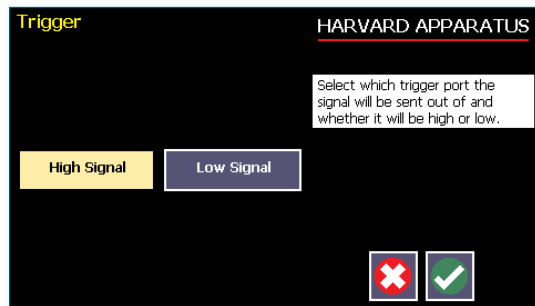

I/O (OUT) Trigger Advanced Options menu

The following option is available when setting an I/O (OUT) Trigger command:

- **Trigger 1:** Specifies output via the Trigger 1 (Pin 4) port. When selected, you must also specify whether the signal to be sent is High Signal or Low Signal.
 - **High Signal:** Sets the output signal to logic high.
 - **Low Signal:** Sets the output signal to logic low.

TO INSERT AN I/O (OUT) TRIGGER COMMAND:

1. From the Method Main screen, choose **Step Definition** to enter the Step Definition screen.
2. Highlight (select once) the Method Step that you want the I/O (OUT) Trigger to follow.
3. Choose the **'ADD STEP'** button to access the Method Steps Menu screen.
4. Choose the **I/O (OUT) Trigger** button to enter the Trigger Step Definition Screen.
5. Set your Trigger settings by using the following procedure:
 - a. To send a Trigger signal to an external device via Pin 4, select the Trigger 1 button. Then select whether the signal will be High or Low by selecting the appropriate button (selection will highlight in white).
6. Choose the Accept button to save your changes and return to the Step Definition screen.

NOTE

When using triggers, the first step in your Method should define the trigger starting level (High or Low). You may then use the trigger command to change the level as desired for your Method.

I/O (IN) Event

The I/O (IN) Event command is used to have the pump pause and wait for a signal from an external device or for a manual user input at the touch screen. These external signals are communicated via Pin 2 on the 15-pin I/O Connector port.

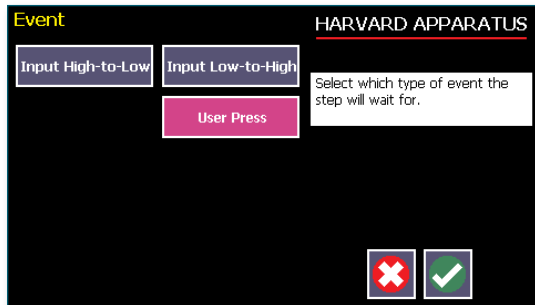

The following options are available when setting an I/O (IN) Event command.

- **Input High-to-Low:** Sets the pump to wait for a logic low input signal falling edge.
- **Input Low-to-High:** Sets the pump to wait for a logic high input signal rising edge.
- **User Press:** Sets the pump to wait for manual input from the user at the touch screen (screen touch).

TO INSERT AN I/O (IN) EVENT COMMAND:

1. From the Method Main screen, choose **Step Definition** to enter the Step Definition screen.
2. Highlight (select once) the Method Step that you want the I/O (IN) Event to follow.
3. Choose the **'ADD STEP'** button to access the Method Steps Menu screen.
4. Choose the I/O (IN) Event button to enter the Event Step Definition Screen.
5. Select either Input High, Input Low or User Press, as appropriate.
6. Choose the Accept button to save your changes and return to the Step Definition screen.



MANAGING PUMP 11 ELITE SERIES METHODS

All Existing and User-Defined Methods are stored in the Method List for ongoing use. Over time, you may want to manage previously created Methods to keep your Method List easy to navigate. In addition, the Pump 11 Elite Series allows you to export Method information to an externally connected pump or to a computer that will be used to control operation. This section of the Guide describes the file management facilities available on the Pump 11 Elite Series.

NOTE

The Method management procedures outlined in this section are not available for Quick Start Methods (Infuse only, Withdraw only, I/W or W/I)

Saving A Copy Of A Method

Follow these instructions to save a copy of a Method under a new name:

1. From Quick Start screen, choose the **Method Select** button to enter the Method Selection screen.
2. From the list of available Methods, select (press once) the Method you want to save a copy of, then choose the File Options button to enter the File Options screen.
3. Choose **Save As/Copy** to access the Method Name Entry screen. The current Method Name will be displayed in the text entry box.
4. On the Method Name screen, type the new name for your Method using the onscreen keyboard. Choose the Symbols/Numbers button (.?123) to display the list of available numbers and symbols that can be included in the Method Name. To switch the keyboard back to letters Method, choose the Letters button (ABC). [15 characters maximum]
5. When finished entering the new Method Name, choose Accept to save your changes and return to the File Options screen.
6. Choose **'BACK'** to return to the Method Selection screen.



Renaming A Method

Follow these instructions to rename a previously saved Method:

1. From the Quick Start screen, choose the **Method Select** button to enter the Method selection screen.
2. From the list of available Methods, select (press once) the Method you want to rename, then choose the **File Options** button to enter the File Options screen.

3. Choose **Rename Method** to access the Method Name Entry screen. The current Method Name will be displayed in the text entry box.
4. On the Method Name screen, type the new name for your Method using the onscreen keyboard. Choose the Symbols/Numbers button (.?123) to display the list of available numbers and symbols that can be included in the Method Name. To switch the keyboard back to letters Method, choose the Letters button (ABC). [15 characters maximum]
5. When finished entering the new Method Name, choose Accept to save your changes and return to the File Options screen.
6. Choose **'BACK'** to return to the Method Selection screen.



Appending A Method

Follow these instructions to Append a previously created Method into a new Method:

1. From the Method Main or Quick Start screen, choose the **Method Select** button to enter the Method Selection screen.
2. From the list of available Methods, select (press once) the Method you want as the base Method.
3. Choose the **File Options** button to enter the File Options screen.
4. Choose **Append** to access the Method to Append screen.
5. Choose (press twice) the Method you would like to Append (attach) to your base Method. The pump will return you to the File Options screen and display a confirmation that the Method was copied.
6. Choose **'BACK'** to return to the Method Selection screen.

Deleting A Method

Follow these instructions to delete a previously saved Method:

1. From the Method Main or Quick Start screen, choose the Method Name button to enter the Method Selection screen.
2. From the list of available Methods, select (press once) the Method you want to delete, then choose the File Options button to enter the File Options screen.
3. Choose **Delete Method**. The application will display a warning message in the Message Area asking you to confirm your deletion request.
4. Choose **Delete Method** again to confirm the deletion and return to the Method Selection screen.

PUMP 11 ELITE SERIES METHOD EXPORT AND IMPORT

The Pump 11 Elite Series pump permits the daisy chaining of multiple pumps, as well as integration with/control by an external computer through HyperTerminal. To facilitate operation in these Methods, the Pump 11 Elite Series application software includes a variety of commands designed to simplify the export/import of Methods between the pump and external devices. This section outlines the use of these commands.

NOTE *Import will only work when the destination pump has 0 or 1 Method stored.*

NOTE *Do not attempt to Export/Import Methods while the pump is running.*

NOTE *Do not change screens while Importing/Exporting a Method.*

NOTE *For additional details on the physical interfaces used to connect the Pump 11 Elite Series to external devices, refer to the External I/O Connections section in the Appendices.*

TRANSFER A METHOD BETWEEN PUMPS

Follow these instructions to transfer a Method between two Pump 11 Elite Series pumps.

1. Connect two pumps together via a RS-485 (firewire type) cable and set the address on the first pump to '00' using the Set Pump Address command in the Settings menu.
2. Set the address on the second pump to something other than '00' using the Set Pump Address command in the Settings menu.
3. From the Method Main screen, choose Method Select then choose the Method you would like to export.
4. Choose the **File Options** button.
5. Choose the Pump button and enter the address for the pump you would like to receive the Method.
6. Choose Export Method to Pump.
7. The pump will display a confirmation message in the Message Area on the screen when the export is complete. Note that long Methods may take a few seconds to export.
8. Before disconnecting the pumps, verify that the Method was successfully exported by choosing Method Select from the Method Main screen on the destination pump, then browse the available Methods to verify that the exported Method is shown in the menu.

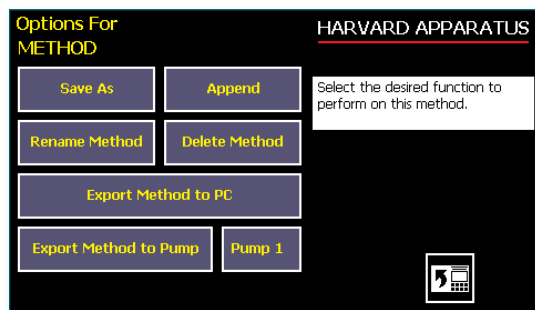

Method option screen

**EXPORTING A METHOD
TO AN EXTERNAL COMPUTER**

Follow these instructions to export a Method to an external computer.

1. Connect the pump to the external computer via USB cable.
2. On the computer, open the HyperTerminal application and verify that the computer can communicate with the pump.
3. At the pump, from the Method Main screen, choose Method Select then choose the Method you would like to export.
4. Choose the **'FILE OPTION'** button.
5. In HyperTerminal, choose Transfer Capture Text...
6. Enter the File Name that you want to save the Method under, then choose Start.
7. Choose Export Method to PC.
8. The pump will display a confirmation message in the Message Area on the screen when the export is complete. Note that long Methods may take a few seconds to export.
9. At the destination computer, in HyperTerminal, when the Method is done transferring, the message "mend" will appear onscreen.
10. In HyperTerminal, choose Transfer Capture Text... Stop. Your Method is now saved on the external computer.

**IMPORTING A METHOD FROM AN EXTERNAL
COMPUTER**

Follow these instructions to import a Method from an external computer.

1. Connect the pump to the external computer via a USB cable and set the Address value to '00' using the Set Pump Address command in the Settings menu.
2. On the computer, open the HyperTerminal application and verify that the computer can communicate with the pump.
3. In HyperTerminal, click on the Properties icons and choose the Settings tab on the pop-up box that is displayed.
4. Click on the ASCII Setup button.
5. In the Line Delay field, enter 500. This will set a 500 millisecond delay after each line is transferred during the import process.
6. Click OK twice to return to the HyperTerminal Main Menu screen.
7. In HyperTerminal, choose Transfer Send Text File...
8. Select the Method that you want to import to the pump and click Open.
9. Before disconnecting, verify that the Method was transferred by choosing Method Select from the Method Main screen at the destination pump, then browse the Method menu to confirm that the new Method is now saved at the pump.

EXTERNAL PUMP CONTROL

This section of the Pump 11 Elite Series manual describes the control of the pump using an external computer device. If communicating via the USB Port, see Appendix C for one time installation instructions of USB Driver.

Setting Up HyperTerminal

HyperTerminal is a Windows application designed to support the external control of devices such as the Pump 11 Elite Series pump through a USB connection. The following instructions describe the configuration of the HyperTerminal application.

1. Select "Start – All Methods – Accessories – Communications – HyperTerminal".
2. Enter a name for a New Connection (i.e Pump_11_Elite), then click OK.

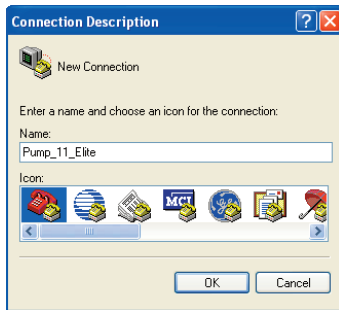

3. Select the Virtual Comm Port from the "Connect using" drop-down list. Click OK. (If the Virtual Comm Port is not known, use Device Manager to find it. Instructions on setting up the Virtual CommPort Driver are supplied in Appendix E.)

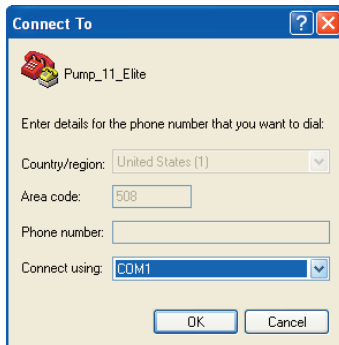

NOTE To determine the proper comport, in your PCs "Systems Properties" screen, under the "Hardware" tab, select "Device Manger". Expand the "ports (COM & LPT)" section and you should see "Syringe Pump". The comport is listed next to this in parenthesis.

4. Set up the Port Settings as shown below and click OK.

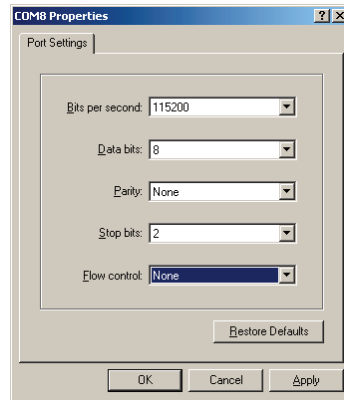

5. Verify the Settings are as shown below.

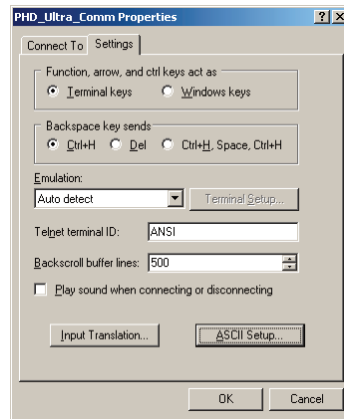

6. Choose ASCII Setup and select "Echo typed characters locally" then click OK to complete the setup.

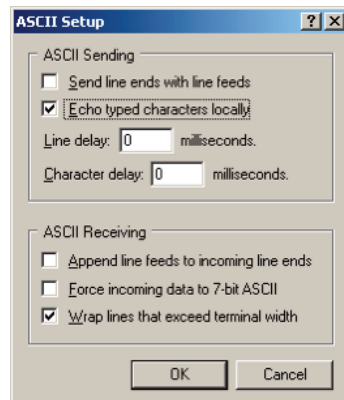

NOTE NOTE: To determine if your pump is connected correctly, in Hyperterminal's main window press 'Enter'; a ':' should appear. If not connected properly, close Hyperterminal, turn off the pump, unplug then re-plug the USB cable, turn on the pump and re-open Hyperterminal.

PUMP CHAIN COMMANDS

The Pump Chain commands allow all pump control information to be managed from an external computer source. These commands can also be used to control a series of pumps (up to 100) from a single computer interface.

Pump 11 Elite Series commands are communicated to the pump via a USB port interface through a terminal Method such as Harvard Apparatus' Method Manager or HyperTerminal. In using the Pump Chain commands, you will need to assign each pump in the pump chain a unique address, using the Set Pump Address command in the Settings menu. The address range is from 00 to 99. This address value is used to identify which pump is to receive a command and which pump is responding. The first pump in the chain, the one connected to the computer, must use address 0 (zero). Configure each pump with its assigned address and baud rate as described in the Pump Settings section of this guide.

NOTE *NOTE: When daisy-chaining using the optional RJ-11 connectors, all pumps must use the same baud rate. Values above 38400 are recommended.*

NOTE *NOTE: If you are using the optional RJ-11 connections for daisy-chaining, the connection from the computer must also come through the RJ-11 connectors.*

NOTE *NOTE: Once communication is established, if you manipulate the touch screen, you must reestablish communications to the PC (<CR> will do this)*

NOTE *NOTE: System commands and start/stop commands can be executed from Method or Method configuration screens. However, for parameter commands (rate, dia, vol, etc) it is necessary to execute from the Quick Start configuration screen.*

Using the Pump 11 Elite Series Pump Chain Commands

The following instructions will help you to utilize the Pump Chain commands feature on the Pump 11 Elite Series pump.

Commands may be abbreviated to the first four letters, i.e. address would be abbreviated addr. A space must follow the command if arguments are included.

If the pump address is nonzero, the one or two-digit pump address precedes the command. For example, to set the infuse rate for pump 12, the command would look like "12irat 3.2 u/m".

NOTE *If the USB port is used on a pump with a nonzero address, the pump address does not need to be used.*

Every line of the response from a pump with a nonzero address is prefixed by the two digit pump address (prefixed with a 0 if necessary) followed by a colon. No colon is used to separate the pump address from the prompt however.

In the command list below, the following convention is used:

{ }	Required parameter
[]	Optional parameter
	Separator between parameter choices
#	Numeric value without preceding zeros
###	Numeric value with preceding zeros
#-#	A range of values
<cr>	Carriage return
<lf>	Line feed
<sp>	Space
[prefix]	Pump address prefix in the format #: if the pump address is not zero
<prompt>	Prompt (see below)

The following prompts are returned after a command is executed:

:	The pump is idle
>	The pump is infusing
<	The pump is withdrawing
*	The pump stalled
T*	The target was reached

If the pump is in poll mode, an XON character is added after the prompt.

If the pump address is nonzero, the pump address is prefixed to the prompt without a colon.

In the following list of commands:

- The pump address is prefixed to every response line followed by a colon.
- <lf>[##]<prompt> is the response unless otherwise noted.

Error Messages

Error messages are displayed if the entered command cannot be executed for some reason. The error message will take up two lines with the first line being the message type and the second line describing the error itself. The second line may be up to 80 characters long.

Command Errors

Command errors are displayed when the command is unrecognized, entered in the wrong mode, or the state of the pump keeps the command from executing (i.e. using the IRUN command if a limit switch is active).

The command error has the following format:

```
<lf>[##:]Command error:<cr>
<lf>[##:]<sp><sp><sp>{error message}<cr>
<lf>[##]<prompt>
```

Argument Errors

Argument errors are displayed when a command argument is unrecognized or out of range. The argument in question will be displayed except in the case of missing arguments.

The argument error has the following format:

```
<lf>[##:]Argument error: [bad argument]<cr>
<lf>[##:]<sp><sp><sp>{error message}<cr>
<lf>[##]<prompt>
```

System commands

ADDRESS

Sets or displays the pump address. Valid range is 0 to 99.

Command format:

```
address [0-99]
```

Query response:

```
<lf>[##:]Pump address is #<cr>
<lf>[##]<prompt>
```

Notes: Pumps with an address of 0 are masters, and pumps with an address between 1 and 99 are slaves.

BAUD

Sets or displays the baud rate. Valid baud rates are 9600, 19200, 38400, 57600, 115200, 128000, 230400, 256000, 460800, and 921600. Note that some computers may not be able to handle baud rates above 115200.

Command format:

```
baud [9600 | 19200 | 38400 | 57600 | 115200 |
128000 | 230400 | 256000 | 460800 | 921600]
```

Query response:

```
<lf>[##:]# baud<cr>
<lf>[##]<prompt>
```

CATALOG

Displays a catalog of Methods stored in the pump.

Command format:

```
cat
```

Query response:

```
<lf>[##:]Method name   Size<cr>
<lf>[##:]-----  ---<cr>
<lf>[##:](Method name)   #<cr> This line is
repeated for each file on the disk
<lf><lf>[##:]# file(s) using # steps<cr>
<lf>[##]<prompt>
```

Notes: The file size is the number of steps in the Method plus one for the file information header.

The last line shows the number of files and the total number of steps being used on the disk.

DELMETHOD

Deletes a Method stored in the pump.

Command format:

```
delMethod {Method}
```

DIM

Sets or displays the backlight level in percent. Valid range is 0 to 100. Note that specifying 0 will turn the backlight off so that the screen will not be visible.

Command format:

```
dim [0-100]
```

Query response:

```
<lf>[##:]Backlight is set to #%<cr>
<lf>[##]<prompt>
```

ECHO

Sets or displays the USB echo state. Valid states are on or off.

Command format:

```
echo [onloff]
```

Query response:

```
<lf>[##:]Echo is OFF<cr>
```

```
<lf>[##]<prompt>
```

or:

```
<lf>[##:]Echo is ON<cr>
```

```
<lf>[##]<prompt>
```

FORCE

Sets or displays the infusion force level in percent. Valid range is 1 to 100.

Command format:

```
force [1-100]
```

Query response:

```
<lf>[##:]#%<cr>
```

```
<lf>[##]<prompt>
```

METRICS

Displays the pump metrics. The operation of this command is covered in the 11 Elite Configuration document.

Command format:

```
metrics
```

POLL

Sets or displays the polling mode state. In polling mode, prompts are inhibited if they aren't generated by a typed command. Valid states are on or off.

Command format:

```
poll [onloff]
```

Query response:

```
<lf>[##:]Polling mode is OFF<cr>
```

```
<lf>[##]<prompt>
```

or:

```
<lf>[##:]Polling mode is ON<cr>
```

```
<lf>[##]<prompt>
```

TIME

Sets or displays the date and time.

Command format:

```
time [mm/dd/yy] [hh:mm:ss]*
```

Query response:

```
<lf>[##:]###/###/### ##:##:## #M<cr>
```

```
<lf>[##]<prompt>
```

* 24 hour time format

VER

Displays the short version string.

Command format:

```
ver
```

Query response:

```
<lf>[##:] 11 Elite #.#.#<cr>
```

```
<lf>[##]<prompt>
```

VERSION

Displays the full version string.

Command format:

```
version
```

Query response:

```
<lf>[##:]Firmware: v#.#.#<cr>
```

```
<lf>[##:]RTOS: FreeRTOS v#.#.#  
(http://www.freertos.org)<cr>
```

```
<lf>[##:]Pump address: #<cr>
```

```
<lf>[##]<prompt>
```

Run commands

IRUN

Runs the pump in the infuse direction. Quick Start mode only.

Command format:

```
irun
rrun
```

Runs the pump in the opposite direction. Quick Start mode only.

Command format:

```
rrun
```

RUN

Simulates a key press of the run button located in the lower right corner of the screen.

Command format:

```
run
```

STOP / STP

Stops the pump.

Command format:

```
stop
stp
```

WRUN

Runs the pump in the withdraw direction. Quick Start mode only.

Command format:

```
wrun
```

Rate commands

CRATE

Displays the current rate that the motor is running at. A valid response is returned only in dynamic situations (while the pump is running). Quick Start mode only.

Command format:

```
crate
```

Query response:

```
<lf>[##:]Infusing at # xl/xxx<cr>
<lf>[##]<prompt>
```

or:

```
<lf>[##:]Withdrawing at # xl/xxx<cr>
<lf>[##]<prompt>
```

DIAMETER

Sets or displays the syringe diameter in mm. Quick Start mode only.

Command format:

```
diameter [{syringe diameter}]
```

Query response:

```
<lf>[##:]#.#### mm<cr>
<lf>[##]<prompt>
```

IRAMP

Sets or displays the target infusion rate while ramping. Quick Start mode only.

Command format:

```
iramp [{start rate} {start units} {end rate} {end units}
{ramp time in seconds}]
```

Query response:

```
<lf>[##:]Ramp not set up.<cr>
<lf>[##]<prompt>
```

or:

```
<lf>[##:]Starting rate: # xl/xxx<cr>
<lf>[##:]Ending rate: # xl/xxx<cr>
<lf>[##:]Ramp time: # seconds<cr>
<lf>[##]<prompt>
```

IRATE

Sets or displays the infusion rate. Quick Start mode only.

Command format:

```
irate [{rate} {rate units}] [max l min]
```

Query response:

```
<lf>[##:]# xl/xxx<cr>
<lf>[##]<prompt>
```

WRAMP

Sets or displays the target withdraw rate while ramping. Quick Start mode only.

Command format:

```
wramp [{start rate} {end rate} {rate units} {ramp
time in seconds}]
```

Query response:

```
<lf>[##:]Ramp not set up.<cr>
```

```
<lf>[##:]<prompt>
```

or:

```
<lf>[##:]Starting rate: # xl/xxx<cr>
```

```
<lf>[##:]Ending rate: # xl/xxx<cr>
```

```
<lf>[##:]Ramp time: # seconds<cr>
```

```
<lf>[##:]<prompt>
```

WRATE

Sets or displays the withdraw rate. Quick Start mode only.

Command format:

```
wrate [{rate} {rate units}] [max l min]
```

Query response:

```
<lf>[##:]# xl/xxx<cr>
```

```
<lf>[##:]<prompt>
```

Volume commands**CIVOLUME**

Clears the infused volume. Quick Start mode only.

Command format:

```
civolume
```

CTVOLUME

Clears the target volume. Quick Start mode only.

Command format:

```
ctvolume
```

NOTE

For commands requiring rate units, use the following format: m, u, n, p/h, m, s. ex: m/m = milliliter/minutes ex: n/s = nanoliter/second

CVOLUME

Clears both the infused and withdrawn volumes. Quick Start mode only.

Command format:

```
cvolume
```

CWVOLUME

Clears the withdrawn volume. Quick Start mode only.

Command format:

```
cwvolume
```

IVOLUME

Displays the infused volume. Quick Start mode only.

Command format:

```
ivolume
```

Query response:

```
<lf>[##:]# xl<cr>
```

```
<lf>[##:]<prompt>
```

SVOLUME

Sets or displays syringe volume. Quick Start mode only.

Command format:

```
svolume
```

TVOLUME

Sets or displays the target volume. Quick Start mode only.

Command format:

```
tvolume [{target volume} {volume units}]
```

Query response:

```
<lf>[##:]Target volume not set<cr>
```

```
<lf>[##:]<prompt>
```

or:

```
<lf>[##:] # xl/xxx<cr>
```

```
<lf>[##:]<prompt>
```

WVOLUME

Displays the withdrawn volume. Quick Start mode only.

Command format:

```
wvolume
```

Query response:

```
<lf>[##:]# xl<cr>
```

```
<lf>[##:]<prompt>
```

Time commands

CITIME

Clears the infused time. Quick Start mode only.

Command format:

ctime

CTIME

Clears both the infused and withdrawn times. Quick Start mode only.

Command format:

ctime

CTTIME

Clears the target time. Quick Start mode only.

Command format:

cttime

CWTIME

Clears the withdrawn time. Quick Start mode only.

Command format:

cwtime

ITIME

Displays the infused time. Quick Start mode only.

Command format:

itime

Query response:

<lf>[##:]# seconds<cr>

<lf>[##]<prompt>

or:

<lf>[##:]###.###.###<cr>

<lf>[##]<prompt>

TTIME

Sets or displays the target time. Quick Start mode only.

Command format:

ttime [{target time}]

Query response:

<lf>[##:]Target time not set<cr>

<lf>[##]<prompt>

or:

<lf>[##:]# seconds<cr>

<lf>[##]<prompt>

or:

<lf>[##:]###.###.###<cr>

<lf>[##]<prompt>

WTIME

Displays the withdrawn time. Quick Start mode only.

Command format:

wtime

Query response:

<lf>[##:]# seconds<cr>

<lf>[##]<prompt>

or:

<lf>[##:]###.###.###<cr>

<lf>[##]<prompt>

Digital I/O commands

INPUT

Reads and displays the trigger input port status.

Command format:

input

Query response:

<lf>[##:]The trigger input is low.<cr>

<lf>[##]<prompt>

or:

<lf>[##:]The trigger input is high.<cr>

<lf>[##]<prompt>

OUTPUT

Sets the level on the output port.

Command format:

```
output {1} {high | low}
```

Internal commands**STATUS**

Displays the raw status for use with a controlling computer.

Command format:

```
status
```

Serial Command Notes

The output is in three integer fields and one flag field, all separated by spaces and terminated by a carriage return/linefeed pair. The first integer is the current rate in femtoliters per second. The second integer is the infuse time in clock cycles. One clock cycle is 1/56,000,000 second. The time has a granularity of 1 millisecond. The third integer is the infused volume in femtoliters. All three values are for the current direction.

The flag field consists of six flags.

Flag one is the motor direction and will be "I" if the pump is infusing and "w" if the pump is withdrawing. If the letter is lower case, the pump motor is idle. If upper case, the pump motor is running.

Flag two is the limit switch status. If the infuse limit switch was hit, "I" is displayed. If the withdraw limit switch was hit, "W" is displayed. If no limit switch was hit or the pump does not have limit switches, "." is displayed.

NOTE

The Pump 11 Elite does not contain limit switches, so "." will be displayed.

Flag three is the stall status and will be "S" if the pump has stalled. Otherwise it will be ".".

Flag four is the trigger input state and will be "T" if high and "." if low.

Flag five is the direction port state and will be "I" for infuse and "W" for withdraw.

Flag six is the target reached status. It will be "T" if the target time or volume was reached and "." if not.

Appendices

APPENDIX A: SYRINGE VOLUME/DIAMETER REFERENCE TABLE

<p>Harvard Apparatus Stainless Steel</p> <table border="1"> <thead> <tr> <th>Size</th> <th>Diameter</th> </tr> </thead> <tbody> <tr> <td>2.5 ml</td> <td>4.851 mm</td> </tr> <tr> <td>8</td> <td>9.525</td> </tr> <tr> <td>20</td> <td>19.13</td> </tr> <tr> <td>50</td> <td>28.6</td> </tr> </tbody> </table> <hr/> <p>Air-Tite HSW Norm-Ject</p> <table border="1"> <thead> <tr> <th>Size</th> <th>Diameter</th> </tr> </thead> <tbody> <tr> <td>1 ml</td> <td>4.69 mm</td> </tr> <tr> <td>2.5</td> <td>9.65</td> </tr> <tr> <td>5</td> <td>12.45</td> </tr> <tr> <td>10</td> <td>15.9</td> </tr> <tr> <td>20</td> <td>20.05</td> </tr> <tr> <td>30</td> <td>22.9</td> </tr> <tr> <td>50</td> <td>29.2</td> </tr> </tbody> </table> <hr/> <p>Becton Dickinson 'Plasti-pak'</p> <table border="1"> <thead> <tr> <th>Size</th> <th>Diameter</th> </tr> </thead> <tbody> <tr> <td>1 ml</td> <td>4.699 mm</td> </tr> <tr> <td>3</td> <td>8.585</td> </tr> <tr> <td>5</td> <td>11.989</td> </tr> <tr> <td>10</td> <td>14.427</td> </tr> <tr> <td>20</td> <td>19.05</td> </tr> <tr> <td>30</td> <td>21.59</td> </tr> <tr> <td>50</td> <td>26.594</td> </tr> <tr> <td>60</td> <td>26.594</td> </tr> </tbody> </table> <hr/> <p>Terumo</p> <table border="1"> <thead> <tr> <th>Size</th> <th>Diameter</th> </tr> </thead> <tbody> <tr> <td>1 ml</td> <td>4.70 mm</td> </tr> <tr> <td>3</td> <td>8.95 mm</td> </tr> <tr> <td>5</td> <td>13</td> </tr> <tr> <td>10</td> <td>15.8</td> </tr> <tr> <td>20</td> <td>20.15</td> </tr> <tr> <td>30</td> <td>23.1</td> </tr> <tr> <td>60</td> <td>29.1</td> </tr> </tbody> </table>	Size	Diameter	2.5 ml	4.851 mm	8	9.525	20	19.13	50	28.6	Size	Diameter	1 ml	4.69 mm	2.5	9.65	5	12.45	10	15.9	20	20.05	30	22.9	50	29.2	Size	Diameter	1 ml	4.699 mm	3	8.585	5	11.989	10	14.427	20	19.05	30	21.59	50	26.594	60	26.594	Size	Diameter	1 ml	4.70 mm	3	8.95 mm	5	13	10	15.8	20	20.15	30	23.1	60	29.1	<p>SGE Scientific Glass Engineering</p> <table border="1"> <thead> <tr> <th>Size</th> <th>Diameter</th> </tr> </thead> <tbody> <tr> <td>5 μl</td> <td>0.343 mm</td> </tr> <tr> <td>10</td> <td>0.485</td> </tr> <tr> <td>25</td> <td>0.728</td> </tr> <tr> <td>50</td> <td>1.03</td> </tr> <tr> <td>100</td> <td>1.457</td> </tr> <tr> <td>250</td> <td>2.303</td> </tr> <tr> <td>500</td> <td>3.257</td> </tr> </tbody> </table> <hr/> <p>1 ml 4.606 mm 2.5 7.284 5 10.301 10 14.567 25 23 50 27.5</p> <hr/> <p>Hamilton Glass - All Types</p> <table border="1"> <thead> <tr> <th>Size</th> <th>Diameter</th> </tr> </thead> <tbody> <tr> <td>0.5 μl</td> <td>0.103 mm</td> </tr> <tr> <td>1</td> <td>0.146</td> </tr> <tr> <td>2</td> <td>0.206</td> </tr> <tr> <td>5</td> <td>0.343</td> </tr> <tr> <td>10</td> <td>0.485</td> </tr> <tr> <td>25</td> <td>0.729</td> </tr> <tr> <td>50</td> <td>1.03</td> </tr> <tr> <td>100</td> <td>1.457</td> </tr> <tr> <td>250</td> <td>2.304</td> </tr> <tr> <td>500</td> <td>3.256</td> </tr> </tbody> </table> <hr/> <p>1 ml 4.608 mm 1.25 5.151 2.5 7.285 5 10.3 10 14.567 25 23.033 50 32.573</p>	Size	Diameter	5 μ l	0.343 mm	10	0.485	25	0.728	50	1.03	100	1.457	250	2.303	500	3.257	Size	Diameter	0.5 μ l	0.103 mm	1	0.146	2	0.206	5	0.343	10	0.485	25	0.729	50	1.03	100	1.457	250	2.304	500	3.256	<p>Cadence Science, Inc. Formerly Popper & Sons MICRO-MATE Glass</p> <table border="1"> <thead> <tr> <th>Size</th> <th>Diameter</th> </tr> </thead> <tbody> <tr> <td>0.25 ml</td> <td>3.47 mm</td> </tr> <tr> <td>0.5</td> <td>3.62</td> </tr> <tr> <td>1</td> <td>4.82</td> </tr> <tr> <td>2</td> <td>8.91</td> </tr> <tr> <td>3</td> <td>8.91</td> </tr> <tr> <td>5</td> <td>11.71</td> </tr> <tr> <td>10</td> <td>14.65</td> </tr> <tr> <td>20</td> <td>19.56</td> </tr> <tr> <td>30</td> <td>22.7</td> </tr> <tr> <td>50</td> <td>28.02</td> </tr> </tbody> </table> <hr/> <p>Becton Dickinson Glass-All Types</p> <table border="1"> <thead> <tr> <th>Size</th> <th>Diameter</th> </tr> </thead> <tbody> <tr> <td>0.5 ml</td> <td>4.64 mm</td> </tr> <tr> <td>1</td> <td>4.64</td> </tr> <tr> <td>2.5</td> <td>8.66</td> </tr> <tr> <td>5</td> <td>11.86</td> </tr> <tr> <td>10</td> <td>14.34</td> </tr> <tr> <td>20</td> <td>19.13</td> </tr> <tr> <td>30</td> <td>22.7</td> </tr> <tr> <td>50</td> <td>28.6</td> </tr> </tbody> </table> <hr/> <p>Sherwood-Mono-ject Plastic</p> <table border="1"> <thead> <tr> <th>Size</th> <th>Diameter</th> </tr> </thead> <tbody> <tr> <td>1 ml</td> <td>4.674 mm</td> </tr> <tr> <td>3</td> <td>8.865</td> </tr> <tr> <td>6</td> <td>12.600</td> </tr> <tr> <td>12</td> <td>15.621</td> </tr> <tr> <td>20</td> <td>20.142</td> </tr> <tr> <td>35</td> <td>23.571</td> </tr> <tr> <td>60</td> <td>26.568</td> </tr> </tbody> </table>	Size	Diameter	0.25 ml	3.47 mm	0.5	3.62	1	4.82	2	8.91	3	8.91	5	11.71	10	14.65	20	19.56	30	22.7	50	28.02	Size	Diameter	0.5 ml	4.64 mm	1	4.64	2.5	8.66	5	11.86	10	14.34	20	19.13	30	22.7	50	28.6	Size	Diameter	1 ml	4.674 mm	3	8.865	6	12.600	12	15.621	20	20.142	35	23.571	60	26.568	<p>Hoshi</p> <table border="1"> <thead> <tr> <th>Size</th> <th>Diameter</th> </tr> </thead> <tbody> <tr> <td>1 ml</td> <td>6.50 mm</td> </tr> <tr> <td>2</td> <td>9.10</td> </tr> <tr> <td>3</td> <td>10.00</td> </tr> <tr> <td>5</td> <td>12.60</td> </tr> <tr> <td>10</td> <td>15.10</td> </tr> <tr> <td>20</td> <td>20.45</td> </tr> <tr> <td>30</td> <td>22.50</td> </tr> <tr> <td>50</td> <td>25.60</td> </tr> </tbody> </table> <hr/> <p>Natsume</p> <table border="1"> <thead> <tr> <th>Size</th> <th>Diameter</th> </tr> </thead> <tbody> <tr> <td>0.25 ml</td> <td>2.5 mm</td> </tr> <tr> <td>0.50</td> <td>2.8</td> </tr> <tr> <td>1</td> <td>4.0</td> </tr> <tr> <td>2</td> <td>6.2</td> </tr> <tr> <td>3</td> <td>7.4</td> </tr> <tr> <td>5</td> <td>9.2</td> </tr> </tbody> </table> <hr/> <p>Top</p> <table border="1"> <thead> <tr> <th>Size</th> <th>Diameter</th> </tr> </thead> <tbody> <tr> <td>1 ml</td> <td>6.40 mm</td> </tr> <tr> <td>2.5</td> <td>9.30</td> </tr> <tr> <td>5</td> <td>13.10</td> </tr> <tr> <td>10</td> <td>15.3</td> </tr> <tr> <td>20</td> <td>21.0</td> </tr> <tr> <td>30</td> <td>23.0</td> </tr> <tr> <td>50</td> <td>29.0</td> </tr> </tbody> </table> <hr/> <p>NIPRO</p> <table border="1"> <thead> <tr> <th>Size</th> <th>Diameter</th> </tr> </thead> <tbody> <tr> <td>1 ml short</td> <td>6.6 mm</td> </tr> <tr> <td>1 ml long</td> <td>4.7</td> </tr> <tr> <td>2.5 ml</td> <td>9.0</td> </tr> <tr> <td>5</td> <td>13.0</td> </tr> <tr> <td>10</td> <td>15.8</td> </tr> <tr> <td>20</td> <td>20.1</td> </tr> <tr> <td>30</td> <td>23.2</td> </tr> <tr> <td>50</td> <td>29.1</td> </tr> </tbody> </table>	Size	Diameter	1 ml	6.50 mm	2	9.10	3	10.00	5	12.60	10	15.10	20	20.45	30	22.50	50	25.60	Size	Diameter	0.25 ml	2.5 mm	0.50	2.8	1	4.0	2	6.2	3	7.4	5	9.2	Size	Diameter	1 ml	6.40 mm	2.5	9.30	5	13.10	10	15.3	20	21.0	30	23.0	50	29.0	Size	Diameter	1 ml short	6.6 mm	1 ml long	4.7	2.5 ml	9.0	5	13.0	10	15.8	20	20.1	30	23.2	50	29.1
Size	Diameter																																																																																																																																																																																																																														
2.5 ml	4.851 mm																																																																																																																																																																																																																														
8	9.525																																																																																																																																																																																																																														
20	19.13																																																																																																																																																																																																																														
50	28.6																																																																																																																																																																																																																														
Size	Diameter																																																																																																																																																																																																																														
1 ml	4.69 mm																																																																																																																																																																																																																														
2.5	9.65																																																																																																																																																																																																																														
5	12.45																																																																																																																																																																																																																														
10	15.9																																																																																																																																																																																																																														
20	20.05																																																																																																																																																																																																																														
30	22.9																																																																																																																																																																																																																														
50	29.2																																																																																																																																																																																																																														
Size	Diameter																																																																																																																																																																																																																														
1 ml	4.699 mm																																																																																																																																																																																																																														
3	8.585																																																																																																																																																																																																																														
5	11.989																																																																																																																																																																																																																														
10	14.427																																																																																																																																																																																																																														
20	19.05																																																																																																																																																																																																																														
30	21.59																																																																																																																																																																																																																														
50	26.594																																																																																																																																																																																																																														
60	26.594																																																																																																																																																																																																																														
Size	Diameter																																																																																																																																																																																																																														
1 ml	4.70 mm																																																																																																																																																																																																																														
3	8.95 mm																																																																																																																																																																																																																														
5	13																																																																																																																																																																																																																														
10	15.8																																																																																																																																																																																																																														
20	20.15																																																																																																																																																																																																																														
30	23.1																																																																																																																																																																																																																														
60	29.1																																																																																																																																																																																																																														
Size	Diameter																																																																																																																																																																																																																														
5 μ l	0.343 mm																																																																																																																																																																																																																														
10	0.485																																																																																																																																																																																																																														
25	0.728																																																																																																																																																																																																																														
50	1.03																																																																																																																																																																																																																														
100	1.457																																																																																																																																																																																																																														
250	2.303																																																																																																																																																																																																																														
500	3.257																																																																																																																																																																																																																														
Size	Diameter																																																																																																																																																																																																																														
0.5 μ l	0.103 mm																																																																																																																																																																																																																														
1	0.146																																																																																																																																																																																																																														
2	0.206																																																																																																																																																																																																																														
5	0.343																																																																																																																																																																																																																														
10	0.485																																																																																																																																																																																																																														
25	0.729																																																																																																																																																																																																																														
50	1.03																																																																																																																																																																																																																														
100	1.457																																																																																																																																																																																																																														
250	2.304																																																																																																																																																																																																																														
500	3.256																																																																																																																																																																																																																														
Size	Diameter																																																																																																																																																																																																																														
0.25 ml	3.47 mm																																																																																																																																																																																																																														
0.5	3.62																																																																																																																																																																																																																														
1	4.82																																																																																																																																																																																																																														
2	8.91																																																																																																																																																																																																																														
3	8.91																																																																																																																																																																																																																														
5	11.71																																																																																																																																																																																																																														
10	14.65																																																																																																																																																																																																																														
20	19.56																																																																																																																																																																																																																														
30	22.7																																																																																																																																																																																																																														
50	28.02																																																																																																																																																																																																																														
Size	Diameter																																																																																																																																																																																																																														
0.5 ml	4.64 mm																																																																																																																																																																																																																														
1	4.64																																																																																																																																																																																																																														
2.5	8.66																																																																																																																																																																																																																														
5	11.86																																																																																																																																																																																																																														
10	14.34																																																																																																																																																																																																																														
20	19.13																																																																																																																																																																																																																														
30	22.7																																																																																																																																																																																																																														
50	28.6																																																																																																																																																																																																																														
Size	Diameter																																																																																																																																																																																																																														
1 ml	4.674 mm																																																																																																																																																																																																																														
3	8.865																																																																																																																																																																																																																														
6	12.600																																																																																																																																																																																																																														
12	15.621																																																																																																																																																																																																																														
20	20.142																																																																																																																																																																																																																														
35	23.571																																																																																																																																																																																																																														
60	26.568																																																																																																																																																																																																																														
Size	Diameter																																																																																																																																																																																																																														
1 ml	6.50 mm																																																																																																																																																																																																																														
2	9.10																																																																																																																																																																																																																														
3	10.00																																																																																																																																																																																																																														
5	12.60																																																																																																																																																																																																																														
10	15.10																																																																																																																																																																																																																														
20	20.45																																																																																																																																																																																																																														
30	22.50																																																																																																																																																																																																																														
50	25.60																																																																																																																																																																																																																														
Size	Diameter																																																																																																																																																																																																																														
0.25 ml	2.5 mm																																																																																																																																																																																																																														
0.50	2.8																																																																																																																																																																																																																														
1	4.0																																																																																																																																																																																																																														
2	6.2																																																																																																																																																																																																																														
3	7.4																																																																																																																																																																																																																														
5	9.2																																																																																																																																																																																																																														
Size	Diameter																																																																																																																																																																																																																														
1 ml	6.40 mm																																																																																																																																																																																																																														
2.5	9.30																																																																																																																																																																																																																														
5	13.10																																																																																																																																																																																																																														
10	15.3																																																																																																																																																																																																																														
20	21.0																																																																																																																																																																																																																														
30	23.0																																																																																																																																																																																																																														
50	29.0																																																																																																																																																																																																																														
Size	Diameter																																																																																																																																																																																																																														
1 ml short	6.6 mm																																																																																																																																																																																																																														
1 ml long	4.7																																																																																																																																																																																																																														
2.5 ml	9.0																																																																																																																																																																																																																														
5	13.0																																																																																																																																																																																																																														
10	15.8																																																																																																																																																																																																																														
20	20.1																																																																																																																																																																																																																														
30	23.2																																																																																																																																																																																																																														
50	29.1																																																																																																																																																																																																																														

Suggested Force Level Settings for Common Syringes

Syringe Type/Material	Capacity	Force Setting	Common Manufacturer(s)
Plastic Syringes	\leq 5ml	50%	BD plastic, Sherwood, Airtite, Terumo
	>5ml	100%	
Stainless Steel	All	100%	Harvard Apparatus
Glass/Glass	\leq 20ml	30%	Cadence (Popper)
	>20ml	50%	
Glass/Plastic	\leq 250 μ l	30%	Hamilton, SGE
	\leq 5ml	50%	
	>5ml	100%	

NOTE The Pump 11 Elite can accommodate syringes ranging from 0.5 μ l to 60 ml single syringe and 0.5 μ l to 10 ml dual syringe.

NOTE NOTE: The Pico Plus Elite can accommodate syringes ranging from 0.5 μ l to 10 ml.

APPENDIX B: PUMP 11 ELITE MIN/MAX FLOW RATES

Nominal Minimum/Maximum Flow Rates for Various Syringes. (Actual Limits will vary depending on syringe manufacturer)					
Syringe Size	Syringe ID	Minimum Rate	Units	Maximum Rate	Units
0.5 μ l	0.103 mm	1.26	pl/min	1.325	μ l/min
1 μ l	0.146 mm	2.52	pl/min	2.65	μ l/min
2 μ l	0.206 mm	5.1	pl/min	5.299	μ l/min
5 μ l	0.343 mm	14.1	pl/min	14.69	μ l/min
10 μ l	0.485 mm	28.26	pl/min	29.38	μ l/min
25 μ l	0.729 mm	63.9	pl/min	66.37	μ l/min
50 μ l	1.030 mm	127.6	pl/min	132.5	μ l/min
100 μ l	1.457 mm	255.2	pl/min	265.1	μ l/min
250 μ l	2.304 mm	638.3	nl/min	662.9	μ l/min
500 μ l	3.256 mm	1.275	nl/min	1.324	ml/min
1000 μ l	4.608 mm	2.553	nl/min	2.652	ml/min
1 ml	5.151 mm	3.191	nl/min	3.313	ml/min
3 ml	8.585 mm	8.863	nl/min	9.204	ml/min
5 ml	11.99 mm	17.29	nl/min	17.95	ml/min
10 ml	14.43 mm	25.03	nl/min	25.99	ml/min
20 ml	19.05 mm	43.64	nl/min	45.32	ml/min
30 ml	21.59 mm	56.05	nl/min	58.21	ml/min
50 ml	26.59 mm	85.05	nl/min	88.32	ml/min
60 ml	26.59 mm	85.05	nl/min	88.32	ml/min

PICO PLUS ELITE MIN/MAX FLOW RATES

Nominal Minimum/Maximum Flow Rates for Various Syringes. (Actual Limits will vary depending on syringe manufacturer)					
Syringe Size	Syringe ID	Minimum Rate	Units	Maximum Rate	Units
0.5 μ l	0.103 mm	0.54	pl/min	596.2	nl/min
1 μ l	0.1457 mm	1.14	pl/min	1.193	μ l/min
2 μ l	0.206 mm	2.28	pl/min	2.385	μ l/min
5 μ l	0.343 mm	6.36	pl/min	6.612	μ l/min
10 μ l	0.485 mm	12.72	pl/min	13.22	μ l/min
25 μ l	0.729 mm	28.74	pl/min	29.87	μ l/min
50 μ l	1.030 mm	57.36	pl/min	59.62	μ l/min
100 μ l	1.457 mm	114.8	pl/min	119.3	μ l/min
250 μ l	2.304 mm	287.2	nl/min	298.3	μ l/min
500 μ l	3.256 mm	573.7	nl/min	595.8	μ l/min
1000 μ l	4.608 mm	1.149	nl/min	1.193	ml/min
1 ml	4.699 mm	1.195	nl/min	1.241	ml/min
3 ml	8.585 mm	3.988	nl/min	4.142	ml/min
5 ml	11.989 mm	7.778	nl/min	8.078	ml/min
10 ml	14.430 mm	11.26	nl/min	11.7	ml/min

APPENDIX C: EXTERNAL CONNECTIONS

User I/O Connector Specifications

Pin Assignments

1. **Direction control input**
Rising edge sets pump to infuse
Falling edge sets pump to refill
2. **Trigger Input**
Event trigger – falling edge triggers a Method event
3. **Footswitch Input**
Momentary switch closure to ground or TTL Logic Low; falling edge toggles between states (run/stop)
4. **Trigger 1 Output**
TTL Logic Output-Default = Low Control thru Method or serial comm
- 9-13. **Signal Return / Ground**
14. **Run Indicator Voltage**
+5V through a 470 ohm resistor (connect to LED Anode)
15. **Run Indicator Output**
TTL Logic Output, active low (low = run) (connect to LED Cathode)

Electrical Specifications

Inputs:	$V_{IH} \geq 2V$	$I_{IH} \leq 20\mu A$
	$V_{IL} \leq 0.4V$	$I_{IL} \leq 0.5mA$
Outputs:	$V_{OH} \geq 3.8V$	$I_{OH} \leq 6mA$
	$V_{OL} \leq 0.4V$	$I_{OL} \leq 6mA$

All Inputs are pulled high to +5 Vdc through a 10k resistor All Outputs are at TTL Logic Levels

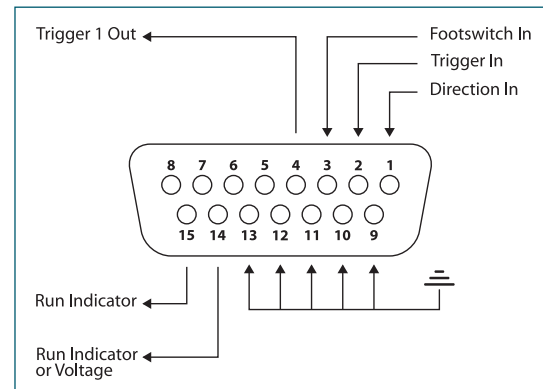

User I/O Connector Specifications

Utilizing the USB Interface

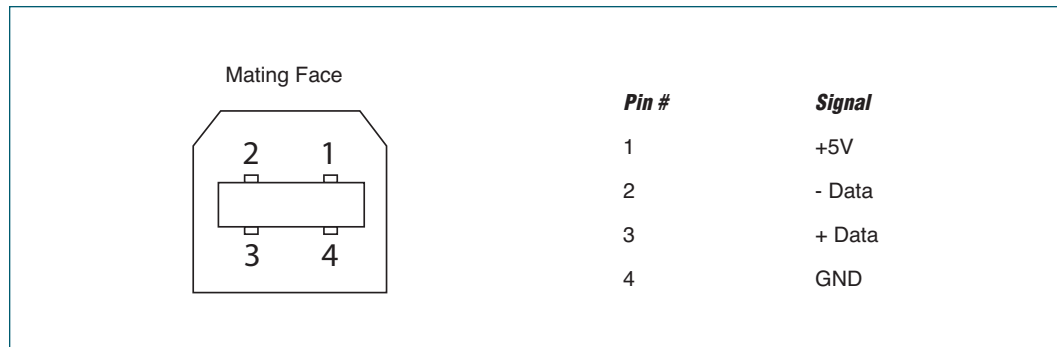

USB VIRTUAL COMMPORT DRIVER INSTALLATION

When you connect the Pump 11 Elite Series pump to a computer via USB for the first time, Windows will seek to install a driver for communication. The following section details the installation of the Virtual CommPort Driver supplied with the Pump 11 Elite Series Pump.



1. On connection of the pump to the computer via USB, the Found New Hardware Wizard will launch and ask how you wish to locate the driver. Choose "No, not this time" and click Next.

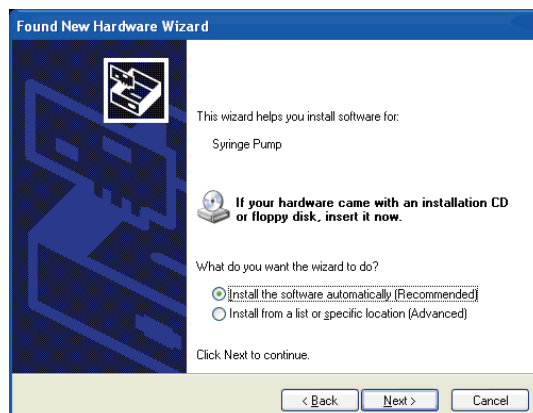

2. Choose "Install from a list or specific location (Advanced)" and click Next.

USB VIRTUAL COMMPORT DRIVER INSTALLATION (CONTINUED)

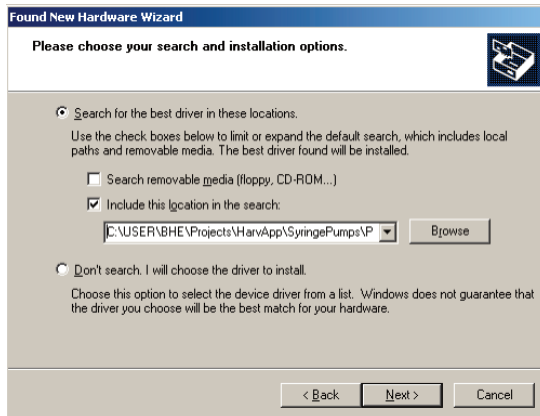

3. Browse for the proper USB driver installation folder in the USB folder and then click next. It can be found on the CD supplied with the Pump 11 Elite Series Pump.

USB Driver: WindowsXP or Vista

USB Driver: Windows2000

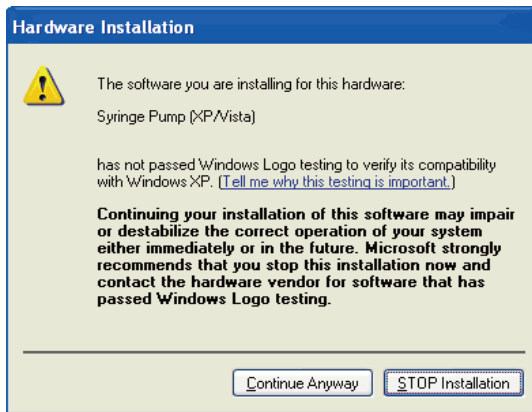

4. If a warning message regarding Windows Logo testing is displayed, choose Continue Anyway to proceed with the installation.

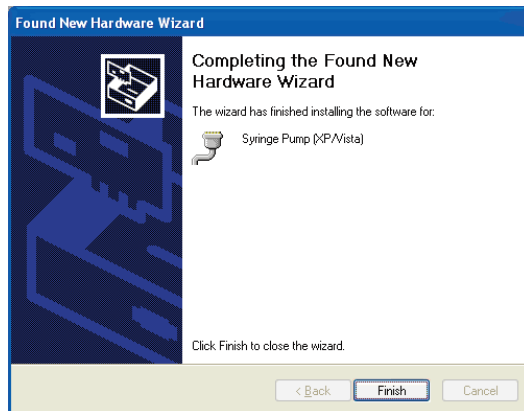

5. The Virtual Commport software will be installed. When the software installation is complete, click Finish to close the wizard.

RS-485

 CAUTION: DO NOT CONNECT TO FIREWIRE PORTS ON A PC. DAMAGE MAY OCCUR TO PUMP AND/OR PC.

Pin #	RS-485 In Signal	RS-485 Out Signal	Notes
1	PWR IN	PWR OUT (+30V)	* Protected by resettable fuse
2	GND	GND	
3	RS-485 A	TIED TO PIN 4**	** 100 Ω, ½ w to GND termination
4	RS-485 B	TIED TO PIN 3**	
5	TIED TO PIN 6**	RS-485 A	
6	TIED TO PIN 5**	RS-485 B	

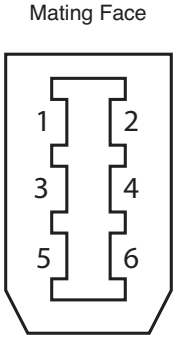

RS-485 In/Out - IEEE-1394 Sockets

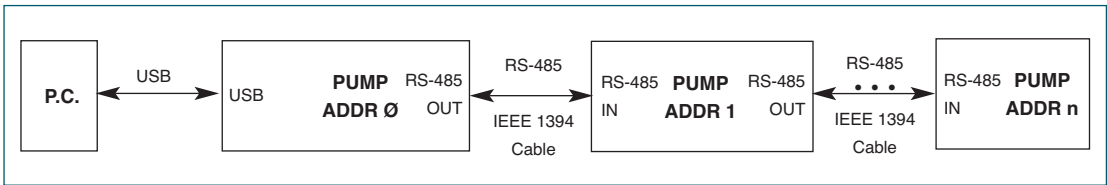

Daisy-Chaining via RS-485

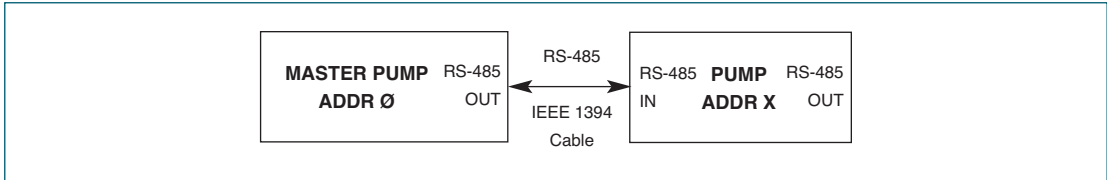

Gradient Connections via RS-485

NOTE When daisy-chaining with RS-485, at minimum, every fourth pump must be self powered (i.e., another stand-alone unit). This can be affected by Force Selection.

NOTE Power may be removed from any group of pumps, except the first group, without affecting communications "down-stream".

NOTE When applying power to pumps in a daisy-chain, apply power to the last group and work backwards.

NOTE When removing power, be sure to remember that power removed from a stand-alone unit will also cause power to be removed from all RS-485 powered units deriving power from it.

Legacy RJ-11 Option

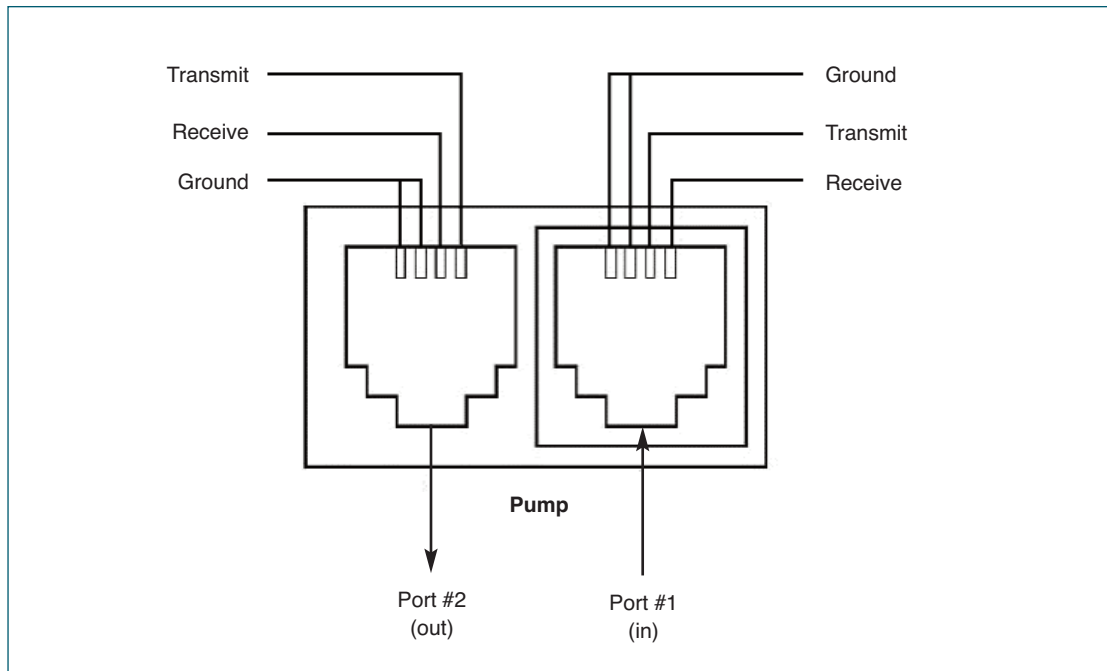

Pumps with Legacy RJ-11 Option

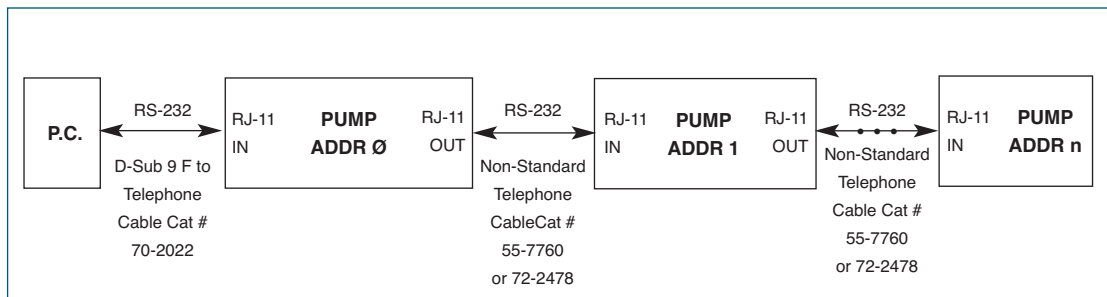

Daisy-Chaining with Legacy RJ-11 Option

NOTE Pumps 1...n also have RJ-11 telephone jacks.

APPENDIX D: MAINTENANCE

Maintenance

Pump 11 Elite Series pumps require no special maintenance other than keeping them clean by avoiding accidental spills of pumped material. Refer to the chemical compatibility chart below for specific chemical resistance information.

The two guide rods and the lead screw should be sparingly lubricated periodically; every 100 hrs the pump will remind you. The guide rods and the lead screw

should be lubricated with Super Lube Synthetic Grease provided with the pump.

To clean the exterior surfaces, use a lint-free cloth to remove loose dust. Use care to avoid scratching the clear display window. For more efficient cleaning, use a soft cloth dampened [not soaked] with water, an aqueous solution of 75% isopropyl alcohol, or a mild detergent.

Chemical Compatibility Chart			
Chemical	Concentration	Overlay Cover	Overlay Adhesive
Acetonitrile	99.5%	A	A
Methyl alcohol	99.8%	A	-
Hydrochloric Acid	36.5%	A	A
Bleach	100%	A	A
Windex®	100%	A	A
Isopropyl Alcohol	99.5%	A	D
Dish Soap	-	A	A
Motor Oil	100%	A	A
Simple Green	100%	A	A
Gasoline	100%	A	D
Ethylene Glycol (Antifreeze)	100%	A	A
Mineral Oil	100%	A	A
Ammonia	27.0%	A	A
Magnalube	100%	A	A
Superlube	100%	A	A
Acetone	99.5%	A	D
Soda (Coca-Cola)®	100%	A	A
Sulfuric Acid	95.0%	D	D
Dimethyl Sulfoxide	99.9%	A	C
Sodium Hydroxide	50%	A	A
Nitric Acid	68.0%	D	D
Chloroform	100%	D	D

The chemical resistance data provided is for reference only. The data is based on the manufacturer's recommendations and is not a guarantee of chemical compatibility for your test conditions. Wipe any spills immediately.

- A Satisfactory
- B Fair, Minor Effects
- C Poor, Moderate Effects
- D Severe Effects
- Not tested

Upgrading Pump 11 Elite Series Software

1. Upload the latest software version to your desktop (format is filename.dfu).
2. Connect the pump to PC using a USB cable.
3. On the Settings screen, press the Upgrade Software button twice to enter "Boot Loader Mode". The pumps screen will be blank and the light should be flashing.

NOTE

To exit boot loader mode without upgrading the software, power cycle the pump.

4. Disconnect then reconnect the USB cable.
5. From the CD provided with the pump, open the Pump 11 Elite Series Flash Upgrade Application.
6. Check "Verify after download" then click browse. Browse to the file previously saved on your desktop and click open.
7. Click upgrade. The previous software will first be erased, the new software will be loaded, and finally the software will be verified.
8. Disconnect the USB cable and power cycle the pump.

NOTE

First time users will need to install the Pump 11 Elite Series USB driver as well as the bootloader driver file (Pump 11 Elite Series-Bootloader.inf). Reference "USB Virtual Compact Driver Installation".

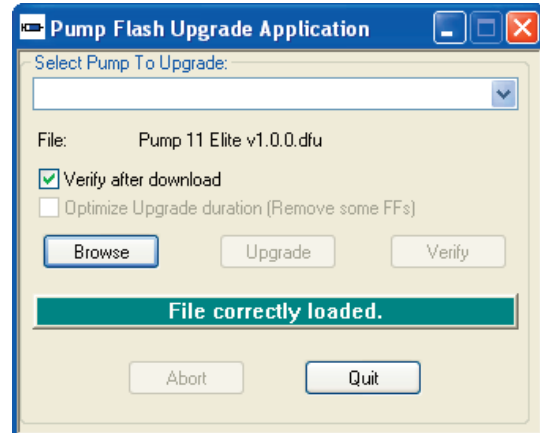

TROUBLESHOOTING

1. Infusion Accuracy

To ensure infusion accuracy always use new syringe(s) and measure syringe bore diameter and enter actual dimensions in millimeters (mm) using the Custom Syringe entry option. Additionally, make sure that the guide rods and lead screw are properly lubricated.

NOTE *It is recommended that you save your Methods periodically by uploading them to a PC.*

Pump 11 Elite Series Display Error Messages

2. Motor Stalled

This indicates that the pusher block travel has been impeded. This may be caused by the syringe plunger hitting bottom, a kink in the tubing (occlusion), syringe plunger binding, incorrect positioning of mechanical stop collars or any situation requiring more force to the head of the syringe than the pump is capable of delivering. To restart the pump, remove the cause of stalling and/or increase the force setting, then press RUN. The pump will continue the interrupted procedure where it stopped.

3. Out of Range

A value was entered or encountered in a pump Method that was beyond the pump's limits.

4. Power Failure Notification

If power to the pump is interrupted during operation, an alarm will sound (if alarm is activated) to alert the user to the interruption. When power is restored, an onscreen message is displayed to indicate the interruption.

5. Overload Protection

The Pump 11 Elite incorporates resettable fuses for overload protection. In the event of an overload, power to the pump may be disconnected. Try to determine and remove the source of the overload, wait a few minutes, and then re-apply power to the pump.

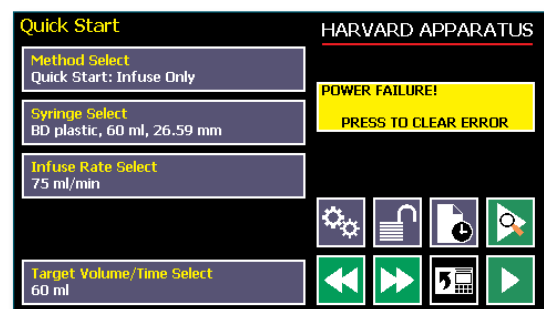

The Pump 11 Elite Series Pump will notify you of a power failure with a message when power is restored

APPENDIX E: ORDERING INFORMATION**Standard Version**

Description	Single Syringe	Dual Syringe
Pump 11 Elite Infusion Only	70-4500	70-4501
Pump 11 Elite Infusion/Withdrawal Programmable	70-4504	70-4505
Pump 11 Pico Plus Elite Infusion/Withdrawal Programmable	—	70-4506

Options

Description	Catalog Number
RS-232 RJ-11 Connectors Option (Only available with Programmable Models)	70-3030

**If needed, must be ordered at the same time as the Elite pump*

Accessories

Description	Catalog Number
RS-485 Cable for Pump-to-Pump Communication, 0.5 m (2 ft)	70-4000
RS-485 Cable for Pump-to-Pump Communication, 1 m (3 ft)	70-4021
RS-485 Cable for Pump-to-Pump Communication, 2 m (7 ft)	70-4001
RS-485 Cable for Pump-to-Pump Communication, 9 m (30 ft)	70-4020
USB Cable for PC-to-Pump Communication, 2 m (7 ft)	70-4002
USB Cable for PC-to-Pump Communication, 5 m (16 ft)	70-4003
Cable Assy, Daisy-chain, Legacy RS-232 RJ-11, 0.5 m (2 ft)	55-7760
Cable Assy, Daisy-chain, Legacy RS-232 RJ-11, 2 m (7 ft)	72-2478
Line Cord, US (115 v)	5113-001
Adapter, Digital I/O	70-4005
Adapter, D-sub 15 to Term. Blk	70-4006
Footswitch (w/ Phono Plug)	70-2215
Adapter for 25ml, 50ml Hamilton GasTight™ syringes	55-8000
Hex Key, 3/32	5012-005
Lubricant, SuperLube, 1cc	70-4013

For additional items such as Syringes, Tubing, Syringe Heaters, Spill Sensors, Temperature Controllers, Nano-Fluidic Accessories, and much more please visit our website www.harvardapparatus.com or call (800) 272-2775.

Declaration of Conformity

Manufacturer: *Harvard Apparatus, Inc.
84 October Hill Road
Holliston, Massachusetts 01746-1388, U.S.A.
Phone: (508) 893-8999*

We herewith declare that the following product:

Product Name: *Pump 11 Elite Syringe Pump Series*
Model No.: *Pump 11 Elite - Catalog # 70-45xx*

To which this declaration relates, is in conformity with the applicable EC Directives, harmonized standards, and other normative requirements:

Application of Council Directive(s): *2006/95/EC Low Voltage Directive
2004/108/EC Electromagnetic Compatibility Directive
2002/95/EC RoHS Directive*

Standard(s) to which conformity is declared:

Safety: *EN 61010-1:2001 (2nd Edition)*
Emissions/Immunity: *EN 61326:2006/05/01
EN 61000-4-2:1995 + A1:1998+A2:2001
EN 61000-4-3:2002
EN 61000-4-4:2004
EN 61000-4-5:1995+A1:2001
EN 61000-4-6:2007
EN 61000-4-8:1993+A1:2001
EN 61000-4-11:2004
EN 61000-3-2:2000
EN 61000-3-3:1995+A1:2001
CISPR11:2003+A1:2004, Group 1, Class B
FCC Part 15 Class B*

EMC and Safety compliance were evaluated by Intertek/ETL Semko

Reference test report file numbers: *100071222 BOX-002, -004a, -007*

I, the undersigned, hereby declare that the equipment specified above conforms to the above Directive(s) and Standard(s).

Place: *United States of America*
Date: *April 22, 2010*



HARVARD
APPARATUS

Beth Bauman
(Signature)

Beth Bauman
(Full Name)

VP Engineering / Operations
(Position)

Harvard Apparatus pumps are distributed
on a non-exclusive basis by:

INSTECH

Instech Laboratories, Inc.

Headquarters:
5209 Militia Hill Road
Plymouth Meeting, PA 19462
TL (800) 443-4227
TL (610) 941-0132
FX (610) 941-0134

European sales office:
P.O. Box 2
9950 AA Winsum
The Netherlands
TL +31 (0)594 769026

www.instechlabs.com/Pumps/syringe/