

BRACKET ATTACHMENT
 CONCRETE/FILLED BLOCK: POWERS WEDGE-BOLT, 3/8 X 1-3/4" LONG
 STEEL HEX BOLT, GR.5, 3/8-16 X 1-3/4" LONG

(W) DIMENSIONS SHOWN ARE FOR MOUNTING TO STEEL JAMBS, ADD 1-1/16" WHEN ATTACHING TO CONCRETE OR FILLED BLOCK JAMBS.

(W) FOR PUSH-UP OPERATION: 5-7/8" (W)(W)
 FOR HAND CHAIN OPERATION: 6-5/8" (W)(W)
 FOR ELECTRIC OPERATION: 7-3/8" (W)(W)
 FOR OUTSIDE OF CHAIN DRIVE: 8-1/8" (W)(W)
 NOTE: RIGHT SIDE DRIVE SHOWN

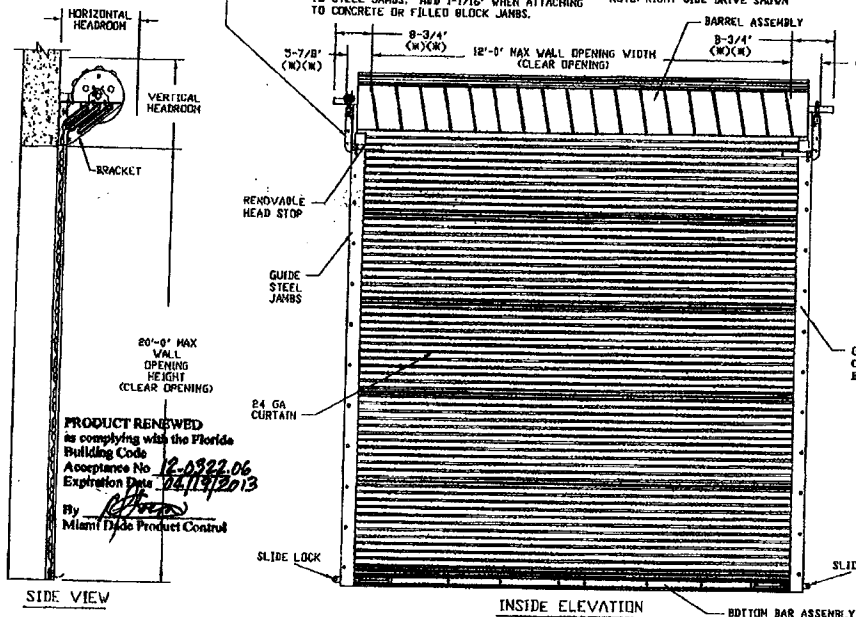

PRODUCT RENEWED
 as complying with the Florida Building Code
 Acceptance No. 12-0322-06
 Expiration Date: 04/19/2013
 By: *[Signature]*
 Miami Trade Product Control

HEADROOM REQUIRED

OPENING HEIGHT	VERTICAL HEADROOM	HORIZONTAL HEADROOM
THRU 8'-0"	17'	19'
OVER 8'-0" THRU 10'-0"	19'	21'
OVER 10'-0" THRU 14'-0"	20'	22'
OVER 14'-0" THRU 16'-0"	21'	23'
OVER 16'-0" THRU 18'-0"	22'	24'
OVER 18'-0" THRU 20'-0"	23'	25'

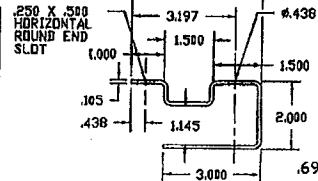

GUIDE
 G90 GALV STEEL
 ASTH A653 W/MIN
 FY=33 KSI
 CONTINUOUS
 FULL JAMB LENGTH

Florida Building Code
 DATE: 04/19/2013
 ND# 12-0322-06
 Miami Trade Product Control
 By: *[Signature]*

REV	DESCRIPTION	DATE	APPROVAL
---	DRAWING RELEASE	3-16-06	DM

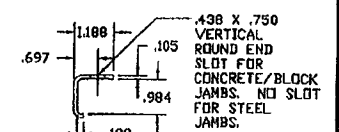

WIND BAR
 WIND BAR G90 GALV STEEL
 ASTH A653 W/MIN
 FY=33 KSI
 CONTINUOUS
 FULL GUIDE LENGTH

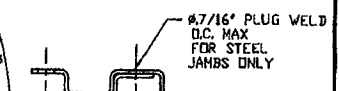

[Signature]
 7/29/06

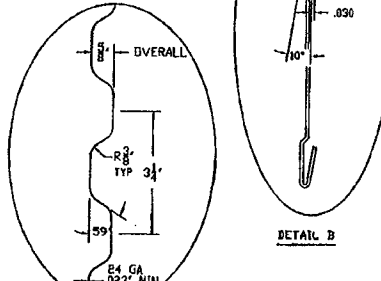
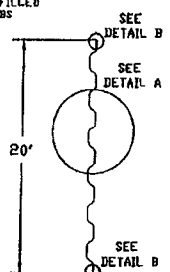

ASTH A653 GR 80 MIN FY=80 KSI,
 G90 GALVANIZED STEEL.
 CURTAIN PANELS LOCK SEAM TOGETHER.
 PRE-PAINTED WITH A FULL COAT OF PRIMER
 AND BAKED SILICONIZED POLYESTER FINISH COAT.
CURTAIN PANEL

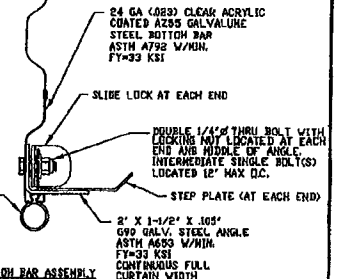

DOUBLE 1/4" THRU BOLT WITH LOCKING NUT LOCATED AT EACH END AND MIDDLE OF ANGLE. INTERMEDIATE SINGLE BOLTS LOCATED 12" MAX O.C.
 STEP PLATE (AT EACH END)
BOTTOM BAR ASSEMBLY

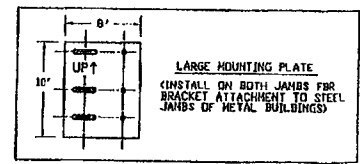
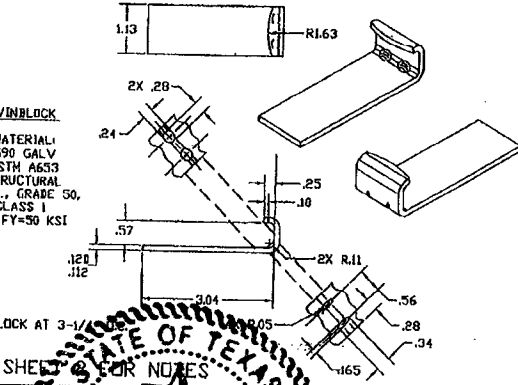

STRUCTURAL ENGINEER: JOSEPH H. DIXON, JR. P.E. FL #7768

UNLESS OTHERWISE SPECIFIED DIMENSIONS ARE IN INCHES AND TOLERANCES ARE:

DECIMAL	FRACTIONS	ANGLES	HOLE DIAMETERS
.XX ±.03	1/16 ± 0° 30'		UNDER .251 +.004
.XXX ±.003			UNDER .251 -.003
			.251 to .500 +.006
			.251 to .500 -.003
			OVER .500 +.008
			OVER .500 -.003

PART NUMBER: NA	DATE: 1-20-06
MATERIAL: NA	APPROVALS: BECKY NELSON
APPLIED FINISH: NA	CHECKED: DON MILLS
UNIT OF MEASURE: NA	APPROVED: DON MILLS

JANUS INTERNATIONAL CORPORATION
 134 EAST LUKE ROAD TEMPLE, GA 30179-4435
 770-582-2850/Fax 770-582-2284
 © 2008 Janus International Corporation All Rights Reserved

DADE COUNTY COMMERCIAL DOOR SERIES 3400
 MAX. SIZE 12'-0" X 20'-0"

SIZE: **B** DRAWING NUMBER: **T1011**

SCALE: NONE SHEET 1 OF 2

STATE OF TEXAS
 JOSEPH H. DIXON, JR.
 18627
 LICENSED PROFESSIONAL ENGINEER
[Signature]
 5/17/13

GENERAL NOTES

- THIS ROLL-UP DOOR SYSTEM HAS BEEN SUCCESSFULLY TESTED ACCORDING TO THE UNIFORM STATIC AIR PRESSURE TEST PER TAS 802-94, THE LARGE WESSLE IMPACT TEST PER TAS 201-94 AND THE CYCLIC WIND PRESSURE LOADING TEST PER TAS 203-94, IN AN INDEPENDENT TESTING LAB CONFORMING TO TAS 301-94.
- THE DOOR IS DESIGNED TO COMPLY WITH THE MIAMI-DADE COUNTY PRODUCT CONTROL DIVISION FOR THE HIGH VELOCITY HURRICANE ZONE (HVHZ) OF THE FLORIDA BUILDING CODE.
- DESIGN LOAD RATING = +43.0 PSF POSITIVE WIND LOAD
-49.0 PSF NEGATIVE WIND LOAD
- WIND LOADS FOR BUILDING OPENINGS SHALL BE DETERMINED BY A PROFESSIONAL ENGINEER USING APPROPRIATE WIND SPEED AND DESIGN CRITERIA. THIS DOOR MAY BE USED WHERE ITS DESIGN LOAD MEETS OR EXCEEDS THE DESIGN LOAD REQUIRED FOR THE BUILDING OPENING.
- THE BUILDING ENGINEER SHALL VERIFY THE ADEQUACY OF THE BUILDING STRUCTURE TO WITHSTAND SUPERIMPOSED LOADS P_{xpf}, P_{ypf} + R_{ypf}, P_{xnf} AND P_{ynt} + R_{ynt}.
- EACH MIAMI-DADE COUNTY DOOR ASSEMBLY SHALL BE LABELED AS FOLLOWS:
 JANUS INTERNATIONAL CORPORATION
 TEMPLE, GA
 MIAMI-DADE COUNTY PRODUCT CONTROL APPROVED
- ALL WELDING SHALL BE PERFORMED BY QUALIFIED WELDERS IN ACCORDANCE WITH THE LATEST EDITION OF AWS SPECIFICATIONS. ALL WELDING ELECTRODES SHALL CONFORM TO AWS A51, GRADE E-70.
- ALL BOLTS AND WASHERS SHALL BE GALVANIZED STEEL OR STAINLESS STEEL WITH A MINIMUM TENSILE STRENGTH OF 60 KSI.
- DOORS SHALL BE PROVIDED WITH DOUBLE BOTTOM BAR MOUNTED SLIDE LOCK LATCHES THAT ENGAGE THE DOOR GUIDES WHEN DOOR IS FULLY CLOSED.
- DOOR ASSEMBLY DESIGN BASED ON CERTIFIED TESTING LABORATORIES, INC., TEST REPORT NO. C7LA-1493W.
- ANCHOR NOTES:
 A. EMBEDMENT LENGTH DOES NOT INCLUDE STUCCO FINISH.
 B. FOR HOLLOW MASONRY BLOCK, FILL ALL CELLS AT ANCHOR LOCATIONS WITH MINIMUM 2000 PSI GROUT.
 C. CONCRETE JAMBS TO BE MINIMUM 2000 PSI.
 D. ANCHORS SHALL BE INSTALLED IN ACCORDANCE WITH MANUFACTURER'S SPECIFICATIONS.
- GUIDE TO JAMB ATTACHMENT FASTENERS BEGIN 4" FROM FLOOR AND END 2" BELOW TOP OF WALL OPENING.
- TEST DOOR WALL OPENING SIZE: 12'-0" X 8'-0".

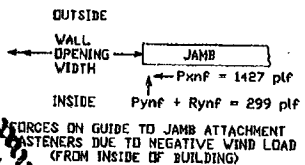
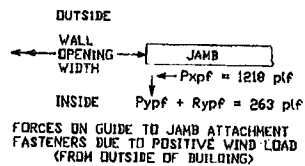

STEEL JAMBS

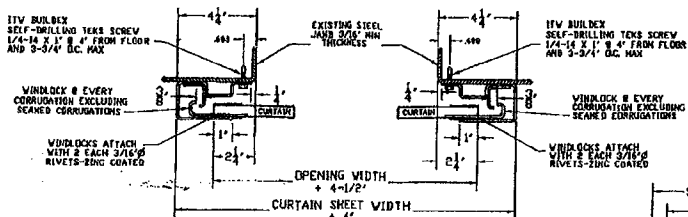

FILLED BLOCK JAMBS

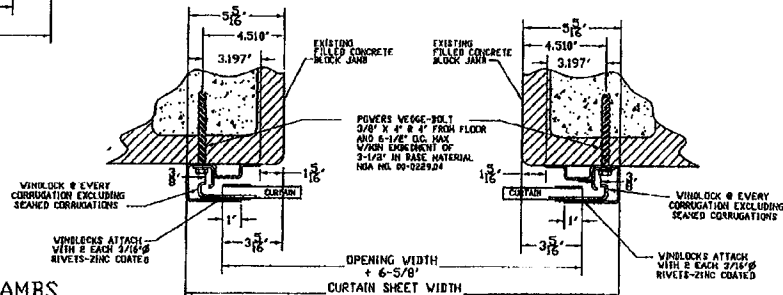

CONCRETE JAMBS

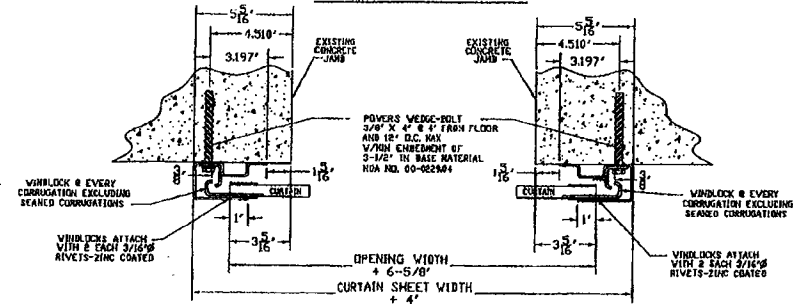

PRODUCT RENEWED
 as complying with the Florida Building Code
 Acceptance No 12-0322-06
 Expiration Date 02/19/2013
 By *[Signature]*
 Miami Dade Product Control

Approved as complying with the Florida Building Code
 Date 02/19/2013
 By *[Signature]*
 Miami Dade Product Control

[Handwritten Signature]
 7/29/06

STRUCTURAL ENGINEER: JOSEPH H. DIXON, JR. P.E. FL #7768

UNLESS OTHERWISE SPECIFIED DIMENSIONS ARE IN INCHES AND TOLERANCES ARE:

DECIMAL	FRACTIONS	ANGLES	HOLE DIAMETERS
.XX ±.03	± 1/16	± 0° 30'	UNDER .251 +.004 -.003
.XXX ±.005			.251 to .500 +.005 -.003
			OVER .500 +.009 -.003

PART NUMBER NA		JANUS INTERNATIONAL CORPORATION	
MATERIAL NA		134 EAST LUKE ROAD TEMPLE, GA 30170-4435	
APPLIED FINISH NA		770-582-2850/Fax 770-582-2284	
UNIT OF MEASURE NA		© 2008 Janus International Corporation All Rights Reserved	
APPROVALS		DADE COUNTY COMMERCIAL DOOR SERIES 3400	
DATE		MAX. SIZE 12'-0" X 20'-0"	
DRAWN BECKY NELSON	1-20-06	SIZE B	DRAWING NUMBER T1011
CHECKED DIXON MILLS	3-16-06	SCALE NONE	SHEET 2 OF 2
APPROVED DIXON MILLS	3-16-06		

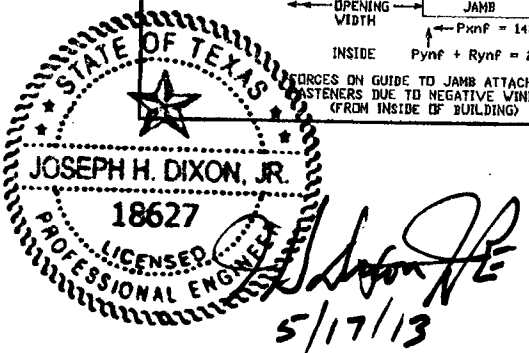

TEXAS DEPARTMENT OF INSURANCE

Engineering Services Program / MC 103-3A 333 Guadalupe Street P.O. Box 149104 Austin, Texas 78714-9104
Phone No. (512) 322-2212 Fax No. (512) 463-6693

PRODUCT EVALUATION GDR-45

Effective Date: June 1, 2013

*The following product has been evaluated for compliance with the wind loads specified in the **International Residential Code (IRC)** and the **International Building Code (IBC)**. This product shall be subject to reevaluation **February 2016**.*

This product evaluation is not an endorsement of this product or a recommendation that this product be used. The Texas Department of Insurance has not authorized the use of any information contained in the product evaluation for advertising, or other commercial or promotional purpose.

This product evaluation is intended for use by those individuals who are following the design wind load criteria in Chapter 3 of the IRC and Section 1609 of the IBC. The design loads shall not exceed the allowable wind loads shown in this product evaluation. This product evaluation does not relieve a Texas licensed engineer of his responsibilities as outlined in the Texas Insurance Code, the Texas Administrative Code and the Texas Engineering Practice Act.

Series 3400 Steel Roll Up Doors, Impact Resistant, as manufactured by:

Janus International Corporation
134 Janus International Blvd.
Temple, Georgia 30179-4435
(770) 562-2850
www.janusintl.com

will be accepted for use in designated catastrophe areas along the Texas Gulf Coast when installed in accordance with this product evaluation and drawings that are referenced in this evaluation report.

PRODUCT DESCRIPTION

This evaluation report is for the Series 3400 steel roll up doors. The steel roll-up doors consist of a corrugated steel curtain that is suspended from a barrel. Coil springs, located within the barrel, raise and lower the curtain, which wraps around the barrel. The steel curtain is raised by push-up, hand chain, or electric operation. The sides of the curtain are constrained from lateral movement along their vertical edges by steel guides that are attached to the structure. The steel roll up doors specified in this evaluation report are impact resistant. This evaluation report includes the following doors:

System	Description	Maximum Width	Maximum Height
1	24 Gauge Series 3400 Roll Up Doors; Single Curtain; Windlocks	12'-0"	20'-0"

The steel roll up doors specified in this evaluation report consist of the following components:

Curtain: 24 gauge corrugated steel that is roll-formed from ASTM A 653 grade 80 steel. The corrugated sheets are galvanized and pre-painted with silicone polyester paint. The corrugated sheets are interlocked mechanically to form the curtain.

Guides: 12 gauge galvanized steel roll-formed from ASTM A 653 steel. The dimensions of the guide are 2" x 4" x 0.105" x full length.

Wind Bar: 12 gauge galvanized steel roll-formed from ASTM A 653 steel. The dimensions of the wind bar are 1.188" x 0.984" x 0.188" x 0.105" x full length of guide. The wind bar is secured to the guide with anchors for cast-in-place or pre-cast concrete substrate and welded in place for steel substrate.

Bottom Bar: One (1) 24 gauge galvanized steel bottom bar full length of curtain. One (1) roll-formed steel angle, 2" x 1 1/2" x 0.105" x full length. The steel angle is attached to the steel bottom bar with 1/4" diameter thru bolts and lock nuts. Two (2) bolts are located at each end and two (2) bolts are located at the center. One (1) bolt is located 12 inches on center. A continuous vinyl bulb astragal is attached to the bottom of the steel angle.

Windlocks: 11 gauge galvanized steel. The dimensions of the windlock are 1.13" x 3.04" x 0.112". The windlock is attached to each side of the curtain at every corrugation except at the seamed corrugations. Each windlock is attached to the curtain with two (2) 3/16" diameter zinc coated rivets.

Hardware: One (1) commercial slide lock located at the end of each bottom bar. Each is attached with two (2) 1/4" diameter bolts and lock nuts.

Product Identification: A label will be affixed to the bottom bar of the steel roll up door. The label shall include the manufacturer's name, model number of door, the allowable design pressure rating, the design drawing number, and compliance with either ASTM E 330 or ANSI/DASMA 108.

LIMITATIONS

System	Maximum Width	Maximum Height	Drawing	Design Pressure Rating (psf)
1	12'-0"	20'-0"	T1011	+43, -49

Glazing: None.

Impact Resistance: The doors listed in this report satisfy the Texas Department of Insurance's criteria for protection from windborne debris in the **Inland I zone** and the **Seaward zone**. The door assemblies passed the equivalent of Missile Level D as specified in ASTM E 1996-04. The door assemblies will not need to be protected with an impact protective system when installed in areas where windborne debris protection is required.

Acceptance of Smaller Assemblies: Door assemblies with dimensions equal to or smaller than those specified above are acceptable within the limitations specified in this report.

Drawings (The drawing listed below shall be available at the job site):

System 1: Janus International Corporation; Dade County Commercial Door Series 3400 Max Size 12'-0" x 20'-0"; Drawing No. T1011, Sheet 1 and 2 of 2; signed, sealed, and dated 05-17-2013, by Joseph H. Dixon, P.E.

INSTALLATION INSTRUCTIONS

The steel roll up doors shall be installed to the substrate using one of the following methods (refer to the design drawings referenced above for further guidance):

Bolted to cast-in-place, pre-cast concrete, or grout-filled CMU substrate:

System 1: Guide Mounting: Each guide and wind bar shall be anchored to the substrate with minimum $\frac{3}{8}$ " x 4" Powers Wedge-Bolt anchors. The anchors shall be placed through the wind bar, through the interior of the guide, and into the substrate. The anchors shall be spaced a maximum of 4 inches from the floor and 12 inches on center for cast-in-place or pre-cast concrete substrate and 6 $\frac{1}{2}$ " on center for grout filled CMU substrate, along the length of the guide. The anchors shall penetrate a minimum of 3 $\frac{1}{2}$ " into the substrate. If the bolt must penetrate through a wall covering, then the bolt length shall be increased by the thickness of the wall covering material. The anchors shall be located a minimum of 4 $\frac{1}{2}$ inches from the edge of the door opening. Grout shall be minimum 2,500 psi.

Bolted to steel substrate:

System 1: Guide Mounting: The steel substrate shall be minimum $\frac{1}{8}$ " thick A36 steel. Each guide shall be anchored to the substrate with minimum $\frac{1}{4}$ -14 x 1" ITW Buildex self-drilling TEKS screws. The screws shall be placed through the wind bar, through the toe of the guide, and into the substrate. The screws shall be spaced a maximum of 4 inches from the floor and 3 $\frac{3}{4}$ inches on center along the length of the guide through the pre-drilled holes in the guide. If the screws must penetrate through a wall covering, then the bolt length shall be increased by the thickness of the wall covering material.

Note: The manufacturer's installation instructions and the design drawings referenced in this evaluation report shall be available on the job site during installation. All fasteners shall be corrosion resistant as specified in the International Residential Code (IRC), the International Building Code (IBC), and the Texas Revisions.