

5M H.265

High quality video
becomes lighter



40%
STORAGE
EFFICIENCY

SNO-8081R/SNV-8081R

5M H.265 Network IR Camera

5M H.265 IR Camera Series

5M High resolution with 40% lower bandwidth costs

Samsung's high resolution 5M camera supports the latest video compression format H.265 to satisfy increasing demand for large scaled areas. Large scaled applications such as city, harbor or airports demand high quality details while struggling with the shortage of bandwidth and storage. Now benefit crystal clear images with 40% lower bandwidth and storage size by SNO-8081R & SNV-8081R.

- 5M 30fps
- True WDR 120dB
- H.265, H.264, MJPEG support
- WDR(120dB), Simple focus, P-Iris
- IR Viewable length 30m
- Hallway view (Rotate 90° / 270°)
- LDC (Lens Distortion Control)
- IP66, IK10, Bi-directional audio support



Lower 40% Bandwidth & Storage costs with H.265

The new H.265 codec format adapted in SNO-8081R & SNV-8081R has 40% bit rate reduction while offering the same image quality compared to H.264 by using a more efficient compression technology. This means that the camera could also offer a significantly better image quality than H.264 with the same bandwidth or storage needs.

Now monitor high quality images without sacrificing video quality.

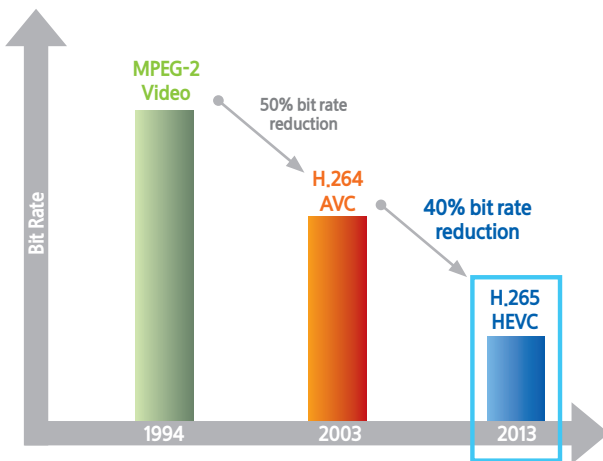

0Lux, IR Viewable Length 30m

SNO & SNV-8081R offers built-in IR LED allowing users to discover objects clearly in no light conditions and provides views from up to 30 meters away. Your safety will be ensured with the high video quality even in total darkness.



※ Scan the QR code to watch the product demo video.

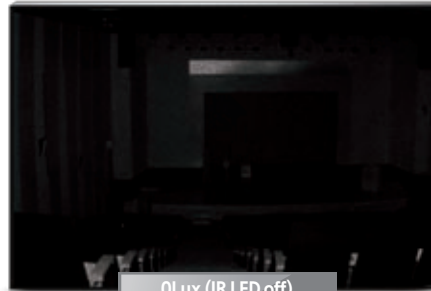

0Lux (IR LED off)

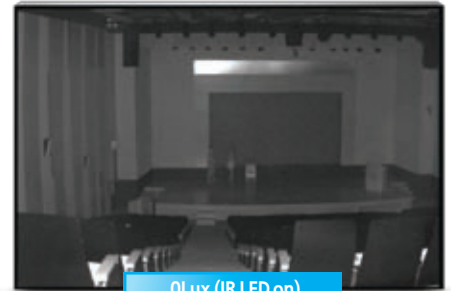

0Lux (IR LED on)

30fps@5Megapixel Resolution

Samsung's 5M H.265 IR cameras have the ability to shoot 30 frames per second at 5MP high resolution with its powerful encoding technology. It has faster frame rate than the conventional 5M cameras allowing users to get sharp and clear videos with fast moving objects.



※ Scan the QR code to watch the product demo video.

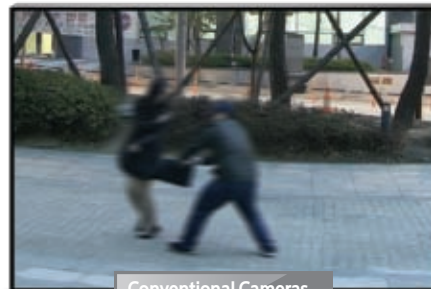

Conventional Cameras

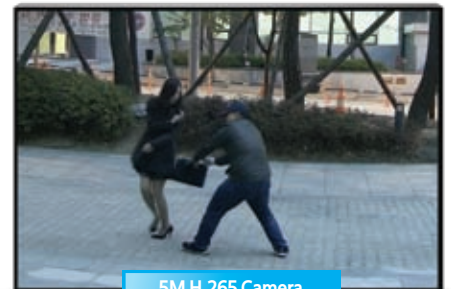

5M H.265 Camera

P-Iris Lens Support

The P-iris system prevents the blurred image that may occur when multiple light conditions exist by optimizing the iris function. As a result, you can shoot high quality images with better contrast, clarity, resolution and depth of field.



※ Scan the QR code to watch the product demo video.

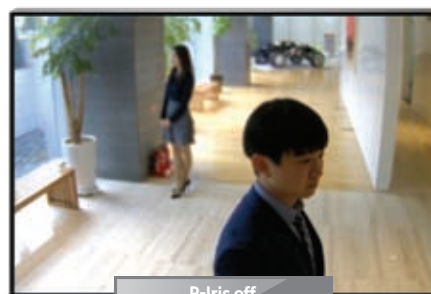

P-Iris off

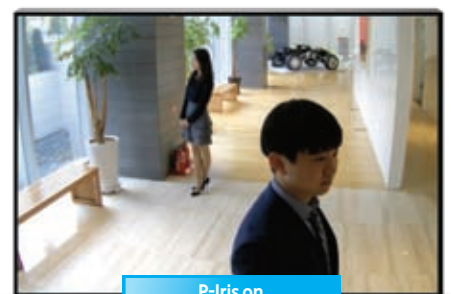

P-Iris on

Hallway view for monitoring vertical shaped areas

In a vertical shaped environment, such as corridors, hallways, tunnels, or aisles, traditional horizontal shaped videos focus on unnecessary edges of the area causing bandwidth and storage waste. By utilizing the hallway view, 3 : 4 and 9 : 16 aspect ratio image is created : a vertically oriented video that maximizes image quality in narrow locations.



Conventional

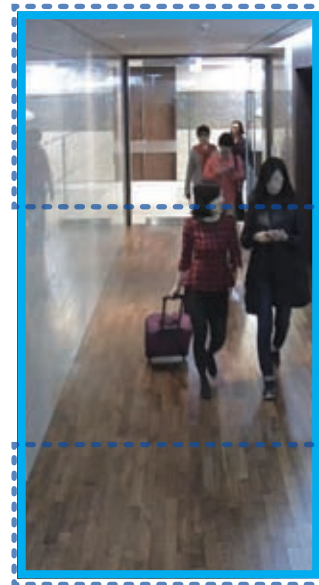

Hallway View

Minimize image distortion by Lens Distortion Correction

Lens Distortion may typically appear in videos causing straight lines close to the edge curve outwards. With the Lens Distortion Correction technology available on the WiseNet Lite series, imperfections in images can be easily repaired.

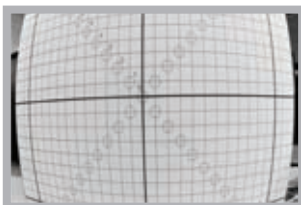

Conventional

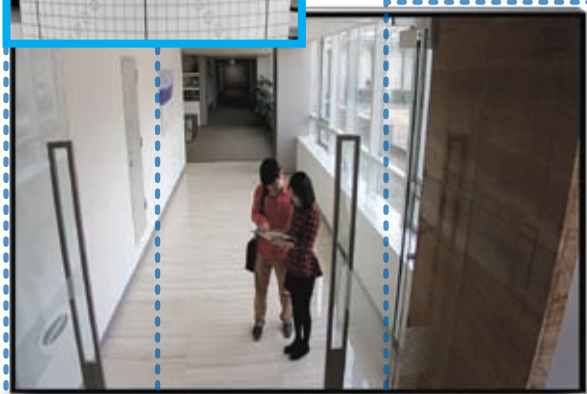
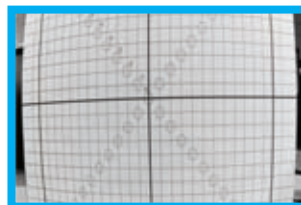

Lens Distortion Correction

SNO-8081R

5Megapixel Network IR Bullet Camera



Key Features

- Max 5M (2592 x 1944) resolution
- 30fps@5M, 60fps@2M
- 0.15Lux@F1.3 (Color), 0Lux (B/W : IR LED on)
- 3.93 ~ 9.4mm (2.4x) motorized varifocal lens
- H.265, H.264, MJPEG support
- Day & Night (ICR), WDR (120dB), Simple focus, P-Iris
- Tampering, Audio detection
- SD/SDHC/SDXC memory slot, NAS, Local PC support
- Hallway view (Rotate 90° / 270°)
- LDC (Lens Distortion Correction)
- IP66, IK10, Bi-directional audio support

Dimensions

Unit : mm (inch)

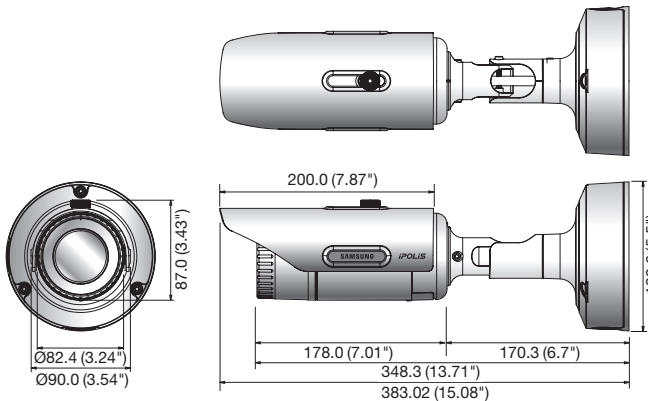

Accessories (Optional)



SNO-8081RN/P

VIDEO	
Imaging Device	1/1.8" 6M CMOS
Total Pixels	3,096(H) x 2,094(V)
Effective Pixels	2,616(H) x 1,976(V)
Scanning System	Progressive
Min. Illumination	Color : 0.3Lux (1/30sec, F1.3, 50IRE), 0.005Lux (2sec, F1.3, 50IRE) 0.15Lux (1/30sec, F1.3, 30IRE), 0.003Lux (2sec, F1.3, 30IRE) B/W : 0Lux (IR LED on)
S / N Ratio	50dB
Video Output	CVBS : 1.0 Vpp / 75Ω composite, 704 x 480(N), 704 x 576(P), for installation DIP connector type
LENS	
Focal Length (Zoom Ratio)	3.93 ~ 9.4mm (2.4x) motorized varifocal
Max. Aperture Ratio	F1.3
Angular Field of View	H : 93.4°(Wide) ~ 39.2°(Tele) / V : 68.1°(Wide) ~ 29.3°(Tele)
Min. Object Distance	0.5m (1.64ft)
Focus Control	Simple focus (Motorized V/F) / Manual, Remote control via network (Manual, Simple focus)
Lens Type / Mount Type	DC auto iris, support P-Iris mode / Board-in type
OPERATIONAL	
Viewable Length	30m (98.43ft), Smart IR
Camera Title	Off / On (Displayed up to 15 characters)
Day & Night	Auto (ICR) / Color / B/W / External / Schedule
Backlight Compensation	Off / BLC / WDR
Wide Dynamic Range	120dB
Contrast Enhancement	SSDR (Samsung Super Dynamic Range) (Off / On)
Digital Noise Reduction	SSNR (2D+3D noise filter) (Off / On)
Motion Detection	Off / On (4ea, Rectangle)
Privacy Masking	Off / On (6ea, Rectangle) - Color : Black / Blue / Red / Grey / White / Green
Gain Control	Off / Low / Medium / High
White Balance	ATW / AWC / Manual / Indoor / Outdoor (Include mercury & Sodium)
LDC (Lens Distortion Correction)	Off / On (Level auto control)
Electronic Shutter Speed	Minimum / Maximum / Anti flicker (2 ~ 1/12,000sec)
Flip / Mirror	Off / On, Halfway : 90° / 270°
Intelligent Video Analytics	Tampering, Audio detection - with metadata
Alarm I/O	Input 1ea / Output 1ea
Alarm Triggers	Alarm input, Motion detection, Tampering, Audio detection, Network disconnect
Alarm Events	File upload via FTP and E-mail, Notification via E-mail Local storage (SD/SDHC/SDXC) or NAS recording at event triggers, External output Support
Pixel Counter	Support
NETWORK	
Ethernet	RJ-45 (10/100BASE-T)
Video Compression Format	H.265 : Main, H.264 (MPEG-4 part 10/AVC) : Main / Baseline / High, MJPEG
Resolution	5M mode : 2592 x 1944, 2592 x 1464, 1920 x 1080, 1600 x 1200, 1280 x 1024, 1280 x 960, 1280 x 720, 1024 x 768, 800 x 600, 720 x 480, 640 x 480, 320 x 240 2M mode : 1920 x 1080, 1280 x 1024, 1280 x 960, 1280 x 720, 1024 x 768, 800 x 600, 720 x 576, 720 x 480, 640 x 480, 320 x 240
Max. Framerate	5M mode - H.265 / H.264 : 30fps in all resolutions MJPEG : 2592 x 1944 ~ 2592 x 1464 : 2fps, 1920 x 1080 ~ 1600 x 1200 : 4fps 1280 x 1024 ~ 1024 x 768 : 5fps, 800 x 600 ~ 320 x 240 : 15fps 2M mode - H.265 / H.264 : 60fps in all resolutions MJPEG : 1920 x 1080 : 4fps, 1280 x 1024 ~ 1024 x 768 : 5fps, 800 x 600 ~ 320 x 240 : 15fps
Smart Codec	Manual mode (Area-based : 4ea)
Video Quality Adjustment	H.265 / H.264 : Compression level, Target bitrate level control, MJPEG : Quality level control
Bitrate Control Method	H.265 / H.264 : CBR or VBR, MJPEG : VBR
Streaming Capability	Multiple streaming (Up to 3 profiles) - Total 3 stream at the same time (Including recording stream)
Audio In	Selectable (Mic in / Line in) Supply voltage : 2.5V DC (4mA), Input impedance : approx. 2K Ohm
Audio Out	Line out (3.5mm stereo mini jack), Max output level : 1Vrms
Audio Compression Format	G.711 u-law/G.726 selectable, G.726 (ADPCM) 8KHz, G.711 8KHz G.726 : 16Kbps, 24Kbps, 32Kbps, 40Kbps
Audio Communication	Bi-directional audio (2-way)
IP	IPv4, IPv6
Protocol	TCP/IP, UDP/IP, RTP(UDP), RTP(TCP), RTCP, RTSP, NTP, HTTP, HTTPS, SSL, DHCP, PPPoE, FTP, SMTP, ICMP, IGMP, SNMPv1/v2c/v3(MIB-2), ARP, DNS, DDNS, QoS, PIM-SM, UPnP, Bonjour
Security	HTTPS(SSL) login authentication, Digest login authentication IP address filtering, User access log, 802.1x authentication (EAP-TLS, EAP-LEAP)
Streaming Method	Unicast / Multicast
Max. User Access	10 users at unicast mode
Edge Storage	SD/SDHC/SDXC (128GB) - Motion images recorded in the SD/SDHC/SDXC memory card can be downloaded, Camera can detect automatically when the memory is connected, Memory status display (Normal / Error / Active / Formatting / Lock), NAS (Network Attached Storage), Local PC for instant recording
Application Programming Interface	ONVIF profile S, SUNAPI (HTTP API), SVNP, Samsung Techwin Open Platform
Webpage Language	English, French, German, Spanish, Italian, Chinese, Russian, Japanese, Swedish, Danish, Portuguese, Turkish, Polish, Czech, Rumanian, Serbian, Dutch, Croatian, Hungarian, Greek
Web Viewer	Supported OS : Windows XP / VISTA / 7 / 8 / 8.1 or higher, MAC OS X 10.7 ~ 10.10 Supported Browser : Microsoft Internet Explorer (Ver. 8 ~ 11), Mozilla Firefox (Ver. 9 ~ 35), Google Chrome (Ver. 15 ~ 40), Apple Safari (Ver. 8.0.2 (Mac OS X 10.10), 7.0.6 (Mac OS X 10.9), 6.0.2 (Mac OS X 10.8, 10.7 only), 5.1.7* Mac OS X only
Central Management Software	SmartViewer, SSM
ENVIRONMENTAL	
Operating Temperature / Humidity	-40°C ~ +55°C (-40°F ~ +131°F) / Less than 90% RH * Start up should be done at above -35°C (-31°F)
Storage Temperature / Humidity	-30°C ~ +60°C (-22°F ~ +140°F) / Less than 90% RH
Ingress Protection / Vandal Resistance	IP66 / IK10
ELECTRICAL	
Input Voltage / Current	24V AC ±10%, 12V DC ±10%, PoE (IEEE802.3af, Class3)
Power Consumption	Max. 12W/13.5W (24V AC, Heater off / on), Max. 10W/11.5W (12V DC, Heater off / on), Max. 11.5W/12.95W (PoE, Heater off / on)
MECHANICAL	
Color / Material	Dark gray / Aluminium
Dimensions (WxHxD)	82.4 x 87.0 x 348.3mm (3.24" x 3.43" x 13.71") (With bracket)
Weight	1.42Kg (3.13 lb)

* The latest product information / specification can be found at www.samsungsecurity.com

SNV-8081R

5Megapixel Vandal-Resistant Network IR Dome Camera



Key Features

- Max 5M (2592 x 1944) resolution
- 30fps@5M, 60fps@2M
- 0.15Lux@F1.3 (Color), 0Lux (B/W : IR LED on)
- 3.93 ~ 9.4mm (2.4x) motorized varifocal lens
- H.265, H.264, MJPEG support
- Day & Night (ICR), WDR (120dB), Simple focus, P-Iris
- Tampering, Audio detection
- SD/SDHC/SDXC memory slot, NAS, Local PC support
- Hallway view (Rotate 90° / 270°)
- LDC (Lens Distortion Correction)
- IP66, IK10, Bi-directional audio support

Dimensions

Unit : mm (inch)

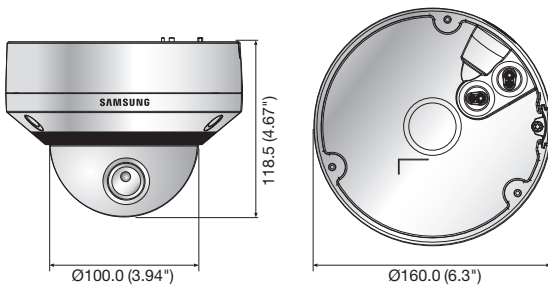

Accessories (Optional)



SNV-8081RN/P	
VIDEO	
Imaging Device	1/1.8" 6M CMOS
Total / Effective Pixels	3,096(H) x 2,094(V) / 2,616(H) x 1,976(V)
Scanning System	Progressive
Min. Illumination	Color : 0.3Lux (1/30sec, F1.3, 50IRE), 0.005Lux (2sec, F1.3, 50IRE) 0.15Lux (1/30sec, F1.3, 30IRE), 0.003Lux (2sec, F1.3, 30IRE)
S / N Ratio	50dB
Video Output	CVBS : 1.0Vpp / 75Ω composite, 704 x 480(N), 704 x 576(P), for installation DIP connector type
LENS	
Focal Length (Zoom Ratio)	3.93 ~ 9.4mm (2.4x) motorized varifocal
Max. Aperture Ratio	F1.3
Angular Field of View	H : 93.4°(Wide) ~ 39.2°(Tele) / V : 68.1°(Wide) ~ 29.3°(Tele)
Min. Object Distance	0.5m (1.64ft)
Focus Control	Simple focus (Motorized V/F) / Manual, Remote control via network (Manual, Simple focus)
Lens Type / Mount Type	DC auto iris, support P-Iris mode / Board-in type
PAN / TILT / ROTATE	
Pan / Tilt / Rotate Range	0° ~ 354° / 0° ~ 67° / 0° ~ 355°
OPERATIONAL	
Viewable Length	30m (98.43ft), Smart IR
Camera Title	Off / On (Displayed up to 15 characters)
Day & Night	Auto (ICR) / Color / B/W / External / Schedule
Backlight Compensation	Off / BLC / WDR
Wide Dynamic Range	120dB
Contrast Enhancement	SSDR (Samsung Super Dynamic Range) (Off / On)
Digital Noise Reduction	SSNR (2D+3D noise filter) (Off / On)
Motion Detection	Off / On (4ea, Rectangle)
Privacy Masking	Off / On (6ea, Rectangle) - Color : Black / Blue / Red / Grey / White / Green
Gain Control	Off / Low / Medium / High
White Balance	ATW / AWC / Manual / Indoor / Outdoor (Include mercury & Sodium)
LDC (Lens Distortion Correction)	Off / On (Level auto control)
Electronic Shutter Speed	Minimum / Maximum / Anti flicker (2 ~ 1/12,000sec)
Flip / Mirror	Off / On, Hallway : 90° / 270°
Intelligent Video Analytics	Tampering, Audio detection - with metadata
Alarm I/O	Input 1ea / Output 1ea
Alarm Triggers	Alarm input, Motion detection, Tampering, Audio detection, Network disconnect
Alarm Events	File upload via FTP and E-mail, Notification via E-mail
Pixel Counter	Local storage (SD/SDHC/SDXC) or NAS recording at event triggers, External output
Support	Support
NETWORK	
Ethernet	RJ-45 (10/100BASE-T)
Video Compression Format	H.265 : Main, H.264 (MPEG-4 part 10/AVC) : Main / Baseline / High, MJPEG
Resolution	5M mode : 2592 x 1944, 2592 x 1464, 1920 x 1080, 1600 x 1200, 1280 x 1024, 1280 x 960, 1280 x 720, 1024 x 768, 800 x 600, 720 x 576, 720 x 480, 640 x 480, 320 x 240 2M mode : 1920 x 1080, 1280 x 1024, 1280 x 960, 1280 x 720, 1024 x 768, 800 x 600, 720 x 576, 720 x 480, 640 x 480, 320 x 240
Max. Framerate	5M mode - H.265 / H.264 : 30fps in all resolutions MJPEG : 2592 x 1944 ~ 2592 x 1464 : 2fps, 1920 x 1080 ~ 1600 x 1200 : 4fps 1280 x 1024 ~ 1024 x 768 : 5fps, 800 x 600 ~ 320 x 240 : 15fps 2M mode - H.265 / H.264 : 60fps in all resolutions MJPEG : 1920 x 1080 : 4fps, 1280 x 1024 ~ 1024 x 768 : 5fps, 800 x 600 ~ 320 x 240 : 15fps
Smart Codec	Manual mode (Area-based : 4ea)
Video Quality Adjustment	H.265 / H.264 : Compression level, Target bitrate level control, MJPEG : Quality level control
Bitrate Control Method	H.265 / H.264 : CBR or VBR, MJPEG : VBR
Streaming Capability	Multiple streaming (Up to 3 profiles) - Total 3 stream at the same time (Including recording stream)
Audio In	Selectable (Mic in / Line in) Supply voltage : 2.5V DC (4mA), Input impedance : approx. 2K Ohm
Audio Out	Line out (3.5mm stereo mini jack), Max output level : 1Vrms
Audio Compression Format	G.711 u-law/G.726 selectable, G.726 (ADPCM) 8KHz, G.711 8KHz G.726 : 16Kbps, 24Kbps, 32Kbps, 40Kbps
Audio Communication	Bi-directional audio (2-way)
IP	IPv4, IPv6
Protocol	TCP/IP, UDP/IP, RTP(UDP), RTP(TCP), RTCP, RTSP, NTP, HTTP, HTTPS, SSL, DHCP, PPPoE, FTP, SMTP, ICMP, IGMP, SNMPv1/v2c/v3(MIB-2), ARP, DNS, DDNS, QoS, PIM-SM, UPnP, Bonjour
Security	HTTPS(SSL) login authentication, Digest login authentication IP address filtering, User access log, 802.1x authentication (EAP-TLS, EAP-LEAP)
Streaming Method	Unicast / Multicast
Max. User Access	10 users at unicast mode
Edge Storage	SD/SDHC/SDXC (128GB) - Motion images recorded in the SD/SDHC/SDXC memory card can be downloaded, Camera can detect automatically when the memory is connected, Memory status display (Normal / Error / Active / Formatting / Lock), NAS (Network Attached Storage), Local PC for instant recording
Application Programming Interface	ONVIF profile S, SUNAPI (HTTP API), SYNIP, Samsung Techwin Open Platform
Webpage Language	English, French, German, Spanish, Italian, Chinese, Russian, Japanese, Swedish, Danish, Portuguese, Turkish, Polish, Czech, Rumanian, Serbian, Dutch, Croatian, Hungarian, Greek
Web Viewer	Supported OS : Windows XP / VISTA / 7 / 8 / 8.1 or higher, MAC OS X 10.7 ~ 10.10 Supported Browser : Microsoft Internet Explorer (Ver. 8 ~ 11), Mozilla Firefox (Ver. 9 ~ 35), Google Chrome (Ver. 15 ~ 40), Apple Safari (Ver. 8.0.2 (Mac OS X 10.10), 7.0.6 (Mac OS X 10.9), 6.0.2 (Mac OS X 10.8, 10.7 only), 5.1.7) * Mac OS X only
SmartViewer, SSM	SmartViewer, SSM
ENVIRONMENTAL	
Operating Temperature / Humidity	-40°C ~ +55°C (-40°F ~ +131°F) / Less than 90% RH * Start up should be done at above -35°C (-31°F)
Storage Temperature / Humidity	-30°C ~ +60°C (-22°F ~ +140°F) / Less than 90% RH
Ingress Protection / Vandal Resistance	IP66 / IK10
ELECTRICAL	
Input Voltage / Current	24V AC ±10%, 12V DC ±10%, PoE (IEEE802.3af, Class3)
Power Consumption	Max. 12W/13.5W (24V AC, Heater off / on), Max. 10W/11.5W (12V DC, Heater off / on), Max. 11.5W/12.95W (PoE, Heater off / on)
MECHANICAL	
Color / Material	Ivory / Aluminum
Dimensions (WxHxD)	160.0 x 118.5mm (6.3" x 4.67")
Weight	955g (2.11 lb)

* The latest product information / specification can be found at www.samsungsecurity.com

SNO-8081R/SNV-8081R

5M H.265 Network IR Camera

HEAD OFFICE

86 Cheonggyecheon-ro Jung-gu Seoul 04541 Korea
Tel : +82-2-729-5277, 5254 Fax : +82-2-729-5489
www.samsungsecurity.com

SAMSUNG TECHWIN EUROPE LTD.

2nd Floor, No. 5 The Heights, Brooklands, Weybridge, Surrey,
KT13 0NY, UK
Tel : +44-1932-82-6700 Fax : +44-1932-82-6701
www.samsungsecurity.co.uk

SAMSUNG TECHWIN AMERICA Inc.

100 Challenger Rd, Suite 700 Ridgefield Park, NJ 07660
Toll Free : +1-877-213-1222 Direct : +1-201-325-6920
Fax : +1-201-373-0124
www.samsung-security.com

SAMSUNG TECHWIN AMERICA Inc.

Latin America Branch Office

5200 Blue Lagoon Dr, Ste 210, Miami, FL, 33126
Tel : +1-305-728-0975 Fax : +1-305-351-8900
www.samsung-security.com

SHANGHAI SAMSUNG TECHWIN CO., LTD.

32F, Blk B, New Caohejing International Business Center,
No. 391 Guiping Rd., Shanghai, China, 200233
Tel : +86-21-5427-1155 Fax : +86-21-5423-5122
www.samsungsecurity.cn

© 2015 HANWHA TECHWIN CO., LTD. ALL RIGHTS RESERVED.

DESIGN AND SPECIFICATIONS ARE SUBJECT TO CHANGE WITHOUT NOTICE
Under no circumstances, this document shall be reproduced, distributed or changed,
partially or wholly, without formal authorization of Hanwha Techwin Co., Ltd.,
WiseNet, LiteNet, SSNR are trademarks of Hanwha Techwin Co., Ltd.

