

# Adsorption of ammonia on metal and polymer surfaces

*Olavi Vaittinen<sup>1</sup>,*

*Markus Metsälä<sup>1</sup>, Stefan Persijn<sup>2</sup>, Markku Vainio<sup>1,3</sup> and Lauri Halonen<sup>1</sup>*

<sup>1</sup> University of Helsinki, Finland

<sup>2</sup> VSL, The Netherlands

<sup>3</sup> MIKES, Finland

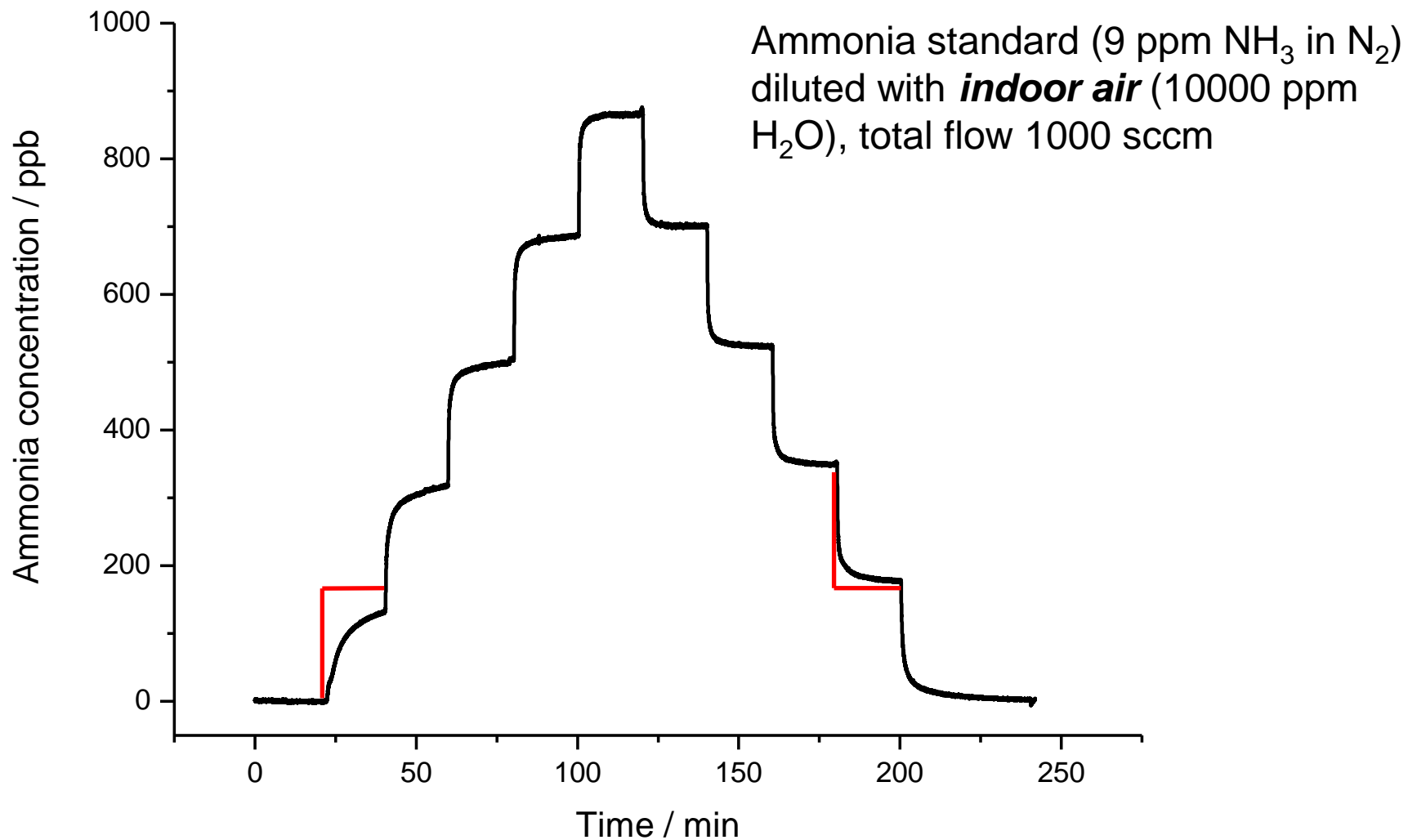

# Variables

**Test tube coating:** stainless steel 316L, electro-polished SS 316L,  
SilcoNert 1000, SilcoNert 2000, Dursan, PFA, FEP, PTFE, PELD, PVDF

**NH<sub>3</sub> concentration:** 10 ppb – 9 ppm (400 or 9000 ppb)

**Flow rate:** 0 – 2000 sccm (200 or 1000 sccm)

**Temperature:** 295 – 333 K (295 K)

**Water content:** 0 – 1 % (25 ppm)



# Gas generation setup

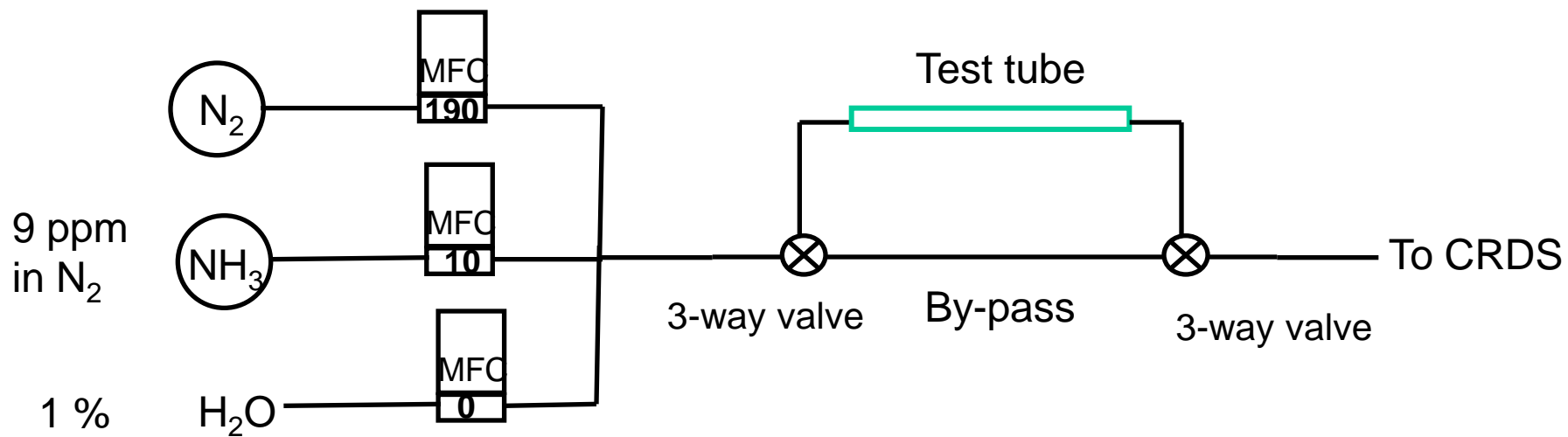

# Study protocol

- A) Test tube is flushed with indoor air ( $\geq 1$  h) and pure  $N_2$  ( $\geq 0.5$  h)
- B) Vacuum line and ring-down cavity (except test tube) are exposed to  $NH_3$  (in  $N_2$ )
- C) Concentration of ammonia is measured after  $\sim 1$  h
- D) Actual real-time adsorption measurement at  $6548.79\text{ cm}^{-1}$  in 3 phases:
  - 1) Ammonia gas flow via by-pass line
  - 2) Ammonia flow switched to go via test tube
  - 3) Slow recovery of ammonia signal

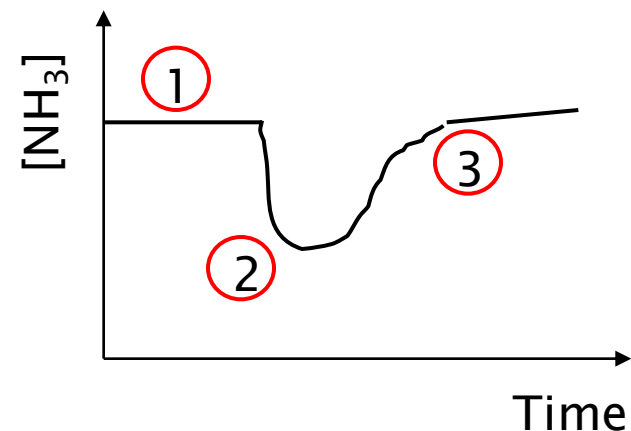
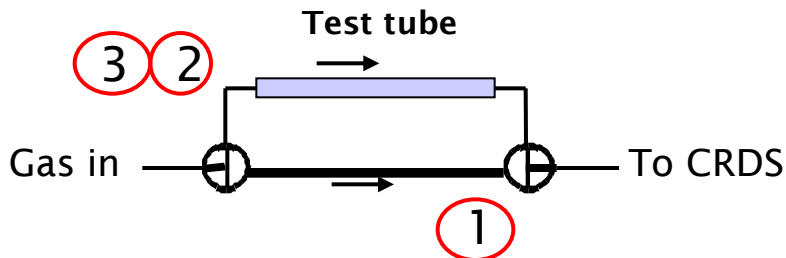

Dursan, 420 ppb

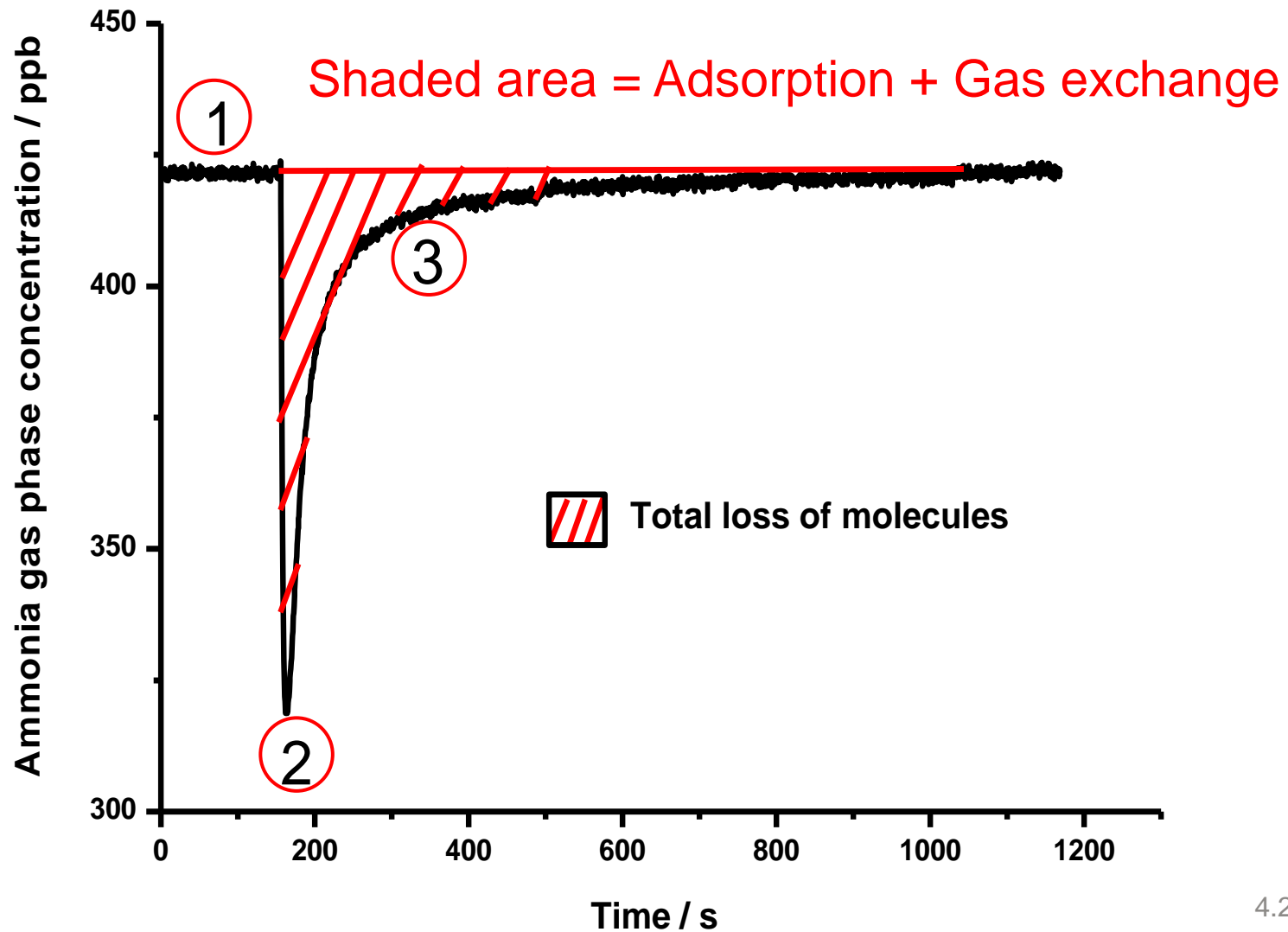

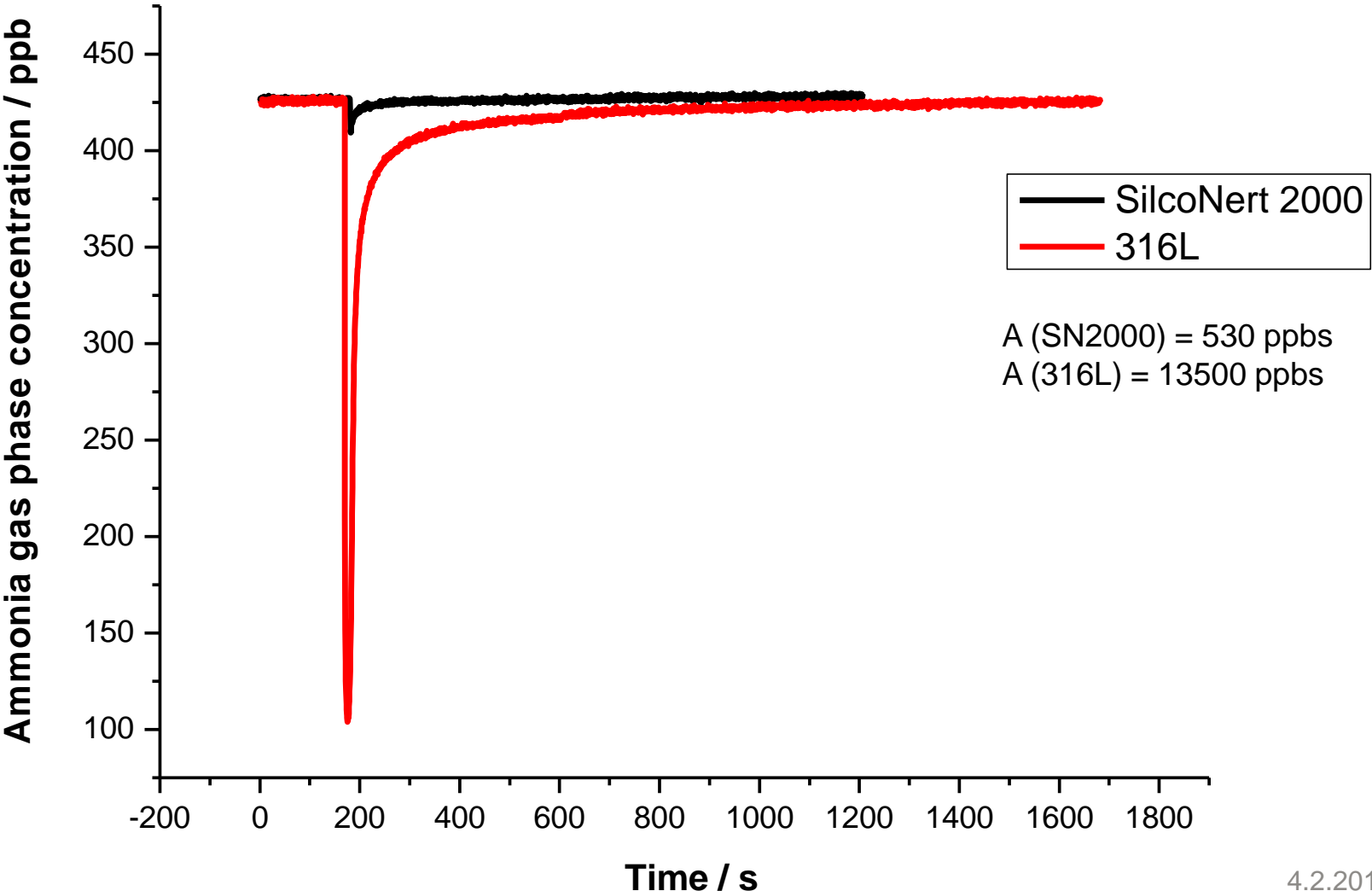

# Adsorption on metal / coated surfaces

Metal / coating	Adsorption* ( $10^{12}$ molecules/cm <sup>2</sup> )	St. deviation ( $10^{12}$ molecules/cm <sup>2</sup> )
SilcoNert 2000	5.7	0.6
SilcoNert 1000	14.6	0.9
EP SS316L	72	11
Dursan	101	5
SS316L	138	21

\*Average of 3 measurements

NH<sub>3</sub> conc = 420 ppb, p (tube) = 176 mbar



# Adsorption on polymer surfaces

Polymer	Adsorption* ( $10^{12}$ molecules/cm <sup>2</sup> )	St. deviation ( $10^{12}$ molecules/cm <sup>2</sup> )
PVDF	1.0	0.1
PELD	4.4	0.6
PTFE	7.5	1.9
FEP	8.6	0.3
PFA	13.9	1.0

\*Average of 3 measurements

NH<sub>3</sub> conc = 8750 ppb, p (tube) = 119 mbar



# Langmuir isotherm

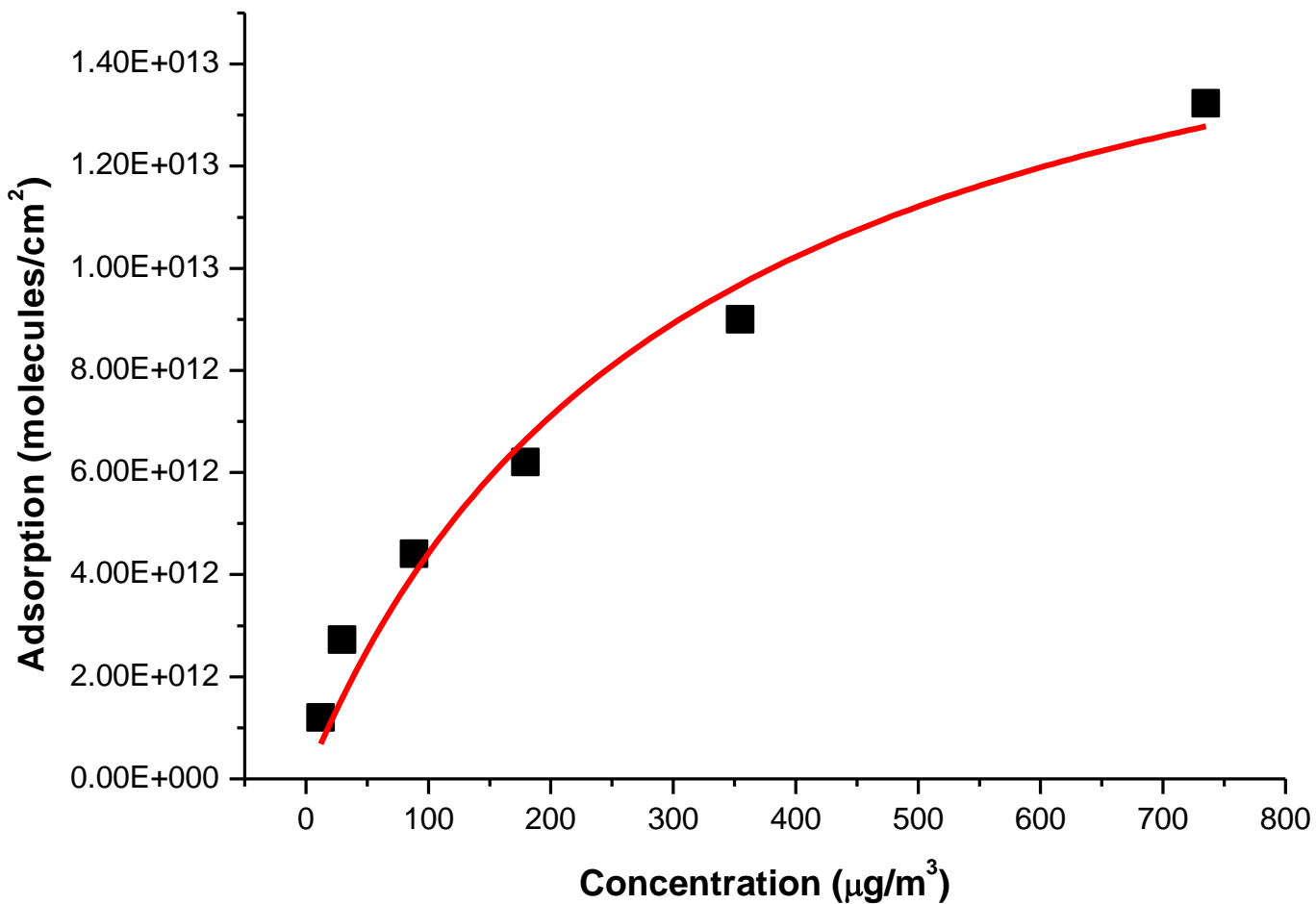

# Effect of water

SS 316L

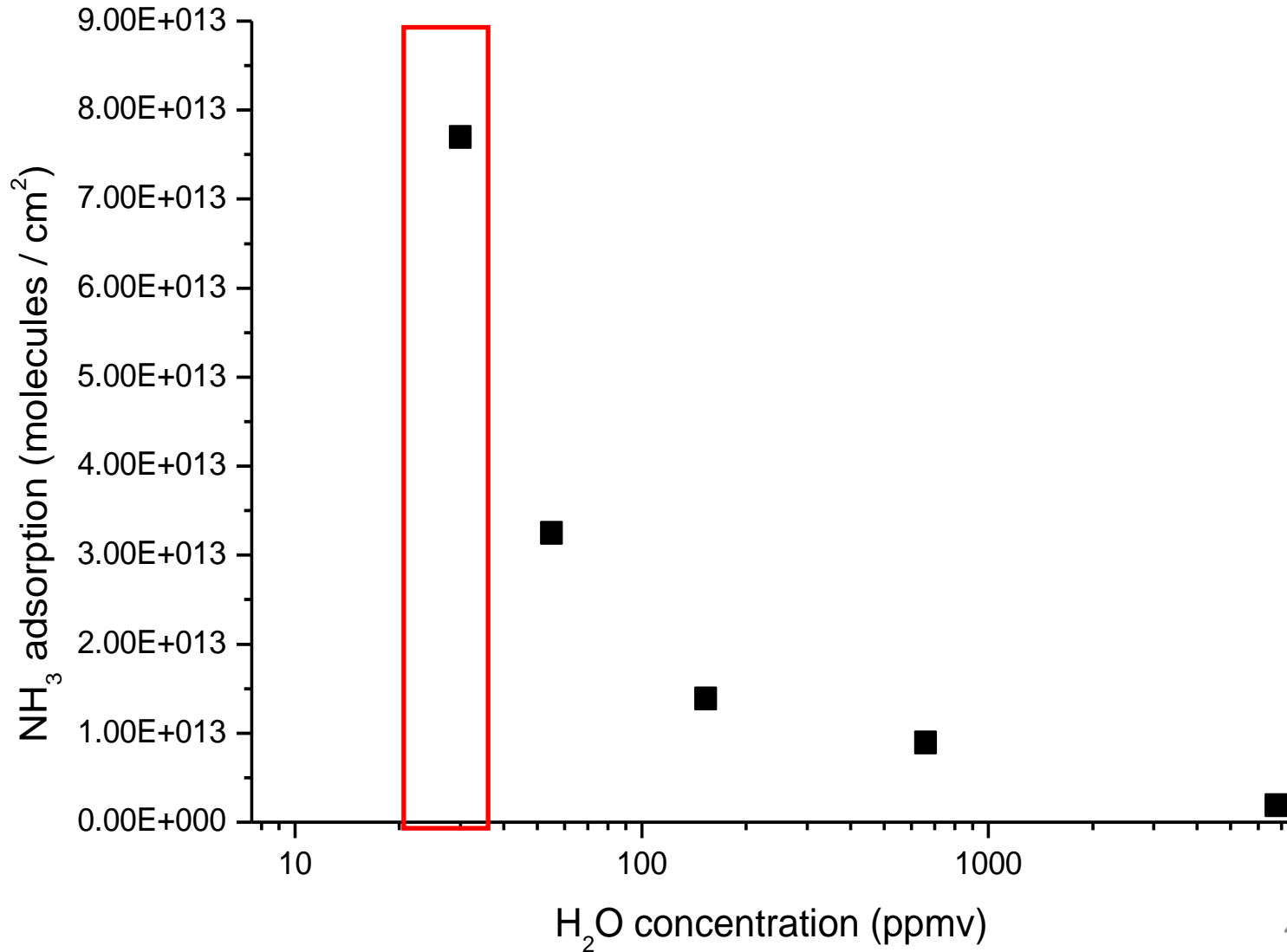



# Comparison to PTR-MS data\*



**CRDS:**

SS > Dursan >> SN2000 > PFA

**PTR-MS:**

SS >> Dursan >> SN2000 > PFA

## Ammonia transport through different tubings

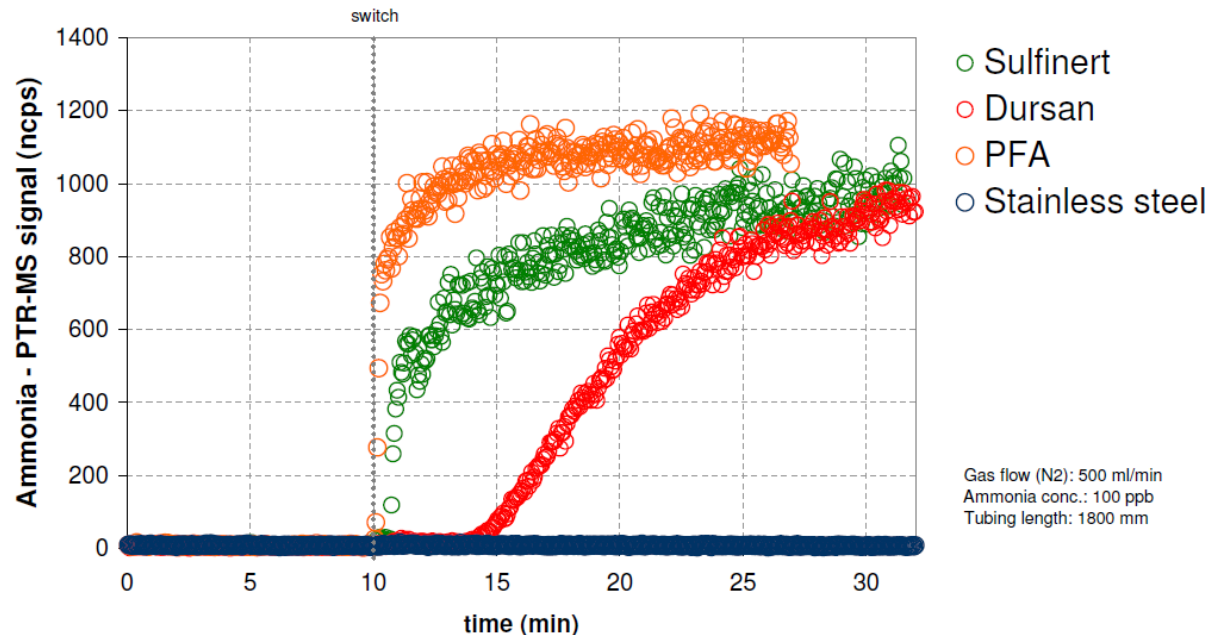

\*SilcoTek Corporation, Sulfinert = SilcoNert 2000

# Acknowledgements



*The research was carried out with funding by EURAMET and the European Union  
The EMRP is jointly funded by the EMRP participating countries within EURAMET and the European Union*

More information: [Olavi.Vaittinen@helsinki.fi](mailto:Olavi.Vaittinen@helsinki.fi)

O. Vaittinen *et al*, "Adsorption of gas phase ammonia on treated stainless steel and polymer surfaces,"  
submitted to *Measurement Science and Technology*

