

HANDLING AND MOUNTING PRECISION BALL BEARINGS

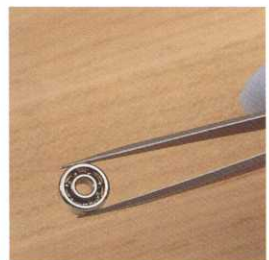

 **Emerson Bearing**
Service. Inventory. Solutions.

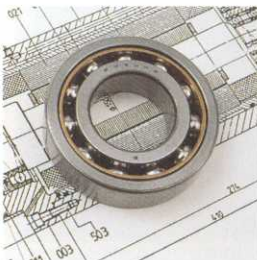
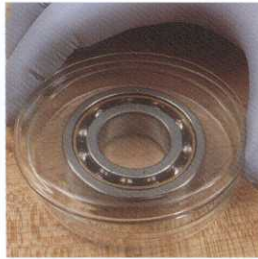
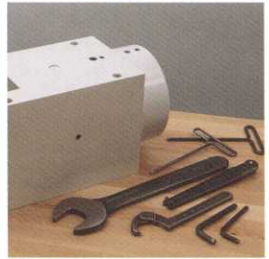

PRECISION BEARINGS: HANDLE WITH CARE

Barden Super Precision ball bearing tolerances are measured in millionths of an inch. Such stringent standards produce bearings that offer exceptional benefits including reduced noise and vibration levels, lower operating temperatures, greater accuracy, higher running speeds and longer life. Unfortunately, all too often bearing problems can be traced back to improper handling. Reaping the full benefits of such highly refined bearings requires users to observe proper installation techniques, to assure long and trouble-free performance.

Send for Barden's "Bearing Failure: Causes and Cures" booklet and wall chart. These excellent diagnostic resources are free upon request.



DAMAGE CAUSED BY DIRT AND CONTAMINANTS

Foreign particles entering a bearing can do severe damage by causing minute denting of the raceways and balls. The outward signs that contamination may be present include increased vibration, accelerated wear, the inability to hold tolerances and elevated running temperatures. All of these conditions could eventually lead to bearing failure.

Close examination of inner or outer ring races will show irregular dents, scratches or a pock-marked appearance. Balls will be similarly dented, dulled or scratched. The effects of some types of contamination may be hard to see at first because of their microscopic nature.

Irregular dents or material embedded in raceways.

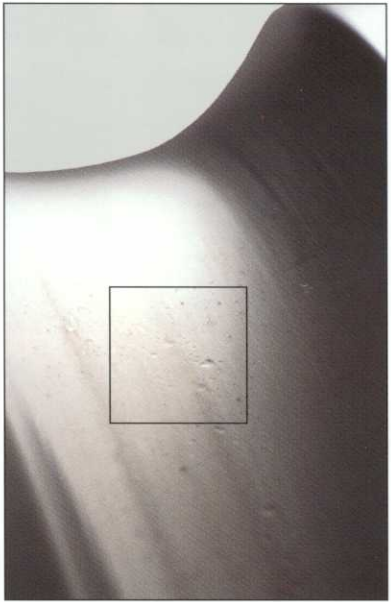
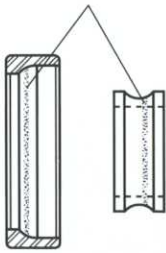

Sometimes, the effects of contamination are barely visible, as this magnified image shows.



P.O. BOX 2449 • 200 Park Avenue, Danbury, CT 06813-2449
(203) 744-2211 • FAX: (203) 744-3756 • (800) 243-1060, ext. 468

THE IMPORTANCE OF CLEANLINESS

If getting bearings to perform at their peak is the desired goal, then cleanliness is a topic that cannot be overstressed. Whenever bearings are handled, it is essential to keep them clean. Even microscopic particles of dirt can kill a bearing fast. Consider every kind of foreign matter a potential enemy to bearing performance.

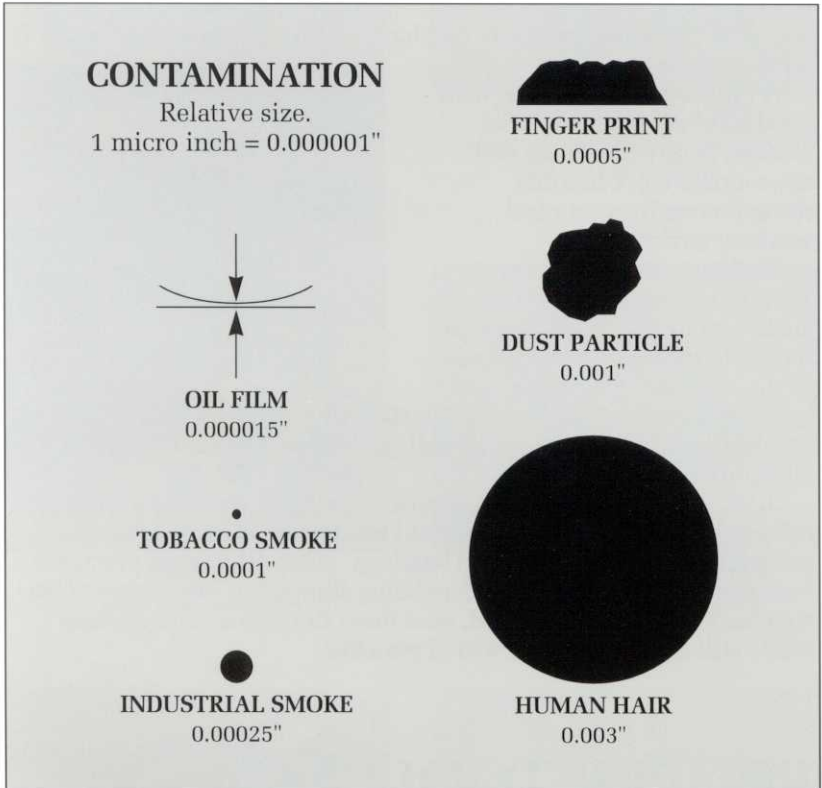

Chart compares relative sizes of typical contaminants. Oil film under boundary lubrication conditions is only 15 micro inches thick, and can be easily penetrated by even a single particle of tobacco smoke.

Dirt and contaminants are of three varieties:

- 1) Airborne contaminants — lint, metal fines, abrasive fines, smoke, dust.
- 2) Transferred contaminants — dirt which is picked up from one source and passed along to the bearing from hands, work surfaces, packaging, tools and fixtures.
- 3) Introduced dirt — typically from dirty solvents/lubricants.

Contaminants that are often overlooked are humidity and moisture, fingerprints (transferred through handling), dirty greases and oils, and cigarette smoke. All of the above sources should be considered abrasive, corrosive or leading causes of degradation of bearing performance. It should be noted that cleanliness extends not just to the bearings themselves, but to all work and storage areas, benches, transport equipment, tools, fixtures shafts, housings and other bearing components.

WORK AREA

Good bearing installation habits begin with a clean work area. Work bench surface materials include wood, rubber, metal and plastic. Generally, painted metal is not desirable as a work surface because it can chip, flake or rust. Plastic laminates may be acceptable and are easy to keep clean, but are also more fragile than steel or wood and are prone towards static electricity build-up. Stainless steel, splinter-free hardwoods such as maple, or dense rubber mats that won't shred or granulate and have no oily residue are all suitable work surfaces.

A clutter-free work area, with good lighting, organized tool storage, handy parts bins and appropriate work holding devices constitute an ideal working environment.

Under no circumstances should food or drink be consumed on or near work surfaces. Smoking should not be allowed in the room where bearings are being replaced. Locate bearing installation operations away from other machining operations (grinding, drilling, etc.) to help minimize contamination problems.

Static electricity—or any operation that may cause steel rings and balls to become magnetized—could result in dust or fine metallic particles being introduced into bearings. Since all Barden precision bearings are demagnetized before being shipped, if you suspect bearings have become magnetized, pass them through a demagnetizer while still in their original sealed pouches.



Good bearing installation habits begin with a clean work surface and the proper tools.

PROPER TOOLS

Every workbench should have a well-stocked compliment of proper tools to facilitate bearing removal and replacement. Tools required include wrenches and spanners (unplated and unpainted only), drifts, gages, gage blocks and bearing pullers.



An arbor press is used for interference fits with small shaft/small bore instrument bearings.

Bearing installers will also want to have access to a variety of diagnostic tools. These may include a run-in stand for spindle testing, a bearing balancer and a portable vibration analyzer.

Most spindle bearings are installed with an induction heater (using the principle of thermal expansion) which enlarges the inner ring slightly so the bearing can be slipped over the shaft. An arbor press can be used for installing small shaft/small bore miniature and instrument bearings.



HOOK SPANNERS

For disassembly and re-assembly of components.



INDUCTION HEATER

Heat expands inner ring for fitting onto shaft.



DRIFTS

Facilitate ring installation.



VIBRATION ANALYZER

Portable diagnostic tool.



OPEN END WRENCHES

Always use unplated tools.



RUN IN STAND

For testing spindle performance.



GAGES AND GAGE BLOCKS

Accurate to .0001".

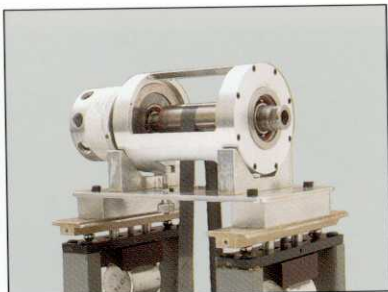

BALANCER

Weight distribution analysis.

DO'S

Observing a few simple precautions will help bearings attain their full and useful working life. It is particularly important to remember to keep bearings in their original pouch until ready to install. Bearing nomenclature is clearly marked on all boxes, so there is no need to open boxes to identify bearings. Other tips include:



Open package with scissors. Handle only with clean, dry hands or gloves.

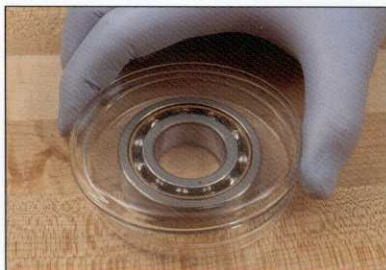

Protect unwrapped bearings by keeping them covered at all times.



Align high point mark on ring 180° from high point of shaft.

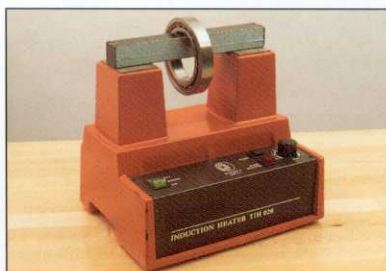

Use an induction heater for assembly (or arbor press for interference fits).



Use clean, burr-free tools that are not plated, painted or rusted.

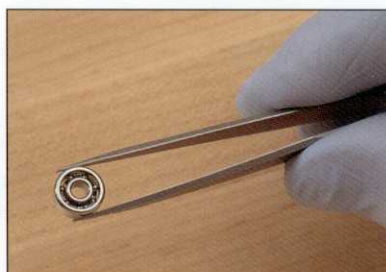

Use tweezers to install miniature and instrument bearings.



Keep maintenance logs and record bearing nomenclature from box.

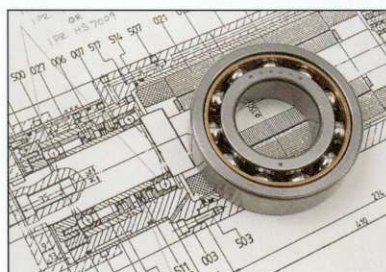

Keep mounting arrangements and blueprints on file for future reference.

DON'TS

Precision ball bearings will not perform as designed — or at all, in some cases — if they are mishandled or improperly installed. Practices to be avoided are illustrated below. If you have questions about the proper use or installation of Barden precision bearings contact your nearest authorized Barden distributor or Barden representative.



Don't open bearing pouch until ready to assemble components.



Don't wash new bearings. They are factory cleaned and lubricated.



Don't wipe parts dry with a rag, or lint could be introduced into the bearing.



Don't spin bearings with compressed air. Internal damage could result.



Don't use a hammer or screwdriver to install bearings. Never drop bearings.

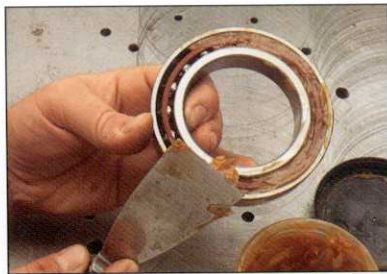

Don't over lubricate or mix different lubricant families.



Don't smoke, eat or drink while handling or installing bearings.

SHAFT AND HOUSING FITS

The ideal Barden precision bearing mounting has a line-to-line fit, both on the shaft and on the housing. Such an idealized fit has no interference or looseness. Many factors may influence fit, however.



It is critical that shafts and housings be clean, burr-free and machined to exact tolerances.

Interference fits should be used cautiously since they can distort the raceway and reduce radial play.

Loose fits may be advisable when:

- There are axial clamping forces
- Ease of assembly is important
- There must be axial movement to accommodate spring loading or thermal movements.

The appropriate fit may also vary, as governed by operating requirements and mounting design.

To ensure a proper fit, assemble only clean, burr-free parts. Even small amounts of dirt on the shaft or housing can cause severe bearing misalignment problems (See Fig. 1).

When press fitting bearings onto a shaft, force should be applied evenly and only to the ring being fitted (See Fig. 2), or internal damage to the bearing — such as brinelling — could result. If mounting of bearings remains difficult, selective fitting practices should be considered. Selective fitting — utilizing a system of bearing calibration — allows better matching of bearing, shaft and housing tolerances, and can provide more control over assembly.

Barden's C-10 Catalog, Engineering Section, provides considerable detail on specific shaft and housing fits, mounting recommendations and bearing calibrations. If you do not have a copy or would like additional copies, please contact your Authorized Barden Distributor, or a Barden representative.

These include:

- Operating conditions such as load, speed, temperature
- Provision for axial expansion
- Requirements for rigidity and rotational accuracy
- Machining tolerances

Interference fits (press fits) may be required in certain circumstances where there is:

- A need to avoid mass center shifts
- Heavy radial loading
- Vibration that could cause fretting and wear
- A need for heat transfer
- A lack of axial clamping

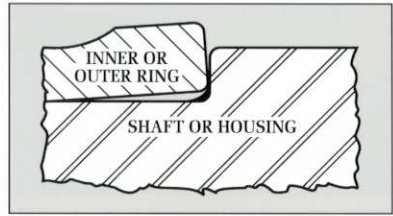

Fig. 1: Burrs or dirt cause bearing misalignment.

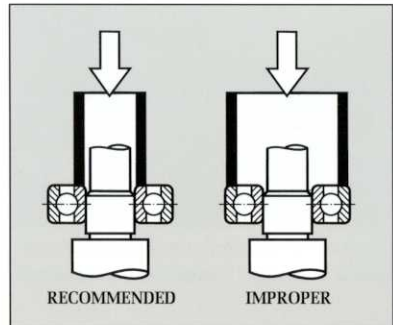
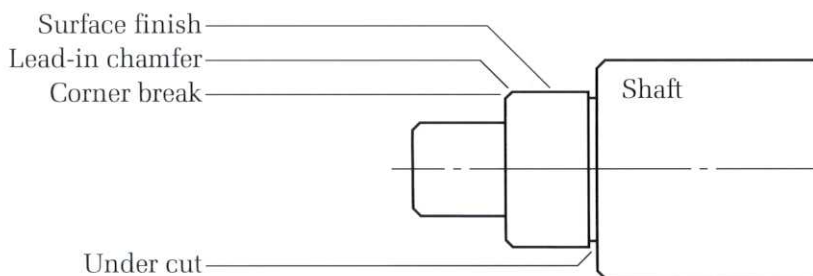

Fig. 2: When press fitting rings, force should only be applied to the ring being fitted.

RECOMMENDED SHAFT & HOUSING GEOMETRIES

Bearing seats on shafts and housings must be accurately machined, and should match the bearing ring width to provide maximum seating surface. Shaft and housing shoulders must also be high enough to provide solid seating and accurate alignment for maximum thrust support under maximum thrust load conditions. Shoulders should not interfere with cages, seals or shields. Refer to Barden's C-10 catalog for additional specifications. Recommendations for geometry and surface finish tolerances are shown in the diagrams below.



Detail or characteristic	Specification
Lead-in chamfer	Required
Under-cut	Preferred
All corners	Burr-free at 5x magnification
Surface finish	16 micro inch AA max
Bearing seats	Clean at 5x magnification

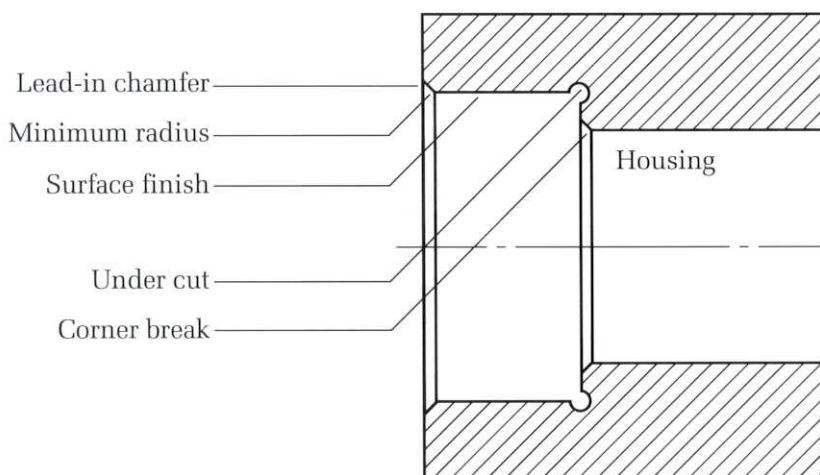

Detail	Bearing	Miniature and instrument size bearings	Nominal bore diameter, mm		
			6-50	51-120	121-180
Corner break, min.		.001"	.002"	.003"	.004"
Minimum radius		.003"	.003"	.003"	.004"

RECOMMENDED SHAFT TOLERANCES

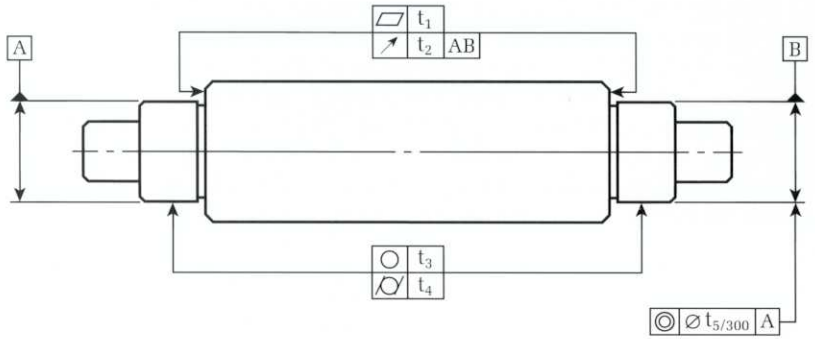

TOLERANCE VALUES IN MICROINCHES

Characteristic	O.D., mm						
	6-10	11-18	19-30	31-50	51-80	81-120	121-180
▭ Flatness, t_1	60	80	100	100	120	150	200
↗ Runout, t_2	100	120	150	150	200	250	300
○ Roundness, t_3	50	60	75	75	100	125	150
∕ Taper, t_4	50	60	75	75	100	125	150
◎ Concentricity, t_5	100	120	150	150	200	250	300

SHAFT DIAMETERS FOR VARIOUS FIT CLASSIFICATIONS

Nominal inner ring bore mm	T			
	min.		max.	
	C		N	
	min. in.	max. in.	min. in.	max. in.
7	.2753	.27545	.2756	.27575
8	.3417	.34185	.3420	.34215
9	.3540	.35415	.3543	.35445
10	.3934	.39355	.3937	.39385
12	.4721	.47225	.4724	.47255
15	.5903	.59045	.5906	.59075
17	.6690	.66915	.6693	.66945
20	.7871	.78725	.7874	.78755
25	.9840	.98415	.9843	.98445
30	1.1808	1.18095	1.1811	1.18125
35	1.3776	1.3778	1.3780	1.3782
40	1.5774	1.5776	1.5778	1.5780
45	1.7713	1.7715	1.7717	1.7719
50	1.9681	1.9683	1.9685	1.9687
55	2.1650	2.1652	2.1654	2.1656
60	2.3618	2.3620	2.3622	2.3624
65	2.5587	2.5589	2.5591	2.5593
70	2.7555	2.7557	2.7559	2.7561
75	2.9524	2.9526	2.9528	2.9530
80	3.1492	3.1494	3.1496	3.1498
85	3.3460	3.34625	3.3465	3.34675
90	3.5428	3.54305	3.5433	3.54355
95	3.7397	3.73995	3.7402	3.74045
100	3.9365	3.93675	3.9370	3.93725
105	4.1334	4.13365	4.1339	4.13415
110	4.3302	4.33045	4.3307	4.33095
120	4.7239	4.72415	4.7244	4.72465
130	5.1175	5.1178	5.1181	5.1184

T = Line to line fit

C = Loose fit — ABEC-7 bearing size tolerance

N = Tight fit — ABEC-7 bearing size tolerance

RECOMMENDED HOUSING TOLERANCES

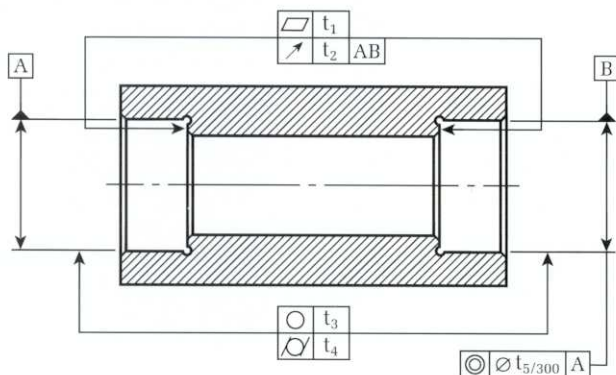

TOLERANCE VALUES IN MICROINCHES

Characteristic	O.D., mm						
	10-18	19-30	31-50	51-80	81-120	121-180	181-250
Flatness, t_1	80	100	100	120	150	200	300
Runout, t_2	120	150	150	200	520	300	400
Roundness, t_3	75	100	125	150	150	200	250
Taper, t_4	60	75	75	100	125	150	200
Concentricity, t_5	120	150	150	200	250	300	400

HOUSING DIAMETERS FOR VARIOUS FIT CLASSIFICATIONS

Nominal outer ring o.d. mm	T			
	min.		max.	
	N		C	
	min. in.	max. in.	min. in.	max. in.
22	.8657	.8659	.8661	.8663
24	.9445	.9447	.9449	.9451
26	1.0232	1.0234	1.0236	1.0238
28	1.1020	1.1022	1.1024	1.1026
30	1.1807	1.1809	1.1811	1.1813
32	1.2594	1.2596	1.2598	1.2600
35	1.3776	1.3778	1.3780	1.3782
37	1.4563	1.4565	1.4567	1.4569
40	1.5744	1.5746	1.5748	1.5750
42	1.6531	1.6533	1.6535	1.6537
47	1.8500	1.8502	1.8504	1.8506
52	2.0468	2.0470	2.0472	2.0474
55	2.1650	2.1652	2.1654	2.1656
62	2.4405	2.4407	2.4409	2.4411
68	2.6768	2.6770	2.6772	2.6774
72	2.8342	2.8344	2.8346	2.8348
75	2.9524	2.9526	2.9528	2.9530
80	3.1492	3.1494	3.1496	3.1498
85	3.3459	3.3461	3.3463	3.3465
90	3.5427	3.5429	3.5431	3.5433
95	3.7396	3.7398	3.7400	3.7402
100	3.9364	3.9366	3.9368	3.9370
105	4.1333	4.1335	4.1337	4.1339
110	4.3301	4.3303	4.3305	4.3307
115	4.5270	4.5272	4.5274	4.5276
120	4.7238	4.7240	4.7242	4.7244
125	4.9205	4.9207	4.9209	4.9211
130	5.1173	5.1175	5.1177	5.1179
140	5.5110	5.5112	5.5114	5.5116
145	5.7079	5.7081	5.7083	5.7085
150	5.9047	5.9049	5.9051	5.9053
160	6.2984	6.2986	6.2988	6.2990
165	6.4953	6.4955	6.4957	6.4959
170	6.6921	6.6923	6.6925	6.6927
180	7.0858	7.0860	7.0862	7.0864
190	7.4795	7.4797	7.4799	7.4801
200	7.8732	7.8734	7.8736	7.8738

NOTE: T fits have the same bore and o.d. dimensions as bearings with ABEC-7 tolerances. T (max) Dia. are nominal values.

NOMENCLATURE

BARDEN PRECISION BEARINGS

Chart shows sequence of bearing box nomenclature, used to identify bearing type and characteristics.

