

Koyo

JTEKT
Group

TRAINING MANUAL

Koyo Corporation of USA has been inducted into John Deere's Supplier Hall of Fame and has been awarded over 20 distinguished supplier awards during the past several years, including Ford's Q-1 Supplier Award, as well as many others from automotive and industrial customers.



With Koyo, you get over 80 years of engineering and manufacturing excellence. As part of the Toyota group, JTEKT owns and operates bearing plants in seven countries, sales facilities in 20 countries and research & development Technical Engineering Centers on 3 continents. Koyo offers innovative solutions to both original equipment manufacturers and aftermarket end users focusing on key markets such as automotive, steel, agriculture, electric motor, wind power, power sports, lift truck and general industry. When you select Koyo, you no longer have to choose between quality and competitive price... you get both!

The contents of this manual are subject to change without prior notice. Every possible effort has been made to ensure that the data contained herein is correct. However, we cannot assume responsibility for any errors or omissions. Reproduction of this manual or its contents without permission from Koyo Corporation of USA is strictly prohibited. All rights reserved. Koyo Corporation of USA 2008

Koyo

CONTENTS

BEARING BASICS

Bearing Design, Function, And History.....	2
Bearing Designs, Features, And Applications.....	4
Speciality Bearings Design And Features.....	15
Bearing Part Numbering And Nomenclature.....	22

Section
1

MATERIALS & MANUFACTURING

Material Characteristics Of Bearing Components.....	30
Bearing Manufacturing Process.....	33

Section
2

THE BEARING SELECTION PROCESS

Application Operating Condition Considerations.....	38
Selection Of Bearing Mounting Arrangements.....	42
Bearing Service Life And Load Ratings.....	45

Section
3

BEARING TOLERANCES, FITS & CLEARANCES

Bearing Tolerances And Classes.....	52
Bearing Shaft And Housing Fits.....	52
Fitting Practice Tables.....	62
Bearing Internal Clearances And Preload.....	66

Section
4

BEARING STORAGE, HANDLING & CLEANING

Bearing Storage And Handling Precautions.....	72
Bearing Cleaning Methods.....	73

Section
5

BEARING MOUNTING & REMOVAL

Bearing Mounting Preparations And Precautions.....	76
Mounting Methods For Cylindrical Bore Bearings.....	77
Mounting Procedure For Tapered Roller Bearings.....	80
Installation Procedure For Tapered Bore Bearings.....	82

Section
6

BEARING LUBRICATION

Purpose And Regimes.....	88
Terminology.....	90
Grease And Oil Lubrication.....	92
Grease Compatibility.....	104

Section
7

BEARING FAILURE ANALYSIS

Determining Mode Of Bearing Failure.....	107
Types Of Bearing Failures And Damage.....	108

Section
8

TROUBLESHOOTING BEARING PROBLEMS

Problem And Possible Solutions	116
--------------------------------------	-----

Section
9

GLOSSARY

Terms And Definitions ...	119
---------------------------	-----

Section
10

SECTION 1 - Bearing Basics

BEARING DESIGN AND FUNCTION

FRICITION DESCRIPTION

Friction is the force that resists relative motion between two surfaces in contact. An object must be in contact with another object or material and an external force must be applied on the object in an attempt to move it. The type of motion determines the type of friction. Two types of friction are sliding and rolling. Sliding friction can be illustrated by considering the example of a stack of books on a desk and the force required to move the books. The force required to move the books will depend on the weight of the books and the surface roughness of the materials which can be large.

If the books can roll on the desk the force resisting the motion is termed rolling friction or rolling resistance. Typically rolling friction is considerably less than sliding friction. If the same stack of books now has rollers or balls between it and the desk, the force required to move the books is now much less than when it was directly on the table.

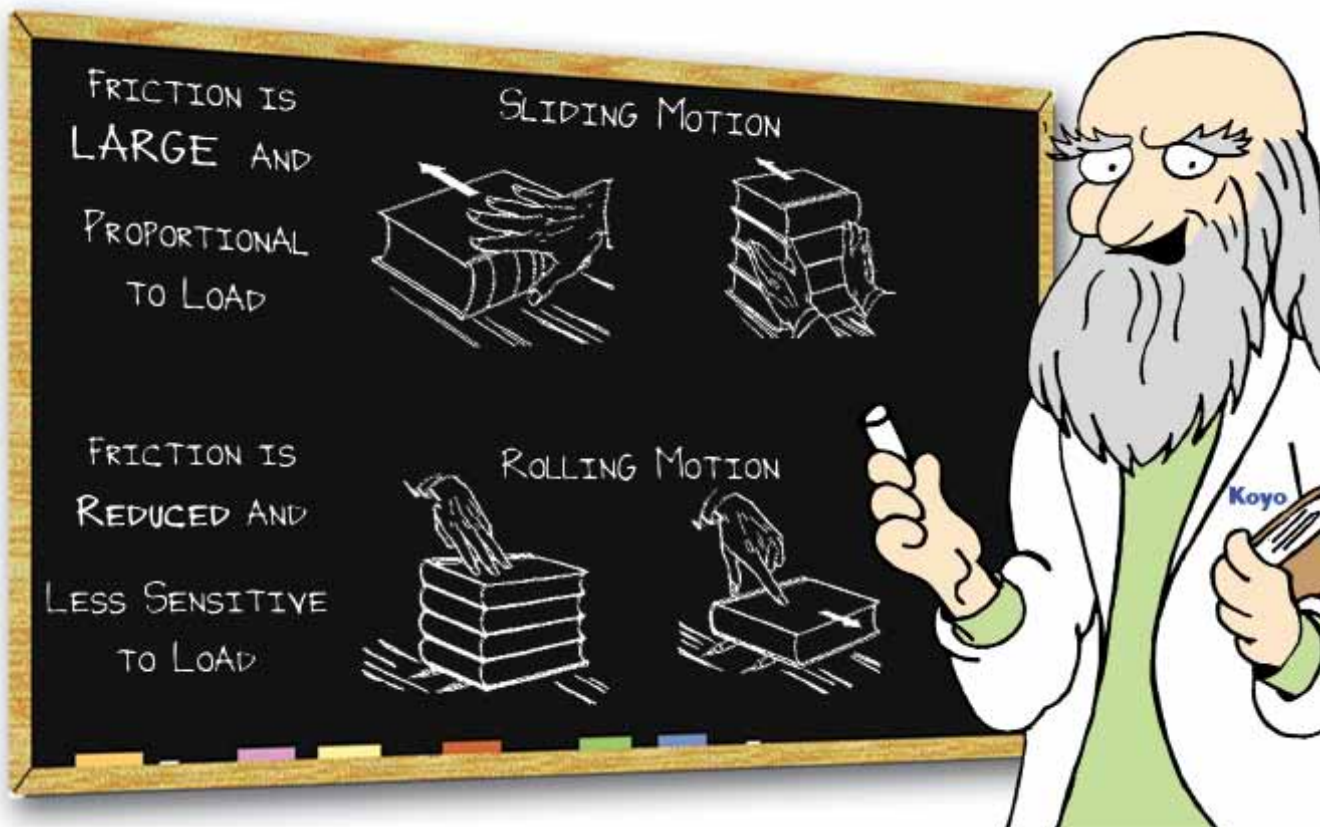

SECTION 1 - Bearing Basics

HISTORY AND DEVELOPMENT OF BEARINGS

The basic means of using rolling elements to overcome friction as illustrated is in fact ancient history. Egyptian hieroglyphics show huge blocks of stone used to build the pyramids being transported by sliding them on tree trunks acting as bearings.



Another early example of the use of ball bearings has been dated back to 40 BC with the retrieval of a Roman ship found in Lake Nemi, Italy. It was discovered that wooden balls were used to support a rotating platform.



DID YOU KNOW...

Leonardo da Vinci is officially credited with discovering the principles of bearing function in



the 15th century. He realized that friction could be further reduced if the balls of a bearing did not touch each other. He subsequently developed separators for use between the balls allowing them to move freely around the retaining rings.

His retained ball bearing concept is illustrated in the sketch below.

Leonardo's ball bearing was reinvented again in the 18th

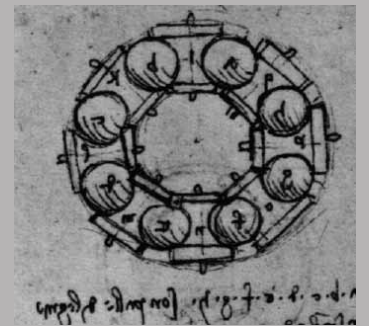

century when a horse carriage axle was fitted with a ring of balls rotating in grooves cut into the axle. With the advent of the industrial revolution during the 19th century, bearing applications were everywhere and the bearing was further developed and refined in conjunction with technology and metallurgy.

SECTION 1 - Bearing Basics

BEARING DESIGN AND FUNCTION

ROLLING ELEMENTS OVERCOME FRICTION

As illustrated on the previous page, placing rolling elements between moving surfaces replaces sliding friction with rolling motion. This is the basis for all rolling element bearings. Rolling element bearings will use either balls or rollers as the rolling element component of the bearing. There are other types of bearings used to overcome friction such as journal and fluid bearings, but rolling element bearings have become the most widely accepted, cost effective, and easily adapted anti-friction bearing solution.

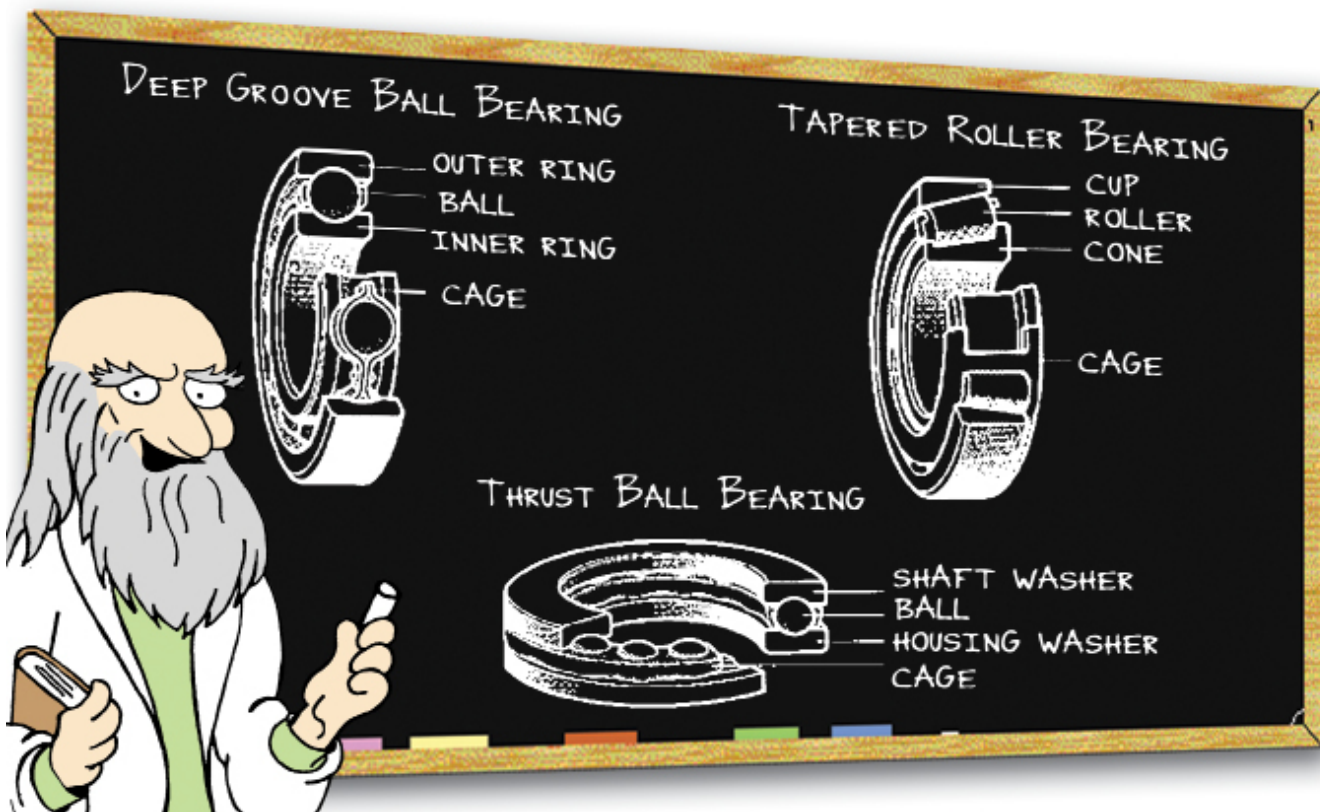

SECTION 1 - Bearing Basics







TYPES OF ROLLING ELEMENT BEARINGS

There are many different types of rolling element bearings. The key in determining a bearing type is the style of the rolling element itself. Although ball bearings are available in different configurations and designs, they are still identified as ball bearings because of the rolling element. Bearings using rollers as the rolling element can be in various shapes. As illustrated below, roller bearings are available as cylindrical, needle, tapered (trapezoid), and spherical (barrel shaped). Roller bearings will have a line contact area between rollers and rings and will provide heavier load capacities compared to a point contact ball. However, the point contact ball will generate less rolling friction than a roller element bearing, making it better suited for higher operating speeds.

In addition to the rolling element the majority of bearings consist of an inner ring, outer ring, and retainer or cage to guide and separate the rolling elements. In tapered roller bearings, the inner ring is normally called the cone, while the outer ring is referred to as the cup. The rolling paths of the elements on the rings are called raceways. With ball bearings, since the ball path is actually a groove, it is referred to as a raceway groove. In thrust bearings the inner and outer rings are called shaft and housing washers respectively.

The inside diameter of the inner ring is normally referred to as the bore and is mounted on a shaft or spindle. The outside diameter of the outer ring is usually in contact with a housing or hub in most applications. Radial bearings are designed primarily for carrying radial load. Most radial bearings can carry some thrust loading with the thrust carrying ability dependent on the contact angle and type of rolling element (steeper angle tapered rollers have relatively high thrust capacities). However, with the exception of spherical thrust bearings, which can carry a small amount of radial load, thrust bearings can only carry thrust loads.

TYPES OF ROLLING ELEMENTS



	BALL
	CYLINDRICAL ROLLER
	LONG CYLINDRICAL ROLLER
	NEEDLE ROLLER
	TAPERED ROLLER
	CONVEX ROLLER

SECTION 1 - Bearing Basics

RADIAL BALL DESIGNS, FEATURES AND APPLICATIONS

There are two basic design characteristics for all types of radial ball bearing types; the no-fill slot or Conrad design, and the filling slot or maximum capacity design. The Conrad design is named for its inventor, Robert Conrad, who received a British patent in 1903 and one in the U.S. in 1906. Since the Conrad bearing designs do not have a fill slot, the bearing is assembled by displacing the inner ring eccentrically in relation to the outer ring to allow insertion of the balls.

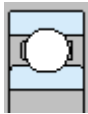
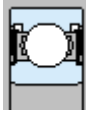
FEATURES OF DEEP GROOVE RADIAL BEARINGS

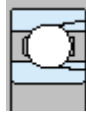
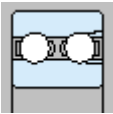
DEEP GROOVE RADIAL BALL BEARING TYPES									
Open type		Shielded/ sealed type		With locating snap ring		Maximum type		Double-row	
									
		ZZ 2RU 2RS 2RD		NR		With filling slot			
680	690		600	620	630	(ML)	Extra small miniature bearings	M6200	4200
6800	6900	16000	6000	6200	6300	6400		M6300	4300

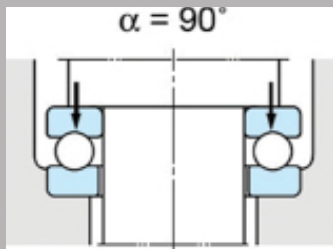
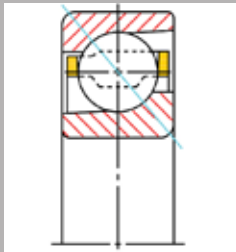
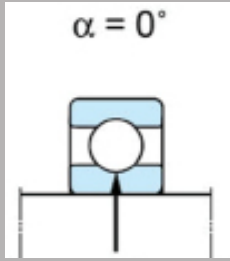

The contact angle (α) is the angle formed by the direction of the load applied to the bearing rings and rolling elements, and a plane perpendicular to the shaft center, then the bearing is loaded.

Bearings are classified into two types in accordance with the contact angle (α).

Radial Bearings

$$(0^\circ \leq \alpha \leq 45^\circ)$$

Designed to accommodate mainly radial load.

Thrust Bearings

$$(45^\circ < \alpha \leq 90^\circ)$$

Designed to accommodate mainly Axial load.

The most popular rolling bearing type used in a wide variety of industries and applications

- The inner and outer rings have deep uninterrupted grooves
- They can support radial loading and certain degree of axial loading in either direction
- High speed capability
- The Maximum style not to be used when axial loading or high speed is involved
- Sealed and shielded types are filled with an appropriate volume of grease
- Bearings with a locating snap ring aid axial positioning and eliminate need for housing shoulder
- Cages can be a pressed steel, machined copper alloy, molded polyamide, synthetic resin, pressed stainless sheet steel

MAIN APPLICATIONS

Automotive: Transmissions, electrical devices, truck and trailer equipment



Off-Highway Vehicles: Construction equipment, agricultural equipment, railroad rolling equipment.

Electrical Equipment: Standard motors, electric appliances for domestic use

Other: Measuring instruments, medical instruments, and miscellaneous industrial equipment.

SECTION 1 - Bearing Basics

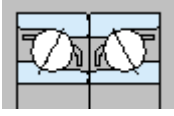
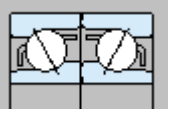
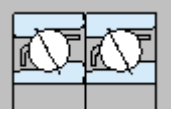
ANGULAR CONTACT BALL BEARINGS

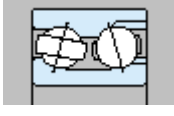
Single-row	Back-to-back arrangement		Face-to-face arrangement		Tandem arrangement	Double-row	
							
	DB		DF		DT	With filling slot	
	7000,	7200,	7300,	7400	Contact angle 30°		
	7000B,	7200B,	7300B,	7400B	Contact angle 40°		
7900C,	7000C,	7200C,	7300C		Contact angle 15°		
ACH900C, ACH000C					Contact angle 15°		
						3200 3300 Contact angle 32°	5200 5300 Contact angle 24°

FEATURES OF ANGULAR CONTACT BALL BEARINGS



- The contact angle between the bearing balls and rings is normally 15, 30, or 40 degrees
- The larger contact angle bearings have greater thrust load capacity.
- Single row bearings can accommodate radial load and axial load in one direction only
- Double row matched bearings can accommodate radial load and axial load in either direction
- The DT double tandem arrangement should be used for higher axial loads
- Angular contact bearings can provide a high degree of accuracy and are capable of running at high speed
- Cages can be pressed steel, machined copper alloy, molded polyamide, and machined synthetic resin

MAIN APPLICATIONS

- Automotive: Front wheel bearings, transmissions, differential pinion shaft.
- Electrical: High frequency motors.
- Industrial Equipment: Machine tool spindles, pumps, gas turbines, centrifugal separators, and Printing equipment.

SECTION 1 - Bearing Basics

SELF-ALIGNING BALL BEARINGS

Cylindrical bore		Tapered bore		Sealed
				
		K Taper 1:12		2RS
	120	130		2200 2RS 2300 2RS
	1200	1300		
	2200	2300		
(11200,11300 extended inner ring type)				

FEATURES OF SELF-ALIGNING BALL BEARINGS

- The Self-Aligning ball bearing has two rows of balls
- The balls roll on a spherical outer ring raceway
- The inner ring, balls and retainer can align themselves and accommodate for shaft and housing misalignment and deflections
- The tapered bore design allows for easy mounting with an adaptor sleeve
- Pressed steel cages are either a staggered or snap type

MAIN APPLICATIONS

Power transmission shafts of wood working and spinning machines
Plummer blocks

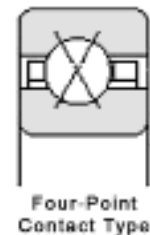

FOUR-POINT CONTACT BALL BEARINGS

FEATURES OF FOUR-POINT CONTACT BEARINGS



- A four-point or X –type bearing is designed with Gothic arch raceways creating four contact points between the balls and the raceways
- The design can accommodate a radial load and axial loading in both directions
- This bearing is also suitable for use with pure axial loading or a combined axial and moment loading
- A single four point contact bearing can be substituted for a two-row face-to-face or back-to-back angular contact arrangement
- The contact angle of this bearing is determined by the axial load direction.
- The cage is a machined copper alloy, pressed steel, or molded polyamide.

MAIN APPLICATIONS

- Automotive: Transmissions and steering mechanisms
- Motorcycles: Transmissions and pinion drive shafts.
- Industrial: Turntables

SECTION 1 - Bearing Basics

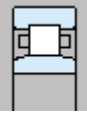
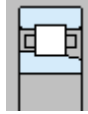
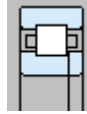
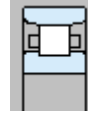
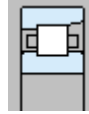
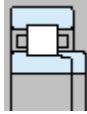
RADIAL ROLLER DESIGNS, FEATURES, AND APPLICATIONS

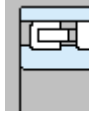
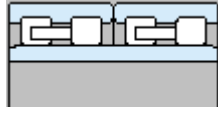
Single-row						Double-row		Four-row
								
NU	NJ	NUP	N	NF	NH	NNU	NN	Mainly use on rolling mill roll neck
NU1000	NU200(R)	NU300(R)	NU400	Cylindrical bore NNU4900 NNU4900K		Tapered bore NN3000 NN3000K		(FC), (4CR)
	NU2200(R)	NU2300(R)						
	NU3200	NU3300						

- The design allows linear contact of the cylindrical rollers with the raceways resulting in excellent radial load and impact load capacity.
- The rollers have a slight crown to relieve the ends and reduce stress concentration
- The geometry allows for accurate machining to precision grade quality and use at high speeds
- The inner or outer rings can be separated, simplifying mounting and removal of the bearing
- The N and NU type with flanges only on the outer or inner rings, allow for shaft movement and thermal expansion but will not carry axial load
- Types NJ and NF have flanges on each end of the inner or outer races and a single flange on the inner or outer race to carry axial load in one direction
- The NUP and NH use a loose rib and thrust collar on the inner race to allow some axial load capacity in both directions
- Double row cylindrical like single row cylindrical, are available with either a separable inner or outer race
- Double rows are available with either a cylindrical or tapered bore
- Double row cylindrical can also be provided with lubrication holes and grooves in the outer ring
- Four row designs are used mainly on rolling mill roll necks where heavy radial load capacity is required
- Cage types are pressed steel, machined copper alloy, and pin type.

MAIN APPLICATIONS

- **AUTOMOTIVE:** Internal combustion engines transmissions, and cargo transportation
- **ELECTRICAL:** Large and medium sizes motors, traction motors and generators
- **INDUSTRIAL:** Gear boxes and machine tool spindles, steel mills

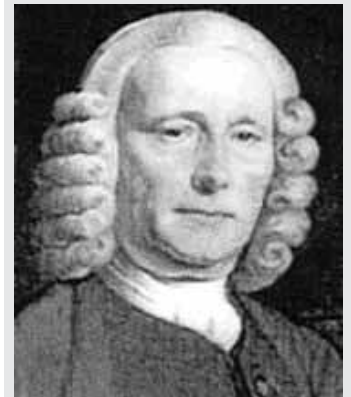

It may be argued that since tree trunks were a popular early means of moving large objects, the roller was the first rolling element bearing used. However, it took a 1750 English clock designer, John Harrison, looking to design an accurate clock for maritime use, to invent a caged roller bearing that would achieve the low friction requirements and accuracy needed for his clock. The Roller Bearing is now considered the best rolling element bearing for load carrying capacity and speed capability.

SECTION 1 - Bearing Basics

TAPERED ROLLER BEARINGS

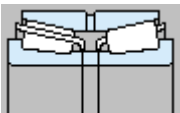
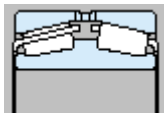
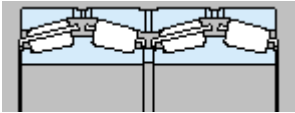
Single-row				Double-row		Four-row
						
				TDO type	TDI type	Mainly used on rolling mill roll necks
(Standard contact angle)		(Intermediate contact angle)	(Steep contact angle)	46200		
32900JR	30200JR			46200A	45200	37200
32000JR	32200JR	30200CR	46300	45300	47200	
33000JR	33200JR	32200CR	46300A	(45T)	47300	
33100JR	30300JR	30300CR	(46T)		(47T)	
	32300JR	32300CR				

FEATURES OF TAPERED ROLLER BEARINGS



- The inner ring assembly of a tapered roller is referred to as the cone, while the outer ring is called the cup.
- Tapered rollers are guided by the cone back face rib.
- This bearing design is suitable for heavy radial loading and a sizeable amount of axial loading.
- The taper of the rollers and the cone raceways have a common apex on the bearing axis.
- The angle between the cup raceway and the bearing axis is the contact angle.
- The larger the contact angle the greater the bearings axial load capacity.
- The cone and cup are separable simplifying bearing mounting.
- Single row bearings can accommodate radial load and axial load in one direction.
- Two single row bearings are used opposing each other to simplify setting of the proper clearance between the two rows.
- The two row design can handle radial load and an axial load in either direction.
- The two row design is available as a TDO (double outer race), or a TDI (double inner race).
- Two row taper designs are normally supplied with spacers to provide a pre-adjusted assembly.
- The four row design is commonly used on rolling mill roll necks for their large load carrying capacity.
- Cages used can be a pressed steel or a pin type.

MAIN APPLICATIONS

- **AUTOMOTIVE:** Front and rear wheels, transmissions, differential pinion
- **OFF-HIGHWAY VEHICLES:** Railroad, Construction, and Agricultural equipment
- **INDUSTRIAL:** Rolling mill equipment, gear boxes, and machine tool spindles.

SECTION 1 - Bearing Basics

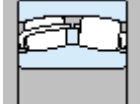
SPHERICAL ROLLER BEARINGS

Convex asymmetrical roller type	Convex symmetrical roller type		Tapered bore
			
R	RH, RHR	RHA	K or K30
23900 23000 23100 22200 21300 24000 24100 23200 22300			

FEATURES OF SPHERICAL ROLLER BEARINGS

- There are two basic spherical roller bearing designs.
- R & RR type uses two sets of convex asymmetrical rollers separated by a center inner ring rib.
- The RH, RHR, and RHA design uses two rows of longer symmetrical rollers and only a center guide ring instead of a rib.
- The bearing is self-aligning and forgiving to errors of up to 1.5° of misalignment between the shaft and housing due to shaft bending.
- Spherical bearings can carry radial and axial load in both directions.
- Suitable for applications where there is heavy radial and impact loading applied.
- The bearing can be manufactured with a cylindrical or taper bore.
- The taper bore bearing is easily mounted with the use of an adaptor sleeve
- Lubrication grooves and holes can be provided on either the inner or outer rings.
- Cage types can be pressed steel, machined copper alloy.

MAIN APPLICATIONS

- OFF-HIGHWAY: Railroad axle journals
- INDUSTRIAL: Paper manufacturing equipment, gear boxes, continuous casters, rolling mill pinion stands, table rollers, crushers, shaker screens, and printing cylinders

SECTION 1 - Bearing Basics

NEEDLE ROLLER BEARINGS

FEATURES OF NEEDLE ROLLER BEARINGS

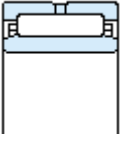
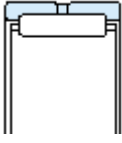
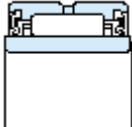
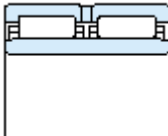
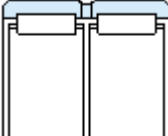
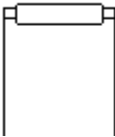
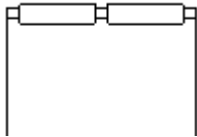
Machined ring needle roller bearings			
Single-row			
			
With inner ring	Without inner ring	Sealed	
NA4800	RNA4800	NA4900UU	
NA4900	RNA4900		
NA5900	RNA5900		
(NQI, NQIS)	(NQ, NQS)		
Double-row			
			
With inner ring	Without inner ring		
NA6900 RNA6900			
Needle roller and cage assemblies			
Single-row		Double-row	
			
R			
RS		WR	
V		WV	
VS			

- The basic design of needle rollers bearings is the same as the NU type cylindrical roller
- For those applications where minimal cross section height is required
- The rollers of needle bearings are longer and smaller in diameter than cylindrical rollers
- Needle roller bearings cannot carry thrust loading but have relatively high radial capacity
- Needle rollers are available in different styles with and without inner rings and seals
- When used without inner rings the shaft is heat treated and ground to function as the raceway surface.
- Drawn cup needle roller bearings use an outer ring in the form of a cup drawn with no additional machining performed.
- Drawn cup needles are available with open ends or a single closed end to seal and protect the end of the shaft
- The Drawn cup design is also made with a cage or as a full complement without a cage
- Cage material is a pressed steel

MAIN APPLICATIONS

- **AUTOMOTIVE:** Automobile engines, transmissions, pumps, and compressors
- **OFF-HIGHWAY VEHICLES:** Power shovel wheel drums
- **INDUSTRIAL:** Overhead cranes, hoists, and power tools

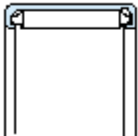
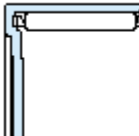
Drawn cup needle roller bearings			
With open ends		With closed end	
			
Full complement type	BM	Full complement type	MM
With cage	BTM, BHT	With cage	MKM, MHK
	M		M

SECTION 1 - Bearing Basics

THRUST BEARING DESIGNS, FEATURES, AND APPLICATIONS

BALL THRUST BEARINGS

FEATURES OF BALL THRUST BEARINGS

- Consists of row of balls running between two grooved washer rings
- The smaller bore ring is referred to as the shaft washer while the larger bore ring is called the housing washer
- The ring faces are always mounted parallel to the shaft center line
- The housing washer is made with either a flat or spherical back face
- Thrust bearings with spherical faces and washers are self-aligning to compensate for mounting errors
- Cages can be pressed steel , copper alloy, and a synthetic resin molded or machined resin cage

MAIN APPLICATIONS

Automobile steering pivots and machine tool spindles

CYLINDRICAL THRUST BEARINGS

FEATURES OF CYLINDRICAL THRUST BEARINGS

- Uses crowned cylindrical rollers running between flat shaft and housing ring washers
- Very high axial load capacity and rigidity
- Accommodates axial load in one direction only
- Cage is a machined copper alloy material or pressed steel.

MAIN APPLICATIONS

- Oil excavator swivels and steel crane hooks

NEEDLE THRUST BEARINGS

FEATURES OF NEEDLE THRUST BEARINGS

- Available in a separable or non-separable design
- The separable style consists of separate washers and a needle roller and cage assembly
- The non-separable consists of precision pressed washers and needle roller cage assembly
- Axial load can be handled in one direction only
- Small cross section area allows use in limited space applications
- Can be used without washer rings when the heat treated and ground mounting surfaces are used as raceways
- Pressed steel cages are used on the separable style while molded resin cages are used for the non-separable design

MAIN APPLICATIONS

- Automobile transmissions, cultivators and machine tools

With flat back faces



51100, 51200, 51300
51400

With spherical back face



53200, 53300, 53400

With aligning seat washer

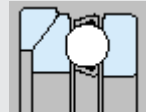

53200U, 53300U,
53400U



Since the discovery of the use of wooden balls supporting a rotating platform on a sunken Roman ship, thrust rolling element bearings have been used in applications ranging from bar stools to high precision machine tool spindles and tables.

SECTION 1 - Bearing Basics

TAPERED THRUST BEARINGS

FEATURES OF TAPERED THRUST BEARINGS

- This thrust bearing design uses tapered rollers with spherical large ends precisely guided by ribbed shaft and housing washer rings
- Both the shaft and housing washers have tapered raceways whose apexes along with the rollers, converge on a point on the bearing axis
- This bearing has a very high thrust load capacity
- Single direction thrust load designs are normally used, but double direction designs are possible
- Cage material is normally a machined copper alloy

MAIN APPLICATIONS

- Crane hooks, crushers, oil excavator swivels, and rolling mill screw down equipment

SPHERICAL THRUST BEARINGS

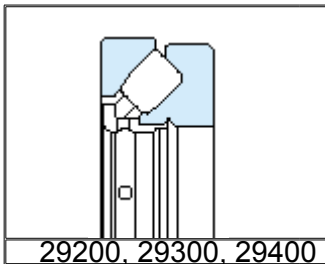

FEATURES OF SPHERICAL THRUST BEARINGS

- This bearing uses spherical convex rollers arranged at an angle to the axis of the bearing
- Due to the rollers and spherical raceways on the washers, some shaft misalignment can be tolerated.
- This bearing can support radial load up to 55% of the axial load being carried
- Spherical thrust bearings are not suitable for high speed operation
- The cage is a machined copper alloy

MAIN APPLICATIONS

- Vertical motors, deep well pumps, ship propeller shafts, jib cranes, screw down reducers, and hydroelectric generators

SECTION 1 - Bearing Basics

SPECIALITY BEARING DESIGNS AND FEATURES



MINIATURE BALL BEARINGS

Miniature and extra-small ball bearings are available as open and sealed deep groove types as well as those with outer ring flanges and locating snap rings. Also, recent application requirements have led to the development of ceramic miniature ball bearings and those with a resin flange which are 10% lighter than the conventional flanged bearing.

These miniature bearings are provided in metric and inch series dimensions. The metric bearings range in size from 1mm bore with a 3mmOD to a 9mm bore with a 17mm OD at the large end. The inch series range from the smallest at .04" bore with a .125" OD, to a .375" bore with a .875" OD.

HUB UNITS

Technology trends in the automotive industry have been towards improving safety, reliability, and energy savings of all vehicle components including bearing units. Wheel bearing designs have evolved from using two single row tapered rollers or deep groove ball bearings, to hub units where the mating parts such as the wheel hub and shaft have been combined into one unit with the bearings.

For over twenty years Koyo has developed advanced hub units for the automotive industry. The designs and units produced have included the latest ABS sensor technology to prevent wheels from locking when the brakes are applied suddenly. These Hub Units are now used by almost all automobile manufactures.

In addition to the previously covered bearing types, the **KOYO JTEKT GROUP** offers many different specialized bearing designs. These bearings have been designed for special application requirements and extreme operating conditions that cannot be accommodated by using standard production bearings and materials. The following bearing types are some of those products and design features they offer.



SECTION 1 - Bearing Basics

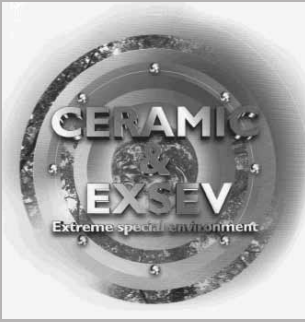

The Koyo EXSEV bearing series was developed for use in extreme applications where conventional bearings are not practical. The EXSEV bearing's components are made from special materials and use special lubricants. They are designed for use in environments such as clean rooms, in a vacuum, extreme temperature, corrosive conditions, to be non-magnetic or insulating, and to have high speed characteristics.

The EXSEV bearing series includes the following bearing types and a brief description of their special design features. For additional details and reference materials please contact KOYO.

EXSEV AND CERAMIC BEARINGS

- 1. THE CLEAN PRO BEARING** – Uses martensitic stainless steel balls and rings, austenitic stainless cage and shield with all components lubricated with a fluoropolymer coating. Suitable for clean and vacuum applications up to 200° C (380° F).
- 2. HIGH TEMPERATURE CLEAN PRO BEARING** – Uses a fluoropolymer coating on its rolling surfaces for lubrication. Suitable for clean and vacuum applications with high temperatures to 260° C (500° F).
- 3. CLEAN PRO PRA BEARING** – A fluoropolymer gel coating on the rolling surfaces is used as a lubricant. For use when temperatures are below 120 C, will give greater life than the CLEAN PRO.
- 4. DL BEARING** – In addition to martensitic stainless steel rings and balls and austenitic stainless steel cage and shield, this bearing is lubricated by packing it with a fluorinated KDL grease suitable for clean and vacuum environments. Will operate at higher speeds than the CLEAN PRO bearings.
- 5. PN BEARING** – This bearing includes martensitic stainless steel rings and balls, austenitic stainless steel shield a peek resin cage, and molybdenum disulfide a high heat resistant solid lubricant. Suitable for vacuum environments and operating temperatures as high as 300° C (560° F).
- 6. WS BEARING** – Uses martensitic stainless steel rings and balls, austenitic stainless steel shield, and separators made of a sintered composite material including tungsten disulfide for lubrication. Good for use in vacuum conditions and temperatures as high as 350° C (650° F).
- 7. MO BEARING** – In addition to martensitic stainless steel rings and balls, austenitic stainless steel shield and cage, molybdenum disulfide is baked on the cage surface for lubrication. Lubricant life is comparable to PTFE coating in life but has superior heat resistance.
- 8. MG BEARING** – This bearing has silver ion plated on the stainless steel balls as a lubricant. Will operate in ultra-high vacuums and temperatures as high as 500° C (930° F).

SECTION 1 - Bearing Basics

EXSEV AND CERAMIC BEARINGS

9. HIGH TEMPERATURE HYBRID CERAMIC BEARING – Inner and outer rings are a high speed tool steel, balls are Ceramic, cage is graphite which provides lubrication. This is intended for high temperature operation only 500° C (930° F)

10. FULL COMPLEMENT CERAMIC BALL BEARING – The rings and balls of this bearing are ceramic for ultra high temperatures operation. No cage is provided. In addition to extreme temperature resistance, it is suitable for magnetic fields, vacuums, and corrosive environments. 800°C (1470° F)

11. SK BEARING – Stainless steel rings, balls, cage, and shield are used. Bearing is packed with a lithium KHD grease for lubrication. It is suitable for corrosive environments and can operate at speeds comparable to conventional bearings.

12. CORROSION RESISTANCE HYBRID CERAMIC BEARING – The rings and shield are a corrosion resistance stainless steel, the balls are ceramic, and a fluorocarbon cage is used. The bearing is good for clean, vacuums, and underwater corrosive environments.

13. CERAMIC BEARING – This bearing has components made of silicon nitride ceramic and uses a fluorocarbon cage. It is typically used in vacuums and corrosive environments and where magnetic fields are present.

14. HIGH CORROSION RESISTANCE CERAMIC BEARING
– Uses corrosion resistant ceramic material components with a fluorocarbon cage which is resistant to strong acids and alkalis. Also good for clean, vacuums, and magnetic field environments.

15. NON-MAGNETIC HYBRID CERAMIC BEARING – This bearing uses non-magnetic stainless steel rings, ceramic balls, and a fluorocarbon cage. Intended for clean, vacuums, and magnetic field environments.

16. HYBRID CERAMIC BEARING – Uses high carbon chromium bearing steel rings, ceramic balls, and standard ball bearing cage. Lubricated with grease or oil, it can be used as an insulating bearing or for high speed operation.

“K” SERIES THIN SECTION BALL BEARINGS

Light and more compact modern machines and equipment are being used in every field of industry to save energy and materials. However, in many cases the size of shaft diameters cannot be reduced because of application requirements for specific strength levels, rigidity, and dampening characteristics.

Consequently, Thin Section Ball Bearings with their reduced outside diameters and bores that have not been changed will provide the small cross sections required.

Koyo offers three different types of “K” series thin section ball bearings; deep groove, angular contact, and four-point contact designs. Also available are EXSEV type, for use in extreme special environments. These bearings are sized according to nine different cross sectional areas. The bearings of the same dimension series have equal cross sectional areas regardless of bore size. The bores are classified into 6 groups from 1 to 12 inches (25.4 to 304.8mm).



SECTION 1 - Bearing Basics

STEEL MILL BEARINGS

Manufacturing companies throughout the world are increasingly finding it necessary to reduce energy and labor costs, along with being environmentally friendly and improving efficiency. Steel manufacturers in particular are looking for means to address these issues. Bearings are the anti-friction component of a piece of equipment, and an important means for reducing energy consumption and providing reliable operation. Consequently, having the properly designed bearing for a demanding steel making operation is a critical decision.

Koyo offers a number of different bearing products designed specifically for steelmaking applications. Listed below are a few of these bearing designs and their intended applications:

FOUR ROW CYLINDRICAL ROLLER BEARINGS – These large sized bearings support the backup roll of rolling mills. Suitable for high speed and high loads. The cylindrical assemblies also allow the inner ring raceway and roll to be finished ground simultaneously with the ring mounted on the roll neck to improve running accuracy of the roll.

FOUR ROW TAPERED ROLLER BEARING – These bearings have a high radial and axial load rating and are designed for work rolls and intermediate roll necks of rolling mills. They are supplied as a pre-adjusted matched spacer assembly. They can also be provided as a sealed unit eliminating the need for additional machining and parts assembly.

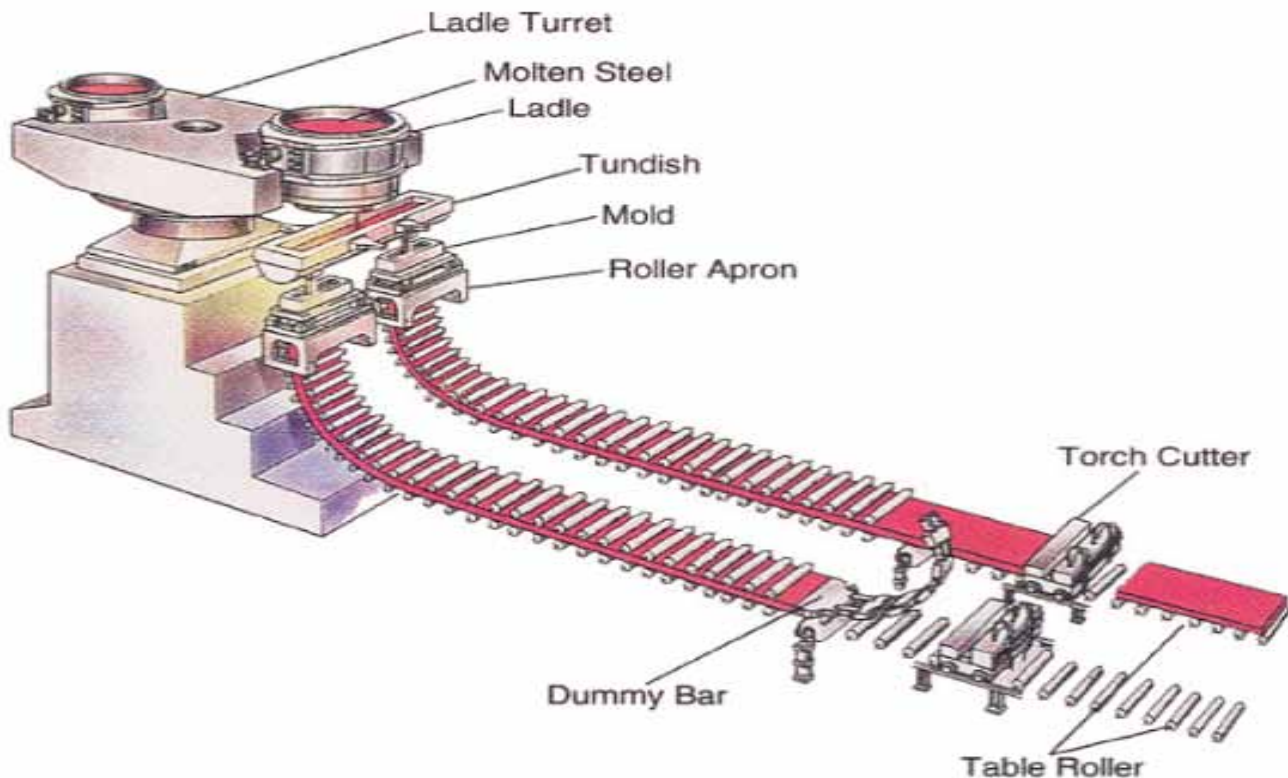
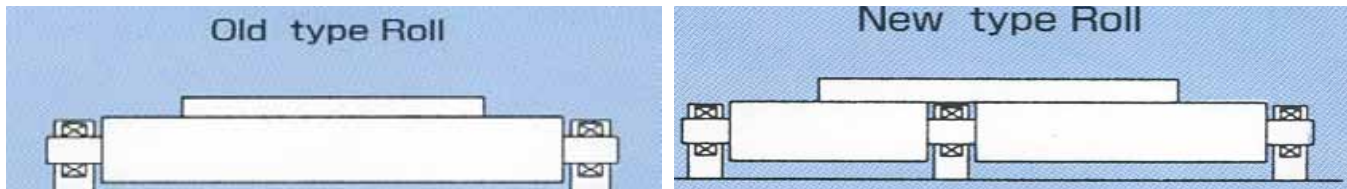

SECTION 1 - Bearing Basics

STEEL MILL BEARINGS... *cont'd*

HSC BEARING UNITS – Support the driving rolls of a continuous casting machine at the middle position. These bearings are used under heavy loads and very slow speeds along with operating where they are exposed to water and steel slab scales. To operate under these conditions, these bearings use a full compliment of cylindrical rollers, a split housing design with self-aligning capability to handle the deflections and expansion and contraction of the roll.

SC & SCP BEARINGS – SC bearings support continuous casting rolls at the float side while SCP bearings use ribs on the inner ring to accommodate axial loads and are used at fixed position. These bearings also use a full complement of cylindrical rollers with a self-aligning outer ring to accommodate the loading and misalignment.

BACKUP ROLL UNITS – These units are completely sealed utilizing cylindrical rollers with large O.D. outer rings used as backup rolls. They are typically used on plate and tension levelers. They can be custom made using optimal roll material and seal design for the required operating conditions.

TAPERED BEARING



HSC BEARING UNIT

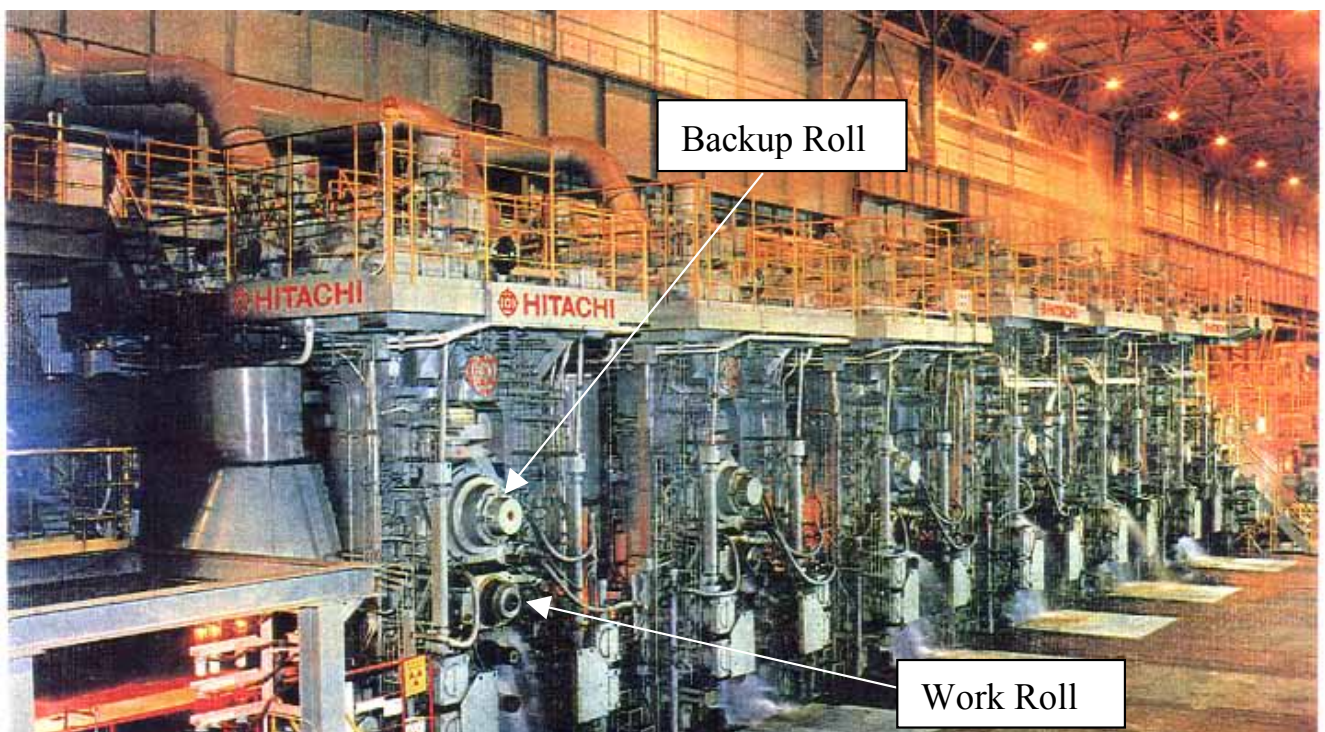

SECTION 1 - Bearing Basics

STEEL MILL BEARINGS... *cont'd*



CYLINDRICAL ROLLER BEARINGS FOR BACKING SHAFTS – These Cylindrical Roller Bearings are designed for the backing shafts of Z-Mills and other multi-roll mills. These bearings maintain contact with the intermediate rolls supporting the roll loads. The outer rings are made of special material and are heat treated to ensure surface hardness and impact resistance for reliability.

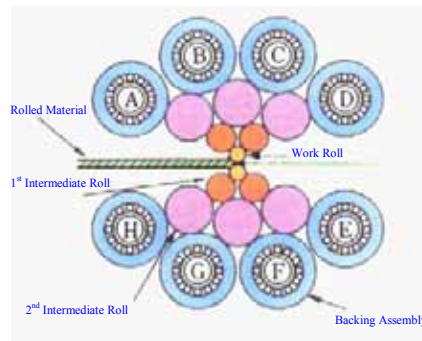
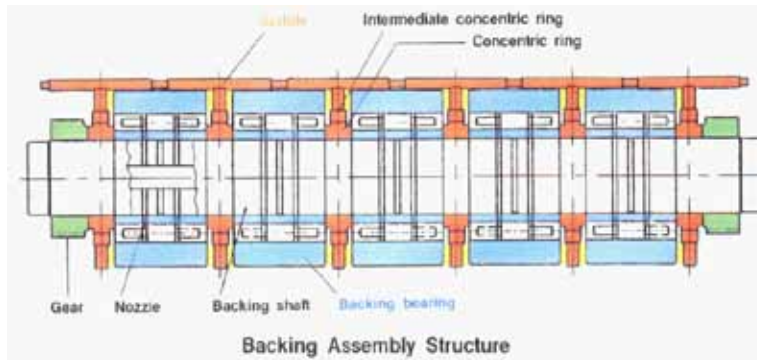

SLEWING RIM BEARINGS



Slewing Rim Bearings are designed to carry both axial and radial loading in addition to being able to handle moment and overturning loading. These bearings are used in applications for support of large rotating and pivoting units used in construction equipment such as power shovels, track cranes and loaders. They are also popular in applications like machine tool tables and wind turbines.

These bearings are available in various configurations which include four point balls, a double direction angular contact ball, cylindrical rollers positioned at right angles (cross roller design), and a triple cylindrical roller design for higher rigidity and load capacity. The angular contact ball and right angle cylindrical roller designs are available with an internal or external gear, while the four-point contact ball and triple cylindrical are available with gears or not.

SECTION 1 - Bearing Basics

NOTES

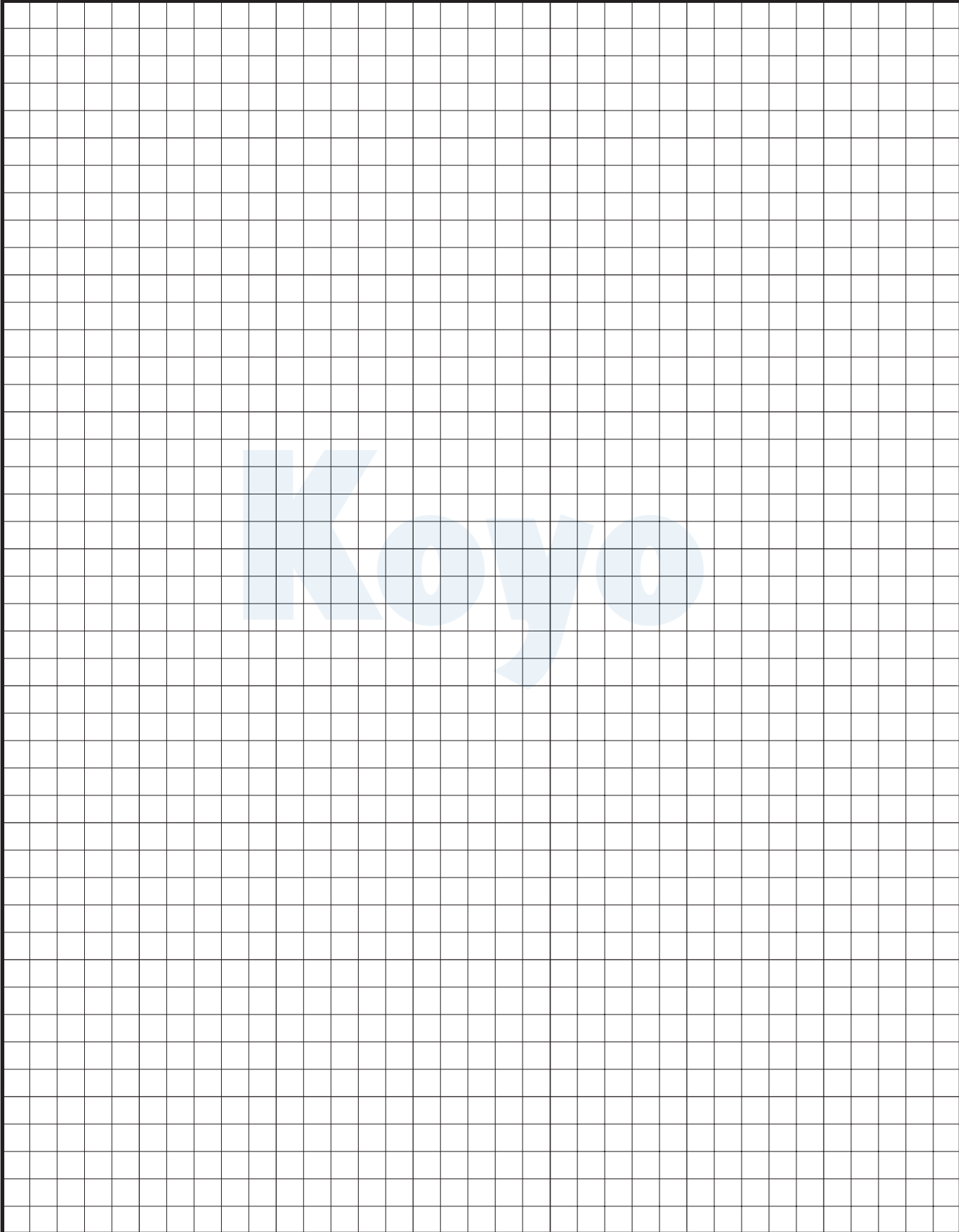

SECTION 1 - Bearing Basics

BALL BEARING PART NUMBERING AND NOMENCLATURE

PREFIX		BEARING SERIESCODE		BORE DIA. #		CONTACT ANGLE		INTERNAL DESIGN		SEAL/ SHIELD	
3NC		62		02						2RD	
		52		04						ZZ	
		72		10		B		G			
PREFIX		BEARING SERIESCODE		Bore Dia. #		Contact Angle		Internal Design		SEAL / SHIELD	
3NC	Silicon Nitride (Ceramic) balls	68, 69, 160, 60, 62, 63, 64	Single-row deep groove ball bearing	00	10 mm bore	A (omitted)	30 degrees	R	High capacity ball design	RS	RS type contact rubber seal
		42, 43	Double-row deep groove ball bearing	01	12 mm bore	B	40 degrees	G	Flush ground bearings	RD	RD type extremely light contact rubber seal
		79, 70, 72, 73, 74	Single-row angular contact ball bearing	02	15 mm bore	C	15 degrees			RDT	RD type extremely light contact rubber seal for large ball bearings
		32, 33	Double-row angular contact ball bearing (w/ filling slot - can not be sealed)	03	17 mm bore			PA	Outer ring guided retainer	RU	RU type non-contact rubber seal
		52, 53	Double-row angular contact ball bearing	04 ~ 96	Bore diameter in mm can be found by multiplying the 'Bore Dia. #' by 5 (i.e. 05=5*5=25 mm)			-5	Ball guided retainer	RK	RK sype double lip contact rubber seal
		511, 512, 513, 514, 532, 533, 534, 522, 523, 524, 542, 543, & 544	Thrust ball bearing								ZZ
		12, 22, 13, 23, 112, 113	Self-aligning ball bearing	/500	500 mm bore					ZZX	Removable metal shield
									Fixed metal shield		
									Removable metal shield		

SECTION 1 - Bearing Basics

BALL BEARING PART NUMBERING AND NOMENCLATURE... *Cont'd*

RING SHAPE		MATERIAL / SPECIAL TREATMENT		MATCHED PAIR		CLEARANCE / PRELOAD	
NR		ST				C3	
		SH					
		S1		DB		L	
Ring Shape		Material		Matched Pair		Clearance/Preload	
N	Snap ring groove	Blank	SUJ2	DB	Back to back arrangement	C2 CD2	Smaller than standard radial internal clearance
NR	Snap ring groove and snap ring	ST	Inner ring, outer ring and balls made from SUS440C	DF	Face to face arrangement	BLANK	Standard clearance
W33	Lubrication groove with oil holes	ST4	Inner ring and outer ring made from SUS440C	DT	Tandem arrangement	CM	Electric motor RIC (European standard)
K	Inner ring tapered bore (1:12 ratio)	SH2	Carbonitriding heat treatment on inner ring	X2	Set of 2 angular contact bearings (always with flush ground designs)	C3 CD3	Larger than standard RIC
		S0	Bearings dimensionally stabilized to 150C (302° F)			M1 M2 M3 M4 M5 & M6	Clearances for Miniature/ Small ball bearings
		S1	Bearings dimensionally stabilized to 200C (392° F)			C4	Larger than C3 RIC
		S2	Bearings dimensionally stabilized to 250C (482° F)			S	Slight preload
						L	Light preload
						M	Medium preload
						H	Heavy preload

RETAINER	PRECISION	NOISE		PARTS	GREASE				
//	P5	/		00	SR				
FG	P6	/		00	XM				
FT	P4	S		00					
Cage Material	Precision Grade	NOISE		PARTS	GREASE				
//	Pressed steel cage	P0	Standard BB precision (ABEC 1)	/	Standard noise specification	00	Complete bearing	XM	Exxon Polyrex EM
FG	Fiberglass reinforced molded polyamide (Nylon 6,6) cage	P6	Better than standard BB Precision (ABEC 3)	S	Super motor quality (ball bearings)			SR	Multemp SRL
FT	Machined phenolic cage	P5	Better than standard BB Precision (ABEC 5)	U	Noise quality for machine tool bearings			CR	Chevron SRI # 2
FY	Machined bronze cage	P4	Better than standard BB Precision (ABEC 7)					A2	Alvania #2
YS	Pressed Stainless Steel Cage	PZ	Non Standard tolerances					B5	Beacon 325
MG	Fiberglass reinforced molded polyamide (Nylon 6,6) cage								

SECTION 1 - Bearing Basics

ROLLER BEARING PART NUMBERING AND NOMENCLATURE

Prefix		BEARING SERIES CODE		BORE DIA. #		CONTACT ANGLE		INTERNAL DESIGN		RING SHAPE	
KE		322		05		J		R			
		NU2		10				R			
		222		15				RHR		W33	
		294		30				R			
Prefix		BEARING SERIES CODE		Bore Dia. #		Contact Angle		Internal Design		Ring Shape	
KE	Carbonitriding heat treatment (for case hardened steels)	NU10, 2, 22, 32, 3, 23, 4	Single-row cylindrical roller bearing	00	10 mm bore	C	20° contact angle for metric TRB	R	High capacity roller design	N	Snap ring groove
		NNU49, NN30	Double-row CRB	01	12 mm bore	D	28° 30' contact angle for metric TRB	R & RR (SRB)	Asymmetrical rollers and machined bronze cage	NR	Snap ring groove and snap ring
		239, 230, 240, 231, 241, 222, 232, 213, 223	Spherical roller bearing	02	15 mm bore	DJ	28° 48' 39" contact angle for metric TRB	RH & RHR (SRB)	Symmetrical rollers and pressed cage	W33	Lubrication groove with oil holes
		292, 293, 294	Spherical thrust roller bearing	03	17 mm bore	J	TRB cup width, contact angle and cup small inside diameter conform to ISO standards (standard for metric TRB)	RHA (SRB)	Symmetrical rollers and 1-piece machined bronze cage	W502	W33 + special OD tolerance for shaker screens
		BE, BEU, R, RE, RS, V, VEU, VS, VP, VPS, VU W/R, WRS, WV, UR	Needle roller bearing (cage and roller assembly)	04 ~ 96	Bore diameter in mm can be found by multiplying the 'Bore Dia. #' by 5 (i.e. 05=5*5=25 mm)			ROVS	Asymmetrical rollers, and outer ring guided machined bronze cage for shaker screens	K	Tapered inner ring bore (12:1)
		BM, BHM, B, BH, Y, YM, M, MH, MM, BTM, BHTM, BT, BHT, MKM, MHKM, MK MHK	Drawn cup needle roller bearing	/500	500 mm bore					K30	Tapered inner ring bore (30:1)
		NA49, NA59, NA69, RNA49, RNA59, RNA69, NQ, NQS, NQI, NQIS	Machined needle roller bearing								
		329, 320, 330, 331, 302, 322, 332, 303, 313, 323	Metric Tapered roller bearing								

SECTION 1 - Bearing Basics

ROLLER BEARING PART NUMBERING AND NOMENCLATURE... *cont'd*

MATERIAL / SPECIAL TREATMENT		CLEARANCE / PRELOAD		RETAINER		PRECISION		NOISE		PARTS		GREASE
				//		P0		/		00		
S0				FY		P0		/		00		
		C4		FY		P0		/		00		
				FY		P0		/		00		
Material		Clearance/ Preload		Cage Material		Precision		NOISE		Parts		GREASE
Blank	SUJ2	C2	Smaller than standard radial internal clearance	//	Pressedsteelcage	P0	StandardRB precision (ABEC 1)	((omitted))	Standard noise specification	00	Completebearing	N/A
SH	Carbonitriding heat treatment (for through hardened steels)	BLANK	Standard clearance	FY	Machined bronze cage	P6	Better than standard RBPrecision (ABEC 3)	N	Super motor quality (roller bearings)	01	Inner ring assembly (IR, cage and rollers)	
SH2	SH treatment on inner ring only (for through hardened steels)	C3	Larger than standard clearance	YP	Pressedbrasscage	P5	Better than standard RBPrecision (ABEC 5)			02	Outer ring assembly	
S0	Bearings dimensionally stabilized to 150C	C4	Larger than C3 clearance			P4	Better than standard RBPrecision (ABEC 7)			03	Cageand roller assembly	
S1	Bearings dimensionally stabilized to 200C									21	Outer ring /Cup	
S2	Bearings dimensionally stabilized to 250C											

SECTION 1 - Bearing Basics

TAPERED ROLLER BEARING PART NUMBERING AND NOMENCLATURE

PREFIX		DUTY		ANGULARITY		BASIC SERIES		PART #		SUFFIX		PART #	
HI-CAP		L		4		46		49		R			
HI-CAP		L		4		46						10	
		HH		2		283		49				/10	
KE		HM		8		86		49					
Prefix		Duty		Angularity*		Basic Series		Part #		Suffix		Part #	
KE	Carbonitriding heat treatment (for case hardened steels)	EL	Extra-Light series	1	$0^\circ < \alpha \leq 24^\circ$	00 to 19	d* 1"	30 - 49	Cone	R	High capacity roller design	/	Cup and cone assembly
HI-CAP	TRB made from case carburized steel	LL	Light-Light series	2	$24^\circ < \alpha \leq 25^\circ 50'$	20 to 99 000 to 029	$1" < d \leq 2"$			X	Special feature. Not interchangeable with standard non-X version	10~19	Cup
J	J series metric TRB	L	Light series	3	$25^\circ 50' < \alpha \leq 27^\circ$	039 to 129	$2" < d \leq 3"$			A	Special feature. Not interchangeable with standard non-A version		
		LM	Light-Medium series	4	$27^\circ < \alpha \leq 28^\circ 30'$	130 to 189	$3" < d \leq 4"$			S	Special feature. Not interchangeable with standard non-S version		
		M	Medium series	5	$28^\circ 30' < \alpha \leq 30^\circ 30'$	190 to 239	$4" < d \leq 5"$						
		HM	Heavy-Medium series	6	$30^\circ 30' < \alpha \leq 32^\circ 30'$	240 to 289	$5" < d \leq 6"$						
		H	Heavy series	7	$32^\circ 30' < \alpha \leq 36^\circ$	290 to 339	$6" < d \leq 7"$						
		HH	Heavy-Heavy series	8	$36^\circ < \alpha \leq 45^\circ$	340 to 389	$7" < d \leq 8"$						
		EH	Extra-Heavy series	9	$45^\circ < \alpha$ but not thrust	390 to 429	$8" < d \leq 9"$						
		T	Thrust only	0	Thrust bearing								

SECTION 1 - Bearing Basics

TAPERED ROLLER BEARING PART NUMBERING AND NOMENCLATURE... cont'd

SUFFIX		COMPLETE BASE P/N	RETAINER		PRECISION		NOISE		PARTS		GREASE
		HI-CAPL44649R	//		A4		/		01		
		HI-CAPL44610	//		A4		/		21		
		HH228349UR2/10UR	//		A4		/		00		
		KEHM88649	//		A2		/		01		
Suffix			RETAINER		PRECISION		NOISE		PARTS		GREASE
X	Special feature. Not interchangeable with standard non-Xversion		//	Pressed steel cage	A4	Standard class 4 inch series TRB tolerance	/	Standard noise specification	00	Complete bearing	N/A
A	Special feature. Not interchangeable with standard non-Aversion				A2	Better than standard inch TRB tolerance (class 2)	N	Super motor quality	01	Inner ring assembly (IR, cage and rollers)	
S	Special feature. Not interchangeable with standard non-Sversion				PK	Standard J series metric TRB tolerance			21	Cup	
					PN	Better than standard J series metric TRB tolerance					

SECTION 1 - Bearing Basics

BEARING PART NUMBERING AND NOMENCLATURE

SHIELD / SEAL/ SNAP RING CODES										
One Side	Both Sides	Description	Interchange							
			FAG	MRC	Nachi	NSK	NTN	SNR	SKF	Torrington/ Fafnir
Z	ZZ	Fixed Shield(s)	Z/ZZ	F/FF	Z/ZZ	Z/ZZ	Z/ZZ	Z/ZZ	Z/ZZ	D/DD
ZX	ZZX	Removable Shield(s)	N/A	L/LL	ZS/ZZS	ZS/ZZS	ZA/ZZA	N/A	N/A	N/A
RU	2RU	Non-contact Seal(s)	RSD/2RSD	N/A	NKE/2NKE	V/VV	LB/LLB	N/A	RZ/2RZ	PL/PPL
RS	2RS	Contact Seal(s)	RS/2RS	Z/ZZ	NSL/2NSL	DU/DDU	LU/LLU	E/EE	RS/2RS	P/PP
RK	2RK	Dbl lip Contact Seal(s)	N/A	N/A	N/A	N/A	LC/LLC	E10/EE10	N/A	Y/YY
RD	2RD	Extremely Light Contact Seal(s)	N/A	N/A	NSE/2NSE	N/A	LH/LLH	N/A	N/A	V/VV
RDT	2RDT	Same as 2RD - for Large Size Ball Bearings	N/A	N/A	NSE/2NSE	N/A	LH/LLH	N/A	N/A	V/VV
NR		Snap Ring on Outer Ring O.D.	NR	G	NR	NR	NR	NR	NR	G

TAPERED ROLLER BEARING INTERCHANGE						
TAPERED SET NO.	KOYO PART NUMBER		CR BEARING	BCA	L & S BEARING	TIMKEN
	CONE	CUP		FEDERAL MOGUL		
K1	LM11749	LM11710	BR1	A1	S1	SET 1
K2	LM11949	LM11910	BR2	A2	S2	SET 2
K3	M12649	M12610	BR3	A3	S3	SET 3
K4	L44649	L44610	BR4	A4	S4	SET 4
K5	LM48548	LM48510	BR5	A5	S5	SET 5
K6	LM67048	LM67010	BR6	A6	S6	SET 6
K12	LM12749	LM12710	BR12	A12	S12	SET 12
K13	L68149	L68110	BR13	A13	S13	SET 13
K14	L44643	L44610	BR14	A14	S14	SET 14
K15	L45449	L45410	BR15	A15	S15	SET 15
K16	LM12749	LM12711	BR16	A16	S16	SET 16
K17	L68149	L68111	BR17	A17	S17	SET 17
K18	JL69349	JL69310	BR18	A18	S18	SET 18
K29	LM67049A	LM67010	BR22	A29	S29	SET 22
K35	LM501349	LM501310	BR35	A35	S35	SET 35
K36	LM603049	LM603012	BR36	A36	S36	SET 36
K37	LM603049	LM603011	BR37	A37	S37	SET 37
K38	LM104949	LM104911	BR38	A38	S38	SET 38
K39	JL26749	JL26710	BR39	A39	S39	SET 39
K41	57410 LFT	LM29710	BR41	A41	S41	SET 41

SECTION 1 - Bearing Basics

NOTES

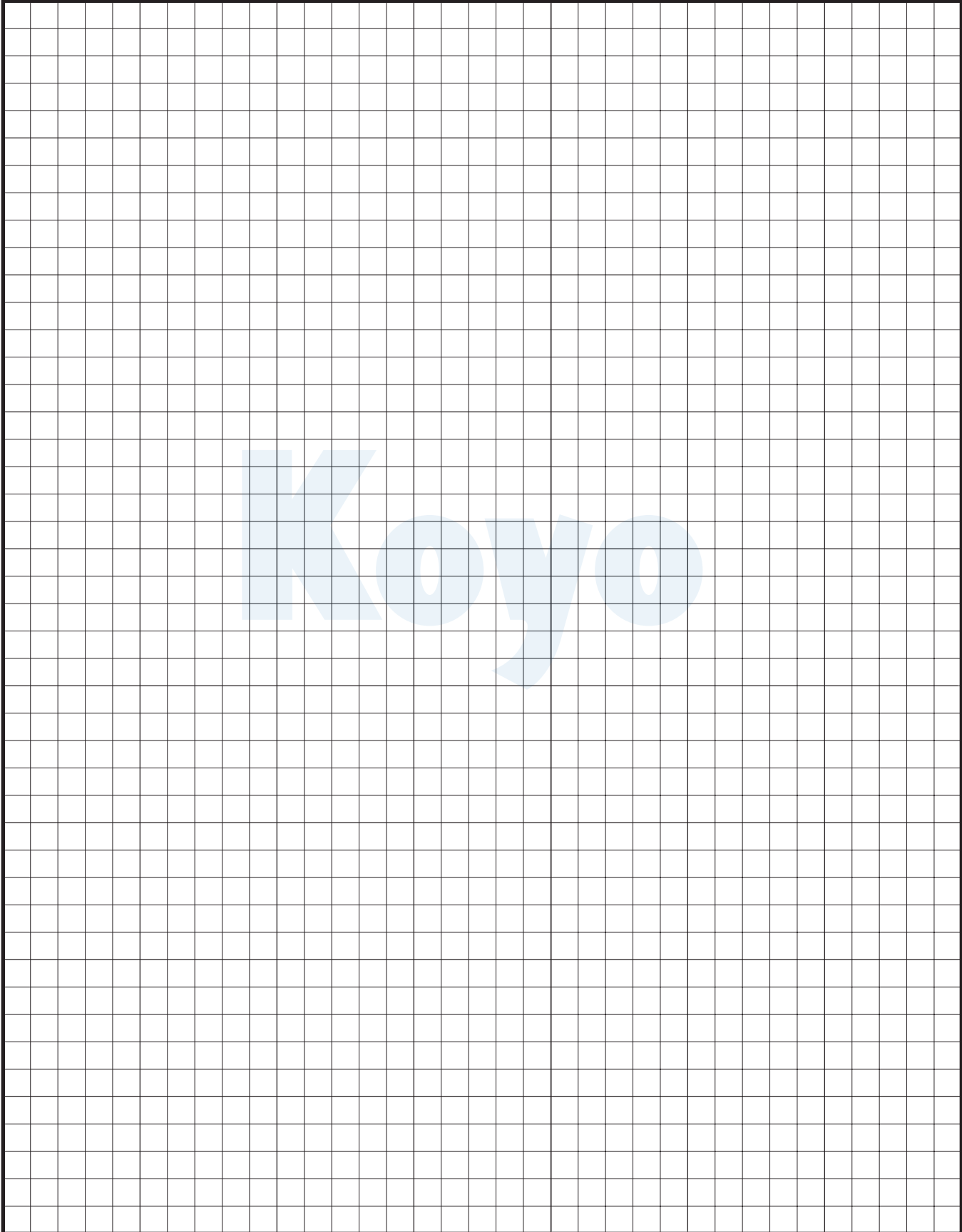

SECTION 2 - Materials & Manufacturing

Bearing rings and rolling elements are subjected to load stresses in a very small point and line contact area. Consequently, material characteristics such as hardness, yield strength, wear and abrasion resistance, and rolling fatigue are necessary for successful bearing operation.

MATERIAL CHARACTERISTICS OF BEARING COMPONENTS

BEARING RINGS AND ROLLING ELEMENTS

THROUGH - HARDENED STEELS

Generally high carbon chromium bearing steels such as JIS designation SUJ2, SUJ3, or SUJ5 are used for bearing rings and rolling elements, and is equivalent to SAE52100 steel. SUJ2 steel is the most commonly used for bearing components. SUJ3 has more manganese and better tempering characteristics than SUJ 2, making it a better selection for medium and large size bearings. SUJ5 is made by adding molybdenum to SUJ3 further increasing tempering ability making it well suited for thick sectioned and very large bearing components. These steels are normally selected for use in the heat treatment process for obtaining a through hardened product with a hardness level in the 58 to 64 Rockwell C range

CASE CARBURIZED STEEL

For those applications requiring bearings with better resistance to shock loading and rapid temperature changes, carburizing steels are used. With these steels a carbon rich atmosphere is precisely controlled through the required time and temperature cycles. After quenching and tempering the metallurgical transformation is similar to the through hardened steels, however the result is a core lower in carbon and hardness. The outer case is carburized to a full hardness level of 58 to 62 Rockwell C, while the core is a softer more ductile 40 to 45 Rockwell. The case depth does vary according to heat treatment and component size and normally ranges from .02" to .125".

SPECIALITY STEELS

In the Specialty Bearing section of this booklet, reference was made to some of the materials used in these products to obtain successful performance in extreme and demanding application environments. The following are some of the special steels designations used in KOYO

EXSEV bearings and their characteristics:

MARTENSITIC STAINLESS STEEL – SUS440C 60 HRC Hardness – Used in clean and vacuum environments

PRECIPITATION HARDENED (AUSTENITIC) STAINLESS STEEL – SUS630, 40 HRC Hardness – Corrosive environments

HIGH SPEED TOOL STEEL – M50,61 HRC Hardness – High temperature environments

HIGH SPEED TOOL STEEL – SKH4, 64 HRC Hardness – High temperature environments

NON-MAGNETIC STAINLESS STEEL – 43 HRC HARDNESS – Magnetic field environments

SECTION 2 - Materials & Manufacturing

CERAMIC BEARING MATERIALS

Ceramic bearings components have some special properties that steel bearings do not, such as being non-magnetic and having insulating abilities. Also, ceramic materials are desirable for their heat resistant properties, plus their low density reduces weight and decreases centrifugal forces induced by the rolling elements making them a good choice for high speed bearing operation.

KOYO ceramic bearings are either Full Ceramic bearings (all components) or Hybrid Ceramic (only the rolling elements are ceramic). On the Hybrid Ceramic bearings the inner and outer rings are made from high carbon chromium steel, while the cage may be a metal, resin, or composite material depending on the operating conditions. Although KOYO uses silicon nitride as the standard ceramic material, there are a couple of additional ceramic materials that can be used. The following are the available ceramic materials and their characteristics:

SILICON NITRIDE – Si₃N₄ – Comparable to bearing steel in load capacity plus has good high speed, heat resistance, and high vacuum capabilities

CORROSION RESISTANT Si₃N₄ - Uses a different binder material to improve corrosion resistance without sacrificing performance.

ZIRCONIA – ZrO₂ – Good for light load applications and is ideally suited for highly corrosive chemicals

SILICON CARBIDE – SiC – Good for light loads, highly corrosive chemicals and high temperature operation

Utilized Example	Application Example
High Speed	Machine tool main spindle, turbo charger, gas turbine, centrifuge, spindle motor, dental hand-piece, polygonal mirror scanning motor, twine spindle
High Corrosion Resistance	Semiconductor equipment, plating equipment, composite fiber equipment, optical film equipment, drug equipment.
High Vacuum	Semiconductor equipment, vacuum apparatus, stepping motor.
Heat Resistance	Heat treatment furnace, heat roller, medical supplies equipment, chemical fiber instruments.
Non-magnetism	Semiconductor equipment, superconduction equipment, atomic power installation.
Lightness	Crankshaft of racing motorcycle, space appliance, aircraft engine.
High Rigidity	Machine tool main spindle
Insulation	Plating equipment, tractor motor, motor.

FEATURES

HIGH SPEED

Centrifugal force reduction due to light ball or roller.

HIGH CORROSION RESISTANCE

Can be used under special conditions such as in acid, alkali, salt water, etc.

HIGH VACUUM

High seizure resistance with solid lubricant

HEAT RESISTANCE

No hardness and strength reduction under high temperature.

NON-MAGNETISM

Can be used in magnetic fields

LIGHTNESS

Density is 40% of bearing steel's.

SMALL DIMENSION CHANGE BY TEMPERATURE

Low coefficient of linear thermal expansion

HIGH RIGIDITY

Higher hardness and longitudinal elasticity modulus greater than bearing steel.

INSULATION

Deterioration caused by electric arcing can be prevented

SECTION 2 - Materials & Manufacturing



The cages of rolling element bearings must be able maintain proper spacing of the rolling elements, have the strength to withstand centrifugal and shock forces and be able to tolerate temperature and lubricant variations.

STAMPED CAGES

There are several different types of cages, and various materials used in cage construction. Stamped one or two piece cages are normally made from steel, stainless steel, or bronze. Since stamped metal cages allow the use of more and larger rolling elements than the other cage types they are the most widely used for rolling element retention.

MACHINED CAGES

Machined one or two piece cages are made from steel, bronze, aluminum, or phenolic resins. Machined cages are normally used to reduce unbalance and wear in high speed operation. They are also normally used in large bearings and where higher operating temperatures are expected.

RIVETED CAGES

Two pieces stamped cage halves are normally riveted together. Riveting cage halves together produces a very strong connection. Riveted cages are normally manufactured from steel, a lower cost material; however, for higher speed operation bronze is a better selection.

MOLDED CAGES

Materials typically used for injection molded cages are polyacetal and polyamide (Nylon 6.6, Nylon 4.6) and polymer containing fluorine which are strengthened with glass and carbon. These materials have been used successfully in bearings for those applications requiring characteristics difficult for steel and other metal alloy cage materials. Nylon cages have very low operating torque making them a good selection for high speed operation. They also have good misalignment capability making them less susceptible to torsional and bending stresses.

SECTION 2 - Materials & Manufacturing

BEARING MANUFACTURING PROCESS

RING FORGINGS – The process starts after the reception of alloy steel bar stock which is hot forged into inner and outer bearing rings

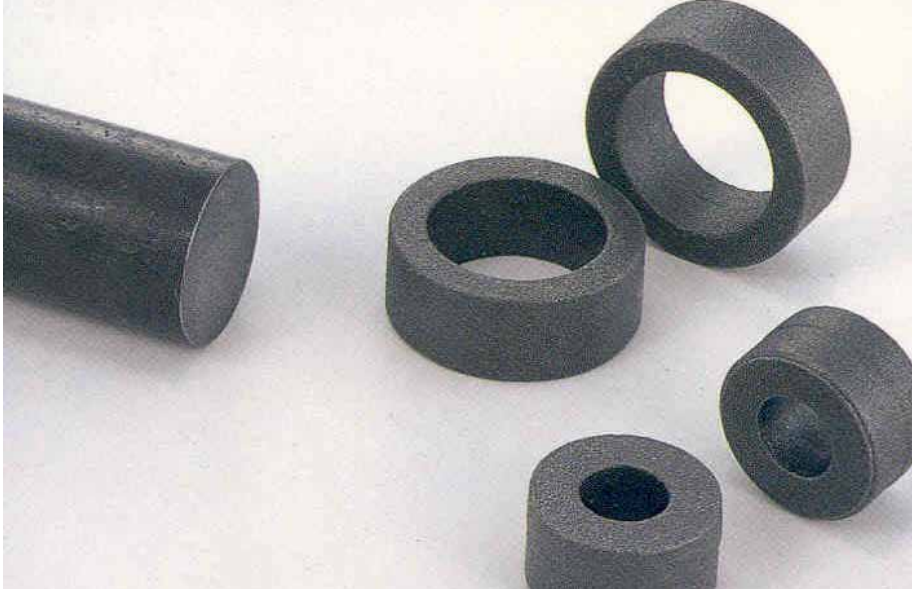

RING TURNING – The forged rings are then sent to CNC turning centers or multi-spindle chuckers to be turned and machined into the required part shape.



HEAT TREATMENT – Before the rings can be ground they need to be heat treated to provide the proper hardness, wear and fatigue resistance. At this stage the parts are either through hardened or case carburized to give the required Rockwell C level.

For a typical representation of the bearing manufacturing process, the processing flow for a ball bearing starting with the reception of steel bar stock and ending with a packaged bearing ready for shipment is covered here.

SECTION 2 - Materials & Manufacturing

SUPER FINISHING



Depending on part surface finish requirements, processes such as lapping, honing, and coating applications may be used to further reduce surface asperities to obtain finishes within several micro-inches.

BEARING MANUFACTURING PROCESS

GRINDING – Rings are face ground, O.D. & I.D. ground, and the raceways ground to give the finished part size and tolerances. Concentricity, roundness, and runout requirements are also checked at this time for class and precision requirements.

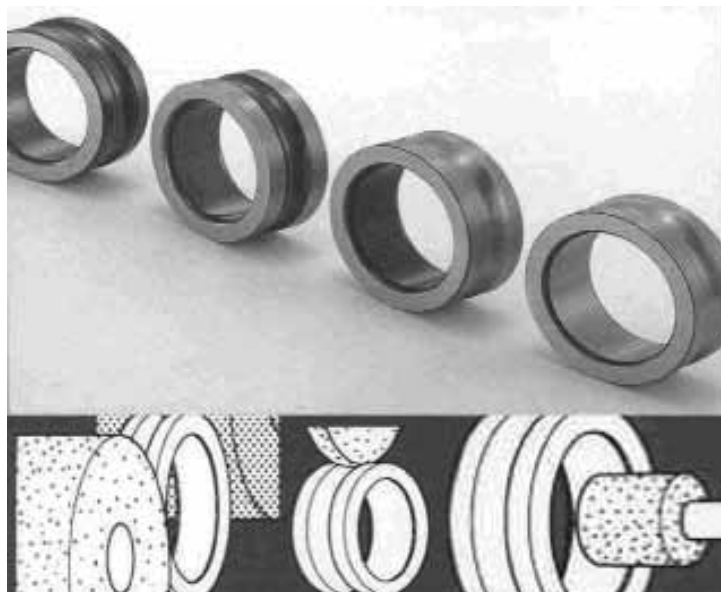

WASHING & INSPECTION – The rings are washed and cleaned in automatic ultrasonic units equipped with fine filtration to remove the smallest processing residue. After cleaning, parts are lab inspected to be sure they are free of defects and grinding burns.

SECTION 2 - Materials & Manufacturing

BEARING MANUFACTURING PROCESS

BALL FORMING – Balls 1 inch and under in diameter are formed from steel wire. The wire is sheared to size and pressed between concave dies. Balls larger than 1 inch are produced from bar stock and cut to the proper size and pressed between cold forming dies.

BALL FLASHING – After forming the balls have a raised center band of excess material. The excess material is normally removed by rough grinding before the balls can be processed further.

RILL FILING & TUMBLING – Before the balls are heat treated they are Rill filed to remove the rough surfaces and tumbled in high speed centrifugal barrels to yield a smooth and uniform surface.

HEAT TREATMENT – Heat treatment is performed to ensure the balls are hardened to the correct level from their centers to the surface.

BALL GRINDING – After being heat treated, the balls first go through another rough grinding before being finished ground to size and roundness.

BALL LAPPING – During the lapping procedure the ball stock removal is monitored closely while the balls are bathed by lapping compound. Lapping improves the surface finish and brings the balls within 25 millionths of inch of diameter.

WASHING & INSPECTION – After cleaning the balls are both visually and electronically scanned for defects.



SECTION 2 - Materials & Manufacturing



BEARING PACKAGING – The final step is to be sure the bearings are properly wrapped and boxed to assure they are protected until they are ready for assembly and operation.



BEARING MANUFACTURING PROCESS

CAGE STAMPING – Sheet steel is used in the stamping process to form blanks into round discs.



CAGE FORMING – The cages go through several press forming operations before they are in their finished shape. If rivets are to be used they are then punched with rivet holes.

CAGE DEBURRING & FINISHING – Cages are normally deburred and polished in rotating centrifugal barrels with a polishing compound.

RIVET INSERTION – For cages that have been hole punched, rivets are inserted before the cages are cleaned and inspected.



BEARING ASSEMBLY – The inner race is placed and offset inside the outer race to allow the balls to be inserted between them. The balls are then evenly distributed around the raceways for acceptance of the cage halves which are then riveted together. The assembled bearing is once again cleaned and inspected. The bearings that are to be greased and installed with shields or seals are processed before being sound tested and a final inspection. Otherwise the assembled bearing is sound tested before application of a rust preventative.

NOTES

A large grid area for taking notes, consisting of a 30x30 grid of small squares. A faint, light blue watermark of the word "Koyo" is centered across the grid.

SECTION 3 - The Bearing Selection Process

APPLICATION OPERATING CONDITION CONSIDERATIONS

In order to select the most appropriate bearing for an application, it is very important to understand the expected operating conditions of the bearing. The main bearing selection criteria will be covered in this section.

1. MOUNTING SPACE

When an application is designed, a primary consideration is for the shaft to have the proper strength and rigidity. Consequently, the minimum required shaft diameter is determined followed by a determination of the allowable housing size, weight, and material needs based on the application environment and loads. Once these shaft and housing size restrictions have been determined, the allowable bearing envelope dimensions can be specified.

2. LOADING

Load type, magnitude, and direction of loads are all key in determining the proper bearing for a particular application.

Knowing the type of loading, load combinations, and if shock loading is possible are important factors in bearing selection. The load types are normally described as being either pure radial (a load perpendicular to the shaft centerline), pure thrust (a load parallel to the shaft centerline), and moment or overturning load (a load offset from a bearing arrangement which causes an overturning motion).

If a bearing's load requirements are only to be able to carry a radial load, there are numerous ball, cylindrical roller, spherical roller, and tapered roller possibilities. However, if the application load requirements are for load carrying ability of all three types of loading, tapered roller bearings, a four-point contact ball, or possibly multiple rows of angular contact ball bearings may be the only options. Of course, when only pure thrust loading is involved, there are various types of thrust bearings that can be used.

The other aspect of bearing loading that needs to be considered when selecting bearings is the magnitude and direction of the loads. Questions such as: will a single row ball bearing, angular contact ball, cylindrical, or tapered bearing have the capacity needed for the radial and thrust loading involved? Additionally, is the thrust load only in one direction, or is it reversible and will multiple rows of bearings be needed to carry the loads?

To aid in the determination of the ability of a bearing to handle various types and magnitude of loading, reference can be made to the KOYO JTEKT Ball and Roller Bearing catalog #B201E for basic radial and thrust load ratings.

SECTION 3 - The Bearing Selection Process

2. LOADING ... *cont'd*

RADIAL LOAD

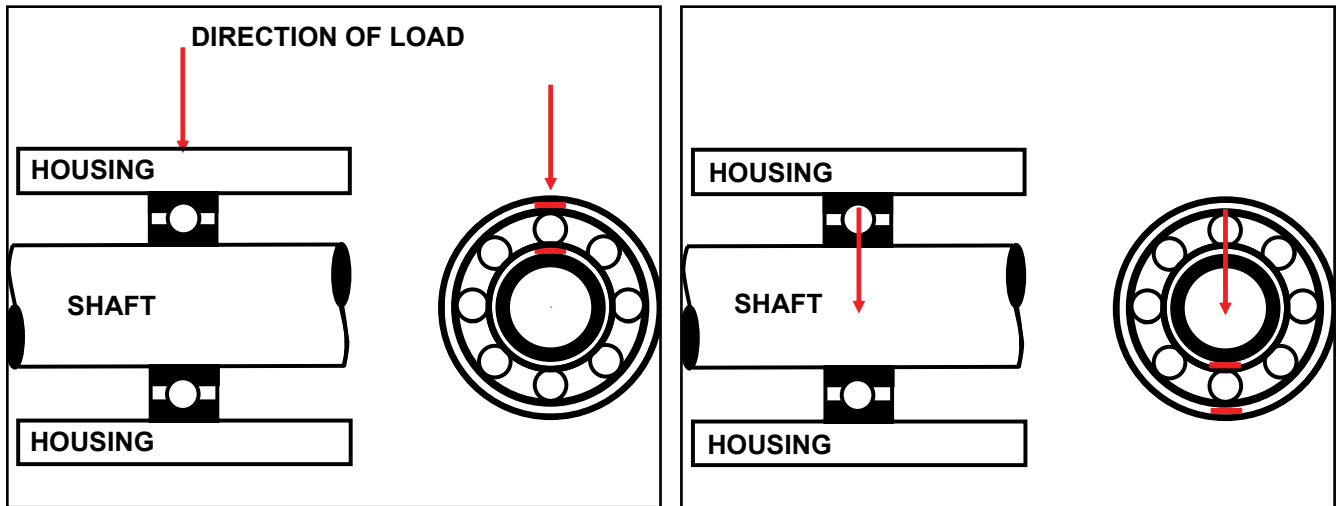

AXIAL LOAD

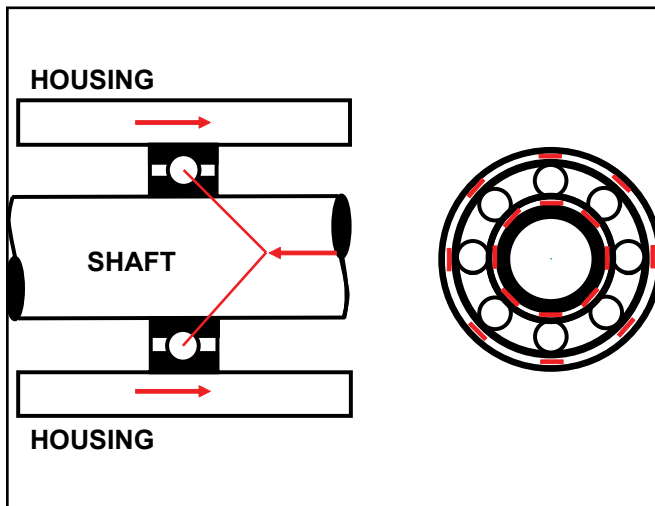

MOMENT LOAD

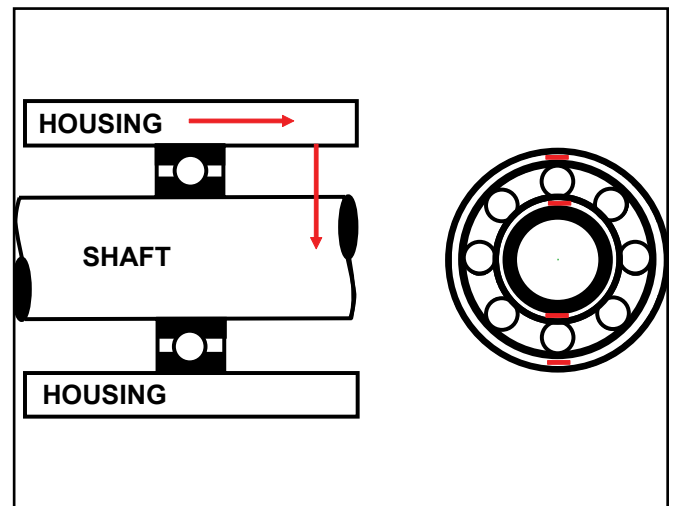

SECTION 3 - The Bearing Selection Process

Another classification used for bearing accuracy is the ABEC rating. ABEC stands for Annular Bearing Engineers Committee. This committee helps in determining bearing standards for the American Bearing Manufacturers Association (ABMA). ABEC ratings correspond to the following ISO ratings. Refer to the chart below.

3. SPEED REQUIREMENTS

Speed requirements are normally expressed in RPM's (Revolutions per Minute). Normally the first question regarding operating speed is what is the expected maximum RPM's, but it also should be determined as to whether the rotation is constant, variable, reversing, or oscillating. The other aspect of bearing rotation is whether the inner or outer ring is the rotating member. The majority of bearing applications will be rotating shaft with the inner ring rotating. However, there are some applications like wheel hubs, where the bearings are mounted inside the rotating hub and the outer ring is rotating. In addition to affecting the type of bearing to be used, these rotational considerations will affect the bearing life, fits of the rings, internal clearances, and lubrication requirements.

The limiting speed for bearings refers to the rotating speed at which the bearing can be rotated continuously without an excessive increase in operating temperature. The published limiting speed for bearings is lubrication based (oil or grease) and is listed in the bearing specification tables of the KOYO B201E catalog.

In general, point contact ball bearings such as the deep groove and angular contact, which generate less heat than line contact roller bearings, have the highest speed capabilities. However, if the speed capability of a bearing is questionable or the expected application operating speed approaches or exceeds the bearing limiting speed, KOYO should be consulted.

4. ACCURACY REQUIREMENTS

For each bearing type, there are different tolerances and running accuracy of bearings available. The dimensional and running accuracy of Koyo bearings is described in JIS B 1514; these JIS standards are based on ISO standards. Bearing tolerances are standardized by classifying bearings into the following six classes with the accuracy becoming higher in the order listed: 0, 6X, 6, 5, 4, and 2. Class 0 bearings meet the requirements for most general applications, while class 5 and higher will meet accuracy requirements for demanding applications such as machine tool spindles, radar equipment, computers, and all high precision applications.

ABEC RATING	ISO CLASS
ABEC 1	CLASS 0
ABEC 3	CLASS 6
ABEC 5	CLASS 5
ABEC 7	CLASS 4
ABEC 9	CLASS 2

SECTION 3 - The Bearing Selection Process

5. RIGIDITY REQUIREMENTS

In applications such as machine tool spindles and automobile final drives, bearing rigidity can be a determining factor of its desirability. Rigidity can be defined as the resistance of a bearing to elastic deformation at the point where the rolling elements contact the raceway surface. The higher the bearing rigidity the better the resistance to load induced deformation. Elastic deformation is less of a problem with line contact roller bearings than point contact ball bearings.

Bearing rigidity can be enhanced by setting up the bearings with preload or negative clearance. Using preload to increase rigidity is suitable for use with angular contact and tapered roller bearings. Preload is provided by applying an axial load to remove any clearance in the bearings. The additional preload force on the bearings results in more rolling elements sharing the loading on the bearing thereby increasing the bearings resistance to elastic deformation.

6. MISALIGNMENT CONSIDERATIONS

Bearing misalignment can be caused by a number of different conditions. Frequently misalignment is introduced by loading that causes a shaft to bend resulting in angular deflections in the bearings. Misalignment can also be induced by various machining inaccuracies of bearing seats and backing shoulders.

In general, whenever misalignment angles greater than 3-4 minutes are anticipated, consideration should be given to using a self-aligning bearing such as a spherical roller bearing or self-aligning ball bearing. Specific allowable misalignment values for each bearing type are covered before each bearing specification table in the KOYO/JTEKT ball and roller bearing catalog B201E.

7. MOUNTING AND DIS-MOUNTING CONSIDERATIONS

If application requirements call for periodic inspections that require mounting and dis-mounting of the bearings, the ease and methods required for these bearing procedures should be a bearing selection consideration. Bearing mounting and removal is simplified by the use of bearings that have separable races. Bearings such as cylindrical roller bearings, needle roller bearings, and tapered roller bearings have separable races and should be considered for applications requiring frequent inspections and removal of the bearings.

SECTION 3 - The Bearing Selection Process

SELECTION OF BEARING MOUNTING ARRANGEMENTS

Since operating conditions and machine components vary depending on the application; bearing performance and bearing mounting arrangements need to be varied. Normally, two or more bearings are used on one shaft. Frequently, in order to locate the shaft position in the axial direction, one bearing will need to be mounted in a fixed position with the other bearing mounted in a free or floating position. However, depending on shaft length and bearing spread distance, two single row tapers or two pair of angular contact ball bearings mounted face-to-face or back-to-back can be used without a free side since little thermal growth or shrinkage will occur with a short spread distance.

As pointed out above, fixed side bearings locate shafts axially, and will also be the bearing position that carries any axial loading that may be present. The free side bearing will float and allow axial shaft growth or shrinkage caused by operating temperature changes, thereby ensuring the bearings maintain proper operating clearance. Illustrated on the next page in examples 1-4 are several different bearing designs of fixed and free side mounting arrangements:

SECTION 3 - The Bearing Selection Process

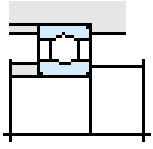
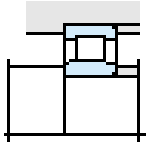
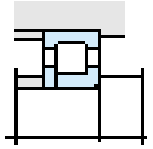
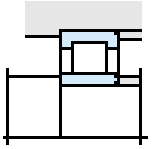
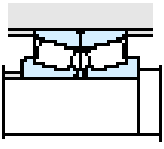
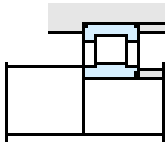
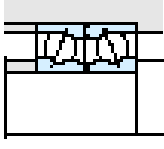
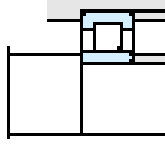
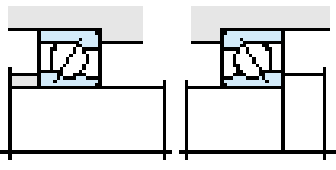
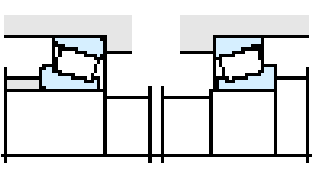
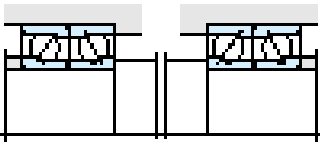
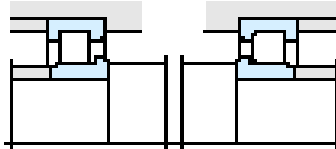
Ex. 1		Ex. 2	
FIXED SIDE	FREE SIDE	FIXED SIDE	FREE SIDE
			
Deep Groove Ball	Cylindrical Roller	Cylindrical Roller	Cylindrical Roller
Ex. 3		Ex. 4	
FIXED SIDE	FREE SIDE	FIXED SIDE	FREE SIDE
			
Tapered Roller	Cylindrical Roller	Angular Contact Ball	Cylindrical Roller
For those applications where shaft growth and shrinkage is not a concern, examples 5-8 are of mounting arrangements where a free or float bearing is not required:			
Ex. 5		Ex. 6	
			
Angular Contact Balls		Tapered Rollers	
Ex. 7		Ex. 8	
			
Angular Contact Balls		Cylindrical Rollers	

SECTION 3 - The Bearing Selection Process

Sealing Devices

Ex. 9

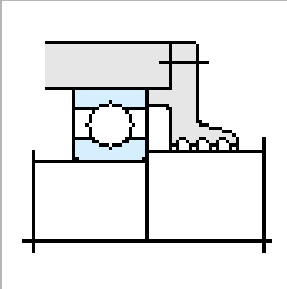

Oil Groove Design

Ex. 10

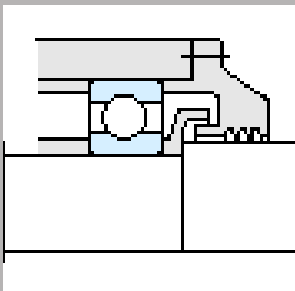

Flinger Design

Ex. 11

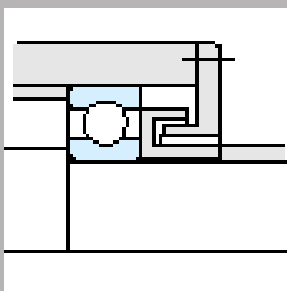

Labyrinth Design

SHAFT AND HOUSING DESIGN CONSIDERATIONS

When shaft and housings are designed, special consideration needs to be given to the backing and mounting dimensions of the surfaces and components that will be used to accommodate the bearings. The following are some design considerations for proper accommodation of bearings:

1. Shaft and housing wall sections supporting the bearings need to be large enough to prevent excessive bearing deflections.
2. The finish of the shaft and housing surfaces should be such that the required accuracy and fits are obtained.
3. The shaft and housing backing shoulders need to be at the specified dimensions for adequate support of the inner and outer rings.
4. The backing shoulder faces need to be perpendicular to the shaft and housing centerlines to avoid bearing misalignment.
5. The radii of the backing shoulders has to be smaller than the chamfer size of the bearings to ensure a flat square backing of the bearing rings.
6. The ends of shafts and housings for press fitted rings should be chamfered to ease assembly.

SEALING DEVICES

Sealing devices not only prevent foreign material from entering a bearing cavity area they prevent lubricant from leaking from the bearing cavity. Consequently, when a sealing device is selected it is important to consider the application operating conditions and type of lubrication to be used. Sealing devices are either non-contact or contact design style. A non-contact design includes oil grooves, flingers, and labyrinth styles which without a contact point will not contribute to operating torque or heat of an application. The non-contact devices utilize narrow clearances and centrifugal force and are especially suited for high speed operation to minimize operating temperatures. Examples of non-contact sealing devices and are shown to the left:

SECTION 3 - The Bearing Selection Process

BEARING SERVICE LIFE

When bearings are rotated under load and subjected to repeated contact stresses, wear will eventually result in the raceway material spalling and flaking off. The total number of revolutions until flaking occurs is described as the bearing service or fatigue life. Bearing service (fatigue) life varies depending on design, size, materials, manufacturing methods, and operating conditions.

If a group of identical bearings are rotated under the same conditions, the total numbers of revolutions until 10% of the bearings exhibit flaking or spalling damage is defined as the basic rating life or “L10” life. This rated life can be expressed in terms of time when the rotating speed is constant.

The calculation of the bearing service (fatigue) life is normally used in the selection of a bearing for a particular application, and is a criterion for acceptability of a bearing. However, other factors and environmental effects can result in pre-mature bearing damage and a reduction in fatigue life. Factors such as improper bearing mounting procedures, lubrication methods and type, fits of the inner and outer rings, and the wrong bearing clearances for the expected operating conditions can all result in fewer hours of bearing life.

BASIC DYNAMIC LOAD RATING

The basic dynamic load rating can be either pure radial for radial bearings or pure axial load for thrust bearings of a constant magnitude in the same direction, which will give the basic rated life of 1 million revolutions at 33 1/3 rpm rotation of inner ring. The basic dynamic load rating for radial bearings is listed as the “Cr” value, while the basic dynamic rating for thrust bearings is listed as the “Ca” value. The basic dynamic load ratings can be found in the KOYO JTEKT ball and roller bearing catalog.

Another effective means for sealing bearing is through the use of contact or rubbing type seals which employ at least one contacting lip. These seals typically are manufactured from synthetic rubber, synthetic resin, or felt. Rubbing type seals can be used with either oil or grease lubrication. When a dirty operating environment expected, these seals can also be provided with a second or minor sealing lip which acts to prevent the entry of contaminants. For additional information and selection of contacting seals, see the KOYO JTEKT cat. No. R2001E on Oil Seals & O-Rings. Below is an example of a contacting oil seal design:

Ex. 12

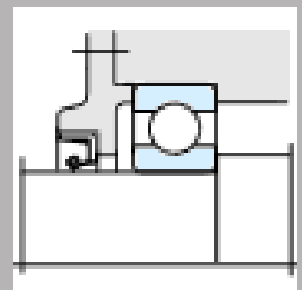

Contacting Single Lip Oil Seal Design

SECTION 3 - The Bearing Selection Process

DID YOU KNOW ...

Koyo offers you a TOLL FREE Technical Support Line to assist you.

Give us a call if you need help with:

Part number interchanges

Mounting instructions

Precision grades

Application specifications

Bearing life

Load capacities

Or anything technical

CALL
1-866-
KOYOTECH

DYNAMIC EQUIVALENT RADIAL LOAD

Bearings are used under various operating conditions which frequently include operating with both radial and thrust loading. In order to calculate a bearing fatigue life with combined thrust and radial loading, it is necessary to calculate a dynamic equivalent radial load value. The dynamic equivalent radial load is defined as a single radial load that will result in the same bearing life as the combined load condition. The equivalent radial load (P) is calculated by applying adjustment factors (X and Y) to the applied radial and thrust loads. These factors will vary depending on bearing type, contact angle, and load magnitudes. The equivalent radial load equations and adjustment factors can be found in the bearing selection section of the KOYO/JTEKT ball and roller bearing catalog.

BASIC DYNAMIC BEARING LIFE CALCULATION

The Basic Dynamic Bearing Life can be expressed using the following equation (3-1) which takes into account the basic dynamic load rating and the dynamic bearing load rating. This equation can be modified to show the theoretical bearing life in terms of time or hours (3-2), or in terms of running distance or km (3-3):

$$\text{(Total revolutions)} \quad L_{10} = (C/P)^p \quad (3-1)$$

$$\text{(Time)} \quad L_{10h} = 10^6 (C/P)^p / 60n \quad (3-2)$$

$$\text{(Running distance)} \quad L_{10s} = \pi DL_{10} \quad (3-3)$$

Where,

L10 = Basic Rating Life	10 ⁶ (revolutions)	C = Basic Dynamic Load Rating	N
L10h = Basic Rating Life	<i>h</i> (hours)	n = Rotational Speed	r/min
L10s = Basic Rating Life	km (mileage)	p = for ball bearings	p=3
P = Dynamic Equivalent Load	N	p = for roller bearings	p=10/3
D = wheel or tire diameter	mm		

CORRECTION OF BASIC DYNAMIC LOAD RATING

In high temperature environments, bearing material hardness deteriorates as material composition is altered. Consequently, the basic dynamic load rating is no longer a good prediction of bearing fatigue life. Once material composition is altered, it will not recover even if operating temperatures return to normal. Therefore, for bearings operating in high temperature environments, the basic dynamic load rating should be reduced according to expected operating temperatures. The basic dynamic load rating should be reduced for high operating temperatures according to the factors listed in the chart on the next page:

SECTION 3 - The Bearing Selection Process

Values of Temperature Adjustment Factor

Bearing temperature C/F	125°/260°	150°/300°	175°/350°	200°/380°	250°/480°
Temperature adjustment factor	1	1	0.95	0.90	0.75

CORRECTION OF BEARING BASIC DYNAMIC LIFE CALCULATION

As pointed out previously, the basic dynamic life is expressed using a reliability factor of 90% or L_{10} life. However, there are demanding applications requiring reliability higher than 90%. To select a bearing requiring a higher reliability than what is predicted using the basic dynamic life equation, several adjustment factors can be applied to the L_{10} life to give a corrected dynamic life value or “ L_{na} ” life:

$$L_{na} = a_1 a_2 a_3 L_{10}$$

a_1 : reliability factor
 a_2 : bearing characteristic factor
 a_3 : operating characteristic factor

- a_2 – This factor can be greater than 1 for bearings made of specialty materials to extend fatigue life

Reliability %	Life definition	a_1
90	L_{10}	1
95	L_5	0.62
96	L_4	0.53
97	L_3	0.44
98	L_2	0.33
99	L_1	0.21

- a_3 – Under normal lube conditions the calculation can be performed with $a_3 = 1$, with favorable lubrication a_3 can be greater than 1. Under poor or marginal lube conditions a_3 can be lower than 1
- L_{10} – Basic dynamic bearing life (90% reliability)

SECTION 3 - The Bearing Selection Process

LOAD DIAGRAM OF TRANSMISSION GEAR SHAFT

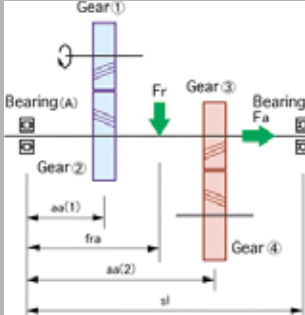

Reference can be made to the selection of bearing dimension section of the KOYO ball & roller bearing catalog for a tabulation of load coefficient values for various applications and bearing load calculation examples.

BASIC STATIC LOAD RATING

The static load rating is defined as the static load level or impact loading which when applied to a stationary bearing will produce a permanent deformation of the raceways. The amount of deformation (Brinelling) has to be sufficient to effect the smooth rotation and performance of the bearing and will be approximately 1/1000 of the rolling element diameter as determined by ISO standards. The Basic Static Load Rating is the static load which corresponds to the calculated contact stress values listed below:

SELF-ALIGNING BALL BEARING	= 4600 Mpa
OTHER BALL BEARINGS	= 4200 Mpa
ROLLER BEARINGS	= 4000 Mpa

The basic static load rating for radial bearings is specified as the basic static radial load rating or the “Cor” value, and for thrust bearings as the basic static axial load rating or the “Coa” value. These values are listed in the bearing specification tables of the KOYO ball and roller bearing catalogs.

DESCRIPTION OF BEARING LOADING ANALYSIS

The loading affecting bearing rolling elements can be from various sources from just a weight load of an object to, transmission force loading from gears, chain sprockets, and belt pulleys, to impact loading from use in construction equipment. Depending on the application and operating environment, a static moment loading analysis alone may not be an accurate reflection of bearing loading and resulting life. Consequently, due to load fluctuations in frequency and magnitude, and possible effects of vibration and impact loading, it is often necessary to multiply the theoretical load value by a load coefficient. For the gear forces shown on the illustration to the left, the value of gear coefficients will be either 1.0 to 1.1 for precision gearing to 1.1 to 1.3 for standard gearing.

SECTION 3 - The Bearing Selection Process

LIMITING SPEED CONSIDERATIONS

The rotating speed of a bearing is normally limited by heat generated in the bearing. If the heat exceeds a certain value, seizure and/ or lubrication failures may occur. As pointed out under “Application Operating Considerations”, the limiting speed of a bearing refers to the speed at which the bearing can be rotated continuously without an excessive increase in temperature. When a sealed bearing with a contact type seal is involved, the rotating speed is limited by two more factors; the running speed of the seal contact surface and the heat resistance characteristics of the grease being used.

The limiting speed of a bearing varies depending on the bearing type, dimensions, accuracy, lubrication method, the properties and amount of lubricant, the type and material of cage, and loading conditions.

The limiting speed for each bearing is based on the use of grease or oil bath lubrication.

The published limiting speed applies to operation under normal loading conditions ($C/P \geq 13$, $F_a/F_r \geq \text{approx. } 0.25$).

C: basic dynamic load rating = N

P: dynamic equivalent load = N

Fr: radial load = N

Fa: axial load = N

If a bearing is being considered for use when it is to be operated near or beyond its limiting speed the following points should be considered:

1. Use of high precision bearings
2. Study of proper internal clearance (reduction in internal clearance caused by temperature increase should be considered.)
3. Selection of proper cage type and materials (for high speed, copper alloy or phenolic resin machined cages are suitable.)
4. Selection of a high speed lubrication system such as forced oil lubrication, oil jet lubrication, oil mist lubrication and air/oil lubrication, along with consideration of lubricant properties such as the proper viscosity rating.

SECTION 3 - The Bearing Selection Process

NOTES

Koyo

SECTION 3 - The Bearing Selection Process

NOTES

A large grid area for taking notes, with a faint 'Koyo' watermark in the center.

SECTION 4 - Bearing Tolerances, Fits, & Clearances

The bearing standards organizations and the applied tolerance classes control the size limit tolerances for all envelope dimensions such as bearing bores, outside diameter, assembled width, inner & outer ring widths, chamfer dimensions, and tapered bore tolerances. Also bearing precision requirements such as radial & axial runout of assembled bearings and the individual rings, and perpendicularity of ring faces & outside surfaces. All of these tolerance tables and charts are covered in the KOYO JTEKT Ball and Roller Bearing catalogs tolerance section.

BEARING TOLERANCES AND CLASSES

Since application tolerance and accuracy requirements do vary, bearing manufacturers produce bearings to varying degrees of precision and tolerance. Accuracy requirements are typically highest for applications like machine tool spindles, radar antennas, computers, and precision measuring instruments. Most automotive applications, construction equipment, agricultural equipment, electric motors, and other general application do not require the highest precision and tolerances controls.

The tolerance classifications for bearings were briefly covered in SECTION 3 "Accuracy Requirements". It was pointed out that the JIS standards are based on the ISO classes which increase in order of precision from 0, 6X, 6, 5, 4, to 2. The chart below shows the various bearing types and the corresponding applied standards and classes. Also listed are the class designations for standards organizations JIS (The Japan Bearing Industrial Association) and the ABMA (American Bearing Manufacturers Association):

BEARING TYPE		APPLIED STANDARDS	APPLIED TOLERANCE CLASS					
Deep groove ball bearing		JIS B 1514	Class 0	-	Class 6	Class 5	Class 4	Class 2
Angular contact ball bearing			Class 0	-	Class 6	Class 5	Class 4	Class 2
Self-aligning ball bearing			Class 0	-	-	-	-	-
Spherical roller bearing			Class 0	-	-	-	-	-
Cylindrical roller bearing			Class 0	-	Class 6	Class 5	Class 4	Class 2
Needle roller bearing (Machined ring type)			Class 0	-	Class 6	Class 5	Class 4	-
Tapered roller bearing	Metric series (Single row)	JIS B 1514	Class 0	6X Class	Class 6	Class 5	Class 4	-
	Metric series (Double or four-row)	BAS 1002	Class 0	-	-	-	-	-
	Inch series	ABMA	Class 4	-	Class 2	Class 3	Class 0	Class 00
	Metric series (J-series)		Class PK	-	Class PN	Class PC	Class PB	-
Thrust roller bearing		JIS B 1514	Class 0	-	Class 6	Class 5	Class 4	-
Spherical thrust roller bearing			Class 0	-	-	-	-	-

SECTION 4 - Bearing Tolerances, Fits, & Clearances

BEARING SHAFT AND HOUSING FITS

Understanding bearing fits and determining the proper fitting practice for a particular bearing and application are very important considerations for ensuring that a bearing will achieve its service life and provide satisfactory equipment operation.

PURPOSE OF BEARING FITS

The purpose of fitting an inner or outer ring onto a shaft or into housing is to prevent circumferential sliding or spinning of the fitted ring. Bearing ring sliding or “creep” will have a detrimental effect on bearing operation. Bearing creep can cause excessive heat generation, wear, and contamination of the bearing from wear particles, vibration, and misalignment problems. Consequently, it is necessary to assure that a bearing ring rotating under load will have the appropriate interference fit.

It is not always necessary for a bearing ring to have an interference fit. The primary requirement for an interference fit is normally determined by whether the ring is the rotating member or not. However, there are additional considerations that will be covered for determining if an interference fit is needed and the magnitude of the fit.

ISO FIT DESIGNATIONS

In addition to an interference fit, there are two other classifications of fits; they are referred to as a “clearance fit” or slip fit and a “transition fit” which can be snug to slightly loose. Since Koyo and all bearing manufacturers follow the ISO designated fits, a consistent system is provided throughout the bearing industry. The correct bearing fits can only be selected if the correct tolerance for the shaft and housing has been selected. The tolerance designations are represented by a letter and a numeral. The designations using capital letters are for housing fits while those using small letters are for shaft fits and indicate the tolerance location while the numeral represents the magnitude of the tolerance. The illustration below shows the relationship between the ISO tolerance designations for the shaft/housing diameters and the resultant fit category:

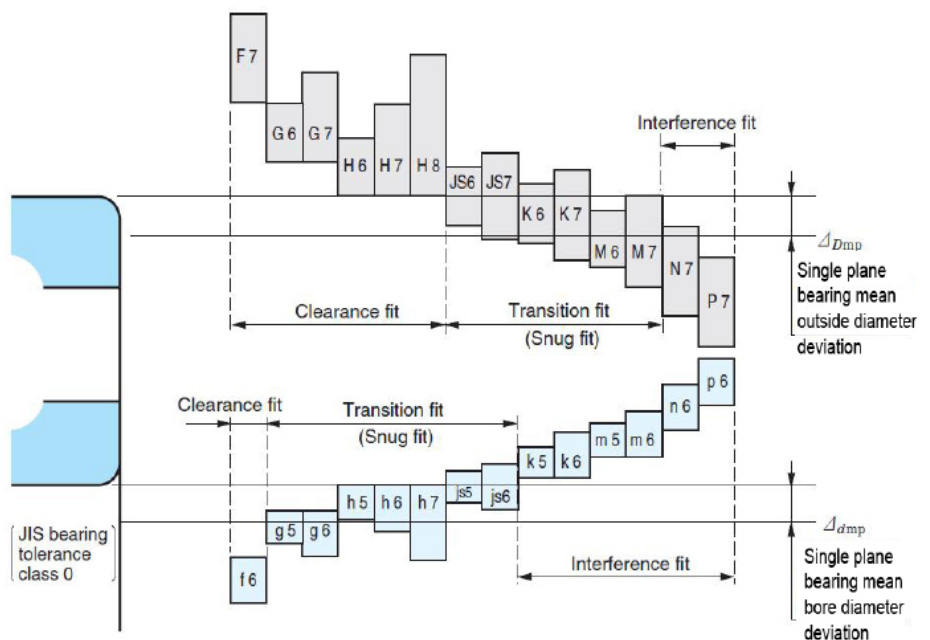







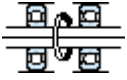

SECTION 4 - Bearing Tolerances, Fits, & Clearances

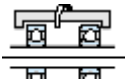
FIT SELECTION CONSIDERATIONS

As previously pointed out, there are other operating conditions to consider in addition to knowing which ring will be rotating when trying to determine the proper fits to use. The operating conditions that should be considered when determining bearing ring fits are the following:

- Load characteristics
- Load magnitude
- Temperature effects
- Effect on bearing internal clearances
- Finish of mating surface
- Shaft and housing material & section thickness
- Mounting design and fixed and float considerations
- Bearing type and size

Rotation pattern	Direction of load	Loading conditions	Fit		Typical application
			Inner ring & shaft	Outer ring & housing	
 Inner ring : rotating Outer ring : stationary	 Stationary	Rotating inner ring load Stationary outer ring load	Interference fit necessary (k, m, n, p, r)	Clearance fit acceptable (F, G, H, JS)	Spur gear boxes, motors
 Inner ring : stationary Outer ring : rotating	 Rotating with outer ring				Greatly unbalanced wheels
 Inner ring : stationary Outer ring : rotating	 Stationary	Stationary inner ring load Rotating outer ring load	Clearance fit acceptable (f, g, h, js)	Interference fit necessary (K, M, N, P)	Running wheels & pulleys with stationary shaft
 Inner ring : rotating Outer ring : stationary	 Rotating with inner ring				Shaker screens (unbalanced vibration)

SECTION 4 - Bearing Tolerances, Fits, & Clearances

LOAD MAGNITUDE EFFECT

When a radial load is applied to a bearing, the inner ring will expand slightly reducing the initial interference fit. The decrease in the interference fit can be calculated using the following equation:

(In the case of $F_r \leq 0.25C_o$)	(In the case of $F_r > 0.25C_o$)
$\Delta d_F = 0.08 \sqrt{d \cdot F_r / B} \times 10^{-3}$	$\Delta d_F = 0.02 \sqrt{(F_r / B)} \times 10^{-3}$

Where:

Δd_F : reduction of inner ring interference mm

d : bore diameter of bearing mm

B : inner ring width mm

F_r : radial load N

C_o : basic static load rating N

Consequently, when the radial load exceeds the C_o value by more than 25%, a greater interference fit is needed to compensate for the reduction amount. Also, a greater interference fit would be needed to offset the effect of any shock loading that may occur.

TEMPERATURE EFFECT

A bearing will normally have a higher operating temperature than the surrounding environment. When an inner ring operates under load its temperature will become higher than the shaft resulting in a decrease in the interference fit due to thermal expansion of the ring. Tests have shown that the difference in temperature between the inner ring & shaft is 10% - 15% less than temperature of the bearing interior and surrounding housing. The reduction in the interference fit due to thermal expansion can be calculated using the following equation:

$$\Delta d_t = (0.10 \text{ to } 0.15) \Delta_t \cdot a \cdot d \doteq 0.0015 \Delta d_t \cdot d \times 10^3$$

Where:

Δd_t : reduction of interference due to temperature difference mm

Δ_t : temperature difference between the inside of the bearing and the surrounding housing ($^{\circ}\text{K}$)

a : linear expansion coefficient of bearing steel ($\doteq 12.5 \cdot 10^{-6}$) 1°K

d : bore diameter of bearing mm

Consequently, when a bearing is operating at greater temperatures than the shaft, it may be necessary to increase the interference fit.

SECTION 4 - Bearing Tolerances, Fits, & Clearances

EFFECT ON INTERNAL CLEARANCES

The effect of interference fits on bearing internal clearances also needs to be taken into consideration. An interference fit expands the inner ring, while an interference fit on the outer ring will compress it. Both of these conditions will result in a loss of internal bearing clearance. This topic will be covered in more detail in the BEARING INTERNAL CLEARANCES & PRELOAD section.

FINISH OF MATING SURFACES

A maximum surface finish roughness of 63 micro-inches (1.6 Ra) is required for most large inner ring seats, while a max. finish of 32 micro-inches (.8 Ra) should be used on small bearings. Housing bore seats can be in the 63 to 125 micro-inch (1.6 to 6.1 Ra) finish range. There are situations when a better surface finish is required, such as when a rubbing seal is also contacting the same surface in which case, a finish of 16 micro-inches or better should be used. Also, a needle roller bearing that uses the same shaft surface as its inner ring should have a surface finish in the 8 to 15 micro-inch (.2 to .4 Ra) range.

The effective interference fit obtained after a bearing ring has been pressed onto a shaft or into housing is different from the original calculated fit due to deformation of the fitted surface. If a rough surface finish or turned shaft finish is used, it may result in excessive wear of the seats and creeping problems. Consequently, it may be necessary to use greater interference fits to prevent wear related problems with turned shafts. The actual effective interference fit can be calculated to determine its adequacy for particular operating conditions:

$$\text{(In the case of a ground shaft) } \Delta d_{\text{eff}} \doteq \Delta d \cdot d/(d+2)$$

$$\text{(In the case of a turned shaft) } \Delta d_{\text{eff}} \doteq \Delta d \cdot d/(d+3)$$

Where:

Δd_{eff} : effective interference mm

Δd : calculated interference mm

d : bore diameter of bearing mm

SECTION 4 - Bearing Tolerances, Fits, & Clearances

SHAFT AND HOUSING MATERIALS & SECTION THICKNESS

With hollow shafts and thin section housings that will use an interference fitted ring, a greater than normal interference should be used for obtaining the same holding force of a solid shaft and thick housing. Additionally, since aluminum has a higher coefficient of thermal expansion that is two times that of bearings, special care must be taken to insure proper fits are being used at operating temperature. KOYO should be consulted for additional information and help in determining the appropriate fitting practice.

MOUNTING DESIGN AND FIXED & FLOAT CONSIDERATIONS

A mounting design consideration that needs to be taken into account is whether the bearing will be mounted on the fixed or free side. Normally, since it is the outer free side ring that needs to float, and it is also the stationary ring, a sufficiently large clearance fit needs to be used to assure the ring is free to float under load conditions. The fixed side outer ring can also be mounted with a clearance fit, but should not be as great since it can be displaced by axial loads.

For those applications that use tapered roller or angular contact ball bearings, another mounting design consideration when selecting fits is whether the ring is adjustable or not. An adjustable ring requires an adequate clearance fit to allow it to be displaced axially.

BEARING TYPE AND SIZE

Fit requirements will vary depending on the type of bearing and its size. The ring section thickness, design, and size dictate what allowable contact stresses will result from an interference fit and also what would be an allowable clearance fit. Consequently, to prevent damage and fracture of bearing rings, it is necessary to change fitting practices accordingly. KOYO JTEKT has published various fitting practice tabulation to serve as a general guide for various bearing types and sizes. Several examples of these fitting practice charts for radial and tapered bearings are covered here. For complete coverage of recommended fits for other bearing types and classes, refer to the KOYO Ball and Roller Bearing catalog.

SECTION 4 - Bearing Tolerances, Fits, & Clearances

RECOMMENDED SHAFT FITS FOR RADIAL BEARINGS (classes 0, 6X, 6)

Conditions ¹⁾		Ball bearing		Cylindrical roller bearing Tapered roller bearing		Spherical roller bearing		Class of shaft tolerance	Remarks
		Shaft diameter (mm)							
		Over	Up to	Over	Up to	Over	Up to		
Rotating inner ring load or indeterminate direction load	Light load or fluctuation load $P/C \leq 0.06$	-	18	-	-	-	-	h5	For applications requiring high accuracy, js5, k5, and m5 should be used in place of js6, k6 and m6.
		18	100	-	40	-	-	js6	
		100	200	40	140	-	-	k6	
		-	-	140	200	-	-	m6	
	Normal load $0.06 < P/C \leq 0.12$	-	18	-	-	-	-	js5	For single-row tapered roller bearings and angular contact ball bearings, k 5 and m5 may be replaced by k6 and m6, because internal clearance reduction due to fit need not be considered.
		18	100	-	40	-	40	k5	
		100	140	40	100	40	65	m5	
		140	200	100	140	65	100		
		200	280	140	200	100	140	m6	
		-	-	200	400	140	280	n6	
		-	-	-	-	280	500	p6	
							r6		
	Heavy load or impact load $P/C > 0.12$	-	-	50	140	50	100	n6	Bearings with larger internal clearance than standard are required.
		-	-	140	200	100	140	p6	
		-	-	200	-	140	200	r6	

SECTION 4 - Bearing Tolerances, Fits, & Clearances

RECOMMENDED HOUSING FITS FOR RADIAL BEARINGS (classes 0, 6X, 6)

Conditions			Class of housing bore tolerance	Remarks	Applications (for reference)	
Housing	Load type etc. ¹⁾	Outer ring axial displacement ²⁾				
One piece or split type	Stationary outer ring load	All load types	Easily displaceable	H7	G7 may be applied when a large size bearing is used, or if the temperature difference is large between the outer ring and housing.	Ordinary bearing devices, railway rolling stock axle boxes, power transmission equipment etc.
		Light or normal load	Easily displaceable	H8	-	
		High temperature at shaft and inner ring	Easily displaceable	G7	F7 may be applied when a large size bearing is used, or if the temperature difference is large between the outer ring and housing.	Drying cylinders etc.
One piece type	Indeterminate direction load	Light or normal load, requiring high running accuracy	Not displaceable in principle	K6	Mainly applied to roller bearings.	
			Displaceable	JS6	Mainly applied to ball bearings.	
		Requiring low noise rotation	Easily displaceable	H6	-	
	Indeterminate direction load	Light or normal load	Normally displaceable	JS7	For applications requiring high accuracy, JS 6 and K 6 should be used in place of JS 7 and K 7.	Electric motors, pumps, crankshaft Normal or main bearings etc.
		Normal or heavy load	Not displaceable in principle	K7		
		High impact load	Not displaceable	M7		
	Rotating outer ring load	Light or fluctuating load	Not displaceable	M7	-	Conveyer rollers, ropeways, tension pulleys etc.
		Normal or heavy load	Not displaceable	N7	Mainly applied to ball bearings.	Wheel hubs with ball bearings etc.
		Thin section housing, heavy or high impact load	Not displaceable	P7	Mainly applied to roller bearings.	Wheel hubs with roller bearings, bearings for large end of connecting rods etc.

[Notes]

1) Loads are classified as stated in Note ¹⁾ to Table 6-1(1)

2) Indicating distinction between applications of non-separable bearings permitting and not permitting axial displacement of the outer rings.

Remarks: 1. This table is applicable to cast iron or steel housings

2. If only central axial load is applied to the bearing, select such tolerance range class as to provide clearance in the radial direction for outer ring.

SECTION 4 - Bearing Tolerances, Fits, & Clearances

RECOMMENDED SHAFT FITS FOR INCH SERIES TAPERED ROLLER BEARINGS

Bearing Tolerance : class 4, class 2

Load type		Nominal bore diameter d mm (1/25.4 inches)				Deviation of a single bore diameter $\Delta d_s, \mu\text{m}$		Dimensional tolerance of shaft diameter μm		Remarks
		over		up to		upper	lower	upper	lower	
		mm	in	mm	in					
Rotating cone load	Normal load	-	-	76.2	3.0	+13	0	+38	+25	
		76.2	3.0	304.8	12.0	+25	0	+64	+38	
		304.8	12.0	609.6	24.0	+51	0	+127	+76	
		609.6	24.0	914.4	36.0	+76	0	+190	+114	
	Heavy load Impact load High speed rotation	-	-	76.2	3.0	+13	0	Should be such that average interference stands at 0.0005 X d(mm)		Generally, bearing internal clearance should be larger than standard.
		76.2	3.0	304.8	12.0	+25	0			
		304.8	12.0	609.6	24.0	+51	0			
		609.6	24.0	914.4	36.0	+76	0			
Rotating cup load	Normal load without impact	-	-	76.2	3.0	+13	0	+13	0	
		76.2	3.0	304.8	12.0	+25	0	+25	0	
		304.8	12.0	609.6	24.0	+51	0	+51	0	
		609.6	24.0	914.4	36.0	+76	0	+76	0	
	Normal load without impact	-	-	76.2	3.0	+13	0	0	+13	Cone is displaceable in axial direction.
		76.2	3.0	304.8	12.0	+25	0	0	+25	
		304.8	12.0	609.6	24.0	+51	0	0	+51	
		609.6	24.0	914.4	36.0	+76	0	0	+76	
	Heavy load Impact load High speed rotation	-	-	76.2	3.0	+13	0	Should be such that average interference stands at 0.0005 X d(mm)		Generally, bearing internal clearance should be larger than standard.
		76.2	3.0	304.8	12.0	+25	0			
		304.8	12.0	609.6	24.0	+51	0			
		609.6	24.0	914.4	36.0	+76	0			

SECTION 4 - Bearing Tolerances, Fits, & Clearances

RECOMMENDED HOUSING FITS FOR RADIAL BEARINGS (classes 0, 6X, 6)

Load type		Nominal outside diameter D mm (1/25.4 inches)				Deviation of a single outside diameter $\Delta D_s \mu\text{m}$		Dimensional tolerance of housing bore diameter μm		Remarks
		over		up to		upper	lower	upper	lower	
		mm	in	mm	in					
Rotating cone load	Used for free or fixed side.	-	-	76.2	3.0	+25	0	+76	+51	Cup is easily displaceable in axial direction.
		76.2	3.0	127.0	5.0	+25	0	+76	+51	
		127.0	5.0	304.8	12.0	+25	0	+76	+51	
		304.8	12.0	609.6	24.0	+51	0	+152	+102	
	Position of cup is adjustable (in axial direction)	-	-	76.2	3.0	+25	0	+25	0	Cup is displaceable in axial direction.
		76.2	3.0	127.0	5.0	+25	0	+25	0	
		127.0	5.0	304.8	12.0	+25	0	+51	0	
		304.8	12.0	609.6	24.0	+51	0	+76	+25	
	Position of cup is not adjustable (in axial direction).	-	-	76.2	3.0	+25	0	-13	-38	Cup is fixed in axial direction.
		76.2	3.0	127.0	5.0	+25	0	-25	+51	
		127.0	5.0	304.8	12.0	+25	0	-25	+51	
		304.8	12.0	609.6	24.0	+51	0	-25	-76	
Rotating cup load	Position of cup is not adjustable (in axial direction).	609.6	24.0	914.4	36.0	+76	0	-25	-102	Cup is fixed in axial direction.
		-	-	76.2	3.0	+25	0	-13	-38	
		76.2	3.0	127.0	5.0	+25	0	-25	+51	
		127.0	5.0	304.8	12.0	+25	0	-25	+51	
		304.8	12.0	609.6	24.0	+51	0	-25	-76	
		609.6	24.0	914.4	36.0	+76	0	-25	-102	

SECTION 4 - Bearing Tolerances, Fits, & Clearances

FITTING PRACTICE TABLES

The following tables show recommended shaft and housing fitting practice values for ball, cylindrical roller, and tapered roller bearings. The fitting practices shown for ball and cylindrical roller bearings are commonly used for electric motors and most other applications using these single row bearings.

RECOMMENDED FITTING PRACTICE FOR DEEP GROOVE & ANGULAR CONTACT BALL BEARINGS(6200/7200 & 6300/7300) Bearing Tolerance Class 0, 6X, & 6

BEARING	SHAFT O.D.	HSG DIA	SHAFT TOLERANCE FIT = MIN/MAX		HOUSING TOLERANCE FIT = MIN/MAX		SHAFT SIZE (mm)		SHAFT SIZE (inches)		HSG SIZE (mm)		HSG SIZE (inches)	
	mm	mm	x 0.001 mm	x 0.0001 in	x 0.001 mm	x 0.0001 in	Min.	Max.	Min.	Max.	Min.	Max.	Min.	Max.
6200/7200	10.000	30.000	js5 = -3/3	js5 = -1.2/1.2	H6 = 0/13	H6 = 0/5.1	9.997	10.003	0.3936	0.3938	30.000	30.013	1.1811	1.1816
6201/7201	12.000	32.000	js5 = -4/4	js5 = -1.6/1.6	H6 = 0/16	H6 = 0/6.3	11.996	12.004	0.4723	0.4726	32.000	32.016	1.2598	1.2605
6202/7202	15.000	35.000	js5 = -4/4	js5 = -1.6/1.6	H6 = 0/16	H6 = 0/6.3	14.996	15.004	0.5904	0.5907	35.000	35.016	1.3780	1.3786
6203/7203	17.000	40.000	js5 = -4/4	js5 = -1.6/1.6	H6 = 0/16	H6 = 0/6.3	16.996	17.004	0.6691	0.6694	40.000	40.016	1.5748	1.5754
6204/7204	20.000	47.000	k5 = 2/11	k5 = 0.8/4.3	H6 = 0/16	H6 = 0/6.3	20.002	20.011	0.7875	0.7878	47.000	47.016	1.8504	1.8510
6205/7205	25.000	52.000	k5 = 2/11	k5 = 0.8/4.3	H6 = 0/19	H6 = 0/7.5	25.002	25.011	0.9843	0.9847	52.000	52.019	2.0472	2.0480
6206/7206	30.000	62.000	k5 = 2/11	k5 = 0.8/4.3	H6 = 0/19	H6 = 0/7.5	30.002	30.011	1.1812	1.1815	62.000	62.019	2.4409	2.4417
6207/7207	35.000	72.000	k5 = 2/13	k5 = 0.8/5	H6 = 0/19	H6 = 0/7.5	35.002	35.013	1.3780	1.3785	72.000	72.019	2.8346	2.8354
6208/7208	40.000	80.000	k5 = 2/13	k5 = 0.8/5	H6 = 0/19	H6 = 0/7.5	40.002	40.013	1.5749	1.5753	80.000	80.019	3.1496	3.1504
6209/7209	45.000	85.000	k5 = 2/13	k5 = 0.8/5	H6 = 0/22	H6 = 0/8.7	45.002	45.013	1.7717	1.7722	85.000	85.022	3.3465	3.3473
6210/7210	50.000	90.000	k5 = 2/13	k5 = 0.8/5	H6 = 0/22	H6 = 0/8.7	50.002	50.013	1.9686	1.9690	90.000	90.022	3.5433	3.5442
6211/7211	55.000	100.000	k5 = 2/15	k5 = 0.8/6	H6 = 0/22	H6 = 0/8.7	55.002	55.015	2.1654	2.1659	100.000	100.022	3.9370	3.9379
6212/7212	60.000	110.000	k5 = 2/15	k5 = 0.8/6	H6 = 0/22	H6 = 0/8.7	60.002	60.015	2.3623	2.3628	110.000	110.022	4.3307	4.3316
6213/7213	65.000	120.000	k5 = 2/15	k5 = 0.8/6	H6 = 0/22	H6 = 0/8.7	65.002	65.015	2.5591	2.5596	120.000	120.022	4.7244	4.7253
6214/7214	70.000	125.000	k5 = 2/15	k5 = 0.8/6	H6 = 0/25	H6 = 0/9.8	70.002	70.015	2.7560	2.7565	125.000	125.025	4.9213	4.9222
6215/7215	75.000	130.000	k5 = 2/15	k5 = 0.8/6	H6 = 0/25	H6 = 0/9.8	75.002	75.015	2.9528	2.9533	130.000	130.025	5.1181	5.1191
6216/7216	80.000	140.000	k5 = 2/15	k5 = 0.8/6	H6 = 0/25	H6 = 0/9.8	80.002	80.015	3.1497	3.1502	140.000	140.025	5.5118	5.5128
6217/7217	85.000	150.000	k5 = 3/18	k5 = 1.2/7	H6 = 0/25	H6 = 0/10	85.003	85.018	3.3466	3.3472	150.000	150.025	5.9055	5.9065
6218/7218	90.000	160.000	k5 = 3/18	k5 = 1.2/7	H6 = 0/25	H6 = 0/10	90.003	90.018	3.5434	3.5440	160.000	160.025	6.2992	6.3002
6219/7219	95.000	170.000	k5 = 3/18	k5 = 1.2/7	H6 = 0/25	H6 = 0/10	95.003	95.018	3.7403	3.7409	170.000	170.025	6.6929	6.6939
6220/7220	100.000	180.000	k5 = 3/18	k5 = 1.2/7	H6 = 0/25	H6 = 0/10	100.003	100.018	3.9371	3.9377	180.000	180.025	7.0866	7.0876
6221/7221	105.000	190.000	m5 = 13/28	m5 = 5/11	H6 = 0/29	H6 = 0/11	105.013	105.028	4.1344	4.1350	190.000	190.029	7.4803	7.4815
6222/7222	110.000	200.000	m5 = 13/28	m5 = 5/11	H6 = 0/29	H6 = 0/11	110.013	110.028	4.3312	4.3318	200.000	200.029	7.8740	7.8752
6224/7224	120.000	215.000	m5 = 13/28	m5 = 5/11	H6 = 0/29	H6 = 0/11	120.013	120.028	4.7249	4.7255	215.000	215.029	8.4646	8.4657
6226/7226	130.000	230.000	m5 = 15/33	m5 = 6/13	H6 = 0/29	H6 = 0/11	130.015	130.033	5.1187	5.1194	230.000	230.029	9.0551	9.0563
6228/7228	140.000	250.000	m5 = 15/33	m5 = 6/13	H6 = 0/29	H6 = 0/11	140.015	140.033	5.5124	5.5131	250.000	250.029	9.8425	9.8437
6230/7230	150.000	270.000	m6 = 15/40	m6 = 6/16	H6 = 0/32	H6 = 0/13	150.015	150.040	5.9061	5.9071	270.000	270.032	10.6299	10.6312
6232/7232	160.000	290.000	m6 = 15/40	m6 = 6/16	H6 = 0/32	H6 = 0/13	160.015	160.040	6.2998	6.3008	290.000	290.032	11.4173	11.4186
6234/7234	170.000	310.000	m6 = 15/40	m6 = 6/16	H6 = 0/32	H6 = 0/13	170.015	170.040	6.6935	6.6945	310.000	310.032	12.2047	12.2060
6236/7236	180.000	320.000	m6 = 15/40	m6 = 6/16	H6 = 0/36	H6 = 0/14	180.015	180.040	7.0872	7.0882	320.000	320.036	12.5984	12.5998
6238/7238	190.000	340.000	m6 = 17/46	m6 = 7/18	H6 = 0/36	H6 = 0/14	190.017	190.046	7.4810	7.4821	340.000	340.036	13.3858	13.3872
6240/7240	200.000	360.000	m6 = 17/46	m6 = 7/18	H6 = 0/36	H6 = 0/14	200.017	200.046	7.8747	7.8758	360.000	360.036	14.1732	14.1746
6244/7244	220.000	400.000	n6 = 31/60	n6 = 12/24	H6 = 0/36	H6 = 0/14	220.031	220.060	8.6626	8.6638	400.000	400.036	15.7480	15.7494
6248/7248	240.000	440.000	n6 = 31/60	n6 = 12/24	H6 = 0/40	H6 = 0/16	240.031	240.060	9.4500	9.4512	440.000	440.040	17.3228	17.3244

SECTION 4 - Bearing Tolerances, Fits, & Clearances

FITTING PRACTICE TABLES

RECOMMENDED FITTING PRACTICE FOR DEEP GROOVE & ANGULAR CONTACT BALL BEARINGS(6200/7200 & 6300/7300) Bearing Tolerance Class 0, 6X, & 6 ... *cont'd*

BEARING	SHAFT O.D.	HSG DIA	SHAFT TOLERANCE FIT = MIN/MAX		HOUSING TOLERANCE FIT = MIN/MAX		SHAFT SIZE (mm)		SHAFT SIZE (inches)		HSG SIZE (mm)		HSG SIZE (inches)	
	mm	mm	x 0.001 mm	x 0.0001 in	x 0.001 mm	x 0.0001 in	Min.	Max.	Min.	Max.	Min.	Max.	Min.	Max.
6300/7300	10.000	35.000	js5 = -3/3	js5 = -1.2/1.2	H6 = 0/16	H6 = 0/6.3	9.997	10.003	0.3936	0.3938	35.000	35.016	1.3780	1.3786
6301/7301	12.000	37.000	js5 = -4/4	js5 = -1.6/1.6	H6 = 0/16	H6 = 0/6.3	11.996	12.004	0.4723	0.4726	37.000	37.016	1.4567	1.4573
6302/7302	15.000	42.000	js5 = -4/4	js5 = -1.6/1.6	H6 = 0/16	H6 = 0/6.3	14.996	15.004	0.5904	0.5907	42.000	42.016	1.6535	1.6542
6303/7303	17.000	47.000	js5 = -4/4	js5 = -1.6/1.6	H6 = 0/16	H6 = 0/6.3	16.996	17.004	0.6691	0.6694	47.000	47.016	1.8504	1.8510
6304/7304	20.000	52.000	k5 = 2/11	k5 = 0.8/4.3	H6 = 0/19	H6 = 0/7.5	20.002	20.011	0.7875	0.7878	52.000	52.019	2.0472	2.0480
6305/7305	25.000	62.000	k5 = 2/11	k5 = 0.8/4.3	H6 = 0/19	H6 = 0/7.5	25.002	25.011	0.9843	0.9847	62.000	62.019	2.4409	2.4417
6306/7306	30.000	72.000	k5 = 2/11	k5 = 0.8/4.3	H6 = 0/19	H6 = 0/7.5	30.002	30.011	1.1812	1.1815	72.000	72.019	2.8346	2.8354
6307/7307	35.000	80.000	k5 = 2/13	k5 = 0.8/5	H6 = 0/19	H6 = 0/7.5	35.002	35.013	1.3780	1.3785	80.000	80.019	3.1496	3.1504
6308/7308	40.000	90.000	k5 = 2/13	k5 = 0.8/5	H6 = 0/22	H6 = 0/8.7	40.002	40.013	1.5749	1.5753	90.000	90.022	3.5433	3.5442
6309/7309	45.000	100.000	k5 = 2/13	k5 = 0.8/5	H6 = 0/22	H6 = 0/8.7	45.002	45.013	1.7717	1.7722	100.000	100.022	3.9370	3.9379
6310/7310	50.000	110.000	k5 = 2/13	k5 = 0.8/5	H6 = 0/22	H6 = 0/8.7	50.002	50.013	1.9686	1.9690	110.000	110.022	4.3307	4.3316
6311/7311	55.000	120.000	k5 = 2/15	k5 = 0.8/6	H6 = 0/22	H6 = 0/8.7	55.002	55.015	2.1654	2.1659	120.000	120.022	4.7244	4.7253
6312/7312	60.000	130.000	k5 = 2/15	k5 = 0.8/6	H6 = 0/25	H6 = 0/9.8	60.002	60.015	2.3623	2.3628	130.000	130.025	5.1181	5.1191
6313/7313	65.000	140.000	k5 = 2/15	k5 = 0.8/6	H6 = 0/25	H6 = 0/9.8	65.002	65.015	2.5591	2.5596	140.000	140.025	5.5118	5.5128
6314/7314	70.000	150.000	k5 = 2/15	k5 = 0.8/6	H6 = 0/25	H6 = 0/9.8	70.002	70.015	2.7560	2.7565	150.000	150.025	5.9055	5.9065
6315/7315	75.000	160.000	k5 = 2/15	k5 = 0.8/6	H6 = 0/25	H6 = 0/9.8	75.002	75.015	2.9528	2.9533	160.000	160.025	6.2992	6.3002
6316/7316	80.000	170.000	k5 = 2/15	k5 = 0.8/6	H6 = 0/25	H6 = 0/9.8	80.002	80.015	3.1497	3.1502	170.000	170.025	6.6929	6.6939
6317/7317	85.000	180.000	k5 = 3/18	k5 = 1.2/7	H6 = 0/25	H6 = 0/10	85.003	85.018	3.3466	3.3472	180.000	180.025	7.0866	7.0876
6318/7318	90.000	190.000	k5 = 3/18	k5 = 1.2/7	H6 = 0/29	H6 = 0/11	90.003	90.018	3.5434	3.5440	190.000	190.029	7.4803	7.4815
6319/7319	95.000	200.000	k5 = 3/18	k5 = 1.2/7	H6 = 0/29	H6 = 0/11	95.003	95.018	3.7403	3.7409	200.000	200.029	7.8740	7.8752
6320/7320	100.000	215.000	k5 = 3/18	k5 = 1.2/7	H6 = 0/29	H6 = 0/11	100.003	100.018	3.9371	3.9377	215.000	215.029	8.4646	8.4657
6321/7321	105.000	225.000	m5 = 13/28	m5 = 5/11	H6 = 0/29	H6 = 0/11	105.013	105.028	4.1344	4.1350	225.000	225.029	8.8583	8.8594
6322/7322	110.000	240.000	m5 = 13/28	m5 = 5/11	H6 = 0/29	H6 = 0/11	110.013	110.028	4.3312	4.3318	240.000	240.029	9.4488	9.4500
6324/7324	120.000	260.000	m5 = 13/28	m5 = 5/11	H6 = 0/32	H6 = 0/13	120.013	120.028	4.7249	4.7255	260.000	260.032	10.2362	10.2375
6326/7326	130.000	280.000	m5 = 15/33	m5 = 6/13	H6 = 0/32	H6 = 0/13	130.015	130.033	5.1187	5.1194	280.000	280.032	11.0236	11.0249
6328/7328	140.000	300.000	m5 = 15/33	m5 = 6/13	H6 = 0/32	H6 = 0/13	140.015	140.033	5.5124	5.5131	300.000	300.032	11.8110	11.8123
6330/7330	150.000	320.000	m6 = 15/40	m6 = 6/16	H6 = 0/36	H6 = 0/14	150.015	150.040	5.9061	5.9071	320.000	320.036	12.5984	12.5998
6332/7332	160.000	340.000	m6 = 15/40	m6 = 6/16	H6 = 0/36	H6 = 0/14	160.015	160.040	6.2998	6.3008	340.000	340.036	13.3858	13.3872
6334/7334	170.000	360.000	m6 = 15/40	m6 = 6/16	H6 = 0/36	H6 = 0/14	170.015	170.040	6.6935	6.6945	360.000	360.036	14.1732	14.1746
6336/7336	180.000	380.000	m6 = 15/40	m6 = 6/16	H6 = 0/36	H6 = 0/14	180.015	180.040	7.0872	7.0882	380.000	380.036	14.9606	14.9620
6338/7338	190.000	400.000	m6 = 17/46	m6 = 7/18	H6 = 0/36	H6 = 0/14	190.017	190.046	7.4810	7.4821	400.000	400.036	15.7480	15.7494
6340/7340	200.000	420.000	m6 = 17/46	m6 = 7/18	H6 = 0/40	H6 = 0/16	200.017	200.046	7.8747	7.8758	420.000	420.040	16.5354	16.5370

SECTION 4 - Bearing Tolerances, Fits, & Clearances

FITTING PRACTICE TABLES

The following tables show recommended shaft and housing fitting practice values for ball, cylindrical roller, and tapered roller bearings. The fitting practices shown for ball and cylindrical roller bearings are commonly used for electric motors and most other applications using these single row bearings.

RECOMMENDED FITS FOR CYLINDRICAL ROLLER BEARINGS(NU200 & NU300) Bearing Tolerance Class 0, 6X, & 6

BEARING DESCRIPTION	SHAFT TOLERANCE FIT = MIN/MAX		HOUSING TOLERANCE FIT = MIN/MAX		SHAFT SIZE (mm)		SHAFT SIZE (inches)		HSG SIZE (mm)		HSG SIZE (inches)	
	x 0.001 mm	x 0.0001 in	x 0.001 mm	x 0.0001 in	Min.	Max.	Min.	Max.	Min.	Max.	Min.	Max.
NU304	k5 = 2/11	k5 = 0.8/4.3	H6 = 0/19	H6 = 0/7.5	20.002	20.011	0.7875	0.7878	52.000	52.019	2.0472	2.0480
NU305	k5 = 2/11	k5 = 0.8/4.3	H6 = 0/19	H6 = 0/7.5	25.002	25.011	0.9843	0.9847	62.000	62.019	2.4409	2.4417
NU306	k5 = 2/11	k5 = 0.8/4.3	H6 = 0/19	H6 = 0/7.5	30.002	30.011	1.1812	1.1815	72.000	72.019	2.8346	2.8354
NU307	k5 = 2/13	k5 = 0.8/5	H6 = 0/19	H6 = 0/7.5	35.002	35.013	1.3780	1.3785	80.000	80.019	3.1496	3.1504
NU308	k5 = 2/13	k5 = 0.8/5	H6 = 0/22	H6 = 0/8.7	40.002	40.013	1.5749	1.5753	90.000	90.022	3.5433	3.5442
NU309	m5 = 9/20	m5 = 3.5/8	H6 = 0/22	H6 = 0/8.7	45.009	45.020	1.7720	1.7724	100.000	100.022	3.9370	3.9379
NU310	m5 = 9/20	m5 = 3.5/8	H6 = 0/22	H6 = 0/8.7	50.009	50.020	1.9689	1.9693	110.000	110.022	4.3307	4.3316
NU311	m5 = 11/24	m5 = 4.3/9	H6 = 0/22	H6 = 0/8.7	55.011	55.024	2.1658	2.1663	120.000	120.022	4.7244	4.7253
NU312	m5 = 11/24	m5 = 4.3/9	H6 = 0/25	H6 = 0/9.8	60.011	60.024	2.3626	2.3631	130.000	130.025	5.1181	5.1191
NU313	m5 = 11/24	m5 = 4.3/9	H6 = 0/25	H6 = 0/9.8	65.011	65.024	2.5595	2.5600	140.000	140.025	5.5118	5.5128
NU314	m5 = 11/24	m5 = 4.3/9	H6 = 0/25	H6 = 0/9.8	70.011	70.024	2.7563	2.7569	150.000	150.025	5.9055	5.9065
NU315	m5 = 11/24	m5 = 4.3/9	H6 = 0/25	H6 = 0/9.8	75.011	75.024	2.9532	2.9537	160.000	160.025	6.2992	6.3002
NU316	m5 = 11/24	m5 = 4.3/9	H6 = 0/25	H6 = 0/9.8	80.011	80.024	3.1500	3.1506	170.000	170.025	6.6929	6.6939
NU317	m5 = 13/28	m5 = 5/11	H6 = 0/25	H6 = 0/9.8	85.013	85.028	3.3470	3.3476	180.000	180.025	7.0866	7.0876
NU318	m5 = 13/28	m5 = 5/11	H6 = 0/29	H6 = 0/11.4	90.013	90.028	3.5438	3.5444	190.000	190.029	7.4803	7.4815
NU319	m5 = 13/28	m5 = 5/11	H6 = 0/29	H6 = 0/11.4	95.013	95.028	3.7407	3.7413	200.000	200.029	7.8740	7.8752
NU320	m5 = 13/28	m5 = 5/11	H6 = 0/29	H6 = 0/11.4	100.013	100.028	3.9375	3.9381	215.000	215.029	8.4646	8.4657
NU321	m6 = 13/35	m6 = 5/14	H6 = 0/29	H6 = 0/11.4	105.013	105.035	4.1344	4.1352	225.000	225.029	8.8583	8.8594
NU322	m6 = 13/35	m6 = 5/14	H6 = 0/29	H6 = 0/11.4	110.013	110.035	4.3312	4.3321	240.000	240.029	9.4488	9.4500
NU324	m6 = 13/35	m6 = 5/14	H6 = 0/32	H6 = 0/12.6	120.013	120.035	4.7249	4.7258	260.000	260.032	10.2362	10.2375
NU326	m6 = 15/40	m6 = 6/16	H6 = 0/32	H6 = 0/12.6	130.015	130.040	5.1187	5.1197	280.000	280.032	11.0236	11.0249
NU328	m6 = 15/40	m6 = 6/16	H6 = 0/32	H6 = 0/12.6	140.015	140.040	5.5124	5.5134	300.000	300.032	11.8110	11.8123
NU330	n6 = 27/52	n6 = 11/20	H6 = 0/36	H6 = 0/14.2	150.027	150.052	5.9066	5.9076	320.000	320.036	12.5984	12.5998
NU332	n6 = 27/52	n6 = 11/20	H6 = 0/36	H6 = 0/14.2	160.027	160.052	6.3003	6.3013	340.000	340.036	13.3858	13.3872
NU334	n6 = 27/52	n6 = 11/20	H6 = 0/36	H6 = 0/14.2	170.027	170.052	6.6940	6.6950	360.000	360.036	14.1732	14.1746
NU336	n6 = 27/52	n6 = 11/20	H6 = 0/36	H6 = 0/14.2	180.027	180.052	7.0877	7.0887	380.000	380.036	14.9606	14.9620
NU338	n6 = 31/60	n6 = 12/24	H6 = 0/36	H6 = 0/14.2	190.031	190.060	7.4815	7.4827	400.000	400.036	15.7480	15.7494
NU340	n6 = 31/60	n6 = 12/24	H6 = 0/40	H6 = 0/15.7	200.031	200.060	7.8752	7.8764	420.000	420.040	16.5354	16.5370
NU344	p6 = 50/79	p6 = 20/31	H6 = 0/40	H6 = 0/15.7	220.050	220.079	8.6634	8.6645	460.000	460.040	18.1102	18.1118
NU348	p6 = 50/79	p6 = 20/31	H6 = 0/40	H6 = 0/15.7	240.050	240.079	9.4508	9.4519	500.000	500.040	19.6850	19.6866

SECTION 4 - Bearing Tolerances, Fits, & Clearances

FITTING PRACTICE TABLES

RECOMMENDED FITS FOR CYLINDRICAL ROLLER BEARINGS(NU200 & NU300) Bearing Tolerance Class 0, 6X, & 6 ... *cont'd*

BEARING DESCRIPTION	SHAFT TOLERANCE FIT = MIN/MAX		HOUSING TOLERANCE FIT = MIN/MAX		SHAFT SIZE (mm)		SHAFT SIZE (inches)		HSG SIZE (mm)		HSG SIZE (inches)	
	x 0.001 mm	x 0.0001 in	x 0.001 mm	x 0.0001 in	Min.	Max.	Min.	Max.	Min.	Max.	Min.	Max.
NU204	k5 = 2/11	k5 = 0.8/4.3	H6 = 0/16	H6 = 0/6.3	20.002	20.011	0.7875	0.7878	47.000	47.016	1.8504	1.8510
NU205	k5 = 2/11	k5 = 0.8/4.3	H6 = 0/19	H6 = 0/7.5	25.002	25.011	0.9843	0.9847	52.000	52.019	2.0472	2.0480
NU206	k5 = 2/11	k5 = 0.8/4.3	H6 = 0/19	H6 = 0/7.5	30.002	30.011	1.1812	1.1815	62.000	62.019	2.4409	2.4417
NU207	k5 = 2/13	k5 = 0.8/5	H6 = 0/19	H6 = 0/7.5	35.002	35.013	1.3780	1.3785	72.000	72.019	2.8346	2.8354
NU208	k5 = 2/13	k5 = 0.8/5	H6 = 0/19	H6 = 0/7.5	40.002	40.013	1.5749	1.5753	80.000	80.019	3.1496	3.1504
NU209	m5 = 9/20	m5 = 3.5/8	H6 = 0/22	H6 = 0/8.7	45.009	45.020	1.7720	1.7724	85.000	85.022	3.3465	3.3473
NU210	m5 = 9/20	m5 = 3.5/8	H6 = 0/22	H6 = 0/8.7	50.009	50.020	1.9689	1.9693	90.000	90.022	3.5433	3.5442
NU211	m5 = 11/24	m5 = 4.3/9	H6 = 0/22	H6 = 0/8.7	55.011	55.024	2.1658	2.1663	100.000	100.022	3.9370	3.9379
NU212	m5 = 11/24	m5 = 4.3/9	H6 = 0/22	H6 = 0/8.7	60.011	60.024	2.3626	2.3631	110.000	110.022	4.3307	4.3316
NU213	m5 = 11/24	m5 = 4.3/9	H6 = 0/22	H6 = 0/8.7	65.011	65.024	2.5595	2.5600	120.000	120.022	4.7244	4.7253
NU214	m5 = 11/24	m5 = 4.3/9	H6 = 0/25	H6 = 0/9.8	70.011	70.024	2.7563	2.7569	125.000	125.025	4.9213	4.9222
NU215	m5 = 11/24	m5 = 4.3/9	H6 = 0/25	H6 = 0/9.8	75.011	75.024	2.9532	2.9537	130.000	130.025	5.1181	5.1191
NU216	m5 = 11/24	m5 = 4.3/9	H6 = 0/25	H6 = 0/9.8	80.011	80.024	3.1500	3.1506	140.000	140.025	5.5118	5.5128
NU217	m5 = 13/28	m5 = 5/11	H6 = 0/25	H6 = 0/9.8	85.013	85.028	3.3470	3.3476	150.000	150.025	5.9055	5.9065
NU218	m5 = 13/28	m5 = 5/11	H6 = 0/25	H6 = 0/9.8	90.013	90.028	3.5438	3.5444	160.000	160.025	6.2992	6.3002
NU219	m5 = 13/28	m5 = 5/11	H6 = 0/25	H6 = 0/9.8	95.013	95.028	3.7407	3.7413	170.000	170.025	6.6929	6.6939
NU220	m5 = 13/28	m5 = 5/11	H6 = 0/25	H6 = 0/9.8	100.013	100.028	3.9375	3.9381	180.000	180.025	7.0866	7.0876
NU221	m6 = 13/35	m6 = 5/14	H6 = 0/29	H6 = 0/11.4	105.013	105.035	4.1344	4.1352	190.000	190.029	7.4803	7.4815
NU222	m6 = 13/35	m6 = 5/14	H6 = 0/29	H6 = 0/11.4	110.013	110.035	4.3312	4.3321	200.000	200.029	7.8740	7.8752
NU224	m6 = 13/35	m6 = 5/14	H6 = 0/29	H6 = 0/11.4	120.013	120.035	4.7249	4.7258	215.000	215.029	8.4646	8.4657
NU226	m6 = 15/40	m6 = 6/16	H6 = 0/29	H6 = 0/11.4	130.015	130.040	5.1187	5.1197	230.000	230.029	9.0551	9.0563
NU228	m6 = 15/40	m6 = 6/16	H6 = 0/29	H6 = 0/11.4	140.015	140.040	5.5124	5.5134	250.000	250.029	9.8425	9.8437
NU230	n6 = 27/52	n6 = 11/20	H6 = 0/32	H6 = 0/12.6	150.027	150.052	5.9066	5.9076	270.000	270.032	10.6299	10.6312
NU232	n6 = 27/52	n6 = 11/20	H6 = 0/32	H6 = 0/12.6	160.027	160.052	6.3003	6.3013	290.000	290.032	11.4173	11.4186
NU234	n6 = 27/52	n6 = 11/20	H6 = 0/32	H6 = 0/12.6	170.027	170.052	6.6940	6.6950	310.000	310.032	12.2047	12.2060
NU236	n6 = 27/52	n6 = 11/20	H6 = 0/36	H6 = 0/14.2	180.027	180.052	7.0877	7.0887	320.000	320.036	12.5984	12.5998
NU238	n6 = 31/60	n6 = 12/24	H6 = 0/36	H6 = 0/14.2	190.031	190.060	7.4815	7.4827	340.000	340.036	13.3858	13.3872
NU240	n6 = 31/60	n6 = 12/24	H6 = 0/36	H6 = 0/14.2	200.031	200.060	7.8752	7.8764	360.000	360.036	14.1732	14.1746
NU244	p6 = 50/79	p6 = 20/31	H6 = 0/36	H6 = 0/14.2	220.050	220.079	8.6634	8.6645	400.000	400.036	15.7480	15.7494
NU248	p6 = 50/79	p6 = 20/31	H6 = 0/40	H6 = 0/15.7	240.050	240.079	9.4508	9.4519	440.000	440.040	17.3228	17.3244
NU252	p6 = 56/88	p6 = 22/35	H6 = 0/40	H6 = 0/15.7	260.056	260.088	10.2384	10.2397	480.000	480.040	18.8976	18.8992
NU256	p6 = 56/88	p6 = 22/35	H6 = 0/40	H6 = 0/15.7	280.056	280.088	11.0258	11.0271	500.000	500.040	19.6850	19.6866

SECTION 4 - Bearing Tolerances, Fits, & Clearances

RADIAL CLEARANCE

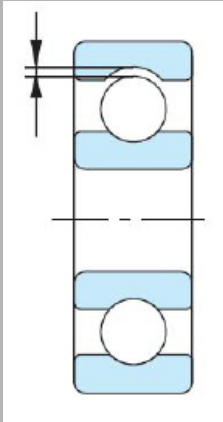

AXIAL CLEARANCE

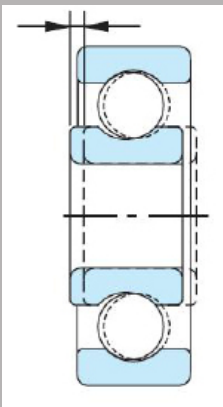

BEARING INTERNAL CLEARANCES AND PRELOADING

Selecting the correct bearing internal clearance and determining whether preload is needed for a particular application is critical to obtaining the desired bearing performance.

DESCRIPTION OF INTERNAL CLEARANCES

Bearing internal clearance is described as being either radial or axial and is the total distance that either the inner or outer ring can be moved in the radial or axial direction while the other ring is held stationary.

With only a few exceptions, bearing internal clearance is normally discussed in terms of radial clearance. Matched pairs of angular contact ball bearings are specified in terms of axial internal clearance. Also, when two single row tapered roller bearings are setup opposing each other, the clearance value between the rows is an axial measurement.

Clearance prior to mounting is generally referred to as the original clearance. This initial clearance value is what is provided in the bearing at the time of shipment. These clearance values are listed in the KOYO/JTEKT table of clearance specifications in the Ball and Roller Bearing catalog.

After the bearing is fitted on a shaft and into housing, the original clearance is reduced due to contraction or expansion of the rings and is called the “residual clearance” or mounted clearance. “Effective clearance” is the residual clearance after taking into account changes from temperature differentials within the bearing. “Operating clearance” is defined as the effective clearance with the additional effect of elastic deformations from application loading.

Successful bearing performance depends on having the appropriate “operating clearance” to avoid premature bearing damage and reduced fatigue life. As illustrated in the chart on page 55, bearing fatigue life is optimized when the operating clearance is slightly negative.

SECTION 4 - Bearing Tolerances, Fits, & Clearances

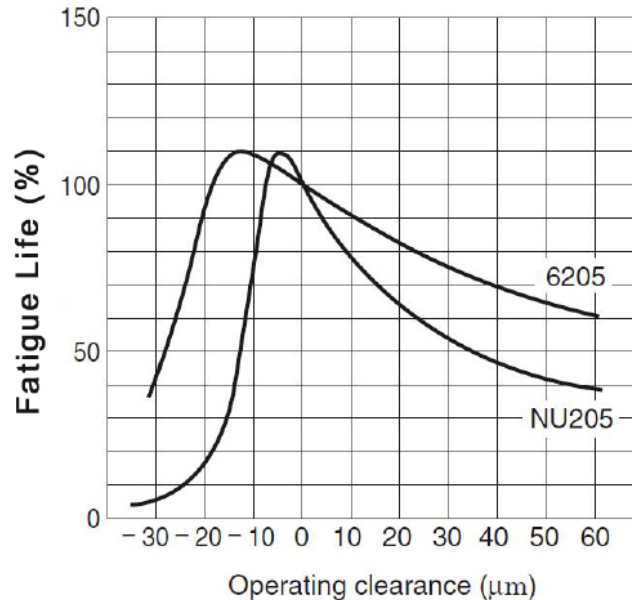

However, if the operating clearance is reduced much beyond this slight negative clearance setting, fatigue life is significantly reduced. Consequently, it is suggested that the initial bearing internal clearance be selected to give an operating clearance that is slightly positive to avoid the possibility of a drastic fatigue life reduction. Equations for determining fit and temperature effects on the original bearing clearance and the resultant operating clearance are covered in KOYO's Ball and Roller Bearing catalog.

BEARING PRELOAD

In general, bearings are operated with a certain amount of clearance. However, there are applications where bearings are mounted with enough of an axial load that will give a negative clearance setting. This axial load is referred to as "preload" and is often used with tapered roller and angular contact ball bearings.

Some of the typical reasons for using bearing preload are as follows:

- To improve running accuracy and precision by eliminating clearances and reducing deflections.
- Improved bearing stiffness and shaft rigidity provides for an accurate gear mesh.
- Reduces possibility of bearing slippage and smearing on applications with high rate of acceleration speed.
- Helps to minimize noise due to vibrations.
- Used to prevent a bearing from spinning freely (cage damage likely) with a single direction high axial load.

Bearing preload can be applied by proper axial positioning of bearing rings. This can be accomplished by using various axial locating devices such as adjusting nuts, bolts, and spacers ground to give a preload setting between rows of bearings. This method is referred to as "position preloading" or fixed preloading. This method will allow the use of larger preload values and result in high rigidity.

SECTION 4 - Bearing Tolerances, Fits, & Clearances

BEARING INTERNAL CLEARANCES AND PRELOADING ...cont'd

Another method for preloading is to use a spring design or “constant pressure preload”. This method will provide a constant preload force and allow for minor load fluctuations and provide some thermal compensation for temperature differences between the shaft and housing. This method is suitable on high speed applications and where vibrations may be a problem. This method should not be used where high rigidity and a loose fitted bearing ring can not be accommodated.

The illustrations below show the “position preload” and “constant preload” methods for preloading bearings:

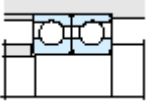
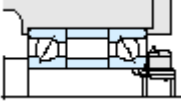
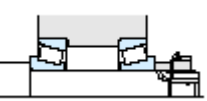
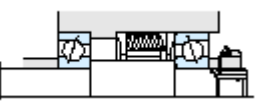
Position preloading			Constant pressure preloading
			
Method using matched pair bearing with stand-out adjusted for preloading (see below).	Method using spacer with dimensions adjusted for preloading.	Method using nut or bolt capable of adjusting preload in axial direction. In this case, starting friction moment during adjustment should be measured so that proper preload will be applied.	Method using coil spring or diaphragm spring.

The amount of preload needs to be determined to avoid possible adverse effects on bearing performance and fatigue life. When determining the amount of preload force to be used the following bearing and application effects should be considered:

- Rigidity requirements
- Accuracy and precision needs
- Bearing torque and horsepower consumption increases
- Operating temperature increases and lubrication requirements for cooling
- Mounting design requirements

Since the desirable effects of an increase in rigidity and accuracy are obtained with preloaded bearings, the majority of preloaded bearings are being used on machine tool spindle applications. Consequently, the angular contact ball bearings normally supplied for these machine tool spindles are JIS precision class 5 or higher. KOYO/JTEKT offers four preload classes of matched pair angular contact ball bearings. A slight preload (S), light preload (L), medium preload (M), and a heavy preload (H) can be selected. With these precision preloaded bearing assemblies, shaft and housing fitting practice needs to be adjusted.

Tables for angular contact ball bearing preload values and recommended fitting practice can be found in the KOYO Ball and Roller Bearing catalog.

NOTES

A large grid area for taking notes, with a faint 'Koyo' watermark in the center.

SECTION 4 - Bearing Tolerances, Fits, & Clearances

NOTES

Koyo

NOTES

A large grid area for taking notes, with a faint 'Koyo' watermark in the center.

SECTION 5 - Bearing Storage, Handling & Cleaning



These bearings have been turned upright and is a **DON'T!**

The bearing stored on its side will have its weight distributed on all the rolling elements and not just a few!



DO store bearings on a pallet, which is definitely a better choice than directly on the floor with no protection from moisture and vibrations from machinery.



BEARING STORAGE PRECAUTIONS

Prior to shipping, bearings are coated with a preservative oil film to protect against corrosion and then wrapped in an anti-tarnish paper. The bearing is guaranteed to be free of rust and corrosion as long as the original wrapping paper has not been damaged or torn. Some additional bearing storage tips and precautions to keep in mind are as follows:

- Bearings should be stored at a room temperature of 20°C/70° F and relative humidity levels of less than 65%
- Bearings should be placed on a shelf at least 30cm/12" off the floor
- Bearing boxes should not be stored upright but placed flat on a shelf
- Bearings should not be stored where vibrations and movement from other machinery is possible
- Bearings should not be stored near a window where direct sun and moisture could be a problem

Shown to the left are examples of some storage Do's & Don'ts:

Under ideal storage conditions, and assuming the packaging remains intact, bearings can be successfully stored for several years.

BEARING HANDLING PRECAUTIONS

Bearings which are properly handled are capable of dependable performance under a variety of operating conditions. However, like other precision machine components, they can be damaged by improper handling procedures. The following are general precautions for proper bearing handling:

- Keep the bearing and assembly area clean, even very small particles of dirt can cause bearing contamination and result in bearing damage and a reduction in bearing life.
- Avoid abusing the bearings; they are precision ground and heat treated. If a bearing is dropped or subjected to impacts or excessive force due to rough handling, they can be cracked or Brinelled before they are mounted resulting in a point of origin for premature damage and failure.

SECTION 5 - Bearing Storage, Handling & Cleaning

- Do not expose the bearings to high temperatures since a standard bearing can be tempered if they are heated to temperatures over 120 °C (250° F), which could result in a reduction in hardness and bearing life.
- The proper tools need to be used for handling. Using whatever tool is at hand could result in bearing damage.
- The bearing and assembly area should be well protected from dampness and moisture to avoid the possibility of bearing corrosion.
- The bearings should only be handled by experienced or well trained operators.

The photo on the top shows a Brinelled bearing raceway, while the bottom image shows subsequent flaking damage all the result of improper handling.

Being careful and following the above handling precautions will go a long way to ensuring the bearing will provide their expected service life.

BEARING CLEANING METHODS

Just like improper storage and handling of bearings can cause damage and a reduction in bearing service life, improper cleaning of bearings, when it is required, can result in premature bearing failure. The following methods and precautions should be used:

- Bearings should not be unwrapped until they are ready for installation or cleaning.
- Normally, the bearing can be installed without removing the film of rust preventative applied prior to shipping since it is compatible with most commonly used lubricants.
- For bearings to be used with high speed oil lubrication or when the grease and rust preventative would result in a loss of lubrication effectiveness, the rust preventative should be cleaned off.
- Bearings should also be washed and dried before installation if the packaging has been damaged or there is a chance the bearing has been contaminated.



SECTION 5 - Bearing Storage, Handling & Cleaning

BEARING CLEANING METHODS ... *cont'd*

- Bearings should be cleaned by washing with a clean solvent made of neutral water-free mineral with a low viscosity.
- Never use the same solvent for the initial cleaning and final rinsing of the bearing .
- Always wipe bearings off with a clean lint free rag.
- If bearings need to be set down while cleaning, they should be placed on clean dry paper.
- Latex, plastic or lint-free gloves should be worn at all times when handling bearings. Not doing so could result in corrosion caused by sweat from your hands.
- If necessary, the outside surfaces of a sealed and shielded bearings can be wiped with a clean solvent free rag, but should never be washed.

After a bearing has been properly cleaned and dried it is now ready to be mounted and installed into its application. Bearing mounting precautions and preparations will be covered in section 6.

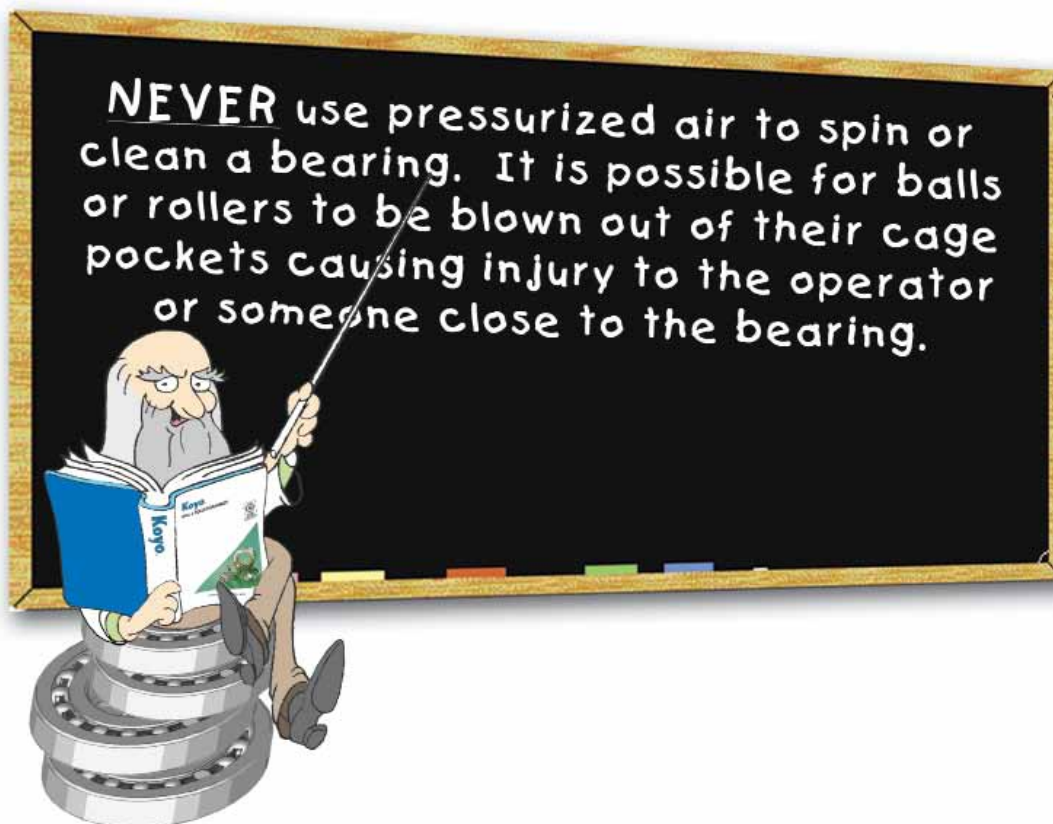

NOTES

A large grid area for taking notes, with a faint 'Koyo' watermark in the center.

SECTION 6 - Bearing Mounting & Removal

BEARING MOUNTING PREPARATIONS AND PRECAUTIONS

Just like the precautions and preparations needed for getting a bearing ready for installation, there are a number of considerations for making sure the shaft and housing of the application are ready for bearing installation. Some of the suggested preparations are covered below:

- A bearing should be installed shortly after it has been washed and cleaned to minimize the possibility of corrosion on any of the surfaces.
- All required bearing mounting tools and jigs should be assembled and cleaned prior to installation.
- The shaft and housing should be cleaned and checked for flaws or burrs from machining. Care should be exercised to completely remove lapping agents, casting sands, and chips from inside the housing.
- The shaft and housing dimensions should be checked for accuracy.
- The shaft diameter and housing bore seat dimensions should be checked for size, roundness, and taper at several different locations along their lengths.
- The fillet radius and squareness of the shaft and housing backing shoulders should be checked.
- After the shaft and housing have passed inspections, it is recommended that a light coating of machine oil or grease be applied prior mounting the bearings.
- The bearings are now ready mounting onto the shaft and into the housing.

SECTION 6 - Bearing Mounting & Removal

MOUNTING METHODS FOR CYLINDRICAL BORE BEARINGS

Mounting and installation of a bearing depends on the type and its fitting practice. The procedures covered are concerned with the proper methods and tools to accomplish installation of pressed fitted bearing rings. Even though some of the tools and procedures used for mounting a non-separable bearing are the same as those used for separable bearings, the methods covered here are specifically for non-separable bearings.

There are three different basic types of bearing mounting methods:

- 1. Cold Mounting** - Involves the use of a press & fixtures, nuts & bolts, and as a last resort an inner ring fixture & dead-blow hammer. This method is mainly used for small cylindrical bore bearings which do not require a heavy press fit.
- 2. Temperature Control** – This method involves heating the bearing rings to expand them by means of oil, a hot plate, oven, or an induction heater. Normally used for large cylindrical bore bearings requiring a heavy shrink fit, but is suitable for use with any size of bearing.
- 3. Hydraulic Pressure** – Pressurized oil is injected between the bearing bore and shaft to lessen the friction and reduce the force required for mounting. This method is normally used for installation of tapered bore bearings.

When a bearing with an interference fitted inner ring is to be cold mounted or removed from a shaft, it is beneficial to know the amount of force needed to overcome the fit. The amount of force necessary to press the bearing on or remove it, will be dependent on factors such as the interference fit, whether it is a solid or hollow shaft, the surface finishes of the components and if the shaft is cylindrical or tapered. The equations for calculating this force are given in the “Handling of Bearings” section of KOYO’s Ball and Roller Bearing catalog.

As shown in the figures to the right, bearing should be mounted slowly with care, by using a fixture to apply force evenly to the bearing.

When mounting the inner ring, apply pressure to the inner ring only. Similarly, in mounting the outer ring, press only the outer ring. If force is applied across the bearing as shown in the bottom figure, Brinelling can occur resulting in a reduction of bearing life.

Mounting methods

(a) Using press fit
(the most widely used method)

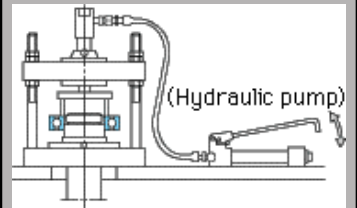

(b) Using bolts and nuts
(screw hole should be provided at the shaft end)

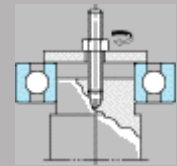

(c) Using hammers
(only when there is no alternative measure)

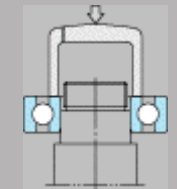

(Inner ring press fit)

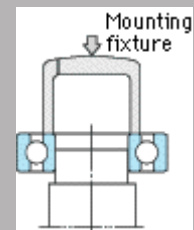

(Outer ring press fit)

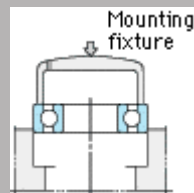

(Inner ring press fit)

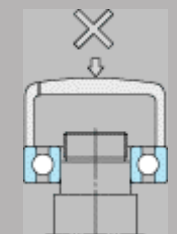



SECTION 6 - Bearing Mounting & Removal

BEARING MOUNTING METHODS ... *cont'd*

TEMPERATURE CONTROLLED MOUNTING METHODS FOR SHRINK FITTED BEARINGS

The temperature control method of obtaining an interference fit can be used for any bearing size and both straight bore and tapered bore. This method can mean heating only one part, cooling one part, or simultaneously heating one part and cooling the other part.

Shrink fit	Descriptions
<p>(a) Heating in an oil bath</p>  <p>Thermometer</p>	<p>This method, which expands bearings by heating them in oil, has the advantage of not applying too much force to bearings and taking only a short time.</p> <p>Oil temperature should not be higher than 100° C (210° F), Bearings heated at higher than 120° C (250° F) lose hardness.</p> <p>Heating temperature can be determined from the bore diameter of a bearing and the interference by referring to the chart on the following page</p>
<p>(b) Induction heater</p> 	<p>Nets or a lifting device prevent the bearing from resting directly on the bottom of the oil container.</p> <p>Since bearings shrink in the radial direction as well as the axial direction while cooling down, fix the inner ring and shaft shoulder tightly with the shaft nut before shrinking, so that no space is left between them.</p> <p>For cylindrical roller bearings used in roll necks of rolling mills and railway rolling stock axle journals, where rings are frequently mounted and dismantled, it is advisable to use Koyo special induction heaters (with automatic demagnetizers).</p>

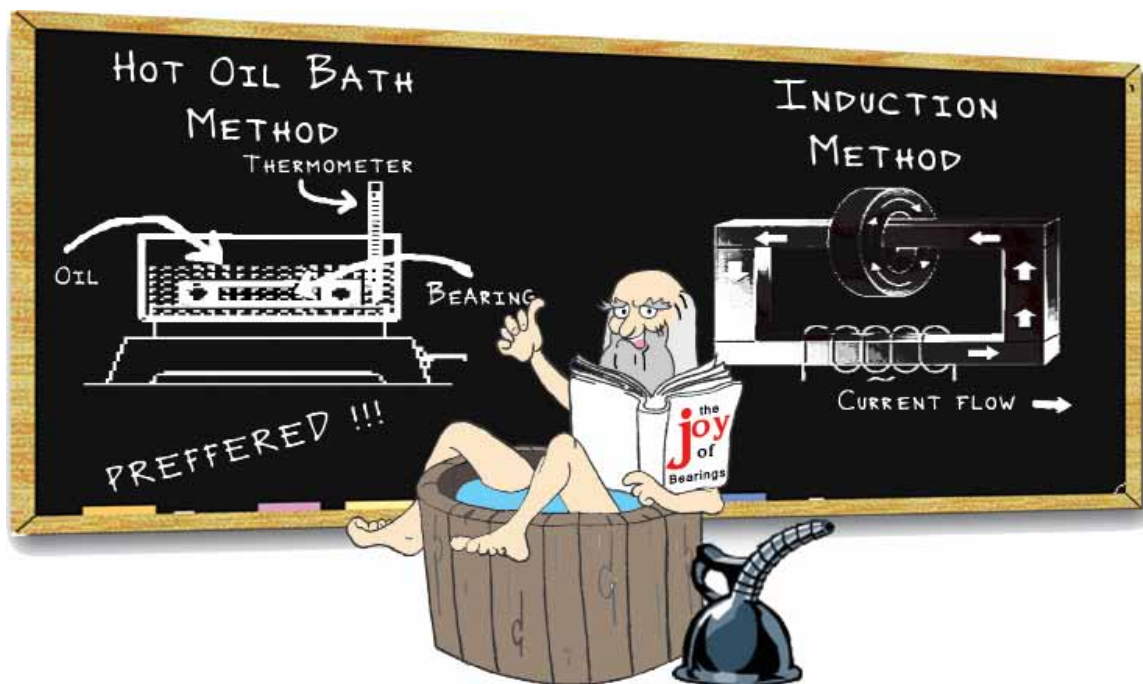

SECTION 6 - Bearing Mounting & Removal

BEARING MOUNTING METHODS... *cont'd*

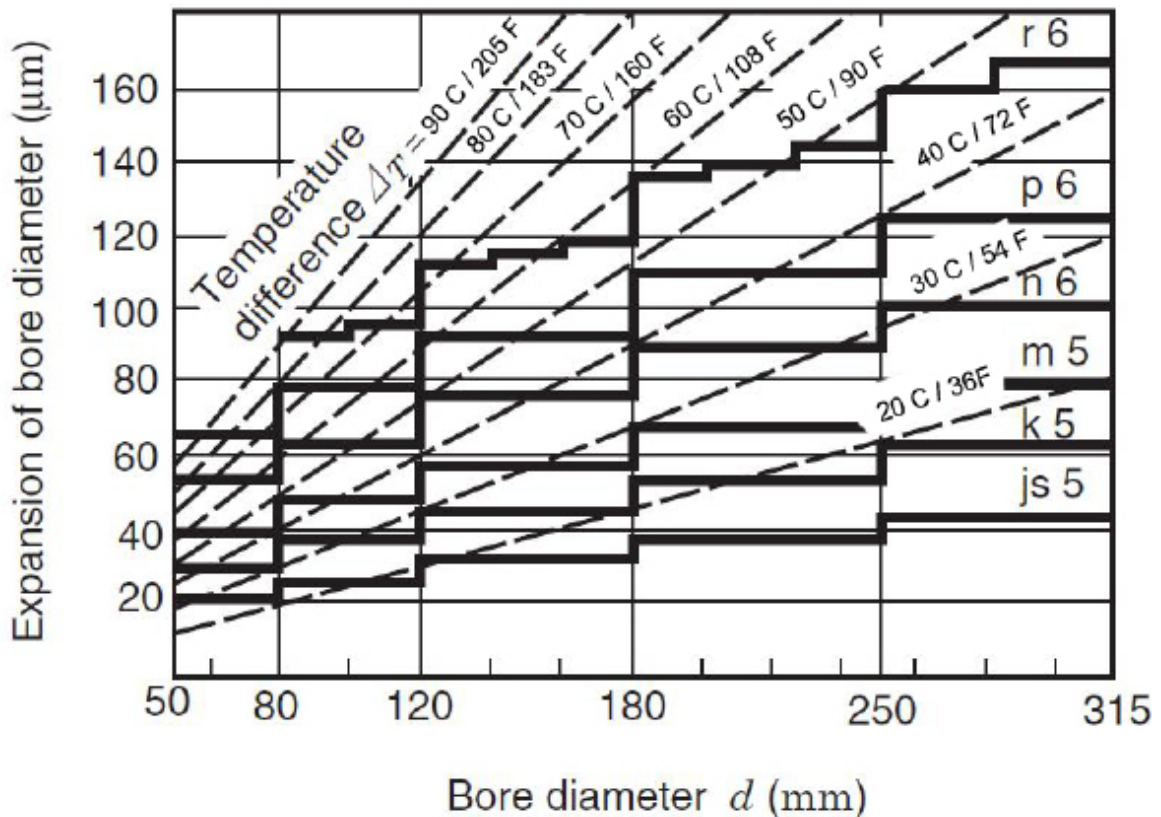

Heating temperatures needed for expansion of inner rings

1. Thick solid lines show the maximum interference value between bearings (class 0) and shafts (r6,p6,n6,m5,k5,js5) at normal temperature.
2. Therefore, the heating temperature should be selected to gain a larger "expansion of the bore diameter" than the maximum interference values.

When fitting class 0 bearings having a 90mm bore diameter to m5 shafts, this figure shows that heating temperature should be 40° C (70° F) higher than room temperature to produce expansion larger than the maximum interference value of 48 µm (0-0019"). However, taking cooling during mounting into consideration, the temperature should be set 20° C (35° F) to 30° C (55° F) higher than the temperature initially required.

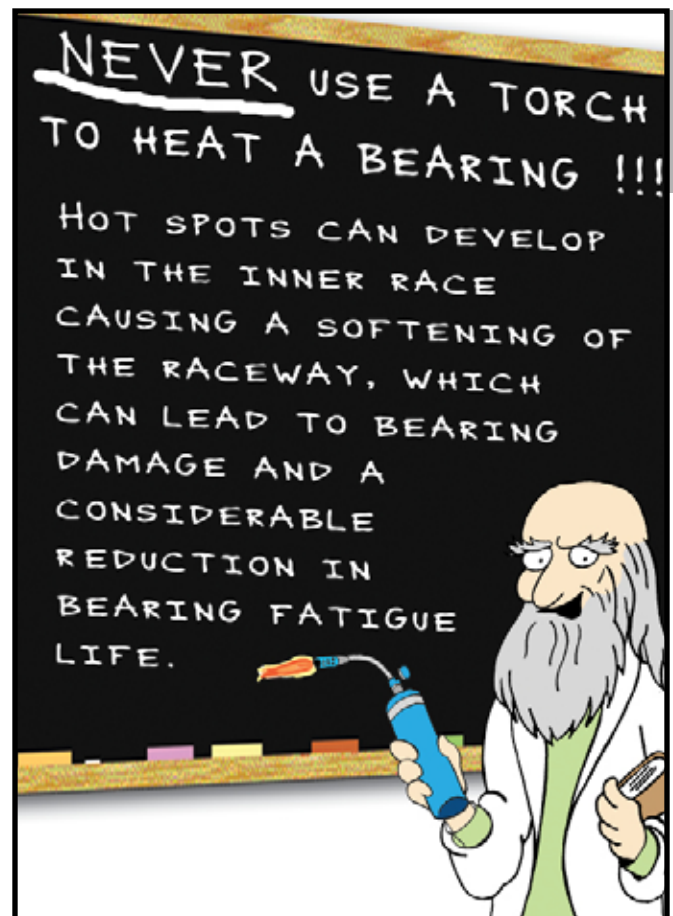

SECTION 6 - Bearing Mounting & Removal

MOUNTING PROCEDURE FOR TAPERED ROLLER BEARINGS

Even though the methods used for installing and heating press fitted rings are essentially the same for separable and non-separable bearings; there are precautions and methods that should be used for proper assembly, seating of the rollers, and obtaining the desired mounted axial clearance or preload unique to tapered roller bearing arrangements. The following suggested procedure assumes the use of two adjustable single row bearings or an adjustable two row assembly and not a pre-set spacer assembly:

1. SETTING DETERMINATION (AXIAL CLEARANCE OR PRELOAD?) – As covered in the Internal Clearance & Preload topic in Section 4, it is critical to determine the proper initial bearing clearance or preload required for an application. If replacement bearings are being installed in an existing application, normally the determination for setting is made by the equipment manufacturer and when replacing these bearings, the OEM guidelines should be followed. Otherwise, consideration needs to be given to the applications mounting design, loading, speeds, temperatures, lubrication type, and how the initial bearing setting will be effected and the resulting operating clearance or preload.

2. PRE-INSTALLATION PRECAUTIONS – Prior to mounting the cone assembly in a grease lubricated application, it is important to be sure that the grease is properly packed in the assembly. Grease needs to be applied between the rollers and the cage and not just on the outside of these parts. Grease should be forced between the rollers from the large end to the small end. A small amount of the excess grease can be smeared on the outside of the rollers.

3. INSTALL CONE ASSEMBLY AND CUP – Reference should be made to "MOUNTING METHODS FOR CYLINDRICAL BORE BEARINGS" portion of this section for suggested tools and methods. In general small bearing cones and cups can be pressed or driven on shafts or into housings. For larger bearings and heavy press fits, the cone assembly should be heated and cups cooled to ease installation. With any method used, care should be used to assure the cone or cup is solidly seated against the shoulders. It is recommended that after the part has been pressed on and has cooled, a thickness gauge be used to make sure it is properly positioned against the shoulder. The thickness gauge should not fit between the bearing face and shaft shoulder. If it does, the bearing needs to be pressed up the shaft until it contacts the shoulder. If it is noticed that the bearing is touching the shoulder in some places but not in others, this is a clear indication of an un-square shoulder that needs to be fixed.

4. BEARING ADJUSTMENT AND SETTING – There a number of methods for properly adjusting tapered roller bearings, but the most common are with a threaded shaft and adjusting nut or a housing with a cup follower/carrier and shims. If a nut is being used, the suggested procedure is to tighten the nut while rotating the bearings until there is some rotational resistance. This will confirm the proper seating of the rollers against the cone rib. If axial clearance is required, the nut is backed off and the bearings are rotated to assure clearance is present. If the bearings are to be preloaded, the nut is advanced while the bearings are rotated until the recommended tightening torque is reached. The adjusting nut should then be locked in place until the dimensional settings are confirmed.

SECTION 6 - Bearing Mounting & Removal

MOUNTING PROCEDURE FOR TAPERED ROLLER BEARINGS... *cont'd*

If a cup follower /carrier or end plate with shims is being used for adjustment, the plate or cup follower should be tightened without the shims in place until the bearings slightly resist rotation. The gap between the follower/end plate and the housing should be measured with a feeler gauge or dial indicator. The measured gap plus the required axial clearance will determine the total of the shims to be used. If preload is needed, the desired dimensional value is subtracted from the gap measurement.

5. BEARING SETTING CONFIRMATION – After tapered roller bearings have been setup, it is recommended that an additional measurement be performed to confirm the appropriate setting has been achieved. For preload confirmation, it is recommended that a spring scale with a string attached be wrapped around the shaft or gear and pulled at a slow and steady rate. The force reading on the scale should be multiplied by the radius of the shaft or gear to determine the bearing torque. Of course, if rubbing seals are being used, their torque values should be determined prior to bearing assembly and deducted from the spring scale reading. This rolling torque value can be converted to an equivalent dimensional preload value or preload force.

If the bearings are to have a specific axial clearance setting, it is necessary to check the axial movement of the shaft which indicates the amount of axial clearance in the bearings. To accomplish this procedure, a dial indicator should be mounted against the end of the shaft to measure axial movement. The shaft should be loaded in one direction and oscillated a number of times in each direction while the load is applied to get an accurate measurement, the indicator should be then be set to 0. The load should then be reversed and the shaft oscillated again for an axial movement reading and bearing clearance measurement.

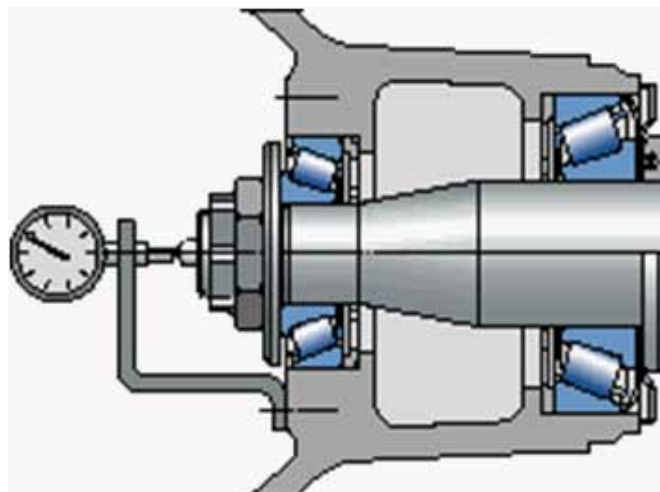





SECTION 6 - Bearing Mounting & Removal

INSTALLATION PROCEDURES FOR TAPERED BORE BEARINGS

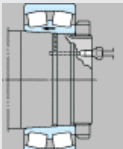
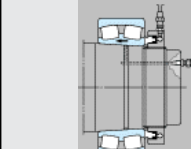
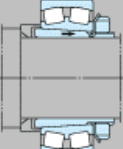
Tapered bore bearings can be mounted directly on a tapered shaft, a tapered adapter, or a tapered withdrawal sleeve. Before mounting a tapered bore bearing, it is important to measure the tapered shaft. This is normally done with a ring gauge or sine bar gauge. To be sure a tapered bore bearing achieves its predicted service life; it is necessary to assure tapered shafts are sized properly and meet the required geometry and tolerance specifications.

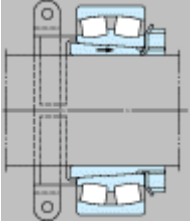
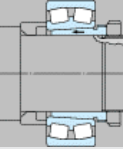
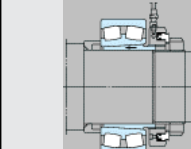
The majority of tapered bore mounting procedures use hydraulic assistance to simplify the assembly. To accomplish hydraulic assisted assembly, the shaft has to be designed with an oil groove on the outside diameter and an oil inlet line from the end of the shaft. Additional hydraulic assistance can be obtained through the use of a hydraulic nut designed to allow the use of oil pressure for moving the bearing through the taper. These mounting procedures and tools are covered below:

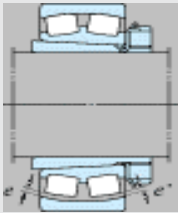
Mounting methods	Descriptions
<p>(a) Mounting on tapered shafts</p> <div style="display: flex; justify-content: space-around;"> <div style="text-align: center;">  <p>[1] Locknut</p> </div> <div style="text-align: center;">  <p>[2] Hydraulic nut</p> </div> </div>	<p>When mounting bearings directly on tapered shafts, provide oil holes and grooves on the shaft and inject high-pressure oil into the space between the fitting surfaces (oil injection). Such oil injection can reduce tightening torque of locknut by lessening friction between the fitting surfaces.</p> <p>When exact positioning is required in mounting a bearing on a shaft with no shoulder, use a clamp to help determine the position of the bearing.</p>
<p>(b) Mounting by use of an adapter sleeve</p> <div style="display: flex; justify-content: space-around;"> <div style="text-align: center;">  <p>[1] Locknut</p> </div> <div style="text-align: center;">  <p>[2] Hydraulic nut</p> </div> </div>	<div style="text-align: center;">  <p>(Locating bearing by use of a clamp)</p> </div> <p>When mounting bearings on shafts, locknuts are generally used. Special spanner wrenches are used to tighten them. Bearings can also be mounted using hydraulic nuts.</p>
<p>(c) Mounting by use of a withdrawal sleeve</p> <div style="display: flex; justify-content: space-around;"> <div style="text-align: center;">  <p>[1] Locknut</p> </div> <div style="text-align: center;">  <p>[2] Hydraulic nut</p> </div> </div>	<div style="text-align: center;">  </div> <p>When mounting tapered bore spherical roller bearings, the reduction in the radial internal clearance which gradually occurs during operation should be taken into consideration as well as the push-in depth described in the chart on the following page.</p>
<p>(d) Measuring clearances</p> <div style="text-align: center;">  </div>	<p>Clearance reduction can be measured by a feeler gauge. First, stabilize the roller in the proper position and then insert the gauge into the space between the rollers and the outer ring. Be careful that the clearance between both roller rows and the outer rings is roughly the same (e e'). Since the clearance may differ at different measuring points, take measurements at several positions.</p> <p>When mounting self-aligning ball bearings, leave enough clearance to allow easy aligning of the outer ring.</p>

SECTION 6 - Bearing Mounting & Removal

The reduction in radial internal clearance when mounting tapered bore spherical roller bearings with CN clearance on a solid shaft is listed below. If mounting bearings with C3 clearance, the maximum value listed should be used as the standard value:

Nominal bore diameter d mm		Reduction of radial internal clearance μm				Axial displacement mm				Minimum required residual clearance μm		
						1/12 taper		1/30 taper		Clearance CN	Clearance C3	Clearance C4
over	up to	min		max		min	max	min	max			
		mm	inches	mm	inches							
24	30	15	0.0006	20	0.0008	0.27	0.35	-	-	10	20	35
30	40	20	0.0008	25	0.0010	0.32	0.4	-	-	15	25	40
40	50	25	0.0010	35	0.0014	0.4	0.5	-	-	20	30	45
50	65	30	0.0012	40	0.0016	0.45	0.6	-	-	25	35	55
65	80	35	0.0014	50	0.0020	0.55	0.75	-	-	35	40	70
80	100	40	0.0016	55	0.0022	0.65	0.85	-	-	40	50	85
100	120	55	0.0022	70	0.0028	0.85	1.05	2.15	2.65	45	65	100
120	140	65	0.0026	90	0.0035	1.0	1.2	2.5	3.0	55	80	110
140	160	75	0.0030	100	0.0039	1.1	1.35	2.75	3.4	55	90	130
160	180	80	0.0031	110	0.0043	1.2	1.5	3.0	3.8	60	100	150
180	200	90	0.0035	120	0.0047	1.4	1.7	3.5	4.3	70	110	170
200	225	100	0.0039	130	0.0051	1.55	1.85	3.85	4.6	80	120	190
225	250	110	0.0043	140	0.0055	1.7	2.05	4.25	5.1	90	130	210
250	280	120	0.0047	160	0.0063	1.8	2.3	4.5	5.75	100	140	230
280	315	130	0.0051	180	0.0071	2.0	2.5	5.0	6.25	110	150	250
315	355	150	0.0059	200	0.0079	2.3	2.8	5.75	7.0	120	170	270
355	400	170	0.0067	220	0.0087	2.5	3.1	6.25	7.75	130	190	300
400	450	190	0.0075	240	0.0094	2.8	3.4	7.0	8.5	140	210	330
450	500	210	0.0083	270	0.0106	3.1	3.8	7.75	9.5	160	230	360
500	560	240	0.0094	310	0.0122	3.5	4.3	8.75	10.8	170	260	370
560	630	260	0.0102	350	0.0138	3.9	4.8	9.75	12.0	200	300	410
630	710	300	0.0118	390	0.0154	4.3	5.3	10.8	13.3	210	320	460
710	800	340	0.0134	430	0.0169	4.8	6.0	12.0	15.0	230	370	530
800	900	370	0.0146	500	0.0197	5.3	6.7	13.3	16.8	270	410	570
900	1000	410	0.0161	550	0.0217	5.9	7.4	14.8	18.5	300	450	640

SECTION 6 - Bearing Mounting & Removal

Inner ring removal methods

(a) Removal by use of a press

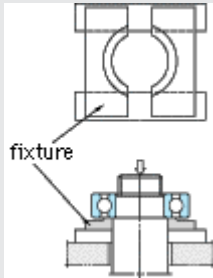

(b) Removal by use of oil pressure

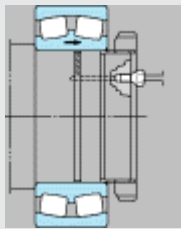

(c) Removal by use of special tools

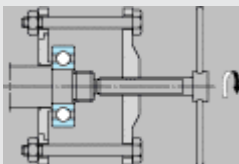

(d) Removal by use of special tools

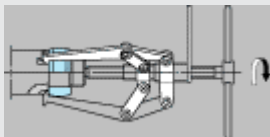

(e) Removal using an induction heater

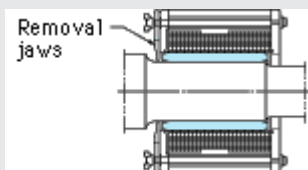

BEARING REMOVAL METHODS

Since bearings with interference fits can be easily damaged during removal, precautions to prevent damage during removal should be taken. Of course, if a bearing is to be discarded, methods such as torch cutting can be used for bearing removal. If the bearing is to be reused or checked for causes of damage, care needs to be taken during removal. To ease removal and avoid damage to the bearing, the proper tools and methods need to be employed. The tables on the following pages cover the tools and methods needed for removal.

REMOVAL PROCEDURES FOR CYLINDRICAL BORE BEARINGS

- Non-separable bearings should be treated carefully during removal so as to minimize external force, which affects their rolling elements.
- The easiest way to remove bearings is by using a press as shown in Fig.(a). It is recommended that the fixture be prepared so that the inner ring can receive the removal force.
- Large size bearings are often removed by applying oil pressure to fitting surfaces, as shown in Fig.(b).
- Figs.(c) and (d) show removal methods in which special tools are employed. In both cases, the jaws of the tool should firmly hold the side of the inner ring.
- Figs.(e) shows an example of removal by use of an induction heater: this method can be adapted to both mounting and removal of the inner rings of NU and NJ type cylindrical roller bearings.

SECTION 6 - Bearing Mounting & Removal

REMOVAL PROCEDURES FOR TAPERED BORE BEARINGS

- Fig.(a) shows the removal of an inner ring by means of driving wedges into notches at the back of the labyrinth.
- For bearings with an adapter sleeve, the following two methods are suitable. As shown in Fig.(b), fix bearings with clamps, loosen locknuts, and then hammer off the adapter sleeve. This method is mainly used for small size bearings.
- Fig.(c) shows the method using hydraulic nuts.
- Small size bearings with withdrawal sleeves can be removed by tightening locknuts as shown in Fig.(d). For large size bearings, provide several bolt holes on locknuts as shown in Fig.(e), and tighten bolts. The bearings can then be removed as easily as small size bearings.
- Fig.(f) shows the method using hydraulic nuts.

REMOVAL METHODS FOR PRESS FITTED OUTER RINGS

To remove outer rings with interference fits, it is recommended that notches or bolt holes be provided on the shoulder of the housings

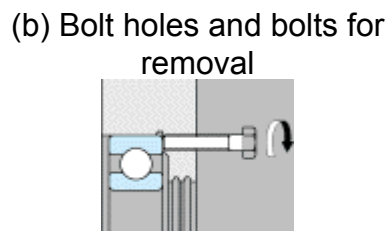
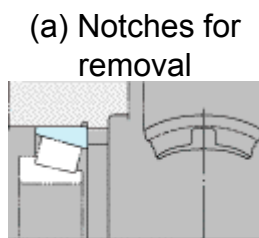

Inner ring removal methods

(a) Removal by use of a wedge

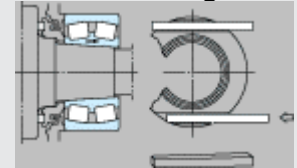

(b) Removal by use of clamps

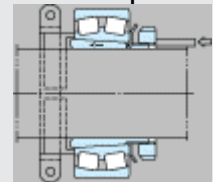

(c) Removal by use of hydraulic nuts

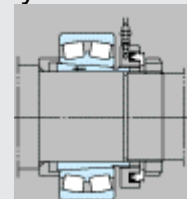

(d) Removal by use of locknuts



(e) Removal by use of bolts

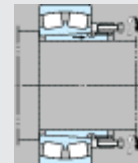

(f) Removal by use of hydraulic nuts



SECTION 6 - Bearing Mounting & Removal

NOTES

Koyo

SECTION 6 - Bearing Mounting & Removal

NOTES

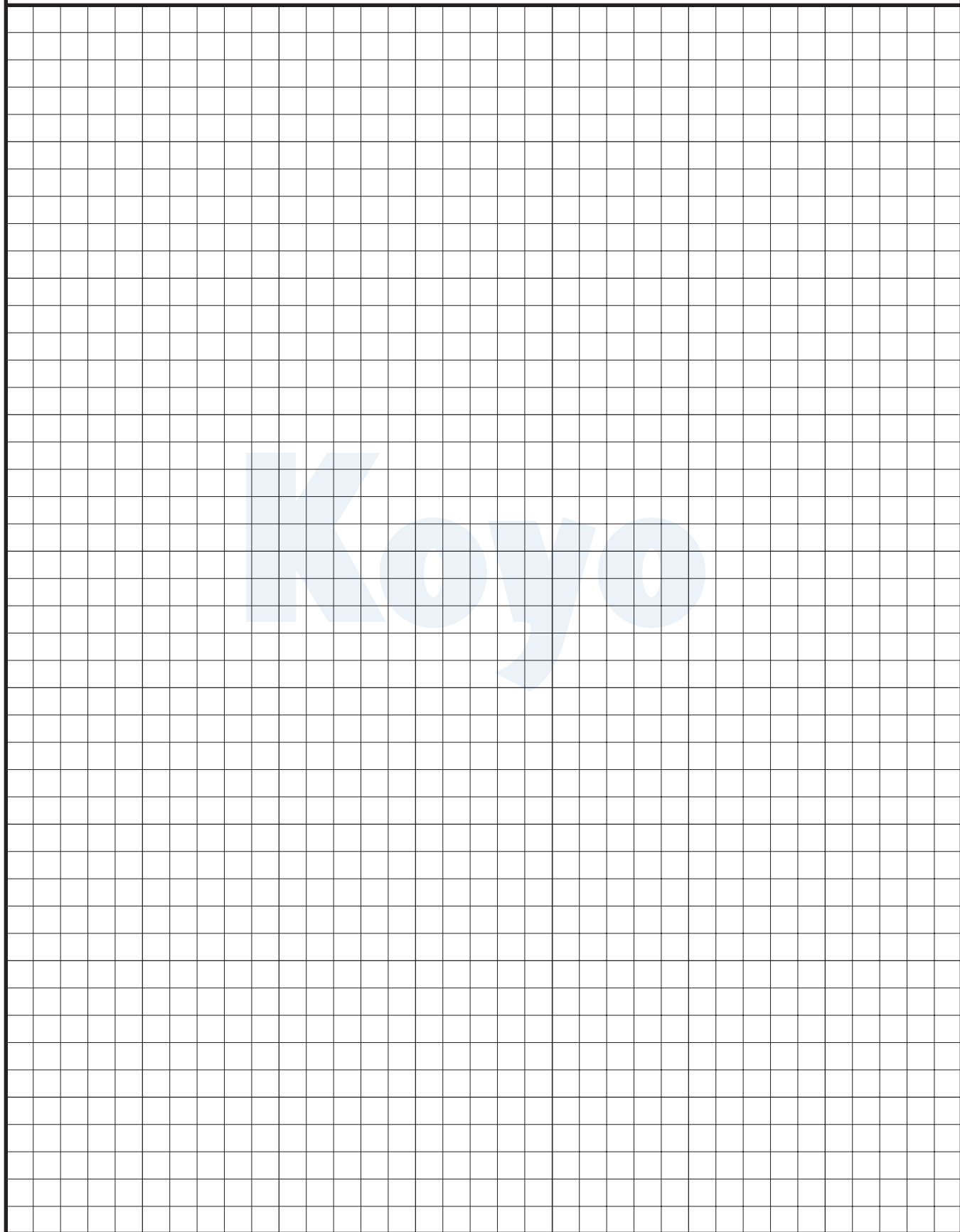

SECTION 7 - Bearing Lubrication

BEARING LUBRICATION

Proper lubrication for rolling element bearings is critical for reliable bearing operation and prevention of premature damage and a reduction in fatigue life. The proper bearing lubricant must provide a separating film between the rolling elements, raceways, and cage to prevent metal-to-metal contact. The lubricant film must be thick enough under operating conditions to prevent contact of rolling element and raceway asperities (high points of surface finish) as illustrated below.

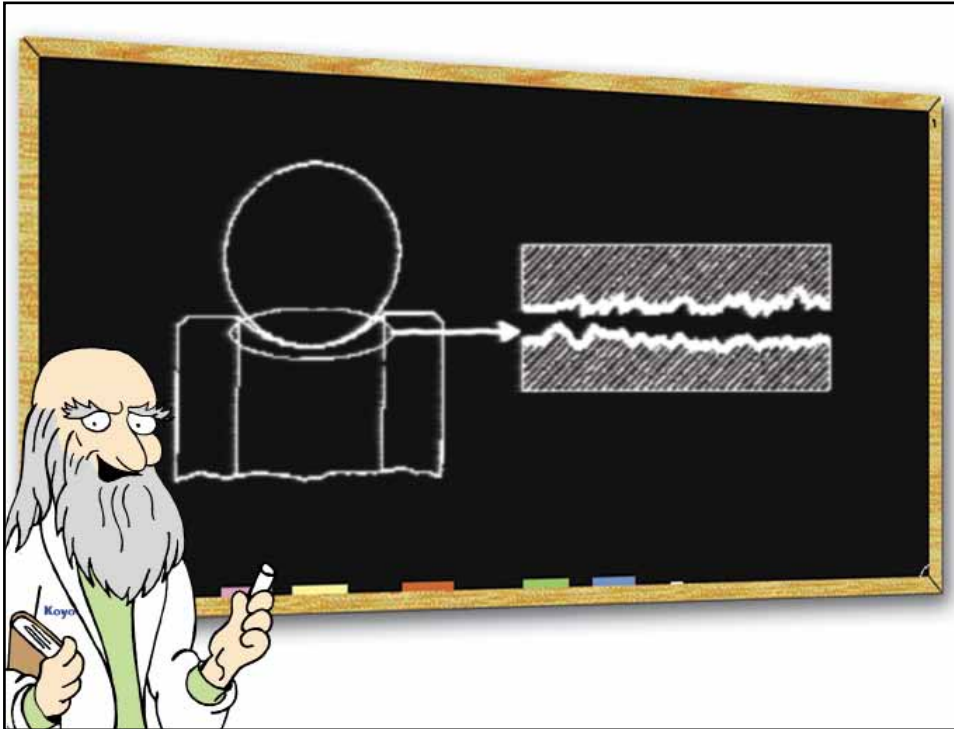

If the asperities of rolling elements and races of an anti-friction bearing come into contact with each other, a certain amount of molecular adhesion or micro-welding or shearing of these asperities as a result of the relative motion between them can be expected. The result is an undesirable surface change of the rolling surfaces. Ideal lubrication requires that an oil film be continually present to prevent contact of the surface asperities and metal to metal contact.

In addition to preventing metal-to-metal contact, proper bearing lubricants help perform the following function:

- Reduce friction, heat generation, torque, and power consumption
- Provide a heat transfer medium
- Prevent corrosion
- Aid in providing proper sealing and preventing contamination

Bearing lubrication is broadly categorized as being either grease or oil lubrication. The decision to use grease or oil and what type of lubricant system to use, are dependent on the bearing type and application operating conditions. Specific considerations for using grease or oil will be covered in the following pages of this section.

SECTION 7 - Bearing Lubrication

REGIMES OF LUBRICATION

When loading is progressively increased between bearing rolling elements and the raceway surfaces, there are distinct differences that affect the condition of the lubricant which are referred to as the regime of lubrication:

FLUID FILM – The load is fully supported by the lubricant thus maintaining a space between the rolling elements and raceway preventing any metal to metal contact.

HYDROSTATIC – A form of fluid film lubrication, but with the addition of a pressurizing system (pump) to maintain a sufficient volume of lubricant dependent on the speed and loading.

HYDRODYNAMIC – The ability of a lubricant through hydrodynamic forces alone, to form the lubricant film into a wedge shape and drag the lubricant into the film enabling the external loads to be supported by the film.

ELASTO-HYDRODYNAMIC – The rolling elements and raceway are still separated by the lube film, but due to elastic deformation of the contacting surfaces, some contact may occur between the surface asperities.

BOUNDARY LUBRICATION – Essentially a breakdown of the lubricant hydrodynamic action allowing more metal to metal contact between the rolling elements and raceway surface asperities.

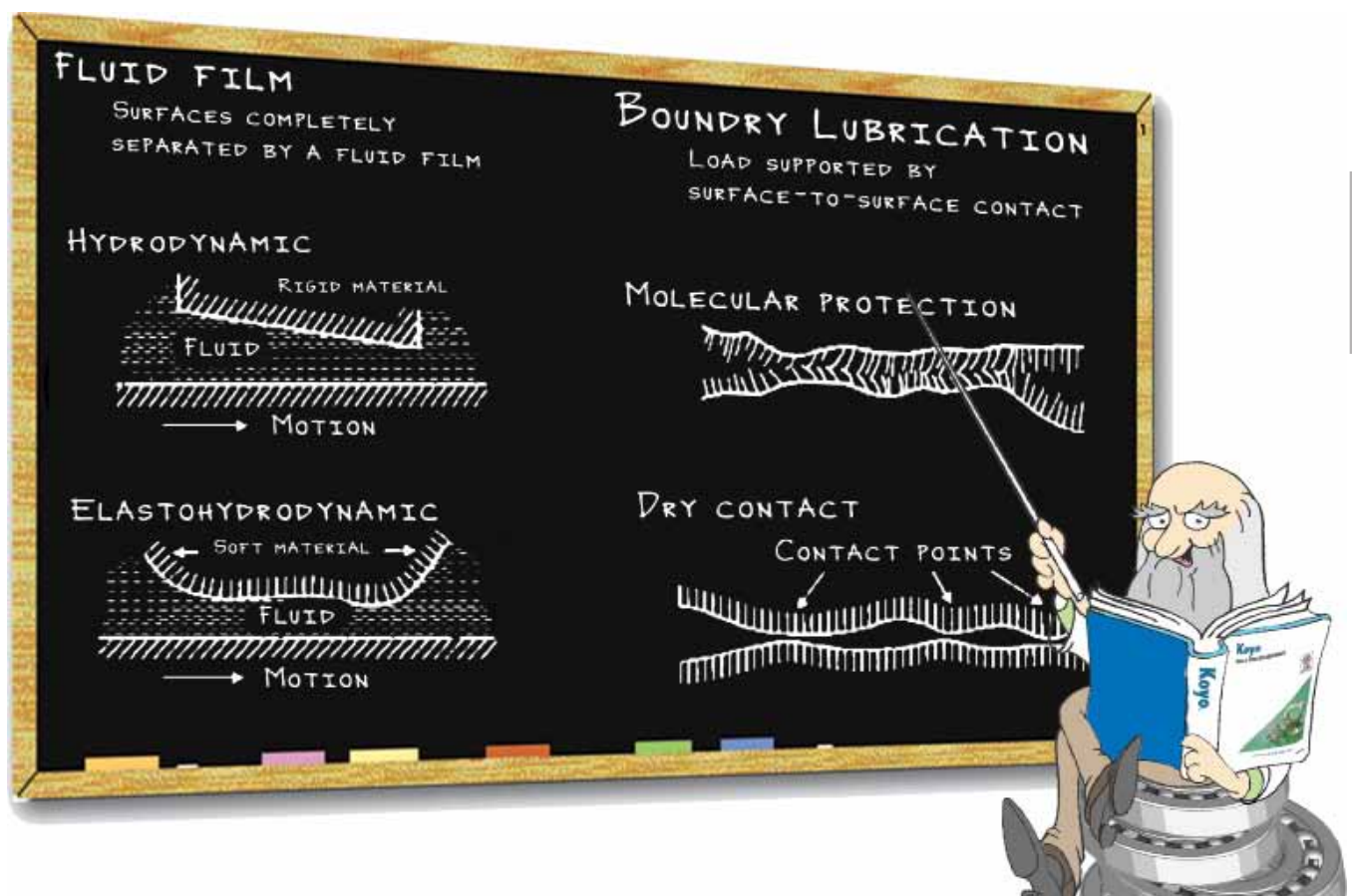

SECTION 7 - Bearing Lubrication

LUBRICATION TERMINOLOGY

The following is a listing of the definitions of the more commonly used lubrication terms used when describing lubricants for bearing applications:

ADDITIVE – Any material or compound added to a base lubricant to enhance its properties, characteristics, or performance.

ANTI-FOAM AGENT – Additive that suppresses the foaming tendency of a lubricant by breaking up surface bubbles and decreasing the tendency to entrap air and bubble formation.

ANTI-OXIDANT – Additive that reduces rate of oil oxidation. Oil oxidation can result in an increase in lubricant viscosity and corrosion of bearing steel surfaces.

ANTI-WEAR AGENT – Additive used when bearing may be operating under boundary lubrication conditions to prevent metal to metal contact and wear.

BASE OIL – Oil component of grease which provides lubrication under operating conditions. Greases can be based on either a mineral oil or synthetic oil.

CONSISTENCY – Normally used to describe grease's firmness level. Grease consistency depends on the type and amount of thickener used and the viscosity of the base oil. Consistency is measured in terms of its NLGI (National Lubricating Grease Institute) grade, which can range from 000 to 6. The NLGI rating is a measure of the depth of penetration of a standard cone over a period of time into a grease sample at 25 deg. C. +/- 1 deg (77° F). The higher the NLGI number the harder the grease. Rolling element bearings typically use an NLGI grade of 2 or 3.

CONTAMINATION – Any foreign or unwanted substance in the lubricant that can have a negative effect on bearing operation and fatigue life.

CORROSION INHIBITOR – Lubricant additive that protects metal surfaces from chemical attacks from water or other contaminants that may cause corrosion.

DROPPING POINT – The temperature recorded on a test tube thermometer when a drop of grease will fall through the hole in a grease cup. It is a measure of the heat resistance of grease and away to determine its suitability for a specific application. It is essentially the point at which a grease becomes a liquid.

EXTREME PRESSURE (EP) ADDITIVE – Lubricant additive that prevents sliding metal surfaces from welding and seizing under conditions of extreme pressure. Allows bearings to carry greater loads than would be possible with standard lubricants without excessive wear or damage.

SECTION 7 - Bearing Lubrication

LUBRICATION TERMINOLOGY ... *cont'd*

ISO VISCOSITY GRADE – A number that indicates the nominal viscosity of an industrial fluid lubricant at 40 deg. C (104 F.) as defined by ASTM Standard Viscosity System for Industrial Fluid Lubricants D2422.

KINEMATIC VISCOSITY – The time required for a fixed amount of oil to flow through a capillary tube under the force of gravity. The unit of kinematic viscosity is the stoke or centistoke cSt (1/100 of a stoke).

POUR POINT – The lowest temperature at which oil will flow when cooled. The pour point is 3° C. (5° F.) above the temperature at which the oil in a test container shows no movement when it is held horizontally for five seconds.

SAYBOLT UNIVERSAL VISCOSITY (SUV) OR SAYBOLT UNIVERSAL SECONDS (SUS) – The time required for 60 cubic centimeters of a fluid lubricant to flow through the orifice of the Standard Saybolt Universal Viscometer at a given temperature under specified conditions.

THICKENER – Used in grease formation as a solid with oil affinity so that when mixed with oil will transform it into a semi-solid state. Most greases use a metallic soap base as a thickening agent, but some also use a non-soap base for a thickener depending on the desired grease characteristics

VISCOSITY – A measurement of a fluid's resistance to flow. The higher the viscosity the higher the resistance to flow. The viscosity of a lubricant varies with changes in temperature. Viscosity decreases with an increase in temperature. Consequently, when being reviewed for a bearing application, the effect of viscosity at operating temperature needs to be considered.

VISCOSITY INDEX – Measure of a lubricant's change in viscosity with temperature. The higher the viscosity index, the smaller the change in viscosity with temperature.

SECTION 7 - Bearing Lubrication

Grease Lubrication is Widely Used Because:

- No Need for Replenishment Over a Long Period
- Relatively Simple Structure Can Suffice as a Sealing Device

There are Two Methods of Grease Lubrication:

- Closed (Filled in Advanced –Sealed/ Shielded Bearings)
- Feeding Method (Bearing and Housing are Refilled)

GREASE LUBRICATION

The simplest lubrication system for any bearing application is grease. As illustrated below, grease is a combination of base oil, a thickener, and various additives. All components play an important role in determining grease's suitability for a particular bearing application. However, it is primarily the oil in grease that does the lubricating. Normally the base oil used in greases is a mineral oil, however, if high or low temperatures or special performance characteristics are required, there are various synthetic oils that can be used.

The thickener will absorb the base oil and allow the oil to bleed out to lubricate the bearing. The amount of thickener in grease can vary from a few percent up to 30% or more, and is the primary component in determining the consistency of grease. The migration of grease into and through a bearing is mostly determined by its consistency. A very soft grease will flow easily into a bearing. This is undesirable at higher speeds because the additional grease may be excessive causing churning which will create additional heat generation.

Most greases use a metallic soap base such as lithium, sodium, or calcium as thickeners. Several non-soap substances such as bentone, urea compounds, and fluorine compounds are also used as grease thickeners.

As the chart below shows, in general the mechanical stability, operating temperature range, and water resistance are determined by the thickener. Various additives are selectively used to meet the application requirements. Frequently used grease additives are extreme pressure (EP) and rust & oxidation inhibitors.

CHARACTERISTICS OF GREASE THICKENERS

Thickener	Operating temperature range		Rotational speed range	Mechanical stability	Water resistance	Pressure resistance
	C°	F°				
Lithium soap	-30 to 120	-22 to 248	Medium to high	Excellent	Good	Good
Calcium soap	-10 to 70	14 to 158	Low to medium	Fair to good	Good	Fair
Sodium soap	0 to 110	32 to 230	Low to high	Good to excellent	Bad	Good to excellent
Urea compounds	-30 to 150	-22 to 300	Low to high	Good to excellent	Good to excellent	Good to excellent
Bentone	-10 to 150	14 to 300	Medium to high	Good	Good	Good to excellent
Fluorine compounds	-40 to 250	-40 to 400	Low to medium	Good	Good	Good

SECTION 7 - Bearing Lubrication

BEARING GREASING METHODS AND AMOUNTS

There are two methods for providing bearing grease lubrication. One is the closed lubrication, in which grease is filled in advance into a shielded or sealed bearing; the other is the feeding method in which the bearing and housing are greased at assembly with the proper amount and designed to allow re-greasing and replacement at specified intervals. The closed method using a pre-lubricated shielded or sealed bearing is well suited for applications where cost and space limitations preclude the use of grease filled housing or where relubrication is not possible or necessary. Conversely, the use of the feeding method (illustrated on the previous page) has the advantage of allowing the replacement of grease at periodic intervals in those applications where operating conditions require grease replacement.

On bearing applications utilizing the feeding method, there should be a grease fitting and a vent at opposite ends of the housing near the top. Also, a drain plug should be located near the bottom of the housing to allow purging of the old grease during relubrication. A bearing should be initially greased at assembly by packing it in on both sides and making sure the grease is between the rolling elements and cage. Regreasing should always occur while the bearing is in motion at the normal operating temperature.

GREASE AMOUNT

The amount of grease needed to effectively lubricate a bearing is normally very small. In general, grease fill should be one-third to one-half of the space around the bearing; however, this may vary according to the housing design and application requirements. In applications with high speed and low torque requirements, the bearings can be lubricated with very small quantities of greases. Similarly, in low speed applications, the bearing may be exposed to dirt or moisture, the space around the bearing can be filled from two-thirds to nearly full to prevent contamination. However, as shown in the photo below; if an excessive amount of grease is used when not required, additional heat will be generated from the churning resulting in a softening and deterioration of the grease, and a reduction in bearing life. The grease weight required for a bearing can be calculated in grams by multiplying $.005 \text{ (mm)} \times \text{O.D.} \times \text{Width (mm)}$ or by multiplying $.114 \text{ (in)} \times \text{O.D.} \times \text{Width (in)}$ for the weight in ounces.

Filling Plug

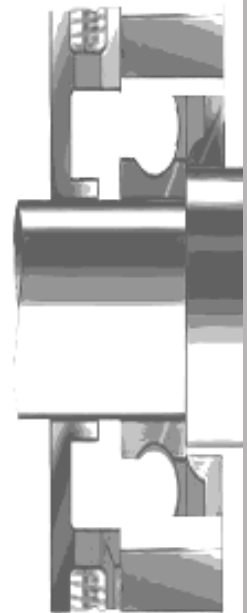

Drain Plug



SECTION 7 - Bearing Lubrication

REGREASING INTERVALS AND GREASE LIFE



Grease Gun

With grease lubricated bearings, periodic relubrication normally is required to ensure efficient operation. Over a period of time, most grease will eventually start to harden due to oxidation. The exception to this is in presealed bearings where relubrication is usually not required.

When regreasing bearings, it is necessary to be sure that the grease fitting is clean prior to injecting the grease. A hand operated grease gun should be used for relubrication, but the use of high pressure needs to be avoided. High pressure may blow out seals. When using a grease gun, it should be calibrated for the proper amount of grease, and confirmed that the grease in the gun is the same as what was initially applied to the bearings.

The main considerations for determining a relubrication cycle are operating speed, bearing size, operating temperature, and sealing efficiency. The graph below can be used to determine the relubrication interval under normal operating conditions. Seals are very critical with grease lubrication because of the importance to keep the grease free from contamination. Contamination that reaches the grease is trapped and will cause bearing damage and wear problems.

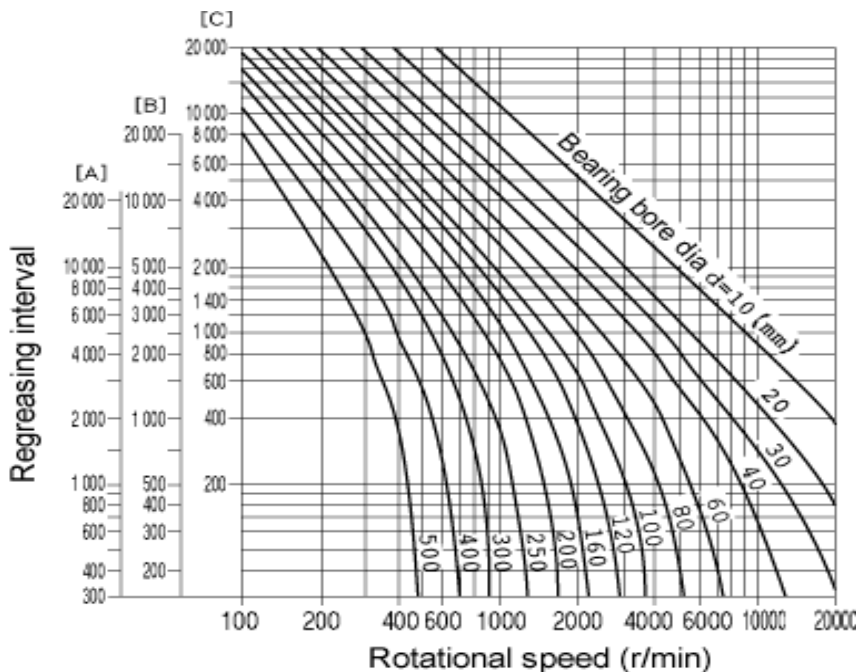

[A] :
Radial Ball Bearings

[B] :
Cylindrical Roller Bearings

Needle Roller Bearings

[C] :
Tapered Roller Bearings

Spherical Roller Bearings

Thrust Ball Bearings

SECTION 7 - Bearing Lubrication

For those applications where the operating temperatures may exceed 70° C (160° F), an additional adjustment to relubrication interval should be taken into account with a temperature correction factor “a”:

$$t_f' = t_f a$$

t_f' = Grease interval time corrected for temperature

t_f = Grease interval time for size & speed only

Temperature correction factor “a”

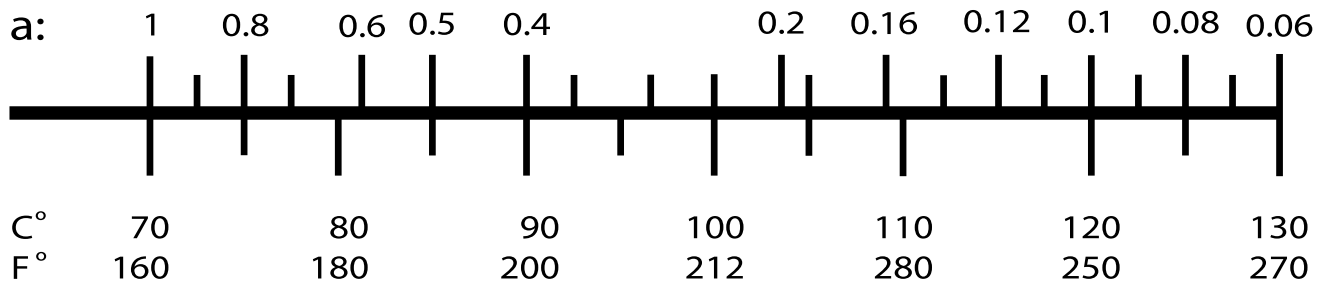

Bearing operating temperature °C / °F

Example of calculating grease feeding interval:

In case of tapered roller bearings with a bore diameter of 100 mm and running speed of 300 RPM, grease has a service life of approximately 8,500 hours.

If the amount of grease initially enclosed is 0.4 kg (14 oz), it decreases 0.00113 kg (0.0402 oz) a day (0.4 kg (14 oz) 24 h / 8,500 h = 0.00113 kg (0.0402 oz)/day).

If grease is fed once a week, the total grease to be added is 0.008 kg (0.28 oz) (0.00113 (0.0402 oz) 7 days = 0.008 kg (0.28 oz)).

Temperature correction for above example with an operating temperature of 120° C (248° F):

$$t_f' = t_f a$$

$$t_f' = 8500\text{hrs} \times .1 = 850\text{hrs.}$$

SECTION 7 - Bearing Lubrication

GREASE LIFE IN SEALED/SHIELDED DEEP GROOVE BALL BEARINGS

Even though these bearings were not designed for relubrication (it is possible to relubricate a shielded bearing), it may be desirable to estimate the expected grease life of these prelubricated bearings based on the operating conditions. The equation below takes into account the effect of speed, load, and operating temperature:

$$\log L = 6.10 - 4.40 \cdot 10^{-6} d_m n - 2.50 (Pr / Cr - 0.05) - (0.021 - 1.80 \cdot 10^{-8} d_m n) T$$

Where:

L :	Grease life	h
	$(D + d) / 2$	
d_m :	$(D$: bearing outside diameter, d : bearing bore diameter)	mm
n :	rotational speed	rpm
Pr :	dynamic equivalent radial load	N
Cr :	basic dynamic radial load rating	N
T :	operating temperature of bearing	°C

It is recommended that KOYO be consulted regarding the use of this equation and conditions that may not be applicable for its use.

OIL LUBRICATION

Oil is generally the bearing lubricant of choice on those applications where higher speeds and operating temperatures are expected. When oil is used for bearing lubrication, it should be a high quality, non-oxidizing mineral oil or synthetic oil with similar properties.

Selection of the proper type of oil depends on bearing operating speed, loading, operating temperature, and method of lubrication. When a lubricating oil viscosity is too low, there will not be a sufficient oil film. Conversely, when the viscosity is too high, additional heat will be generated due to viscous resistance. In general, the heavier the load and the higher the operating temperature, the higher the oil viscosity should be. If the operating speed is high or the temperatures are low, lower viscosity oil needs to be used. The chart on the following page shows the relationship of lubricating oil viscosity with operating temperature, speed, and load:

SECTION 7 - Bearing Lubrication

Operating temperature	$d_m n$ value	Proper kinematic viscosity (expressed in the ISO viscosity grade or the SAE No.)	
		Light/normal load	Heavy/impact load
-30 to 0 °C	All rotation speeds	ISO VG 15, 22, 46	-
0 to 60 °C	up to 300,000	ISO VG 46 (Bearing oil Turbine oil)	ISO VG 68 SAE 30 (Bearing oil Turbine oil)
	300,000 to 600,000	ISO VG 32 (Bearing oil Turbine oil)	ISO VG 68 (Bearing oil Turbine oil)
	over 600,000	ISO VG 7, 10, 22 (Bearing oil)	-
60 to 100 °C	up to 300,000	ISO VG 68 (Bearing oil)	ISO VG 68, 100 SAE 30 (Bearing oil)
	300,000 to 600,000	ISO VG 32, 46 (Bearing oil Turbine oil)	ISO VG 68 (Bearing oil Turbine oil)
	over 600,000	ISO VG 22, 32, 46 (Bearing oil Turbine oil Machine oil)	-
100 to 150 °C	up to 300,000	ISO VG 68, 100 SAE 30, 40 (Bearing oil)	ISO VG 100 460 Bearing oil Gear oil
	300,000 to 600,000	ISO VG 68 SAE 30 (Bearing oil Turbine oil)	ISO VG 68, 100 SAE 30, 40 (Bearing oil)
Remarks:			
1.	$d_m n = (D + d) / 2 n$ <i>{ D : bearing outside diameter (mm), d : bearing bore diameter (mm), n : rotational speed (rpm) }</i>		
2.	Refer to refrigerating machine oil (JIS K 2211), turbine oil (JIS K 2213), gear oil (JIS K 2219), machine oil (JIS K 2238) and bearing oil (JIS K 2239).		
3.	Contact Koyo if the bearing operating temperature is under -30 C / -20 F. or over 150 C / 300 F.		

SECTION 7 - Bearing Lubrication

TYPES OF OIL LUBRICATION METHODS

The main methods for oil lubricating bearings are the following:

1. An Oil Bath or Static Oil Level
2. An Oil Splash System
3. Forced Feed Circulating System
4. Forced Oil Jet System
5. Oil Mist or Fog System
6. Oil/Air System

An oil bath system and the circulating oil methods are probably the most commonly used type of bearing oil systems. However, the selection of a particular type of system is generally based on thermal considerations or the ability of a lubricating system to remove heat generated in the bearing application.

It should be kept in mind that regardless of the oil system used, that the selection of the oil type and its viscosity are based on the application operating conditions and requirements. Also, the recommended volume of oil in any system should always be maintained. All oils will oxidize and will require periodic replacement.

OIL BATH METHOD

- The simplest method is to partially immerse a bearing in oil for operation.
- Suitable for low/medium rotation speeds only, use at high speeds will result in churning and heat generation.
- Oil level gauge should be furnished to adjust the amount of oil.
- (In the case of horizontal shaft) About 50% of the lowest rolling element should be immersed.
- (In the case of vertical shaft) About 70 to 80% of the bearing should be immersed.
- It is better to use a magnetic plug to prevent wear particles from dispersing in the oil.

SECTION 7 - Bearing Lubrication

OIL SPLASH SYSTEM

- This system makes use of a gear or flinger attached to a rotating shaft to splash oil into a catch basin at the top of the housing from which it is directed to the bearing.
- Depending on the bearing type being used, oil splash can be used up to relatively high speed.
- Oil level needs to be maintained at a specific height to allow adequate oil splash.
- Magnetic plug should be used to prevent iron wear particles from dispersing into oil.

FORCED OIL CIRCULATING SYSTEM

- This method employs a circulation-type oil supply system. Supplied oil flows through the bearing carrying away heat, and is sent back to the tank through an oil drain pipe. The oil, after filtering and cooling, is pumped back.
- Widely used at high rotation speeds and high temperature conditions.
- The circulating oil also carries away contaminants.
- The life of the oil is extended by keeping its operating temperature lower and freed of contaminants.
- It is better to use an oil drain pipe approximately twice as thick as the oil inlet pipe in order to prevent too much lubricant from gathering in the housing and backing up creating an oil fill and churning problems.

FORCED OIL JET SYSTEM

- This method uses a nozzle to jet oil at a constant pressure (10 to 50N/cm²), and is highly effective in cooling.
- Suitable for high rotation speed and heavy load.
- Generally, the nozzle (diameter 0.5 to 2 mm (.02 to .08 in)) is located 5 to 10 mm (.2 to .4 in) from the side of a bearing.
- For adequate cooling when a large amount of heat is generated, 2 to 4 nozzles should be used and spaced equally around the bearing circumference at a diameter to assure the oil is not deflected by the cage, spacer, or other design component.
- Since a large amount of oil is supplied in the jet lubrication method, used oil should be discharged with an oil pump to prevent an excessive buildup of oil.

* Since the amount of oil required for cooling bearings with either of the forced oil systems varies depending on the bearing type, oil type, speed, and temperature, the equation on the next page should be used for estimating the require amount of oil to supply.

OIL SPLASH METHOD

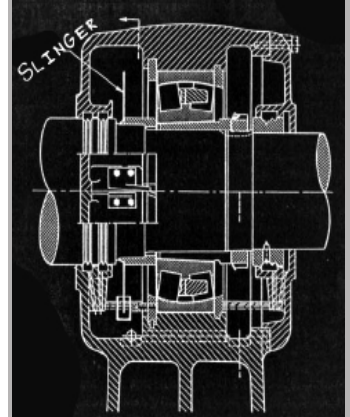

FORCED OIL CIRCULATING METHOD

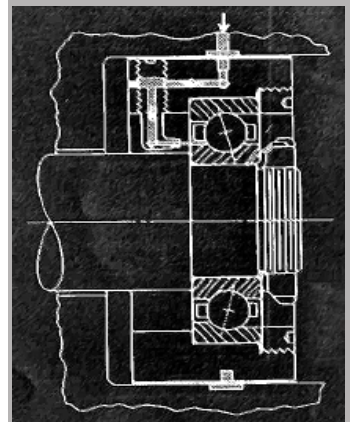

SECTION 7 - Bearing Lubrication

REQUIRED OIL SUPPLY IN FORCED OIL CIRCULATION AND OIL JET LUBRICATION

$$G = \frac{1.88 \times 10^{-4} \mu \cdot d \cdot n \cdot P}{60 c \cdot \rho \cdot \Delta T}$$

Where

G:	required oil supply	L / min
μ :	friction coefficient (see table below)	
d:	bearing bore diameter	mm
n:	rotation speed	r/min
P:	dynamic equivalent load of bearing	N
c:	specific heat of oil, 1.88 to 2.09	kJ/kg · K
ρ:	density of oil	g/cm ³
ΔT:	temperature rise of oil	K

Values of friction coefficient μ

Bearing type	μ
Deep groove ball bearings	0.0010 to 0.0015
Angular contact ball bearings	0.0012 to 0.0020
Cylindrical roller bearings	0.0008 to 0.0012
Tapered roller bearings	0.0017 to 0.0025
Spherical roller bearings	0.0020 to 0.0025

The values obtained by the above equation show amount of oil required to carry away all the heat generated by the bearing, without heat dissipation through the housing not taken into consideration. In reality, the oil supplied is generally half to two-thirds of the calculated value. Heat dissipation varies widely according to the application and operating conditions.

To determine the optimum oil supply, it is advised to start operating with two-thirds of the calculated value, and then reduce the oil gradually while measuring the operating temperature of bearing, as well as the supplied and discharged oil.

SECTION 7 - Bearing Lubrication

OIL MIST LUBRICATION

- Oil mist lubrication is used in high speed continuous operation applications where it may be difficult to supply a large amount of oil needed in a circulating system and slightly higher operating temperatures can be tolerated.
- This method employs an oil mist generator to produce dry mist (air containing oil in the form of mist). The dry mist is continuously sent to the oil supplier, where the mist is turned into a wet mist (sticky oil drops) by a nozzle set up on the housing or bearing, and is then sprayed onto bearing.
- To ensure wetting of the bearings and to prevent possible damage, it is important that the oil mist be turned on for several minutes before the equipment is started.
- This method provides and sustains the smallest amount of oil film necessary for lubrication, and has the advantages of preventing oil contamination, simplifying bearing maintenance, prolonging bearing fatigue life, reducing oil consumption etc.
- Successful use of this system is accomplished by closely monitoring the operating temperature of the bearings being lubricated.
- Due to the small amount of oil used, the oil itself has very little cooling effect the air passing through the bearing has some effect, but not like a large volume of oil.

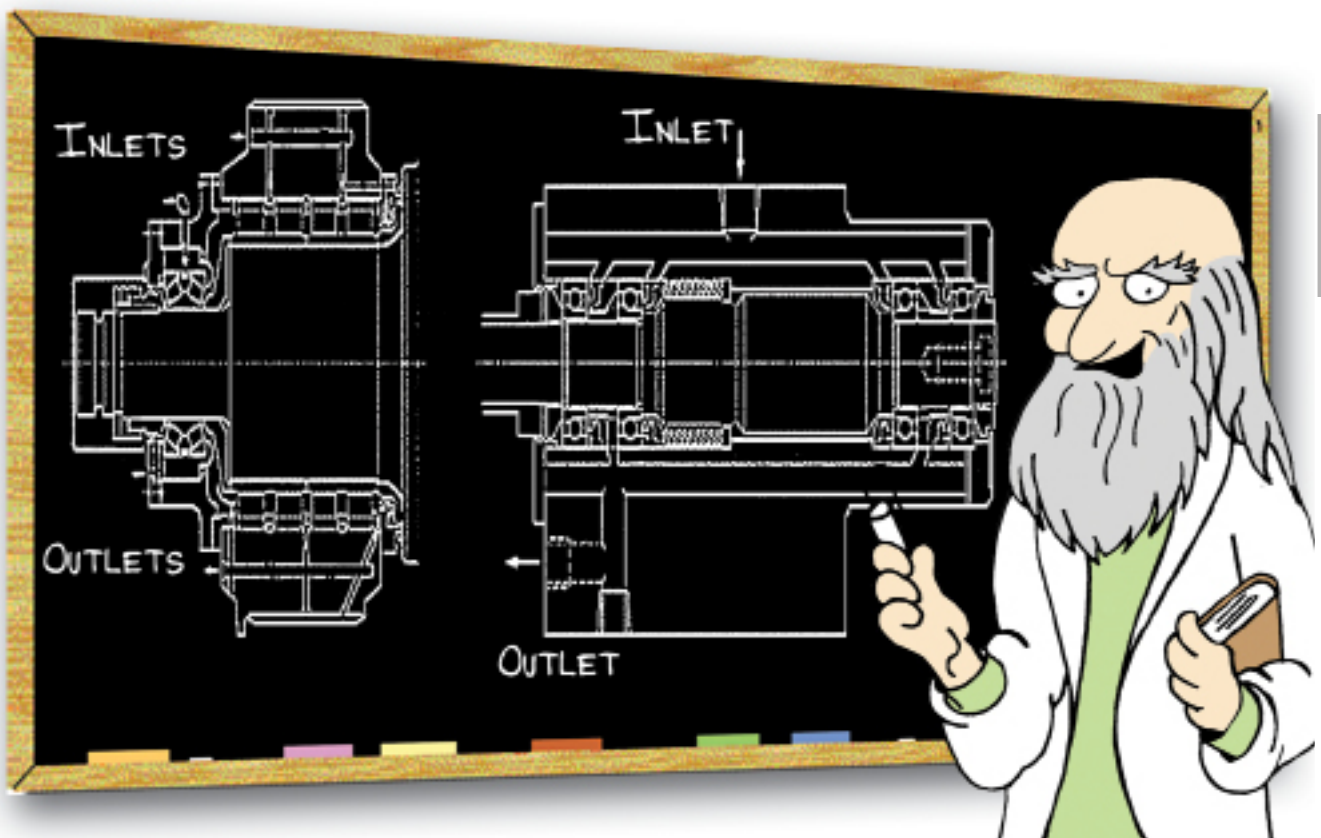

SECTION 7 - Bearing Lubrication

OIL/AIR LUBRICATION SYSTEM

- A proportioning pump releases a small quantity of oil, which is mixed with compressed air by a mixing valve. The mixture is continuously supplied to the bearing.
- This method enables quantitative control of oil in extremely small amounts, always supplying new lubricating oil; consequently, oil degradation is not a problem.
- This method is suitable for machine tools and other applications requiring higher speed operation.
- Compressed air and lubricating oil are supplied to the spindle, increasing the internal pressure helping to prevent dirt and cutting liquids from entering. Also, this method allows the lubricating oil to flow through a feeding pipe minimizing atmospheric pollution.
- Since a large amount of air is used to feed lubricating oil to the bearings, large outlets need to be provided to ensure the air will be exhausted out of the bearing chamber.

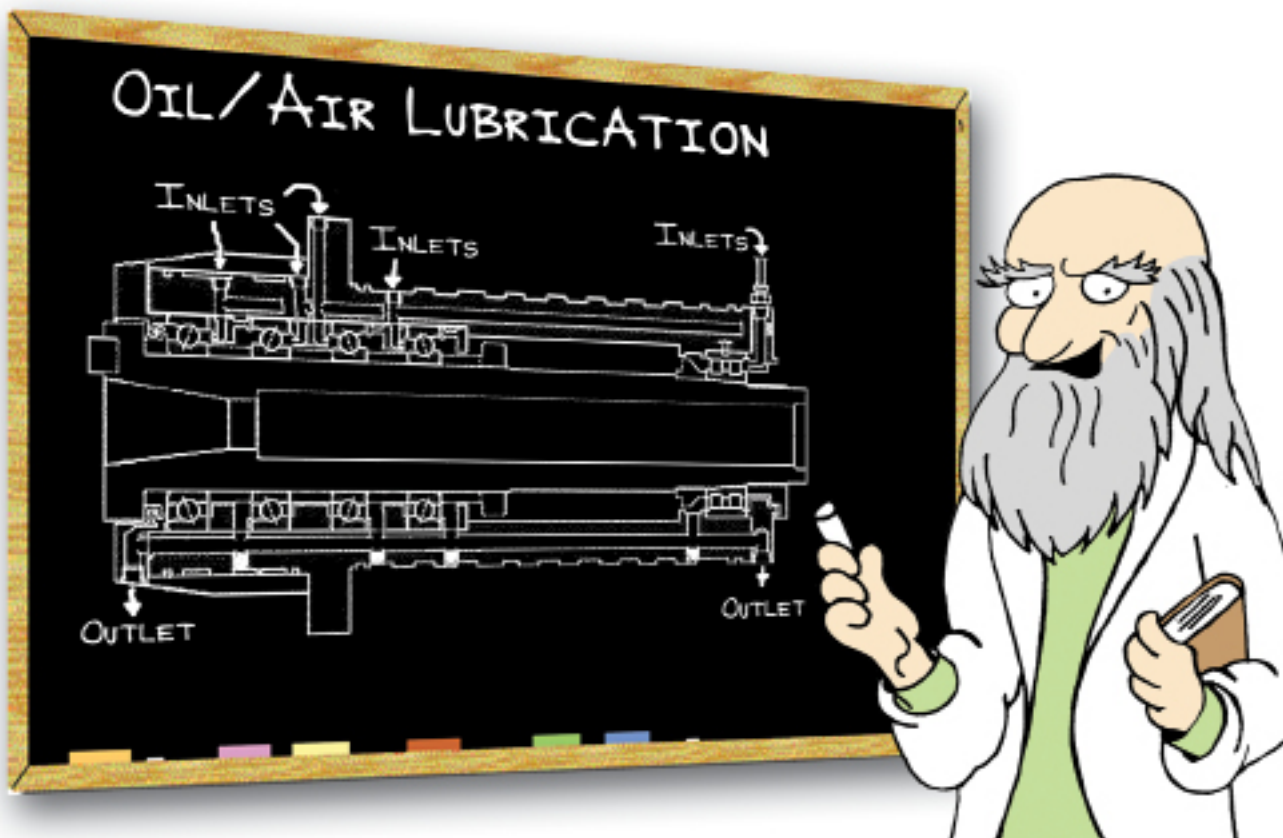

SECTION 7 - Bearing Lubrication

COMPARISON CHART OF OIL VS. GREASE LUBRICATION

A bearing's operating conditions and application design will normally dictate the type of lubrication to be used, however, the chart below can be used as a general guide in determining the most appropriate type.

DESIGN ITEM	GREASE	OIL
Lubricating ability	Good particularly in confined space or vertical application	Excellent because it flows
Sealing devices	Excellent, aids sealing and simplifies sealing device requirements	Fair, more complicated sealing required
Speed capability	Good for slow to moderate speeds	Good for moderate to high speeds
Cooling effect	Not effective at removing heat	Very effective with a circulating system
Lubricant replacement	Time consuming and involved	Easy with adequate drains available
Contamination filtration	Contamination cannot be filtered	Contamination can be filtered out
Lubricant life	Can be long if not adversely effected by operating conditions and is periodically replaced	Usually is long with a recirculating system

SECTION 7 - Bearing Lubrication

GREASE COMPATIBILITY

Occasionally, if operating conditions change or availability becomes an issue, it may become necessary to change the brand of grease being used in an application. ***This can result in serious problems and it cannot be over emphasized, that only certain types of greases can be mixed without negatively affecting the lubricating ability of the grease and the life of the bearings***. The general rule is not to mix greases with different thickeners, base oils or additives because this could actually result in a lessening of both greases lubricating ability. This lessening in performance capability is referred to as incompatibility. ***When greases are incompatible the effect on performance may show up as higher operating temperatures or a change in consistency (usually softening) resulting in bearing failures and high maintenance costs.***

Grease incompatibility is not always caused by the thickener, each of the greases being mixed consists of a thickener, an oil component, and additives. Occasionally, the thickener of one grease is incompatible with the fluid of the additives present in the new grease. Or a particular synthetic base oil in one grease may not be compatible with the conventional oil from a second grease.

To avoid any possibility of incompatibility it is recommended that the grease brand never be changed unless a thorough compatibility study has been conducted. However, if changing brands becomes unavoidable, it is highly recommended to completely remove all of the old grease before using the new grease. However, in rare instances it may not be possible to completely remove the old grease prior to changing brands or type of grease, in these cases the old grease can sometimes be removed by purging with the new grease. This can be done by following these steps:



























































































































1. Insure that the bearing is operating within its established norms (i.e. operating temperature, noise & vibration levels, power draw, etc.)
2. Remove the drain plug and make sure that the grease drain is unobstructed so that the old grease has an easy exit.
3. Add the new grease slowly and in batches.
4. You can expect the temperature to rise whenever new grease is added to a bearing and when changing greases the temperature spike may be larger than is normally seen. Monitor the bearing closely giving extra attention to the temperature and watch for thermal runaway that could come from a severe grease incompatibility.
5. Make sure the old grease is escaping through the drain plug and not around the seals.
6. Wait for the bearing temperature to stabilize. Note that this temperature may be higher than the normal operating temperature due to incompatibility issues.
7. Repeat steps 3 through 6 until the grease that is exiting the grease drain is the same color as the new grease that is being pumped in.
8. Replace the drain plug.
9. Increase normal monitoring of the machine for the first few days after the grease change so that you can catch any previously unseen problems and to establish new bearing norms.

The time that it takes to completely change the grease in a bearing will vary from machine to machine. It can take as little as a couple of hours for a small ball bearing to several days for larger roller bearings. In the situations where a considerable length of time is needed to perform the change-out, make sure to monitor the bearing regularly because a problem might not show itself until a hour or two after the new grease was added and sometimes not until the second, third or even later batch of grease is added.

SECTION 7 - Bearing Lubrication

GREASE COMPATIBILITY CHART

The chart below should only be used as a guide for grease type compatibility. As previously pointed out, the best approach is to thoroughly clean out any old grease before adding a different grease that may or may not be compatible.

 incompatible  compatible		Aluminum Complex	Barium	Calcium	Calcium 12-Hydroxy	Calcium Complex	Clay	Lithium	Lithium 12-Hydroxy	Lithium Complex	Urea	Sodium
Aluminum Complex												
Barium												
Calcium												
Calcium 12-Hydroxy												
Calcium Complex												
Clay												
Lithium												
Lithium 12-Hydroxy												
Lithium Complex												
Urea												
Sodium												

SECTION 7 - Bearing Lubrication

NOTES

Koyo

SECTION 8 - Bearing Failure Analysis

When a bearing is used under ideal conditions, it should meet or exceed its predicted service life and will eventually be damaged by rolling fatigue. Damage from rolling fatigue can occur prematurely if operating conditions are severe or the wrong bearing was selected for the application. However, as indicated by the following statements, the majority of premature bearing failures are caused by improper lubrication, bearing mounting and handling issues.

50% OF ALL FAILURES ARE DUE TO LUBRICATION ISSUES (contamination, inadequate or excessive amounts, wrong lubricant)

30% OF ALL FAILURES ARE RELATED TO MOUNTING ISSUES SUCH AS TOO LOOSE OR TOO TIGHT OF BEARING FITS

10% OF ALL FAILURES ARE RELATED TO STORAGE AND HANDLING PROBLEMS

If damage is found on a bearing during inspection, it is important to document the bearing's operation history properly to identify the causes, even if the damage is very small. Also, it is essential to examine not only the bearing but also the shaft, housing and lubricant.

PROCEDURE FOR DETERMINING MODE OF BEARING FAILURE

For properly identifying the cause of bearing damage in an application, the following procedure and investigation is recommended:

1. Review service and maintenance records and any other previous data from bearing monitoring equipment.
2. Prior to bearing removal and inspection, a final noise and temperature check should be performed and recorded.
3. Create a sheet for documenting bearing and application inspection observations which should include pertinent photos.
4. Lubricant samples should be taken from bearings and surrounding areas including housing and seals.
5. A sample of new unused bearing lubricant should also be collected.
6. When the bearing is removed from the equipment, step 5 shown in the 'bearing removal methods' section of this book should be followed.
7. If the bearing must be removed from the shaft by pulling on the outer ring, mark position of the balls on the inner ring so that the damage that is caused during disassembly can be identified and not mistakenly attributed to an assembly problem.
8. The machine components surrounding the bearings such as backing shoulders, locknuts, and any sealing devices need to be inspected for damage and wear and then documented on the inspection sheet.
9. The shaft and housing should be measured for bore and OD sizes, roundness and taper.
10. After the bearing has been removed and cleaned, all markings and part numbers should be recorded.
11. If a bearing is to be returned to the manufacturer for analysis, do not clean the lubricant from the bearing.
12. The general condition of the bearing should be noted and recorded, with specific attention to the condition of the rolling elements and raceways.
13. If further analysis of the bearing damage is required or a metallurgical check may be needed, a preservative oil should be applied to the bearing prior to repackaging and shipment.

SECTION 8 - Bearing Failure Analysis

TYPES OF BEARING FAILURES AND DAMAGE

Since there are many different failure modes and damage bearings will exhibit, the following pages will review these and cover possible causes and preventive measures that can be taken.

FLAKING

Flaking is damage where material is removed in flakes from a surface layer of the bearing raceways or rolling elements due to rolling fatigue.

This failure mode is generally attributed to the approaching end of bearing service life. However, if flaking occurs at early stages of bearing service life, it is necessary to determine causes and adopt preventive measures.



DAMAGE	Possible Causes	Preventive Measures
Flaking occurring at an initial stage	<ul style="list-style-type: none"> • Too small internal clearance • Improper or insufficient lubricant • Excessive loading • Rust 	<ul style="list-style-type: none"> • Provide proper internal clearance. • Select proper lubricating method or lubricant.
Flaking on one side of radial bearing raceway	<ul style="list-style-type: none"> • An excessively large axial load 	<ul style="list-style-type: none"> • Fitting between outer ring on the free side and housing should be changed to clearance fit.
Symmetrical flaking along circumference of raceway	<ul style="list-style-type: none"> • Inaccurate housing roundness 	<ul style="list-style-type: none"> • Correct machining accuracy of housing bore. (Especially for split housings, care should be taken to ensure machining accuracy.)
Slanted flaking on the radial ball bearing raceway	<ul style="list-style-type: none"> • Improper mounting • Shaft deflection • Misalignment of the shaft and housing 	<ul style="list-style-type: none"> • Correct centering. • Widen bearing internal clearance. • Correct squareness of shaft or housing shoulder.
Flaking occurring near the edge of the raceway or rolling contact surface of roller bearings		
Flaking on the raceway surface at the same interval as rolling element spacing	<ul style="list-style-type: none"> • Heavy impact load during mounting • Damage on a cylindrical roller bearing or tapered roller bearing caused when they are mounted. • Rust gathered while out of operation. 	<ul style="list-style-type: none"> • Improve mounting procedure. • Provide rust prevention treatment before long cessation of operation.

SECTION 8 - Bearing Failure Analysis

TYPES OF BEARING FAILURES AND DAMAGE

CRACKING, CHIPPING

DAMAGE	Possible Causes	Preventive Measures
Cracking in outer ring or inner ring	<ul style="list-style-type: none"> Excessive interference. Excessive fillet on shaft or housing. Heavy impact load. Advanced flaking or seizure 	<ul style="list-style-type: none"> Select proper fit. Adjust fillet on the shaft or in the housing to smaller than that of the bearing chamfer dimension. Re-examine load conditions.
Cracking on rolling elements	<ul style="list-style-type: none"> Heavy impact load. Advanced flaking. 	<ul style="list-style-type: none"> Improve mounting and handling procedure. Re-examine load conditions.
Cracking on the rib	<ul style="list-style-type: none"> Impact on rib during mounting. Excessive axial impact load. 	<ul style="list-style-type: none"> Improve mounting procedure. Re-examine load conditions.



BRINELLING, NICKS

Brinelling is a small surface indentation generated either on the raceway through plastic deformation at the contact point between the raceway and rolling elements, or on the rolling surfaces from insertion of foreign matter, when heavy load is applied while the bearing is stationary or rotating at a low rotation speed.

Nicks are those indentations produced directly by rough handling such as hammering.

DAMAGE	Possible Causes	Preventive Measures
Brinelling on the raceway or rolling contact surface	<ul style="list-style-type: none"> Entry of foreign matter 	<ul style="list-style-type: none"> Clean bearing and it's peripheral parts. Improve sealing devices.
Brinelling on the raceway surface at the same interval as the rolling element spacing	<ul style="list-style-type: none"> Impact load during mounting. Excessive load applied while bearing is stationary. 	<ul style="list-style-type: none"> Change mounting procedure. Improve machine handling.
Nicks on the raceway or rolling contact surface	<ul style="list-style-type: none"> Careless handling. 	<ul style="list-style-type: none"> Improve mounting and handling procedure.

BRINELLING



SECTION 8 - Bearing Failure Analysis

PEAR SKIN

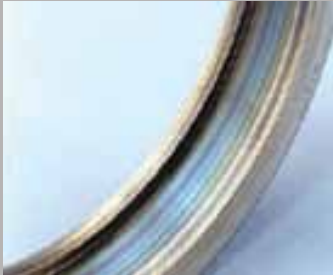

TYPES OF BEARING FAILURES AND DAMAGE

PEAR SKIN, DISCOLORATION

Pear skin is damage in which minute Brinell marks cover the entire rolling surface, caused by contamination. This is characterized by loss of luster and a rolling surface that is rough in appearance. In extreme cases, it is accompanied by discoloration due to heat generation. This phenomena is also commonly called frosting.

Discoloration is damage in which the surface color changes because of staining or heat generation during rotation.

Color change caused by rust and corrosion is generally separate from this phenomenon.

DAMAGE	Possible Causes	Preventive Measures
Indentation similar to pear skin on the raceway and rolling contact surface.	<ul style="list-style-type: none"> Entry of minute foreign matter 	<ul style="list-style-type: none"> Clean the bearing and its surrounding parts. Improve sealing device.
Discoloration of the raceway, surface rolling contact surface, rib face, and cage riding land.	<ul style="list-style-type: none"> Too small bearing internal clearance. Improper or insufficient lubricant. Deterioration of lubricant due to aging, etc. 	<ul style="list-style-type: none"> Provide proper internal clearance. Select proper lubricating method , amount and lubricant type.

SCRATCH & SCUFFING



SCRATCH & SCUFFING

Scratches are relatively shallow marks generated by sliding contact, in the same direction as the sliding. This is not accompanied by apparent melting of material.

Scuffing refers to surface marks, which are partially melted due to higher contact pressure and therefore a greater heat effect. Generally, scuffing may be regarded as an advanced case of scratches.

DAMAGE	Possible Causes	Preventive Measures
Scratches on raceway or rolling contact surface	<ul style="list-style-type: none"> Insufficient lubricant during start-up. Careless handling. 	<ul style="list-style-type: none"> Apply lubricant to the raceway and rolling contact surface when mounting. Improve mounting procedure.
Scuffing on rib face and roller end face	<ul style="list-style-type: none"> Improper or insufficient lubricant. Improper mounting. Excessive axial load. 	<ul style="list-style-type: none"> Select proper lubricating method or lubricant. Correct centering of axial direction.



SECTION 8 - Bearing Failure Analysis

TYPES OF BEARING FAILURES AND DAMAGE

SMEARING

Smearing is damage in which clusters of minute seizures cover the rolling contact surface. Since smearing is caused by high temperature due to friction, the surface of the material usually melts partially; and the smeared surfaces appear very rough in many cases.

DAMAGE	Possible Causes	Preventive Measures
Smearing on raceway or rolling contact surface	<ul style="list-style-type: none"> Improper or insufficient lubricant. Slipping of the rolling elements This occurs due to the break down of lubricant film when an abnormal self-rotation causes slip of the rolling elements on the raceway. 	<ul style="list-style-type: none"> Select proper lubricating method or lubricant. Provide proper preload.

RUST, CORROSION

Rust is a film of oxides, or hydroxides, or carbonates formed on a metal surface due to chemical reaction.

Corrosion is damage in which a metal surface is eroded by acid or alkali solutions through a chemical reaction (electrochemical reaction such as chemical combination and battery formation); resulting in oxidation.

It often occurs when sulfur or chloride contained in the lubricant additives is dissolved at high temperature. It can also occur when water becomes entrapped in the lubricant.

DAMAGE	Possible Causes	Preventive Measures
Rust partially or completely covering the bearing surface.	<ul style="list-style-type: none"> Improper storage condition. Condensation in atmosphere. 	<ul style="list-style-type: none"> Bearing should be stored in dry area. Improve sealing devices. Provide a preservative oil treatment before long cessation of operation.
Rust and corrosion at the same interval as rolling element spacing.	<ul style="list-style-type: none"> Contamination by water or corrosive matter 	<ul style="list-style-type: none"> Improve sealing devices.

SMEARING



RUST (CORROSION)



SECTION 8 - Bearing Failure Analysis

ELECTRIC PITTING



TYPES OF BEARING FAILURES AND DAMAGE

ELECTRIC PITTING

When an electric current passes through a bearing while in operation, it can generate sparks between the raceway and rolling elements through a very thin oil film, resulting in melting of the surface metal in this area. The resultant damage is referred to as a pit. When the pit is magnified, it appears as a hole like a crater, indicating that the material melted when it was sparking. When a bearing continues to operate under these conditions advanced form of pitting, called fluting, can occur.

WEAR



WEAR

Normally, wear on bearings is observed on sliding contact surfaces such as roller end faces and rib faces, cage pockets, and cage riding lands. However, wear caused by foreign material and corrosion can affect not only sliding surfaces but also rolling surfaces.



DAMAGE	Possible Causes	Preventive Measures
Wear on the contact surfaces (roller end faces, rib faces, cage pockets)	<ul style="list-style-type: none"> Improper or insufficient lubricant 	<ul style="list-style-type: none"> Select proper lubricating method or lubricant. Improve sealing device.
Wear on raceways and rolling contact surfaces	<ul style="list-style-type: none"> Entry of contaminants. Improper or insufficient lubricant. 	<ul style="list-style-type: none"> Clean the bearing and surrounding application component parts and housing.

SECTION 8 - Bearing Failure Analysis

TYPES OF BEARING FAILURES AND DAMAGE

FRETTING

Fretting occurs to bearings which are subject to vibration while in a stationary condition or which are exposed to slight axial movements. It is characterized by rust-colored wear particles. Fretting damage on the rotating ring is usually a clear indication of an improper fit. Since fretting on the raceways often appears similar to brinelling, it is sometimes called “false brinelling”.

DAMAGE	Possible Causes	Preventive Measures
Rust-colored wear particles generated on the fitting surface (fretting corrosion)	<ul style="list-style-type: none"> Insufficient interference fit 	<ul style="list-style-type: none"> Provide greater interference fit. Apply lubricant to the fitting surfaces.
Brinelling on the raceway surface at the same interval as rolling element spacing (false brinelling)	<ul style="list-style-type: none"> Vibration and oscillation when bearings are stationary. 	<ul style="list-style-type: none"> Improve fixing method of the shaft and housing. Provide means to insulate machine from vibrations and movement. Provide preload to bearing.

FRETTING



CREEPING

Creeping is a phenomenon in which bearing rings move relative to the shaft or housing during operation.

DAMAGE	Possible Causes	Preventive Measures
Wear, discoloration and scuffing, caused by slipping on the fitting surfaces	<ul style="list-style-type: none"> Insufficient interference fit. Insufficient tightening of sleeve. 	<ul style="list-style-type: none"> Provide greater interference fit. Proper tightening of sleeve.

CREEPING



SECTION 8 - Bearing Failure Analysis

TYPES OF BEARING FAILURES AND DAMAGE

CAGE DAMAGE



CAGE DAMAGE

Since cages are made of low hardness materials, external pressure and contact with other parts can easily produce dents and distortion. In some cases, these are aggravated and become chipped and cracked. Large chipping and cracks are often accompanied by deformation, which may reduce the accuracy of the cage itself and may prevent the smooth movement of rolling elements. Also, if cage damage is observed, the bearing raceways should be examined for misalignment, as even minor misalignment can cause cage breakage.

DAMAGE	Possible Causes	Preventive Measures
Flaws, distortion, chipping, cracking and excessive wear in cages. Loose or damaged rivets.	<ul style="list-style-type: none"> • Considerable vibration, impact loading. • Improper or insufficient lubricant. • Improper mounting (misalignment). • Dents made during mounting. • Rapid acceleration and very high speeds . 	<ul style="list-style-type: none"> • Re-examine load conditions. • Select proper lubricating method or lubricant. • Minimize mounting deviations and clearances. • Re-examine cage types. • Improve mounting.

SEIZURE



SEIZURE

Seizure is damage caused by excessive heating in bearings.

DAMAGE	Possible Causes	Preventive Measures
Discoloration, distortion and melting together of bearing components	<ul style="list-style-type: none"> • Too small internal clearance. • Improper or insufficient lubricant. • Excessive load. 	<ul style="list-style-type: none"> • Provide proper internal clearance. • Select proper lubricating method or lubricant. • Re-examine bearing type. • review maintenance & re-lubrication schedule.

PLEASE ALSO REFER TO THE PAGES FOLLOWING THIS SECTION FOR ADDITIONAL INFORMATION ON TROUBLESHOOTING BEARING PROBLEMS!

SECTION 8 - Bearing Failure Analysis

NOTES

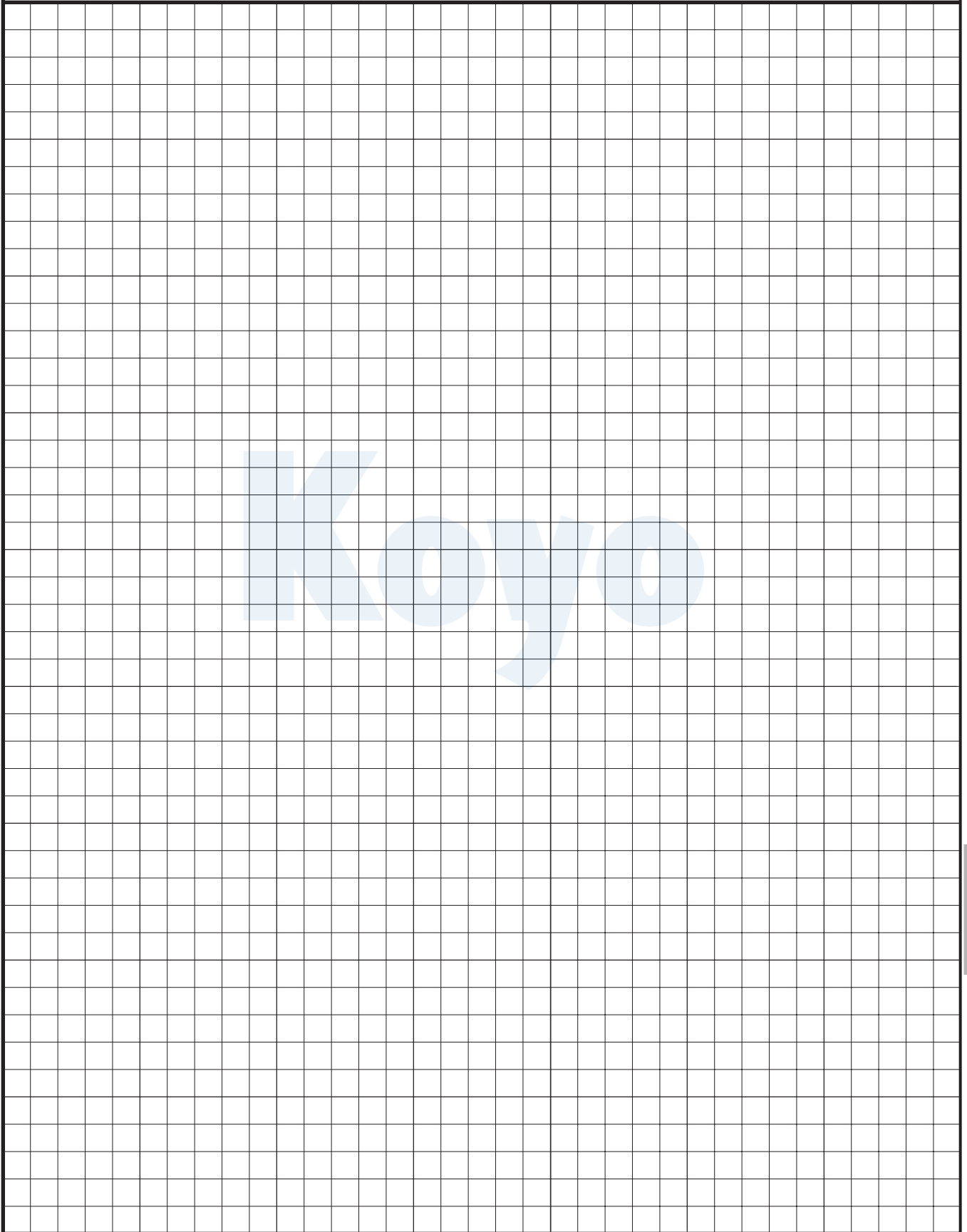

SECTION 9 - Trouble Shooting Bearing Problems

PROBLEM	POSSIBLE SOLUTIONS
<p style="text-align: center;">BEARING IS RUNNING HOT</p>	<ul style="list-style-type: none"> • Wrong type of grease or oil (check manufacturers specifications and maintenance records). • Inadequate amount of lubricant (check oil level and grease amount or leakage through seals). • Excessive amount of lubricant (oil is churning and not draining or bearing and surrounding cavity are completely filled with grease). • Lack of internal bearing clearance (initial bearing internal clearances too small for operating conditions or wrong fits were used). • Application design problem (misalignment between shaft housing bore, seats off taper or out-of-round, free-side bearing not able to float). • External source (bearing is running hot due to proximity to other heat generating equipment).
<p style="text-align: center;">BEARING IS NOISY</p>	<ul style="list-style-type: none"> • Lubrication problem (see comments above for wrong type and inadequate amount of lubricant). • Contamination of lubricant (foreign material such as grinding debris, sand, or dirt acting as an abrasive on rolling elements and raceway). • Excessive bearing internal clearance (initial bearing internal clearance is too great for operating conditions or wrong fits were used). • Handling or mounting damage (bearing rolling elements or raceways may be Brinelled or dented prior to or during mounting). • Application design problem (bearing rings may be spinning freely in housing or on shaft due too loose of fits or improper backing and clamping arrangement). • Other source (bearings may be transferring noise from gears, motor, pulley, or seals). • Fluting from electrical damage.
<p style="text-align: center;">BEARING AND SHAFT ARE VIBRATING</p>	<ul style="list-style-type: none"> • Contamination of lubricant (foreign material on rolling elements and raceways generating vibrations). • Handling or mounting damage (Brinelled or dented raceways and rolling elements). • Application design problem (excessive loose fits, bearing seats out-of-round, backings off square or fillet radii too large). • Excessive internal bearing clearance (wrong fits or incorrect initial bearing clearance for application). • External source (bearings can be transferring and amplifying vibrations generated by gearing or other machine components). • Bearing irregularities (since bearing rolling elements are never perfectly smooth and round, any grinding or machining irregularities may be adversely effected by dynamic forces with accelerations increasing vibrations).

SECTION 9 - Trouble Shooting Bearing Problems

PROBLEM	POSSIBLE SOLUTIONS
<p style="text-align: center;">SHAFT IS HARD TO TURN (Horse Power consumption is high)</p>	<ul style="list-style-type: none"> • Lubrication problem (can be either insufficient or excessive amount, or wrong viscosity) • Insufficient bearing clearance (initial bearing clearance is not correct for application or wrong fits are used) • Application design problem (bearing seats off-taper, out-of-round, backing shoulders off square, shaft & using misaligned, bearing cage interference with adjacent part). • Sealing problem (Seals are misaligned, seal housing bore is too small or wear seat OD too large, seals rubbing on a stationary part). • Bearing failure (bearing has seized or is badly spalled and is contaminated with debris wear) • Other possibilities (improper gear mesh or belt pulley Adjustment)
<p style="text-align: center;">EQUIPMENT OPERATION IS POOR (Bearings are being replaced frequently)</p>	<ul style="list-style-type: none"> • Wrong bearing was selected (bearing may not be adequate for application loading or too few bearing rows are being used). • Bearing and lubricant are contaminated (an abrasive or wear particulars may be preventing smooth operation of bearings and causing bearing damage). • Improper bearing clearance (too little or too great initial bearing clearance or wrong fits, bearings have too great of preload force). • Application design problem (Shaft OD or housing bore out-of-round or off taper, bearing seats misaligned, backings off-square). • Equipment maintenance problem (lubricant not Being checked or replaced when needed, improper Bearing mounting procedure or assembly of machine Components).

SECTION 9 - Trouble Shooting Bearing Problems

NOTES

Koyo

SECTION 10 - Glossary

“L10” LIFE – The total number of revolutions or hours until 90% of bearings being operated under the same conditions are left without flaking damage

ABEC RATING – Annular Bearing Engineers Committee rating system for bearing accuracy

ABMA – American Bearing Manufacturers Association a U.S. based organization for bearing standards

ANGULAR CONTACT BALL BEARING – Has contact angle between balls & rings commonly of 15, 30, or 40 deg.

AXIAL LOAD – Force on a bearing from a load parallel to the shaft centerline

BACKING SHOULDER – Shaft or housing surface used to back and retain a bearing inner or outer ring

BASIC DYNAMIC LOAD RATING – The radial or axial load rating of a bearing that will give the basic rated life of 1 million revolutions or 500 hours at 33 1/3 rpm.

BEARING BORE – Inside diameter of inner ring

BEARING CAGE – Retainer or guide used to separate rolling elements

BEARING CONE – Assembled inner ring of a tapered roller bearing

BEARING CONTACT ANGLE – Angle formed by the direction of the load applied to a bearing

BEARING CUP – Outer ring of a tapered roller bearing

BEARING INNER RING – Inner ring component for rolling elements

BEARING OUTER RING – Outermost ring for rolling element components

BEARING RACEWAYS – Paths and surfaces for rolling element components

BEARING SEATS – The shaft diameter and housing bore sections ground to accommodate a specific fit for a bearing's inner and outer rings

BEARING SERVICE LIFE – The number of revolutions or hours required for a bearing to exhibit flaking damage

BOUNDARY LUBRICATION – A breakdown of a lubricant hydrodynamic action allowing metal to metal contact between rolling elements and raceway surfaces

BRINELLING – A small surface indentation generated either on the raceway through plastic deformation or on the rolling surfaces due to heavy loading on a stationary or slow speed bearing

CASE CARBURIZED STEEL BEARINGS – The outer case is carburized to a full hardness level of 58 to 62 Rockwell C, while the core is a softer more ductile 40 to 45 Rockwell C.

CLEARANCE FIT – Indicates looseness or clearance between the rings and their seats

COLD MOUNTING – The mounting of bearing rings with the use of presses & fixtures and not temperature effects

CONRAD BEARING – Ball bearing type without fill slot for balls

CONTACT SEAL – Rubbing type of seals which employ at least one contacting lip

CONTAMINATION – Any foreign or unwanted substance in the lubricant that will have a negative effect on bearing operation and fatigue life

CREEP – Condition where bearing rings will move or spin relative to the shaft or housing during operation resulting in discoloration and wear on the mating surfaces

CYLINDRICAL ROLLER BEARING – Uses cylindrical rollers for line contact between rollers & raceways for greater radial load capacity

DEEP GROOVE BALL BEARING – Inner & outer rings that have uninterrupted grooved raceways

SECTION 10 - Glossary

DYNAMIC EQUIVALENT RADIAL LOAD – The single radial load that will result in the same bearing life as a combined radial and axial load condition

EXSEV BEARINGS – KOYO Specialty bearings for extreme application environments

FIXED POSITION – Bearing position which is not free to move with thermal growth, but locates shaft axially carries any axial loading, and effective clearance

FLAKING – Bearing damage where raceway or rolling element surface material will start to flake off

FLUID FILM LUBRICATION – Bearing loading is fully supported by the lubricant preventing contact of surface asperities

FOUR POINT CONTACT BALL BEARING – Uses Gothic arched raceways to create four points of contact between balls and raceway

FREE POSITION – Bearing position which is free to float and compensate for axial shaft growth or shrinkage

FRETTING (FALSE BRINELLING) – Rust colored wear that appears similar to raceway brinelling and normally occurs from vibrations on stationary bearings

FRICITION – Force that resists motion between two surfaces in contact

GREASE GUN – Hand operated mechanism for applying proper amount of grease to bearings when relubricating

GREASE LUBRICATION – Simplest lubrication system for bearings

HUB UNITS – Combines bearings, seals, shafts, and wheel hubs into a single package

HYDRODYNAMIC LUBRICATION – Ability of a lubricant through hydrodynamic forces alone to form a lubricant into a wedge shape creating a lubricant film condition

HYDROSTATIC LUBRICATION – A form of fluid film lubrication but with the addition of a pressurizing system

INDUCTION HEATER – For use to heat and expand bearing rings for proper fitting which uses heat produced by electromagnetic induction

INTERFERENCE FIT – Indicates the bearing inner ring bore is smaller than the shaft diameter or the outer ring outside diameter is larger than the housing bore seat

INTERNAL CLEARANCE – Can be either radial or axial and is the total distance that either the inner or outer ring can be moved while the other ring is held stationary

LUBRICANT VISCOSITY – A measurement of a lubricant's resistance to flow. The higher the viscosity, the higher the resistance to flow

MACHINED CAGE – Machined from steel, bronze, or phenolic resins into one piece cages

MISALIGNMENT – Normally refers to the degree of shaft bending and deflections from loading or machining inaccuracies of bearing seats

MOLDED CAGE – Nylon and polymer strengthened with glass and carbon are injection molded into cages

MOMENT LOAD – Load offset from shaft or bearing centerline which causes an overturning motion and load

NEEDLE ROLLER BEARING – Uses thin section cylindrical rollers for minimum cross section height

NON-CONTACT SEAL – Refers to sealing devices such as oil grooved closures and labyrinth designs that do not rub and contact the rotating surface

SECTION 10 - Glossary

NON-SEPARABLE BEARING – Integrated bearing assembly that is mounted together as a single unit such as a deep groove ball bearing or spherical roller bearing.

OIL BATH LUBRICATION – A bearing is partially submersed in a maintained oil level

OIL CIRCULATING SYSTEM – Oil is supplied to a bearing carrying away heat and is sent back to a tank through an oil drain pipe

OIL JET SYSTEM – Forced system that uses a nozzle to jet oil to bearings at a constant pressure

OIL MIST SYSTEM – Employs a mist generator and nozzles for spraying an oil mist on bearings

OIL SPLASH LUBRICATION – Makes use of a rotating gear or flinger to splash oil into a basin that will direct it to the bearings

OIL/AIR LUBRICATION – A system that pumps small quantities of oil to be mixed with compressed air to provide oil droplets through inlets directed to bearings

OPERATING CLEARANCE – The effective clearance with the additional effects of elastic deformations from application loading and temperature

PRELOAD – Axial load applied to tapered and angular contact ball bearings resulting in a axial deflection or negative axial clearance of the bearings or a radial preload from press fits.

RADIAL LOAD – Force on a bearing from a load perpendicular to the shaft centerline

RIVETED CAGE – Two piece stamped cages are riveted together, normally steel but can be bronze or phenolic resin

ROCKWELL HRC HARDNESS – Standard used for metals in determining the penetration hardness level

ROLL NECK BEARINGS – Four rows of cylindrical or tapered rollers in a matched bearing assembly for rolling mills

ROLLING ELEMENT – The rolling components (ball or rollers) of anti-friction bearing

ROLLING FRICTION – Force resisting motion between a ball or roller and another surface

RPM – “Revolutions Per Minute” used to express operating speed

SELF-ALIGNING BALL BEARING – Two rows of balls with a spherical outer raceway to compensate for misalignment

SEPARABLE BEARING – Inner and outer rings can be mounted separately such as a tapered or cylindrical roller bearing

SLEWING RIM BEARING – Available in various configurations for carrying large moment and overturning loads

SLIDING FRICTION – The resisting force between two flat surfaces

SMEARING – Phenomenon where clusters of minute seizures cover the rolling contact surfaces

SPANNER WRENCH – Used for turning locknuts and adjusting bearings

SPHERICAL ROLLER BEARING – Self-aligning bearing using two sets of convex rollers separated by a center rib or ring

STAMPED CAGE – Normally are one or two pieces made from steel, stainless steel, aluminum, or bronze

STATIC LOAD RATING – The static load or impact load level which when applied to a stationary bearing will produce a permanent deformation

SUPER FINISHING – Lapping, honing, and coating processes used to obtain surface finishes within several micro-inches

SECTION 10 - Glossary

TAPERED ROLLER BEARINGS – Tapered rollers and raceways used for both radial and thrust load capacity

THROUGH-HARDENED STEEL BEARINGS – A high carbon chromium steel, such as SUJ2 or 52100, heat treated to obtain a through hardness level of 58 to 62 Rockwell C.

THRUST BEARING – Uses either balls or rollers with shaft and housing ring washers for support of thrust loading only

TRANSITION FIT – The inner ring bore or the outer ring O.D. can be either slightly loose or slightly tight when mounted on their seats

NOTES

A large grid area for taking notes, consisting of a 30x30 grid of small squares. A faint, light blue watermark of the word "Koyo" is centered horizontally and vertically within the grid.

SECTION 10 - Glossary

NOTES

Koyo

NOTES

A large grid area for taking notes, consisting of a 30x30 grid of small squares. A faint, light blue watermark of the word "Koyo" is centered horizontally and vertically within the grid.

SECTION 10 - Glossary

NOTES

Koyo

WE ARE KOYO

Our parent company, JTEKT Corporation, is one of the world's leading manufacturers of bearings and automotive steering assemblies, with a multitude of manufacturing plants overseas and annual sales exceeding seven billion dollars.

JTEKT Corporation and Koyo Corporation of U.S.A. are ISO/TS16949 and ISO 14001 certified.

Koyo Corporation of U.S.A. employs approximately 1,000 people and operates three bearing plants located in Orangeburg and Richland, South Carolina, as well as Washington, Tennessee, one forging plant located in Georgetown, Kentucky and one steering assembly plant located in Daleville, Virginia.

Koyo Corporate Headquarters is located in Westlake, Ohio. Distribution centers are located in Westlake, Ohio; Memphis, Tennessee and Reno, Nevada.

Full service facility for engineering and technical services, including bearing analysis, design, testing and inspection. The Technical Center is also home to Koyo Steering Systems of U.S.A. Inc. which includes sales, service, spare parts, training and demonstration capabilities.

Primary activities-evaluation, design and testing of bearings and components, investigation of testing parts, new product development, bearing and component design and North American bearing application engineering support.

Equipment testing. Bearing durability tests with variable loads, speeds and times for automotive wheel, engine and transmission applications.

Bearing durability testing for agricultural, electric motor, machine tool and other industrial applications.

Analysis. Dimensional measurement, metallurgical analysis, grease and vibration analysis and metrology lab.

At Koyo, our objective is to provide easy, convenient access to Koyo products, capabilities and services. Our mission is to reinforce the Koyo philosophy of delivering innovation and technology, quality products and superior customer service...



The Koyo Training Vehicle (KTV) has been designed and equipped with a variety of features and benefits to allow for maximum flexibility for use anywhere in the country. Examples of how Koyo utilizes this training vehicle include:

- **Training Classes**
- **Open Houses**
- **Trade shows**
- **Special Events**
- **Sales Presentations**

Koyo's KTV can be available for your event. Simply contact Koyo's U.S. Corporate office at (440) 835 -1 000 Ext: 2251. From Corporate Headquarters. we will connect you with your local Koyo Representative.

Koyo



Corporation of U.S.A.



KOYO CORPORATION OF U.S.A. SALES DIVISION

29570 Clemens Road
Westlake, Ohio 44145
Tele: (440) 835-1000
Fax: (440) 835-9347
Web: www.koyousa.com

KOYO CORPORATION OF U.S.A. REGIONAL OFFICES

NORTH CENTRAL REGION

20603 W. 88th Terrace
Lenexa, KS 66220
Tele: (913) 829-1124
Fax: (913) 829-2297
Customer Svc: 1-800-328-5696

NORTHEASTERN REGION

3249 Carriage Way
Stow, Ohio 44224
Tele: (330) 677-5081
Fax: (330) 677-5082
Customer Svc: 1-800-348-5696

SOUTHERN REGION

1867 Independence Square, Ste. 200
Atlanta, Georgia 30338
Tele: (770) 352-3425
Fax: (770) 352-3416
Customer Svc: 1-800-328-5696

WESTERN REGION

4040 Douglas Way, Ste. 116
Lake Oswego, Oregon 97034
Tele: (503) 699-7355
Fax: (503) 699-7519
Customer Svc: 1-800-331-5696

KOYO CORPORATION OF U.S.A. WAREHOUSES

NEVADA

640 Maestro Drive, Suite 103
Reno, NV 89511

OHIO

29570 Clemens Road
Westlake, OH 44145

TENNESSEE

Southridge Corporate Park
4903 Southridge Blvd.
Memphis TN 38141

KOYO CORPORATION OF U.S.A. MANUFACTURING DIVISIONS

Orangeburg, South Carolina
Richland, South Carolina
Washington, Tennessee