

Care and Maintenance of Bearings





Explanation of the Photos. These are microscopic photographs of peeling damage generated on the surface of a ball/roller bearing. Peeling can occur when the surface roughness is high, or when the lubrication performance is poor. Peeling has a flat-colored appearance, and when observed under a microscope, shows minute flaking and cracks. The top photo shows an example of minute flaking interconnected with cracks. The photo in the middle shows an example of partial separation of the surface, occurring after a number of areas where minute flaking occurred have been connected. This is often seen when grease lubrication is used. The bottom photo shows an example in which a directionality is seen in the minute flaking. The example also shows cracks due to slippage.

Care and Maintenance of Bearings (Revised)

We thank you for your interest in **NTN** bearings.

This booklet is intended as a guide to bearing maintenance, with the main consideration being on-site bearing maintenance.

Bearings may fail earlier than the expected rolling fatigue life. Early failure is mostly attributable to inadequate handling or maintenance.

We will be pleased if this guide book assists the user in preventing early bearing failure or in troubleshooting the causes of bearing failure.

Care and Maintenance of Bearings

Contents

1.	Introduction	5
2.	Inspection of Bearings	5
3.	Inspection When Machine is Running	5
3.1	Bearing Temperature	5
3.2	Operating Sounds of Bearing	5
3.3	Vibration of Bearing.....	7
3.4	Lubricant Selection	7
3.5	Relubrication	7
4.	Check of Bearings after Operation	9
5.	Bearing Failures and Solutions	9
5.1	Flaking	10
5.2	Peeling	12
5.3	Spalling	13
5.4	Smearing	15
5.5	Wear	15
5.6	Speckles and Discoloration	16
5.7	Indentations	17
5.8	Chipping	18
5.9	Cracking	19
5.10	Rust and Corrosion	20
5.11	Seizing	21
5.12	Fretting and Fretting Corrosion	22
5.13	Electrical Pitting	23
5.14	Rolling Path Skewing	24
5.15	Damage to Retainers	25
5.16	Creeping	26

1. Introduction

The rolling-contact bearing is an element of machinery with a very important role, and it dominates the performance of the machine. If one of the bearings breaks or seizes, not only the machine but also the assembly line may stop. If one of the axle bearings of an automobile or a railway car breaks down, a serious accident could occur.

To avoid trouble, every bearing manufacturer should make efforts to assure the highest quality for each bearing, and should emphasize that the user carefully handle and maintain all bearings.

Every bearing becomes unserviceable in the course of time even if it is installed correctly and operated properly. The raceway surfaces and the rolling contact surfaces of the rolling elements are repeatedly subjected to compressive loads, and the surfaces eventually flake.

The life of a rolling-contact bearing is defined as the total number of revolutions (or the number of operation hours at a given constant speed) before flaking occurs.

The bearing may also become unserviceable because of seizing, breakage, wear, false brinelling, corrosion, etc.

These problems are caused by improper selection or handling of the bearing. The problems are avoidable by correct selection, proper handling and maintenance, and are distinguished from the fatigue life of the bearing.

However, breakdowns due to improper application, bearing design, and maintenance are more frequent than flaking due to rolling fatigue in the field.

2. Inspection of Bearings

Inspection of a machine's bearings during operation is important to prevent unnecessary bearing failure. The following methods are generally adopted to inspect the bearing.

(1) Check of bearings in operation

Included are the check of bearing temperature, noise, and vibration, and the examination of the properties of lubricant to determine when lubricant should be replenished or exchanged.

(2) Inspection of bearings after operation

Any change of the bearing is carefully examined after operation and during periodic inspections so as to take measures to prevent recurrence.

It is important for proper bearing maintenance to determine inspection requirements and intervals, according to the importance of the system or machine, and adhere to the established schedule.

3. Inspection When Machine is Running

3.1 Bearing Temperature

Bearing temperature generally rises with start-up and stabilizes at a temperature slightly lower than at start-up (normally 10 to 40°C higher than room temperature) in a certain time. The time before stabilizing depends on the size, type, speed, and lubrication system of the bearing and the heat dissipation condition around the bearing. It ranges from about 20 minutes to as long as several hours. If bearing temperature does not stabilize but continues to rise, the causes shown in Table 3.1 are conceivable. Operation should be stopped and an appropriate corrective action should be taken.

High bearing temperature is not desirable in view of maintaining an adequate service life and preventing lubricant deterioration. A desirable bearing temperature is generally below 100°C.

Table 3.1 Major causes of high bearing temperature

-
- (1) Extremely insufficient or excessive lubricant
 - (2) Poor installation of the bearings
 - (3) Extremely small bearing clearance or extremely heavy load
 - (4) Extremely high friction between lip and seal groove
 - (5) Improper lubricant type
 - (6) Creep between the fitting surfaces
-

3.2 Operating Sound of Bearing

The following Table 3.2 lists typical abnormal bearing sounds and their causes. Please note that the description of some of these sounds is rather subjective and thus could vary considerably from person to person.

Table 3.2 Typical Abnormal Bearing Sounds and Their Causes

Sound	Features	Causes
Hiss	Small Bearings	Raceway, ball or roller surfaces are rough.
Buzz to Roar	Loudness and pitch change with speed.	Resonation Poor fit (Poor shaft shape) Bearing rings deformed. Vibration of raceways, balls, or rollers (For large bearings, if this sound is minor, then this is considered normal). Brinelling
Crunch	Felt when the bearing is rotated by hand.	Scoring of raceway surface (regular). Scoring of balls or rollers (irregular). Dust/Contamination Deformed bearing ring (partial interference clearance).
Hum	Disappears when power supply is switched off.	Electromagnetic sound of motor.
Chatter	Noticeable at low speeds. Continuous at high speeds.	Bumping in cage pockets (insufficient lubricant)(Eliminated by clearance reduction or pre-loading. Rollers bumping into each other on full-roller bearing.
Clang/Clatter	Metallic, loud bumping sound. Thin section large bearing (TTB) at low speeds.	Bearing ring deformed. Grating of key.
Screech/Howl	Occurs mainly on cylindrical roller bearings. Sound changes with speed. Loud metallic sound that disappears temporarily when grease is added.	Large radial clearance. Poor lubrication/grease consistency.
Squeak	Metal-to metal spalling sound. High pitch	Spalling of roller and rib of roller bearing. Small clearance Poor lubrication
Squeal	Generated irregularly due to grating.	Slip on fitting surfaces. Grating on mounting seat, of key, etc.
Faint tinkle	Irregular (not changing with speed). Primarily on small bearings.	Dust in bearing.
Rustle	Sound quality remains the same even if speed changes (Dirt). Sound quality changes with speed (Scoring).	Dirt Raceway, ball, or roller surfaces are rough.
Rustle	Generated intermittently at regular intervals.	Chafing at the labyrinth. Contact of cage and seal.
Rustle patter	Regular and continuous at high speed.	Generated by retainer. Normal if sound is clear. Grease is inadequate if sound is generated at low temperatures (Use soft grease). Wear of cage pockets. Insufficient lubricant. Low bearing load.
Growl	Continuous at high speeds.	Scoring on raceway, balls, or rollers.
Quiet Fizzing/Poping	Generated irregularly on small bearings.	Bursting sound of bubbles in grease.
Large Sound Pressure	Large Sound Pressure	Rough raceway, roller, or ball surfaces. Raceway, rollers, or balls are deformed by wear. Large clearance due to wear.

3.3 Vibration of Bearing

Damage to the bearing can be detected early by measuring the vibration of the machine. The degree of damage is inferred from quantitative analysis of the amplitude and frequency of the vibration. However, values measured differ depending on the measuring point and the operating condition of the bearing. It is desirable to accumulate measurement data and establish evaluation criteria for each machine.

3.4 Lubricant Selection

The purpose of lubrication the bearing is to cover the rolling contact surfaces and sliding contact surfaces with a thin oil film to avoid direct metal-to-metal contact. Effective lubrication of the rolling-element bearing has the following effects.

- (1) Reduces friction and abrasion
- (2) Transports heat generated by friction
- (3) Prolongation of service life
- (4) Prevents rust (corrosion)
- (5) Keeps foreign objects (or contamination) away from rolling elements and raceways

For these purposes, a lubricant should be selected by referring to the following criteria:

(1) Grease lubrication

Grease is generally used for lubricating rolling-element bearings because it is easy to handle and simplifies the sealing system.

Carefully examine the type and properties of the base oil, thickener and additives of the grease, and select a grease appropriate for the operating condition of the bearing. The general relation between consistency of grease and the application of the bearing is given in Table 3.3. The types and properties of greases are given in the bearing section of the **NTN** general catalog.

Table 3.3 Consistency of Grease

NLGL consistency No.	JIS(ASTM) consistency after 60 workings	Application
0	355-385	Centralized lubrication
1	310-340	Centralized lubrication
2	265-295	General, prelubricated bearing
3	220-250	General, high temperature
4	175-205	Special applications

(2) Oil lubrication

Oil lubrication is generally suitable for high speed or high temperature operations. It is also suitable for carrying heat away from the bearing.

Oil viscosities required for the operating temperatures of bearings are given in Table 3.4.

Carefully study the viscosity, viscosity index, oxidation resistance, corrosion resistance, foaming resistance, etc. to select an oil. Table 3.5 gives a guide for selecting viscosity.

Fig. 3.1 shows the variation of viscosity with temperature for several lubrication oils. Use Table 3.5 to select an oil with an adequate viscosity for the operating temperature of the bearing.

Table 3.4 Viscosities Required for Operating Temperature of Bearings

Bearing Type	Kinematic viscosity mm ² /s
Ball, cylindrical roller and needle roller bearings	13
Self-aligning roller bearings, tapered roller bearings and thrust needle roller bearings	20
Self-aligning thrust roller bearings	30

3.5 Relubrication

In grease lubrication, the lubricating characteristic of grease deteriorates with operating hours, thus requiring relubrication of the bearing at appropriate intervals. Relubrication intervals of grease depend on the type, dimensions, and speed of the bearing, and the type of grease.

A line diagram serving as a rough guide of grease relubrication intervals, is given in the bearing section of the **NTN** general catalog.

For oil lubrication, oil changing intervals depend on the operating condition of the machine and the type of lubrication system (a rough guide to oil changing intervals and for oil analysis intervals is given in Tables 3.6 and 3.7).

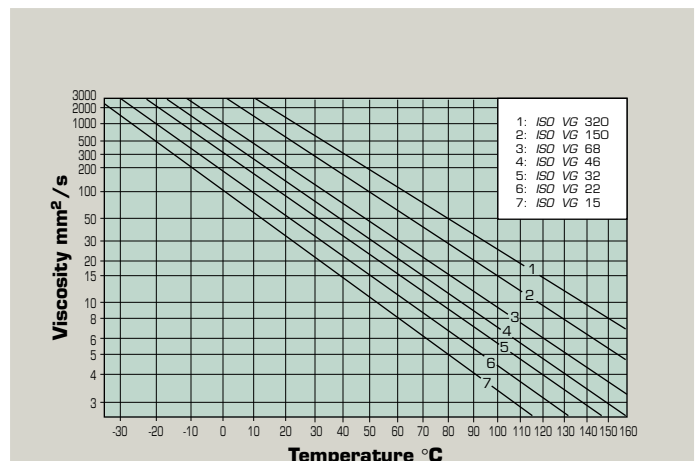

Fig. 3.1 Lubrication oil viscosity-temperature line diagram

Table 3.5 Selection Guide For Lubrication Oil Viscosity

Bearing operating temperature °C	dn value x10 ⁴	ISO viscosity grade of oil (VG)		Applicable bearing types
		Normal load	Heavy or impact load	
-30~0	Up to allowable speed	22 32	46	All types
0~60	~ 1.5	46 68	100	All types
	1.5~8	32 46	68	All types
	8~15	22 32	32	Except for thrust ball bearings
	15~50	10	22 32	Single row radial ball bearings Cylindrical roller bearings
60~100	~ 1.5	150	220	All types
	1.5~8	100	150	All types
	8~15	68	100 150	Except for thrust ball bearings
	15~50	32	68	Single row radial ball bearings Cylindrical roller bearings
100~150	Up to allowable speed	320		All types
0~60	Up to allowable speed	46	68	
60~100	Up to allowable speed	150		Self-aligning roller bearings

Remarks

1. The table above is applicable to oil bath lubrication and recirculation lubrication.
2. Consult NTN if your operating condition is not shown in the table.

Table 3.6 Lubrication Oil Properties and Serviceable Limits

Property	Serviceable limit		Remarks
	Circulating oil	Gear oil	
Viscosity Deterioration mm ² /s	Less than 10%	25% max., 10 to 15% is preferable	Caused by oxidation or mixing with different type of oil.
Water content in volume %	0.2 max.	0.2 max.	May be reusable after water removal
Insoluble matter in weight	Normal	1.0 max.	Additive carbon particles Dust
	Pentane % Benzene %	0.5 max.	
Sedimentation value ml/10ml	0.1 max.		Contaminants such as water and dust, or worn metal particles.
Total acid value KOHmg/g	2 to 3 times that of new oil		Adopt higher value according to additives
Ash %	—	0.2 max.	
Iron content in ash %	—	0.1 max.	

Table 3.7 Frequency of Lubricating Oil Analysis

Lubrication system	Inspection interval	
	Normal operating conditions	Severe operating conditions
Disk lubrication method	One year	6 months
Oil bath or splash lubrication	6 months	3 months
Circulating lubrication	9 months	1 to 3 months

Severe operating conditions means:

- (1) Severe water condensation or ingress
- (2) Excessive ingress of dust, gas, etc.
- (3) Operating temperature exceeding 120°C

Bearings after operation and those removed during periodic inspection should be carefully checked visually for systems on each component to evaluate whether the bearings' operating conditions are satisfactory.

If any abnormality is detected, find the cause and apply a remedy by checking the abnormality against the failure cases given in Section 5. "Bearing Failures and Solutions."

The bearing is generally usable up to the end of the rolling fatigue life if handled properly. If it fails earlier, it may be due to some fault in the selection, handling, lubrication, and/or mounting of the bearing.

It is sometimes difficult to determine the real cause of bearing failure because many interrelated factors are possible. It is, however, possible to prevent the recurrence of similar problems by considering possible causes according to the situation and condition of the machine on which the bearings failed. Also, installation location, operating conditions, and surrounding structure of the bearings should be taken into consideration.

Bearing failures are classified and illustrated in photos in this section. Use the section as a guide for troubleshooting.

Figures 5.1 to 5.7 show the names of bearing parts referred to in the descriptions of the failure cases.

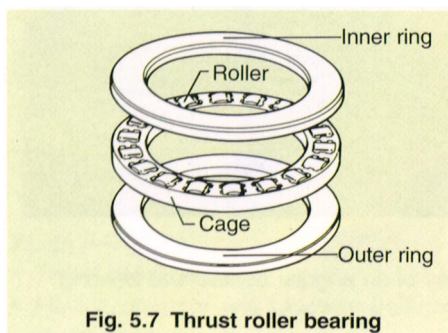
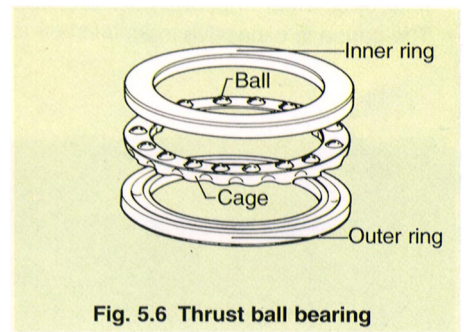
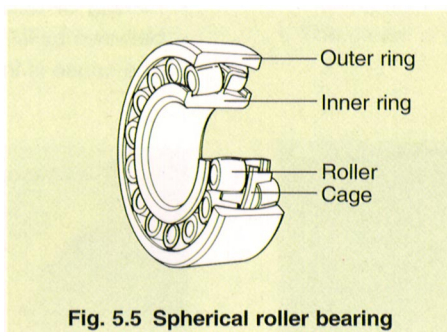
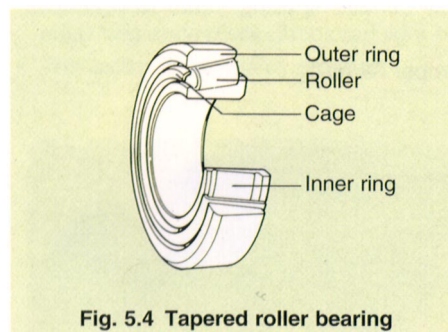
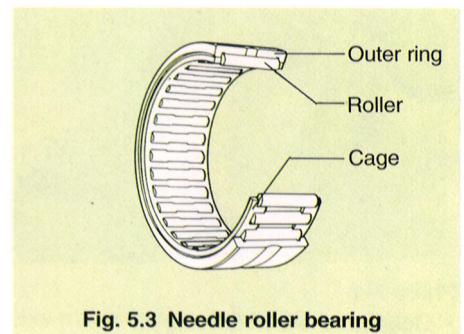
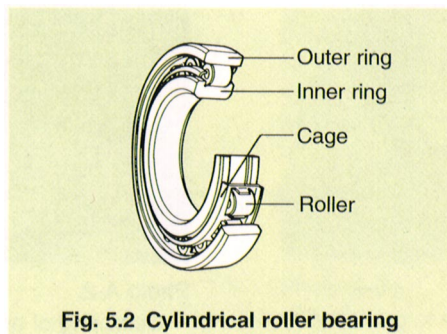
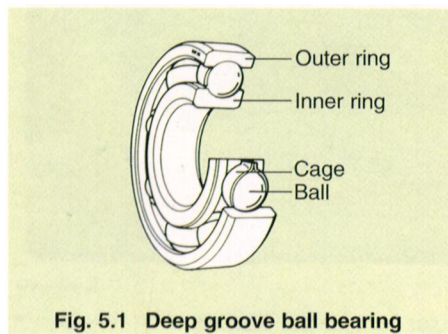

5.1 Flaking

Condition	Cause	Solution
Raceway surface is flaked Surface after flaking is very rough.	Rolling fatigue. Flaking may be caused early by over-load, excessive load due to improper handling, poor shaft or housing accuracy, installation error, ingress of foreign objects, rusting, etc.	<ol style="list-style-type: none"> (1) Find the cause of the heavy load. (2) Examine operating conditions and adopt bearings with larger capacity as necessary. (3) Increase viscosity of oil and improve lubrication system to form an adequate lubricating oil film. (4) Eliminate installation errors.



Photo A-1

- Deep groove ball bearing.
- Inner ring, outer ring, and balls are flaked.
- The cause is excessive load.



Photo A-2

- Outer ring of angular contact ball bearing
- Flaking of raceway surface spacing equal to distances between balls.
- The cause is improper handling.

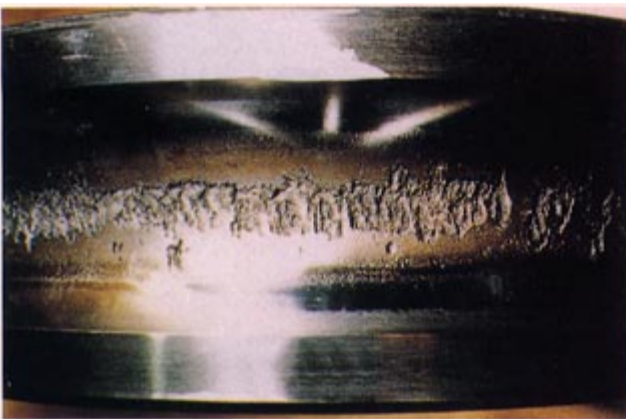

Photo A-3

- Inner ring raceway of a deep groove ball bearing



Photo A-4

- Outer ring raceway of an angular contact ball bearing



Photo A-5

- Inner ring of deep groove ball bearing
- Flaking on one side of the raceway surface
- The cause is an excessive axial load.



Photo A-6

- * Inner ring of spherical roller bearing.
- * Flaking only on one side of the raceway surface.
- * The cause is an excessive axial load.

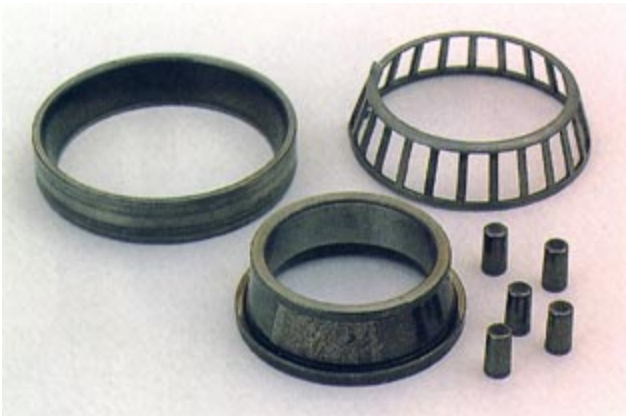

Photo A-7

- Tapered roller bearing
- Flaking on 1/4 circumference of inner ring raceway with outer ring and rollers discolored light brown.
- The cause is excessive pre-load.



Photo A-8

- Outer ring of double row angular contact ball bearing.
- Flaking on 1/4 circumference of outer ring raceway.
- The cause is poor installation.



Photo A-9

- Thrust ball bearing
- Flaking on inner ring raceway (bearing ring fastened to shaft) and balls.
- The cause is poor lubrication.



Photo A-10

- Outer ring raceway of double row tapered roller bearing (RCT bearing)
- Flaking originated from electric pitting on the raceway surface (refer to Section 5.13 "Electrical Pitting")

5.2 Peeling

Condition	Cause	Solution
Peeling is a cluster of very small spalls (size about 10 μ m). Peeling can also include very small cracks which develop into spalls.	Likely to occur in roller bearings. Tends to occur if surface of opposite part is rough or lubrication characteristics are poor. Peeling may develop into flaking.	(1) Control of surface roughness and dust (2) Selection of appropriate lubricant (3) Proper break-in



Photo B-1

- Rollers of spherical roller bearing
- Peeling on rolling contact surfaces
- The cause is poor lubrication.



Photo B-2

- Tapered roller bearing
- Development of peeling to flaking on inner ring and rollers
- The cause is poor lubrication.

5.3 Spalling

Condition	Cause	Solution
Score accompanying seizing. Mounting score in axial direction. Scores on roller end face and guide rib-cycloidal scores. Scratches in spinning direction on raceway surface and rolling contact surfaces.	Poor mounting and removing practice. Oil film discontinuation on the contact surface due to excessive radial load, foreign object trapping, or excessive pre-load. Slippage or poor lubrication of rolling elements.	(1) Improvement in mounting and removing procedures. (2) Improvement in operation conditions (3) Correction of pre-load (4) Selection of adequate lubricant and lubrication system (5) Improvement of sealing efficiency



Photo C-1

- Inner ring of cylindrical roller bearing
- Spalling on rib
- The cause is excessive load.



Photo C-2

- Inner ring of cylindrical roller bearing
- Spalling on raceway surface and cone back face rib
- The cause is poor lubrication.



Photo C-3

- Rollers of tapered roller bearing
- Cycloidal spalling on the end faces (Scuffing)
- The cause is poor lubrication.



Photo C-4

- Roller of cylindrical roller bearing
- Score in axial direction on rolling contact surface caused during mounting.
- The cause is poor mounting practice.

5.4 Smearing

Condition	Cause	Solution
Surface is roughened and tiny particles adhere.	Rolling elements slip in rolling motion and characteristics of lubricant are too poor to prevent slippage.	<ol style="list-style-type: none"> (1) Select optimum lubricant and lubrication system capable of forming sound oil film. (2) Use a lubricant including extreme pressure additive. (3) Take precautions such as a small radial clearance and pre-load to prevent slippage.

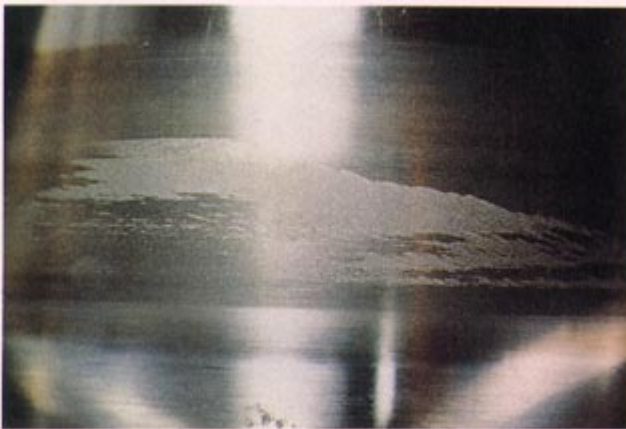

Photo D-1

- Inner ring of cylindrical roller bearing
- Smearing on raceway surface
- The cause is slippage of rollers due to foreign objects trapped within.

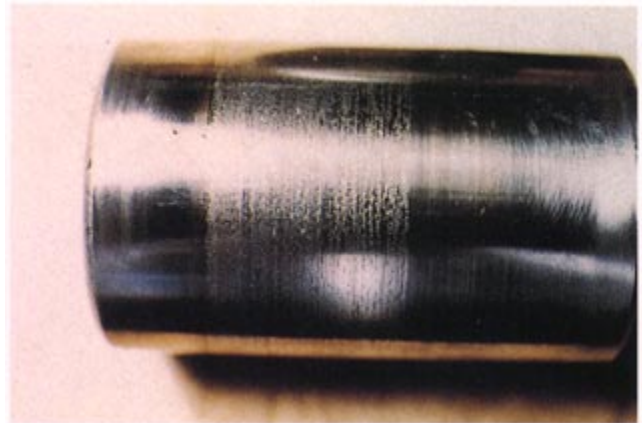

Photo D-2

- Roller of same bearing as that of the inner ring shown in Photo D-1
- Smearing on rolling contact surface
- The cause is slippage of rollers due to foreign objects trapped within.



Photo D-3

- Rollers of spherical thrust roller bearings
- Smearing at middle of rolling contact surfaces
- The cause is slippage of rollers due to foreign objects trapped within.

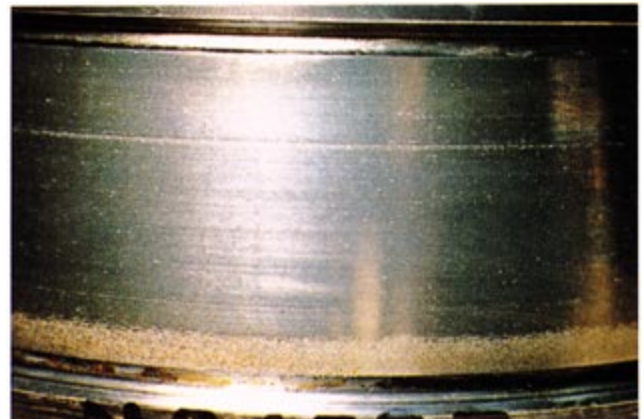

Photo D-4

- Inner ring of double row tapered roller bearing (RCT bearing)
- Smearing on raceway surface

5.4 Stepped wear

Condition	Cause	Solution
Surface is worn and dimensions are reduced compared with other portions. Surface mostly roughened and scored.	Ingress of solid foreign objects. Dirt and other foreign objects in lubricant. Poor lubrication. Skewing of rollers.	(1) Selection of optimum lubricant and lubrication system (2) Improvement in sealing efficiency (3) Filtration of lubricating oil (4) Elimination of misalignment



Photo E-1

- Outer ring of cylindrical roller bearing
- Stepped wear on raceway surface
- The cause is poor lubrication.



Photo E-2

- Inner ring of cylindrical roller bearing (inner ring of which is shown in Photo E-1)
- Stepped wear on full circumference of raceway
- The cause is poor lubrication.



Photo E-3

- Outer ring of double row angular contact ball bearing (hub unit bearing)
- Wear on one side of the raceway
- The cause is poor lubrication.

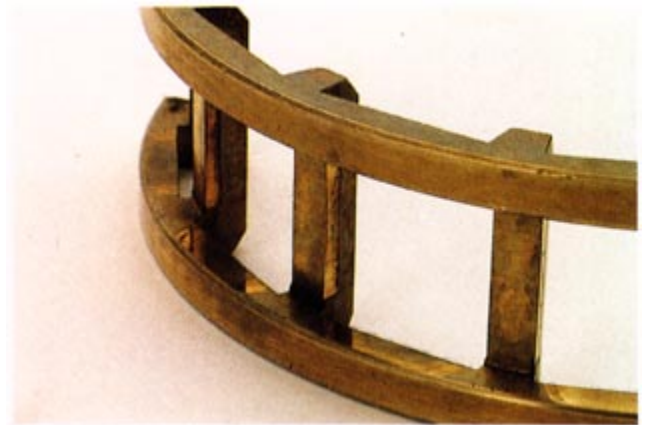

Photo E-4

- Retainer of cylindrical roller bearing
- Wear of pockets of machined high tensile brass casting retainer (G1)

5.6 Speckles and Discoloration

Condition	Cause	Solution
<p>Speckles</p> <p>Raceway surface is matted and speckled.</p> <p>Speckles are clusters of tiny dents.</p> <p>Discoloration</p> <p>The surface color has changed.</p>	<p>Ingress of foreign objects</p> <p>Poor lubrication</p> <p>Temper color by overheating(2)</p> <p>Deposition of deteriorated oil on surface</p>	<p>Speckles</p> <p>(1) Improvement in sealing efficiency</p> <p>Filtration of oil</p> <p>(3) Improvement in lubrication system</p> <p>Discoloration</p> <p>(1) Oil deposition is removable by wiping with an organic solvent (oxalic acid).</p> <p>(2) If roughness is not removable by polishing with sandpaper, it is rust or corrosion. If completely removable, it is temper color due to overheating.</p>



Photo F-1

- Inner ring of double row tapered roller bearing (RCT bearing)
- Raceway surface is speckled
- The cause is electric pitting.



Photo F-2

- Ball of deep groove ball bearing
- Speckled all over
- The cause is foreign objects and poor lubrication.



Photo F-3

- Outer ring of spherical roller bearing
- Partial oil deposition on raceway surface



Photo F-4

- Spherical roller bearing
- Discoloration of inner and outer ring raceway surfaces
- The cause is deterioration of lubricant.

5.7 Indentations

Condition	Cause	Solution
Hollows in raceway surface produced by solid foreign objects trapped or impacts (False brinelling)	Ingress of solid foreign objects Trapping of flaked particles Impacts due to careless handling	(1) Keeping out foreign objects (2) Check involved bearing and other bearings for flaking if dents are produced by metal particles. (3) Filtration of oil (4) Improvement in handling and mounting practices

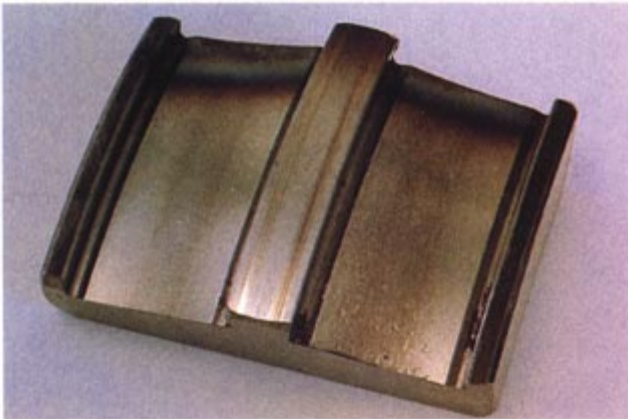

Photo G-1

- Inner ring (cut off piece) of self-aligning roller bearing
- Dents on one side of the raceway
- The cause is trapping of solid foreign objects.



Photo G-2

- Rollers of spherical roller bearing
- Dents on rolling contact surfaces
- The cause is trapping of solid foreign objects.



Photo G-3

- Rollers of tapered roller bearings
- Dents all over rolling contact surfaces. (Temper color at two ends.)
- The cause is foreign objects carried by lubricating oil.

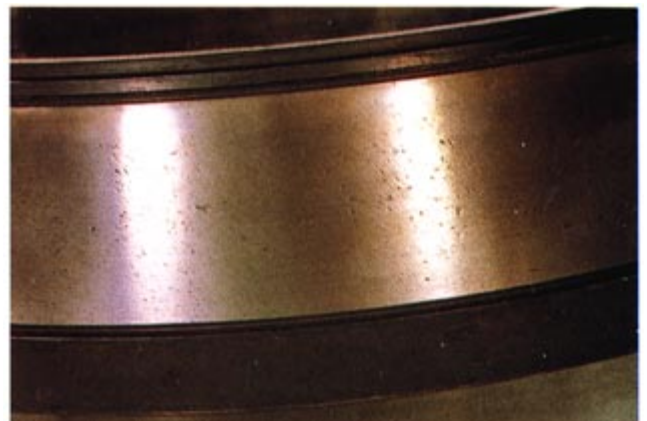

Photo G-4

- Inner ring of tapered roller bearing
- Dents on raceway surface
- The cause is trapping of foreign objects.

5.8 Chipping

Condition	Cause	Solution
Partial chipping of inner ring, outer ring, or rolling elements.	Trapping of large solid foreign objects Impact or excessive load Poor handling	(1) Trouble shooting and improvements of impacts and excessive load (2) Improvement in handling (3) Improvement in sealing characteristics



Photo H-1

- Cylindrical roller bearing
- Chipping of guide ribs of inner and outer rings
- The cause is excessive impact load.



Photo H-2

- Inner ring of spherical roller bearing
- Rib chipped
- The cause is excessive impact load.



Photo H-3

- Inner ring of tapered roller bearing
- Chipping of cone back face rib
- The cause is impact due to poor mounting.

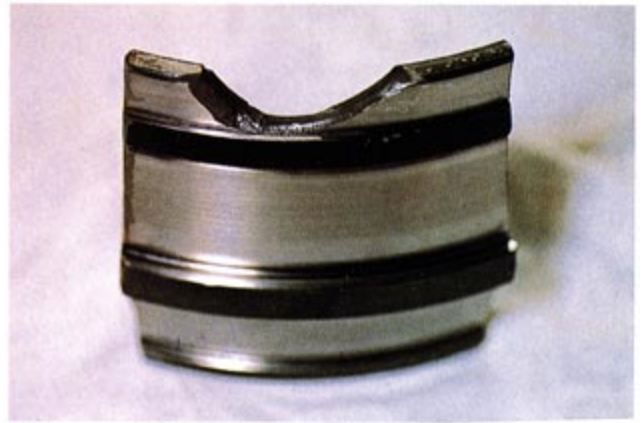

Photo H-4

- Inner ring of double row tapered roller bearing
- Chipping of side face
- The cause is impact due to improper handling.

5.9 Cracking

Condition	Cause	Solution
Splits, and cracks in bearing rings and rolling elements.	Excessive load Excessive impacts Overheating by creeping and rapid cooling Very loose fit Large flaking	(1) Examination and improvement of cause of very large load (2) Prevention of creep (3) Correction of fit

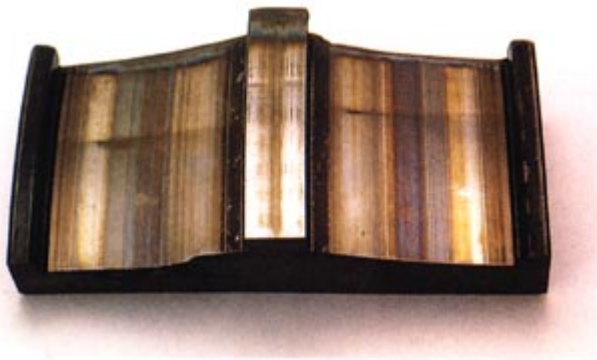

Photo I-1

- Inner ring of spherical roller bearing
- Split of raceway surface in the axial direction
- The cause is excessive interference fit.

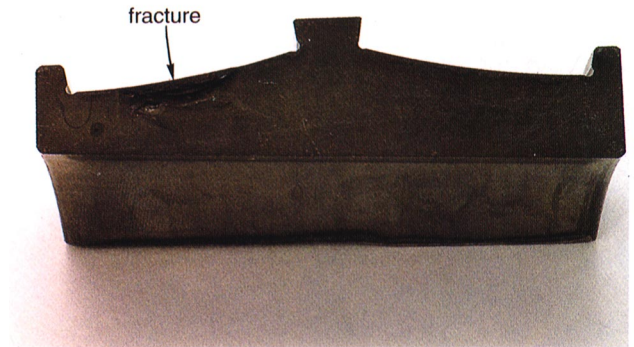

Photo I-2

- Fracture of inner ring shown in Photo I-1
- Originating point is observed at the middle of the left raceway surface.



Photo I-3

- Outer ring of four-row cylindrical roller bearing
- Split of raceway surface in the circumferential direction, originated from large flaking.
- The cause is large flaking.

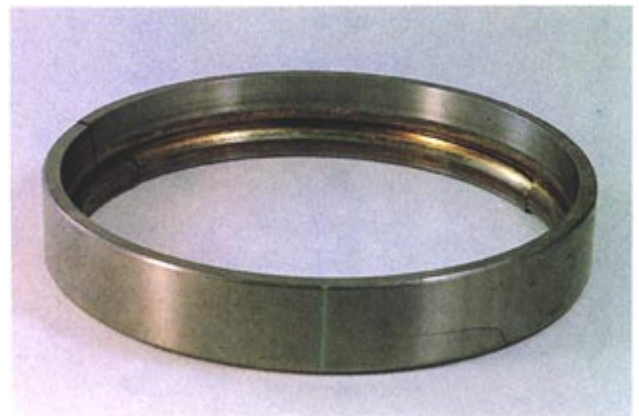

Photo I-4

- Outer ring of angular contact ball bearing
- Split of raceway surface in the circumferential direction
- The cause is slipping of balls due to poor lubrication.

5.10 Rust and Corrosion

Condition	Cause	Solution
Rusting or corrosion of bearing ring and rolling element surfaces Sometimes rusted at spacing equal to the distances between the rolling elements	Ingress of water or corrosive material (such as acid) Condensation of moisture contained in the air. Poor packaging and storing conditions, and handling with bare hands.	(1) Improvement in sealing effect (2) Periodic inspection of lubricating oil (3) Careful handling of bearing (4) Measures for preventing rusting when not operating for a long period of time.



Photo J-1

- Inner ring of tapered roller bearing
- Rusting on raceway surface spacing equivalent to the distance between rollers. The cause is water in lubricant.



Photo J-2

- Outer ring of tapered roller bearing
- Rusting on raceway surface spacing equivalent to the distances between rollers. The cause is water in lubricant. Some points are corroded.



Photo J-3

- Roller of spherical roller bearing
- Rust as well as corrosion on rolling contact surface
- Ingress of water



Photo J-4

- Inner ring (split type) of self-aligning roller bearing
- Rust and corrosion of the raceway surface
- The cause is ingress of water.

5.11 Seizing

Condition	Cause	Solution
Bearing generates heat and is seized up by heat disabling spinning. Discoloration, softening, and welding of raceway surface, rolling contact surfaces, and rib surface.	Dissipation of heat generated by bearing is not enough. Poor lubrication or lubricant improper. Clearance excessively small. Excessive load (or pre-load). Roller skewing and installation error.	<ol style="list-style-type: none"> (1) Improve dissipation of heat from bearing (2) Selection of suitable lubricant and determination of optimum lubricant feeding rate. (3) Prevention of misalignment (4) Improvement in clearance and pre-load (5) Improvement in operating conditions



Photo K-1

- Inner ring of double row tapered roller bearing
- Seizing-up discolors and softens inner ring producing stepped wear at spacing equal to distances between the rollers.
- The cause is poor lubrication.



Photo K-2

- Rollers of double row tapered roller bearing
- Rollers of same bearing as that of the inner ring shown in Photo K-1. Discoloration, spalling, and adhesion due to seizing up on rolling contact surfaces and end faces of rollers.



Photo K-3

- Outer ring of spherical roller bearing
- Stepped wear due to seizing up of raceway surface.
- The cause is poor lubrication.



Photo K-4

- Inner ring of tapered roller bearing
- Large end of the raceway surface and cone back face rib surface are seized up.
- The cause is poor lubrication.

5.12 Fretting and Fretting Corrosion

Condition	Cause	Solution
<p>Fretting surfaces wear producing red rust colored particles that form hollows.</p> <p>On the raceway surface, dents called false brinelling are formed at spacing equal to distances corresponding to the rolling elements.</p>	<p>If a vibrating load works on contacting elements resulting in small amplitude oscillation, lubricant is driven out from contact, and parts are worn remarkably.</p> <p>Oscillation angle of the bearing is small.</p> <p>Poor lubrication (no lubrication)</p> <p>Fluctuating load</p> <p>Vibration during transportation</p> <p>Vibration, shaft deflection, installation error, loose fit.</p>	<p>(1) Inner ring and outer ring should be packaged separately for transportation. If not separable, bearings should be preloaded.</p> <p>(2) Use oil or high consistency grease when bearings are used for oscillation motion.</p> <p>(3) Change lubricant</p> <p>(4) Fix shaft and housing</p> <p>(5) Improve fit</p>



Photo L-1

- Inner ring of cylindrical roller bearing.
- Corrugated fretting along full circumference of raceway.
- The cause is vibration.



Photo L-2

- Inner ring of deep groove ball bearing.
- Fretting along full circumference of raceway.
- The cause is vibration.



Photo L-3

- Outer ring of cylindrical roller bearing
- Fretting rust on outside diameter surface



Photo L-4

- Outer ring of tapered roller bearing
- Fretting rust on the outside diameter surface

5.13 Electrical Pitting

Condition	Cause	Solution
<p>Surface is speckled visually and the speckles are clusters of tiny pits when viewed through a microscope. Further development leads to a corrugated surface.</p>	<p>Electric current passes through bearing, and sparks are generated to fuse the raceway surface.</p>	<p>Avoid flow of electric current by averting current with a slip ring or insulation bearing.</p>

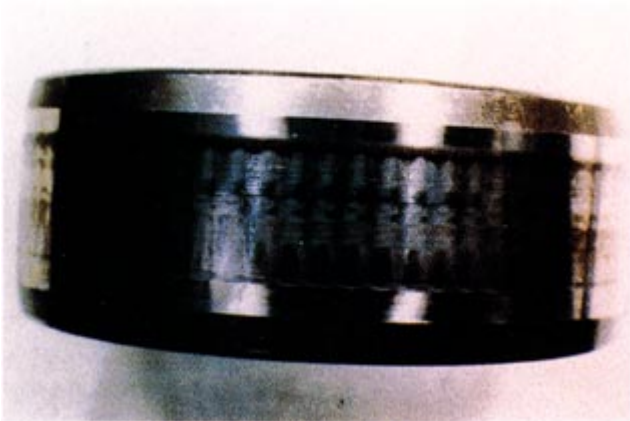

Photo M-1

- Inner ring of cylindrical roller bearing
- Raceway surface is corrugated by electric pitting



Photo M-2

- Rollers of tapered roller bearings
- Electric pitting at middle of rolling contact surfaces

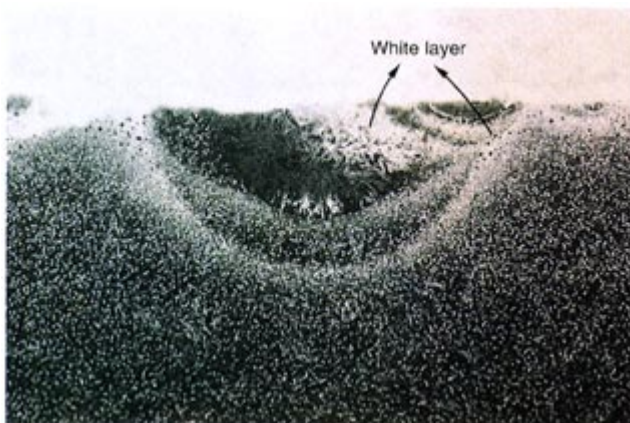
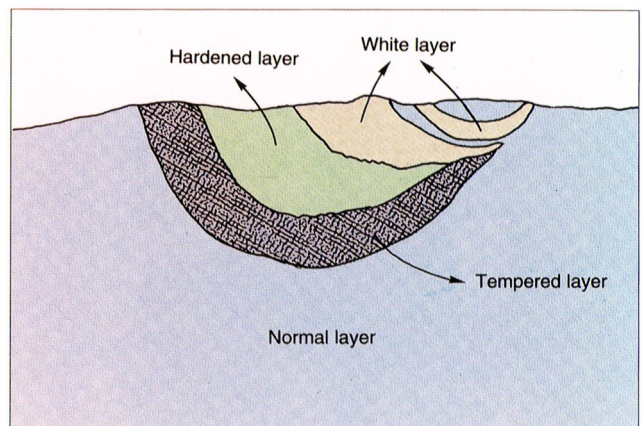

Photo M-3

- Magnified (x400) pitting of roller shown in Photo M-2
- Nital etchant develops a white layer on the cross section



Explanation of magnified photo M-3

5.14 Rolling Path Skewing

Condition	Cause	Solution
Rolling element contact path on raceway surface strays or skews.	Deformation or tilt of bearing ring due to poor accuracy of shaft or housing Poor rigidity of shaft or housing Deflection of shaft due to excessive clearance	(1) Improvement in machining accuracy of shaft and housing (2) Improvement in rigidity of shaft and housing (3) Employment of adequate clearance



Photo N-1

- Spherical roller bearing
- Contacts on inner ring, outer ring, and rollers are not even.
- The cause is poor mounting.



Photo N-2

- Outer ring of tapered roller bearings
- Contact path on raceway surface strays.
- The cause is poor mounting.



Photo N-3

- Rollers of tapered roller bearing of which outer ring is shown in Photo N-2.
- Contact marks on rolling contact surfaces are not even.

5.15 Damage to Retainers

Condition	Cause	Solution
Breaking of retainer <ul style="list-style-type: none"> • Wear of pockets or guide • Loosening or breaking of rivet 	Excessive moment load High speed spinning or large fluctuation of speed Poor lubrication Trapping of foreign objects Heavy vibration Poor mounting (cocked bearing) Excessive heat (plastic retainer in particular)	(1) Improvement in load conditions (2) Improvement in lubrication system and lubricant (3) Selection of optimum retainer (4) Improvement in handling (5) Study in rigidity of shaft and housing



Photo O-1

- Retainer of angular contact ball bearing
- Breakage of machined high tension brass retainer L1
- The cause is poor lubrication.

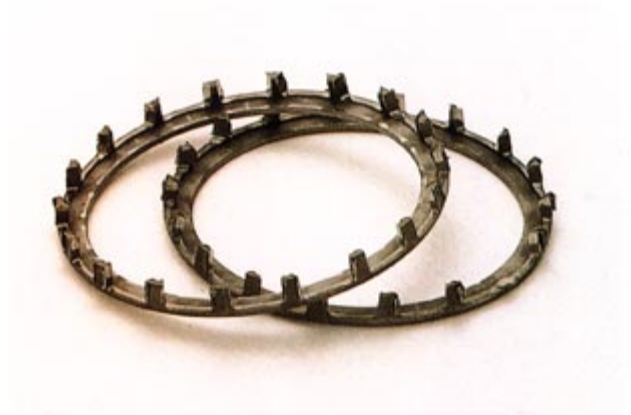

Photo O-2

- Retainer of spherical roller bearing
- Breakage of partitions between pockets of pressed steel retainer

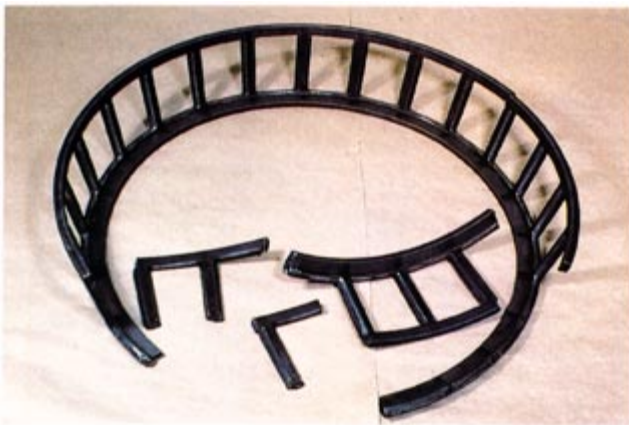

Photo O-3

- Retainer of tapered roller bearing
- Breakage of pockets of pressed steel retainer

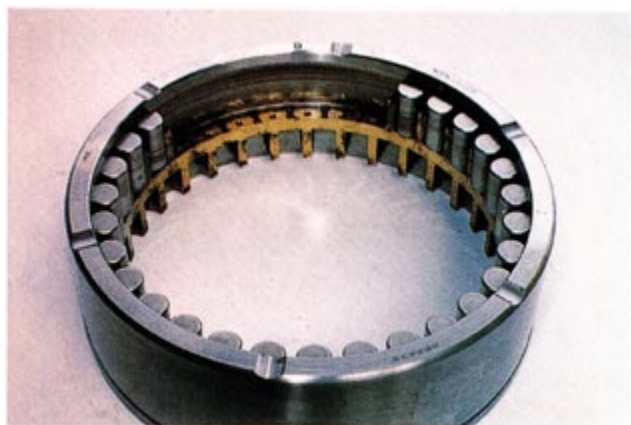

Photo O-4

- Retainer of cylindrical roller bearing
- Breakage of partitions between pockets of machined high tension brass casting retainer L1.

5.16 Creeping

Condition	Cause	Solution
Fitting surfaces are glazed or matted, and sometimes spalled as well.	Fitting of inner ring is loose on inner ring drive bearing, and that of the outer ring is loose on outer ring drive bearing. If the housing is made of a light alloy such as aluminum, fit may become loose due to the difference of thermal expansion.	<ol style="list-style-type: none"> (1) Improvement in fit (2) Improvement in machining accuracy of shaft and housing



Photo P-1

- Inner ring of deep groove ball bearing
- Bore wall glazed by creep



Photo P-2

- Inner ring of tapered roller bearing
- Spalling due to creep at the middle of bore wall



Photo P-3

- Inner ring of thrust ball bearing
- Spalling and friction cracking due to creep on bore wall.

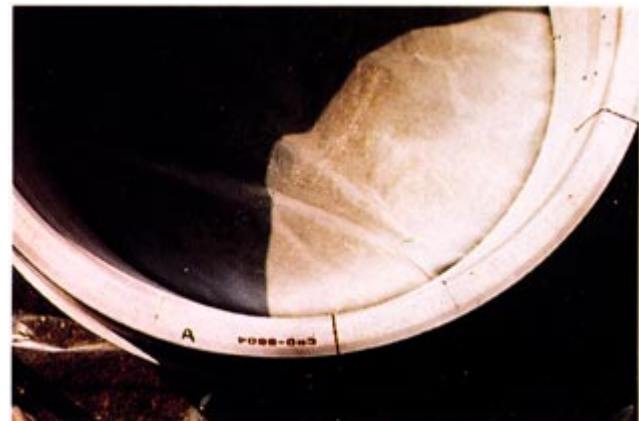

Photo P-4

- Inner ring of tapered roller bearing
- Spalling and friction cracking on width surface due to creep
Crack developed into a split reaching bore wall.

For New Technology Network

NTN®

Care and Maintenance
of Bearings

CAT. NO. 3017/E 03/96
Printed in U.S.A.



Emerson Bearing
Service. Inventory. Solutions.