

NACHI



Bearing Training Manual

Nachi's Complete Line of Ball and Roller Bearings



Deep Groove Ball Bearings

Open - Sealed - Shielded
10mm to 200mm Bore Diameters
Series: 6800, 6900, 6000, 6200, 6300



Angular Contact Ball Bearings

Single Row and Double Row
10mm to 150mm Bore Diameters
Series: 7000, 7200, 7300
Series: 5200, 5300



Super Precision Bearings

ABEC 7, 10mm to 150mm Bore Diameters
Series: 7900, 7000, 7200
Ball Screw Support - TAB-Series
Small Ball BNH Series, Ceramic Ball SH6 - Series
Double Row Cylindrical NN3000-Series



Cylindrical Roller Bearings

Steel, Brass, or Nylon
10mm to 200mm Bore Diameters
N, NU, NJ, NUP Configurations
Series: 200, 2200, 300, 2300



Tapered Roller Bearings

Interchangeable Metric Design
20 mm to 100 mm Bore Diameters
Series: 30200, 30300
Series: 32000, 32200, 32300



Double-Row Spherical Roller Bearings

Steel or Brass Cage, and Vibrating Screen Designs
25 mm to 320 mm Bore Diameters
Series: 22200, 23200, 21300, 22300, 23000
Series: 23100, 23900, 24000, 24100



Spherical Roller Thrust Bearings

Steel or Brass Cage
60 to 300 Bore Diameter
Series: 29300, 29400



Nachi Training Manual - Index

Sales Section

1. Introduction to Nachi America Inc.		
• History	2
2. Basic bearing parts, ball vs. roller	4
• Radial, Conrad	8
• Angular Single and Double Row	10
• Machine Tool	12
• Cylindrical Roller	14
• Spherical Roller	16
• Tapered roller bearings	18
• Spherical Thrust	19
3. Basic Bearing Selection		
• Materials	20
• Manufacturing	21
• Clearance	22
• Lubricant	24
• Shaft & Housing Fits	32

Engineering Section

4. Mounting Procedures		
• Cylindrical Bore	34
• Tapered Bore	40
5. Engineering Practice		
• Lubrication	44
• Shaft and Housing Tables	48
6. Bearing Selection		
• Conditions	54
• Life	56
• Loads	58
7. Special Bearing		
• Machine Tool Bearing	64
• Shaker Screen	76
8. Bearing Failures		
• Failure Analysis	78



Cutting Tools



Bearings



Special Steel



Broach Machine



Special Steel



Gear Cutting & Forming Tools



Robot



Furnace

NACHI

- 1920's** **Nachi Fujikoshi** started manufacturing hacksaw blades with high quality steel in **Toyama Japan**.
- 1930's** **Steel mill** started operation.
High Speed , Alloy Tool and Bearing Steels.
Saw Blades, Drills, Taps, End Mills, and Hobs.
Creation of **Ball Bearing Plant**, and **Machine Tool Plant**.
- 1940's** Expansion Period for current business and future business.
Broach bars and broaching Equipment are introduced.
Roller Bearings added to bearing product line.
- 1950's** Became a comprehensive machine manufacturer.
Shaper and shaver cutters, Christmas Tree Broaches.
First in Japan to Manufacture of Spherical Roller Bearings.
Begun production of **Hydraulic Equipment**.
- 1960's** Production of high performance products.
Advancements in Carbide tools.
Bearings supplied for Jet Engines and Bullet Train.
Production of Hydraulic Pumps and Valves.
Organized **Heat Treatment Technology**.
Established **Nachi America Inc**.
Established **Machine Tools & Hydraulic Div**.
Begun production of Industrial Furnaces & Coating Equip.
- 1970's** Export Internationally.
Precision Roll Forming Machines.
Powered High Speed Steels.
Develop Hydro-Logic systems.
Automotive Air Conditioner Bearings.



Broach Machine



Wheel Bearing (high speed train)



Precision Machine

NACHI

- 1980's**
 - Established **Robot & Precision Machinery Div.**
 - Promote shift of production to overseas plants.
 - Creation of **Precision Machinery Division** Grinding Equip.
 - Introduction of Coated Tools.
 - Welding and Painting Robots.
 - Needle Bearings for CVJ.
 - Awarded **TPM** (Total Productive Maintenance).
 - Hydraulic Wheel Motors.
 - Supplying Hardened Bar (Drill blanks).
 - Vacuum Heat Treated Furnaces.
- 1990's**
 - Mechatronics (Combine Engineering Curriculums).
 - Automotive Hydraulics Division.**
 - Awarded **Deming Prize.**
 - Product Handling Robots.
 - Radial Bearing Redesign.
 - Spherical Roller Bearing Redesign.
 - Development of High Speed Specialty Steels.
 - Improvement in Coating Technologies.
- 2000's**
 - Expand Global Business.
 - Refinement of specialized cutting tools.
 - High Speed Broaching Equipment.
 - Sealed Ball Screw Support Bearings.
 - Hydraulics for Mobile Equipment.
 - High Performance Bearing Steels.



Drills

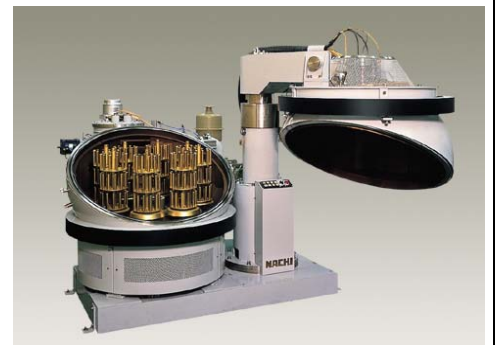

Coating Equipment

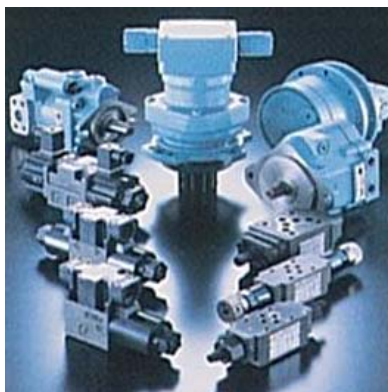

Hydraulic Equipment



Robots



Solenoid Valve

Six Basic Machines

Work is performed by applying a force over a distance.

These six simple machines have been used for thousands of years.

Combined these machines are used to create greater mechanical advantages.

- **Lever**
- **Wheel**
- **Inclined Plane**
- **Wedge**
- **Screw**
- **Pulley**

Half of these simple machines have shafts which rotate.

As the shafts spin faster and as the loads increase sliding friction caused the simple shaft supports to operate too hot.

Anti-Friction Bearings are the Solution as they operate with much less friction resulting in lower operating temperatures and are capable of accepting heavy loads.

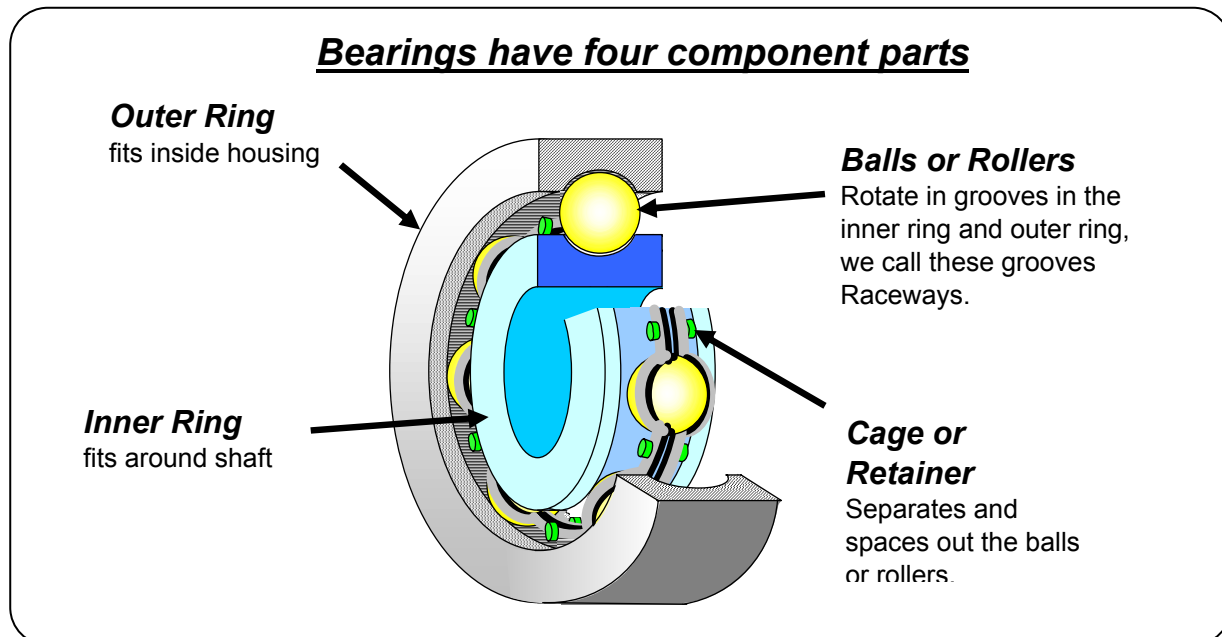

• **Material**

Bearing rings and rolling elements are normally manufactured from 52100 Vacuum Degassed Bearing Steel. 52100 is the most used steel for anti-friction bearings. Nachi has our own steel mill in Toyama Japan. We use steel from our plant or from other Japanese Steel Plants. The secret in bearing steel is in the cleanliness rating as our bearing steel are in the range of 6 parts per million. This makes the parts less susceptible to failure, this extends our bearing lives.

Retainers or cages are manufactured in several ways. Some are steel stampings others are steel stampings held together with rivets, some are machined bronze, others are fiberglass reinforced molded nylon. The retainer design and material type is offered to enhance the performance of the specific type of bearing.

Bearing Types

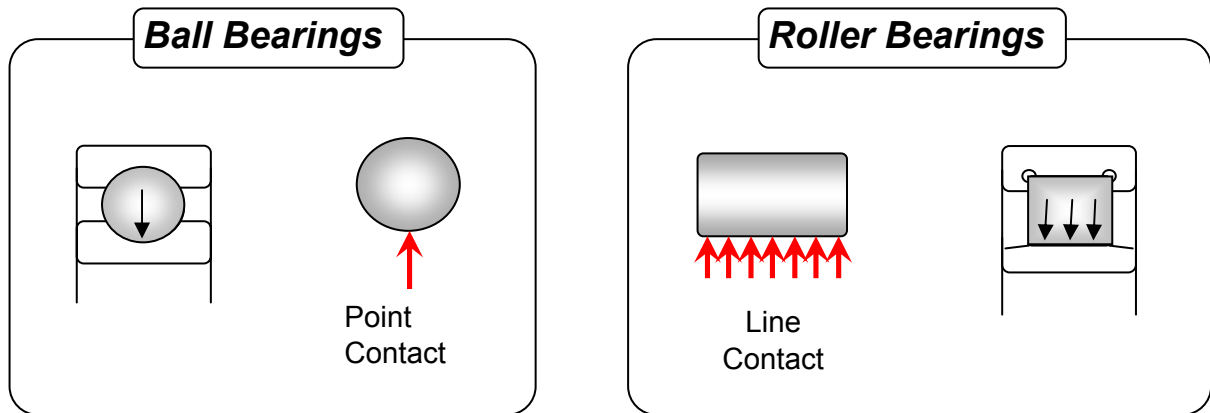

Bearings are divided into two groups Ball and Roller. The balls in ball bearings transfer the loads over very small areas with the raceways, we describe this as point contact. The rollers in roller bearings transfer the loads over larger areas with the raceways, we describe this as line contact.

Point Contact enables Ball Bearings to operate at high speeds since the rolling friction is very low. The point contact limits the amount of load the bearing can accept. So Ball bearings can operate fast with light loads.

Line Contact cause more friction which limits the operating speed of roller bearings. The larger contact areas also increase the load carrying ability of roller bearings. So Roller bearings operate slower with heavier loads.

• Types of Loading

Radial bearing are primarily designed for carrying radial loads.

A radial load is a pressing force that is perpendicular to the shaft.

A thrust or axial load is a force that is parallel to the shaft.

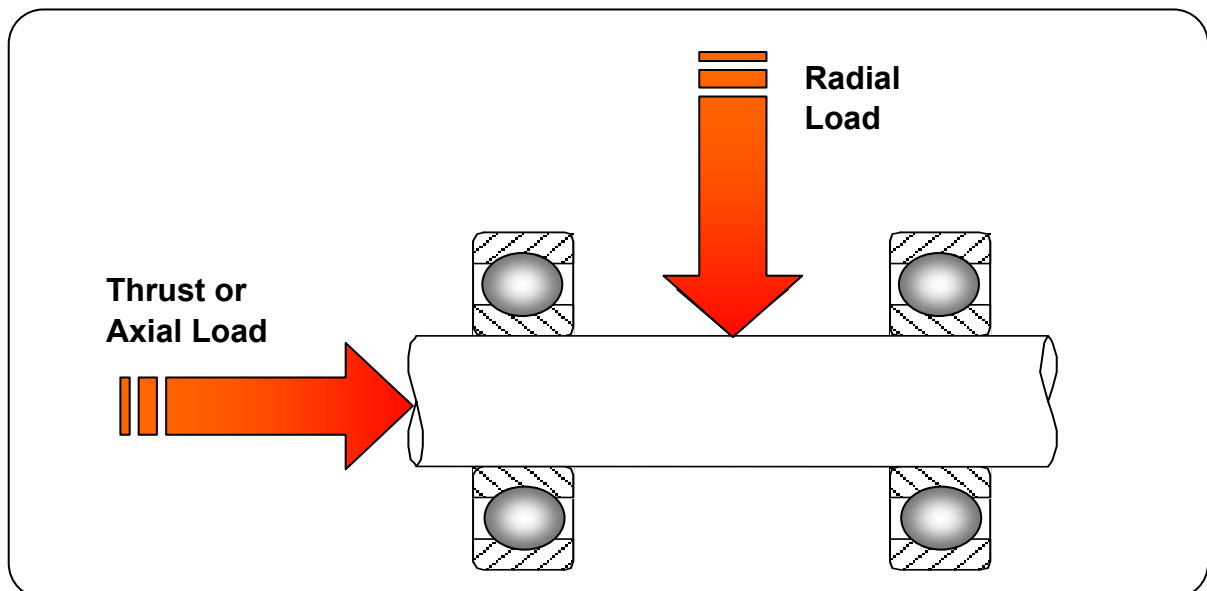

Bearing Types

2. Roller Bearings

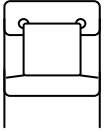
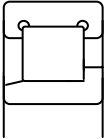
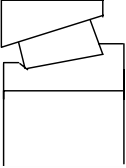
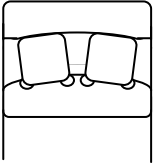
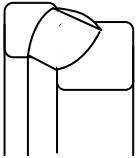
Ball Bearings	High Speed	Loading Orientation	Application	Page
 <p style="text-align: center;">Expansion</p>	● ●	↑	Gear Box Pumps Motors Transmissions Compressors	14
 <p style="text-align: center;">Cylindrical Roller Bearing</p>	● ●	↑ ←		15
 <p style="text-align: center;">Tapered Roller Bearing</p>	● ●	↑ ←	Gear Box Pumps Transmissions Grinders	18
 <p style="text-align: center;">Spherical Roller Bearing</p>	● ●	↑ ← →	Centrifugal & Positive Displacement Pumps Fans Gear box Hammer Mills Shaker Screens	16
Misalignment Capabilities - Mounted units for Fabricated Industrial Equipment				
 <p style="text-align: center;">Spherical Roller Bearing</p> <p style="text-align: center;">Misalignment Capabilities</p>	●	↑ ←	Centrifugal Pumps Underground Trenching Plastic Extruding Earth Boring Equipment Municipal vertical shaft pump motors.	19

Radial Ball Bearings



The radial ball bearing is the most commonly used bearing in the world today. Nachi's design has a ball which is about 60% of the cross section of the bearings. This design with the larger balls is the high capacity design.

These are Conrad radial ball bearings. The balls are loaded in between the inner ring and outer ring. The outer ring is pushed out of round and the

inner ring will pass down between the balls. The balls can now be spaced out and the retainer installed. Most world class bearing manufactures use the big ball design, and since the Conrad design will permit a maximum number of balls most major manufactures will have about the same capacity. The higher the capacity the longer the bearing life.

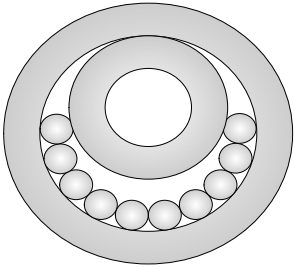

The capacity of a bearing will be the same regardless if it has seals, open, or shielded. All three bearings will accept the same load and produce the same life. The three bearing will have different speed limits. Speed limits are determined by how hot

the bearing will operate. The higher the speed the higher the operating temp. The open bearing has the highest speed limit. The shielded bearing will come in second, as the grease in the bearing is contained and will generate some additional temperature. The seals in the sealed bearing contact the inner ring and this contact will generate the most additional temperature so the sealed bearing have the lowest speed limits. Speed limits are in the catalog and are for reference as all applications are not the same and if the bearing operating temperature can be reduced the bearing can operate faster. Maximum operating temperature is 250 F.

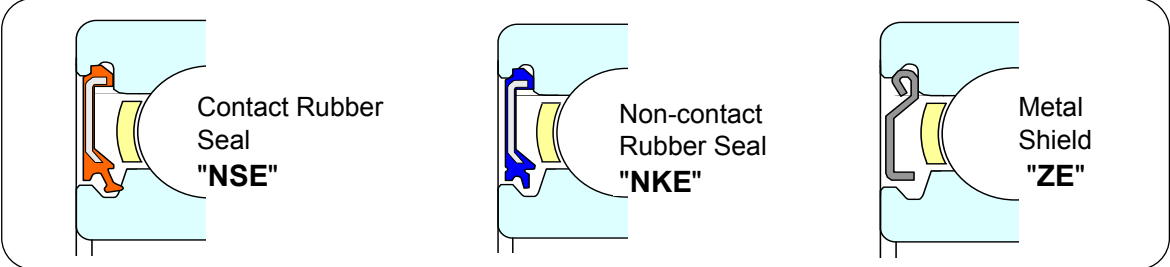

Nachi's design utilizes a groove in the inner ring and the seal contacts the side of the groove. Standard material for seals is Buna N (Nitril Rubber).

Bearings are like building blocks. We have many size ball bearings which have the same bore size. As the cross section of the ball bearing get larger the bearing can handle heavier loads, with slower speed limits than the thinner bearings.

Bearings will also have common OD sizes. Again the bearings with the larger cross-sections will handle the heavier loads and slower speeds.

Bearings can have common OD, Bores and Widths across bearing types

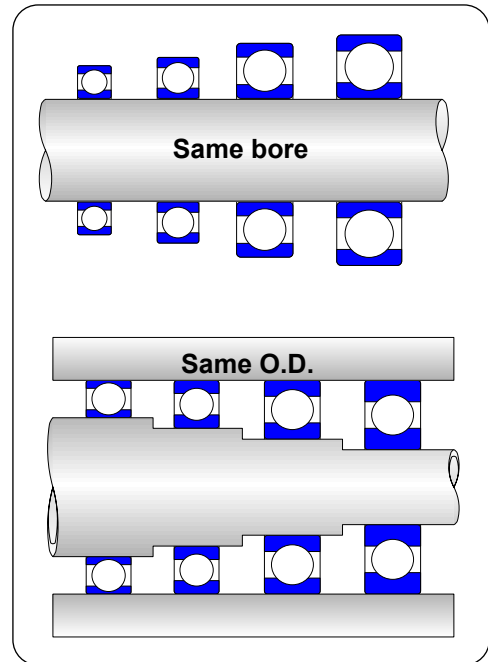

Designation ? Nomenclature?

6211 2NSE M NR C3

- ↓ **62** Radial Ball Bearing type 6200
Types 6800, 6900, 6000, 6200, 6300
- ↓ **11** Bore Size is 5 x 11 = Ø55 mm
Exceptions: 00 = Ø10 mm
01 = Ø12 mm
02 = Ø15 mm
03 = Ø17 mm
- ↓ --- = Open Bearing (no Seals or Shields)
- ↓ **NKE** = Non Contact Seals on One Side
- ↓ **2NKE** = Non Contact Seals on Both Sides
- ↓ **ZE** = Metal Shield on One Side
- ↓ **ZZE** = Metal Shield on Both Sides
- ↓ **NSE** = Rubber Seal on One Side
- ↓ **2NSE** = Rubber Seals on Both Sides
- ↓ **M** = Bronze Cage (Large Bore)
-- = Standard Stamped Steel Cage
G = Polyamide Cage, (Reinforced Nylon)
- ↓ **NR** = Snap Ring and Groove.
N = Snap Ring Groove in Outer Ring OD
- ↓ **C4** = more than C3
- ↓ **C3** = Internal Radial Clearance
Standard Clearance Stocked in the US.
C3 is more than CN
- ↓ **CN** = C0 = Normal Clearance, Standard outside US
- ↓ **C2** = less than CN

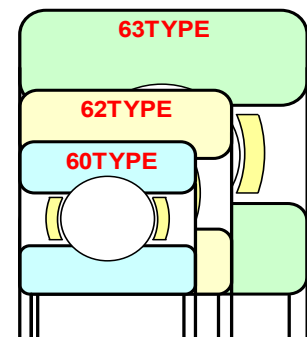

Angular Contact Ball Bearings

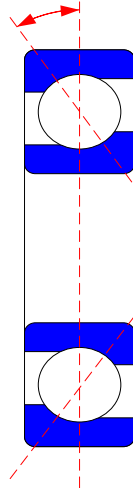

Single Row

The single row angular contact ball bearing was designed to support heavy thrust loads in one direction. The high thrust capacity is achieved by a higher shoulder on one side of the outer ring, a matching high shoulder is often on the opposite side of the inner ring as well. The direction of the load through the balls forms an angle α , known as the contact angle. The thrust capacity increases with the contact angle. Contact angles are 30° to 40° , depending on the bearing type.

Universal Ground Angular Contact Ball Bearings

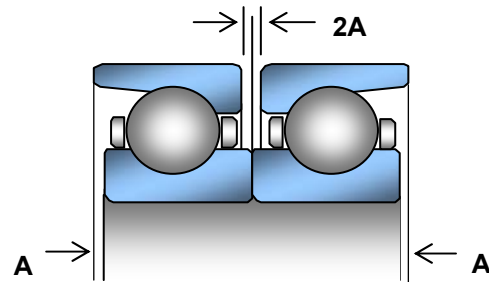
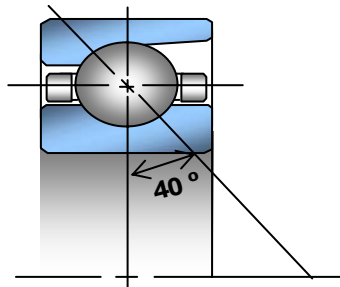

BMU bearing commonly referred to as thrust bearings can be used in pairs. The inner ring and the outer ring have identical widths. This permits the bearings to be arranged in any combination such as back to back face to face or tandem pairs. The 40° bearing angle enables the bearings to accept heavy axial loads.

Axial Internal Clearance			
Bore (mm)		2A (μm)	
Over	Incl.		
10	~ 18	18	~ 32
18	~ 30	20	~ 40
30	~ 40	25	~ 45
40	~ 50	30	~ 50
50	~ 65	35	~ 60
65	~ 80	40	~ 65
80	~ 100	55	~ 80
100	~ 120	60	~ 85
120	~ 140	75	~ 105
140	~ 150	85	~ 115

72 11 B M U C3

- \downarrow **C3** = C3 Internal clearance
- \downarrow **U** = Universal Ground Rings for Universal Mounting
- \downarrow **M** = Machined Bronze Retainer
- \downarrow --- = Stamped Steel Retainer
- \downarrow **B** = Bearing Contact Angle 40°
- \downarrow **C** = Bearing Contact Angle 15°
- \downarrow --- = Bearing Contact Angle 30°
- \downarrow **11** = Bore Size is $5 \times 11 = \text{Ø}55 \text{ mm}$
- \downarrow **72** = 7200 Angular contact ball bearing (Types 7000, 7200, 7300)

Angular Contact Ball Bearings

Double Row

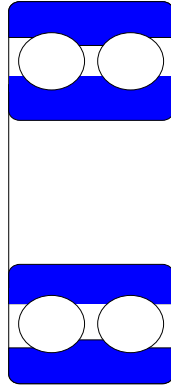
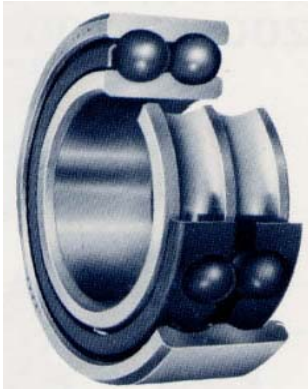

Double row angular contact ball bearings correspond, in principle, to two single row angular contact ball bearings with either a 20° or a 30° contact angle in the back-to-back arrangement. Double Row bearings are narrower than two of the same bearing size.

Double row angular contact ball bearings are used for radial loads, and can also carry thrust in either direction. Their radial load-carrying capacity is not double the corresponding single row bearing but is 1.55 times the single row bearing for a 20° contact angle and 1.47 times for a 30° contact angle.

Double row angular contact bearings can be supplied open, sealed or shielded. Clearance Ranges for single row angular contact bearings are dependent on series. Angular contact Machine tool bearings are normally supplied with negative clearance commonly referred to as preload. Standard angular contact bearings are not specified and must be set during installation. Pump bearing designation BMU have C3 axial clearance.

Double row angular contact bearings have the **same** radial internal clearances as normal radial ball bearings.

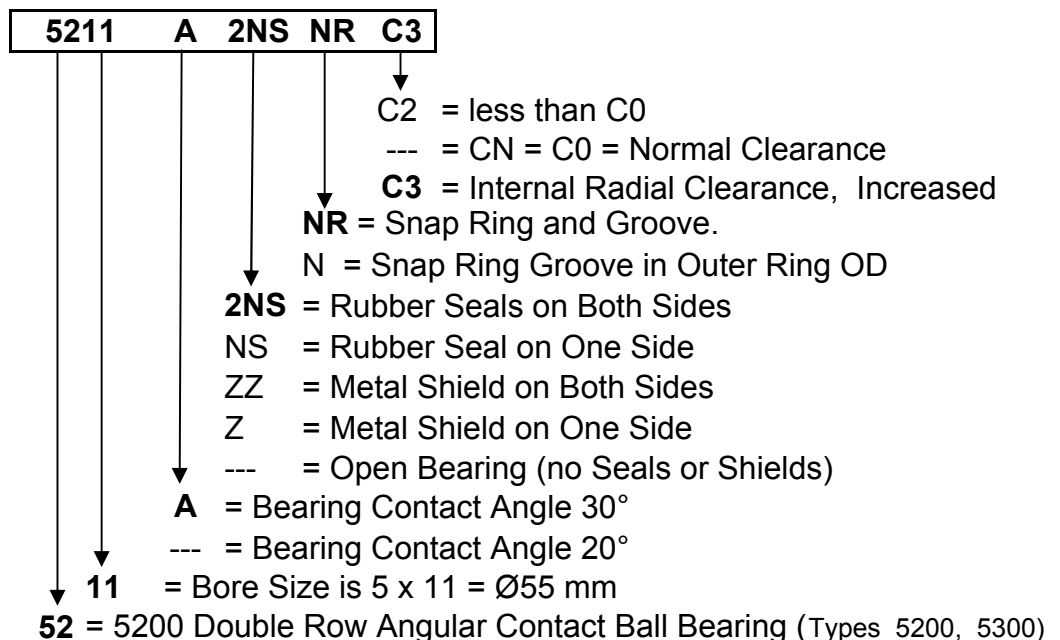

Machine Tool Bearings

Angular Contact Ball Bearings for the Machine Tool Industry are broken into two categories: Spindle Bearings & Ball screw Support Bearings. Both series of bearings are manufactured to ABEC 7 standards.

ISO	Normal class	Class 6	Class 5	Class 4	Class 2
JIS	P0	P6	P5	P4	P2
DIN	P0	P6	P5	P4	P2
ABMA	ABEC1	ABEC3	ABEC5	ABEC7	ABEC9



Spindle bearings are normally stocked as universal pairs or universal singles. Universal bearings can be arranged into any configuration

Spindle Bearings

Back-to-Back
"DB"

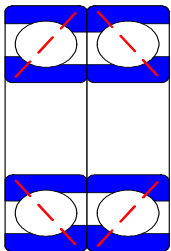

Face-to-Face
"DF"

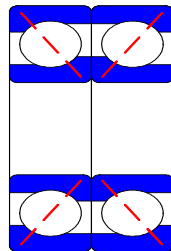

Tandem
"DT"

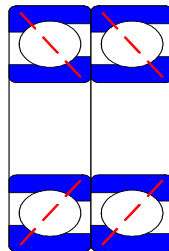

When bearings are used in duplex sets or pairs the bearings need to be special or matched sets. Bearings are very stiff and for both bearings to accept the loads evenly the bearings should be matched.

We stock some angular contact bearings as universal ground indicating the width of the rings in the bearings are identical and these bearings can be used in any of the three arrangements.

Single row angular contact bearings are supplied open, only ball screw support bearing have optional seals. Clearance ranges for single row angular contact bearings are dependent on bearing series. Angular contact Machine tool bearings are normally supplied with negative clearance commonly referred to as preload. Standard angular contact bearings are not specified and must be set during installation. Pump bearings designation BMU have C3 axial clearance.

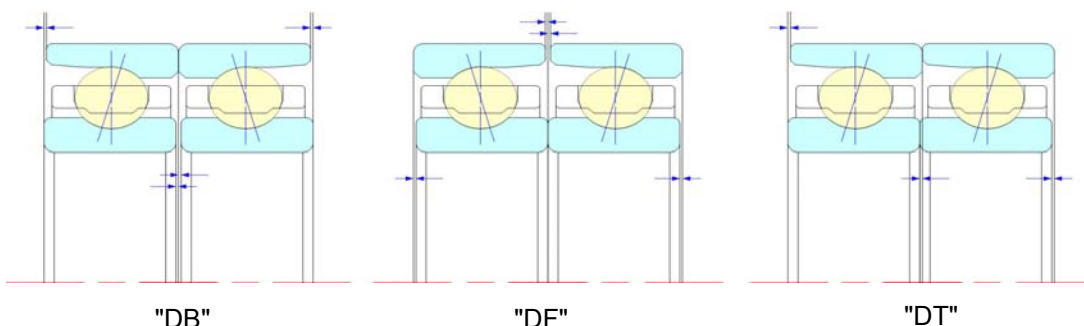

7011 C Y DU GL P4

- P4 = Precision Grade (Standard)
- GL = Light Preload (Standard)
- GE = Extra Light Preload
- GM = Medium Preload
- GH = Heavy Preload
- DU = 2 bearings Universal Ground
- U = 1 bearing Universal Ground
- DB = 2 bearings in back to back arrangement
- DF = 2 bearings in face to face arrangement
- DT = 2 bearings in tandem arrangement
- Y = Polyamide Resin Cage
- Blank = Phenolic Cage,
- C = Bearing Angle = 15
- AC = Bearing Angle 25
- 11 Bore Size is 5 x 11 = 55mm
- 70 7000 Angular contact ball bearing (Types 7900,7000,7200)



35 TAB 07 DU 2LR GM P4

- P4 = Precision Grade (Standard)
- GM = Medium Preload (Standard)
- 2LR = 2 Rubber Seals one on each side
- 2NK = 2 Rubber Seals one on each side
- Blank
- DU = 2 bearings Universal Ground
- U = 1 bearing Universal Ground
- DB = 2 bearings in back to back arrangement
- DF = 2 bearings in face to face arrangement
- DT = 2 bearings in tandem arrangement
- 07 = Indicator of OD size 70 something. This bearing is 72 mm.
- TAB = Ball Screw Support Bearing (Bearing Angle 60)
- 35 = Bore size 35 mm. (Polyamide Resin Cage)

Cylindrical Roller Bearings

Cylindrical roller bearings are designed to accept heavy radial loads. We show six family of parts for each bore size, the boundary dimension agree with radial ball bearings.

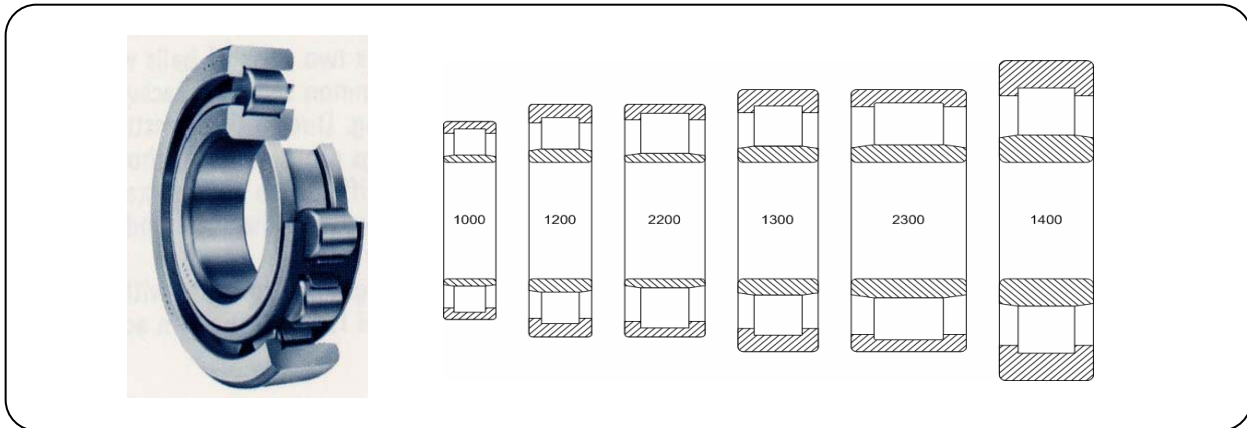

For each size there are many configurations (types) as shown below. The type depend on the ribs on the inner and outer ring. The most common types are the NU and NJ. NU has two ribs on the outer ring and no ribs on the inner ring, this type can not accept thrust load. The NJ has two ribs on the outer ring and one rib on the inner ring, this type can accept thrust load in one direction.

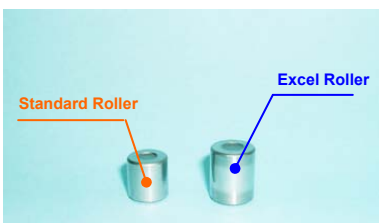
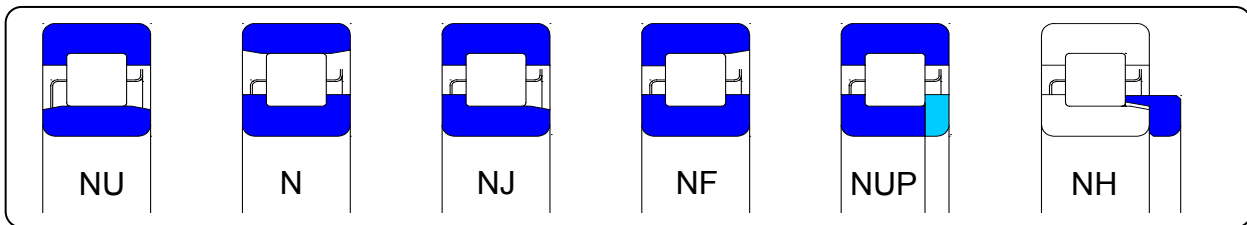

For each size and configuration there are two designs The Standard Design and the Large Roller High Capacity Design. In addition for each size, configuration and type there are various retainer designs. No single manufacturer stocks all these variations.

Larger Diameter Rollers increase the Capacity of the bearing which increase bearing Life.

Cage Material

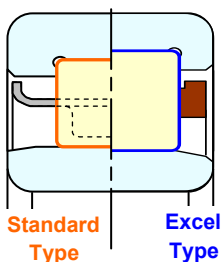

		Standard		Excel Series		
Symbol		-	MY	EG	EJ	EL
Cage Material		Steel	Bronze	Nylon	Steel	Bronze
Feature	Big Roller	△	△	⊗	⊗	⊗
	Low viscosity Oil	△	○	⊗	△	○
	High Temperature	○	⊗	×	○	⊗
	Low Noise	○	○	⊗	○	○
	Low Cost	⊗	○	⊗	○	△

⊗ : Excellent ○ : Good △ : Fair × : Poor

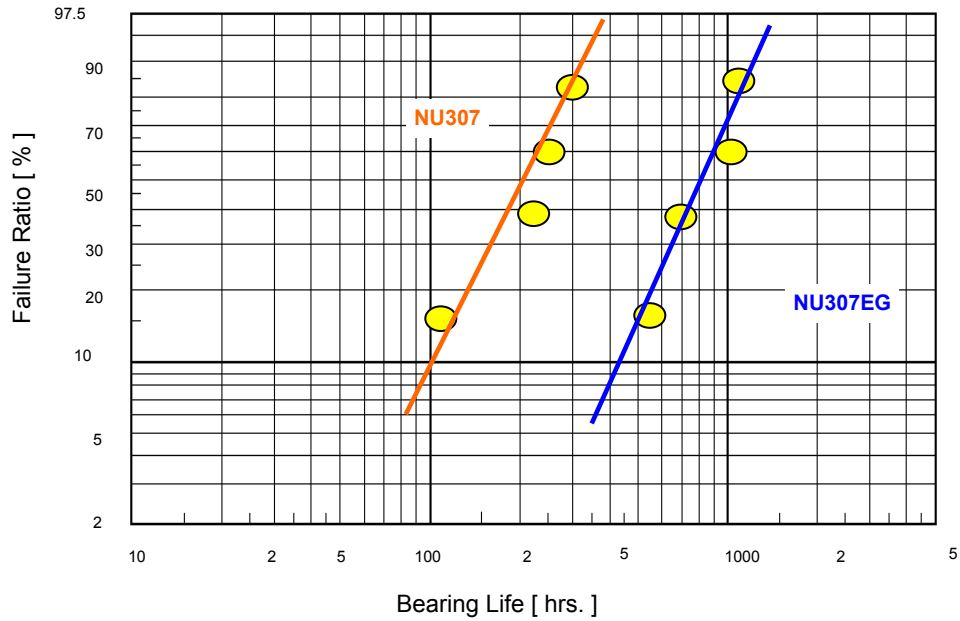
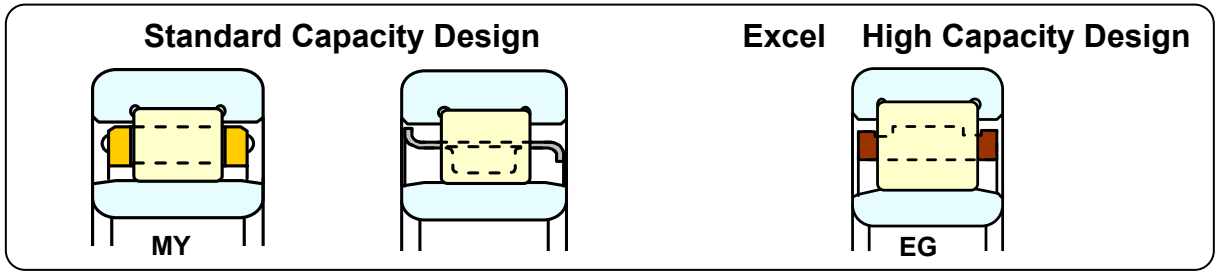

NU 2 07 E G C3

- ↓ **NU** = Configuration Options, NU, N, NJ, NF, NUP, NH
- ↓ **200** = Series 1000, 200,300,2200, 2300
- ↓ **07** = Bore size 35 mm.
- ↓ **E** = High Capacity Design
- = Standard Design
- ↓ **G** = Nylon Molded Cage
J = Stamped Steel Cage
L = Bronze Cage
MY = Machined Bronze Cage
- = Stamped Steel Cage
- ↓ **C3** = Internal Radial Clearance

Spherical Roller Bearings

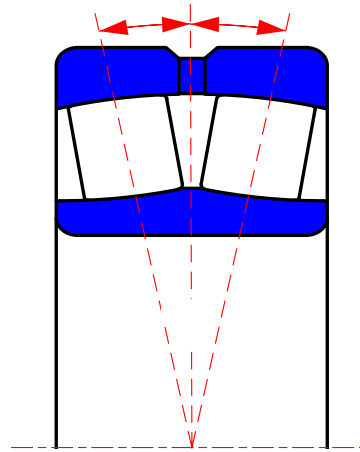

Double Row Spherical Roller Bearings are the work horse of the industry. Their Ball Shaped outer ring and Barrel Shaped Rollers permits this bearing to operate with misalignment with no reduction in bearing life. These bearings will operate and except static misalignment or dynamic misalignment with no reduction in life.

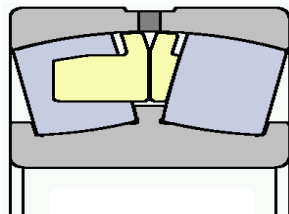

AEX-V

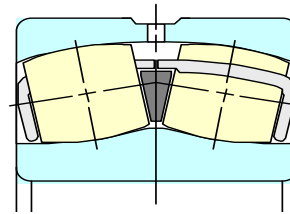

EX-V

Vibrating Screen Bearings are special spherical roller bearings as the applications are most sever. We now can offer two bearings with different cages for this extremely harsh application. Our standard bearing with a machined bronze cage is coded AEX-V and our new high capacity bearing with the heat treated stamped steel cage is coded EXV.

For the last two decades Nachi has had the highest load ratings in the World.

Bearing Life is directly related to Load Ratings.

Larger Diameter Rollers relates to less stress,

less stress relates to Longer Bearing Life.

Stamped Steel retainer coupled with floating aligning ring permits Longer Length Rollers

All Spherical Roller Bearings are heat stabilized so the bearings can operate to 400 F with no reductions in Bearing Life.

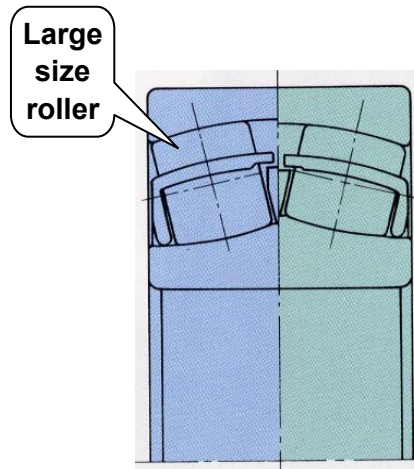

EX Design

Conventional Design

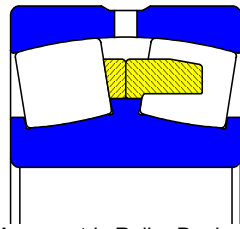

Asymmetric Roller Design
Fixed Guide Flanges
Machined Bronze Cage

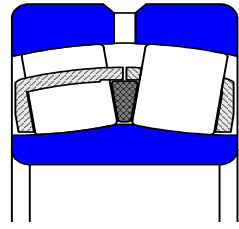

Symmetric Roller Design
Floating Guide Flange
Pressed Steel Cage



Most all of the bearings brought into the North America have W33 relube grooves and holes.

Nine Series of Spherical Roller Bearings a large offering which permits the best bearing selection for our customers

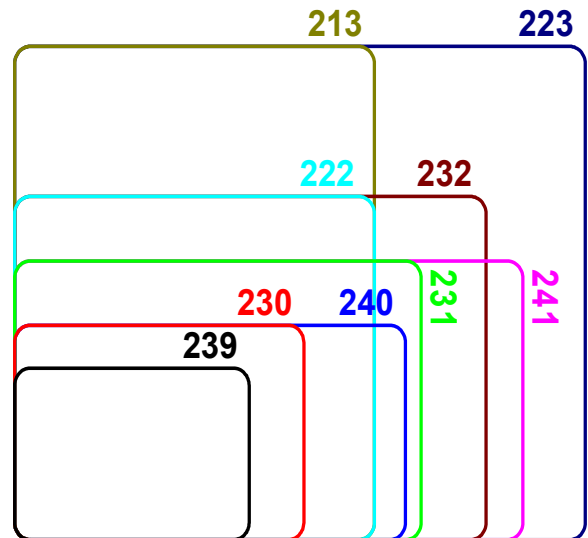
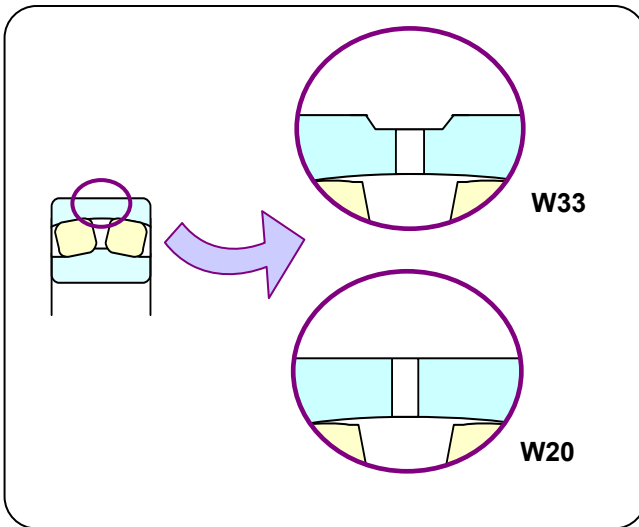

2 2 3 1 8 EX W33 K C3

- 2 = indicates this is a spherical roller bearing
- 23 = this is the 22300 series, Nine different series
- 18 = 18 x 5 = Ø90 mm bore
- E = Standard Design
- AEX = Asymmetric Design
- EXV = High Capacity Design (Vibrating Screen Design)
- EX = High Capacity Design
- = No Lubrication Groove or Holes in Outer Ring
- W20 = Lubrication Holes in Outer Ring
- W33 = Lubrication Groove and Holes in Outer Ring
- = Straight bore
- K = Tapered bore (1/12)
- C3 = Internal Radial Clearance

Metric Tapered Roller Bearings



Thin section, high strength stamped steel cages maximizes the lubrication flow which improving the lubrication factor ultimately resulting in longer bearing life.

Bearing features:

Advanced Inner ring rib design provides:

Superior roller guidance for better efficiencies

Sliding motion between the inner ring flange and the roller end is the primary heat generation source. We have optimized the design of this critical area to reduce heat build up.

All contacting Bearing components are made from the cleanest Japanese steels. These materials increase the life of the bearings over conventional steel.

Metric Series:

30203 - 30220

30303 - 30314

32004 - 32022

32205 - 32218

32304 - 32311



E 3 0 2 06 J

↓
 ↓
 ↓
 ↓
 ↓
 ↓

06 = bore 06 x 5 = 30 mm
2 = diameter series 2
0 = width series 0
3 = tapered roller bearings

E....J

Indicates metric series comply with ISO standard Interchangeable cup & cone

H-E....J

H indicates the bearing rings are manufactured from high speed steel for higher loading.

Spherical Thrust Roller Bearings

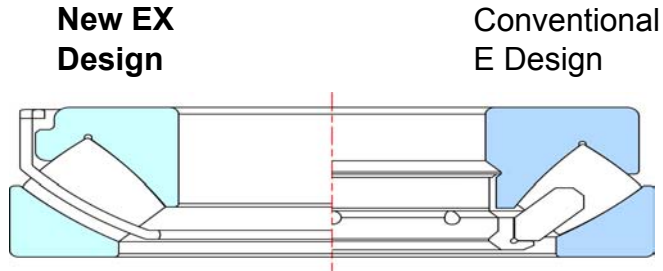

150% to 200% Increase in Bearing Life:

Maximizing the roller diameter, effective length, and number of rollers, yields the highest possible dynamic load capacity design. Our new EX design provides for this dramatic increase in bearing life.

Faster Speed Capability:

We developed a new stamped steel retainer to increase lubricant flow and enhance our design to improve the sliding motion between the inner ring flange and roller ends. This reduced heat generation of 10% increased the limiting speeds by 10%

Quieter Operation and Reduced Vibration Level:

We implemented a unique super finish process and improved roller roundness and raceway accuracy, which reduced noise and vibration level by more than 40% over other manufacturers bearings.

Size Range:

EX Series 29317EX to 29326EX

EX Series 29412EX to 29430EX

E Series 29328E to 29360E

E Series 29432E to 29456E

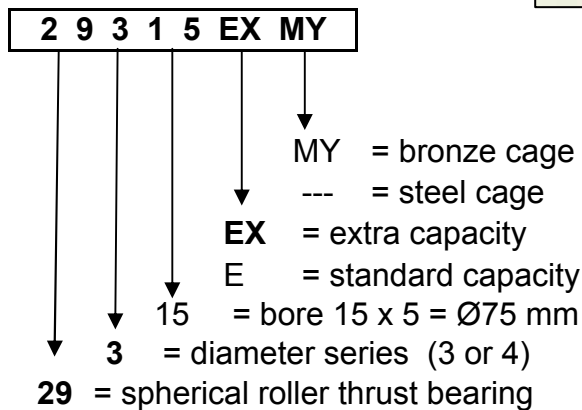

Bearing Materials

Material

Rolling bearings are manufactured from special steel alloys that possess high strength, wear resistance, dimensional stability, excellent fatigue resistance, and freedom from internal defects.

The bearing rings and rolling elements are usually fabricated from vacuum-degassed, high carbon, chrome bearing steel that is hardened to 60-63 Rockwell C. The most common alloy is designated AISI52100 through hardened steel, which is capable of operating temperatures up to approximately 250 °F. This same material can further be "heat stabilized" to endure operating temperatures up to 400 °F. Operating bearing above these temperature limits will reduce the hardness of the steel and result in significantly reduced bearing life.

Some larger bearing types can also be produced with case hardened steel where only the surface is hardened. The use of this steel limits the chances of fracture leading to catastrophic failure.

The selection of retainer material is equally important. Many bearing materials may be used such as brass, steel, polymers, and composites. In general, the maximum temperature limits for the retainers exceed those of the bearing.

Seals and shields are often incorporated into many bearing types. Shields are usually made of low-carbon steel and in most cases do not pose a controlling temperature limitation. Seal materials are Buna-Nitrile rubber (NBR), which has a temperature limit of 250 °F, Polyacrylic rubber (ACM) can be used up to 300 °F, and Viton Fluoroelastomer (FPM) can withstand temperatures up to 400 °F

Manufacturing

Bearing rings are made from solid bars, seamless tubing, or forged rings. The exact process is dependent on bearing ring dimensions and order quantity. Balls and rollers are cold or hot headed from wire or bar stock depending on size.

The individual components are turned to rough size, hardened and drawn in an atmosphere controlled furnace. All components are ground to final size. Grinding consists of Face Grinding , External Grinding, Internal Grinding and Honing.

All of the steps during assembly are dependent on Bearing Type.

Bearing Manufacturing

- ▣ The steel for Standard Ball & Roller Bearings is heat stabilized to operate up to 250 °F.
- ▣ Spherical Roller Bearings rings are heat stabilized to operate up to 400 °F.

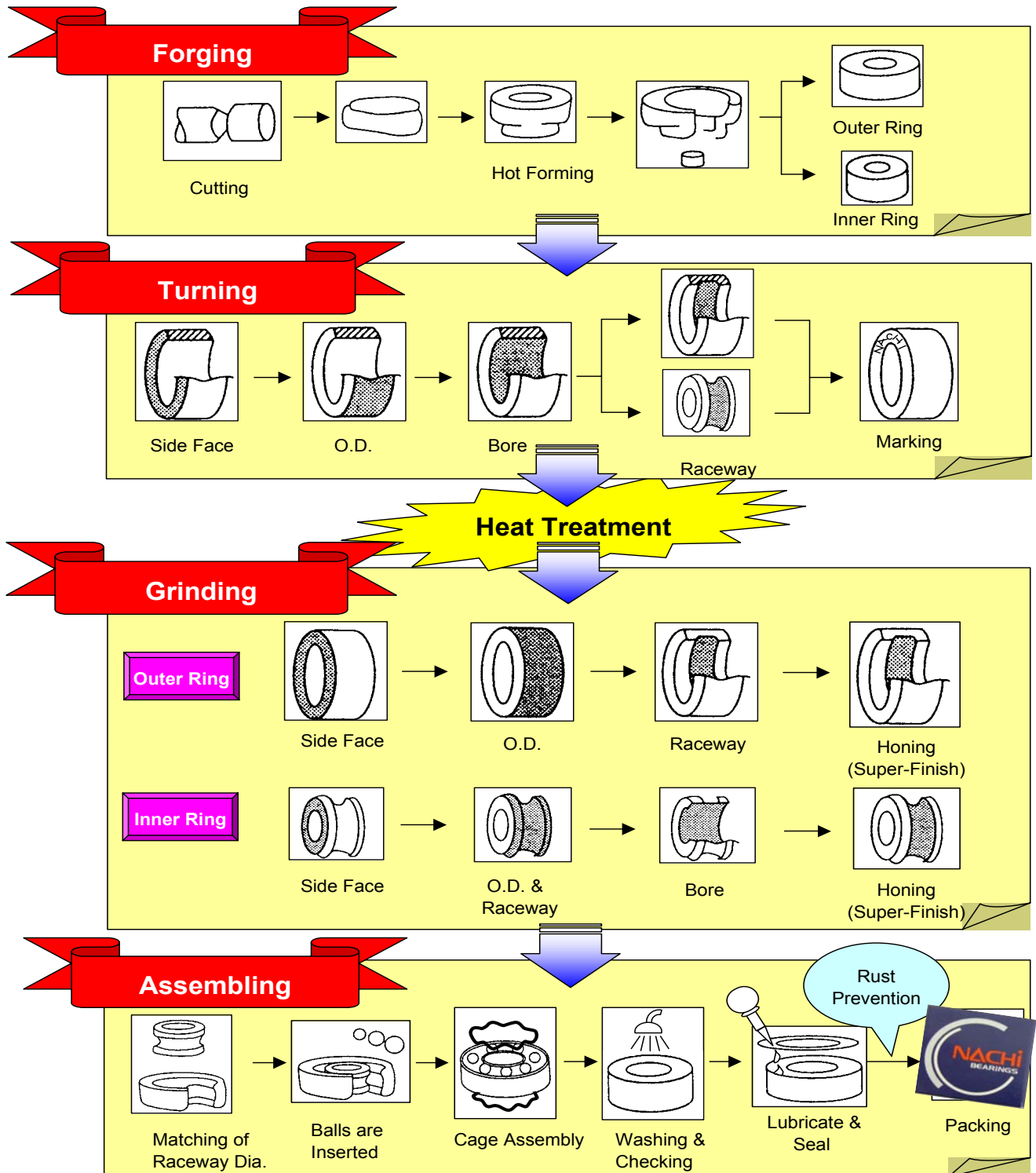

The table values are radial internal clearance. Radial ball bearings will have about 10 times the amount of axial clearance as radial. The axial clearance is what can be felt when holding a bearing in hand and twisting the inner ring to outer ring. Double row angular contact ball bearings about 3 times the of axial to radial clearance..

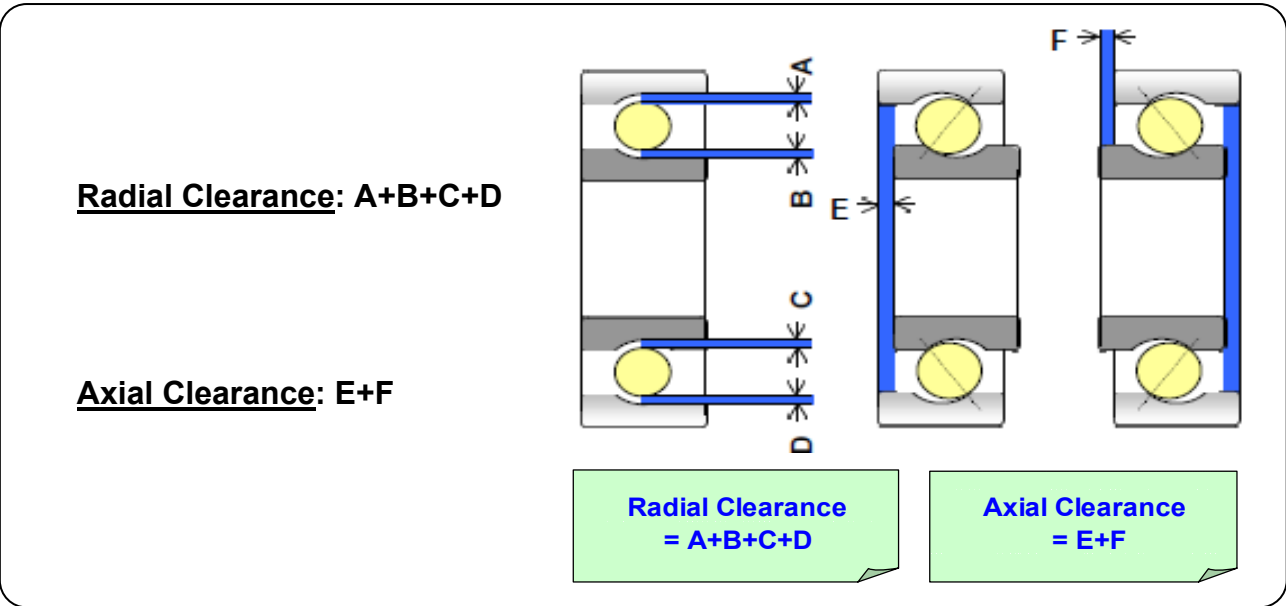

Unit: 0.001 mm

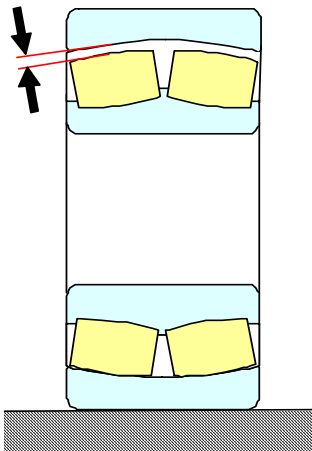

Bearing Bore		Radial Clearance for Spherical Roller Bearing									
		C2		CN		C3		C4		C5	
Over	Inc	Min	Max	Min	Max	Min	Max	Min	Max	Min	Max
30	40	15	30	30	45	45	60	60	80	80	100
40	50	20	35	35	55	55	75	75	100	100	125
50	65	20	40	40	65	65	90	90	120	120	150
65	80	30	50	50	80	80	110	110	145	145	180
80	100	35	60	60	100	100	135	135	180	180	225
100	120	40	75	75	120	120	160	160	210	210	260
120	140	50	95	95	145	145	190	190	240	240	300
140	160	60	110	110	170	170	220	220	280	280	350
160	180	65	120	120	180	180	240	240	310	310	390
180	200	70	130	130	200	200	260	260	340	340	430
200	225	80	140	140	220	220	290	290	380	380	470
225	250	90	150	150	240	240	320	320	420	420	520
250	280	100	190	190	260	260	350	350	460	500	570
280	315	110	190	190	280	280	370	370	460	500	630

Clearance values are published in our Nachi catalogs and on our web (www.nachi.com). Our web site also will convert radial clearance to axial clearance for each bearing size. Roller bearings require more clearance than ball bearings so the clearances in roller bearings are larger. The clearance ranges for ball bearing overlap while the clearance ranges for roller bearings do not.

Lubrication

Why is Important to Lubricate Bearings?

Five Basic Functions of Lubrications:

- Reduce Friction
- Reduce Wear
- Reduce Temperature
- Minimize Corrosion
- Seal Out Contamination

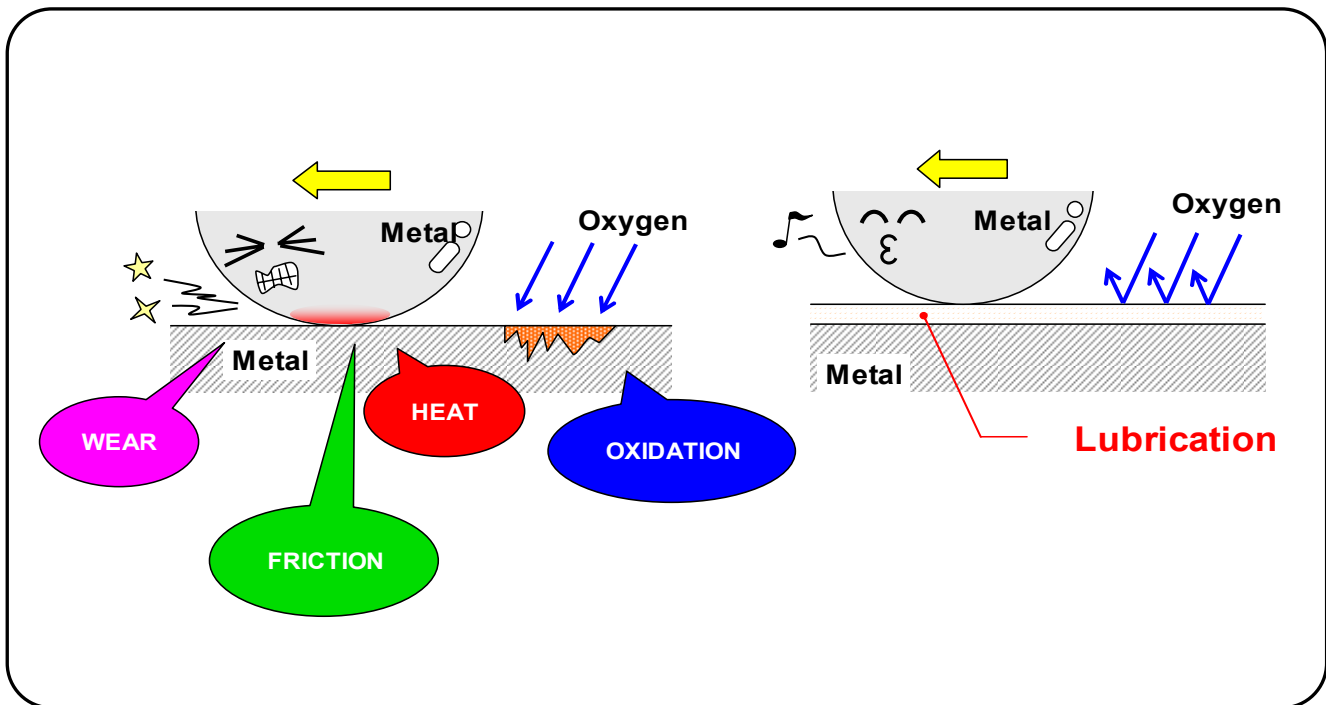

Bearings can not survive without Lubricant !!!!!

There are two Basic types of lubricant: Grease & Oil

Grease :

Grease is a very effective method for lubricating bearings because it has several advantages:

- **Convenience** –factory sealed and greased bearings require no maintenance
- **Cost Effective** – a sealed and greased bearing reduces the number of parts
- Grease is **easier to contain** than oil
- Grease **acts as a seal** preventing the entry of contaminants inside the bearing

The American Society for Testing and Materials (ASTM) defines grease as: “a lubricant of fluid-to-firm consistency produced by thickening a liquid lubricant with a stable, homogenous dispersion of a solid-phase thickener, and containing such additives as required to impart special characteristics.

In general terms, it is oil blended with a base thickener to give it some consistency. Additives are often blended in as well to improve characteristics, such as preventing rust or improving wear resistance.

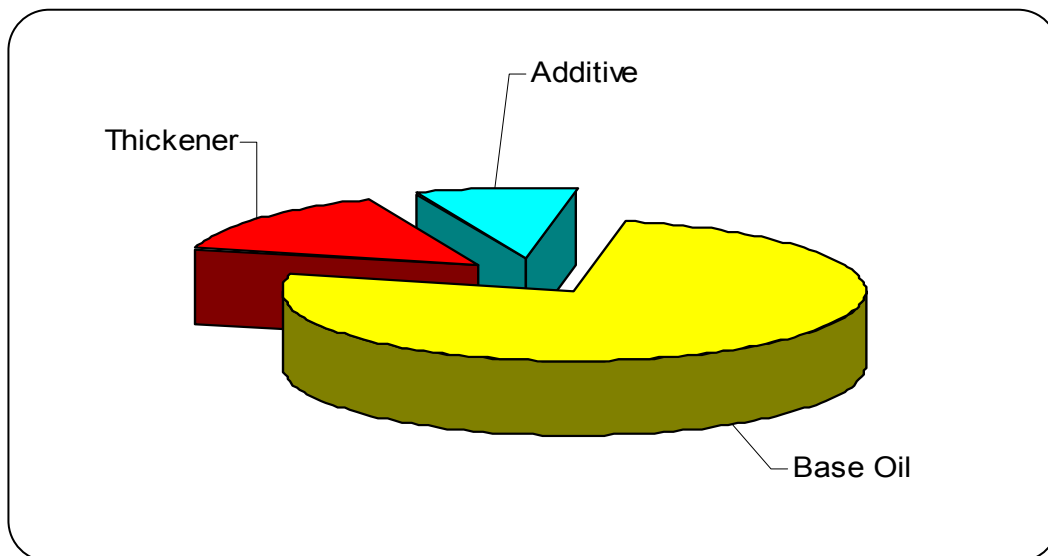

Greases are described in terms of the materials used to formulate them and their physical properties. The type of base oil, oil viscosity, thickener type, and thickener content are the formulation properties. Other physical properties such as consistency or penetration, torque resistance, dropping point, evaporation loss, and water washout are determined using standardized tests. There are thousands of greases available on the market with a vast array of formulations and performance characteristic. The results of these tests help determine when a specific grease is better suited for an application over another grease.

Lubrication

Grease Properties

• Viscosity

An important property of every grease is the base fluid viscosity. Viscosity is the measurement of a fluid's resistance to flow. Laboratory measurements of viscosity use the force of gravity to produce flow through a standard size tube at a controlled temperature. This measurement is called kinematic viscosity. The common units for kinematic viscosity are **centistokes** (cSt) or **saybolt universal seconds** (SUS). A higher base oil viscosity provides increased film thickness and load carrying capability, while increasing friction and heat while reducing the maximum allowable operating speed.

• Penetration

Penetration is a measure of the consistency of the grease. Consistency is defined as the degree to which a grease resists deformation under the application of force. Basically it is a measure of the stiffness or hardness of the grease. Penetration is the depth (in tenths of a millimeter) that a standard cone penetrates a sample of the grease at standard conditions of weight, time, and temperature.

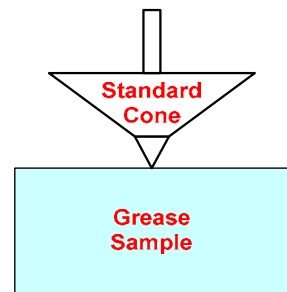

• NLGI Consistency Grades

The National Lubricating Grease Institute (NLGI) has a numerical scale for classifying the consistency of grease by the ASTM worked penetration. In order of increasing hardness, the consistency numbers are:

<u>NLGI Grade</u>	<u>ASTM Worked Penetration</u>	<u>NLGI Grade</u>	<u>ASTM Worked Penetration</u>
000	445 - 475	3	220 - 250
00	400 - 430	4	175 - 205
0	335 - 385	5	130 - 160
1	310 - 340	6	85 - 115
2	265 - 295		

• Dropping Point

This is the lowest temperature at which a grease passes from a semisolid to a liquid state under the conditions of the test. This is determined when the first drip of the grease falls from the opening of a standardized cup. This is an indication of whether a grease will flow from a bearing at operating temperatures. The dropping point of a grease is well above the maximum useable temperature of the grease.

Popular Bearing Greases:

Grease Name	Base Oil	Thickener	Operating Temp	Color	Performance Properties						Example	
					Water Resistance	High Speed	Noise	High Temp	Load Resistance	Torque		Low Temp
Exxon Polyrex EM	Mineral Oil	Polyurea	-13~338 °F (-25~170 °C)	Blue	○	○	○	○	○			Electric Motor
Chevron SR12	Mineral Oil	Polyurea	-22~302 °F (-30~150 °C)	Dark Green	○	○	△	○	○			Magnetic Clutch
Shell Doliium BRB	Mineral Oil	Polyurea	-22~302 °F (-30~150 °C)	Purple	○	○		○				Transmission
Shell Alvania #2	Mineral Oil	Lithium	-20~250 °F (-29~121 °C)	Amber	○		○					General Machinery
Shell Alvania EP2	Mineral Oil	Lithium	-20~250 °F (-29~121 °C)	Reddish Brown	○			○	◎			Industrial Laundry Washer
Kyodo Yushi MTSRL	Ester Oil	Lithium	-40~302 °F (-40~150 °C)	Light Brown	○		◎	○		○	○	Electric Motor
Exxon Unirex N3	Mineral Oil	Lithium	-40~400 °F (-40~204 °C)	Green	◎	○	△	○				Idler Pulley
Kluber Isoflex NBU15	Synthetic Ester/Mineral Blend	Barium Complex	-40~266 °F (-40~130 °C)	Light Beige		◎	○					Machine Tool Spindle
Exxon Beacon 325	Di Ester Oil	Lithium	-65~250 °F (-54~121 °C)	Light Gray	○	○	△	○			◎	Cold Climate Machine
Mobil Grease 28	Di Ester Oil	Bentonite	-67~356 °F (-55~180 °C)	Red	○			○			◎	Cold Climate Machine

Nachi Standard Greases:

For Sealed And Shielded Single Row Deep Groove Ball Bearings

Grease Name	POLYREX EM	ALVANIA #2	MULTEMP SRL
Nachi Grease Code	XM	AV2	MTSRL
Manufacturer	Exxon	Shell	Kyodo Yushi
NLGI Consistency Grade	2	2	3
Color	Blue	Amber	Light brown
Thickner	Polyurea	Lithium soap	Lithium soap
Base oil	Mineral oil	Mineral oil	Ester
Operating Temperature Range °C	-25~170 (-13~338°F)	-25~130 (-13~266°F)	-40~150 (-40~302°F)
Base Oil Viscosity @ 40 °C (cSt)	115	98	26
Base Oil Viscosity @ 100 °C (cSt)	12.2	9.7	5.1
Penetration (60-strokes)	284	287	250
Dropping Point °C	288 (550°F)	185 (365°F)	190 (374°F)
Resistance to Load	Normal	Normal	Normal
Water Resistance	Excellent	Excellent	Excellent
Shearing Stability	Excellent	Excellent	Excellent
Noise Level	Good	Normal	Excellent

Lubrication

Grease Compatibility

● Beware Of Mixing Different Greases !

A critical motor keeps failing, even though the bearings have been replaced and lubricated according to the motor manufacturers specifications. What is happening?

The motor repair shop removes one shield from the bearing and adds grease in the end bell of the motor to help seal out dirt, but the grease the motor shop adds is not the same grease that is already in the bearing and they are incompatible! When two greases are mixed the results may be disastrous.

● What Happens When Greases Are Incompatible?

When two incompatible greases are mixed, either one of two things can happen. Either the mixture hardens and will not release any of the oil or the opposite effect; the mixture softens and releases all of the oil. In either case, the end result is basically the same; there is no means to effectively lubricate the bearing.

● How Is Grease Compatibly Determined ?

Two different tests are conducted to determine if greases are compatible. First a 50/50 mixture of the two greases is analyzed at a worked penetration of 60 strokes to see if the new grease stays within the same NLGI consistency grade limits. If the first test is successful, a second and more demanding roll stability test is run. This involves running a heavy cylindrical roller at 165 rpm. The worked penetrations of the samples are measured before and after the roll test. The compatibility is determined by evaluating each of the greases individually, as well as for mixtures at 25%/75%, 50%/50%, and 75%/25% of the two greases of interest. The penetrations are measured and the results are plotted to illustrate the blending and shearing effects on the greases and mixtures. The grease compatibly is determined by comparing the measured worked penetration results after the test to the theoretical (calculated) results expected for the mixture. The compatibly assessments are based on the following approximate limits on the difference between the measured and calculated penetrations:

Compatible	0 to 30 points of change
Borderline	31 to 60 points of change
Incompatible	61 or more points of change

Grease Compatibility Matrix:

C = COMPATIBLE B = BORDERLIBE I = INCOMPATIBLE	Aluminum Complex	Barium	Calcium	Calcium 12-hydroxy	Calcium Complex	Clay	Lithium	Lithium 12-hydroxy	Lithium Complex	Polyurea
Aluminum Complex	X	I	I	C	I	I	I	I	C	I
Barium	I	X	I	C	I	I	I	I	I	I
Calcium	I	I	X	C	I	C	C	B	C	I
Calcium 12-hydroxy	C	C	C	X	B	C	C	C	C	I
Calcium Complex	I	I	I	B	X	I	I	I	C	C
Clay	I	I	C	C	I	X	I	I	I	I
Lithium	I	I	C	C	I	I	X	C	C	I
Lithium 12-hydroxy	I	I	B	C	I	I	C	X	C	I
Lithium Complex	C	I	C	C	C	I	C	C	X	I
Polyurea	I	I	I	I	C	I	 I	I	I	X

There are a number of letters in the marketplace stating that Polyrex EM, a Polyurea Based Grease is compatible with a list of Lithium Based Greases.

How can this be ???

We have examined the test results and found that in almost all cases the mixed grease had a significant enough change to bring it down to a NLGI grade 1, but they put a disclaimer stating they do not expect mixtures of more than 80%/20% , so the mixture of greases will not reduce bearing performance. It is our field experience that any mixing of grease **does** have an effect on bearing performance. The most noticeable problem is a dramatic increase in noise level. Shortened service life in severe duty motors has been documented as well.

Lubrication

How Much Grease?

One of the most common misconceptions that cause a high number of bearing failures is that a bearing needs to be completely packed full. Many people have been taught; the more grease, the better. We have even heard of cases where people do not feel bearing manufacturers use enough grease in sealed and shielded ball bearings, so they remove one seal or shield and pack the bearing with more grease. These misconceptions are completely false. Over lubricating the bearings forces the motor to work harder. The best analogy that I have heard is comparing running in water that is up to your ankles or running in water that is up to your neck. Which is harder? Obviously the higher the water, the harder you have to work to move through it, this is the same for bearings, the more grease, the harder the motor has to work to overcome the friction of the excess grease.

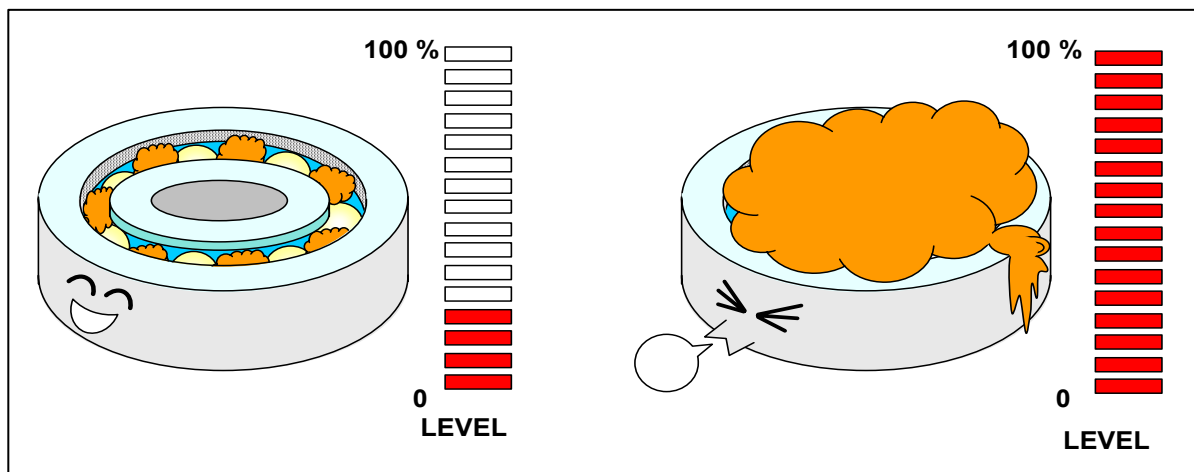

- **Nachi Standard grease fill** for sealed and shielded ball bearings is **20% to 30% full**

Too much grease can cause excess friction, thereby overheating the bearing and causing premature failure.

Only a small of grease is required to lubricate a bearing in motion.

When a bearing is in motion, most of the grease is pushed to the side (channeling) leaving a thin film of oil between the raceways and rolling elements.

When using open bearings, pack the bearing as follows:

When the shaft speed is

50% or less of the bearings cataloged limiting speed pack 1/2 to 2/3 full

Greater than 50% of the bearings cataloged limiting speed pack 1/3 to 1/2 full.

Oil Lubrication

Advantages:

- Good for operation at high speeds
- Circulating oil can act as a coolant
- Circulating oil can remove contaminants and be filtered
- Oil is suitable for extremely low or extremely high temperatures

Characteristics:

- Oil is primarily used for higher speed and lighter loads
- Mineral oils are the most common, however high temperatures may require synthetic oils
- The quantity and type of oil varies depending on bearing type, size, load, speed...etc

Generally, oil should be replaced once per year when operating temperatures are $< 120^{\circ}\text{F}$
Oil should be replaced every 90 days when operating temperatures $> 200^{\circ}\text{F}$
For mineral oil the life of the oil halves every 15°F the oil operates over 140°F
On Synthetic oil the starting point is 180°F

Particle Sizes:

(Scale: X 1,800 times)

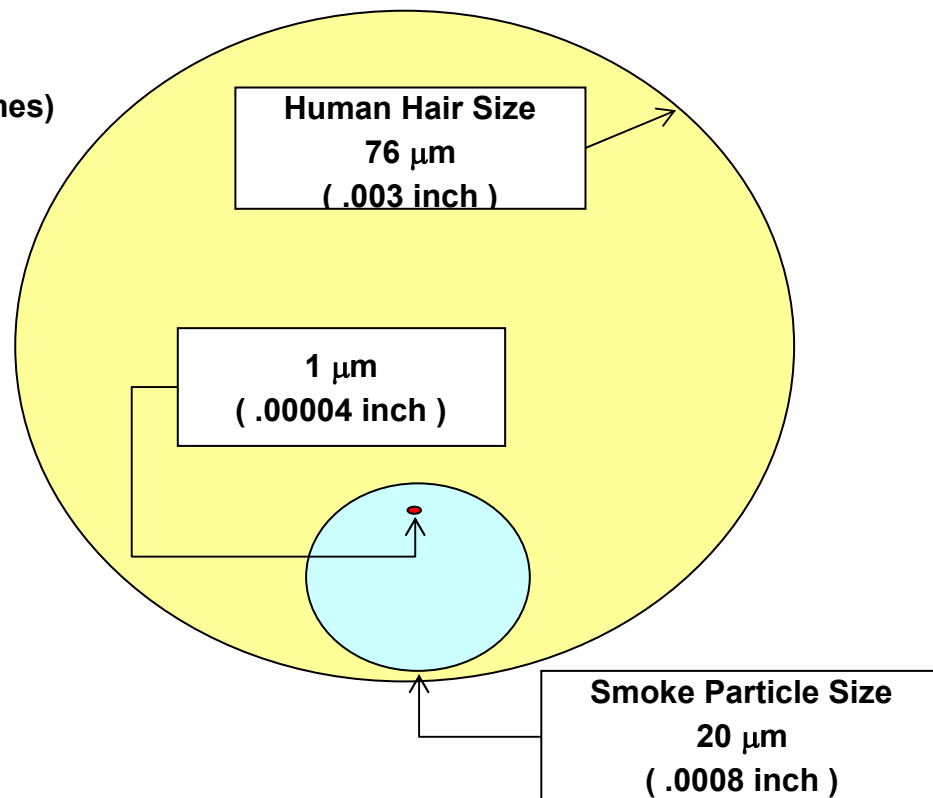

Contamination in bearings is a constant problem. Even a small amount of contamination will affect the bearings. A hair has a diameter of about .004" A smoke particle is .0008". Contamination the size of 1 micron is at least five times the film thickness of the oil on the raceways. The contour of the raceway surfaces are in the range of plus or minus 1 micron.

Shaft & Housing Fits

In order for a ball or roller bearing to perform satisfactorily, the fit between the inner ring and the shaft, and the fit between the outer ring and the housing must be suitable for the application. For example, too loose a fit could result in a corroded or scored bearing bore and shaft. While too tight a fit could result in unnecessarily high mounting forces and too great a reduction in internal bearing clearance. In either case the end result could be premature bearing failure.

All Nachi bearings are made to tolerances set forth by the American Bearing Manufacturers Association (ABMA) and the International Standards Organization (ISO). The proper fits can only be obtained by selecting the proper tolerances for the shaft outside diameter and housing bore diameter. A letter and a number designate each tolerance. The lower case letter is for shaft fits and a capital letter is used for housing fits. The letter indicates the tolerance zone in relation to the nominal dimension and the number indicates the magnitude. The sectional rectangles shown in Figure 1 illustrate the location and magnitude of the various shaft and housing tolerance zones used for ball and roller bearings.

The selection of fit is dependent of the characteristic of the load, the bearing dimensions, the bearing operating temperature, thermal expansion of the shaft and other surrounding parts, and the required running accuracy.

In determining suitable fits for any given application, the direction of the load with respect to the bearing ring must be known. Various load conditions are discussed as follows:

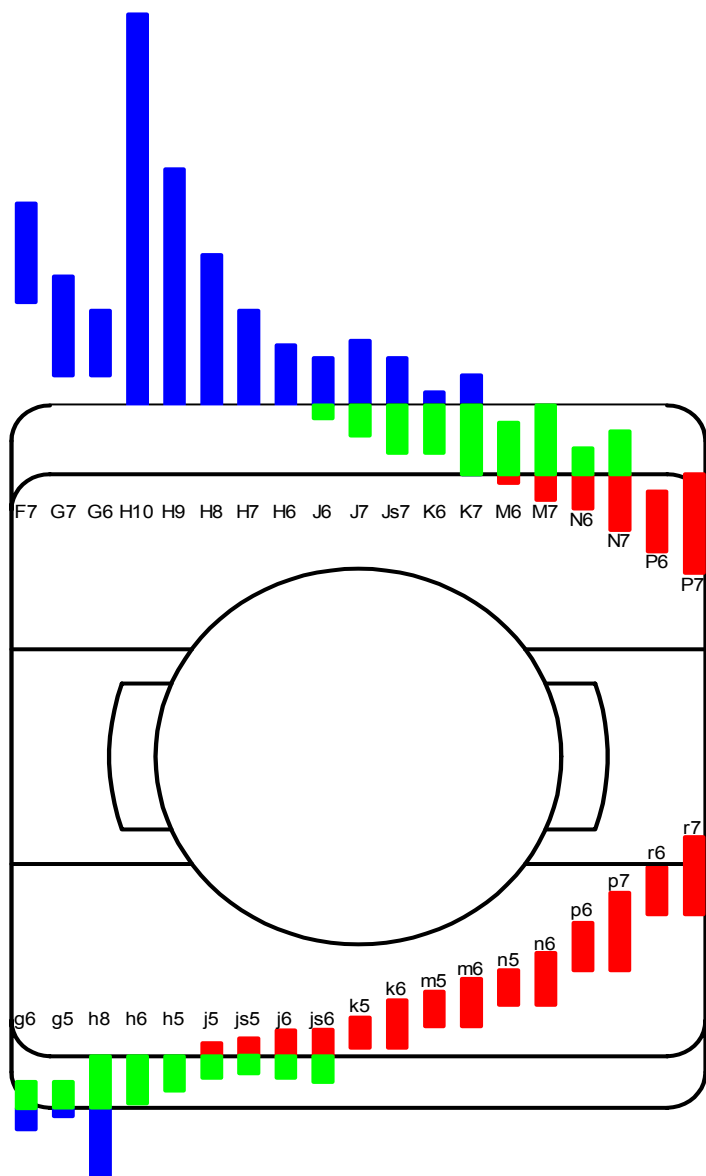

There are three most common types of applications which fit into two fitting categories:

Note: the loads in these application are radial only

■ Type One

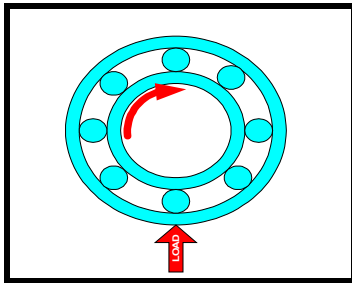

The shaft rotates and the direction of the load does not change. The outer ring is stationary. The entire inner ring raceway comes under load during one revolution of the shaft. Only a portion (an arc) of the outer ring comes under load. This is the most common application. Example Electrical Motor

In this type of application the inner ring wants to slip on the shaft and the outer ring does not want to slip in the housing. An interference fit is required between the shaft and the inner ring bore. The shaft should be slightly larger than the bearing bore. The bearing will have to be pressed onto the shaft. A loose fit is required between the outer ring OD and the housing bore. The housing is slightly larger than the bearing. and the bearing slide axially into the housing.

■ Types Two and Three

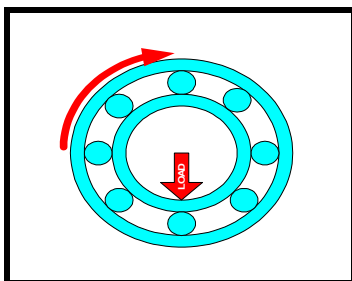

The shaft remains stationary and the outer ring rotates, The direction of the load does not change. The entire outer ring raceway comes under load during one rotation of the housing. Only a portion of the inner ring raceway ever comes under load. Example Pulley

The shaft rotates and the load rotates with the shaft. The outer ring does not rotate. The entire outer ring raceway comes under load during one rotation of the shaft. Only a portion of the inner ring ever comes under load. Example Vibrating Screen.

In these types of application the outer ring wants to slip in the housing and the inner ring does not want to slip on the shaft. An interference fit is required between the bearing OD and the housing. The housing will be slightly smaller than the bearing. The bearing will have to be pressed into the housing. A loose fit is required between the bearing bore and the shaft. The shaft is slightly smaller than the bearing bore. The bearing will slide onto the shaft.

All the other application are a slight combination of these three application and will be taken up later in this book.

Mounting Instructions (Straight Bore)

The Installation Process:

1. Preparing for mounting
2. Inspecting the shaft & housing
3. Unpacking (washing the bearing, when needed)
4. Mounting the bearing
5. Lubrication
6. Test running of the equipment



1. Preparing for mounting

When preparing for mounting, select an appropriate and clean work place to proceed. All of the necessary parts, tools, and equipment should be at hand before beginning the procedure.

2. Inspecting the shaft & housing

Inspect the shaft and housing to confirm that they are free of burrs, flashes or any other defects. Check to confirm that the shaft and housing meet specifications using properly selected tolerances in accordance with American Bearing Manufacturers Association (ABMA) Standard 7, "Shaft and Housing Fits for Metric Ball and Roller Bearings." This includes dimensions, perpendicularity of the shoulder and fillet radii. Non-observance of proper shaft and housing conformity will impair bearing performance leading to premature bearing failure. The cause of such failures is not always easy to establish, much time can be lost looking for the cause of failure.

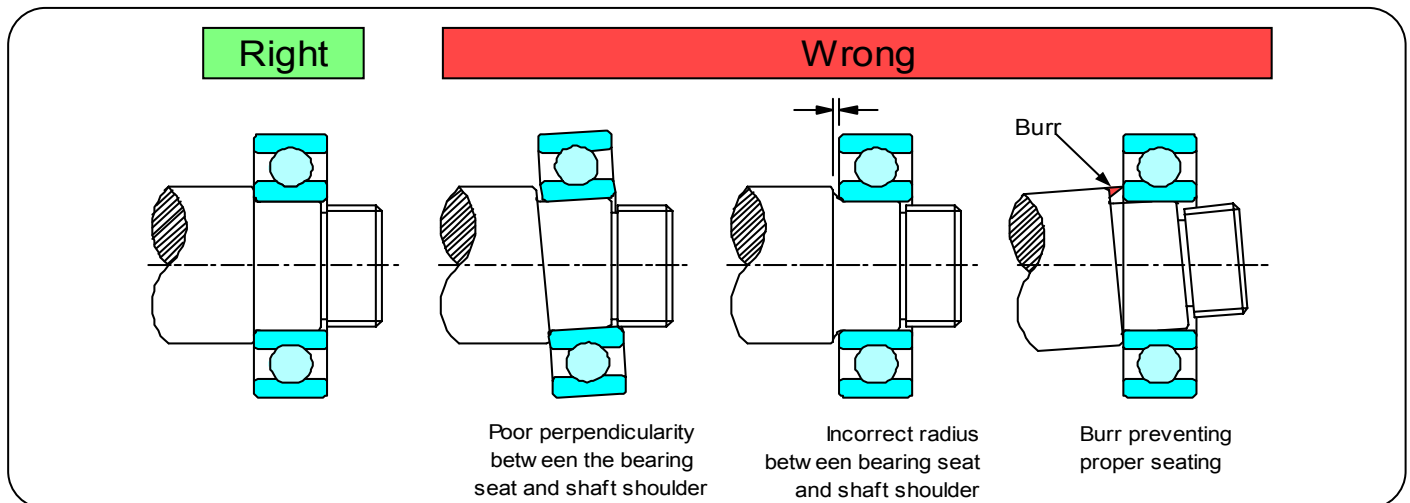

- ▣ Check the shaft diameter at two positions (A and B) in four planes.
- ▣ Record these measurements for future reference.

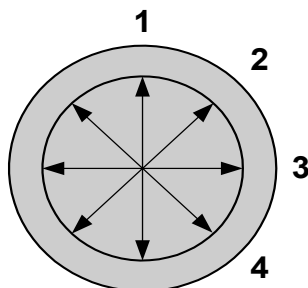

- ▣ Check the housing bore diameter at two positions (A and B) in four planes.
- ▣ Record these measurements for future reference

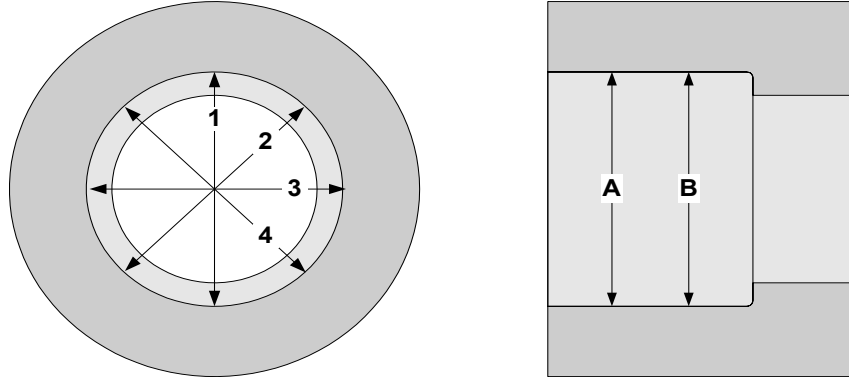

3. Unpacking (washing the bearing, when needed)

Unpack the bearing just before mounting.

Handling with bare hands may cause rust, it is advised that you use a clean pair of vinyl gloves. Dirty gloves are a possible source of dust and dirt which may enter the bearing and cause future problems. Normally a bearing need not be washed after unpacking as the anti-rust preservative coating is compatible with most lubricants. However, high speed and high precision bearings which are used for special applications or when the grease is incompatible with the preservative, the bearing may have to be washed to remove the rust prevention fluid.

When cleaning the bearing it is necessary to use a fresh kerosene, free of impurities such as dust and dirt. Wash the bearing with a filter shower. When a shower is not available use a net to dip the bearing in kerosene.

The cleaning process should be divided into rough cleaning and final cleaning. A separate kerosene container should be used for each process. The bearings should then be carefully dried After cleaning immediately cover the bearings preferably with plastic.



4. Mounting the bearing - Methods of Mounting:

Mount the bearing using one of the three methods:

- 4-1 -the press method
- 4-2 -the heat expansion method
- 4-3 -the adapter or withdrawal sleeve method

Mounting Instructions (Straight Bore)

4-1 Press method :

This is the most common method to mount a bearing and can be used on bearings up to a maximum bore diameter of 60 mm. When mounting with an interference between the shaft and inner ring use a mounting dolly according to the size of the inner ring. It is recommended that a thin film of gear oil should be applied to the shaft.

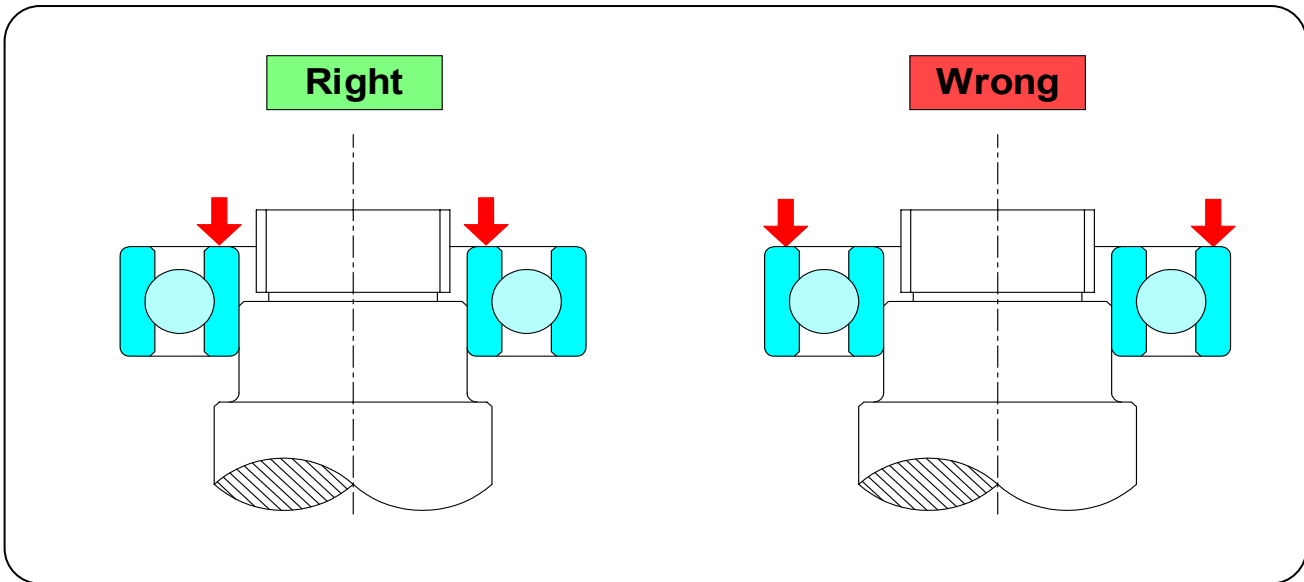

When force is to be applied on the rolling bearing for mounting, it must be applied in a straight line and evenly. Make sure that bearing is centered correctly.

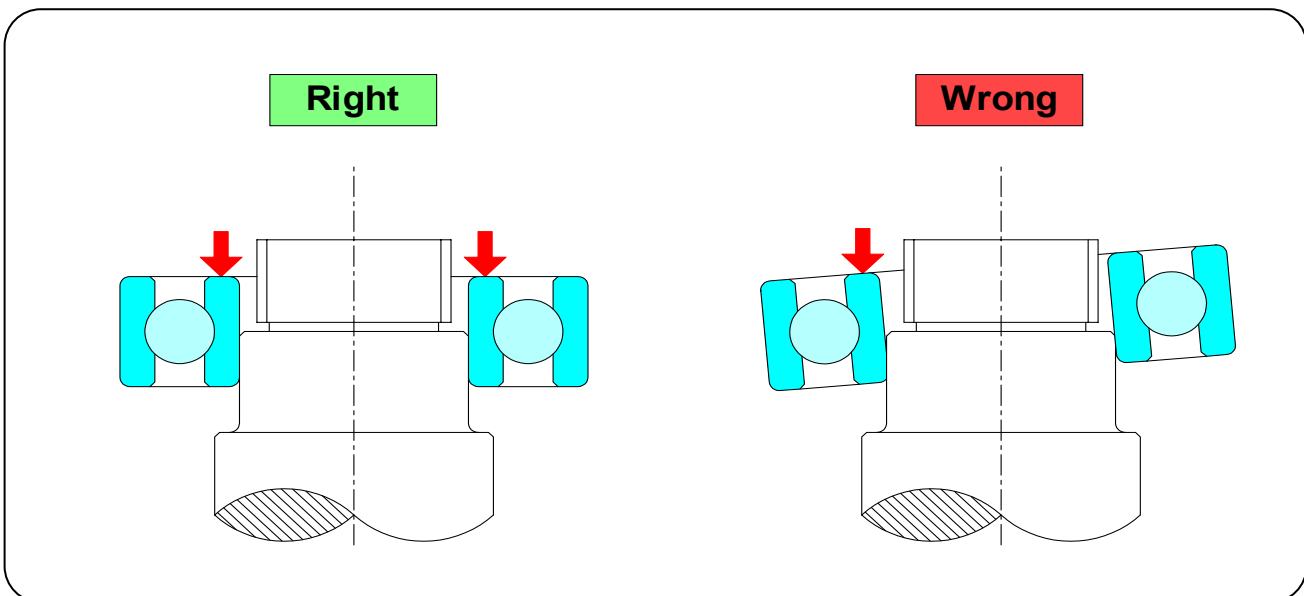

When a press is not available, hammer in the bearing, using only a dead blow hammer and a mounting dolly to minimize the shock to the bearing and evenly distribute the mounting forces. The bearing should not be hammered directly and pressure should be applied only to the inner ring.

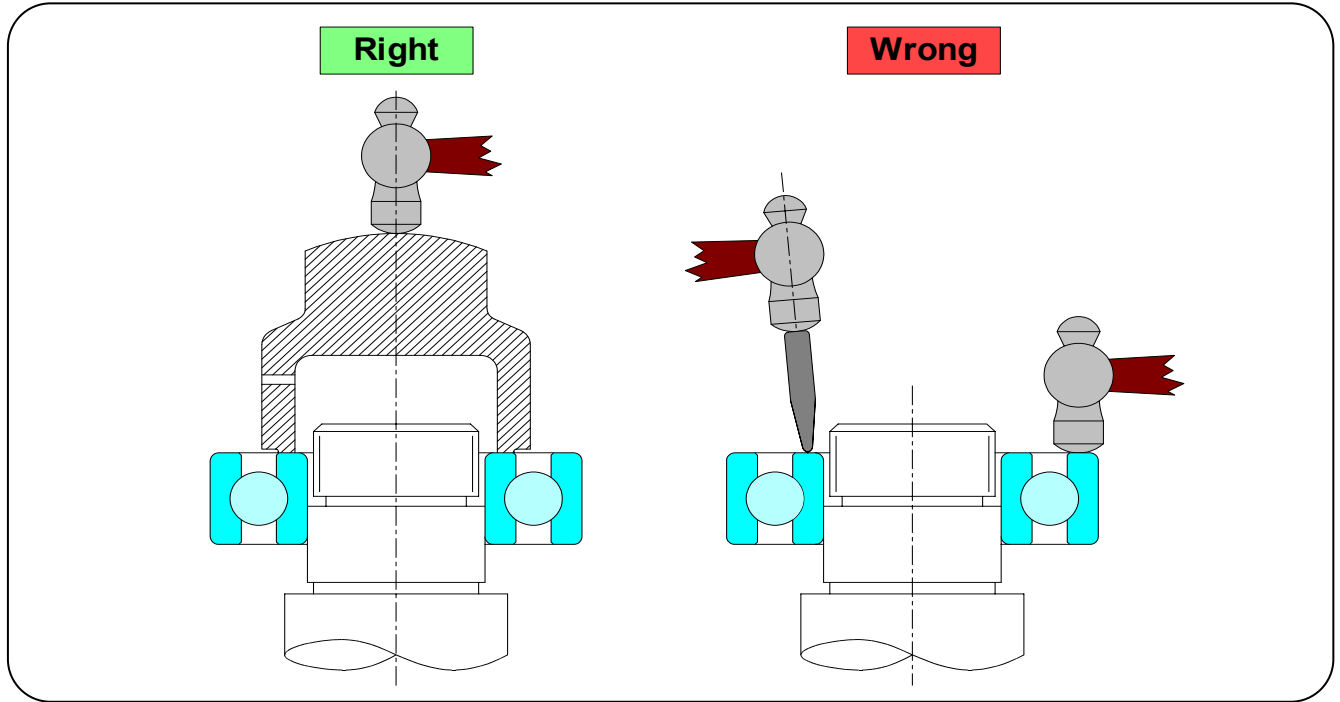

When you are mounting the inner and outer rings at same time, use a metal buffer and apply a force simultaneously on both rings.

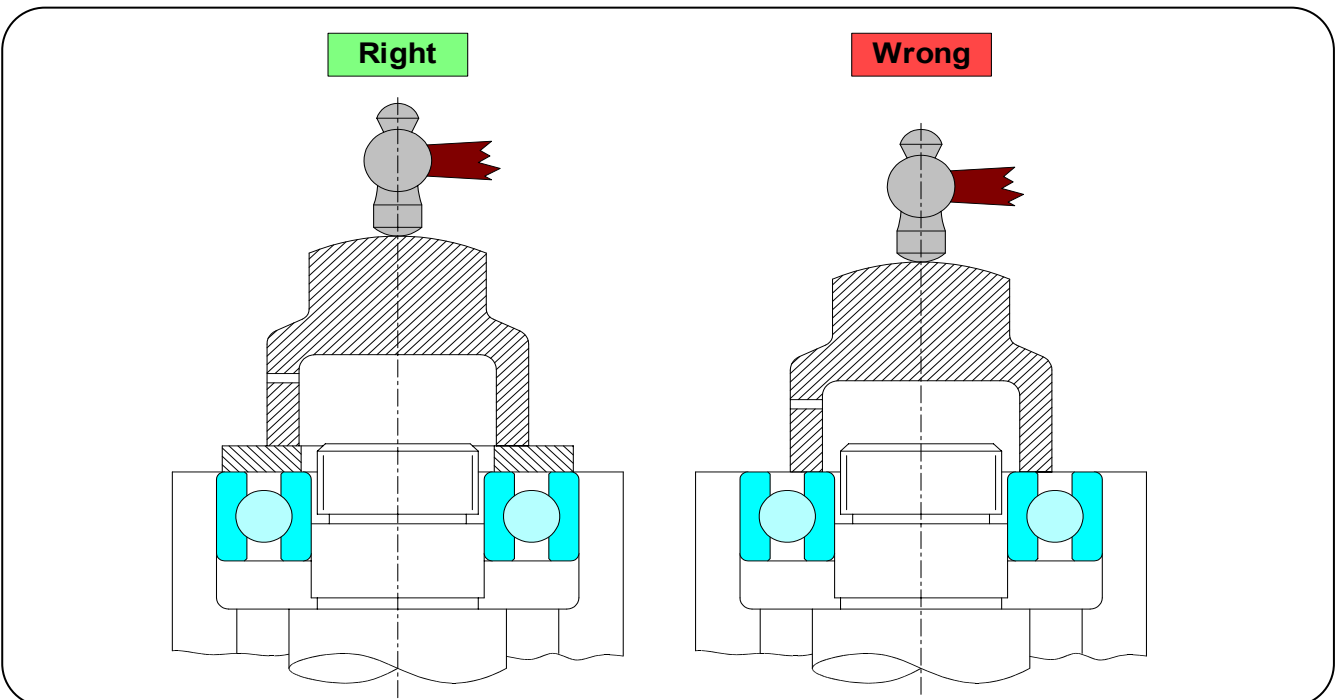

Mounting Instructions (Straight Bore)

4-2 The Thermal expansion method:

If the interference between the inner ring and shaft is large, a thermal expansion method is recommended. This method of mounting is simple if a heat tank or induction heater is available.

- **Absolutely never heat a bearing using an open flame!**

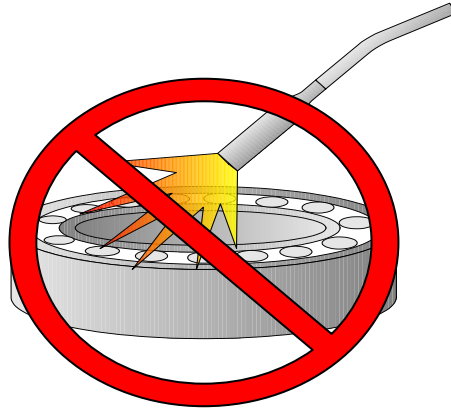

When using a oil bath heating tank, place the bearing on a screen that is several inches off the bottom and heat the tank to the required temperature.

Normally good quality machine oil or transmission oil is used.

The following 3 points should be checked:

- the oil to be used must be always clean
- place the bearing on a wire mesh support, the bearing should never be in direct contact with the bottom of the heating tank
- the oil temperature should not be allowed to exceed 248° F

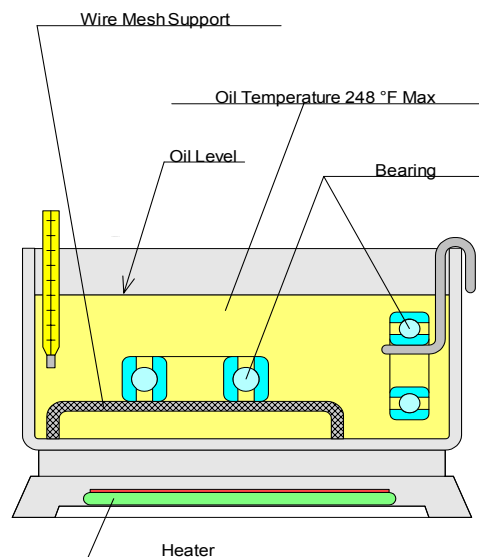
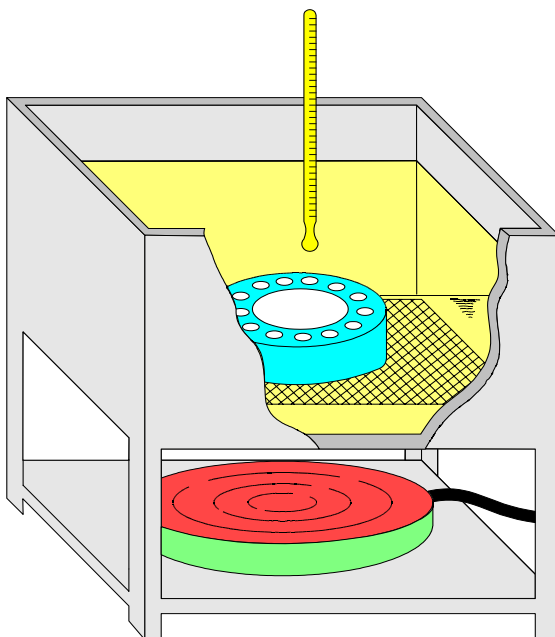

If you frequently mount bearings of similar sizes, use an induction heater with automatic demagnetization. This tool heats by inducing electric currents. It takes only a short time to heat a bearing to 248° F, even a large bearing.

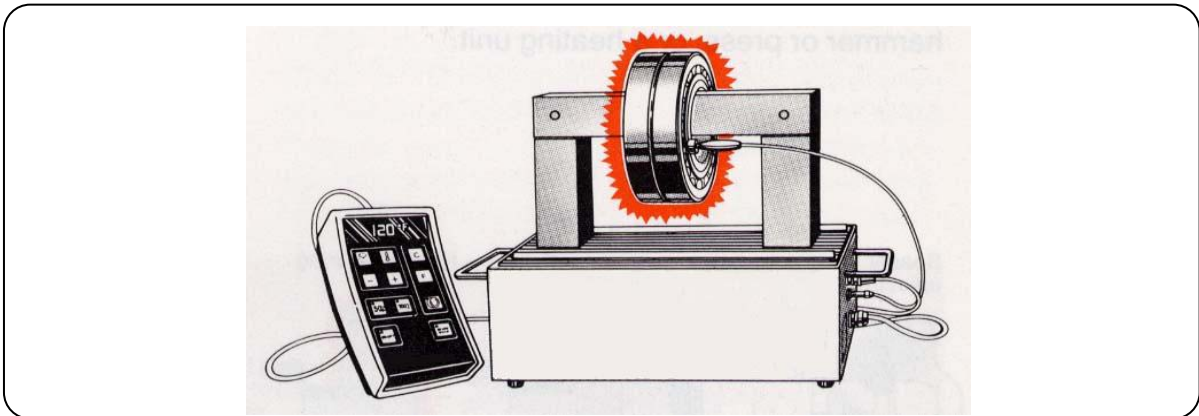

The bearing should be mounted immediately after heating. If the bearing does not slip on smoothly do not force it. In this case remove the bearing and reheat it. If expanding the bearing by heating is not sufficient to get it on the shaft, you may also cool the shaft with dry ice to make it contract. Contraction also will occur in the axial direction as it is cooled and there is a possibility of some clearance developing between the inner ring and shoulder. To prevent this from happening, a small amount of pressure can be applied with a mounting dolly.

4-3 The adapter or withdrawal sleeve method

Please refer to the NACHI Report no. T-276.
(Assembly Instructions for Spherical Roller Bearing)



5. Lubrication

Lubricants are indispensable for all bearings and are classified into oils and greases. Make sure that a specified and adequate amount of clean lubricant is used. When using oil as a lubricant with horizontal shafts, the static oil level must be approx. at the center of the ball or roller at the bottom of its travel. In case of vertical shafts, the oil level is set slightly above the center line of the bearing. The volume of grease to be injected is about 1/3 or 1/2 of the total volume of the internal bearing space. The volume of grease is reduced slightly if the bearing runs at high speeds. In NACHI sealed or shielded bearings the appropriate amount of grease is supplied. Do not subject the sealed or shielded bearings under pressure. This may cause a deformation of seal or shield resulting in bearing problems. No attempt should be made to add lubricant to these bearings. Attempting to do so will most likely result in damage to the bearing.

6. Test Running the Equipment

If possible, do not run bearings at the full operating speed immediately installation. First, rotate the shaft manually and then run the machine at slow speeds. Make sure that the bearings run smoothly and that there is no abnormal noise or vibration. If no problem is detected, gradually raise the speed watching the temperature and checking the lubricant.

Mounting Instructions (Tapered Bore)

Tapered-bore spherical roller bearings can be mounted either on a tapered shaft or on a cylindrical shaft using a tapered adapter sleeve.

Note: Leave the bearing in its protective wrapping until ready to assemble it on the shaft. Do not wash off the preservative coating: it protects the bearing and is compatible with all standard lubricants. Gather all necessary parts and tools before starting.

Required Tools and Equipments:

- Micrometer
- Feeler Gauge
- Spanner Wrench
- Lockwasher
- Hammer & Rod
- Locknut
- Adapter Sleeve; if required
- Graphite or Molybdenum Paste
- Light-duty Oil

1. Measure Shaft Diameter

Check the shaft for dimensional accuracy with a micrometer, also check for nicks and burrs. If any discrepancies are found on the shaft, have it reworked to conform to specification.

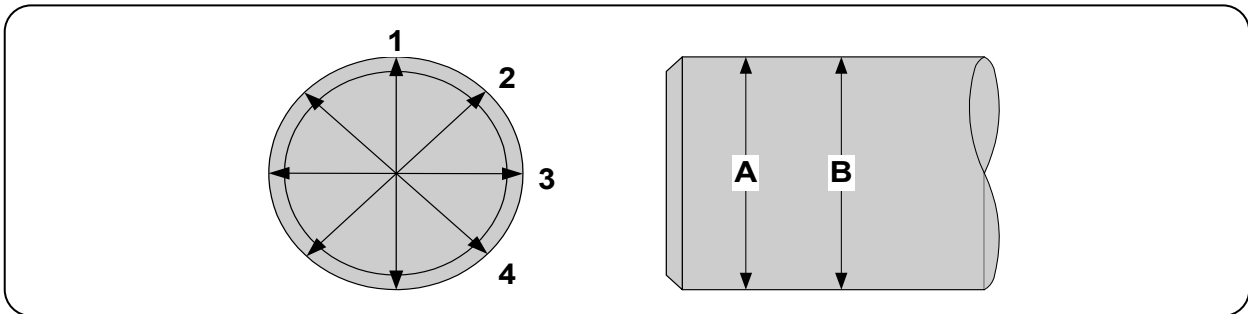

Nominal Shaft Diameter				Deviation	
Over	Incl	Over	Incl	mm	Inch
mm		Inch			
30	50	1.1811	1.9685	+0.000 -0.062	+0.0000 -0.0025
50	80	1.9685	3.1496	+0.000 -0.074	+0.0000 -0.0030
80	120	3.1496	4.7244	+0.000 -0.087	+0.0000 -0.0035
120	180	4.7244	7.0866	+0.000 -0.100	+0.0000 -0.0040
180	250	7.0866	9.8425	+0.000 -0.115	+0.0000 -0.0045
250	315	9.8425	12.4016	+0.000 -0.130	+0.0000 -0.0050
315	400	12.4016	15.748	+0.000 -0.140	+0.0000 -0.0055

2. Measure the Unmounted Radial Internal Clearance

To properly determine initial internal radial clearance, the following procedure should be observed. A feeler gauge with the smallest blade of .0010" is used.

- (a) Place the bearing in an upright position with inner and outer ring faces parallel.
- (b) Place thumbs on inner ring bore and oscillate inner ring two or three times, pressing down firmly. This "Seats" the inner ring and rolling elements(= rollers).
- (c) Position the individual roller assemblies so that a roller is at the top of inner ring - on both sides of the Bearing.

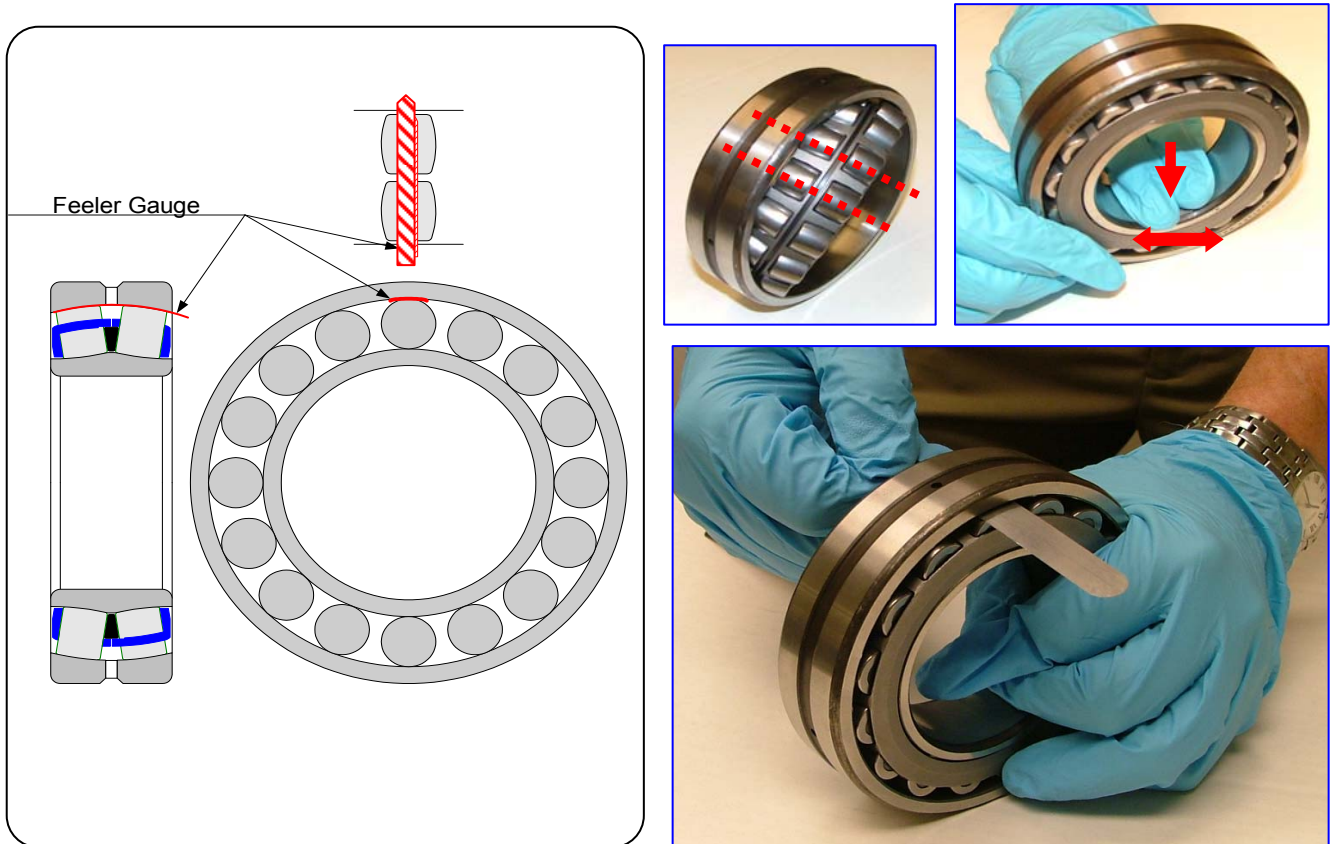

- (d) Press the two rollers inward to assure their being in contact with the center guide ring as well as the inner ring raceways.
- (e) With the rollers in correct position, insert a thin blade of the feeler gauge between the rollers.
- (f) Move it carefully over the top of both rollers between the rollers and outer ring raceway.
- (g) Repeat this procedure, using progressively thicker feeler gauge blades until one is found that will not go through.
- (h) The blade thickness that **preceded** the **"NO - GO"** blade is a measure of internal radial clearance.
- (i) Record the unmounted radial clearance in a convenient place for reference in this procedure.

Mounting Instructions (Tapered Bore)

3. Mount the Adapter Sleeve, if Required

If the bearing is to be mounted on a tapered shaft skip this step. Either dimensionally or visually determine the final position of the bearing. Slide the adapter sleeve onto the shaft with the threads on the sleeve facing the outboard side. Position the sleeve at the approximate location of the bearing centerline.

- (a) remove oil from the shaft to prevent transfer of oil to the bore of the adapter sleeve.
- (b) for SAF units slide inner triple seal onto shaft. This seal slides freely into position.
- (c) position adapter sleeve onto shaft with threads to outboard.

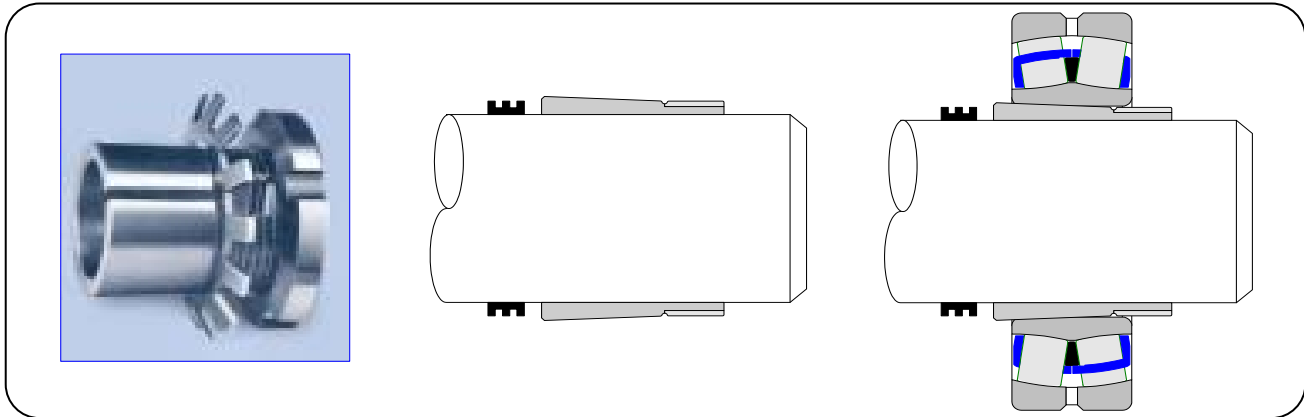

4. Mount the Bearing

Apply a light coating of oil on the outside diameter of the sleeve to facilitate bearing mounting. Starting with the large end of the bearing bore, slide the bearing on the adapter sleeve or shaft so that the taper of the bearing matches the taper of the adapter or shaft. With the bearing hand tight on the adapter sleeve or shaft, position the bearing in the correct location on the shaft. Please note as the bearing is pushed up the adapter the position of the bearing will move about 1/8".

Bearing Bore Diameter (mm)		Radial Clearance Prior to Mounting (in)					
		Normal		C3		C4	
over	incl.	min	max	min	max	min	max
30	40	0.0014	0.0020	0.0020	0.0026	0.0026	0.0034
40	50	0.0018	0.0024	0.0024	0.0032	0.0032	0.0039
50	65	0.0022	0.0030	0.0030	0.0037	0.0037	0.0047
65	80	0.0028	0.0037	0.0037	0.0047	0.0047	0.0059
80	100	0.0032	0.0043	0.0043	0.0055	0.0055	0.0071
100	120	0.0039	0.0053	0.0053	0.0067	0.0067	0.0087
120	140	0.0047	0.0063	0.0063	0.0079	0.0079	0.0102
140	160	0.0051	0.0071	0.0071	0.0091	0.0091	0.0118
160	180	0.0055	0.0079	0.0079	0.0102	0.0102	0.0134
180	200	0.0063	0.0087	0.0087	0.0114	0.0114	0.0146
200	225	0.0071	0.0098	0.0098	0.0126	0.0126	0.0161
225	250	0.0079	0.0106	0.0106	0.0138	0.0138	0.0177
250	280	0.0087	0.0118	0.0118	0.0154	0.0154	0.0193
280	315	0.0095	0.0130	0.0130	0.0169	0.0169	0.0213

5. Drive Up the Bearing

A coating of graphite or molybdenum disulfide paste on both faces of the lock washer and adapter threads will reduce the mounting forces during assembly.

Slip the lock nut on the adapter, the ID tang locates in the split of the adapter under the bearing. Position the locknut on the threads of the adapter with the adapter with the chamfered face toward the bearing.

Tighten the locknut with a heavy-duty spanner wrench. spanner wrench. If using a hammer and chisel, be careful not to damage the lock washer or add debris into the bearing.

Periodically check the internal radial clearance. When the required reduction in radial clearance is measured advance the locknut to align up the locknut to the closest lock washer tang and bend the tang over into the slot to secure the locknut from backing off.

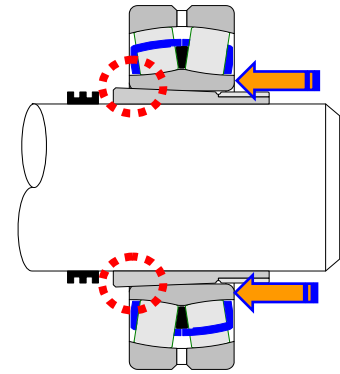

Reduction of Radial Clearance

Bearing Bore Diameter (mm)		Reduction in Internal Radial Clearance (in)			Axial Displacement		Smallest Radial Clearance after Mounting (in)		
					1:12 taper (in)				
over	incl.	Target	min	max	min	max	Normal	C3	C4
30	40	0.0010	0.0008	0.0010	0.0140	0.0180	0.0006	0.0010	0.0016
40	50	0.0010	0.0010	0.0012	0.0180	0.0200	0.0008	0.0012	0.0020
50	65	0.0015	0.0012	0.0016	0.0200	0.0280	0.0010	0.0014	0.0022
65	80	0.0015	0.0016	0.0020	0.0280	0.0330	0.0010	0.0016	0.0028
80	100	0.0020	0.0018	0.0024	0.0300	0.0390	0.0014	0.0020	0.0031
100	120	0.0025	0.0020	0.0028	0.0310	0.0470	0.0020	0.0026	0.0039
120	140	0.0030	0.0026	0.0035	0.0470	0.0590	0.0022	0.0031	0.0043
140	160	0.0035	0.0030	0.0039	0.0510	0.0670	0.0022	0.0035	0.0051
160	180	0.0040	0.0031	0.0043	0.0550	0.0750	0.0024	0.0039	0.0059
180	200	0.0045	0.0035	0.0051	0.0590	0.0870	0.0028	0.0039	0.0063
200	225	0.0050	0.0039	0.0055	0.0670	0.0940	0.0031	0.0047	0.0071
225	250	0.0050	0.0043	0.0059	0.0710	0.1020	0.0035	0.0051	0.0079
250	280	0.0055	0.0047	0.0067	0.0790	0.1140	0.0039	0.0055	0.0087
280	315	0.0060	0.0051	0.0075	0.0870	0.1260	0.0043	0.0059	0.0094

Grease Lubrication

Relubrication guidelines for grease lubricated bearings in horizontal shaft motors with continuous operation

Bearing Size	Ounces of Grease	Bearing Size	Ounces of Grease	Relubrication Interval				
				900	1200	1800	2700	3600
				Motor Speed (rpm)				
6208	0.3	6308	0.4	2 Years	2 Years	12 Months	6 Months	6 Months
6209	0.3	6309	0.4	2 Years	1.5 Years	12 Months	6 Months	6 Months
6210	0.3	6310	0.5	2 Years	1.5 Years	12 Months	6 Months	3 Months
6211	0.4	6311	0.6	2 Years	1.5 Years	12 Months	6 Months	3 Months
6212	0.4	6312	0.7	2 Years	1.5 Years	12 Months	6 Months	3 Months
6213	0.5	6313	0.8	2 Years	1.5 Years	6 Months	3 Months	3 Months
6214	0.5	6314	0.9	2 Years	1.5 Years	6 Months	3 Months	2 Months
6215	0.6	6315	1.1	1.5 Years	12 Months	6 Months	3 Months	2 Months
6216	0.7	6316	1.2	1.5 Years	12 Months	6 Months	2 Months	1Month
6217	0.8	6317	1.3	1.5 Years	12 Months	6 Months	2 Months	1Month
6218	0.9	6318	1.5	1.5 Years	12 Months	6 Months	2 Months	1Month

Our online catalog was used to generate the information on this chart. The information can be obtained on our web site www.nachi.com. Please verify the volume out put per stroke for you grease gun. Guns normally have out puts between 10 shot for one ounce to 33 shots for one ounce. This is a wide range so the grease guns should be calibrated.

Nachi's Radial Ball Bearings standard grease is EXXON **Polyrex EM** Grease. This grease has a polyurea thickener and is used exclusively in the motor industry. Other standard greases used by Nachi are Shell Alvania, and Kyodo Yushi Multemp SRL both greases are lithium thickener greases.

Sealed bearings are lubricated for life. That is the life of the grease not the possible life of the bearing. On most applications, extended grease life can be achieved by relubricating ball bearings. Bearing life should not be compromised by lubrication.

Recommended Grease Replenishment Quantities & Intervals (for lubrication of units in service)				
Bearing P/N	Grease - fluid (oz)	3,600 rpm	1,800 rpm	1,200 rpm
6203 ~ 6208	0.2	2 years	3 years	3 years
6209 ~ 6309	0.4	1 year	2 years	2 years
6310 ~ 6311	0.6	1 year	2 years	2 years
6312 ~ 6317	0.8	1 year	1 year	1 year
6218 ~ 6220	1.0	6 months	1 year	2 years

This is a relubrication schedule specifically for electric motor. Notice how the two tables compare.

**Spherical Roller bearings used in SAF housings
on horizontal shafts applications**

Initially hand pack the bearings and fill the bearing cavity to the bottom of the shaft. Relubrication should be a function of rpm of the application.

Basic Bearing Number	Amount of Grease OZ.	Relube Cycle			
		6 months	4 months	2 months	1 months
		Operating Speed (rpm)			
22209	0.3	2400	3600	5000	5500
22210	0.3	2200	3300	4500	5000
22211	0.4	2000	3000	4000	4500
22213	0.8	1700	2500	3400	3800
22215	0.8	1450	2200	3000	3400
22216	0.9	1350	2000	2800	3200
22217	1.2	1300	1900	2600	3000
22218	1.7	1200	1800	2400	2700
22220	2.3	1100	1650	2200	2300
22222	3.1	1000	1500	1950	2100
22224	4.3	900	1350	1850	1900
22226	5.5	840	1250	1700	1800
22228	6.4	780	1150	11600	1700
22230	7.9	730	1100	1500	1600
Clean & Repack		5 years	3 years	2 years	1 years

Basic Bearing Number	Amount of Grease OZ.	Relube Cycle			
		6 months	4 months	2 months	1 months
		Operating Speed (rpm)			
22309	0.7	1325	2100	3150	4200
22310	1.1	1200	1900	2850	3800
22311	1.3	1075	1800	2700	3600
22313	1.9	925	1500	2250	3000
22315	2.6	800	1300	1950	2600
22316	3.2	750	1250	1875	2500
22317	3.6	700	1150	1725	2300
22318	4.3	650	1100	1650	2200
22320	6.1	600	1000	1500	2000
22322	8.3	550	900	1350	1800
22324	11.6	500	800	1200	1600
22326	13.3	450	750	1125	1500
22328	16.9	425	700	1050	1400
22330	22	400	650	975	1300
Clean & Repack		5 years	3 years	2 years	1 years

Oil Lubrication

The majority of the bearings in operation are lubricated with grease.

Grease is 80% oil so the difference is not as large as you would expect. There are thousands of various greases. Each grease has its own operating characteristic and the Engineer has to align the bearing with the best grease for the application. On the more difficult applications oil is many times preferred. The oil selection process is much easier than the grease selection.

It is important to select an oil having a viscosity which will work with the bearing configuration, operating temperature, rotating speed and load. If the oil viscosity is too low the film between the raceways and the elements can be compromised too easily by the application and the bearing will premature wear. Anti-friction bearings are not designed to wear. Sleeve bearings are designed to wear and so sleeve bearings have acceptable wear rates. When rolling bearings wear they wear out. If the oil viscosity is too high the rotation torque will increase causing the bearing to operate hotter and the input power would also be increase.

dn value is the bore of the bearing multiplied by the rpm of the application

In the following chart the units of dn are in 1,000.

example 50 mm x 2,000 rpm = 100,000 or in the chart 100.

Viscosity is a measure of the resistance of a fluid which is being deformed by either shear or tensile stress. In everyday terms (and for fluids only), viscosity is thickness or "internal friction". Thus, water is "thin", having a lower viscosity, while honey is "thick", having a higher viscosity.

The following is a general oil selection guide.

Operating Temperature °C	Speed dn value 1000	ISO viscosity grade (VG) of Oil		Bearing Types
		Normal Loads	Heavy or Shock Loads	
-40 to 0	Up to Limit	22 32	46	All Types
0 to 60	Up to 15	46 68	100	All Types
	15 to 80	32 64	68	All Types
	80 to 150	22 32	32	All Types
	150 to 500	10	22 32	All Types
60 to 100	Up to 15	150	220	All Types
	15 to 80	100	150	All Types
	80 to 150	68	100 150	All Types
	150 to 500	32	68	All Types
100 to 150	Up to Limit	320		All Types
0 to 60	Up to Limit	46	68	All Types
60 to 100	Up to Limit	150		All Types

The viscosity index is a widely used and accepted measure of the variation in kinematic viscosity due to changes in the temperature of a petroleum product between 40 and 100°C.

A higher viscosity index indicates a smaller decrease in kinematic viscosity with increasing temperature of the lubricant.

The viscosity index is used in practice as a single number indicating temperature dependence of kinematic viscosity.

VISCOSITY CLASSIFICATION EQUIVALENTS						
KINEMATIC VISCOSITIES		ISO VG	AGMA Grades	SAE Grades Auto	SAE Grades Gear	SAYBOLT VISCOSITIES
cSt / 40° C	cSt / 100° C					SUS / 100° F SUS / 210° F
2000						
1000	50	1000	8A		250	5000
800						4000 200
600		680	8			3000
500	30		13			
400		460	7		140	2000
300		320	6			
						100
200	18	220	5	50		1000
150	15	150	4	40	90	800 80
100	12	100	3			500
80	10			30	85	
60	8	68	2		80	300
50	7			20		
40	6	46	1			200
30	5	32		10	75	150 45
20	4	22		5		100 40
10		10				

Rule of Thumb SUS @ 100° F / 5 = cSt @ 40° C

Shaft Fits

- 1) Determine the type of bearing to be used and the bore diameter in millimeters.
- 2) Determine which of the following load conditions is present.
 - a) Rotating Outer Ring Load – Such as a wheel
 - b) Rotating Inner Ring Load – Such as an electric motor or pump
 - c) Rotating Inner Ring Load and High Accuracy is Required – Such as a machine tool spindle.
 - d) Rotating Inner Ring Load that is Considered a Heavy Load – Such as Rail Vehicles or Rolling Mills.
- 3) Select the proper tolerance symbol based on the following table:

Operating Conditions	Shaft Diameter (mm)			Tolerance Symbol	Remarks	Application Example	
	Ball Bearings	Cylindrical Roller Bearings	Spherical Roller Bearings				
Bearings with Cylindrical Bore							
Rotating Outer Ring Load	When the inner ring is required to move on the shaft easily	For All Shaft Diameters			g6	When high precision is required, adopt g5 and h5 respectively. For large bearings, use f6 instead.	Driven Wheel
	When the inner ring is NOT required to move on the shaft easily	For All Shaft Diameters			h6		Tension Pulley or Rope Sheave
Rotating Inner Ring Load or Indeterminate Load Direction	Light or Fluctuating Load	up to 18	-----	-----	h5	When high precision is required, adopt j5, k5, and m5 respectively, instead of j6, k6, and m6.	Conveyors, lightly loaded gear boxes
		(18) to 100	up to 40	-----	j6		
		(100) to 200	(40) to 140	-----	k6		
		-----	(140) to 200	-----	m6		
	Normal Load	upto 18	-----	-----	j5	Use k6 and m6 instead of k5 and m5 for Angular Contact Ball Bearings.	Electric Motors, turbines, pumps, "Bearing applications in general"
		(18) to 100	upto 40	upto 40	k5		
		(100) to 200	(40) to 100	(40) to 65	m5		
		-----	(100) to 140	(65) to 100	m6		
		-----	(140) to 200	(100) to 140	n6		
		-----	(200) to 400	(140) to 280	p6		
Heavy and Shock Loads	-----	(50) to 140	(50) to 100	n6	A bearing with larger than normal clearance is required.	Locomotive Axles and Traction Motors	
	-----	(140) to 200	(100) to 140	p6			
	-----	Over 200	Over 140	r6			
Axial Load Only	upto 250			j6	-----	-----	
	Over 250			js6			

Notes: Shaft tolerances in this table are for solid steel shafts for P0 or P6 bearings
 For every 0.0001" of shaft interference, you lose 0.00007" of the bearing internal clearance

Typical Bearing Loads:		
Heavy Load	$P > 0.18Cr$	$Cr = \text{Basic Dynamic Load Rating}$
Normal Load	$0.08Cr < P < 0.18Cr$	$P = \text{Equivalent Load}$
Light Load	$P < 0.08Cr$	

Housing Fits

- 1) Determine the type of bearing to be used and the outside diameter in millimeters.
- 2) Determine which of the following load conditions is present.
 - a) Rotating Outer Ring Load – Such as a wheel
 - b) Rotating Inner Ring Load – Such as an electric motor or pump
- 3) Select the proper tolerance symbol based on the following table:

Operating Conditions			Tolerance Symbol	Outer Ring Movement	Application Example
Solid Housing	Rotating Outer Ring Load	When a heavy load is applied to a thin-walled housing or impact load.	P7	Outer Ring Can Not be Moved in an Axial Direction	Automobile Wheel (roller bearing)
		Normal or Heavy Load	N7		Automobile Wheel (ball bearing)
		Light or Fluctuating Load	M7		Conveyor Roller or Tension Pulley
	Indeterminate Load Direction	Heavy Impact Load			Traction Motor
			Heavy load or normal load; when the outer ring is not required to move in axial direction		K7
Split or Solid Housing	Indeterminate Load Direction	Normal or light load; when it is desirable for the outer ring to move in an axial direction	J7	Outer Ring Can be Moved in an Axial Direction	Medium-sized electric motors
		Impact load; When an unloaded condition can occur instantaneously			Railroad Car Axle
	Rotating Inner Ring Load	Loads of All Kinds	H7	Outer Ring Can Easily be Moved in an Axial Direction	General Engineering
		Normal Load or Light Load	H8		Gear Transmission
		When a thermal condition through the shaft is present	G7		Drying Cylinder
Solid Housing	When High Accuracy is Required	Fluctuating Load; when extremely accurate rotation and high rigidity are required.	N6	Outer Ring Can Not be Moved in an Axial Direction	Machine Tool Spindle with bearing O.D. > 125 mm
			M6		Machine Tool Spindle with bearing O.D. ≤ 125 mm
		Indeterminate load direction, light load; when extremely accurate rotation is required.	K6	Outer Ring Can Not be Moved in an Axial Direction as a Rule	Centerless Grinder Main Shaft - Fixed Bearing
		When extremely accurate rotation is required and it is desirable for the outer ring to move in an axial direction.	J6	Outer Ring Can be Moved in an Axial Direction	Centerless Grinder Main Shaft - Floating Bearing

Notes: Housing tolerances in this table are applied to cast iron or steel housings for P0 or P6 bearings. For every 0.0001" of housing interference, you use 0.0001" of the bearings internal clearance. A tighter fit may be adopted for light alloy housings.

Shaft Bearing Seat Diameters

(Values in Inches)

Bearing Bore Diameter			g6		h6		h5		j5		j6		k5	
			Shaft Diameter	Fit in 0.0001"	Shaft Diameter	Fit in 0.0001"	Shaft Diameter	Fit in 0.0001"	Shaft Diameter	Fit in 0.0001"	Shaft Diameter	Fit in 0.0001"	Shaft Diameter	Fit in 0.0001"
mm	Max.	Min.	Max.	Min.	Max.	Min.	Max.	Min.	Max.	Min.	Max.	Min.	Max.	Min.
4	0.1575	0.1572	0.1573	0.1570	0.1575	0.1572	0.1575	0.1573	0.1576	0.1574	0.1577	0.1574	0.1577	0.1575
5	0.1969	0.1966	0.1967	0.1964	0.1969	0.1966	0.1969	0.1967	0.1970	0.1968	0.1971	0.1968	0.1971	0.1969
6	0.2362	0.2359	0.2360	0.2357	0.2362	0.2359	0.2362	0.2360	0.2363	0.2361	0.2364	0.2361	0.2364	0.2362
7	0.2756	0.2753	0.2754	0.2750	0.2756	0.2752	0.2756	0.2754	0.2758	0.2755	0.2759	0.2755	0.2759	0.2756
8	0.3150	0.3147	0.3148	0.3144	0.3150	0.3146	0.3150	0.3148	0.3152	0.3149	0.3153	0.3149	0.3153	0.3150
9	0.3543	0.3540	0.3541	0.3537	0.3543	0.3539	0.3543	0.3541	0.3545	0.3542	0.3546	0.3542	0.3546	0.3543
10	0.3937	0.3934	0.3935	0.3931	0.3937	0.3933	0.3937	0.3935	0.3939	0.3936	0.3940	0.3936	0.3940	0.3937
12	0.4724	0.4721	0.4722	0.4717	0.4724	0.4720	0.4724	0.4721	0.4726	0.4723	0.4727	0.4723	0.4728	0.4724
15	0.5906	0.5903	0.5904	0.5899	0.5906	0.5902	0.5906	0.5903	0.5908	0.5905	0.5909	0.5905	0.5910	0.5906
17	0.6693	0.6690	0.6691	0.6686	0.6693	0.6689	0.6693	0.6690	0.6695	0.6692	0.6696	0.6692	0.6697	0.6693
20	0.7874	0.7870	0.7871	0.7866	0.7874	0.7869	0.7874	0.7870	0.7876	0.7872	0.7878	0.7872	0.7878	0.7875
25	0.9843	0.9839	0.9840	0.9835	0.9843	0.9838	0.9843	0.9839	0.9845	0.9841	0.9847	0.9841	0.9847	0.9844
30	1.1811	1.1807	1.1808	1.1803	1.1811	1.1806	1.1811	1.1807	1.1813	1.1809	1.1815	1.1809	1.1815	1.1812
35	1.3780	1.3775	1.3776	1.3770	1.3780	1.3774	1.3780	1.3776	1.3782	1.3778	1.3784	1.3778	1.3784	1.3781
40	1.5748	1.5743	1.5744	1.5738	1.5748	1.5742	1.5748	1.5744	1.5750	1.5746	1.5752	1.5746	1.5752	1.5749
45	1.7717	1.7712	1.7713	1.7707	1.7717	1.7711	1.7717	1.7713	1.7719	1.7716	1.7721	1.7716	1.7721	1.7718
50	1.9685	1.9680	1.9681	1.9675	1.9685	1.9679	1.9685	1.9681	1.9687	1.9683	1.9689	1.9683	1.9690	1.9686
55	2.1654	2.1648	2.1650	2.1643	2.1654	2.1647	2.1654	2.1649	2.1656	2.1651	2.1658	2.1651	2.1660	2.1655
60	2.3622	2.3616	2.3618	2.3611	2.3622	2.3615	2.3622	2.3617	2.3624	2.3619	2.3626	2.3619	2.3626	2.3623
65	2.5591	2.5585	2.5587	2.5580	2.5591	2.5584	2.5591	2.5586	2.5593	2.5588	2.5595	2.5588	2.5595	2.5592
70	2.7559	2.7553	2.7555	2.7548	2.7559	2.7552	2.7559	2.7554	2.7561	2.7556	2.7563	2.7556	2.7565	2.7560
75	2.9528	2.9522	2.9524	2.9517	2.9528	2.9521	2.9528	2.9523	2.9530	2.9525	2.9532	2.9525	2.9534	2.9529
80	3.1496	3.1490	3.1492	3.1485	2.9528	3.1489	3.1496	3.1491	3.1498	3.1493	3.1500	3.1493	3.1502	3.1497
85	3.3465	3.3457	3.3460	3.3452	3.3465	3.3456	3.3465	3.3459	3.3467	3.3461	3.3470	3.3461	3.3472	3.3466
90	3.5433	3.5425	3.5428	3.5420	3.5433	3.5424	3.5433	3.5427	3.5435	3.5429	3.5438	3.5429	3.5440	3.5434
95	3.7402	3.7394	3.7397	3.7389	3.7402	3.7393	3.7402	3.7396	3.7404	3.7398	3.7407	3.7398	3.7409	3.7403
100	3.9370	3.9362	3.9365	3.9357	3.9370	3.9361	3.9370	3.9364	3.9372	3.9366	3.9375	3.9366	3.9377	3.9371
105	4.1339	4.1331	4.1334	4.1326	4.1339	4.1330	4.1339	4.1333	4.1341	4.1335	4.1344	4.1335	4.1346	4.1340
110	4.3307	4.3299	4.3302	4.3294	4.3307	4.3298	4.3307	4.3301	4.3309	4.3303	4.3312	4.3303	4.3314	4.3308
115	4.5276	4.5268	4.5271	4.5263	4.5276	4.5267	4.5276	4.5270	4.5278	4.5272	4.5281	4.5272	4.5283	4.5277
120	4.7244	4.7236	4.7239	4.7231	4.7244	4.7235	4.7244	4.7238	4.7246	4.7240	4.7249	4.7240	4.7251	4.7245
125	4.9213	4.9203	4.9207	4.9198	4.9213	4.9203	4.9213	4.9206	4.9216	4.9209	4.9219	4.9209	4.9221	4.9214
130	5.1181	5.1171	5.1175	5.1166	5.1181	5.1171	5.1181	5.1174	5.1184	5.1177	5.1187	5.1177	5.1189	5.1182
140	5.5118	5.5108	5.5112	5.5103	5.5118	5.5108	5.5118	5.5111	5.5121	5.5114	5.5124	5.5114	5.5126	5.5119
150	5.9055	5.9045	5.9049	5.9040	5.9055	5.9045	5.9055	5.9048	5.9058	5.9051	5.9061	5.9051	5.9063	5.9056
160	6.2992	6.2982	6.2986	6.2977	6.2992	6.2982	6.2992	6.2985	6.2995	6.2988	6.2996	6.2988	6.3000	6.2993
170	6.6929	6.6919	6.6923	6.6914	6.6929	6.6919	6.6929	6.6922	6.6932	6.6925	6.6935	6.6925	6.6937	6.6930
180	7.0866	7.0856	7.0860	7.0851	7.0866	7.0856	7.0866	7.0859	7.0869	7.0862	7.0872	7.0862	7.0874	7.0867
190	7.4803	7.4791	7.4797	7.4786	7.4803	7.4792	7.4803	7.4795	7.4806	7.4798	7.4809	7.4798	7.4812	7.4805
200	7.8740	7.8728	7.8734	7.8723	7.8740	7.8729	7.8740	7.8732	7.8743	7.8735	7.8746	7.8735	7.8749	7.8742
220	8.6614	8.6602	8.6608	8.6597	8.6614	8.6603	8.6614	8.6606	8.6617	8.6609	8.6620	8.6609	8.6623	8.6616
240	9.4488	9.4476	9.4482	9.4471	9.4488	9.4477	9.4488	9.4480	9.4491	9.4483	9.4494	9.4483	9.4497	9.4490
260	10.2362	10.2348	10.2355	10.2343	10.2362	10.2349	10.2362	10.2353	10.2365	10.2356	10.2368	10.2356	10.2373	10.2364
280	11.0236	11.0222	11.0229	11.0217	11.0236	11.0223	11.0236	11.0225	11.0239	11.0230	11.0241	11.0230	11.0247	11.0238
300	11.8110	11.8096	11.8103	11.8091	11.8110	11.8097	11.8110	11.8101	11.8113	11.8104	11.8116	11.8104	11.8121	11.8112
320	12.5984	12.5968	12.5977	12.5963	12.5984	12.5970	12.5984	12.5974	12.5987	12.5977	12.5991	12.5977	12.5995	12.5986
340	13.3858	13.3842	13.3851	13.3837	13.3858	13.3844	13.3858	13.3848	13.3861	13.3851	13.3865	13.3851	13.3869	13.3860
360	14.1732	14.1716	14.1725	14.1711	14.1732	14.1718	14.1732	14.1722	14.1735	14.1725	14.1739	14.1725	14.1743	14.1734
380	14.9606	14.9590	14.9599	14.9585	14.9616	14.9592	14.9616	14.9596	14.9609	14.9599	14.9613	14.9599	14.9617	14.9608
400	15.7480	15.7464	15.7473	15.7459	15.7480	15.7466	15.7480	15.7464	15.7483	15.7473	15.7487	15.7473	15.7491	15.7482
420	16.5354	16.5336	16.5346	16.5330	16.5354	16.5338	16.5354	16.5343	16.5357	16.5346	16.5362	16.5346	16.5367	16.5356
440	17.3228	17.3210	17.3220	17.3186	17.3228	17.3212	17.3228	17.3217	17.3231	17.3220	17.3236	17.3220	17.3241	17.3230
460	18.1102	18.1084	18.1094	18.1060	18.1102	18.1086	18.1102	18.1091	18.1105	18.1094	18.1110	18.1094	18.1115	18.1104
480	18.8976	18.8958	18.8968	18.8952	18.8976	18.8960	18.8976	18.8968	18.8979	18.8968	18.8984	18.8968	18.8989	18.8978
500	19.6850	19.6832	19.6842	19.6826	19.6850	19.6834	19.6850	19.6839	19.6853	19.6842	19.6858	19.6842	19.6863	19.6852

Shaft Bearing Seat Diameters

(Values in Inches)

Bearing Bore Diameter			k6			m5			m6			n6			p6			r6		
			Shaft Diameter		Fit in 0.0001"	Shaft Diameter		Fit in 0.0001"	Shaft Diameter		Fit in 0.0001"	Shaft Diameter		Fit in 0.0001"	Shaft Diameter		Fit in 0.0001"	Shaft Diameter		Fit in 0.0001"
mm	Inches		Max.	Min.		Max.	Min.		Max.	Min.		Max.	Min.		Max.	Min.		Max.	Min.	
4	0.1575	0.1572	0.1579	0.1575	0T	0.1579	0.1577	0.1580	0.1577	2T	0.1581	0.1578								
5	0.1969	0.1966	0.1973	0.1969	0T	0.1973	0.1971	0.1974	0.1972	2T	0.1975	0.1972								
6	0.2362	0.2359	0.2366	0.2362	7T	0.2366	0.2364	0.2367	0.2364	8T	0.2369	0.2365								
7	0.2756	0.2753	0.2760	0.2756		0.2761	0.2758	0.2364	0.2760		0.2763	0.2760								
8	0.3150	0.3147	0.3155	0.3150	0T	0.3156	0.3152	0.3157	0.3154	2T	0.3157	0.3154								
9	0.3543	0.3540	0.3547	0.3543	7T	0.3548	0.3545	0.3549	0.3552	9T	0.3550	0.3552								
10	0.3937	0.3934	0.3941	0.3937		0.3942	0.3939	0.3943	0.3946		0.3944	0.3946								
12	0.4724	0.4721	0.4729	0.4724		0.4730	0.4727	0.4731	0.4729		0.4733	0.4729								
15	0.5906	0.5903	0.5911	0.5906	0T	0.5912	0.5909	0.5913	0.5911	3T	0.5915	0.5911								
17	0.6693	0.6690	0.6698	0.6693	8T	0.6699	0.6696	0.6700	0.6692	10T	0.6702	0.6692								
20	0.7874	0.7870	0.7880	0.7875		0.7881	0.7877	0.7882	0.7880		0.7885	0.7880								
25	0.9843	0.9839	0.9849	0.9844	1T	0.9850	0.9846	0.9851	0.9849	3T	0.9854	0.9849								
30	1.1811	1.1807	1.1817	1.1812	10T	1.1818	1.1814	1.1819	1.1817	12T	1.1822	1.1817								
35	1.3780	1.3775	1.3787	1.3781		1.3788	1.3784	1.3790	1.3787		1.3793	1.3787								
40	1.5748	1.5743	1.5755	1.5749	1T	1.5756	1.5752	1.5758	1.5655	4T	1.5761	1.5655								
45	1.7717	1.7712	1.7724	1.7718	12T	1.7725	1.7721	1.7727	1.7724	15T	1.7730	1.7724								
50	1.9685	1.9680	1.9692	1.9686		1.9693	1.9689	1.9695	1.9692		1.9698	1.9692								
55	2.1654	2.1648	2.1662	2.1655		2.1664	2.1659	2.1666	2.1658		2.1669	2.1662								
60	2.3622	2.3616	2.3630	2.3623		2.3632	2.3627	2.3634	2.3626		2.3637	2.3630								
65	2.5591	2.5585	2.5599	2.5592	1T	2.5601	2.5596	2.5603	2.5595	4T	2.5606	2.5599								
70	2.7559	2.7553	2.7567	2.7560	14T	2.7569	2.7564	2.7571	2.7563	18T	2.7574	2.7567								
75	2.9528	2.9522	2.9536	2.9529		2.9538	2.9533	2.9540	2.9532		2.9543	2.9536								
80	3.1496	3.1490	3.1504	3.1497		3.1506	3.1501	3.1508	3.1500		3.1511	3.1504								
85	3.3465	3.3457	3.3475	3.3466		3.3476	3.3470	3.3479	3.3470		3.3483	3.3474								
90	3.5433	3.5425	3.5443	3.5434		3.5444	3.5438	3.5447	3.5438		3.5450	3.5442								
95	3.7402	3.7394	3.7412	3.7403		3.7413	3.7407	3.7416	3.7407		3.7420	3.7411								
100	3.9370	3.9362	3.9380	3.9371	1T	3.9381	3.9375	3.9384	3.9375	5T	3.9388	3.9379	26T							
105	4.1339	4.1331	4.1349	4.1340	18T	4.1350	4.1344	4.1353	4.1344	22T	4.1357	4.1348								
110	4.3307	4.3299	4.3317	4.3308		4.3318	4.3312	4.3321	4.3312		4.3325	4.3316								
115	4.5276	4.5268	4.5286	4.5277		4.5287	4.5281	4.5290	4.5281		4.5294	4.5285								
120	4.7244	4.7236	4.7254	4.7245		4.7255	4.7249	4.7258	4.7249		4.7262	4.7253								
125	4.9213	4.9203	4.9224	4.9214		4.9226	4.9219	4.9229	4.9219		4.9233	4.9224								
130	5.1181	5.1171	5.1192	5.1182		5.1194	5.1187	5.1197	5.1187		5.1208	5.1192								
140	5.5118	5.5108	5.5129	5.5119		5.5131	5.5124	5.5134	5.5012		5.5129	5.5129								
150	5.9055	5.9045	5.9066	5.9056	1T	5.9068	5.9061	5.9071	5.9061	6T	5.9075	5.9066	11T							
160	6.2992	6.2982	6.3003	6.2993	21T	6.3005	6.2998	6.3008	6.2998	26T	6.3012	6.3003	30T							
170	6.6929	6.6919	6.6940	6.6930		6.6942	6.6935	6.6945	6.6935		6.6949	6.6940								
180	7.0866	7.0856	7.0877	7.0867		7.0879	7.0872	7.0882	7.0872		7.0886	7.0877								
190	7.4803	7.4791	7.4817	7.4805		7.4818	7.4810	7.4821	7.4810		7.4827	7.4815								
200	7.8740	7.8728	7.8754	7.8742	2T	7.8755	7.8747	7.8758	7.8747	7T	7.8764	7.8752								
220	8.6614	8.6602	8.6628	8.6616	26T	8.6629	8.6621	8.6632	8.6621	7T	8.6638	8.6626	12T							
240	9.4488	9.4476	9.4502	9.4490		9.4503	9.4495	9.4506	9.4495	30T	9.4512	9.4500	36T							
260	10.2362	10.2348	10.2376	10.2364		10.2376	10.2370	10.2382	10.2370		10.2397	10.2375								
280	11.0236	11.0222	11.0250	11.0238	2T	11.0253	11.0253	11.0256	11.0244	8T	11.0262	11.0249	13T							
300	11.8110	11.8096	11.8124	11.8112	28T	11.8127	11.8118	11.8130	11.8118	34T	11.8136	11.8123	40T							
320	12.5984	12.5968	12.6000	12.5986		12.6002	12.5992	12.6006	12.5992		12.6013	12.5999								
340	13.3858	13.3842	13.3874	13.3860		13.3876	13.3866	13.3880	13.3866		13.3887	13.3887								
360	14.1732	14.1716	14.1748	14.1734	2T	14.1750	14.1740	14.1754	14.1740	8T	14.1761	14.1747	15T							
380	14.9606	14.9590	14.9622	14.9608	32T	14.9624	14.9614	14.9628	14.9614	38T	14.9635	14.9621	45T							
400	15.7480	15.7464	15.7496	15.7482		15.7502	15.7488	15.7502	15.7488		15.7509	15.7495								
420	16.5354	16.5336	16.5372	16.5356		16.5374	16.5363	16.5379	16.5363		16.5385	16.5370								
440	17.3228	17.3210	17.3246	17.3230		17.3248	17.3237	17.3253	17.3237	9T	17.3259	17.3244								
460	18.1102	18.1084	18.1120	18.1104	2T	18.1122	18.1111	18.1127	18.1111	38T	18.1133	18.1118	16T							
480	18.8976	18.8958	18.8994	18.8978	36T	18.8996	18.8985	18.9001	18.8985		18.9007	18.8992	49T							
500	19.6850	19.6832	19.6873	19.6852		19.6870	19.6859	19.6875	19.6859		19.6881	19.6866								

Housing Bearing Seat Diameters

(Values in Inches)

Bearing Outside Diameter			G7		Fit in 0.0001"	H8		Fit in 0.0001"	H7		Fit in 0.0001"	J6		Fit in 0.0001"	J7		Fit in 0.0001"	K6		Fit in 0.0001"
			Min.	Max.		Min.	Max.		Min.	Max.		Min.	Max.		Min.	Max.		Min.	Max.	
mm	Inches																			
	Min.	Max.	Min.	Max.		Min.	Max.		Min.	Max.		Min.	Max.		Min.	Max.		Min.	Max.	
16	0.6299	0.6296	0.6301	0.6308	12L 2L	0.6299	0.6310	14L 0T	0.6299	0.6306	10L 0T	0.6297	0.6301	5L 2T	0.6296	0.6303	7L 3T	0.6295	0.6300	4L 4T
19	0.7480	0.7476	0.7483	0.7491		0.7480	0.7492		0.7480	0.7488		0.7478	0.7483		0.7476	0.7485		0.7475	0.7480	
22	0.8661	0.8657	0.8664	0.8672		0.8661	0.8673		0.8661	0.8669		0.8659	0.8664		0.8657	0.8666		0.8656	0.8661	
24	0.9449	0.9445	0.9452	0.9460	15L	0.9449	0.9461	17L	0.9449	0.9457	12L	0.9447	0.9452	7L	0.9445	0.9454	9L	0.9444	0.9449	4L
26	1.0236	1.0232	1.0239	1.0247	3L	1.0236	1.0248	0T	1.0236	1.0244	0T	1.0234	1.0239	2T	1.0232	1.0241	4T	1.0231	1.0236	5T
28	1.1024	1.1020	1.1027	1.1035		1.1024	1.1036		1.1024	1.1032		1.1022	1.1027		1.1020	1.1029		1.1019	1.1024	
30	1.1811	1.1807	1.1814	1.1822		1.1811	1.1823		1.1811	1.1819		1.1809	1.1814		1.1807	1.1816		1.1806	1.1811	
32	1.2598	1.2594	1.2602	1.2611		1.2598	1.2613		1.2598	1.2608		1.2596	1.2602		1.2594	1.2604		1.2593	1.2599	
35	1.3780	1.3776	1.3784	1.3793		1.3780	1.3795		1.3780	1.3790		1.3778	1.3784		1.3776	1.3786		1.3775	1.3781	
37	1.4567	1.4563	1.4571	1.4580	17L	1.4567	1.4582	19L	1.4567	1.4577	14L	1.4565	1.4571	8L	1.4563	1.4573	10L	1.4562	1.4568	5L
40	1.5748	1.5748	1.5752	1.5761	4L	1.5748	1.5763	0T	1.5748	1.5758	0T	1.5746	1.5752	2T	1.5744	1.5754	4T	1.5743	1.5749	5T
42	1.6535	1.6531	1.6539	1.6548		1.6535	1.6550		1.6535	1.6545		1.6533	1.6539		1.6531	1.6541		1.6530	1.6536	
47	1.8504	1.8500	1.8508	1.8517		1.8504	1.8519		1.8504	1.8514		1.8502	1.8508		1.8500	1.8510		1.8499	1.8505	
52	2.0472	2.0467	2.0476	2.0488		2.0472	2.0490		2.0472	2.0484		2.0470	2.0477		2.0467	2.0479		2.0466	2.0474	
55	2.1654	2.1649	2.1658	2.1670		2.1654	2.1672		2.1654	2.1666		2.1652	2.1659		2.1649	2.1661		2.1648	2.1656	
62	2.4409	2.4404	2.4413	2.4425	21L	2.4409	2.4427	23L	2.4409	2.4421	17L	2.4407	2.4414	10L	2.4404	2.4416	12L	2.4403	2.4411	7L
72	2.8346	2.8341	2.8350	2.8362	4L	2.8346	2.8364	0T	2.8346	2.8358	0T	2.8344	2.8351	2T	2.8341	2.8353	5T	2.8340	2.8348	6T
80	3.1493	3.1491	3.1500	3.1512		3.1496	3.1514		3.1496	3.1508		3.1494	3.1501		3.1491	3.1503		3.1490	3.1498	
85	3.3465	3.3459	3.3470	3.3484		3.3465	3.3486		3.3465	3.3479		3.3463	3.3471		3.3460	3.3474		3.3458	3.3467	
90	3.5433	3.5427	3.5438	3.5452		3.5433	3.5454		3.5433	3.5447		3.5431	3.5439		3.5428	3.5442		3.5426	3.5435	
100	3.9370	3.9364	3.9375	3.9389	25L	3.9370	3.9391	27L	3.9370	3.9384	20L	3.9368	3.9376	12L	3.9365	3.9379	15L	3.9363	3.9372	8L
110	4.3307	4.3301	4.3312	4.3326	5L	4.3307	4.3328	0T	4.3307	4.3321	0T	4.3305	4.3313	2T	4.3302	4.3316	5T	4.3300	4.3309	7T
115	4.5276	4.5270	4.5281	4.5295		4.5276	4.5297		4.5276	4.5290		4.5274	4.5282		4.5271	4.5285		4.5269	4.5278	
120	4.7244	4.7238	4.7249	4.7263		4.7244	4.7265		4.7244	4.7258		4.7242	4.7250		4.7239	4.7253		4.7237	4.7246	
125	4.9213	4.9206	4.9219	4.9234		4.9213	4.9238		4.9213	4.9229		4.9210	4.9220		4.9207	4.9223		4.9205	4.9215	
130	5.1181	5.1174	5.1187	5.1202		5.1181	5.1206		5.1181	5.1197		5.1178	5.1188		5.1175	5.1191		5.1173	5.1183	
140	5.5118	5.5111	5.5124	5.5139	28L	5.5118	5.5143	32L	5.5118	5.5134	23L	5.5115	5.5125	14L	5.5112	5.5128	17L	5.5110	5.5120	9L
145	5.7087	5.7080	5.7093	5.7108	6L	5.7087	5.7112	0T	5.7087	5.7103	0T	5.7084	5.7094	3T	5.7081	5.7097	6T	5.7079	5.7089	8T
150	5.9055	5.9048	5.9061	5.9076		5.9055	5.9080		5.9055	5.9071		5.9052	5.9062		5.9049	5.9065		5.9047	5.9057	
160	6.2992	6.2982	6.2998	6.3013		6.2992	6.3017		6.2992	6.3008		6.2989	6.2999		6.2986	6.3002		6.2984	6.2994	
170	6.6929	6.6919	6.6935	6.6950	31L	6.6929	6.6954	35L	6.6929	6.6946	26L	6.6926	6.6936	17L	6.6923	6.6939	20L	6.6921	6.6931	12L
180	7.0868	7.0856	7.0872	7.0887	6L	7.0868	7.0891	0T	7.0868	7.0885	0T	7.0863	7.0873	3T	7.0860	7.0876	6T	7.0858	7.0868	8T
190	7.4803	7.4791	7.4809	7.4827		7.4803	7.4831		7.4803	7.4821		7.4800	7.4812		7.4797	7.4815		7.4794	7.4805	
200	7.8740	7.8728	7.8746	7.8764		7.8740	7.8768		7.8740	7.8768		7.8737	7.8749		7.8734	7.8752		7.8731	7.8742	
210	8.2677	8.2665	8.2683	8.2701		8.2677	8.2705		8.2677	8.2695		8.2674	8.2686		8.2671	8.2689		8.2668	8.2679	
215	8.4646	8.4634	8.4652	8.4670	36L	8.4646	8.4674	40L	8.4646	8.4664	30L	8.4643	8.4655	21L	8.4640	8.4658	24L	8.4637	8.4648	14L
225	8.8583	8.8571	8.8589	8.8607	6L	8.8583	8.8611	0T	8.8583	8.8601	0T	8.8580	8.8592	3T	8.8577	8.8595	6T	8.8574	8.8585	9T
240	9.4488	9.4476	9.4494	9.4512		9.4488	9.4516		9.4488	9.4506		9.4485	9.4497		9.4482	9.4500		9.4479	9.4490	
250	9.8425	9.8413	9.8431	9.8449		9.8425	9.8453		9.8425	9.8443		9.8422	9.8434		9.8419	9.8437		9.8416	9.8427	
260	10.2362	10.2340	10.2369	10.2389		10.2362	10.2394		10.2362	10.2382		10.2359	10.2372		10.2356	10.2376		10.2351	10.2364	
280	11.0236	11.0222	11.0243	11.0263	41L	11.0236	11.0268	46L	11.0236	11.0256	34L	11.0233	11.0246	24L	11.0230	11.0246	28L	11.0225	11.0238	16L
300	11.8110	11.8096	11.8117	11.8137	7L	11.8110	11.8142	0T	11.8110	11.8130	0T	11.8107	11.8120	3T	11.8104	11.8124	6T	11.8099	11.8112	11T
310	12.2047	12.2033	12.2054	12.2074		12.2047	12.2079		12.2047	12.2067		12.2044	12.2057		12.2041	12.2061		12.2036	12.2049	
320	12.5984	12.5968	12.5991	12.6014		12.5984	12.6019		12.5984	12.6006		12.5981	12.5995		12.5977	12.5999		12.5973	12.5987	
340	13.3858	13.3842	13.3865	13.3888		13.3858	13.3893		13.3858	13.3880		13.3855	13.3869		13.3851	13.3873		13.3847	13.3861	
360	14.1732	14.1716	14.1739	14.1762	46L	14.1732	14.1767	51L	14.1732	14.1754	38L	14.1729	14.1743	27L	14.1725	14.1747	31L	14.1721	14.1735	19L
380	14.9606	14.9590	14.9613	14.9636	7L	14.9606	14.9641	0T	14.9606	14.9628	0T	14.9603	14.9617	3T	14.9599	14.9621	7T	14.9595	14.9609	11T
400	15.7480	15.7464	15.7487	15.7510		15.7480	15.7515		15.7480	15.7512		15.7477	15.7491		15.7473	15.7495		15.7469	15.7483	
420	16.5354	16.5336	16.5362	16.5387		16.5354	16.5392		16.5354	16.5379		16.5351	16.5367		16.5346	16.5371		16.5341	16.5357	
440	17.3228	17.3210	17.3236	17.3261		17.3228	17.3266		17.3228	17.3253		17.3225	17.3241		17.3220	17.3245		17.3215	17.3231	
460	18.1102	18.1084	18.1110	18.1135	51L	18.1102	18.1140	56L	18.1102	18.1127	43L	18.1099	18.1115	31L	18.1094	18.1119	35L	18.1089	18.1105	21L
480	18.8976	18.8958	18.8984	18.9009	8L	18.8976	18.9014	0T	18.8976	18.9001	0T	18.8973	18.8980	3T	18.8968	18.8993	8T	18.8963	18.8979	13T
500	19.6850	19.6832	19.6858	19.6883		19.6850	19.6888		19.6850	19.6876		19.6847	19.6863		19.6842	19.6867		19.6837	19.6853	
520	20.4724	20.4704	20.4733	20.4760		20.4724	20.4767		20.4724	20.4752		20.4721	20.4739		20.4715	20.4743		20.4707	20.4724	
540	21.2598	21.2578	21.2607	21.2634		21.2598	21.2641		21.2598	21.2626		21.2595	21.2613		21.2589	21.2617		21.2581	21.2598	
580	22.8346	22.8326	22.8355	22.8382	56L	22.8346	22.8389	63L	22.8346	22.8374	48L	22.8342	22.8361	35L	22.8337	22.8365	39L	22.8329	22.8346	20L
600	23.6220	23.6200	23.6229	23.6256	9L	23.6220	23.6263	0T	23.6220	23.6248	0T	23.6217	23.6235	3T	23.6211	23.6239	9T	23.6203	23.6220	17T
620	24.4094	24.4074	24.4103	24.4130		24.4094</														

Housing Bearing Seat Diameters

(Values in Inches)

Bearing Outside Diameter			K7		M6		M7		N6		N7		P7							
			Housing Bore		Fit in 0.0001*	Housing Bore		Fit in 0.0001*	Housing Bore		Fit in 0.0001*	Housing Bore		Fit in 0.0001*	Housing Bore		Fit in 0.0001*			
mm	Inches		Min.	Max.		Min.	Max.		Min.	Max.		Min.	Max.		Min.	Max.				
16	0.6299	0.6296	0.6294	0.6301	5L 5T	0.6293	0.6297	1L 6T	0.6292	0.6299	3L 7T	0.6291	0.6295	1T 8T	0.6290	0.6297	1L 9T	0.6288	0.6295	1T 11T
19	0.7480	0.7476	0.7474	0.7482		0.7473	0.7478		0.7472	0.7480		0.7471	0.7476		0.7469	0.7477		0.7466	0.7474	
22	0.8661	0.8657	0.8655	0.8663		0.8654	0.8659		0.8653	0.8661		0.8652	0.8657		0.8650	0.8658		0.8647	0.8655	
24	0.9449	0.9445	0.9443	0.9451	6L	0.9442	0.9447	2L	0.9441	0.9449	4L	0.9440	0.9445	0T	0.9438	0.9446	1L	0.9435	0.9443	2T
26	1.0236	1.0232	1.0230	1.0238	6T	1.0229	1.0234	7T	1.0228	1.0236	8T	1.0227	1.0232	9T	1.0225	1.0233	11T	1.0232	1.0230	14T
28	1.1024	1.1020	1.1018	1.1026		1.1017	1.1022		1.1016	1.1024		1.1015	1.1020		1.1013	1.1021		1.1010	1.1018	
30	1.1811	1.1807	1.1805	1.1813		1.1804	1.1809		1.1803	1.1811		1.1802	1.1807		1.1800	1.1808		1.1797	1.1805	
32	1.2598	1.2594	1.2591	1.2601		1.2590	1.2596		1.2588	1.2598		1.2587	1.2593		1.2585	1.2595		1.2581	1.2591	
35	1.3780	1.3776	1.3773	1.3783		1.3772	1.3778		1.3770	1.3780		1.3769	1.3775		1.3767	1.3777		1.3763	1.3773	
37	1.4567	1.4563	1.4560	1.4570	7L	1.4559	1.4565	2L	1.4557	1.4567	4L	1.4556	1.4562	1T	1.4554	1.4564	1L	1.4550	1.4560	3T
40	1.5748	1.5758	1.5741	1.5751	7T	1.5740	1.5746	8T	1.5738	1.5748	10T	1.5737	1.5743	11T	1.5735	1.5745	13T	1.5731	1.5747	17T
42	1.6535	1.6531	1.6528	1.6538		1.6527	1.6533		1.6525	1.6535		1.6524	1.6530		1.6522	1.6532		1.6518	1.6528	
47	1.8504	1.8500	1.8497	1.8507		1.8496	1.8502		1.8494	1.8504		1.8493	1.8499		1.8491	1.8501		1.8487	1.8497	
52	2.0472	2.0467	2.0464	2.0476		2.0462	2.0470		2.0459	2.0472		2.0459	2.0466		2.0457	2.0468		2.0452	2.0464	
55	2.1654	2.1649	2.1646	2.1658		2.1644	2.1652		2.1642	2.1654		2.1641	2.1648		2.1639	2.1650		2.1634	2.1646	
62	2.4409	2.4404	2.4401	2.4413	9L	2.4399	2.4407	3L	2.4397	2.4409	5L	2.4396	2.4403	1T	2.4394	2.4405	1L	2.4389	2.4401	3T
72	2.8346	2.8341	2.8338	2.8350	8T	2.8336	2.8344	9T	2.8334	2.8346	12T	2.8333	2.8340	13T	2.8331	2.8342	15T	2.8326	2.8338	20T
80	3.1493	3.1491	3.1488	3.1500		3.1486	3.1494		3.1484	3.1496		3.1483	3.1490		3.1481	3.1492		3.1476	3.1488	
85	3.3465	3.3459	3.3455	3.3469		3.3454	3.3463		3.3451	3.3465		3.3450	3.3459		3.3447	3.3461		3.3442	3.3456	
90	3.5433	3.5427	3.5423	3.5437		3.5422	3.5431		3.5419	3.5433		3.5418	3.5427		3.5415	3.5429		3.5410	3.5424	
100	3.9370	3.9364	3.9360	3.9374	10L	3.9359	3.9368	4L	3.9356	3.9370	6L	3.9355	3.9364	0T	3.9352	3.9366	2L	3.9347	3.9361	3T
110	4.3307	4.3301	4.3297	4.3311	10T	4.3296	4.3305	11T	4.3293	4.3307	14T	4.3292	4.3301	15T	4.3289	4.3303	18T	4.3284	4.3298	23T
115	4.5276	4.5270	4.5266	4.5280		4.5265	4.5274		4.5262	4.5276		4.5261	4.5270		4.5258	4.5272		4.5253	4.5267	
120	4.7244	4.7238	4.7234	4.7248		4.7233	4.7242		4.7230	4.7244		4.7229	4.7238		4.7226	4.7240		4.7221	4.7235	
125	4.9213	4.9206	4.9202	4.9218		4.9200	4.9210		4.9197	4.9213		4.9195	4.9205		4.9193	4.9208		4.9188	4.9202	
130	5.1181	5.1174	5.1170	5.1186		5.1168	5.1178		5.1165	5.1181		5.1163	5.1173		5.1160	5.1176		5.1154	5.1170	
140	5.5118	5.5111	5.5107	5.5123	12L	5.5105	5.5115	4L	5.5102	5.5118	7L	5.5100	5.5110	1T	5.5098	5.5113	2L	5.5091	5.5107	4T
145	5.7087	5.7080	5.7076	5.7092	11T	5.7074	5.7084	13T	5.7071	5.7087	16T	5.7069	5.7079	18T	5.7068	5.7082	20T	5.7060	5.7076	27T
150	5.9055	5.9048	5.9044	5.9060		5.9042	5.9052		5.9039	5.9055		5.9037	5.9047		5.9035	5.9050		5.9028	5.9044	
160	6.2992	6.2986	6.2981	6.2997		6.2979	6.2989		6.2973	6.2992		6.2973	6.2984		6.2972	6.2987		6.2965	6.2981	
170	6.6929	6.6919	6.6916	6.6934	15L	6.6916	6.6926	7L	6.6913	6.6929	10L	6.6910	6.6921	2L	6.6909	6.6924	5L	6.6902	6.6918	1T
180	7.0868	7.0862	7.0855	7.0871	11T	7.0853	7.0863	13T	7.0850	7.0866	16T	7.0847	7.0858	18T	7.0846	7.0861	20T	7.0839	7.0855	27T
190	7.4803	7.4797	7.4790	7.4808		7.4788	7.4800		7.4785	7.4803		7.4783	7.4794		7.4779	7.4797		7.4772	7.4790	
200	7.8740	7.8734	7.8727	7.8745		7.8725	7.8737		7.8722	7.8740		7.8720	7.8731		7.8716	7.8734		7.8709	7.8727	
210	8.2677	8.2665	8.2664	8.2682		8.2662	8.2674		8.2659	8.2677		8.2657	8.2668		8.2653	8.2671		8.2646	8.2664	
215	8.4646	8.4634	8.4633	8.4651	17L	8.4631	8.4643	9L	8.4628	8.4646	12L	8.4626	8.4637	3L	8.4622	8.4640	6L	8.4615	8.4633	1T
225	8.8583	8.8571	8.8570	8.8588	13T	8.8568	8.8580	15T	8.8565	8.8583	18T	8.8563	8.8574	20T	8.8559	8.8577	24T	8.8552	8.8570	31T
240	9.4488	9.4476	9.4475	9.4493		9.4473	9.4485		9.4470	9.4488		9.4468	9.4479		9.4464	9.4482		9.4457	9.4475	
250	9.8425	9.8413	9.8412	9.8430		9.8410	9.8422		9.8407	9.8425		9.8405	9.8416		9.8401	9.8419		9.8394	9.8412	
260	10.2362	10.2340	10.2348	10.2368		10.2346	10.2358		10.2342	10.2362		10.2340	10.2352		10.2336	10.2356		10.2327	10.2348	
280	11.0236	11.0222	11.0222	11.0242	20L	11.0220	11.0232	10L	11.0216	11.0236	14L	11.0214	11.0226	4L	11.0210	11.0226	8L	11.0201	11.0222	0T
300	11.8110	11.8096	11.8096	11.8116	14T	11.8094	11.8106	16T	11.8090	11.8110	20T	11.8088	11.8100	22T	11.8084	11.8104	26T	11.8075	11.8096	35T
310	12.2047	12.2033	12.2033	12.2053		12.2031	12.2043		12.2027	12.2047		12.2025	12.2037		12.2021	12.2041		12.2012	12.2033	
320	12.5984	12.5968	12.5968	12.5991		12.5966	12.5980		12.5962	12.5984		12.5958	12.5974		12.5955	12.5978		12.5945	12.5968	
340	13.3858	13.3842	13.3842	13.3865		13.3840	13.3854		13.3836	13.3858		13.3832	13.3848		13.3829	13.3858		13.3819	13.3842	
360	14.1732	14.1716	14.1716	14.1739	23L	14.1710	14.1728	12L	14.1710	14.1732	16L	14.1708	14.1726	6L	14.1703	14.1726	10L	14.1693	14.1716	0T
380	14.9606	14.9590	14.9590	14.9613	16T	14.9588	14.9602	18T	14.9584	14.9606	22T	14.9580	14.9596	24T	14.9578	14.9600	29T	14.9567	14.9590	39T
400	15.7480	15.7464	15.7464	15.7487		15.7462	15.7476		15.7458	15.7480		15.7454	15.7470		15.7452	15.7474		15.7441	15.7464	
420	16.5354	16.5336	16.5336	16.5361		16.5334	16.5350		16.5329	16.5354		16.5328	16.5343		16.5323	16.5347		16.5310	16.5336	
440	17.3228	17.3210	17.3210	17.3235		17.3208	17.3224		17.3203	17.3228		17.3202	17.3217		17.3197	17.3221		17.3184	17.3210	
460	18.1102	18.1084	18.1084	18.1109	25L	18.1082	18.1098	14L	18.1077	18.1102	18L	18.1076	18.1091	7L	18.1071	18.1095	11L	18.1058	18.1084	0T
480	18.8976	18.8958	18.8958	18.8983	18T	18.8956	18.8972	20T	18.8951	18.8976	25T	18.8950	18.8965	26T	18.8945	18.8969	31T	18.8932	18.8958	43T
500	19.6850	19.6832	19.6832	19.6857		19.6830	19.6846		19.6825	19.685										

Bearing Selection

Shaft and Housing Dimensions

Many times the shaft selection is decided by the customer on his basic design. Shaft strength is normally one of the primary limitations. Bearing size is then determined by the size of the customer shaft. Housing size normally has more flexibility, the Outside Diameter of the bearing and the width of the bearing can be dictated by our customers, but these dimension are normally open to discussion. As previously shown bearings with the same bore and OD dimension have considerable variations.

Please review the section on Shaft and Housing Fitting Practices. These are straight forward. The chart for shaft fits requires the product type, the shaft size, the application type and the loading conditions. The chart produces a tolerance class which is a small case letter followed by a number. Using the shaft size and tolerance class a second set of charts show the bearing bore tolerance and the recommended shaft tolerance. We use these shaft to bearing fits to determine bearing internal clearance removal.

The chart for housing fits is similar to the shaft chart as knowing the bearing type, application and loading conditions, we are able to again find a tolerance class for the housing. The tolerance class for the housing will be a capital letter followed by a number. Using the bearing OD and the tolerance class a second set of charts show the bearing OD tolerance and the recommended housing bore tolerance. We use these housing to bearing fits to determine bearing internal clearance removal.

Internal Clearances

Interference fits between the shaft & bearing and housing & bearing reduce the bearing internal clearance. This calculation is dependent on operating temperature, housing material, housing cross section, shaft material, and solid or hollow shaft. This calculation can be done manually or on our web site.

Environmental Conditions

Most of the time we are considering open bearings or bearings with out seals. When seals or shields are required we are limited to radial ball bearings. Discussions on housing seals is important as contamination leads to bearing failure by lubrication. Redundant sealing or seals with dual acting features are always an important point. Lubricant is normally selected by the customer so we will comment on our experiences with the specific products.

We always try and use standard commercial parts as the cost of special bearings will increase the cost of the product as well as extend the availability of the bearings.

Fixed vs. Expansion Sides

Two bearings are normally mounted on each shaft. One of the bearings will be designated as the fixed bearing as it axially locates the shaft with the housing.

The second bearing will be the expansion bearing. The expansion bearing may be similar to the NU cylindrical roller bearing and will not accept thrust loading.

The expansion bearing may be standard and the housing will be machined so that the bearing will not be located up against a confining shoulder in the housing.

Bearings are very stiff and as the bearing and shaft heats up we try and limit the possibility of the bearings loading axially against each other, as this is another possible way of causing premature bearing failure.

Material will expand when exposed to heat. We have to select the correct shaft tolerance and housing tolerances to insure Material's Thermal Expansion Growth do not adversely affect the bearings.

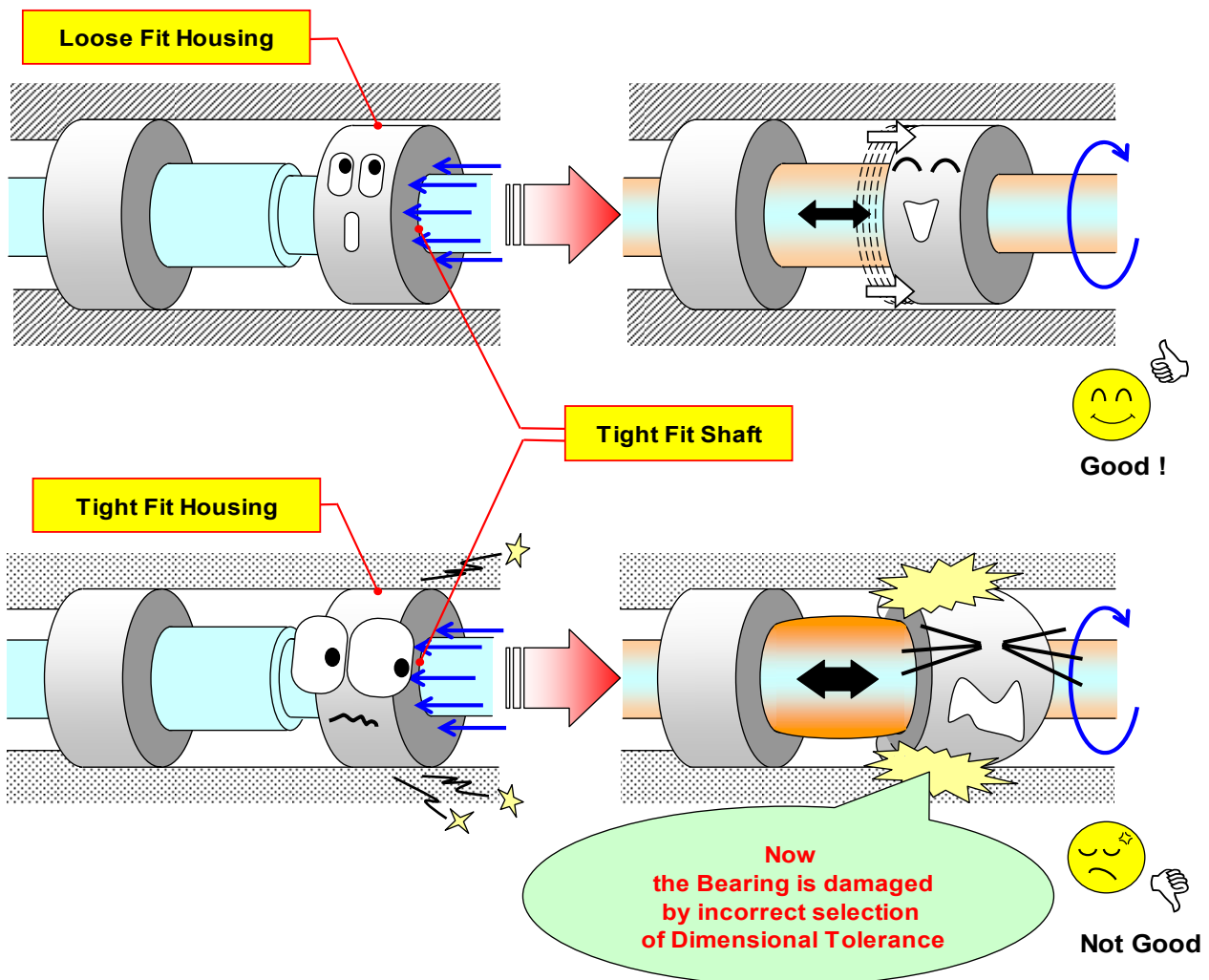

Bearing Selection

The bearing application will determine which bearing would be the better selection. These are some of the basic requirements for any application:

- | | |
|---|---|
| <ul style="list-style-type: none"> ● Bearing Speed. ● Bearing loads ● Expected Service Life ● Environmental Temperature ● Contamination from Environment | <ul style="list-style-type: none"> ● Seals for housing and/or bearing ● Dimensional limitations. ● Shaft and Housing Fits ● Fixed vs Expansion ● Lubrication |
|---|---|

When reviewing the application please take time to write down these requirements. Bearing speed. Speed causes increase in operating temperature. Review catalog values. Ball Bearings spin faster than roller bearings
The smaller the bearing cross section the faster the bearing can spin.

Bearing No.	Dynamic Load (lbs)	Limiting speeds (rpm)			
		Oil	Shielded	Sealed	Grease
6010	4,910	10,000	8,500	5,000	8,500
6210	7,875	8,600	7,100	4,800	7,100
6310	13,950	7,500	6,400	4,300	6,400
7210B (single)	7,207	7,500	---	---	5,600
7210B (double)	14,302	6,000	---	---	4,500
7310B (single)	11,149	6,700	---	---	5,000
7310B (double)	22,185	5,300	---	---	4,000
NU210	10,800	8,500	---	---	7,100
NU210E	15,520	7,700	---	---	6,400
NU310	19,570	6,700	---	---	5,600
NU310E	24,750	6,500	---	---	5,400
22210EX	32,170	7,100	---	---	5,600
21310EX	40,040	5,600	---	---	4,500
22310EX	62,900	5,300	---	---	4,300

This was simplified since we used only radial load which transfer directly to resultant load. Life comparisons becomes more complex if the application has radial and axial loads, then X and Y factors must be used. These factors are dependent on bearing angles, the ability of the bearings to accept radial and axial loads.

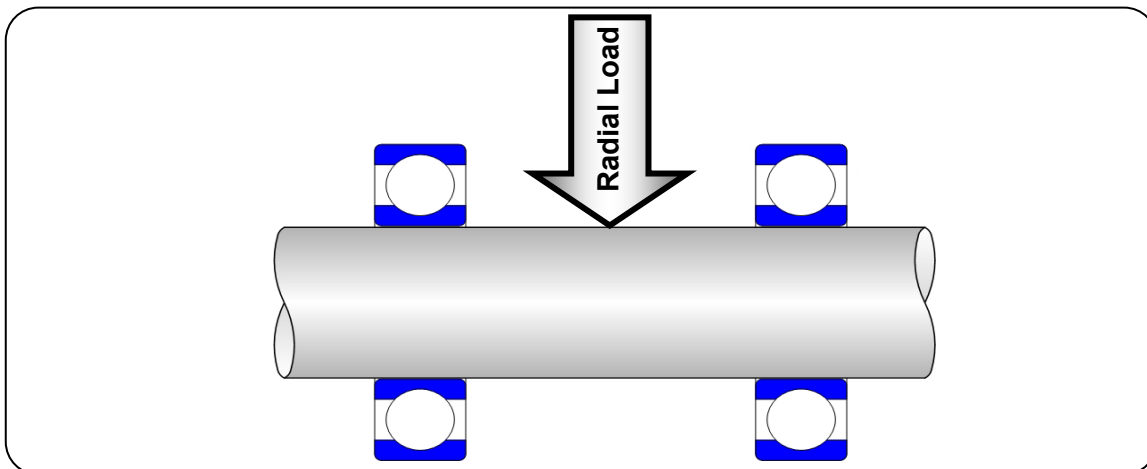

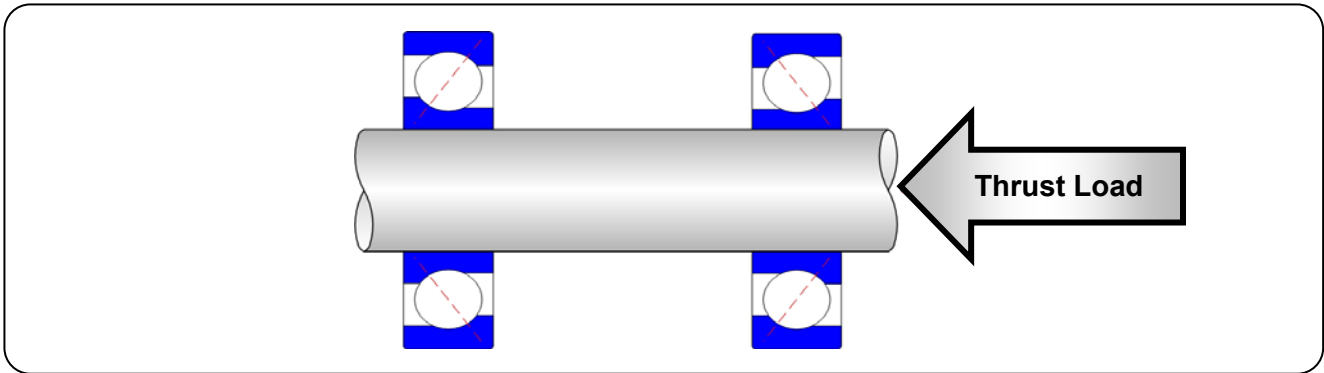

The "C" Capacity of the bearing is used to calculate bearing life. The loading ratio "load/C" indicates type of load. 1% to 8% are lightly loads, 8% to 18% medium loads; heavy load 18% to 25%. Light loaded applications tend to operate at higher speeds, medium loaded applications operate at half of the speed limit of the bearings, and heavy loaded application operate at low rpm.

The expected bearing life indicates how long our customer believes the bearing should last. The following standard formula has been used for decades to estimate bearing life.

$$L_{10} := \left(\frac{C}{P} \right)^p \cdot \left(\frac{10^6}{60 \cdot N} \right)$$

L₁₀ = Rating Fatigue Life in Hours
C = Cataloged Basic Dynamic Load Capacity
P = Equivalent Applied Load to the Bearing
N = Rotating Speed in RPM
p = calculation exponent
 -use **3** for ball bearings
 -use ¹⁰/₃ for roller bearings

In addition to C values for each bearing we have Co values. Co values are calculated values to determine the static load which will permanently damaging the bearing.

Elastic Deformation

Now let's look under the surface and see how a ball interacts with the raceway under this same load. At the loaded point of contact we can see that the ball and raceway are actually deformed. However, the deformation incurred will not be permanent. This process where the bearing steel will return to its original form is called "elastic deformation".

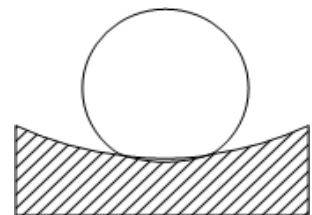

Exceeded Elastic Deformation

If a static or non-rotating load results in a contact stress that exceeds 580,000 psi, the elastic deformation limit is exceeded. The material surfaces yield and enters the "plastic deformation" zone. The deformation becomes a permanent dent called a "Brinell". The load which will permanently damage the bearing is the "Co" value. Both "C" and "Co" values are in the catalog.

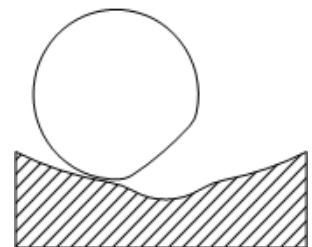

Bearing Selection

Subsurface Flaking

As the stress cycles increase and the fatigue limits are reached sub-surface fracturing begins. These fracture points are the origins of subsurface flaking.

The physical evidence of this subsurface flaking appear as a spall, which is a small fragment or chip removed from the raceway. This single spall will continue to grow in size similar to the way a pot-hole will develop in a road and continue to grow. Ultimately, spalling will end the life of a bearing. The quantification of this life ending process is called "rolling fatigue life." It is represented by the number revolutions endured.

The bearing may be operable for some time beyond this point, but will be noisier and eventually lock-up completely.

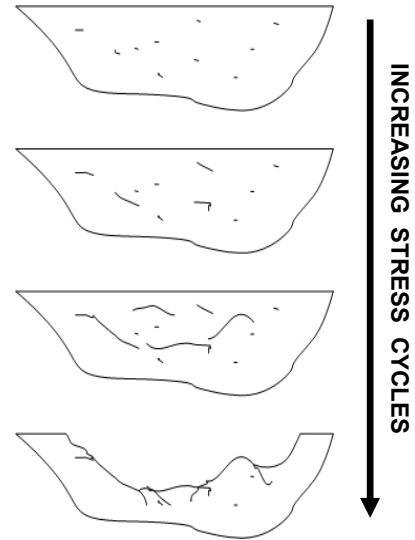

Bearing Life Calculations

This formula estimates the normal distribution of failures and locates a point on the normal distribution curve where 90% of the bearings will life longer than this estimate.

$$L_{10} = \left[\frac{C}{P} \right]^p \left[\frac{1000000}{60N} \right]$$

Life Calculation Example 1:

Shield Type : 6210ZZE	
Contact Seal Type : 6210-2NSE	
Non Contact Seal Type : 6210-2NKE	
Dynamic Load Rating Cr : 7,874 lbs	
Static Load Rating Cor : 5,219 lbs	
Radial Clearance : .00071 - .00142	
Radial Run-out Inner Ring : .00059	
Outer Ring : .00138	
Width Variation Inner Ring : .00079	
Outer Ring : .00079	
Limiting Speed	
Oil Lubrication : 8,600 rpm	
Grease Lubrication : 7,000	
Grease Lub. Contact Seal : 4,800	

UNIT : inch
Weight : 1.021 lbs

Bearing: 6210

Operating Load = 1,000 lbf
Operating Speed = 500 rpm

$$L_{10} = \left[\frac{C}{P} \right]^p \left[\frac{10}{60N} \right]^6$$

$$L_{10} = \left[\frac{7.874}{1000} \right]^3 \left[\frac{1000000}{60(500)} \right]$$

$$L_{10} = [7.874]^3 [33.33]$$

$$L_{10} = 16271 \text{ Hours}$$

Life Calculation Example 2:

Bearing: **6310**

Operating Load = 1,000 lbf
Operating Speed = 500 rpm

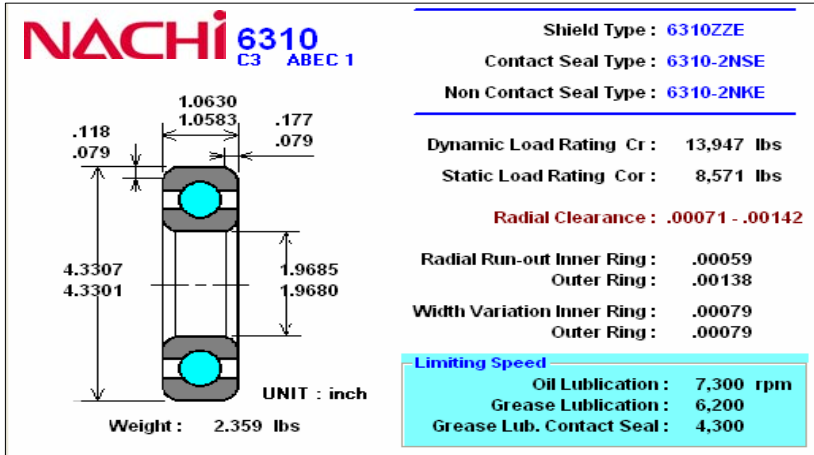

$$L_{10} = \left[\frac{C}{P} \right]^p \left[\frac{10}{60N} \right]^6$$

$$L_{10} = \left[\frac{13947}{1000} \right]^3 \left[\frac{1000000}{60 (500)} \right]$$

$$L_{10} = [13.947]^3 [33.33]$$

$$L_{10} = 72341 \text{ Hours}$$

Design Life Recommendations:

In order to determine what is acceptable life, the following guide is used by most manufactures when designing their equipment:

Class of Machine	L ₁₀ Hours of Service
Domestic Machines, Agricultural Machines, Instruments, Technical Apparatus, Or Medical Use	300 to 3,000
Machines Used For Short Periods Or Intermittently: Electric Hand Tools, Lifting Tackle In Workshops, Small Construction Machines	3,000 to 8,000
Machines Working Intermittently With High Reliability: Hoists, Workshop Cranes, Auxiliary Machinery In Power Stations, Domestic Refrigerating Appliances, And Infrequently Used Machine Tools	8,000 to 12,000
Machines Used 8 Hours Per Day, But Not Always Fully Utilized: General Purpose Gear Drives, Electric Motors	10,000 to 25,000
Machines Used 8 Hours Per Day And Fully Utilized: Machine Tools, Wood Processing Machinery, Machines For The Engineering Industry, Cranes For Bulk Materials, Ventilating Fans, Conveyors, Printing Equipment, Centerfuges	20,000 to 30,000
Machines For Continuous Use, 24 Hours Per Day: Rolling Mill Gear Drives, Compressors, Pumps Mine Hoists, Stationary Electric Machines, Textile Machinery	40,000 to 50,000
Water Works Machinery Rotary Furnaces, Cable Stranding Machines, Propulsion Machinery For Ocean-Going Vessels	60,000 to 100,000
Pulp And Papermaking Machinery, Large Electric Motors, Power Station Plants, Mine Pumps And Ventilating Fans	Greater than 100,000

Bearing Selection

Load Comparison:

Customers always want to know how much load will a bearing accept.

The answer to this question is complicated. To determine the load on the bearing the RPM and the expected life must be known. The first of the following two tables shows a comparison of Radial Ball Bearing's Radial Loading given the life requirement of 20,000 hours and 40,000 hours and speed requirement.

All of the bearings are grouped by bore size. This chart shows the smaller the bearing cross section the less load that bearing can accept. It also shows why the 6300 series bearing are called heavy duty.

The next two tables show similar comparisons. The table below is grouped by bore size and shows radial ball bearing loads for various rpm and life requirements. On the next page the table shows ball and roller bearing loads for the same rpm and life requirements.

Basic Bearing	Load Rating lbs	3 year life (20000 hrs.)				5 years life (40000 hrs.)			
		900 rpm	1200 rpm	1800 rpm	3600 rpm	900 rpm	1200 rpm	1800 rpm	3600 rpm
6805	967	94	86	75	59	75	68	59	47
6905	1574	153	139	122	97	122	111	97	77
16005	1563	152	138	121	96	121	110	96	76
6005	2271	221	201	176	139	176	160	139	111
6205	3147	307	279	243	193	243	221	193	153
6305	5306	517	470	410	326	410	373	326	259
6810	1439	140	127	111	88	111	101	88	70
6910	3260	318	289	252	200	252	229	200	159
16010	3620	353	321	280	222	280	254	222	176
6010	4901	478	434	379	301	379	344	301	239
6210	7869	767	697	609	483	609	553	483	383
6310	13939	1359	1234	1078	856	1078	980	856	679
6815	2810	274	249	217	173	217	198	173	137
6915	4676	456	414	362	287	362	329	287	228
16015	6205	605	549	480	381	480	436	381	302
6015	8880	866	786	687	545	687	624	545	433
6215	14838	1446	1314	1148	911	1148	1043	911	723
6315	25405	2476	2250	1965	1560	1965	1786	1560	1238
6820	4406	429	390	341	271	341	310	271	215
6920	9555	931	846	739	587	739	672	587	466
16020	8431	822	747	652	518	652	593	518	411
6020	13489	1315	1195	1044	828	1044	948	828	657
6220	27428	2673	2429	2122	1684	2122	1928	1684	1337
6320	38894	3791	3444	3009	2388	3009	2734	2388	1895
6830	10679	1041	946	826	656	826	751	656	520
6930	19222	1874	1702	1487	1180	1487	1351	1180	937
16030	17199	1676	1523	1330	1056	1330	1209	1056	838
6030	28327	2761	2509	2191	1739	2191	1991	1739	1380
6230	39568	3857	3504	3061	2430	3061	2781	2430	1928
6330	61601	6004	5455	4765	3782	4765	4330	3782	3002

Basic Bearing	Load Rating lbs	3 year life (20000 hrs.)				5 years life (40000 hrs.)			
		900 rpm	1200 rpm	1800 rpm	3600 rpm	900 rpm	1200 rpm	1800 rpm	3600 rpm
6205	3147	307	279	243	193	243	221	193	153
7205	2293	224	203	177	141	177	161	141	112
5205	4901	478	434	379	301	379	344	301	239
NU205	3979	490	449	398	323	398	365	323	262
NU205E	6587	810	743	658	535	658	604	535	434
E30205J	7082	871	799	708	575	708	649	575	467
22205EX	14164	1742	1598	1415	1150	1415	1298	1150	934
6210	7869	767	697	609	483	609	553	483	383
7210	7082	690	627	548	435	548	498	435	345
5210	12253	1194	1085	948	752	948	861	752	597
NU210	10791	1328	1218	1078	876	1078	989	876	711
NU210E	15513	1908	1751	1550	1259	1550	1422	1259	1023
E30210J	17199	2116	1941	1719	1396	1719	1576	1396	1134
22210EX	31924	3927	3603	3190	2591	3190	2926	2591	2105
6215	14838	1446	1314	1148	911	1148	1043	911	723
7215	15400	1501	1364	1191	946	1191	1082	946	751
5215	21583	2104	1911	1670	1325	1670	1517	1325	1052
NU215	21695	2669	2448	2168	1761	2168	1989	1761	1430
NU215E	29227	3595	3298	2920	2372	2920	2679	2372	1927
E30215J	31924	3927	3603	3190	2591	3190	2926	2591	2105
22215EX	59577	7329	6723	5953	4835	5953	5461	4835	3928
6220	27428	2673	2429	2122	1684	2122	1928	1684	1337
7220	28327	2761	2509	2191	1739	2191	1991	1739	1380
5220	37770	3681	3345	2922	2319	2922	2655	2319	1841
NU220	41142	5061	4643	4111	3339	4111	3771	3339	2712
NU220E	56205	6914	6343	5616	4562	5616	5152	4562	3705
E30220J	58004	7136	6546	5796	4708	5796	5317	4708	3824
22220EX	116906	14382	13193	11682	9488	11682	10716	9488	7707
6230	39568	3857	3504	3061	2430	3061	2781	2430	1928
7230	62950	6136	5574	4870	3865	4870	4424	3865	3068
NU230	84308	10371	9514	8424	6843	8424	7728	6843	5558
NU230E	101169	12446	11417	10109	8211	10109	9273	8211	6670
E30230J	104766	12888	11823	10469	8503	10469	9603	8503	6907
22230EX	269784	33189	30444	26958	21896	26958	24729	21896	17785

Equivalent Dynamic Load:

In the previous example, we mentioned “Equivalent Dynamic Load” Sometimes the load fluctuates and we must average it into a steady equivalent dynamic load, or sometimes we have both radial loads and thrust loads and we must combine them into an equivalent radial load to use in the life calculation. To obtain the equivalent dynamic load “P”, we combine the radial forces “Fr” with the axial forces “Fa” using loading factors. These factors are selected dependent upon their ratio relative to one another and the contact angle and internal geometry of the bearing. The formula to combine this is as follows:

$$P = X \cdot Fr + Y \cdot Fa$$

The selection of “X” and “Y” is usually more cumbersome than the life calculation itself. This has been greatly simplified through the use of bearing manufacturers electronic catalogs that are available on CD or their websites. These electronic versions automatically select the proper loading factors.

Bearing Selection

40° Angular Contact Ball Bearing Continuous Thrust loads (lbs.) Single Set

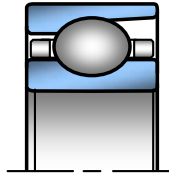

Basic Bearing	Load Rating lbs	1 year life (8760 hrs.)				2 years life (17520 hrs.)			
		900 rpm	1200 rpm	1800 rpm	3600 rpm	900 rpm	1200 rpm	1800 rpm	3600 rpm
7204	2990	673	612	534	424	534	486	424	337
7205	3147	709	644	562	446	562	511	446	354
7206	4362	982	892	779	619	779	708	619	491
7207	5755	1296	1177	1029	816	1029	934	816	648
7208	6879	1549	1407	1229	976	1229	1117	976	774
7209	7711	1736	1578	1378	1094	1378	1252	1094	868
7210	8026	1807	1642	1434	1138	1434	1303	1138	904
7211	9915	2232	2028	1772	1406	1772	1610	1406	1116
7212	12005	2703	2456	2145	1703	2145	1949	1703	1352
7213	13692	3083	2801	2447	1942	2447	2223	1942	1541
7214	14209	3199	2907	2539	2015	2539	2307	2015	1600
7215	16120	3630	3298	2881	2286	2881	2617	2286	1815
7216	17334	3903	3546	3098	2459	3098	2814	2459	1951
7217	20054	4515	4102	3584	2844	3584	3256	2844	2258
7218	22932	5163	4691	4098	3253	4098	3723	3253	2582
7219	24955	5619	5105	4460	3540	4460	4052	3540	2809
7220	27878	6277	5703	4982	3954	4982	4526	3954	3138
7221	30351	6834	6209	5424	4305	5424	4928	4305	3417
7222	33049	7441	6761	5906	4688	5906	5366	4688	3721
7224	35522	7998	7267	6348	5038	6348	5768	5038	3999
7226	39793	8960	8141	7111	5644	7111	6461	5644	4480
7228	44290	9972	9060	7915	6282	7915	7191	6282	4986
7230	50585	11390	10348	9040	7175	9040	8213	7175	5695
7303	3103	699	635	554	440	554	504	440	349
7304	3642	820	745	651	517	651	591	517	410
7305	5148	1159	1053	920	730	920	836	730	580
7306	6205	1397	1269	1109	880	1109	1008	880	699
7307	7307	1645	1495	1306	1036	1306	1186	1036	823
7308	8925	2010	1826	1595	1266	1595	1449	1266	1005
7309	11376	2561	2327	2033	1614	2033	1847	1614	1281
7310	14478	3260	2962	2587	2054	2587	2351	2054	1630
7311	16704	3761	3417	2985	2369	2985	2712	2369	1881
7312	19087	4298	3905	3411	2707	3411	3099	2707	2149
7313	21605	4865	4420	3861	3065	3861	3508	3065	2432
7314	24281	5467	4967	4339	3444	4339	3942	3444	2734
7315	26529	5973	5427	4741	3763	4741	4307	3763	2987
7316	28552	6429	5841	5103	4050	5103	4636	4050	3214
7317	30800	6935	6301	5504	4369	5504	5001	4369	3468
7318	33273	7492	6807	5946	4720	5946	5403	4720	3746
7319	35522	7998	7267	6348	5038	6348	5768	5038	3999
7320	37770	8504	7727	6750	5357	6750	6133	5357	4252
7321	42941	9669	8784	7674	6091	7674	6972	6091	4834
7322	47887	10782	9796	8558	6792	8558	7775	6792	5391

**40° Angular Contact Ball Bearing
ContinousThrust loads (lbs.)
Duplex Set**

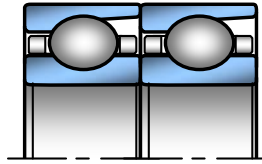

Basic Bearing	Load Rating lbs	1 year life (8760 hrs.)				2 years life (17520 hrs.)			
		900 rpm	1200 rpm	1800 rpm	3600 rpm	900 rpm	1200 rpm	1800 rpm	3600 rpm
7204	4857	1094	994	868	689	868	789	689	547
7205	5113	1151	1046	914	725	914	830	725	576
7206	7085	1595	1449	1266	1005	1266	1150	1005	798
7207	9350	2105	1913	1671	1326	1671	1518	1326	1053
7208	11176	2516	2286	1997	1585	1997	1815	1585	1258
7209	12527	2821	2563	2239	1777	2239	2034	1777	1410
7210	13038	2936	2667	2330	1849	2330	2117	1849	1468
7211	16106	3626	3295	2878	2285	2878	2615	2285	1813
7212	19503	4391	3990	3485	2766	3485	3167	2766	2196
7213	22242	5008	4550	3975	3155	3975	3611	3155	2504
7214	23082	5197	4722	4125	3274	4125	3748	3274	2599
7215	26186	5896	5357	4680	3714	4680	4252	3714	2948
7216	28159	6340	5760	5032	3994	5032	4572	3994	3170
7217	32578	7335	6664	5822	4621	5822	5290	4621	3668
7218	37253	8388	7621	6657	5284	6657	6049	5284	4194
7219	40540	9128	8293	7245	5750	7245	6582	5750	4564
7220	45287	10197	9265	8093	6424	8093	7353	6424	5098
7221	49305	11102	10086	8811	6994	8811	8006	6994	5551
7222	53688	12088	10983	9595	7615	9595	8717	7615	6044
7224	57705	12993	11805	10312	8185	10312	9369	8185	6496
7226	64644	14555	13224	11553	9169	11553	10496	9169	7278
7228	71949	16200	14719	12858	10205	12858	11682	10205	8100
7230	82175	18503	16811	14685	11656	14685	13343	11656	9251
7303	5040	1135	1031	901	715	901	818	715	567
7304	5917	1332	1210	1057	839	1057	961	839	666
7305	8364	1883	1711	1495	1186	1495	1358	1186	942
7306	10080	2270	2062	1801	1430	1801	1637	1430	1135
7307	11870	2673	2428	2121	1684	2121	1927	1684	1336
7308	14499	3265	2966	2591	2057	2591	2354	2057	1632
7309	18480	4161	3781	3303	2621	3303	3001	2621	2081
7310	23520	5296	4812	4203	3336	4203	3819	3336	2648
7311	27136	6110	5551	4849	3849	4849	4406	3849	3055
7312	31007	6982	6343	5541	4398	5541	5035	4398	3491
7313	35098	7903	7180	6272	4978	6272	5699	4978	3951
7314	39444	8881	8069	7049	5595	7049	6404	5595	4441
7315	43096	9704	8816	7702	6113	7702	6997	6113	4852
7316	46383	10444	9489	8289	6579	8289	7531	6579	5222
7317	50035	11266	10236	8942	7097	8942	8124	7097	5633
7318	54053	12171	11058	9660	7667	9660	8776	7667	6085
7319	57705	12993	11805	10312	8185	10312	9369	8185	6496
7320	61357	13815	12552	10965	8703	10965	9963	8703	6908
7321	69757	15707	14270	12466	9895	12466	11326	9895	7853
7322	77792	17516	15914	13902	11034	13902	12631	11034	8758

Machine Tool Bearing

Super precision bearings are bearings with ISO class 5 or higher tolerance.

The tolerance of bearings, dimensional and running accuracy, is classified into five classes by the International Standardization Organization and other standards as shown in the table below

	Precision Bearings		Super Precision Bearings			Note
ISO 492	Normal	Class 6	Class 5	Class 4	Class 2	International
JIS B 1514	Class 0	Class 6	Class 5	Class 4	Class 2	Japanese
ANSI / ABMA 20	ABEC 1	ABEC 3	ABEC 5	ABEC 7	ABEC 9	American
	RBEC 1	RBEC 3	RBEC 5	-	-	American
DIN 620	0	P6	P5	P4	P2	German

NACHI Super Precision Angular Contact Ball Bearings

CY Series (15° contact angle)

7000CY ~ 7020CY
7200CY ~ 7220CY

ACY Series (25° contact angle)

Nylon or Phenolic cage
Ceramic optional

BNH Series (High Speed Type)

BNH907C ~ BNH932C
BNH007C ~ BNH032C

Ceramic optional
7000 series boundary dimensions

TAB Series (Ball Screw Support Bearings)

15TAB04 ~ 60TAB12

Seals optional

Contact angle

The contact angle is the angle formed by a line drawn between the points of contact of the balls with the raceways and a plane perpendicular to the bearing axis.

The contact angle influences the axial and radial characteristics of a bearing.

"C" = contact angle bearings are 15°

"AC" = contact angle bearings are 25°

"B" = contact angle bearings are 40°

Contact angles of TAB bearings have 60°

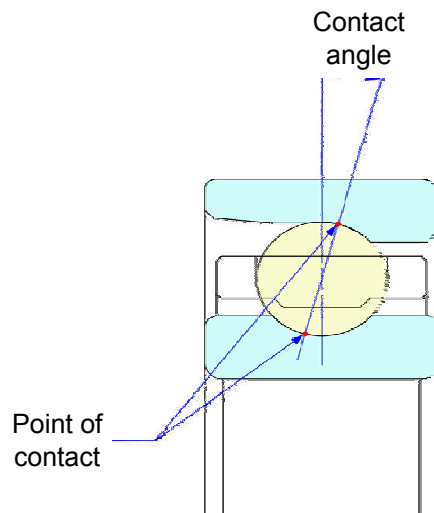

The bearings are not interchangeable.

"C" → contact angle is used for high speed and light load applications.

"B" → contact angle is used for lower speeds and heavy axial load applications.

The following may occur when using a "C" contact angle instead of a "B" contact angle.

- Poor Rigidity in Axial Direction
- High Operating Temperature
- Short Service Life

Angular contact bearings have two sides

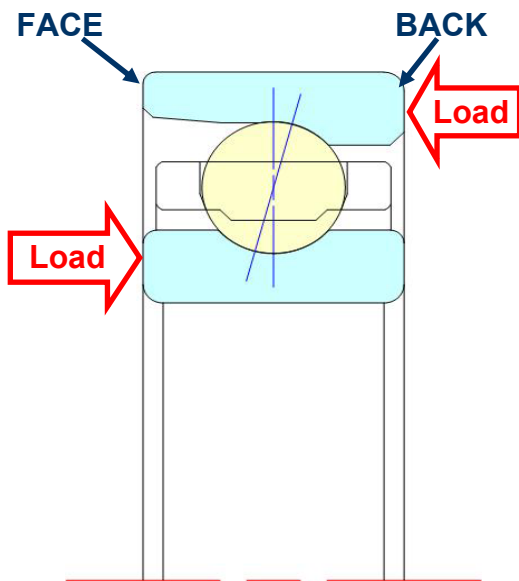

Back

The outer ring face is the key. The thick face of the outer ring is the Back side.

The thick face is the side receiving the load.

Face

The outer ring face is the Key. The thin face of the outer ring is the Face side.

The face side is at times called the front side.

Counter bore

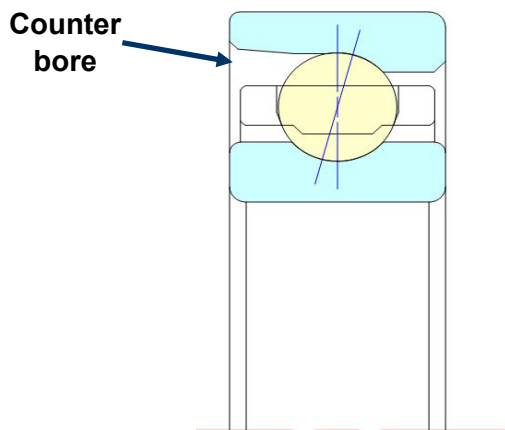

Counter Bore:

Removing the shoulder side of the ring of a ball bearing with a chamfer.

Appearance indicates an angular ball bearing not a radial ball bearing.

Permits better lubrication flow.

Ring is no longer a symmetrical part.

Machine Tool Bearing

These are the suffixes for the bearing arrangements.

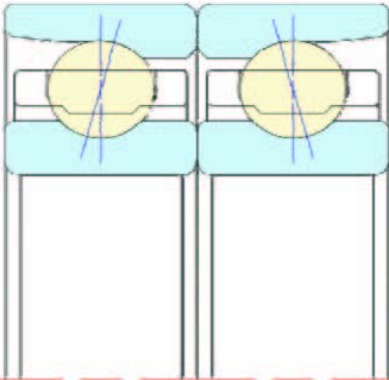

Back-to-back mounting

In this arrangement the contact angles diverge so that the effective distance between bearing center is increased. Axial and radial loads can be used in any direction. This arrangement accommodates radial stiffness and resistance to moment loads.

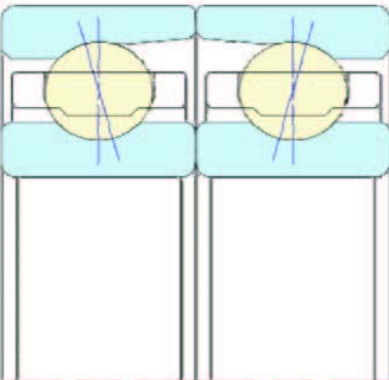

Face-to-face mounting

In this arrangement the contact angles converge so that the effective distance between bearing centers is decreased. Axial and radial loads can be used in any direction. This arrangement has less radial stiffness and is generally used where precise alignment cannot be achieved.

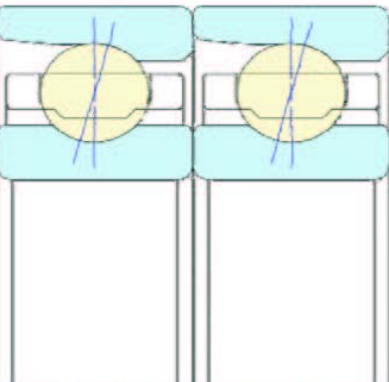

Tandem mounting

In this arrangement the contact angles are parallel. Axial loads are shared but can be applied in only one direction. Must be opposed by another bearing, or set of bearings, to accommodate the axial load in the reverse direction.

Configured bearings can only be used in one arrangement.

For DB bearings, the preload is only controlled on the "Back" side of the bearings.
For DF bearings, the preload is only controlled on the "Face" side of the bearings.
If a DF arrangement is made from DB set, we can not expect the correct preload.

"DU" is the suffix for a duplex universal combination bearing set. We call these universal bearings "Flush Ground Bearings".

For DU bearings, the preload gap (width dimension) of both the "Face" and "Back" sides is controlled to get a proper preload. Any arrangement, DB, DF, DT or other multi-combinations, can be arranged.

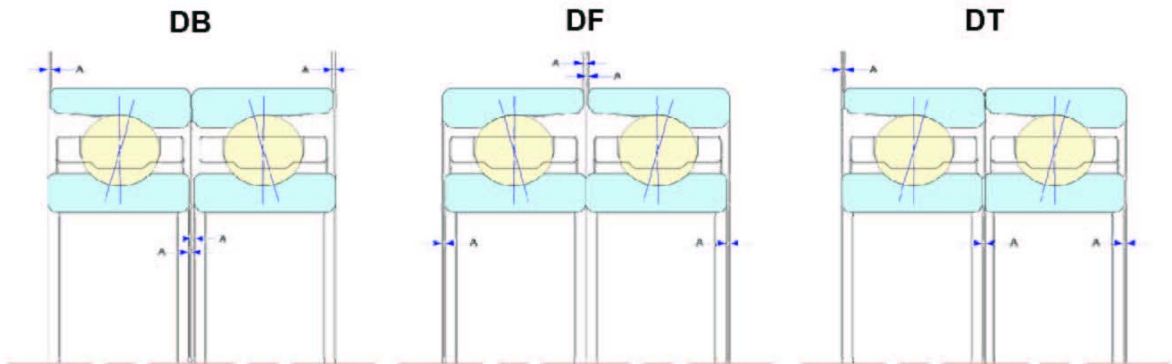

These sets of two bearings have been selected as matched pairs at the factory. One DU set of bearings has only a small dimensional variation (2 μm maximum) on the bore diameter and OD of the two bearings. The Dimensions are shown on the inspection sheet in the box and on the side of the box. Each bearing is serialized.

To make triplex and quadruplex combinations, DU sets with similar Bore and OD dimensions should be selected. The selected sets should have no more than 2 μm (0.002mm) variation between the bearings on bore size and OD size. This practice insure the preload will be correct.

Each manufacturer has their own suffixes for Triplex and Quad arrangements. Common suffixes are shown below.

Angle	NACHI	SKF	NSK	NTN	RHP	KOYO	BARDEN
/\	FFB	TBT	DBD	DBT	2TB	DBD	DBT
\/\	BFF	TFT	DFD	DFT	2TF	DFD	(DFT)
///	FFF	TT	DTD	DTT	3T	DTD	
///\	FFFB	QBT	DBT	DBTT	3TB		DBD
/\/\	FFBB	QBC	DBB	DTBT	2TB2T (QB)	DBB	DBTT
\/\/\	BBFF	QFC	DFB	DIFT	2TF2T (QF)	(DFB)	(DFTT)
///\	BFFF	QFT	DFT	DFTT	3TF		(DFD)
////	FFFF	QT	DTT	DTTT	4T		

Most manufacturer have the same nomenclature for DU, DB, DF and DT.

Machine Tool Bearing

Preload means to apply a permanent axial load to a bearing
All of the internal bearing clearance is removed.

Preloading achieves a number of objectives:

- Elimination of free radial and axial movement
- Reduced deflection from externally applied loads

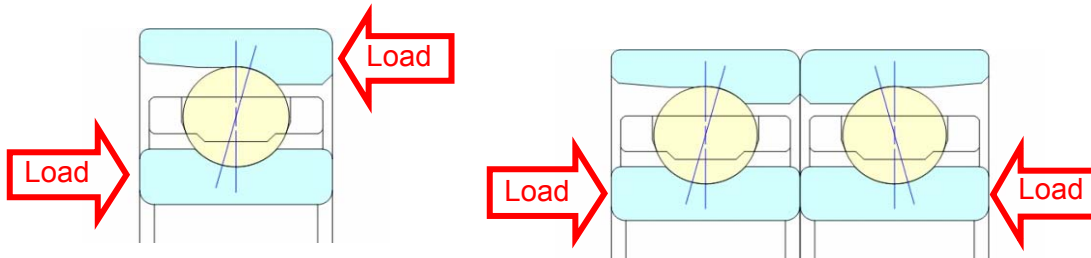

Single row angular contact bearings can only be loaded in one direction.
If the bearing is loaded in the wrong direction away from the back face the bearing:

- Disassemble
- Have high operating noise
- Fail quickly

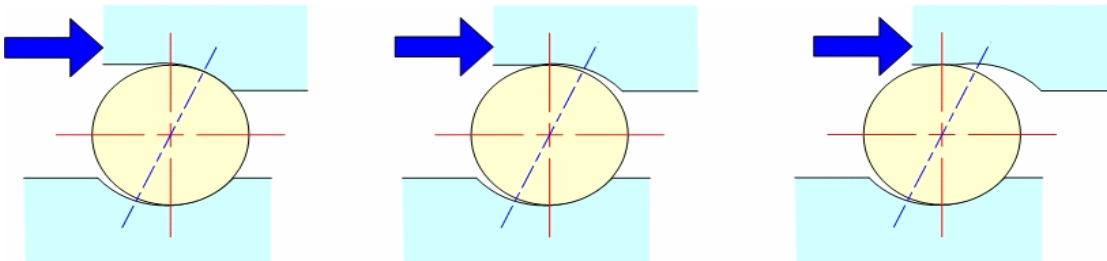

On "DB" arrangements the inner ring must be clamped to preload the bearings.

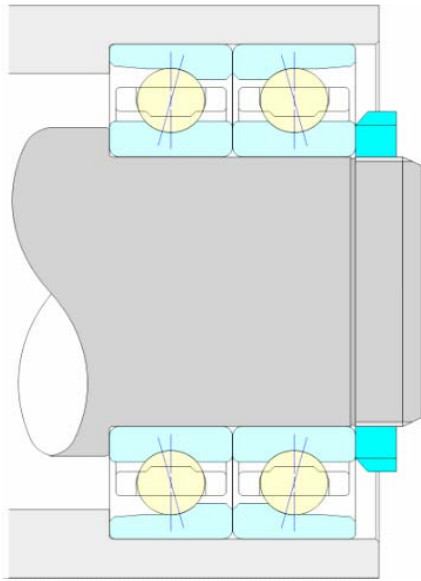

On "DF" arrangements a housing cover preloads the bearings.

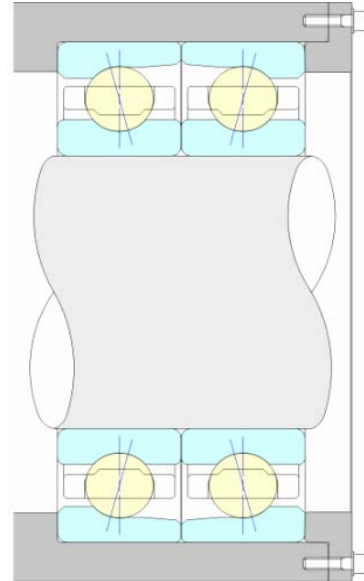

Bearing Bore (mm)	Clamping Force			
	7000		7200	
	N	lbs	N	lbs
10	550	124	600	135
12	770	173	830	187
15	770	173	830	187
17	860	194	1100	248
20	1000	225	1200	270
25	1300	293	1400	315
30	1400	315	2200	495
35	1600	360	3100	698
40	1800	405	2800	630
45	2000	450	3600	810
50	2200	495	3800	855
55	2700	608	4000	900
60	2900	653	4400	990
65	3100	698	6000	1350
70	3300	743	5700	1283
75	3500	788	6100	1373
80	5100	1148	5600	1260
85	5400	1215	8200	1845
90	8700	1958	10000	2250
95	7600	1710	12000	2700
100	7900	1778	11000	2475
110	8100	1823	13000	2925
120	8600	1935	16000	3600

Machine Tool Bearing

NACHI has four kinds of preload as shown in the table below.

E = extra light

L = light (std)

M = medium

H = heavy

Units : Newtons / lbs

7000 Preload				Bore Number	7200 Preload			
E	L	M	H		E	L	M	H
20	50	100	145	00	30	70	145	195
5	11	23	33	01	7	16	33	44
			295	02				
			66	03				
50	100	195	295	04	70	145	295	490
11	23	44	390	05	16	33	66	110
			88	06				590
70	145	295	590	07	100	195	490	133
16	33	66	133	08	23	44	110	785
				09				177
				10				
100	195	390	785	11	145	295	590	980
23	44	88	177	12	33	66	133	221
				13				
145	295	590	1170	14	195	390	785	1470
33	66	133	263	15	44	88	177	331
				16				
195	390	785	1470	17	295	490	980	1960
44	88	177	331	18	66	110	221	441
				19				
				20				

Small Ball Series		
Brg. No	Light Preload	
	N	lbs
BNH007	78.5	18
BNH008	98.1	22
BNH009	98.1	22
BNH010	98.1	22
BNH011	147	33
BNH012	147	33
BNH013	147	33
BNH014	245	55
BNH015	245	55
BNH016	294	66
BNH017	294	66
BNH018	392	88
BNH019	392	88
BNH020	392	88

Ball Screw Support Bearings		
Brg. No	M Preload	
	N	lbs
15TAB04	2,160	486
17TAB04	2,160	486
20TAB04	2,160	486
25TAB06	3,330	749
30TAB06	3,330	749
35TAB07	3,920	882
40TAB07	3,920	882
40TAB09	5,200	1,170
45TAB07	4,120	927
45TAB10	5,980	1,346
50TAB10	6,280	1,413
55TAB10	6,280	1,413
55TAB12	7,060	1,589
60TAB12	7,060	1,589

Preloads are similar for all Manufactures but not identical.

Manufacturing Comparison of Preload of Duplex Pair

			7006C		7012C		7018C	
			N	lbs	N	lbs	N	lbs
Extra Light	NACHI	E	50	11	100	23	200	45
	NSK	C2	20	5	55	12	120	27
	NTN	GL	30	7	100	23	150	34
	KOYO	S	25	6	65	15	140	32
	FAG	-	-	-	-	-	-	-
Light	NACHI	L	100	23	200	45	390	88
	NSK	C7	100	23	275	62	640	144
	NTN	GN	80	18	200	45	390	88
	KOYO	L	80	18	200	45	440	99
	FAG	UL	95	21	235	53	470	106
Medium	NACHI	M	200	45	390	88	785	177
	NSK	C8	210	47	590	133	1325	298
	NTN	GM	150	34	490	110	890	200
	KOYO	M	200	45	490	110	980	221
	FAG	UM	300	68	700	158	1422	320
Heavy	NACHI	H	390	88	785	177	1475	332
	NSK	C9	390	88	1225	276	2750	619
	NTN	GH	300	68	980	221	1960	441
	KOYO	H	390	88	980	221	1960	441
	FAG	US	580	131	1350	304	2940	662

"M preload" can be used in place of "L preload" but remember

- Higher preload makes the spindle more ridged.
- Spindle Rotating Torque would increase
- Spindle would have Higher Operating Temperature

Variation in preloads may work or they may not depending the customer expectation and usage of the equipment.

Machine Tool Bearing

Bearing Speed Limits

Speed Limits should be regarded as a guide rather than an absolute figure, as the maximum speed can be affected by a variety of circumstances. Speed Limits apply when the bearings are operating under normal temperature conditions, are adequately protected from contamination and for applications with inner ring rotation. The speeds quoted for oil lubrication assume that minimum lubrication is used, and for grease supply of a good quality grease is used

High speed operation means operation at speeds more than 75% of the limiting speed. In case of high speed operation, more careful selection of grease and determination of amount of grease are required.

Each series has a dN value. d is the bore size in mm, N is the spindle speed rpm. Multiplying these two numbers together produces a relative speed value which can be used on a bearing series regardless of bearing size.

dN Values

Unit : 1000(mm X rpm)

Bearing Type	Contact Angle	Grease Lubricate.		Oil Lubricate.		Oil Mist	
		Single	Duplex	Single	Duplex	Single	Duplex
7200	C (15°)	550	450	800	625		
7000	C (15°)	600	500	850	650	1,000	
BNH	C (15°)	925		1,300		1,600	
Ceramic	C (15°)	1,100		1,600		2,000	
7200	B (40°)	280	225	375	300		
TAB	(60°)	130					
NN3000		400		500			

Note: Spindle applications are normally lightly loaded < 6 % C

Nachi's "BNH series" has the boundary dimensions of a 7000 series and uses a smaller ball. The small ball design enable the bearing to be used at higher speeds than the 7000. The BNH will produce a stiffer spindle with less load capacity.

Machine Tool bearings with Ceramic balls also can operate at higher speeds with similar load capabilities as the 7000 steel ball design.

Master Grease Amount Chart

units: cm³ & grams

Bore (mm)	7000C		7200C		BNH		NN3000		TAB	
	cm ³	grams	cm ³	grams	cm ³	grams	cm ³	grams	cm ³	grams
10	0.14	0.12	0.18	0.16						
12	0.15	0.14	0.26	0.23						
15	0.21	0.19	0.33	0.30					1.71	1.51
17	0.26	0.23	0.45	0.41					1.71	1.51
20	0.44	0.39	0.71	0.63					1.71	1.51
25	0.51	0.46	0.80	0.72			0.45	0.41	2.16	1.94
30	0.72	0.65	1.23	1.11			0.89	0.80	2.16	1.94
35	0.96	0.86	1.55	1.39	0.84	0.76	1.13	1.01	2.61	2.35
40	1.17	1.05	1.95	1.76	1.08	0.97	1.43	1.28	2.61	2.35
45	1.53	1.38	2.31	2.08	1.35	1.22	1.92	1.73	2.95	2.63
50	1.61	1.44	2.79	2.51	1.46	1.31	2.07	1.86	6.75	6.08
55	2.39	2.15	3.89	3.50	2.10	1.89	2.94	2.65	8.00	7.20
60	2.55	2.30	4.98	4.48	2.25	2.03	3.11	2.79	8.55	7.70
65	2.73	2.46	5.87	5.28	2.40	2.16	3.27	2.94		
70	4.16	3.74	6.78	6.10	3.30	2.97	4.56	4.10		
75	4.31	3.87	7.41	6.67	3.45	3.11	4.94	4.44		
80	4.82	4.33	8.85	7.97	4.50	4.05	6.95	6.25		
85	5.45	4.90	11.0	9.92	4.65	4.19	7.17	6.45		
90	7.38	6.64	14.0	12.57	6.00	5.40	9.44	8.49		
95	7.95	7.16	17.5	15.77	6.30	5.67	9.68	8.71		
100	8.27	7.44	20.3	18.27	6.45	5.81	10.1	9.09		
105	11.0	9.86	23.9	21.49	8.10	7.29	13.8	12.39		
110	13.8	12.41	26.7	24.07	9.90	8.91	17.1	15.42		
120	14.3	12.84	31.4	28.26	10.7	9.59	19.0	17.06		
130	20.9	18.81	36.9	33.25	16.2	14.58	26.6	23.96		
140	22.2	19.99			17.1	15.39	29.3	26.35		
150	27.2	24.49			20.7	18.63	35.2	31.68		
160	33.7	30.36			26.1	23.49	43.2	38.92		
170	45.3	40.76			34.1	30.65	56.1	50.48		
180	54.3	48.84					76.2	68.55		
190	60.8	54.68					79.5	71.56		
200	43.8	39.42					103	92.27		

Conversion: 1 cm³ = 0.9 grams (specific weight of grease 0.9 grams per cc.)

Common Machine Tool Greases

Manufacturer	Grease
Kluber	NBU15
Kluber	LDS18
Kyodo Yushi	Multemp PS2

Nachi recommends a 15% grease fill

Machine Tool Bearing

Shaft & Housing Tolerance and Fitting Practice

Shaft	Shaft OD		Shaft Fit	Tolerance		Actual Fit (µm)	Target Fit (µm)
	(mm) over	(mm) incl.		Brg. Bore (µm)	Shaft Seat (µm)		
Angular Contact	10	18	h3	0 - 4	0 - 4	4L-4T	0 - 2T
	18	30	h3	0 - 5	0 - 4	4L-5T	0 - 2.5T
	30	50	h3	0 - 6	0 - 5	5L-6T	0 - 2.5T
Ball Bearings	50	80	h3	0 - 7	+2 - 4	4L-9T	0 - 3T
	80	120	js3	0 - 8	+3 - 5	5L-11T	0 - 4T
	120	180	js3	0 - 10	+4 - 6	6L-16T	0 - 5T
	180	250	js3	0 - 12	+5 - 7	7L-17T	0 - 6T
Ball Screw Support Bearings	10	18	h5	0 - 4	0 - 8	8L-4T	5L - 0
	18	30	h5	0 - 5	0 - 9	9L-5T	5L - 0
	30	50	h5	0 - 6	0 - 11	11L-6T	5L - 0
	50	80	h5	0 - 7	0 - 13	13L-7T	5L - 0

Housing Fixed End	Housing Bore		Hgs. Fit	Tolerance		Actual Fit (µm)	Target Fit (µm)
	(mm) over	(mm) incl.		Brg. OD (µm)	Housing Bore (µm)		
Cylindrical	All sizes		K5	0 - 8	+2 - 13	10L-13T	0 - 5T
Angular Contact Ball Bearings	18	50	JS3	0 - 6	+6 - 1	12L-1T	3L - 0
	50	120	JS3	0 - 8	+7 - 1	15L-1T	4L - 0
	120	180	JS3	0 - 10	+8 - 2	18L-2T	5L - 0
	180	250	JS3	0 - 11	+9 - 3	20L-3T	6L - 0
Ball Screw Brg.	All sizes		H6	0 - 6	0 - 21	27L-0T	8L - 3L

Housing Free End	Housing Bore		Hgs. Fit	Tolerance		Actual Fit	Target Fit
	(mm) over	(mm) incl.		Brg. OD (µm)	Housing Bore (µm)		
Cylindrical	All sizes		K5	0 - 8	+2 - 13	10L-13T	0 - 5T
Angular Contact Ball Bearings	18	50	H3	0 - 6	+7 - 0	13L-0T	10L - 6L
	50	120	H3	0 - 8	+8 - 0	16L-0T	13L - 8L
	120	180	H3	0 - 10	+10 - 0	20L-0T	18L - 12L
	180	250	H3	0 - 11	+12 - 0	23L-0T	22L - 15L
Ball Screw Brg.	All sizes		H6	0 - 6	0 - 21	27L-0T	8L - 3L

L = loose or slip fit
T = tight or interference fit

Using spacers between bearings is a common practice

Increasing the space between bearings produces a mechanical advantage.

- Reduces the equivalent radial load applied to the bearings.
- Higher moment load capabilities.
- Space out bearings for better heat transfer.

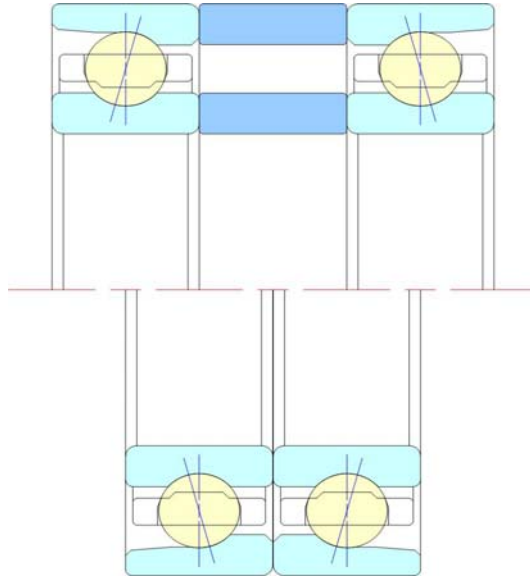

Bearings at free end are cylindrical roller bearings or bearings which are not fixed in the axial direction. Angular contact ball bearings at free end have loose fit and no shoulder on the housing or shaft. Therefore, they can move in the axial direction and they do not carry axial load. The free end is also the expansion end.

Spindles with a free end can absorb length change of spindle due to temperature (Thermal Expansion of shaft) or dimensional difference between the shaft and the housing.

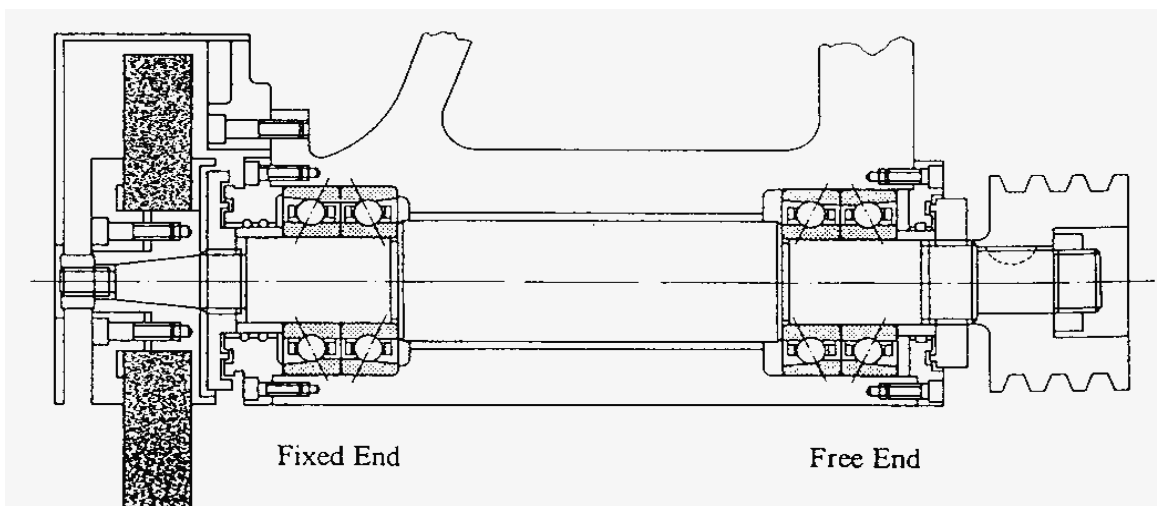

Bearings for Vibrating Applications

Spherical Roller Bearing Design & Configuration

Hardened stamped steel cages on our EX design provides a great selection for applications with heavy vibration.

Extreme contaminated lubrication application are normally huge problems for bearings. Nachi has had great success on these applications by using heat treated steel cages.

Nachi has our own steel plant and our expertise in steel making has transferred to all of our products like Bearing, Drills, Broaches, Heat Treatment equipment and tool steels.

[cage view]



EX-V Series Features

HIGHEST LOAD CAPACITY Nachi's basic EX spherical roller bearing design maintains the highest load capacities by utilizing the biggest rollers (longest length, largest diameter).

HARDENED CAGE Hardening steel cage increase the strength making the cage more fatigue resistant Nachi has been a leader in the main support bearing on the high speed trains in Japan. We have developed testing procedures which separate great products from good products. As shown by the test results we have a great design.

LOWER OPERATING TEMPERATURE In addition to increased strength, our hardened steel cage has a lower coefficient of friction which generates less heat and promotes lower operating temperatures. Lower operating temperature will result in longer grease life.

EX-V DESIGN Nachi vibrating screen bearings have "P5" bore tolerance and "P6" OD tolerance. Increased internal clearance low side C4 insures the bearings will have enough radial clearance when operating.

Vibration Test

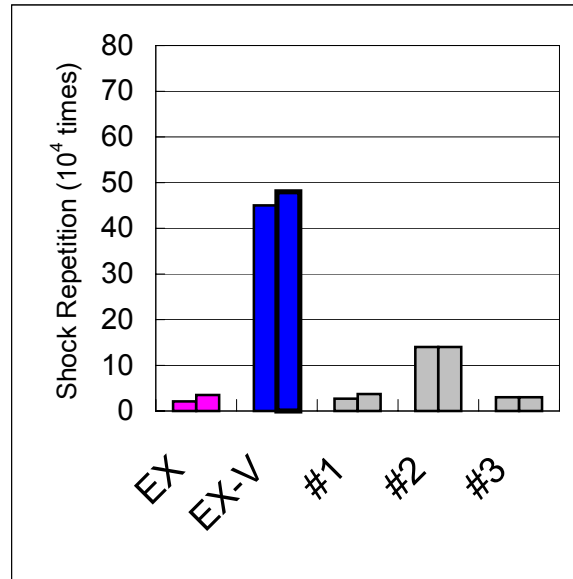
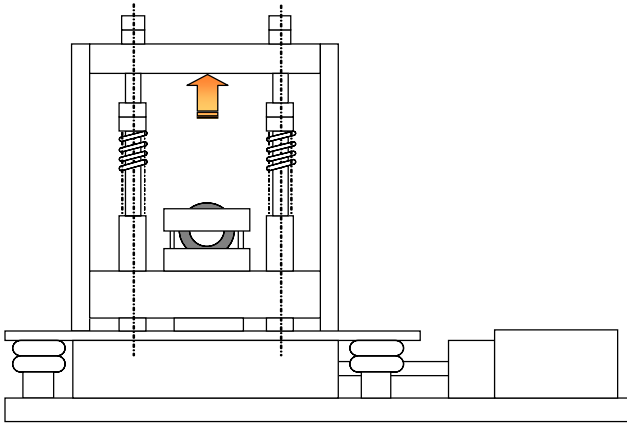

Test conditions

Vibrating cycles : 119 cpm
 Vibrating acceleration : 200 G
 Temperature : ambient

EX	Nachi
EXV	Nachi
#1	VA405
#2	HPS
#3	E1-T41A

Speed / Temperature Test

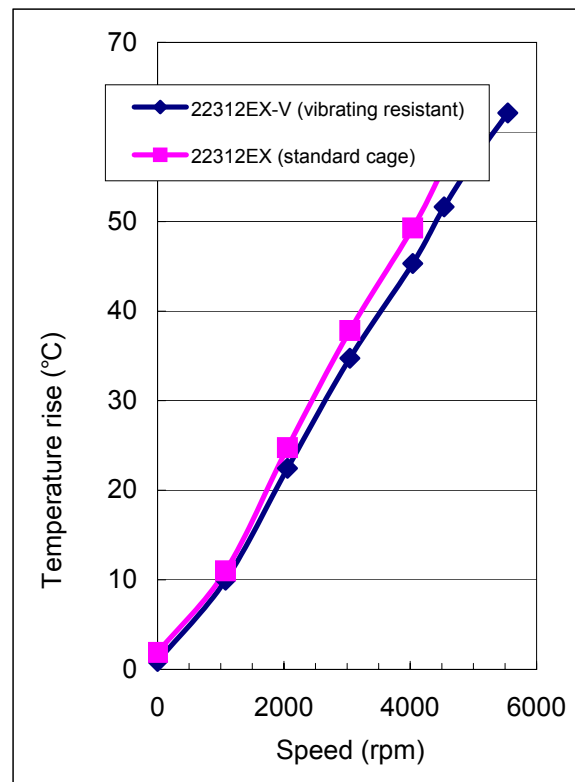
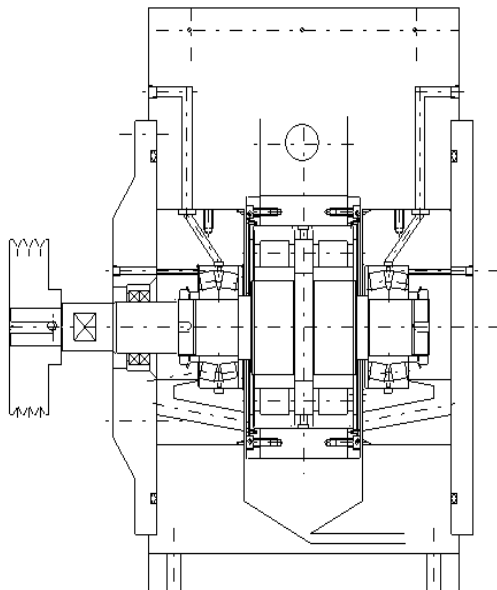

Most Frequent Causes of Bearing Failures

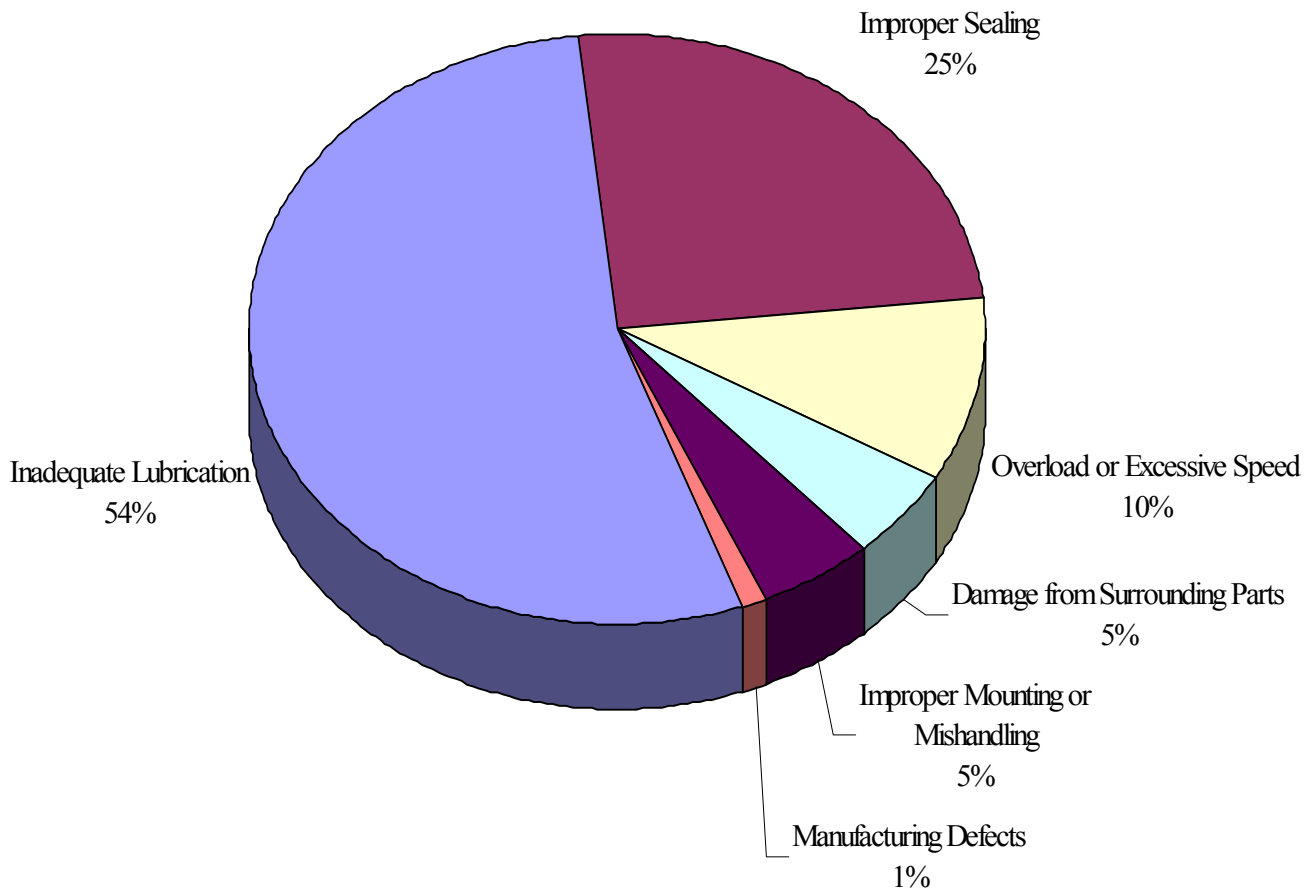

The majority of premature bearing failures are caused by inadequate lubrication. Anti-friction rolling element bearings are designed to have a thin film of oil between the rolling elements and the raceway surfaces. When this film degrades or gets too thin the rolling elements contact the raceway surfaces and wear develops. Anti-friction bearings are not designed to wear when bearing wear bearings wear out.

These are many causes for Inadequate lubrication:

1. Insufficient amount of grease (lubricant) or an excessive amount of grease.
2. Using a lubricant with the wrong characteristics, or mixing of greases (lubricants).
3. Moisture or hard particle contamination from the operating environment. Contamination can degrade, wear the bearing surfaces or degrade the oil film which will also cause wear.
4. Excessive operating temperature from the environment or from the operating speed of the bearing. The faster a bearing operates the higher the temperature. Bearing and lubricants have temperature limits and speed limits.

Investigating bearing failure typically involves reviewing the application. The bearing raceways tend to leave the best clues as to what may have caused the bearing failure. First the bearings will have to be disassembled to view the ring raceways. Since the most common cause for bearing failure is inadequate lubrication we will use the chrematistic to determine bearing failure. Frosting patterns on the inner ring and outer ring raceways is the first indication of inadequate lubrication. The raceway surfaces are starting to have contact with the rolling elements and these slight wear pattern development.

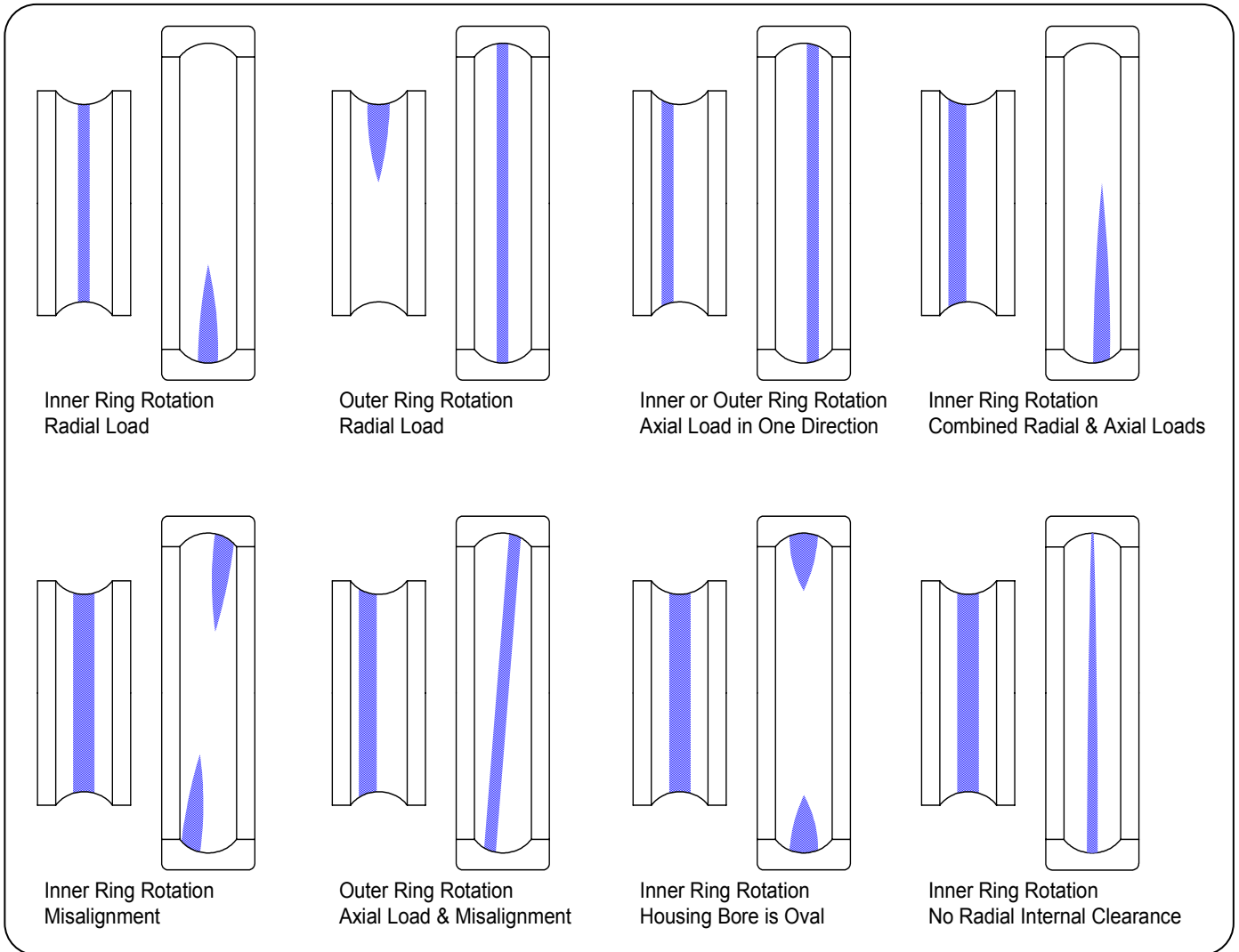

Bearings are like fuses, something causes the bearing to fail. We use these visual wear patterns to determine if the application is normal or if something is abnormal. By shining a bright light (Mag flashlight) down the raceway these patterns pop out and become more visible.

The most common application is the inner ring rotation with a radial load (upper left). By looking at the frosting patterns we can determine if the application is consistent or if something in the application is affecting the bearing. Orientation is always an important part of the investigation. Knowing which side of the bearing was positioned in or out will help in determining which way the bearing was loaded.

Seizure: Bearing seized up from excessive heat. Discoloration, softening and fusion of raceway and rolling element.

Causes: Poor lubrication, excessive load, excessive, clearance too small, entrance of contaminants, poor precision of the shaft or housing

Countermeasures: Reconfirm bearing selection, review lubricant selection type & quantity, check shaft & housing, improve sealing mechanism



Flaking: Repetitive Heavy stress cycle between the bearing raceways and rolling elements resulting in surface fatigue cracks and spalls

Causes: Excessive load, poor mounting, excessive moment load, entry of contamination, improper bearing clearance, improper shaft & housing precision

Countermeasures: Reconfirm the bearing application & load conditions, improve mounting method, improve sealing mechanism, use proper lubricant, check shaft & housing



Cracks: Splits and cracks in the inner ring, outer ring or rolling element.

Causes: Excessive interference fit, impact load, progression of flaking, shaft corner larger than bearing, heat generation & fretting problem

Countermeasures: Check fits, check shaft & housing, review the load conditions, make shaft corner smaller than that of the bearing



Fracture: Cracked inner ring rib. Broken retainer.

Causes: Excessive impact load during handling or mounting, heavy shock load or vibration

Countermeasures: Review handling, check mounting practice
re-check load conditions & bearing selection



True Brinelling: The occurrence of dents on the raceways that are the result of exceeding the elastic limit of the steel.

Causes: Any static overload, severe impact

Countermeasures: Install bearings by applying force only to the ring being press fitted, recheck static load conditions do not exceed bearing capacity



False Brinelling: The occurrence of elliptical wear at ball or roller spacing due to an excessive external vibration

Causes: Small relative motion between the rolling elements & raceways in a non-rotating bearing, stand by equipment, or shipping damage.

Countermeasures: Isolate bearing from external vibration, secure shaft & housing during shipping, reduce vibration by preloading bearings.

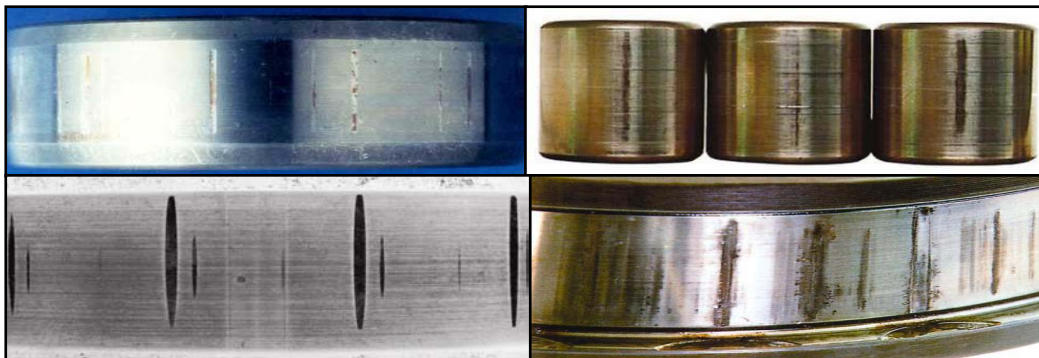

Fretting : It is the wear and oxidation due to repetitive sliding between two steel surfaces of non rotating components.

This can occur between mating components or between rolling elements and raceways. This can develop into false brinelling.

Causes: Improper shaft & housing fits, vibration with a small amplitude

Countermeasures: Check shaft & housing dimensions to ensure they are within recommended tolerances, Preload or load bearing, use an oil or grease in bearings when exposed to vibration

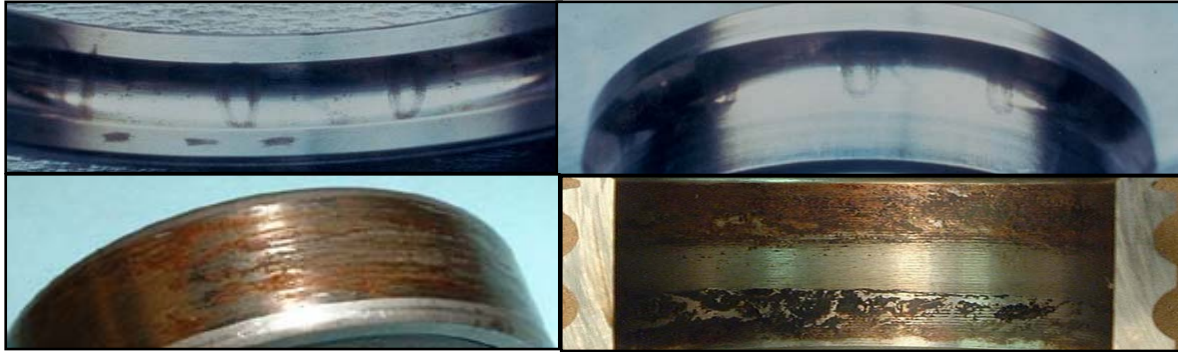

Smearing : Metal to metal contact due to the destruction of oil film. Sliding between outer ring, inner ring and rolling element.

Causes: Improper lubricant selection, rapid acceleration or deceleration, water intrusion

Countermeasures: Use a proper lubricant, review preload/clearance conditions, improve sealing mechanism

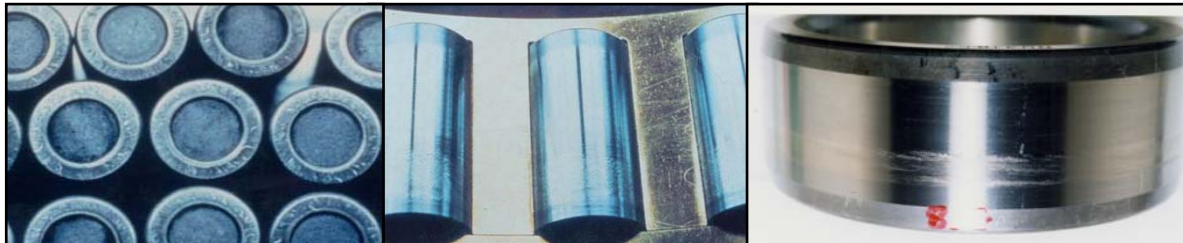

Excessive Wear : Surface deterioration due to heavy sliding friction between the contact areas of the bearing components

Causes: Poor lubrication, entry of contamination particles, progression from corrosion

Countermeasures: Use proper type and amount of lubricant, improve sealing mechanism, clean shaft & housing before mounting



Rusting, Corrosion : Rusting and corrosion is oxidation of the steel. Can cause pits on the surface of the rings & rolling elements

Causes: Ingress of water or corrosive fluid or gas, condensation of moisture in the air, poor packing/storage conditions handling with bare hands.

Countermeasures: Improper sealing mechanism, improve storage & handling implement measures for preventing rust during long periods of non-operation



Creep : Galling, wear, sliding and discoloration of fit face.

Causes: Improper shaft & housing sizes, thermal expansion of the shaft & housing material

Countermeasures: Bring shaft or housings back to recommended tolerances, improve accuracy of shaft & housing

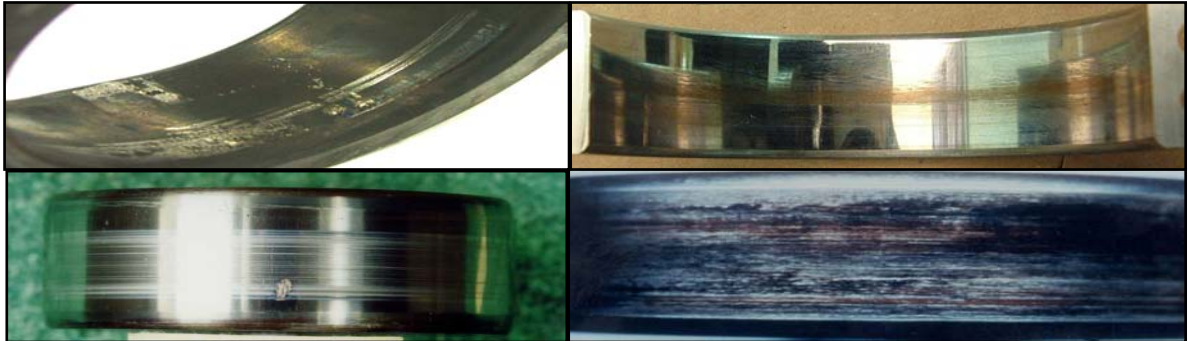











Electric Arcing : Pitted or corrugated surface caused by electric current pass.

Causes: Electric current passes through the bearing current melts patterns in the raceway surface

Countermeasures: Eliminate the flow of electric current through the bearing by grounding by grounding brush, insulating bearing or using ceramic balls.



Bearing Failures

Time Line						
Cause	Incorrect				Defects	
	Bearing Selection	Basic Design	Lubricate	Bearing Handling	Seal Failure	Defective Bearing
After Installation						
After periodic Maintenance						
After Re-lubrication						
During Normal Operation						

• Daily Care:

Bearings simply do not break down one day. Before a breakdown occurs, symptoms such as abnormal noises, increase in vibration and/or increased operating temperature will occur. It is important to check and record these characteristic of bearings on regular intervals. With this historical information trends can be identified and maintenance can be scheduled before catastrophic failure occurs. Bearing failures will not affect each of these three symptoms evenly, history will provide a key for each application as to which symptom to monitor.

• Noise:

Audible noise seems to be the number one characteristic used in determining bearing failure. Many times it is hard to determine if the noise is coming from the bearing or another component part in the machine. Listening rod and screw drivers & thumbs in the ear are used to try and isolate the bearing noise.

• Vibration Analysis:

Trends in the vibration signatures of equipment is a proven way to determine when maintenance should be performed. The vibration signature of each piece of equipment is different. These signatures are sensitive to variation in probe type, location of the probe on the equipment, even the auditor. On critical equipment the probes are mounted permanently and signals related to a control office.

• Operating Temperature:

Monitoring bearing temperatures is a proven approach and has been used for decades on critical equipment. Normally the probe contacts the outer ring. The operating temperature fluctuates since it is a function of the bearing heating up and the environment heating up.

Symptom During Operation		
Operating Condition		Potential Source of Trouble
Noise	Whining or Squealing	Insufficient Operating Clearance Contamination Poor Lube
	Rumbling or Irregular	Excessive Clearance Damaged Rings Contaminated Lube
	Change in Noise	Temperature Change Damaged Rings
Uneven Running		Damaged Rings Contamination
Reduced Working Accuracy		Wear due to Contaminants or Insufficient Lube

• **Bearing Sounds**

As shown in the previous table the bearing noise is an indication of many possible bearing situations. The following chart attempts to qualify the audible sounds.

Sound Features	Causes
Continuous Sounds Zaaaa Shaaa Jiiii	Deterioration of surface roughness or damage to the raceways and rolling elements
Bussing tone Woo-woo Goo-goo	Resonance, poor fit condition Deformation of bearing rings, fluttering of elements on raceway
Indeterminate sound Chiritchirit Piri-piri Pin-pin	Foreign matter (dirt) Creaking of attachment surfaces
Metal Galling noise Kii-kii Gii-gii Kin-kin	Excessive contact of elements and cage Insufficient Clearance Poor Lubrication

MEMO PAGE

MEMO PAGE

MEMO PAGE

MEMO PAGE

NACHI

NACHI AMERICA INC.



 **Action Bearing**
Service. Inventory. Solutions.

CATALOG NO.: NAB1202-1
January 2013

The appearance and specifications of the products in this catalog may be changed without prior notice if required to improve performance. Every care has been taken to ensure the accuracy of the information contained in this catalog, but no liability can be accepted for errors or omissions.