

Fraunhofer Center for Sustainable Energy Systems

Approaches to Energy Yield Improvement in PV Modules

DR. DAN DOBLE

Group Leader, PV Modules

PRESENTED AT

*Intersolar North America 2010
San Francisco, CA, USA
July 13th, 2010*

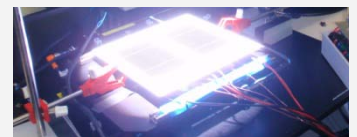
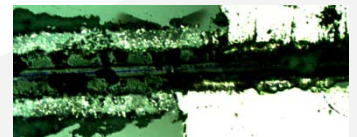
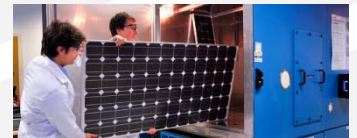
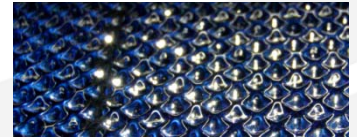
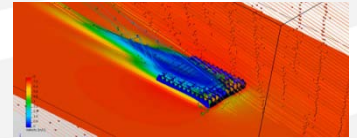
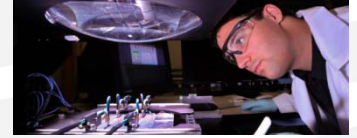

Energy Loss Mechanisms in PV Modules

Light Losses



Temperature Losses

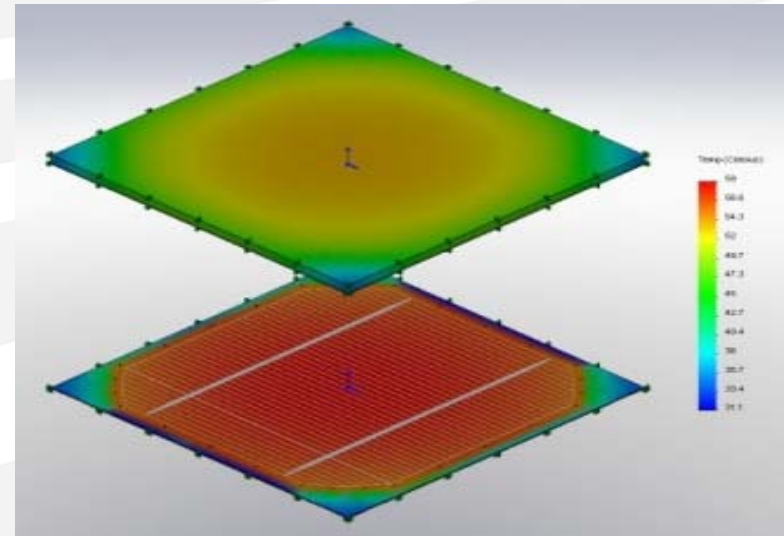

Electrical Losses

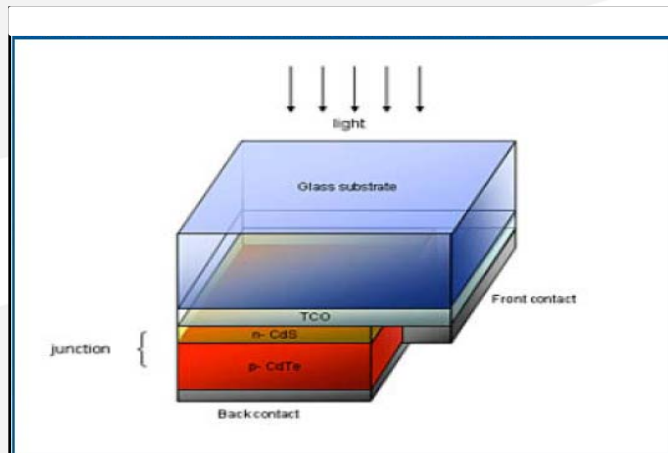

Light Loss Mechanisms in PV Modules

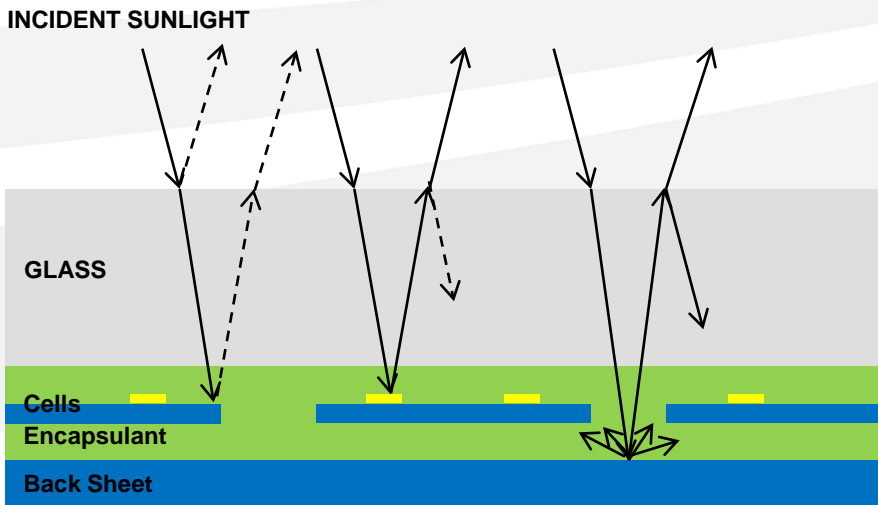
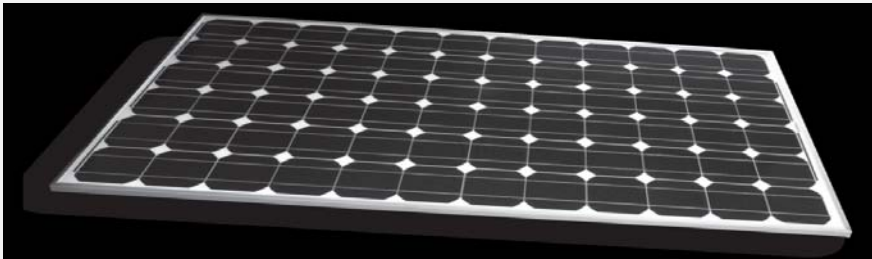

SOURCES: S. Krauter, *Solar Electric Power Generation*, Springer 2005; K. McIntosh et al, 2009 PV IEEE, Philadelphia.

IMPACT ON ENERGY YIELD

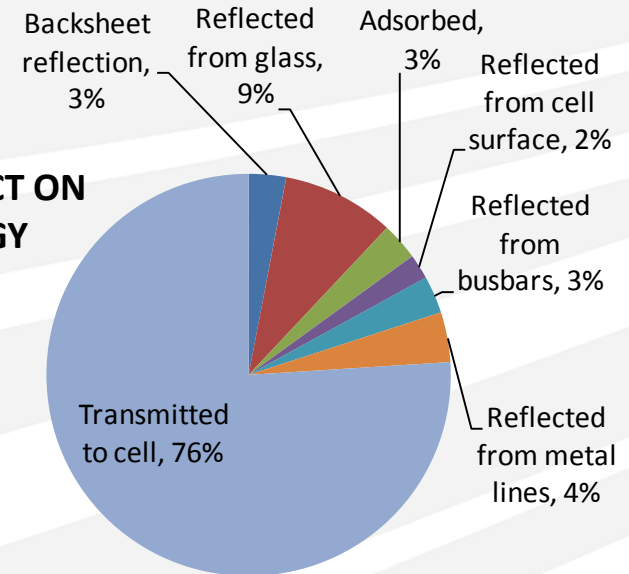

Assumptions: Incident sunlight, No ARC on glass, 4mm low Fe glass, 0.5mm EVA encapsulant, SiN ARC on textured cells, 7.5% of cell area is metallization, 93% cell packing factor in module. Excludes frame and edges. Energy yield is calculated for 33° on 07/01/2010 at 42° latitude. **Note:** Actual transmission to cell = 65% to >90% depending upon technology, architecture and orientation

A SIGNIFICANT PORTION OF SUNLIGHT MAY NEVER ENTER CELLS.

Reflection at Interfaces

- Fresnel reflection occurs between two materials of differing refractive index
- Highly dependant upon several factors:
 - Light polarization
 - Angle of incidence
 - Wavelength of incident sunlight
- In solar modules there are only two interfaces with a serious mismatch in RI, resulting in Fresnel reflection:
 - Air-glass interface
 - Encapsulant-cell interface

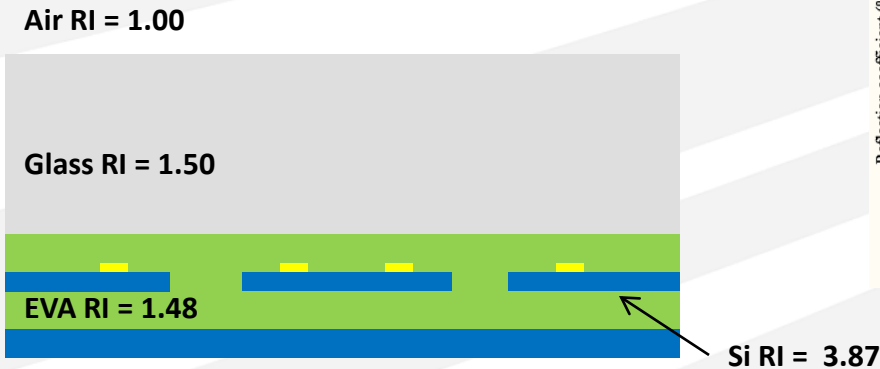

For normally incident light:

$$R = R_s = R_p = \left(\frac{n_1 - n_2}{n_1 + n_2} \right)^2$$

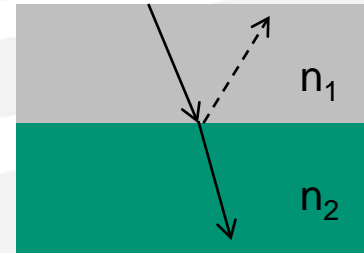

For light that is incident at an angle:

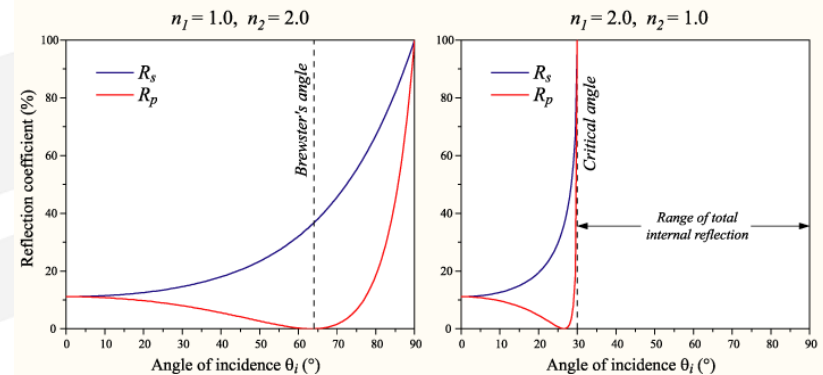

Technology 1: Anti-Reflective Coatings

- Coating applied to the surface of glass
- Main technology types:
 - Destructive interference
 - Graded refractive index
- Graded RI can be accomplished with nano-textured surfaces
 - Porous surface produced from sol-gel liquid processing
 - Occurs in nature on the surface of a moth's eye

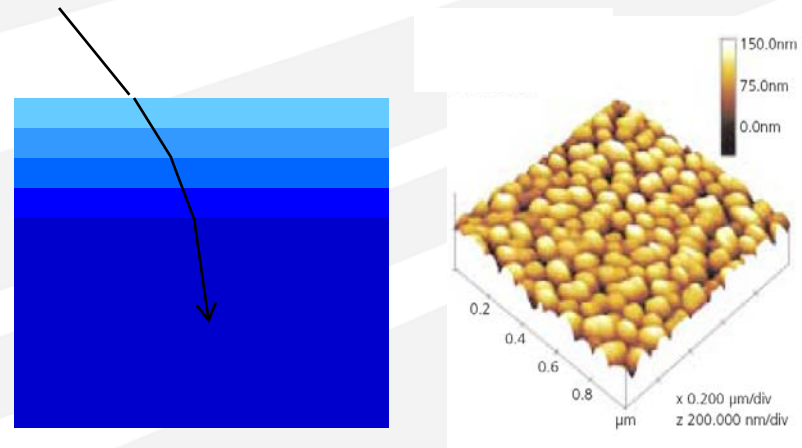
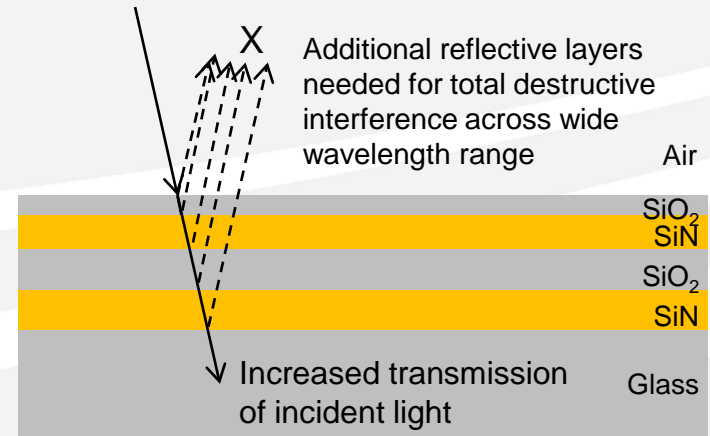

SOURCES: Saint Gobain Glass; Doble, Graff, *PV World*, 2009; Fraunhofer Magazine Volume 2, 2005

Technology 2: Laser Roughening

Standard PV Module

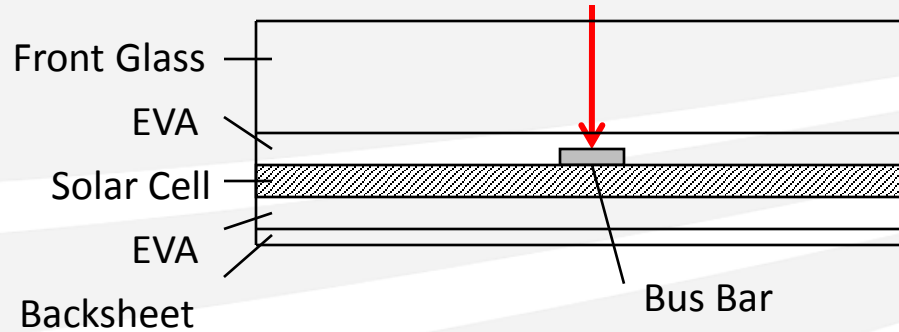

Local Roughening with Laser to Introduce a Scattering Surface

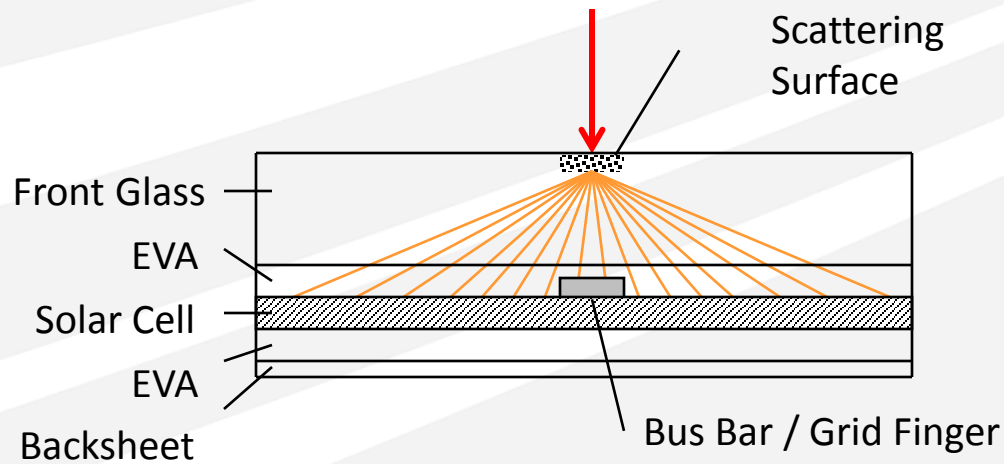

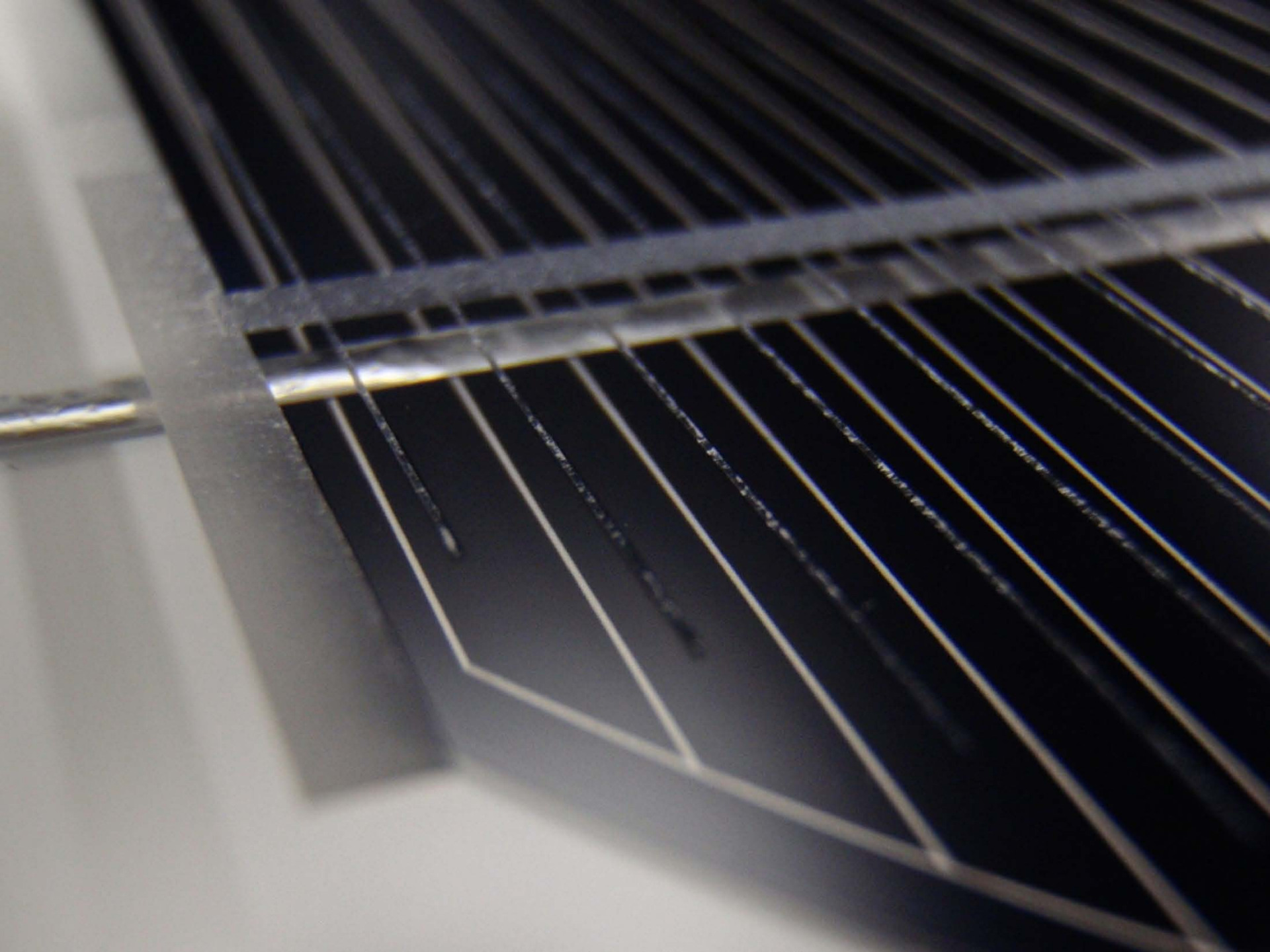

Results for Laser Roughening

- Processed using a 266nm laser
- Scattering structures must be exactly above metallization structures
 - Works only for perpendicular direct light
 - Tracking of the module is necessary
- Results for 1-cell mini modules:
2.1 – 3.3 % increase in I_{sc}
no change in V_{oc} and FF

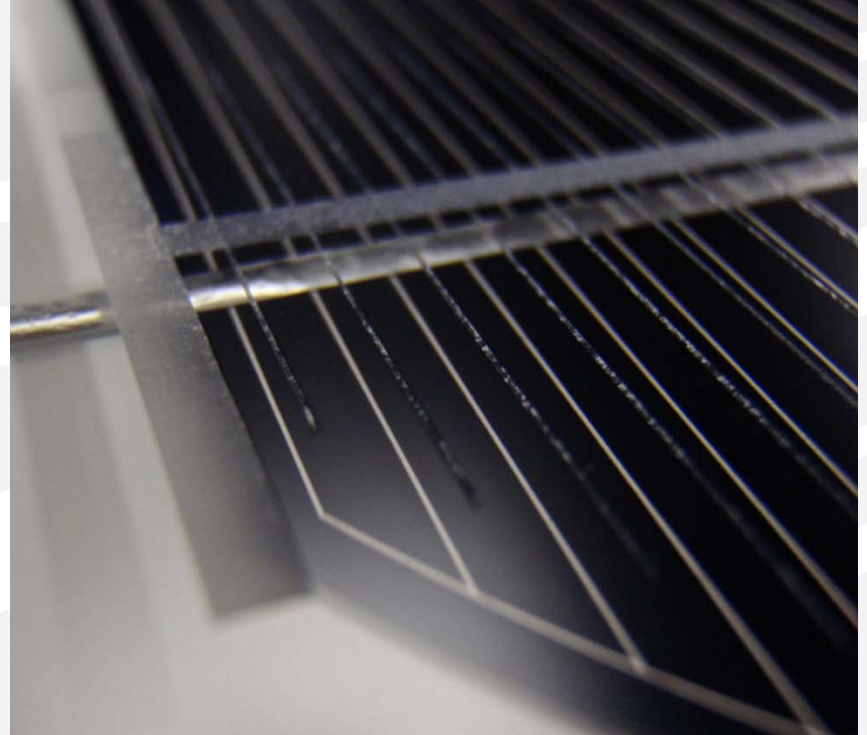

Technology 3: Diffuse Coating on Bus Bars

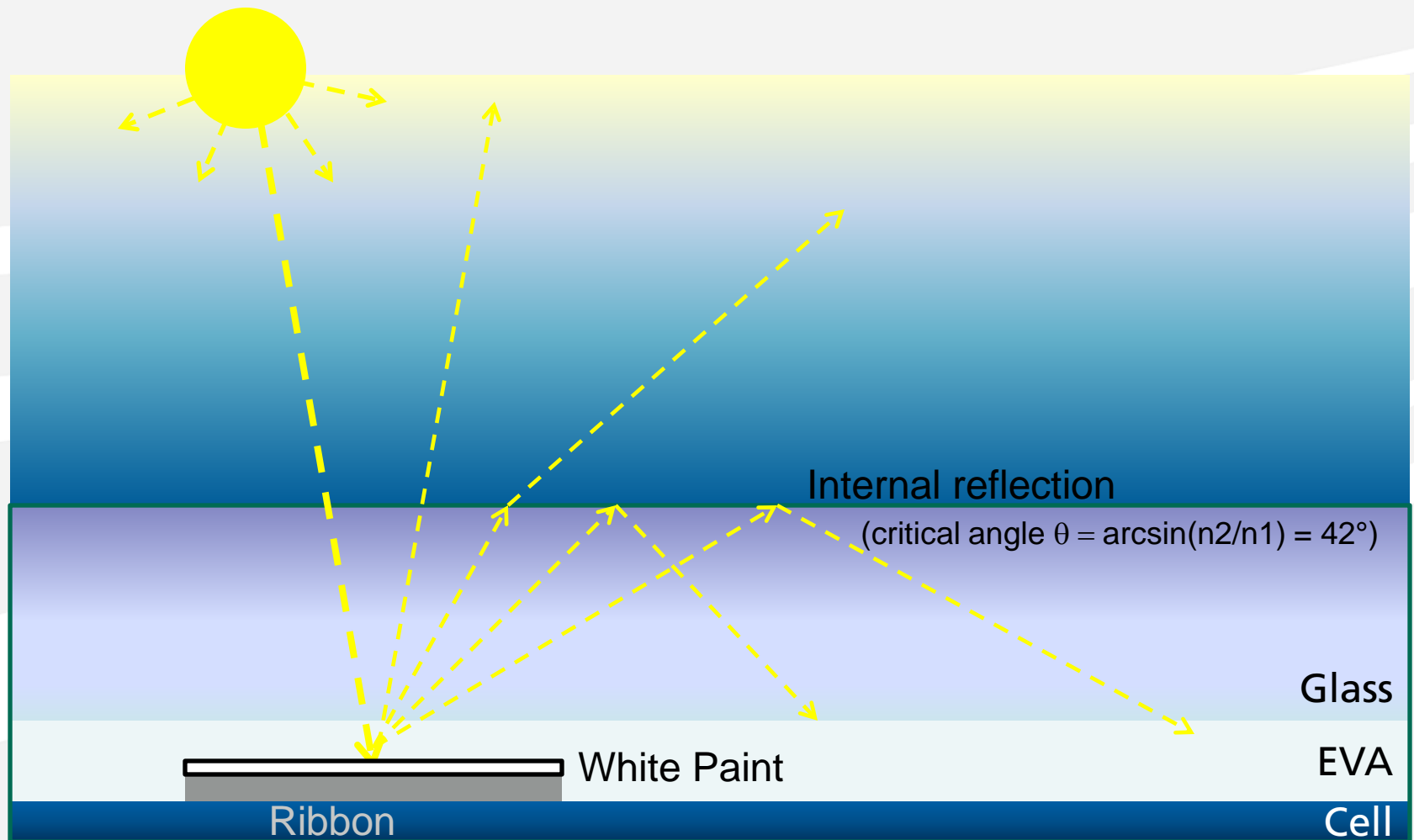

Diffuse Reflective Busbars: Visualization with Laser

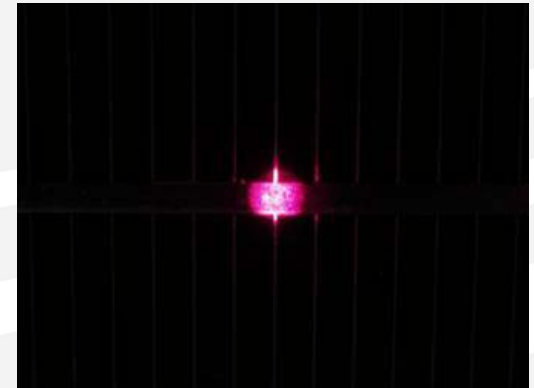
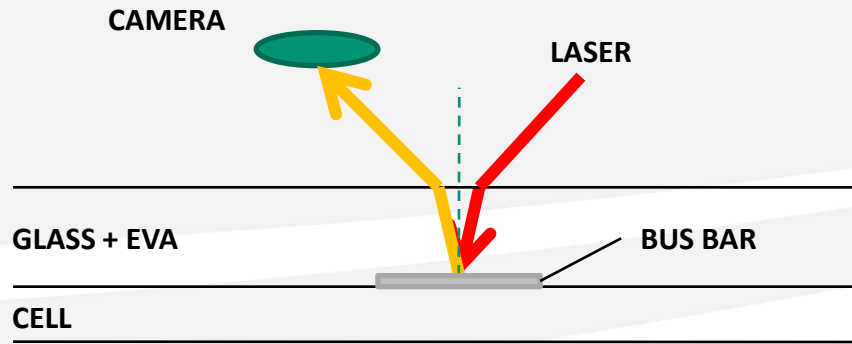

- Dark area around center indicates “dead zone” where most light is lost
- Light that is above critical angle $\theta_2 > 42^\circ$ is totally internally reflected
- Some 70% of overall light is internally reflected

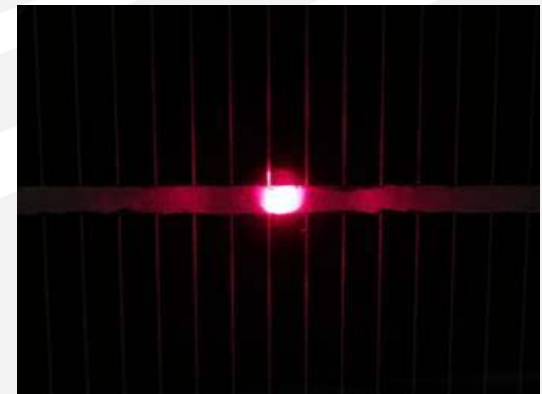
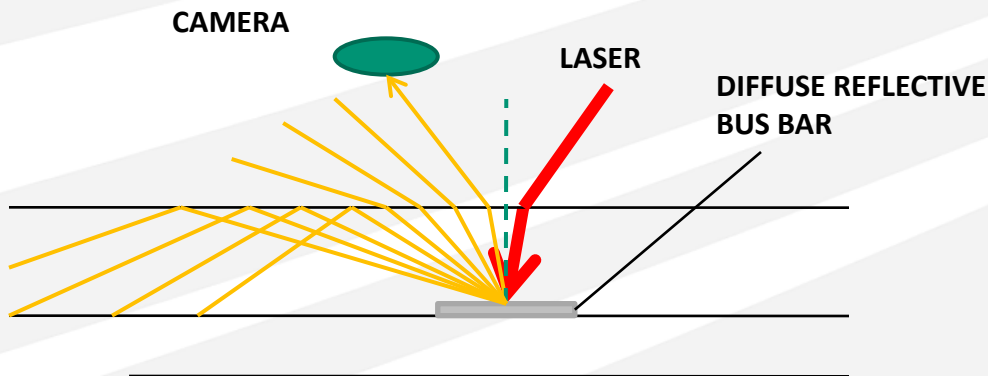

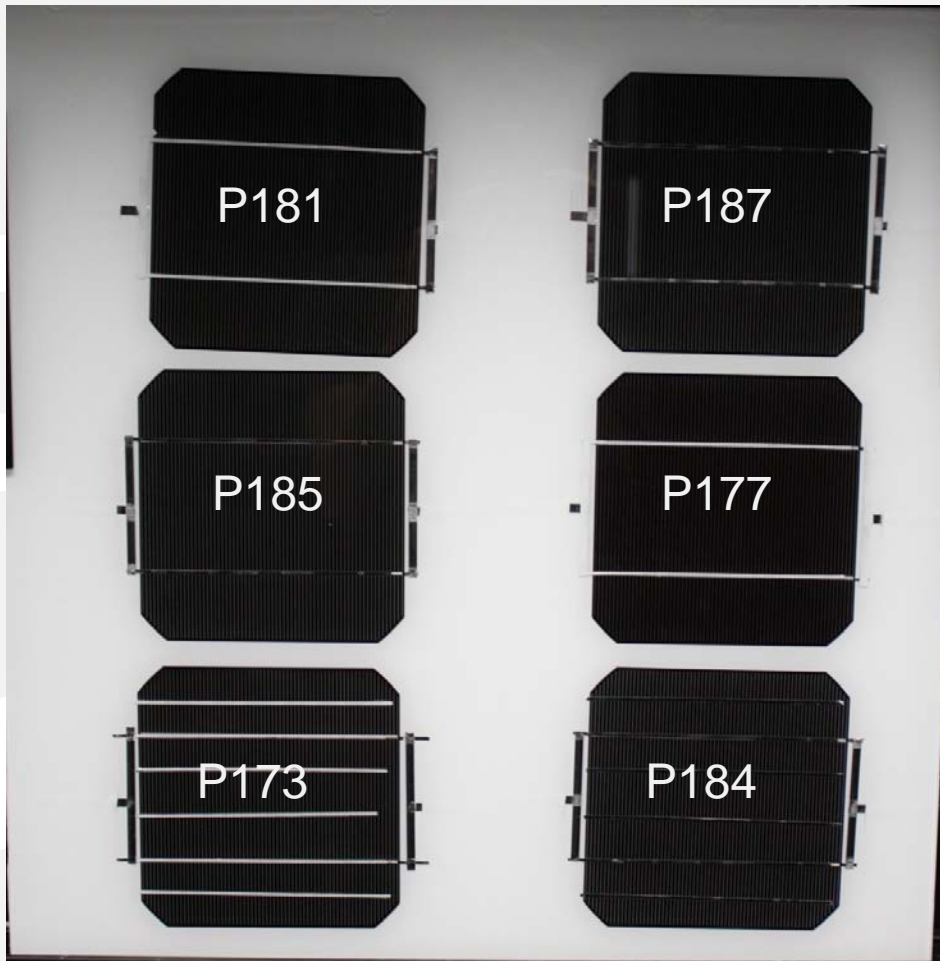

Measuring the Effect on Module Efficiency



- Test module fabricated in which cells have individual contacts:
 - 2 x 2 standard busbars
 - 2 x 2 diffuse busbars
 - 1 x 6 standard busbars
 - 1 x 6 diffuse busbars
- Monitor relative changes in I_{SC}

Module Measurements with Diffuse Reflecting Bus Bars

		Average increase in I_{SC}	Standard Deviation
Two Bus Bars		+ 0.9 %	0.4 %
Six Bus Bars		+ 2.5 %	0.6 %

Note: V_{OC} and
FF remain
unchanged

- 0.9 % average increase in I_{SC} , compared to shading of bus bars is 2.6 %
 - Equivalent to recapturing 35 % of available light; in theory 70% can be recaptured
- Possible loss mechanisms:
 - Adsorption by reflector
 - Imperfect Lambertian reflection
 - Some reflected light will again be incident on metalization

Technology 4: Textured Glass

- Macro-scale surface texturization enhances light transmission
 - Works at a range of wavelengths
 - Works at a range of incidence angles
 - Inverted pyramids are the optimal structure
- Additionally serves to trap light within the cell

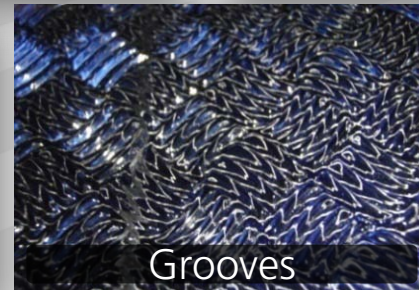
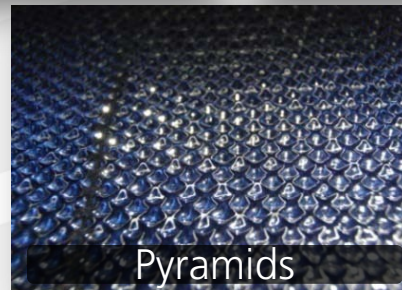
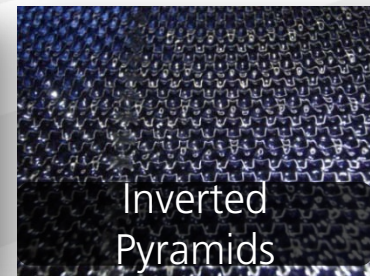
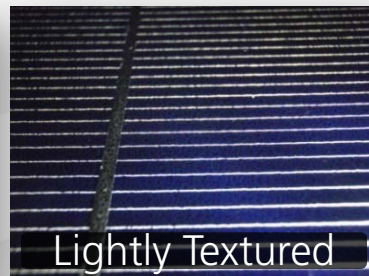
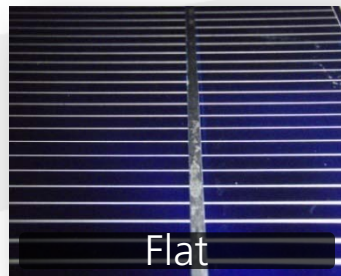
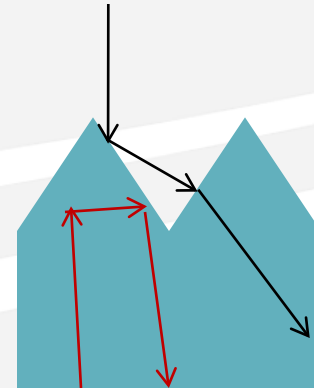

Textured Glass: Results

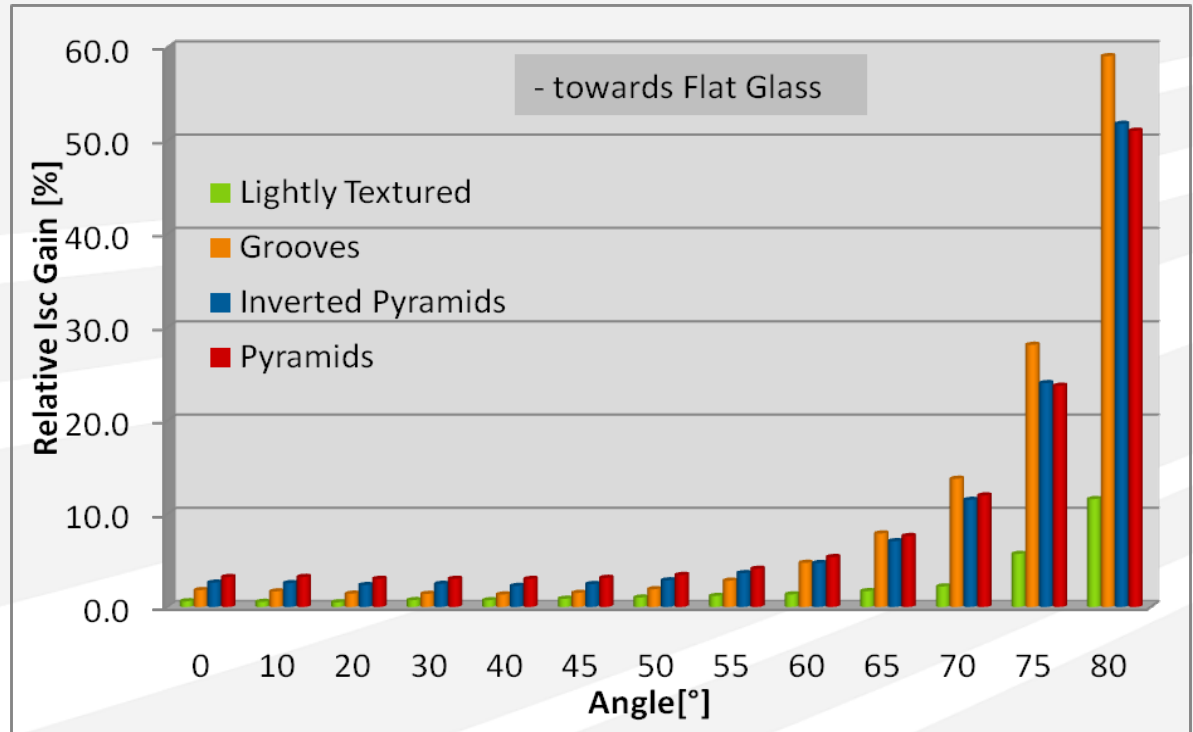
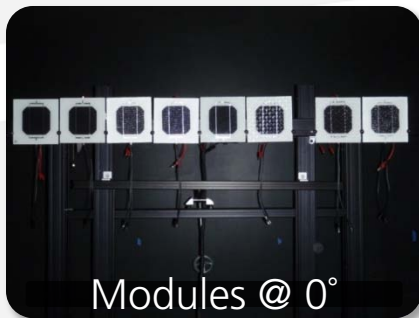

- Significant improvement in transmission of light
 - Improvement in transmission of normally incident light = 3.2% (in theory up to 6%)
 - Improvement in energy yield = 6.9% (in theory up to 15%)
- Yet below theoretical predictions

Textured Glass: Fine Structure

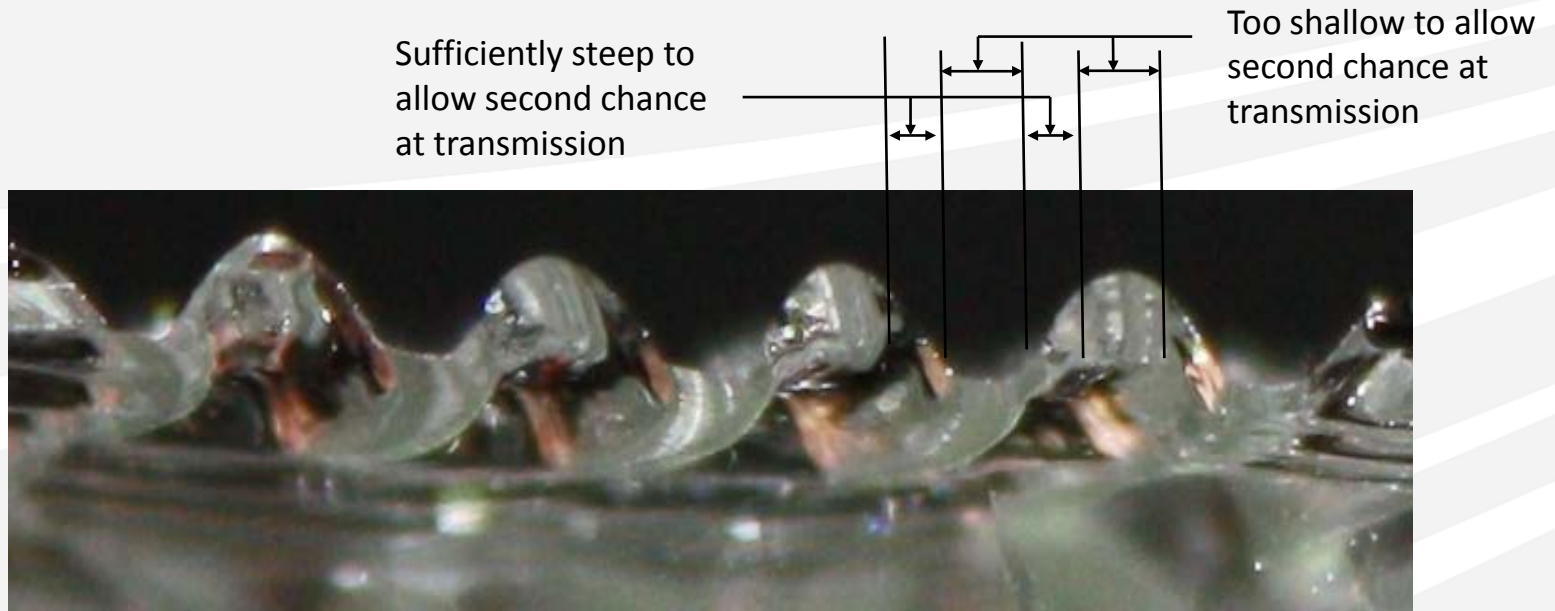

- Features on textured glass have highly rounded corners
 - Much of incident light essentially sees a flat surface
- Ideal structure would have sharp corners

Summary of Light Management Technologies

	Technology			
	ARC layer on glass	Roughened Grid on glass	White bus bars	Textured Glass
Reduces reflection of the module glass (normal incidence)	✓			✓
Reduces losses from reflection within module		✓	✓	✓
Technology also works well for off-angle incident light	✓		✓	✓
Technology also has the potential to reduce module temperature				✓
Soiling Concern		X		X
Sum of energy yield losses addressed by technology	9%	6%	3%	15%

■ Laser Roughening

- Simple process, no materials needed
- Tracking necessary
- Soiling is a potential issue

■ Diffusive Bus Bar Paint

- Simple process and low material costs
- No soiling issues, no tracking required

■ Textured Glass

- Addresses both light transmission and light reflected from within module
- Soiling is a potential issue
- Potential to also decrease module temperature

Effect of Textured Glass on Module Temperature

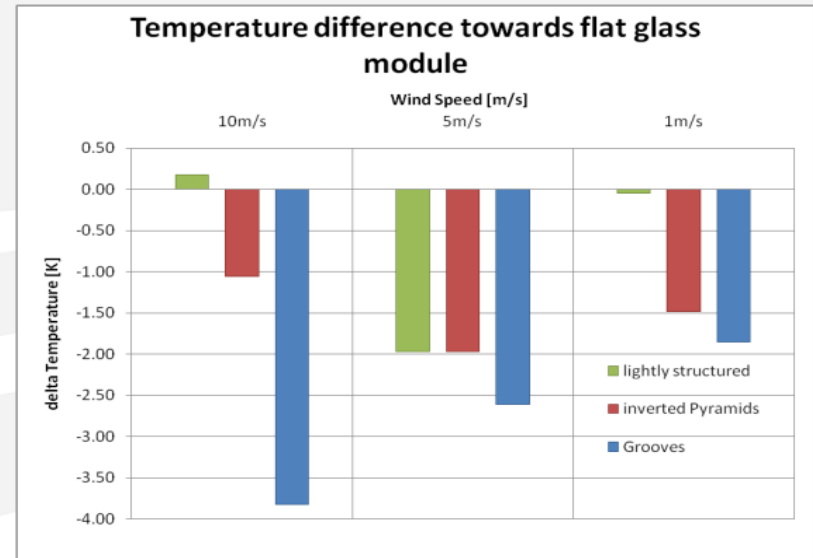

Experimental Setup

- Heater foils laminated inside module in place of cells
- Wind velocity controlled in wind tunnel
- Temperature measured via thermocouples and thermal imaging camera

Results

- Textured glass modules operate at a lower temperature than flat glass
- Difference is highly dependent on wind speed

Outdoor Test Data on Textured Glass

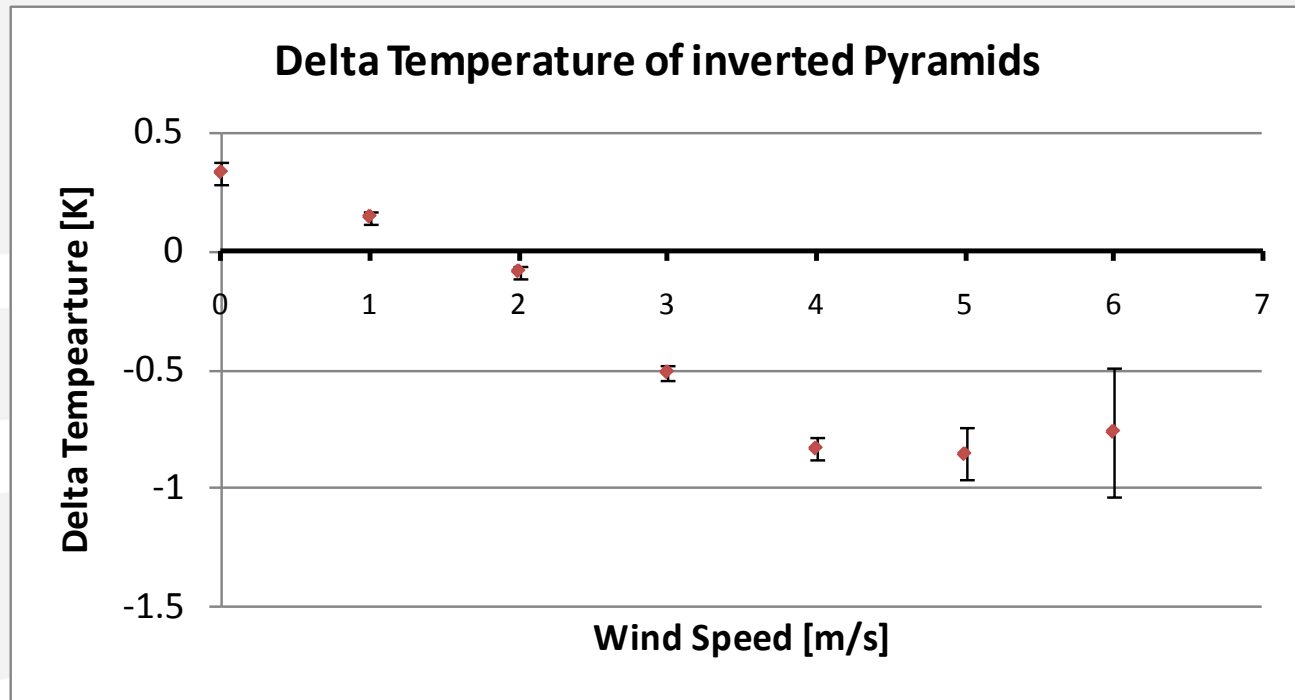

- At low wind speed, increased light transmission results in higher module temperature
- At higher wind speed, the increased convective cooling wins out, resulting in a reduction in module temperature

Acknowledgements

▪ Direct Contributors

- Joachim Jaus
- Matthias Duell
- Matthieu Ebert
- Johannes Eckert

▪ CSE PV Module Group

- Rafal Mickiewicz
- Biao Li
- Frederick Adurodija
- Carola Voelker
- Theresa Christian
- Tanja Schumacher
- Matthias Winter
- Matthias Koch
- John Lloyd
- Marco Jaeger

▪ Fraunhofer CLT

- Henrikki Pantsar
- Hans Haworth
- Stefan Heinemann
- Boris Reagard

▪ NREL

- Matt Muller
- Bill Marion
- Sarah Kurtz

▪ MIT

- Dick Perdichizi