

# The Basics of Loop Vehicle Detection

There are a number of ways to detect vehicles, ranging from hose style detection to ultra-sonic, to inductive loop. For traffic control or drive-thru, inductive loop technology is the most reliable, bar none.

An inductive loop vehicle detector system consists of three components: a loop (preformed or saw-cut), loop extension cable and a detector. When installing or repairing an inductive loop system the smallest detail can mean the difference between reliable detection and an intermittent detection of vehicles. Therefore, attention to detail when installing or troubleshooting an inductive loop vehicle detection system is absolutely critical.

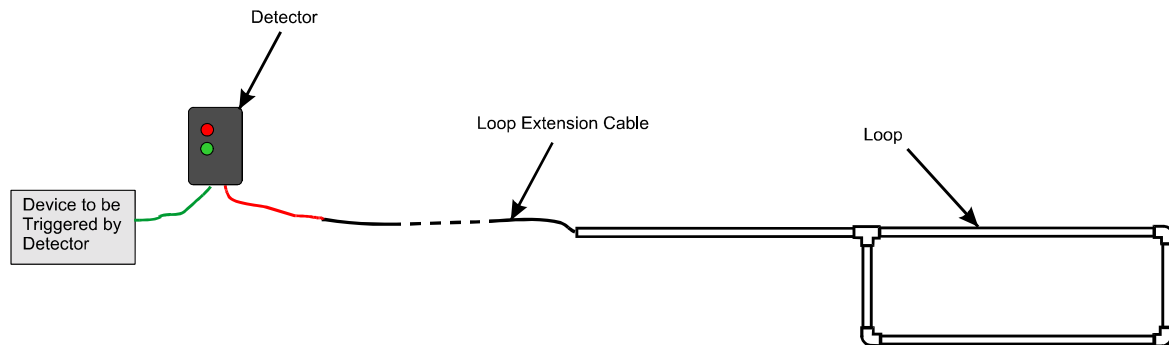
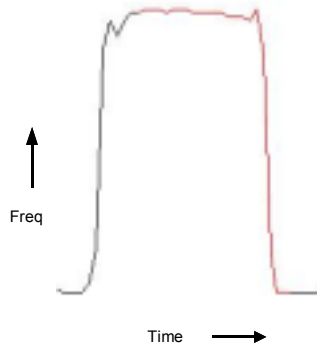
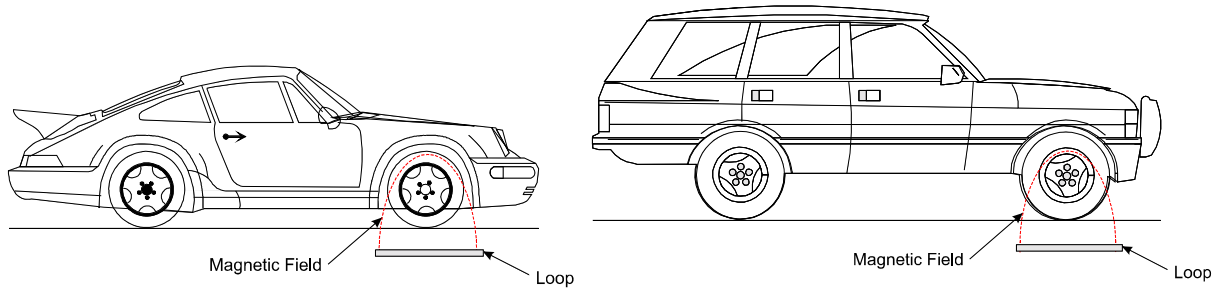

Figure 1.

## How it Works:

The preformed or saw-cut loop is buried in the traffic lane. The loop is a continuous run of wire that enters and exits from the same point. The two ends of the loop wire are connected to the loop extension cable, which in turn connects to the vehicle detector. The detector powers the loop causing a magnetic field in the loop area. The loop resonates at a constant frequency that the detector monitors. A base frequency is established when there is no vehicle over the loop. When a large metal object, such as a vehicle, moves over the loop, the resonate frequency increases. This increase in frequency is sensed and, depending on the design of the detector, forces a normally open relay to close. The relay will remain closed until the vehicle leaves the loop and the frequency returns to the base level. The relay can trigger any number of devices such as an audio intercom system, a gate, a traffic light, etc.

In general, a compact car will cause a greater increase in frequency than a full size car or truck. This occurs because the metal surfaces on the under carriage of the vehicle are closer to the loop. Figures 3 and 4 illustrate how the under carriage of a sports car is well within the magnetic field of the loop compared to the sports utility vehicle. Notice that the frequency change is greater with the smaller vehicle.



**Figure 2**

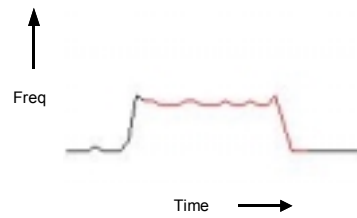

**Figure 3**

Also, it is interesting to note that the frequency change is very consistent between two vehicles of the same make and model, so much so that a detector can almost be designed to determine the type of vehicle over the loop.

There is a misconception that inductive loop vehicle detection is based on metal mass. This is simply not true. Detection is based on metal surface area, otherwise known as skin effect. The greater the surface area of metal in the same plane as the loop, the greater the increase in frequency. For example, a one square foot piece of sheet metal positioned in the same plane of the loop has the same affect as a hunk of metal one foot square and one foot thick. Another way to illustrate the point is to take the same one square foot piece of sheet metal, which is easily detected when held in the same plane as the loop, and turn it perpendicular to the loop and it becomes impossible to detect. Keep this principle in mind when dealing with inductive loop detectors.

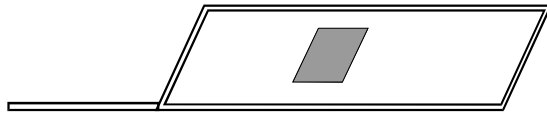

**Figure 4.**  
1' sq Sheet Metal in plane of Loop. Easily Detected.

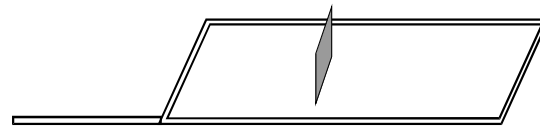

**Figure 5.**  
1' sq Sheet Metal perpendicular to the Loop. Not detectable.

### Preformed and Saw-Cut Loops

A preformed loop is typically 3 to 5 turns of loop wire encased in PVC pipe for use in new construction before the pavement is installed. The loop wire is 14 or 16 awg stranded machine tool wire with an insulation of XLPE (cross-linked polyethylene) encased in PVC pipe to hold the loop's shape and to protect the loop wire from damage while the pavement is installed.

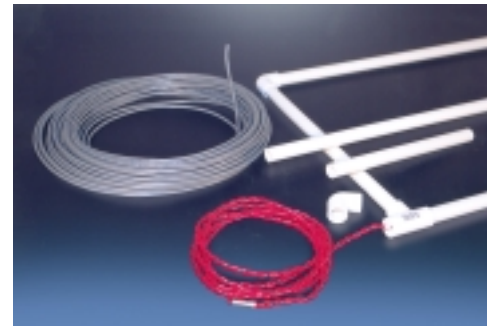

**Preformed Loop with extension cable**

A saw-cut loop is used when the pavement is already in place. The installation involves cutting the loop shape in the pavement with a concrete saw, laying the loop wire in the slot, pressing in a polyfoam backer-rod to keep the wire compacted and finishing with saw-cut loop sealant or street bondo to fill the slot and protect the wire.



**Saw-Cut Loop wire and Loop Sealant**

It is best to use the recommended 14 or 16-awg machine tool wire for loop installation. The insulation has a high resistance to water, heat, abrasions, oils and gasoline. Purchase the wire from the same source you bought the saw-cut loop sealant to be sure to get the correct wire.

## Loop Extension Cable

Loop extension cable is used to extend the distance from the preformed or saw-cut loop to the vehicle detector, which is usually located indoors or in a weatherproof enclosure. The characteristics of the extension cable are just as important as the characteristics of the loop wire. Use only 14, 16, or 18 awg stranded 2 conductor twisted, shielded cable with a polyethylene insulation jacket. The extension cable connections to the loop wire and the vehicle detector wires must be soldered. Do not use any other method for connection. The distance between the loop and the detector can safely be extended to 300 feet with proper extension cable, however check with the vehicle detector manufacturer for confirmation.

## Loop Vehicle Detector

The proper installation and material is critical! In general, loop vehicle detectors from all manufacturers work under the same principle and will all work reliably if the installation is done properly and the correct materials are used.

Vehicle detector features differ between manufacturers, and most are straight forward. The following features need special consideration.



**Number of Outputs.** Most detectors provide a switch closure via a relay, which is typically configured as normally open. It is the number of outputs provided that may be important and how they can be configured. More and more devices, particularly in the drive-thru environments, need to be triggered by vehicle detection, such as audio communication, car timing, message greeting, electronic menu boards, gates, etc. Determine the number of devices that will be used now and in the future with the vehicle detector and match or exceed that number with the number of available relay outputs.

**Signal Type.** All detectors provide a constant presence style of signal output. In other words, the relay output is closed the entire time that a vehicle is present over the loop, and does not open again until the vehicle drives away. Most devices require this style of output signal, however some devices require a pulse style, which will only momentarily close the relay at the time when the vehicle is detected. Check the requirements of the devices that you are connecting to the detector. If you are connecting more than one device to the detector, make sure that the detector can provide the required signal types at the same time. Some detectors can only provide one or the other style of signal output at a time.

**Diagnostics.** Some detectors provide PC diagnostics via a communication port on the detector. Diagnostic software gives you a visual picture of what is happening at the loop, and will help you troubleshoot any problems you may experience during installation or in the future. Detectors with this feature are usually in the same price range as other detectors and can help you save time solving a detection problem. The PC software and cable is usually additional, however keep in mind that if you have multiple installations you need only buy the software and cable setup once. Diagnostics software can also help determine the depth and position of the loop in the pavement.

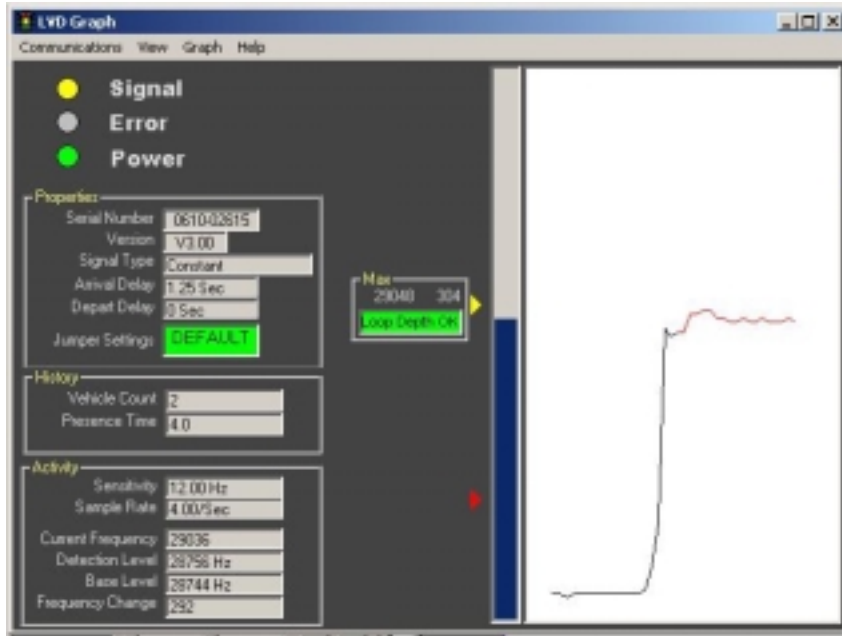

Figure 6. Screen shot of Diagnostics Software

## Location

Location, Location, Location! The position of the loop relative to the vehicles you are trying to detect is extremely important. Vehicles entering a fast food restaurant drive-thru lane will stop at the menu board with the driver's window positioned in line with the speaker post. The front axle is the only metal surface whose relative position to the driver is consistent from vehicle to vehicle. Because of this fact, the vehicle detector is designed to pick up the front axle, not the vehicle's engine. Therefore, the loop should be positioned 1 ½ to 2 feet ahead of the speaker post, with the long axis of the loop running perpendicular to the traffic lane. This positions the axle of the vehicle directly over the loop in the same direction as the loop.

The proper installation and location of the loop are the most important aspects of reliable vehicle detection. In recent years, there has been an increase in the number of missed and false detections due to the popularity of SUVs. The missed detections can be attributed to two factors. First, and most obvious, is that the metal surface area of the taller vehicles is farther away from the loop which makes the vehicle more difficult to detect. Second, and less obvious, is that larger vehicles have a greater turn-

## of Loop

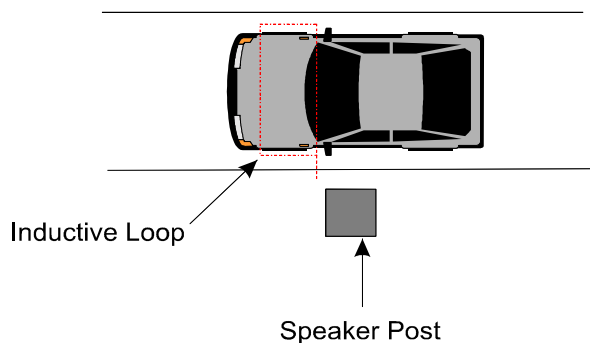

Figure 7. Proper location of loop to pick up metal of front axle.

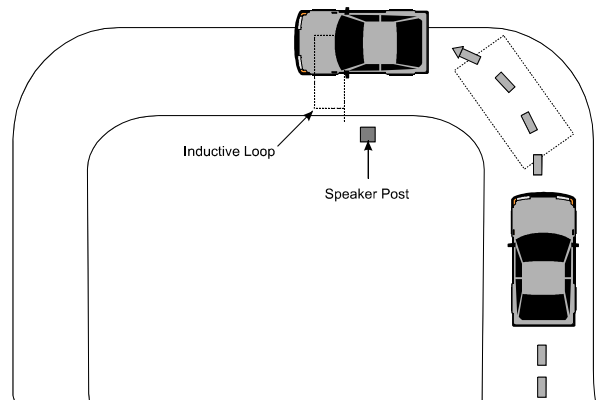

Figure 8. Drive Thru showing tight traffic lane. Vehicles with large turning radius end up in wrong position over loop.

ing radius. The driver finds it difficult in some drive-thru lanes to round the corner prior to the loop and as a result, the vehicle becomes positioned further away from the curb and not properly positioned over the loop. Compound the poor position of the vehicle with the height of the vehicle and you have a difficult vehicle to detect.

### Loop Installation

Follow closely the manufacturers installation instructions for the saw-cut or preformed loop that you purchased. However, there are a couple of important points to make with regard to saw-cut loop and preformed loop installation.

It is important that when the installation is complete the loop be no more than 2" below the surface of the asphalt or concrete. The deeper the loop the less sensitive the loop detection system becomes.

It is also important that the lead-in wires from the detector to the beginning of the loop be twisted a minimum of five times per foot.

### Saw-Cut Loop Installation

When installing a saw-cut loop inspect the cable for any nicks in the protective jacket. Reject and replace any nicked wire. Never splice the loop wire except to splice the loop extension cable to the loop lead in wires and to splice the vehicle detector lead wires to the extension cable. Always solder the connections, never use a short cut such as wire nuts.

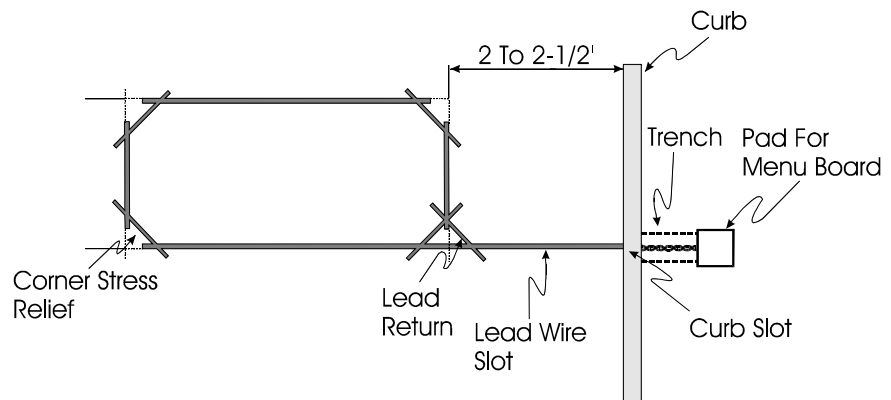

Figure 9.

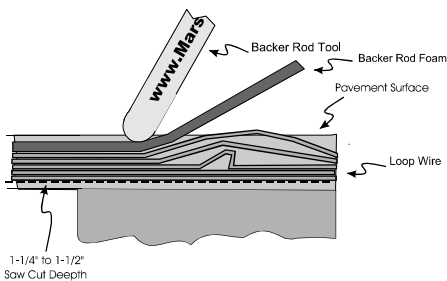

Figure 10.

When making the loop pattern with a concrete saw, cut the corners of the rectangle at a 45-degree angle. This reduces stress and the possibility of nicking the wire outer jacket.

Always use backer rod pressed into the saw-cuts to secure the loop wire before using the street sealer. If backer rod is not used the loop wire will float in the saw-cut slot while the

street sealer is curing, resulting in air pockets. If air pockets exist, the loop wire will move whenever the pavement vibrates and false detections will occur.

### Preformed Loop Installation

Preparation of the loop area prior to placing the loop is important. Start by cutting back any and all concrete reinforcement such as rebar at least 2' from the outer parameter of the loop. Rebar will reduce the sensitivity of the detector. Most detectors are designed to tune out rebar, but rebar will decrease the sensitivity, so take the time now to avoid a problem later.

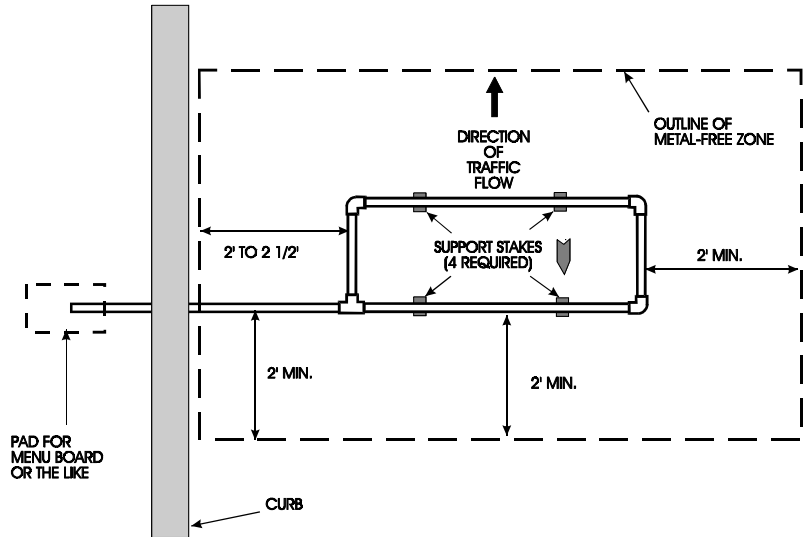

Figure 11.

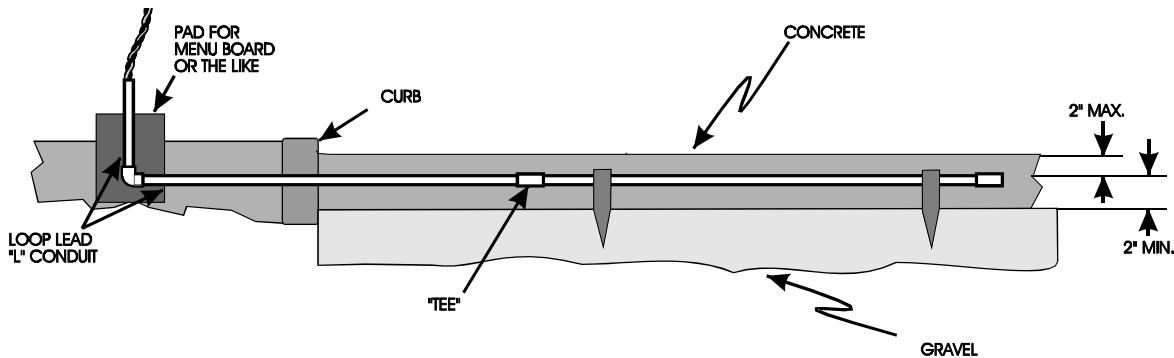

Figure 12.

Next place the preformed loop onto stakes in order to position the loop 2" below the finished surface.

### Sensitivity

Most vehicle detectors have adjustable settings for sensitivity. If the detector is missing vehicles then the sensitivity is set too low. If the detector is jumpy or is creating false detections, it may be set too sensitive. However, all inductive loop detectors are dealing with the same physical characteristics of a magnetic field in a loop. The maximum height of detection is roughly 2/3 the length of the short side of the loop. For example, if you have a loop that is 18" x 60", the maximum height of detection is 12" from the loop. Most manufacturers have managed to push the height of detection to the full length of the short side, however keep in mind this is not as reliable.

The most effective way to increase sensitivity is to lengthen the short side of the loop. Most drive-thru loops are 18 to 24 inches wide. If you take an 18" x 60" loop and increase the short side to 24", you have increased the height of detection by 4". However, making the loop too wide can cause a different problem. In the drive-thru scenario where vehicles move slowly, and bumper to bumper, a system that is too sensitive may not be able to identify the gap between vehicles causing a missed detection.

Another misconception about loop sensitivity is that increasing the number of turns in the loop will increase sensitivity. Increasing or decreasing the number of turns does not affect sensitivity. Increasing the number of turns increases stability. Three to five turns is ideal for maintaining the proper stability and sensitivity combination.

The frequency of the loop will change as the environment changes, as a result most detectors are designed to constantly adjust to this slow change in frequency over time. The detector's purpose is to detect rapid changes in frequency. However, inductive loops and detectors are sensitive to temperature. When the temperature of the inductive loop increases, the frequency will decrease, and the opposite is true of the detector. When the temperature of the detector increases the frequency will increase. If the temperature of either the loop or the detector increases or decreases too fast, false detections will occur. The loop, buried in the pavement is not likely to change temperature rapidly, however mounting the detector in the wrong place can cause such a problem. For example, mounting the detector directly in line with a window where it can get a cold blast of air whenever the window is open, can result in problems.

## **Troubleshooting**

Most detectors provide LEDs that will indicate a problem with the loop, such as a short or an open. It is possible for a problem to occur that will cause the error indicating LED to stay on and yet the installation is ok, but simply needs a reset. Lightning can cause such a problem. Electrical storms can cause havoc with equipment, especially vehicle detectors because the loop is outside.

If problems persist, check the connections to the extension cable and to the loop lead-in wires. Bad connections are a very common problem with inductive loops.

If the installed detector has a communications port for diagnostics, beg, borrow or steal, a copy of the software and cabling needed to utilize this feature. Diagnostics software is an amazingly powerful tool for diagnostics, is less expensive than the test equipment needed to do the same job and will provide more information. Some diagnostics software will even capture the data to disk. This is especially useful if you have an intermittent problem. You can leave the computer running for days in order to capture the problem.

In addition to using diagnostics software to capture or see a problem as it occurs it can often be used to help locate the loop in the pavement in order to determine if it's been properly positioned and buried at the right depth.



If a communications port is not available, the next best thing is a megaohm meter. After disconnecting the loop from the detector, place one lead of the meter to one of the lead wires of the loop and the other to earth ground. The resistance should be greater than 100 megaohms. If the resistance is between 50 and 100 megaohms then it is possible that the loop wire is nicked or the extension cable has been damaged. If the resistance is less than 50 megaohms, the loop is shorted to ground. In either case the loop or the extension cable must be replaced.

## Summary

Inductive loop detection is relatively simple as a system, but it is important to arm yourself with the knowledge of how it works and how the pieces interrelate. There is no question that a problematic installation can be extremely frustrating, but if you break it down to basics it can be solved more efficiently.

## Notes:

- ◆ Use a preformed loop before pavement is installed.
- ◆ Use a saw-cut loop when pavement has already been installed.
- ◆ The loop should be buried no more than 2" below the asphalt or concrete surface.
- ◆ Replace any loop wire that has nicks or splices in the insulation.
- ◆ Loop wire should be 14 or 16 awg machine tool wire with XLPE insulation.
- ◆ Loops should be no less than three turns and no greater than five.
- ◆ The number of turns increases stability of the signal over long runs between the loop and detector.
- ◆ The number of turns does not affect sensitivity.
- ◆ Extension cable should be 14, 16, or 18 awg twisted/shielded 2-conductor cable with polyethylene jacket.
- ◆ The wires that lead into the loop must be twisted a minimum of five turns per foot.
- ◆ The maximum height of detection is roughly  $\frac{2}{3}$  the length of the short side of the loop.
- ◆ Connections to the detector, the loop and the extension cable should be soldered.
- ◆ The frequency decreases as the temperature of the loop increases
- ◆ The frequency increases as the temperature of the detector increases