

FUJIFILM
Value from Innovation



J Press 750S

J Press 750S

23" X 29.5" Sheet-fed Production Inkjet Digital Press

Industry Leading Innovation

Fujifilm's advanced proprietary technologies are now found in our 3rd Generation J Press 750S. Our flagship J Press series continues to lead the industry in innovation.



FUJIFILM



J Press, leading innovation that is driving value and results

J Press offers application flexibility and benefits for short-run requirements that no offset print platform can match.

The J Press 750S delivers the industry's leading quality and provides compatibility with a wide variety of conventional offset media that no other digital press can match—all while delivering exceptional quality time after time.

The new 750S features innovation in technology and reliable productivity that goes beyond conventional and digital standards, generating a new dimension of value in production inkjet.

FUJIFILM



警告
注意
安全
事項
詳細
説明
書
を
読
み
取
り
ま
す

J Press, empowering creativity and flexibility to expand your business potential

The outstanding print quality only the J Press can deliver is the result from years of research and development, integrating Fujifilm owned technologies.

Inspiring clients worldwide, the J Press provides value, productivity and possibility beyond client expectations.

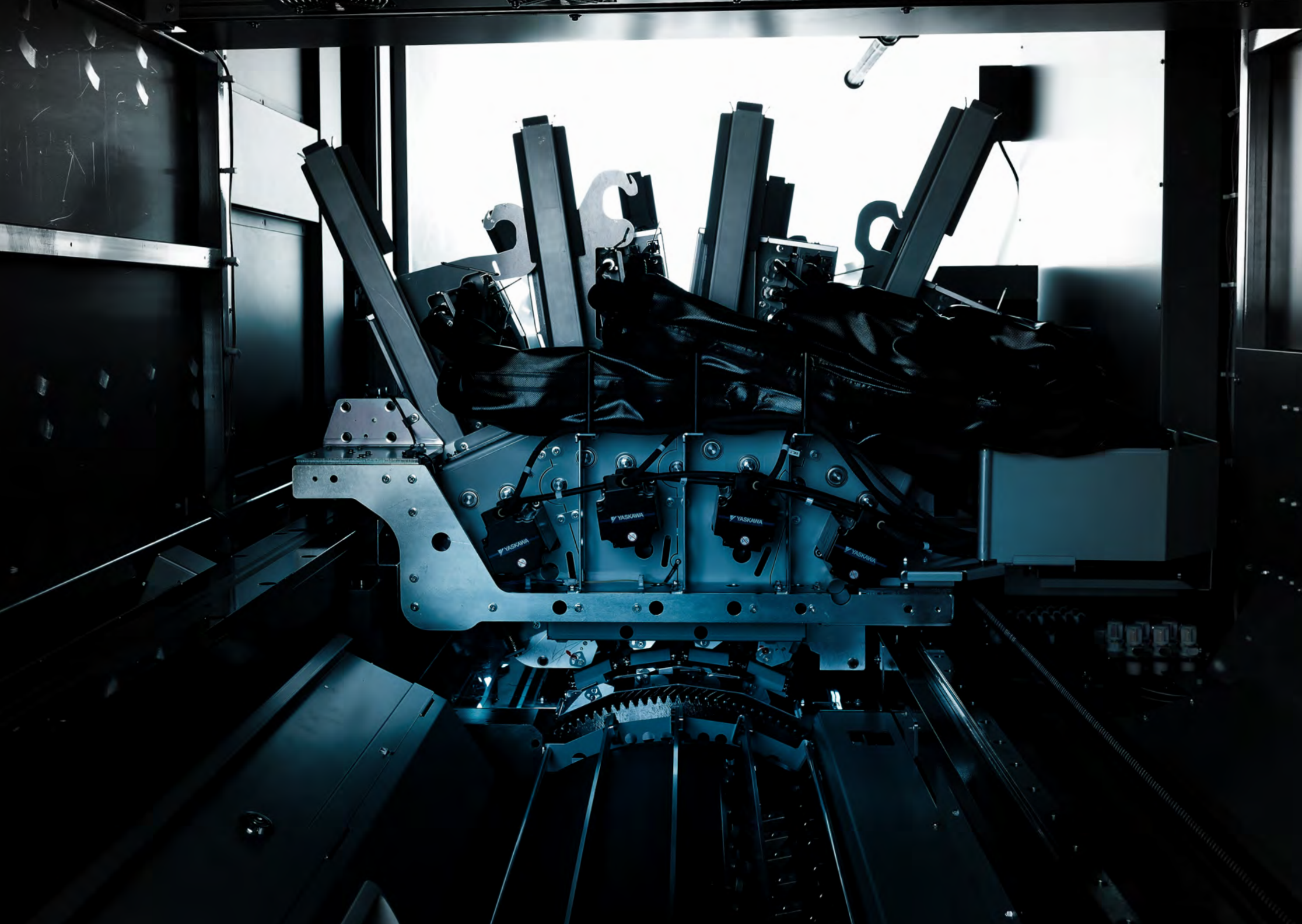

CYAN & MAGENTA

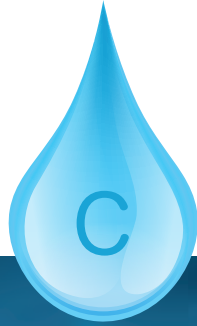

YELLOW & BLACK

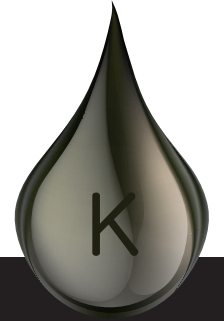

EXCEPTIONAL FLAT TINTS

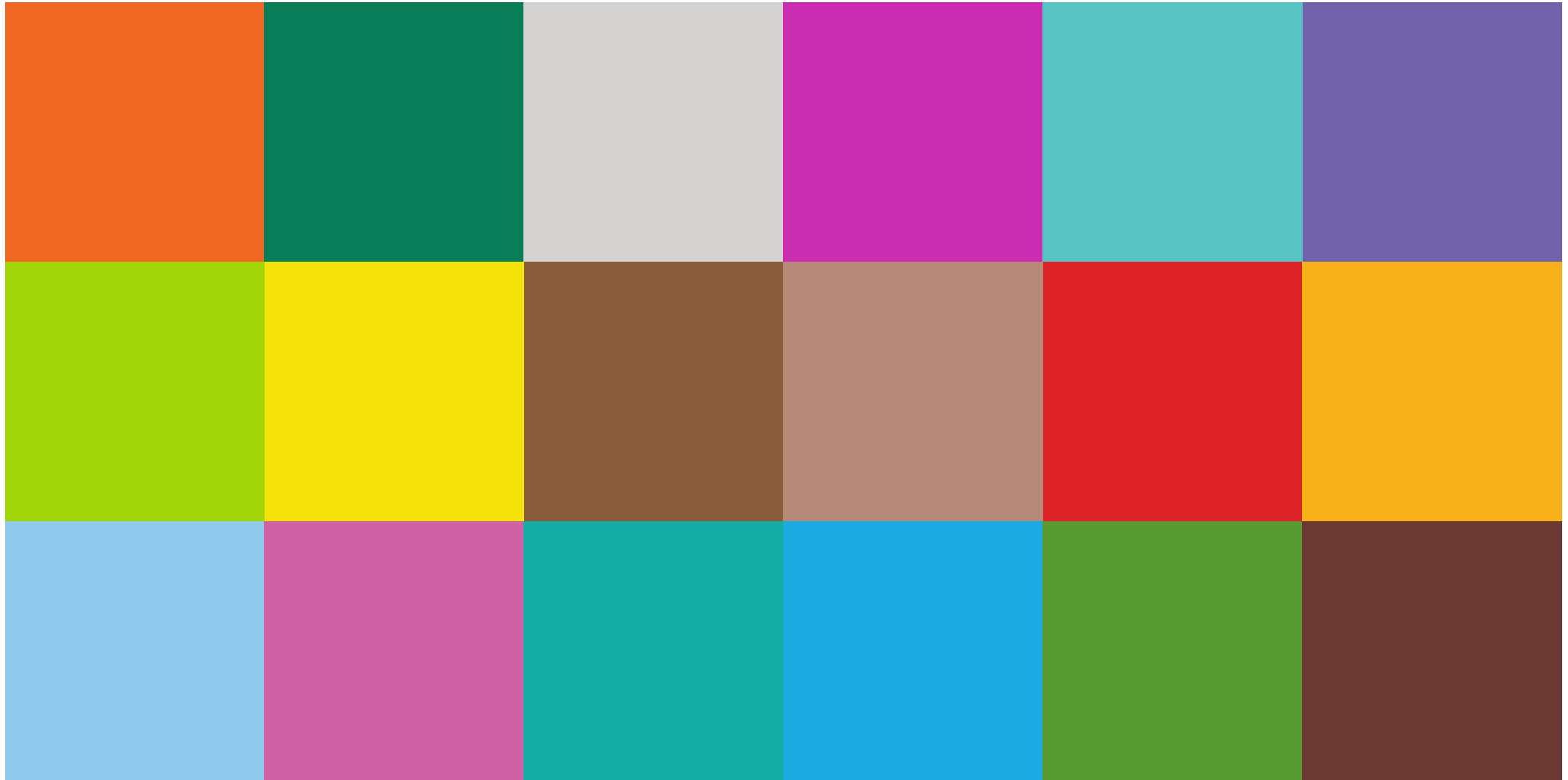

ULTRA SMOOTH GRADIENTS

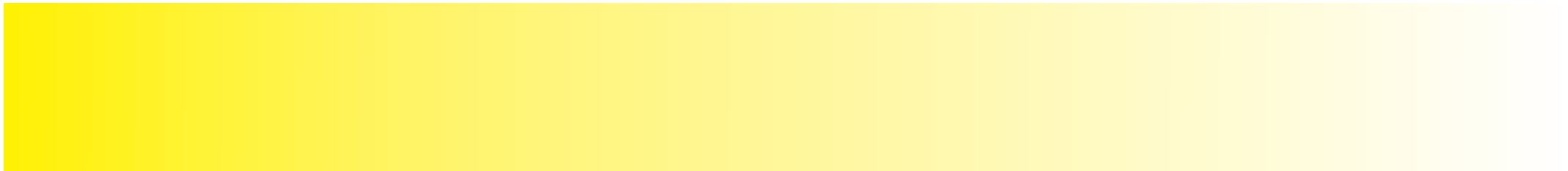

PERFECT BLACK TINTS



100%

75%

50%

25%

ULTRA FINE LINE WORK

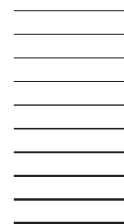
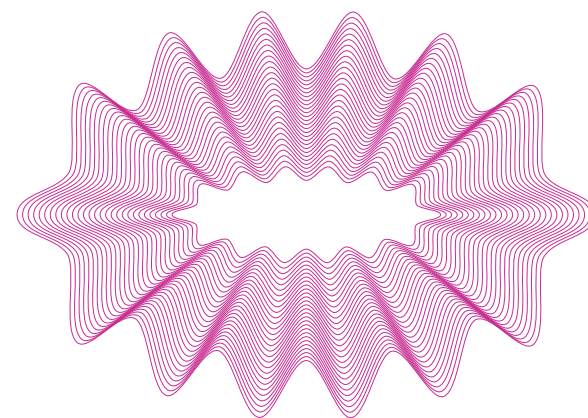
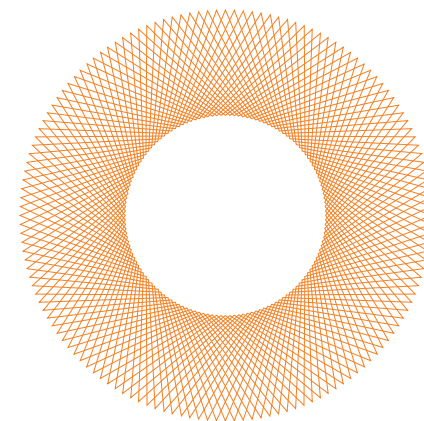
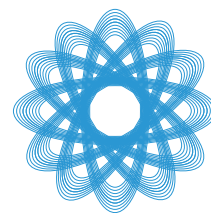
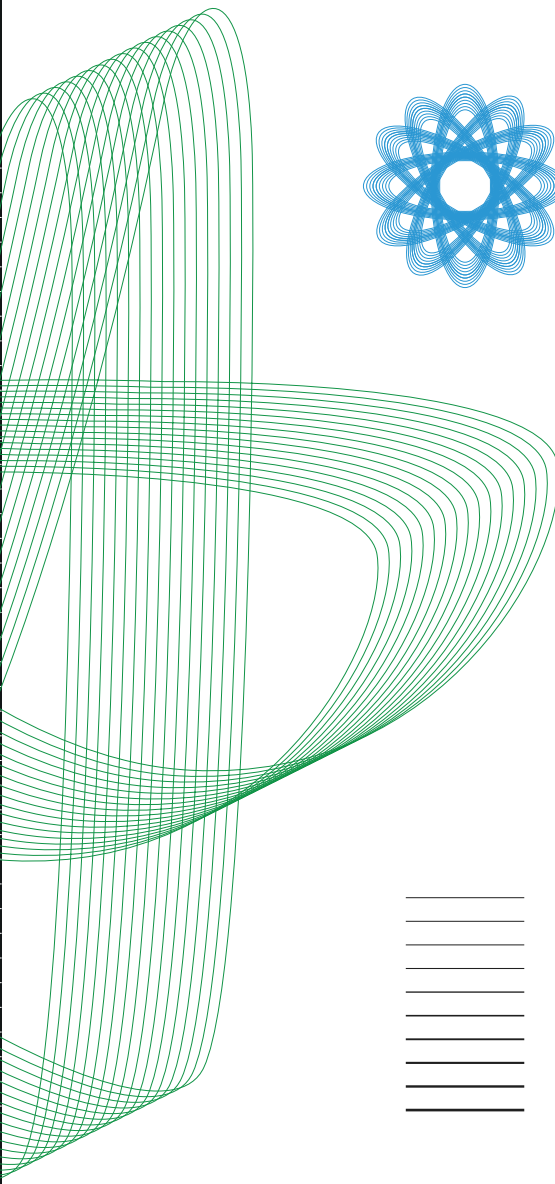

PERFECT FLESH TONES



ADVANCED ENGINEERING THAT FACILITATES STRATEGIC APPLICATIONS

Delivering the industry benchmark in quality, repeatability and reliability, the J Press 750S incorporates a highly reliable infeed, a completely re-engineered rapid drying section, full variable data capability and a simplistic operation eliminating the requirement for a highly skilled operator.



High-capacity and high-speed data server

The server is capable of transmitting variable data alongside printing output, facilitating efficient variable printing while maintaining the productivity of 3,600 sheets per hour.

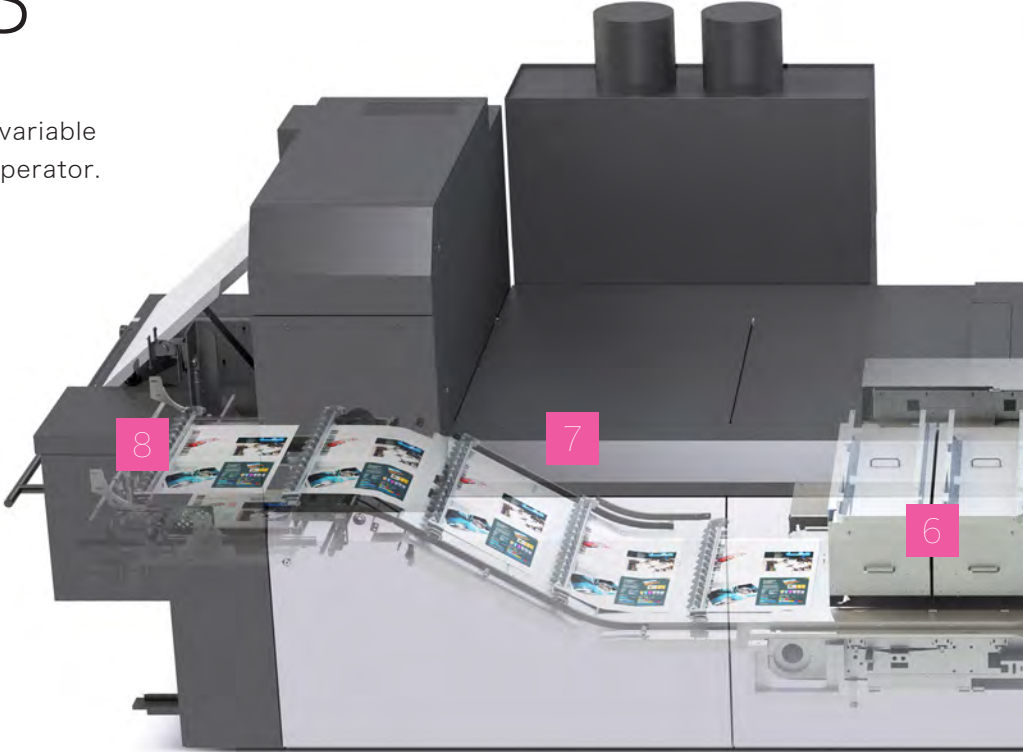

Sheet stacking

Printed sheets are sorted and stacked in the delivery area in the same way as a traditional offset press.



Paper cooling

Before printed sheets leave the press, they are cooled with fans for optimum sheet temperature and ink drying performance.



Paper drying

Printed sheets are fed onto an air suction conveyor with direct heat to ensure efficient drying.



Paper feeding

The J Press 750S uses the same paper-feeding mechanism as those used in sheet-fed offset presses assuring extremely high registration accuracy and reliable operation.

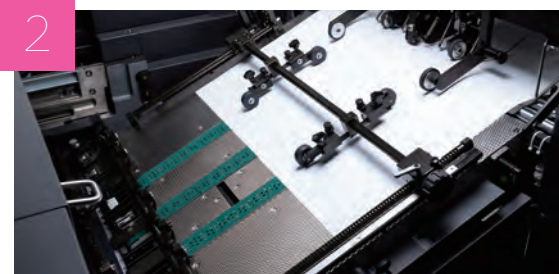

Variable data duplex output with barcode scanning

The J Press 750S brings efficient and highly accurate duplex variable data printing by printing a barcode in the non-image area of the front side that contains the data to be printed on the reverse side. This "Read and Pull" architecture guarantees 100% accuracy of the data to be printed on the reverse side eliminating the need for an Operator to inspect.



Paper preconditioning

A proprietary precoat technology is incorporated allowing for the use of standard coated and uncoated offset stocks. Each sheet of paper receives an ultra thin layer of Rapid Coagulating Primer (RCP) that works with Fujifilm's aqueous based pigment ink to achieve the vibrant images, pin sharp text and stunning flesh tones and gradients only J Press can deliver.



Real time nozzle correction

Every sheet is scanned by an in-line sensor (ILS) for real time nozzle correction as required ensuring each print job maintains quality from page one through the very last page.



Fujifilm Dimatix SAMBA printheads

The J Press 750S uses the latest generation of the industry benchmark Fujifilm Dimatix SAMBA™ printheads. SAMBA printhead arrays jet ink in a single pass over a vacuum jetting cylinder which significantly contributes to the stability of system.

QUALITY

Beautiful and vivid colors, smooth gradations and crisp drawing accuracy. The J Press 750S brings new added value to printing with its astonishingly high print quality that surpasses offset printing.



■ **Newest generation of SAMBA printheads delivers the industry's highest quality imaging performance**

For imaging, the J Press 750S employs the newest generation Fujifilm Dimatix SAMBA printhead with ultra-high density and advanced precision capabilities. While delivering high resolution 1200 x 1200 dpi native resolution and using Fujifilm's VersaDrop jetting technology for precision varying droplet size optimization, the latest generation SAMBA printhead is designed to achieve even greater image reproduction accuracy and jetting stability.



■ **Fujifilm VIVIDIA water-based ink provides an extended color gamut and vivid color reproduction**

The J Press 750S uses Fujifilm's VIVIDIA water based pigment inks achieving a color gamut well beyond that of other four-color printing platforms. VIVIDIA ink also looks and finishes like an offset print, even on uncoated stocks printing as a designer intended.

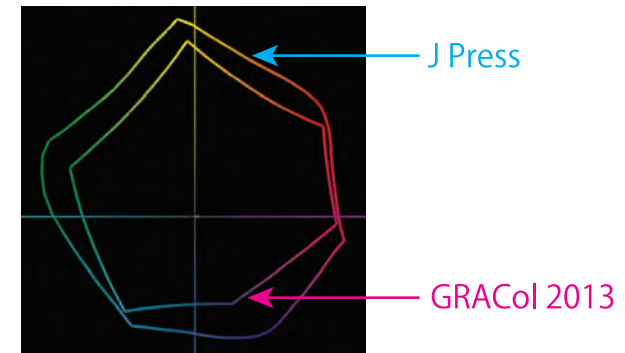

■ **Rapic technology for superb output to paper**

A precoat is applied to media immediately before printing. Fujifilm's proprietary precoat accepts each droplet of ink preventing "dot spread" or the bleeding of an ink droplet to those adjacent and mixing together. This proprietary technology allows ink droplets to be jetted at targeted locations to achieve the highest level of quality output and on a wide ranging and diverse selection of standard offset media.

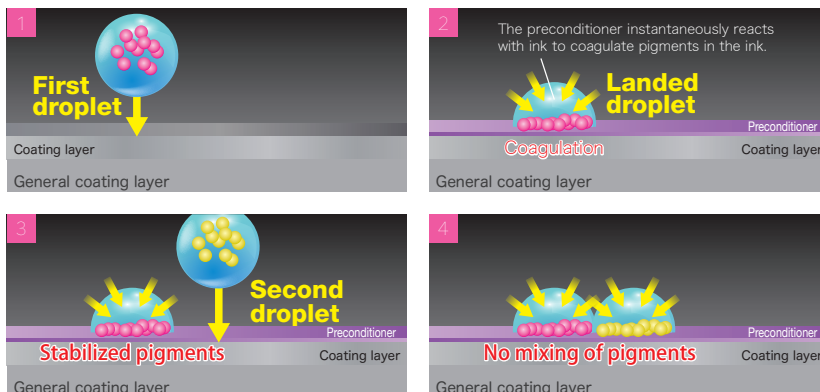

■ **Optional Full Sheet Scanning to reduce the potential of unseen defects**

The J Press 750S has the ability to scan the entire sheet, in real time, at a high level of accuracy to detect the smallest and most difficult to identify print defects. This option scans the entire print area and will detect "white lines caused by bent ink discharge", an issue difficult to identify with conventional systems. By automating this precision process, the J Press 750S can accurately identify and reject defective prints greatly reducing man-hours required for checking and sorting printed sheets.



PRODUCTIVITY

The newest generation SAMBA printheads working together with a fully re-engineered dryer system, enhances the output speed of the new J Press 750S to 3,600 sheets per hour, doubling the sellable output and allowing for even faster turnaround for all jobs.

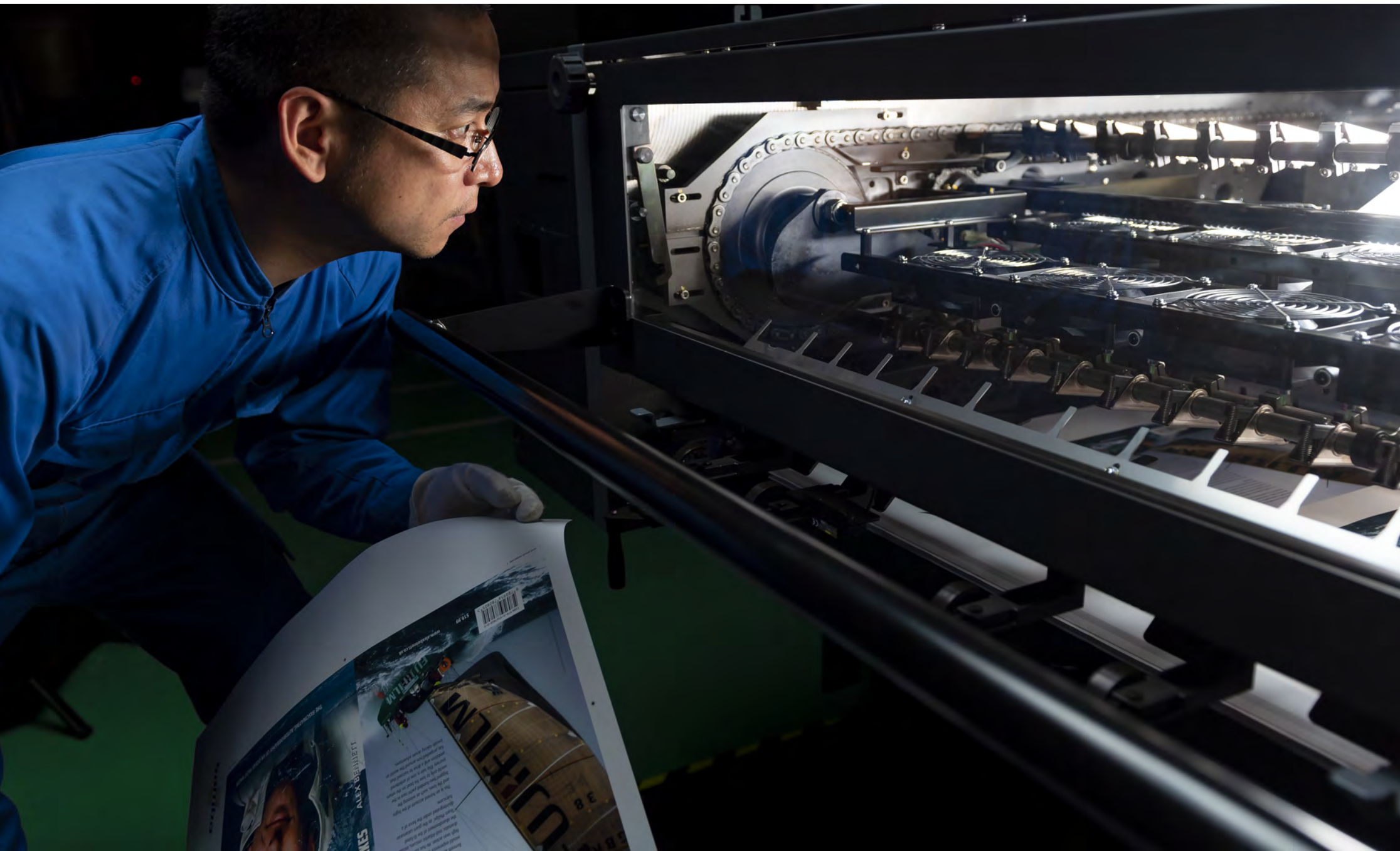

■ Single-pass system for outstanding productivity

Much like the previous generation J Press 720S, the J Press 750S incorporates a single pass jetting system in the direction of the paper feeding. This efficient design, along with the enhanced technologies of the J Press 750S, results in an output speed of 3,600 sheets per hour. With almost no set up printing required, the J Press 750S brings outstanding productivity for short run jobs and running multiple jobs in a single shift.



■ Increased jetting speed

The latest printheads used in the 750S are capable of faster ink-jetting due to enhanced driving frequency and improved driving waveforms. They can discharge ink droplets faster and at a shorter interval to boost not only printing speed but also jet location accuracy.

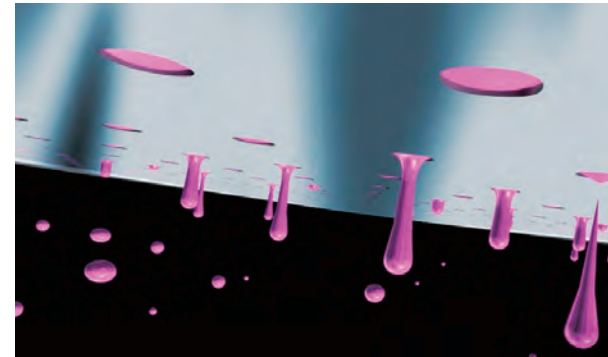

■ Quick and highly efficient dryer system

A completely re-engineered "contact drying" system is integrated in the J Press 750S where the printed sheets are fed onto a suction conveyor exposing the sheets to airflow and direct heat resulting in dramatically improved drying efficiency. This design contributes to the increased speeds but also has resulted in a slightly smaller overall footprint of the press as well as reducing the electrical consumption of the dryer unit.

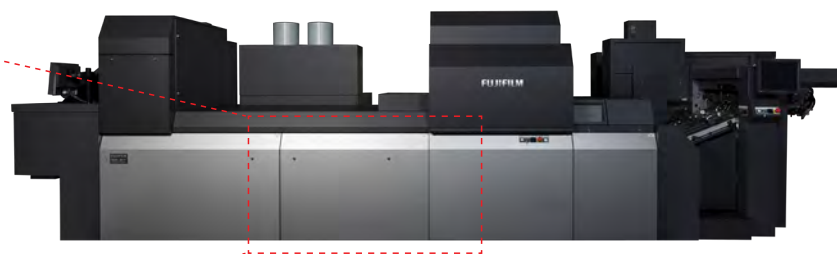
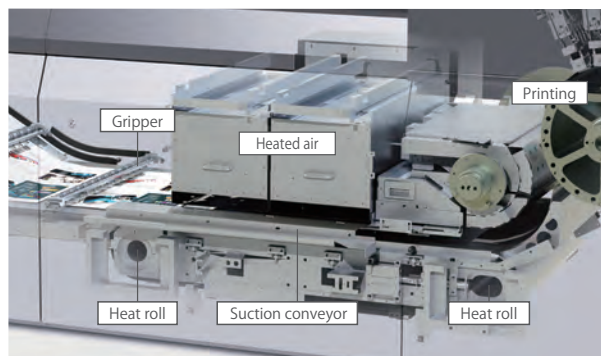

VERSATILITY

The flexibility of the J Press 750S is capable of accommodating a diverse range of jobs, stocks and stock thickness, making it a powerful weapon in the age of wide ranging applications and short-runs.



■ Larger sheet size and printable area to accommodate six letter size (585x 750mm) pages

The J Press 750S introduces a new larger sheet size of 23" x 29.5" (585mm x 750mm) which expands the maximum printable area allowing for a "6-up" imposition of letter size images. This increase over the previous generation J Press greatly enhances productivity and reduces the number of impressions required to complete a job.

Previous printable area (J Press 720S)

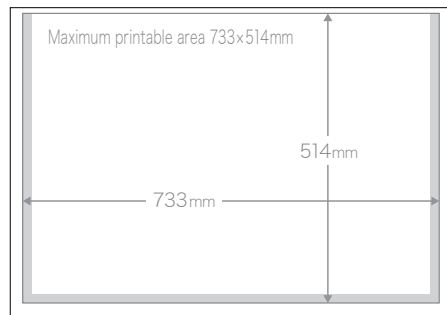

Paper size: 20.9" x 29.5" (532mm x 750mm)

J Press 750S

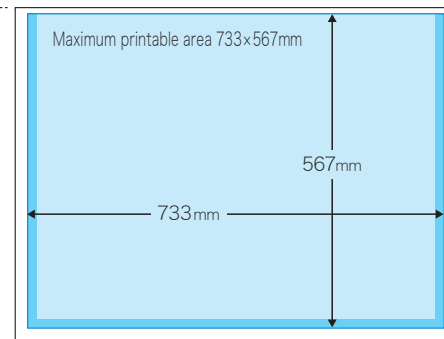

Paper size: 23" x 29.5" (585mm x 750mm)

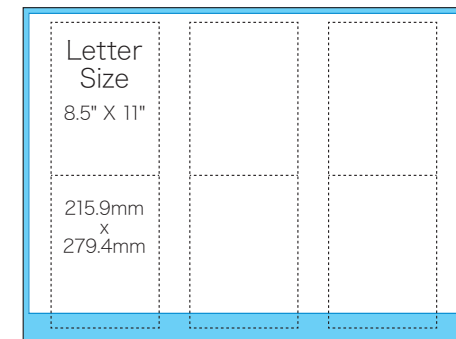

Previous printable area (light blue) J Press 750S (dark blue)



■ Broad paper compatibility for application versatility

The J Press 750S supports paper stocks from 60 lb. text up to 24 pt. board stock (0.07mm to 0.6mm) based on the press configuration. This flexibility and broad range means that the quality the J Press produces can be used on widely varying applications from marketing collateral and brochures using thin stocks to folding cartons requiring a heavier gauge board stock.



■ Workflow system that maximizes the 750S efficiencies

Fujifilm's XMF cross media workflow is ideally packaged to drive the J Press 750S due to its unprecedented productivity and native PDF print handling capabilities. In addition, XMF provides an intelligent job queue controlling all aspects of color management for the press automatically. Most of the time there will be no need to adjust color settings, with 100% color registration possible on the first printed sheet, but manual adjustments can be made where necessary.

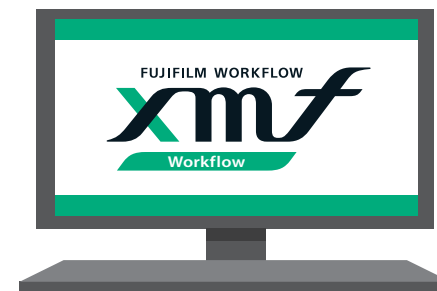

RELIABILITY

The J Press 750S has been designed on an offset platform to minimize downtime and allow for maximum performance at all times. The advanced technologies of the press, coupled with its robust design, help in expanding business opportunities and performing as a production workhorse.



■ Stable paper feeding and printhead protection

The 750S uses a gripper-based paper feeding system with an impression cylinder, widely used in sheet-fed offset presses, to achieve stable paper-feeding and excellent registration accuracy. It maintains the highest level of print quality from start to finish. If part of a sheet floats off the cylinder, the unique "Active Head Retraction System" is activated to protect printheads while minimizing mechanical downtime.

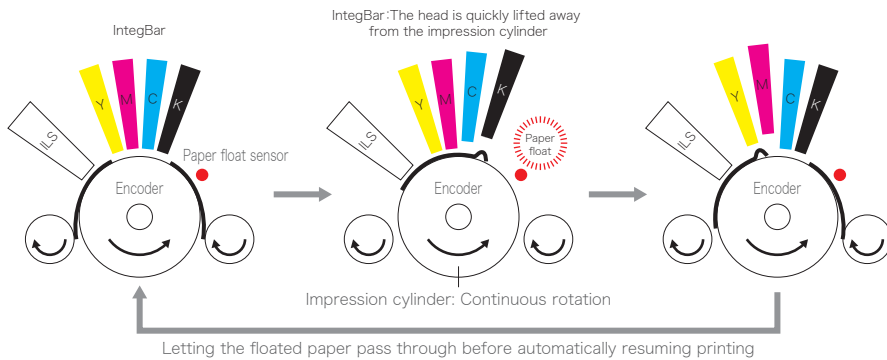

■ Outstanding environmental performance

The 750S has been awarded the highest "three stars" rating in the Green Printing (GP) certification program by the Japan Federation of Printing Industries. Its inks and preconditioner comply with the Japan Printing Ink Makers Association's Voluntary Regulations concerning Printing Inks (NL Regulations).



TECHNICAL SPECIFICATIONS

Fujifilm J Press 750S
Production Inkjet Printing Press

PRINTING	
Printheads	Fujifilm Dimatix SAMBA™ printheads
Printing Resolution	Native 1200 x 1200 dpi, 4 level grayscale
Productivity	3600 sheets per hour (static and variable)
Workflow	Fujifilm XMF
Variable Data	Barcode read & pull, rated speed
Country of Origin	Japan
SUBSTRATE	
Maximum Sheet Size	23" X 29.5" (585mm X 750mm)
Paper Thickness, Standard	Single sided: 60 lb. text to 110 lb. cover/3 pt. to 14 pt.* Double sided: 80 lb. text to 110 lb. cover/6 pt. to 14 pt.*
Paper Thickness, Heavy	8 pt. to 24 pt. board stock (.23mm to .54 mm)*
Paper Type	Standard offset stock, coated and uncoated*
INKS,PRIMER AND WASH	
Ink	Fujifilm VIVIDIA aqueous based pigment (CMYK)
Primer	Fujifilm RAPIC (Rapid Pigment Coagulation)
Wash	Nozzle cleaner and Inkjet head cleaner
Carton Size	10 liter
Shelf Life	2 years from date of manufacture
Country of Origin	Japan
PHYSICAL	
Machine Size	(L)24'1" X (W)8'8" X (H)6'8" / (L)7.35m X (W)2.65m X (H)2.05m
Installation Area	36' X 17' / (10.8m X 5.1m)
Power Requirements	285A/200 – 230VAC

* Paper thickness are guidelines and performance will vary and is dependent upon the mill, paper type, paper grain and paper stiffness among other possible factors. Fujifilm recommends complete testing of all media prior to use.

FUJIFILM

FUJIFILM Corporation

Specifications are subject to change without notice.
※This brochure was printed on the Fujifilm J Press

