

# The KaVo Advantage

Your guide to KaVo innovations

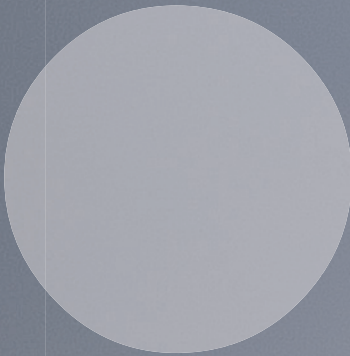

KaVo. Dental Excellence.

# KaVo Innovation

## Over a Century of Dental Excellence

Innovation and quality are traditions that have kept KaVo at the forefront of the dental industry for more than 100 years. The company was founded in 1909 by Alois Kaltenbach in Berlin-Steglitz. It became known as Kaltenbach & Voigt (KaVo) when Richard Voigt joined the company in 1919 and is now a trusted partner for dentists and dental technicians worldwide.

KaVo's continued commitment to advancing dental technology for the betterment of your practice drives us every day. It is innovation and our passion for quality that has fueled our steady growth and world-wide recognition. You can see the outcome in our revolutionary new products, such as the COMFORTdrive™, DIAGNOdent™, MASTERtorque™, and innovative programs such as TryKaVo.com. We believe these products, and our entire portfolio, are the best in the industry and we encourage you to experience KaVo for yourself.





In 1909 KaVo is founded by Alois Kaltenbach and in 1919 Richard Voigt joins the company.



In 1928, the first sterilizable handpiece is created by KaVo.

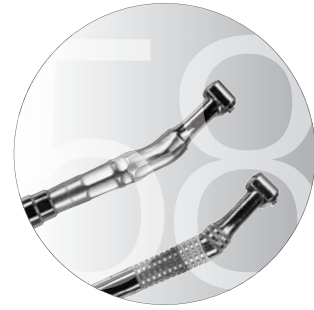

In 1958 KaVo launches its first turbine called Borden-Air 60.

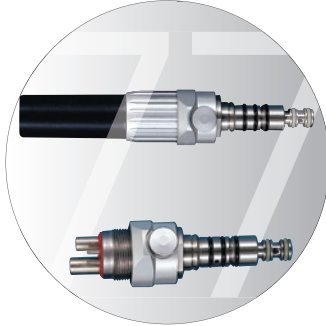

In 1977 the KaVo MULTIFlex™ is the first quick-release coupling.



In 1982 KaVo integrates the first light conductors into turbines.



In 2000 KaVo introduces the revolutionary DIAGNOdent, a caries detection aid.

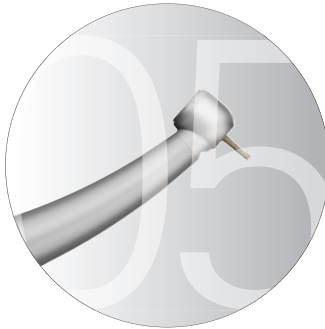

In 2005, KaVo introduces GENTLESilence™ LUX 6500 B – one of the quietest turbines in the world.



In 2008 KaVo introduces the GENTLEmini™ LUX 4500 B, a mini head, mighty power handpiece. Also launched is the GENTLERay™ 980 Premium Soft Tissue Diode Laser, the first diode laser with micro-pulsing power.

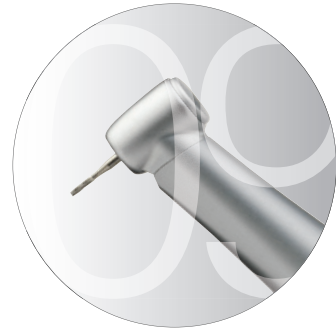

In 2009 KaVo celebrates 100 years of serving the dental industry, joining Pelton & Crane with 110 years of providing dental excellence. KaVo introduces the COMFORTdrive™ - KaVo's most innovative High-speed.



In 2012 KaVo introduces INTRAmatic LUX™ KL703 Short Motor, one of the shortest and lightest motors.



In 2014 KaVo introduces the MASTERtorque™ M8900 L, one of world's most powerful and advanced High-speed turbines. KaVo also introduces the new surgical portfolio featuring the MASTERSurg and EXPERTSurg – simple and intuitive surgical motors, redefining the best.



In 2015, KaVo introduces the MASTERtorque™ M8700 L with the advanced technology of the M8900 L in a mini head. Also launched is the MASTERmatic™ Series, featuring significant improvements in head size without compromising power and performance.





Introducing the

# KaVo MASTERmatic™ Series

## Innovation Changes Everything



### BEST VISIBILITY

20% smaller head with 100% power\*

### EXCEPTIONAL ACCESS

KaVo's patented 100°/19° head and knee angle combination

### REDUCED VIBRATION

With KaVo's exclusive Triple Gear Technology

### IMPROVED VERSATILITY

Introducing the MASTERmatic M05 L Mini High-speed handpiece. 43% smaller head with 100% of the power\*, for standard length and short shank burs

\*Compared to GENTLEpower 25LPR



Introducing the

# KaVo MASTERtorque™ Series

The Best Gets Better



## Superlative Performance

### MORE POWER

23 watts peak power for approx. 20% more torque\*.

### HIGHER PRECISION

Computer balanced turbine, carbide lined chuck for more concentric cutting and smoother, more precise preps.

### REDUCED RUNNING NOISE

Effective frequency optimization ensures a pleasant turbine noise and low noise levels of only 57 dB.

### AVAILABLE IN MINI HEAD

The new M8700 L is KaVo's quietest mini head High-speed at 59 dB, has 11% more power (compared to the 4500BR) at 19 Watts, and NEW Direct Stop Technology (DST).

\*Compared to KaVo's GENTLEsilence 6500BR

\*19W for approx. 11% more torque at 59dB for Mini Head



KaVo. Dental Excellence.

# Electric Collections











## Master, Expert and Smart Series

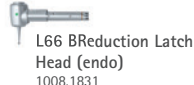
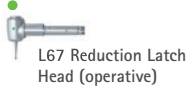
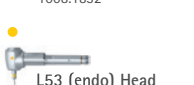

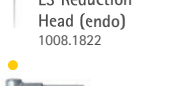
# Master Series

The Pinnacle of KaVo Innovation.

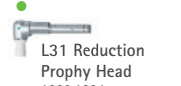
## INTRA LUX™ Heads

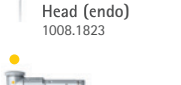
-  L80 Friction Grip Head (operative) 1004.4456
-  L52 Mini Latch Head 1008.1825
-  L66 BReduction Latch Head (endo) 1008.1831
-  L67 Reduction Latch Head (operative) 1008.1832
-  L53 (endo) Head 1008.1826
-  L3 Reduction Head (endo) 1008.1822
-  L61 G (endo) Head 1008.1828
-  L68 B Latch Head (operative) 1008.1834
-  L62 Reduction Latch Head (endo) 1008.1830
-  L31 Reduction Prophy Head 1008.1824
-  L3 Y Reduction Head (endo) 1008.1823
-  L61 R (endo) Head 1008.1829
-  L22 (micro) Head 1008.1835

Color Key  
 ● Blue = 1:1    ● Green = Reduction    ● Yellow = Specialty

## MASTERmatic™ Attachments

-  M25 L High-speed Attachment 1009.3630
-  M05 L Mini High-speed Attachment 1009.3640
-  M20 L Contra Angle Attachment 1009.3620
-  M07 L Contra Angle Attachment 1009.3610
-  M29 L Contra Angle Attachment 1009.3580
-  M10 L Straight Attachment 1009.3570
-  COMFORTdrive 200 XDR 1007.3570

## ELECTROtorque™ Systems

**ELECTROtorque TLC Torque Limit Control LUX with KL703 Brushless Electric Motor Kit**  
1003.5840









**COMFORTdrive Drive Full Operatory Package**  
1007.4682

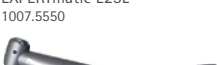

# Expert Series

Superior KaVo Performance.

## EXPERTmatic™ Attachments

- Optic**
-  EXPERTmatic E25L 1007.5550
-  EXPERTmatic E20L 1007.5540
-  EXPERTmatic E15L 1007.5530
- Non-Optic**
-  EXPERTmatic E25C 1007.5551
-  EXPERTmatic E20C 1007.5541
-  EXPERTmatic E15C 1007.5531
-  EXPERTmatic E31C 1008.4998
-  EXPERTmatic E61C 1008.4999
-  EXPERTmatic E10C 1007.5560

## ELECTROtorque Systems

**ELECTROtorque plus LUX with KL703 Brushless Electric Motor Kit**  
1002.5015

To be used with air or electric motor with "E" type connection

**INTRAmatic™ 23ES**  
1004.5380

**INTRAmatic 80ES**  
1004.4375

**INTRAmatic 19ES**  
1004.4503

To be used with any air or electric motor with "E" type connection (181L, 181H, ELECTROtorque plus, ELECTROtorque TLC)



# Smart Series

Reliable and Affordable KaVo Technology.



# Electric Collections

## Master, Expert and Smart Series



High-speed

### Master Series

The Pinnacle of  
KaVo Innovation.

Featuring the new  
MASTERmatic M25 L and  
MASTERmatic M05 L Mini  
High-speeds, KaVo's most  
innovative High-speeds  
ever. Also featuring the  
COMFORTdrive 200 XDR.

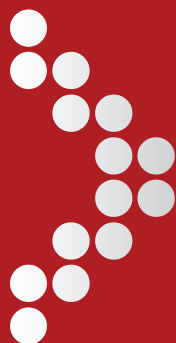

High-speed

### Expert Series

Superior KaVo Performance.

Featuring the new  
EXPERTmatic E25L High-  
speed. Fast and precise  
working thanks to an even  
smaller head, snap-on  
facility and ceramic bearings.





High-speed

Smart Series

Reliable and Affordable  
KaVo Technology.

The KaVo Smart Series High-speed instruments are redesigned with a new surface finish for a perfect grip and no rough edges. Seamless stainless steel profile means there's no where for debris to accumulate and the push-button chuck is standard.



Low-speed

Smart Series

Reliable and Affordable  
KaVo Technology.

The KaVo Smart Series Low-speed instruments can be thermally disinfected and sterilized in autoclaves at temperatures of up to 275°F and can also be washed in the thermodisinfectant. Durable hygienic coating with textured surface for easy grip.



## ELECTROtorque TLC with KL703 LED Motor Master Series



Featuring the new KL703 brushless electric motor for ALL your High-speed, Low-speed and torque control endodontic needs.



### Electric Handpieces

Featuring the MASTERmatic M25 L High-speed, M20L attachment and INTRA LUX heads for a wide range of applications.

## ELECTROtorque Plus with KL703 LED Motor Expert Series



Superior power & torque featuring the KL703 - one of the shortest and lightest electric motors with exclusive SAFEdrive and MULTI LED™ Light.



### Electric Handpieces

Featuring the new EXPERTmatic E25 L High-speed with ceramic bearings and INTRAcompact handpieces with integrated Low-speed heads.



### KL703 LED Short Motor.

KL703 LED Short Motor is 30% lighter and 25% shorter than market leading electrics. Works with all universal E-style attachments. Has field replaceable LED, anti-retraction valve to prevent suck-back of contaminated water, and spray regulation for optimal cooling.

# INTRA LUX Heads Master Series



Invest in just a single contra-angle handpiece. Our broad range of INTRA LUX heads offers you a comprehensive set of options for all applications.

## Versatility at hand

- Maximally ergonomic – the particularly small heads offer an optimum view of the workspace.
- Simply safe – all heads can be sterilized and can be thermally disinfected at up to 135 °C.
- Maximum efficiency – in daily use, the KaVo INTRA LUX heads are time-saving, durable, flexible and economical. Thus unnecessary investments for inflexible complete instruments are superfluous. After long-term use, you can replace just the head and continue to use the shank. You need a new dental instrument for a new application? No problem – this case too, all you have to do is to invest in a new head.

### Color Key

● Blue = 1:1 ● Green = Reduction ● Yellow = Specialty



KaVo. Dental Excellence.

# Air Collections

## Master, Expert and Smart Series



High-speed

### Master Series

The Pinnacle of  
KaVo Innovation.

Featuring the new  
MASTERtorque handpiece  
– the best just got better  
with unique Direct Stop  
Technology for improved  
bur control and reduced  
drawback of contamination.  
Now with even higher power  
and same low noise level for  
the highest treatment quality  
and patient comfort.

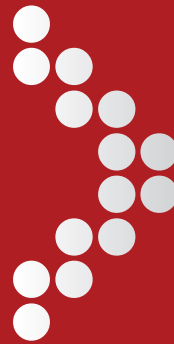

High-speed

### Expert Series

Superior KaVo Performance.

Featuring the new  
EXPERTtorque E679 L standard  
head and E675 L mini head  
handpieces with new innovative  
design and EXPERTgrip.





High-speed

Smart Series

Reliable and Affordable  
KaVo Technology.

Featuring the new  
SMARTtorque S619 L  
standard head and S615 L  
mini head handpiece with  
new ergonomic design and  
legendary KaVo durability.



Low-speed

Smart Series

Reliable and Affordable  
KaVo Technology.

The KaVo Smart Series  
INTRAmatic E Air Motor  
Low-speed Handpieces  
have a number of  
straightforward options  
designed around  
preferences and intended  
clinical application.  
Simply choose the  
motor, attachment and  
head. You have all of the  
options at your fingertips.



# Air Collections

## Master, Expert and Smart Series

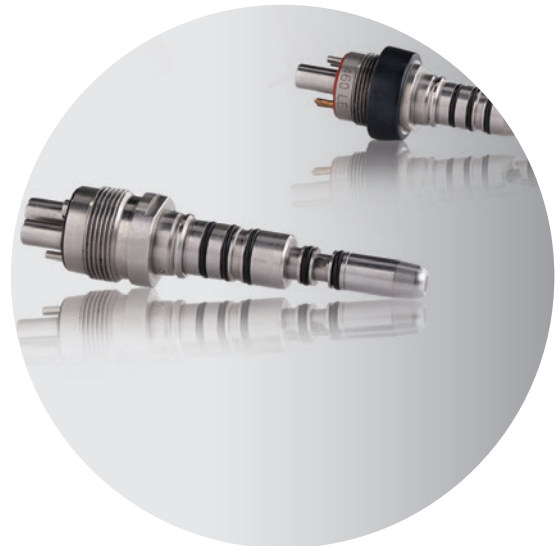
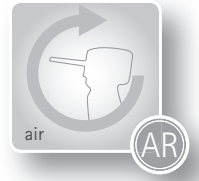

**Master Series**

The Pinnacle of KaVo Innovation.



**Expert Series**

Superior KaVo Performance.



**Smart Series**

Reliable and Affordable KaVo Technology.

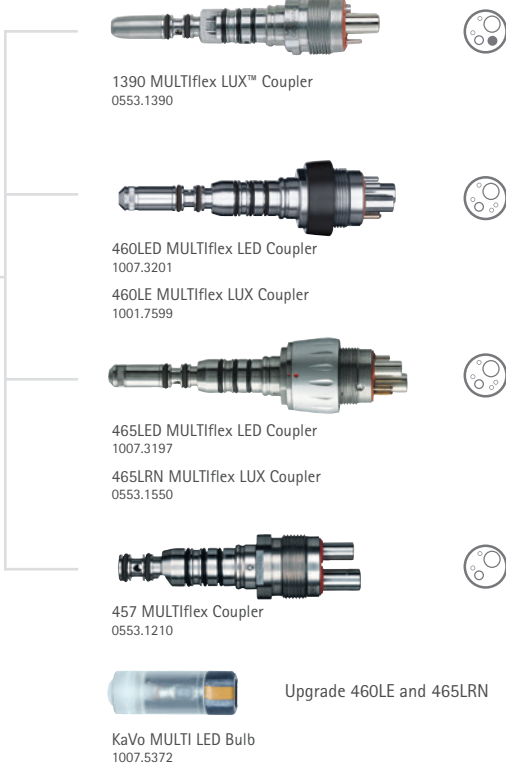

# Air Collections

## Low-speed Air Systems

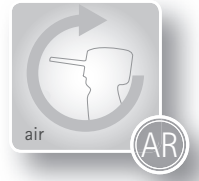

## Smart Series

Reliable and Affordable KaVo Technology.



20E Low-speed Handpiece  
1003.1107



19E Hygiene  
1004.6403  
0201.0116 - Screw for Prophyl Angle



10E Low-speed Handpiece  
1003.6977

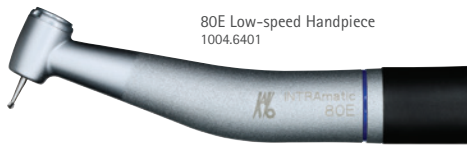

80E Low-speed Handpiece  
1004.6401



14E INTRAmatic Contra Angle  
1003.1108



31E Low-speed Handpiece  
1003.6976  
1004.0596 - Holder Tool

## Master Series

The Pinnacle of KaVo Innovation.



181H INTRA™ LUX Air Motor  
0535.5210  
For E-style attachments.

## Expert Series

Superior KaVo Performance.



181H INTRA Air Motor  
0535.5200  
For E-style attachments.

## Smart Series

Reliable and Affordable KaVo Technology.



181K Air Motor  
0535.5260  
For INTRAmatic attachments.



# QUATTROcare™ Plus Maintenance System



# Protect Your Investment The QUATTROcare Plus

## Easy to use

The user-friendly QUATTROcare Plus system is designed to clean, lubricate and purge your instruments with the simple push of a button. Loading and operation is easy as well as the automatic care and maintenance procedure.

## Safe controlled cleaning

Reduce errors with visual and audio signals during the completely controlled cleaning and purging procedure. With a front-loading enclosed maintenance chamber, the entire process is hygienic and thus eliminates mishandling or insufficient care and maintenance.

## Economical investment

Using the QUATTROcare Plus system means less wear, less repairs, less staff down time, smoother operation, and increased longevity of your handpieces – what an excellent return on investment! The QUATTROcare Plus can be used for virtually all manufacturers' High-speeds, Low-speed contra-angles, straight handpieces, air driven scalars, and air motors.

## Fast cleaning cycle

Up to four (4) handpieces or air motors are cleaned, lubricated and purged in the same cycle. The care and maintenance of one complete set of handpieces in the same cycle is possible which means there's no need to change adapters between High-speed and Low-speed attachments. Flexible programming allows you to choose and set total cycle time from 20-45 seconds per handpiece. Handpieces can be sterilized immediately after maintenance cycle; there is no need for separate purging of the handpiece.

## Chuck care maintenance

New chuck care system provides easy maintenance of handpiece chuck.

Easy As...



1

Position the instruments...



2

... close the door ...



3

... press Start and everything is DONE.



4

Chuck care



KaVo. Dental Excellence.

# HYGIENE 360°

## Everything Easy. Everything KaVo.

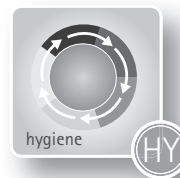

KaVo Hygiene 360° is a complete solution which helps you provide your patients with great dental care. Start the 360° cycle with the SONICflex™ Scaler for scaling, then PROPHYflex™ for tooth cleaning, PROPHYwiz™ for tooth polishing, and DIAGNOdent for caries and sub-gingival calculus detection. Complete your hygiene workflow by using a stool that properly supports you ergonomically.

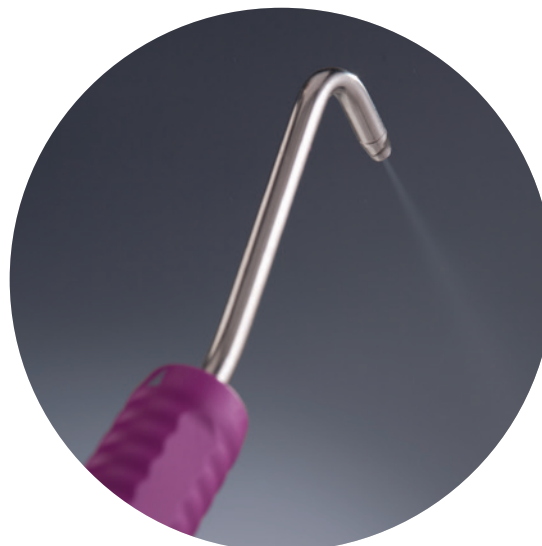
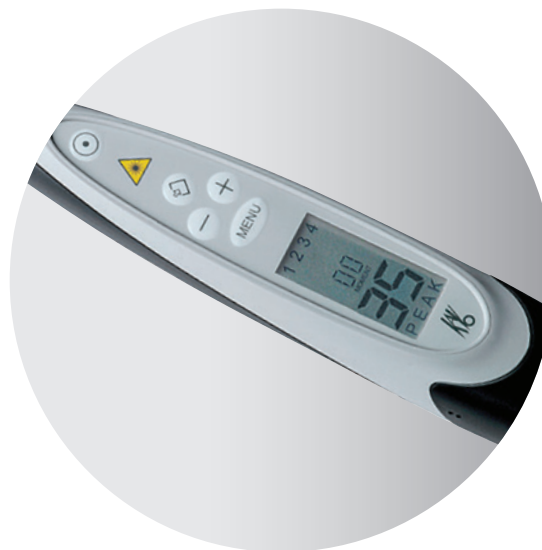



### Step 1 Scaling

**Difficult stains?**  
The problem is solved so easily.

Both thorough and gentle at the same time.

Your hygiene treatment center takes difficult cases in it's stride. Tenacious calculus requires thorough, yet gentle removal. One of the most powerful scalers in its class – The KaVo SONICflex Quick 2008L easily conquers tough challenges.



KaVo SONICflex quick  
2008L



### Step 2 Tooth Cleaning

**Just conjure up a smile for the face.**

Your patients see success immediately.

The next step is about preventing caries, periodontitis and gingivitis. The main causes of these oral indicators, such as biofilm, deposits from smoking and discolorations from coffee and tea can be easily removed with the KaVo 2018 PROPHYflex 3 air polishing device.



KaVo 2018 PROPHYflex 3



### Step 3 Tooth Polishing

**You've got the skills and technology to maintain healthy dental enamel.**

Uncompromising outcome, means everything works great.

For a great finish to every professional tooth cleaning, the final polish and seal of the enamel is essential. KaVo offers the right tool for all indications, in each price segment.



KaVo PROPHYwiz



### Step 4 Caries Detection

**Your aid in detection of caries.**

The DIAGNOdent pen will show you where the decay lies.

It works quickly and reliably. The laser fluorescence detector within the DIAGNOdent pen, is a precise method for identifying fissure caries, proximal caries and periodontitis (with the Perio probe). A virtually unbeatable method with a 90% success rate. The wireless display ensures additional comfort, with a large status and measurement display.



KaVo DIAGNOdent pen +  
Display



### Step 5 Workflow Integration

**Your comfort is of the utmost importance.**

With adjustable levers at your finger tips proper positioning is easy. Stay seated and on task during patient appointments.



Hygienist Stool



# Step 1 - Scaling SONICflex System

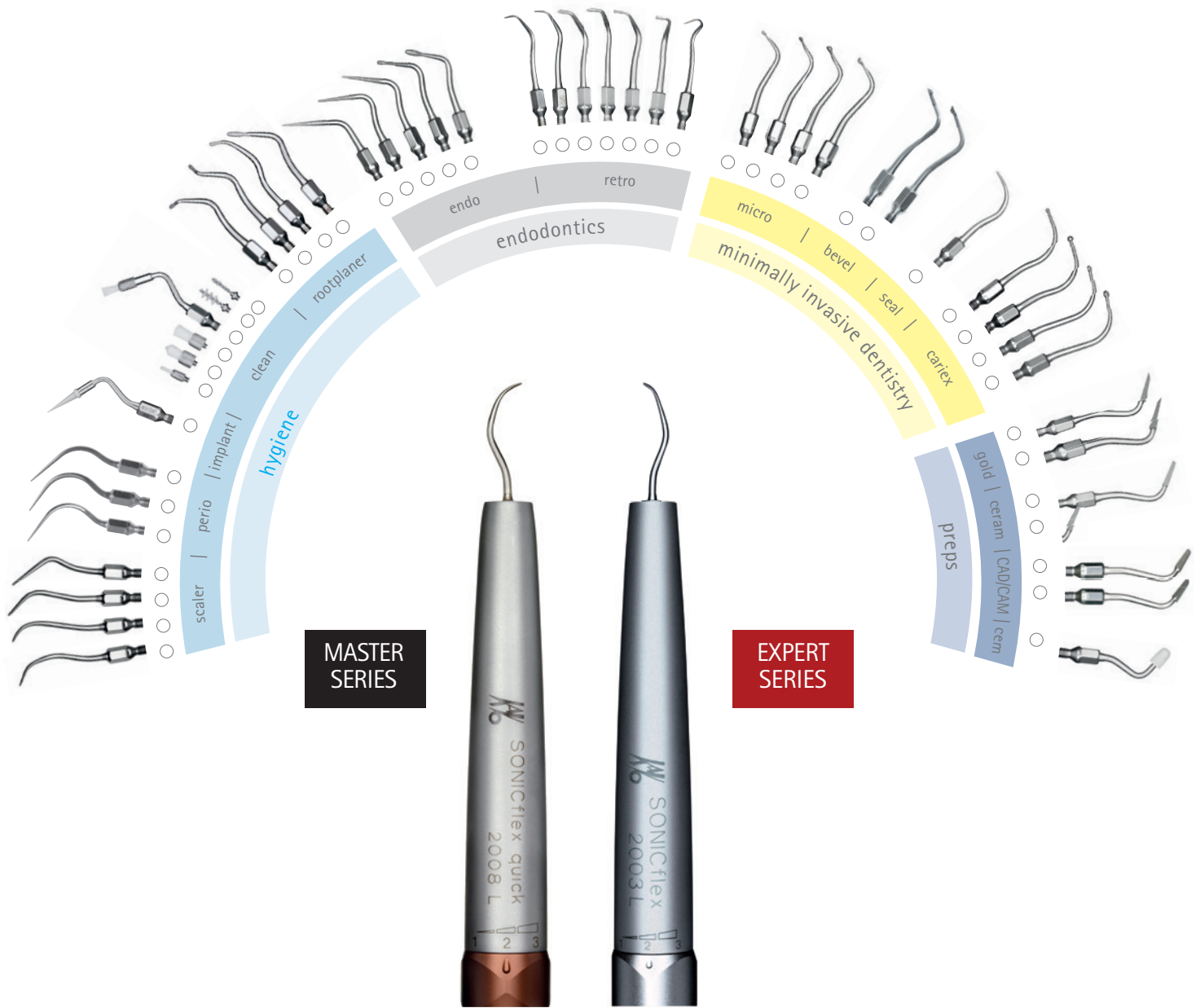

## The right fit for every use.

The wide range of options offered by the SONICflex will soon make it one of your most-used instruments. Choose the right tip for your needs from the wide range of types.

Numerous possibilities – main features and advantages for you:

- More tips and more uses than any other air drive system
- Over 50 different tips
- For every application
- Ensuring successful minimally invasive treatment



## Step 2 - Tooth Cleaning PROPHYflex 3

### PROPHYflex 3

The KaVo PROPHYflex 3 portable air cleaning system that is effective and easy to use. Simply connect the handpiece to the MULTIflex coupler for a quick disconnect and optimal portability. When the rheostat is depressed, air flows directly to the powder chamber. The air mixes with the powder and flows to the end of the tip. At the same time, water - strictly separated from the air/powder mixture - exits the tip. There, the water surrounds the powder/air mixture. Two non-return valves prevent water from flowing back towards the MULTIflex coupler.

### PROPHYpearls™ Cleaning Powder

The PROPHYpearls roll away stains, plaque and calculus accurately, gently and powerfully. As they optimize cleaning performance, they are gentler to sound tooth structure, thereby avoiding surface damage. This advanced calcium carbonate powder provides for faster cleaning and is suitable for PROPHYflex 2 and 3 - as well as all other manufacturers' air polishing systems. Equipment won't clog since there is no chemical reaction to air humidity, and your patients appreciate the non-salty taste.



KaVo. Dental Excellence.

## Step 3 - Tooth Polishing PROPHYwiz



### PROPHYwiz

If you would like the most comfortable polishing handpiece to maximize productivity and make polishing easier and more enjoyable, this is the right choice for you. The handpiece runs smoothly and quietly to optimize patient comfort. There is no need for a coupler or additional motor, providing an affordable and easy integration experience.

### 181K Air Motor

Perform all your Low-speed hygiene needs with the versatile 181 K motor. One of the best E-type air driven motor on the market, the 181K is smooth from 0 to 20,000 rpm. Compatible with Kavo and other E-type speed increasing and reducing contra angles. Standard 4-hole connection. Forward/reverse speed and directional adjustment. Sterilizable. Kavo 181K operates well at an air pressure range of 36-43.

### 19 E and 31 E Low-speed Hygiene Handpiece.

High Performing systems for Low-speed applications. KaVo's 31 E, and 19 E are easy to use ergonomic and lightweight handpieces for all your prophylaxis needs. The durable hygienic coating with textured surface allow for better handling and performance.





## Step 4 - Caries Detection DIAGNOdent

### How the DIAGNOdent Works

The DIAGNOdent measures laser fluorescence within the tooth structure. As the incident laser light is dispersed into the site, carious tooth structure will exhibit fluorescence, proportionate to the degree of caries, resulting in elevated scale readings on the display. Clean healthy tooth structure exhibits little or no fluorescence and will result in very low scale readings on the display.

### A Changing Caries Model

Due to fluoridation, caries have gone "underground". Dentists regularly ask the questions - Should the tooth be opened up? What if no caries are found? Should the tooth just be watched, or does that give caries more time to destroy the tooth's surface?

### Proven Clinical Results

Treatment decisions require a higher degree of certainty. The DIAGNOdent laser caries detection aid removes the doubt from treatment decisions regarding hidden caries or questionable stained grooves. The device's ability to see into occlusal pits and fissures enables dentists to treat subsurface carious lesions with confidence.



\*DIAGNOdent Classic not available in Canada



KaVo. Dental Excellence.

# Surgical Systems

## Driven to Precision



The New KaVo Surgical Portfolio redefines the best. They are simple, intuitive and easy to use with large color screens and pictorial guides for step-by-step procedures. The units can be used for all surgical applications and offer intelligent power and precise torque. KaVo redefines the best with the MASTERSurg™ and EXPERTSurg™.

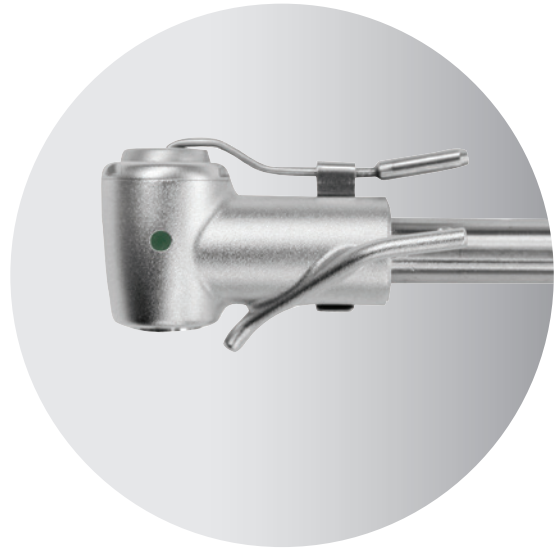

# Surgical Handpieces and Accessories Driven to Precision



KaVo SURGmatic™ handpiece 1:1  
S11L Part No. 1009.1010  
S11C Part No. 1009.1005



Handpiece not included with MASTERsurg

MASTERsurg  
Part No. 1009.1200



Cellular Optic Attachments for Oral Surgery  
and Implantology  
CL 10 Straight Attachment  
Part No. 1002.0911



3610N1 Straight Attachment  
Part No. 0524.5600



3610N2 Surgical Straight Attachment  
Part No. 0524.5610



3610N3 Surgical Straight Attachment  
Part No. 0524.5620



KaVo SURGmatic contra-angle 20:1  
S201 L Part No. 1009.0470  
S201 XL Part No. 1010.2332  
S201 C Part No. 1009.1100  
S201 XC Part No. 1010.2333



Handpiece not included with EXPERTsurg

EXPERTsurg  
Part No. 1008.3500



Cellular Optic Attachments for Oral Surgery  
and Implantology  
CL 3-09 Contra Angle Attachment  
Part No. 1002.3693



CL 09 Cellular Optic Contra Angle Attachment  
Part No. 1001.9258



C 09 Contra Angle Attachment  
Part No. 1001.2278



3620N Contra Angle Attachment  
Part No. 0534.5650



3624N Contra Angle Attachment  
Part No. 0534.5660



3630N Contra Angle Attachment  
Part No. 0534.5670



67RIC Reduction Latch Head for Internally Cooled Burs  
Part No. 0540.8340



C3 Reduction Latch Head for Internally Cooled Burs  
Part No. 1001.4503



CL 3 Reduction Latch Head  
Part No. 1001.8993



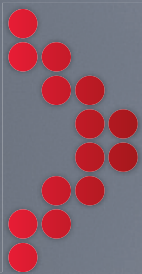

# TryKaVo.com

## Try the Best Handpieces, Risk Free



Step 1.  
**CHOOSE**



Choose a handpiece from our collections listed

Step 2.  
**TRY**



Try a handpiece risk free for 5 business days

Step 3.  
**RETURN**



After 5 day trial, return the handpiece. Like it, buy it. Contact 1-877-746-3995



Go to **TRYKAVO.COM** to start your free and easy trial today!

KaVo Dental Corporation  
11729 Fruehauf Drive  
Charlotte, NC 28273  
888.ASK.KAVO (888.275.5286)  
Fax 704.927.0816  
www.kavousa.com



KaVo. Dental Excellence.