

Connect 4G

Cellular Signal Booster

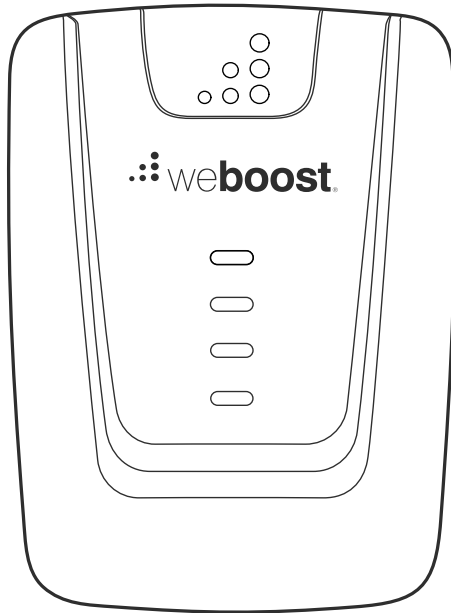

User Manual

NEED HELP?



support.weboost.com



866.294.1660

Index

Package Contents 1

STEP 1: Preparation 2

STEP 2: Find The dBm Reading On Your Phone 3

STEP 3: Measure Signal Strength For Inside Antenna 4

STEP 4: Measure Signal Strength For Outside Antenna 5

STEP 5: Temporarily Mount The Outside Antenna 6

STEP 6: Connect The System 7

STEP 7: Compare Results 8

STEP 8: Permanently Mount The Outside Antenna 9

STEP 9: Permanently Mount The Inside Antenna 11

STEP 10: Route & Secure The Cable 12

Test System: Lights 13

Specifications 15

Safety Guidelines 16

Warranty 18

Package Contents



Connect 4G



Inside Antenna

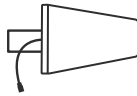

Outside Antenna



2x Coax Cables

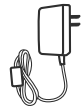

Power Supply



Window Entry Cable



2x Pole Mount Bracket



Wall Mount Bracket



This device may be operated **ONLY** in a fixed location for in-building use. The signal booster unit is designed for use in an indoor, temperature controlled environment (< 100 degrees Fahrenheit)

Step 1: Preparation

You Will Need (tools not included)

Make sure the following materials are prepared and ready for your installation.



3 to 4 hours



2 people (a person to help with antenna calibration)



- Ladder
- Phillips-head screwdriver
- 10mm open-end wrench or adjustable wrench
- Drill (*if routing cable through wall*)
- Mounting Option A:** 1-2" diameter pole (#901117) or an existing pole
- Recommended:** Power Strip

NOTE: These instructions will walk you through a “soft” install process to find the optimal locations for the inside and outside antennas, then through the process of the permanent installation.

Step 2: Find The dBm Reading On Your Phone

iPhone®

Dial *3001#12345#* then press Call.

Hold down power button until you see “Slide to Power Off” **then release the power button.**

Hold the Home button until your main screen appears.

If you want to check 3G/1x but your iPhone is picking up 4G/LTE signal, go to Settings>Cellular>Cellular Data Options>Enable LTE>Select Off

Android™

Settings > About Phone > Status or Network > Signal Strength or Network Type and Strength (exact options/wording depends on phone model).

iPhone is a registered trademark of Apple Inc. Android is a trademark of Google Inc.

All Other Phones & Alternate Methods

- <https://www.weboost.com/test-mode-instructions/>

All Phones:

- Keep track of the network (3G or 4G) phone is connected to.
- Any signal readings you take are valid for that phone's carrier. To get readings from other carriers, you'll need phones from each carrier.
- When system is set-up, you can easily revert back to the “bar display” by restarting your phone.

NEED HELP?





support.weboost.com

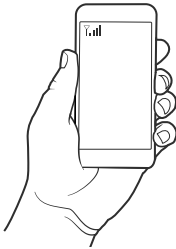

866.294.1660

Step 3: Measure Signal Strength For Inside Antenna Placement



Turn off your cell phone's  WiFi to ensure you are checking the cellular connection. The dBm reading will be refreshed every 30-60 seconds. **Want faster results? Once you have a reading, turn on  airplane mode.** Wait 15 seconds. Turn off airplane mode. The signal strength reading is refreshed.

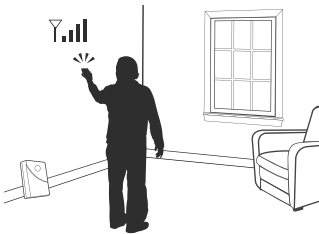





Walk around your home/office taking signal strength readings until you find the area that has the weakest reception, or number farthest away from zero. For example -100 is a weaker signal than -80.

Weakest Signal Number: _____

Weakest Signal Location: _____

Place your Inside Antenna in this poor signal area on the floor and against the wall where you will mount it. For best results, keep the inside antenna more than 18 inches away from the booster.

Having an accurate measurement of signal strength in decibels (dBm) is crucial when installing your system. Decibels accurately measure the signal strength you are receiving. Test both 3G and 4G signal for best results by turning the LTE off in the carrier settings of your device.

SIGNAL STRENGTH	EXCELLENT 	GOOD 	FAIR 	POOR 	DEAD ZONE 
3G/1x (typically voice)	-70dBm	-71 to -85dBm	-86 to -100dBm	-101 to -109dBm	-110dBm
4G/LTE (typically data)	-90dBm	-91 to -105dBm	-106 to -110dBm	-111 to -119dBm	-120dBm

Step 4: Measure Signal Strength For Outside Antenna Placement

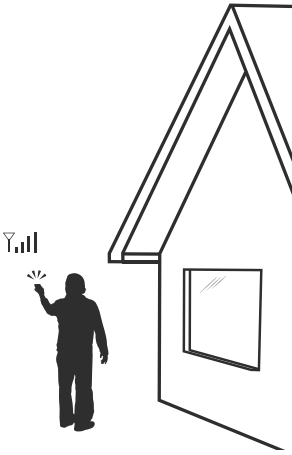

This is the most critical step of the installation process because it will determine the overall performance of the booster system. Using the same method as Step 3, **find the place with the strongest signal (number closest to zero) on the outside of your home.**

The further apart the Inside Antenna is located from the Outside Antenna, the better. To determine the best location for your Outside Antenna, note the dBm reading in a variety of locations.

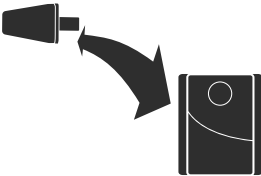

Note: The Outside Antenna must be at least **20 feet vertical or 50 feet horizontal** from the Inside Antenna for best performance. Make sure the Inside Antenna and outside Antennas are facing away from each other.

Step 5: Temporarily Mount The Outside Antenna

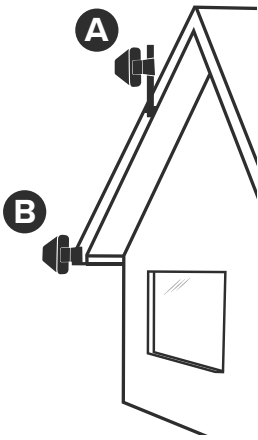

Use one of the two options to mount the outside antenna on the side of the house with the strongest signal.

A Option (Best)

B Option (Good)

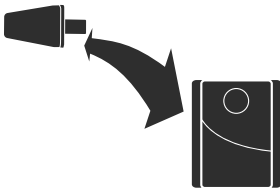

Note: The Outside Antenna must be at least **20 feet vertical or 50 feet horizontal** from the Inside Antenna for best performance. Make sure the Inside Antenna and outside Antennas are facing away from each other.

Step 6: Connect The System

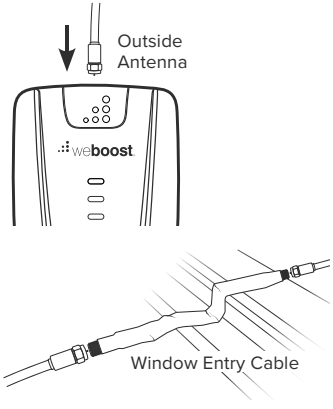

1

Connect the supplied **Coax Cable** to end of booster labeled **Outside Antenna**.

If you choose to bring the cable in through a window, you can use the flat **Window Entry Cable** to connect the two 15 feet cable sections. You can use this option during set-up and/or permanently if you don't want to drill holes through your wall.

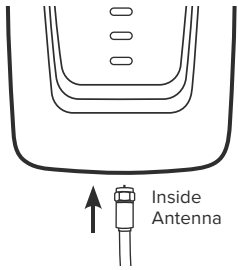

2

Connect the supplied **Coax Cable** to end of booster labeled **Inside Antenna**.

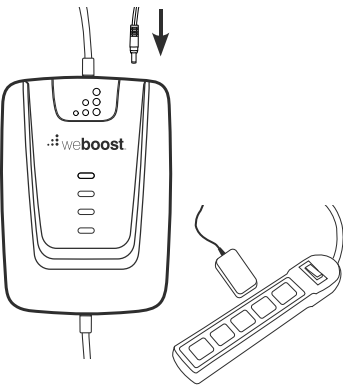

3

Power up the Booster.

To protect Booster from power surges, connect to a power strip.

Step 7: Compare Results

Using the field test mode described in step 3, measure the new signal strength and write it down here _____.

Compare this number with the original reading you took in the same part of the house. If the number is higher (closer to zero) than the original reading without booster, your booster is working. If it is not, look at the lights on the booster and the section at the end of this manual "Test System: Lights".

Did you know a signal increase in just 3dB is 2 times the power and signal amplification!

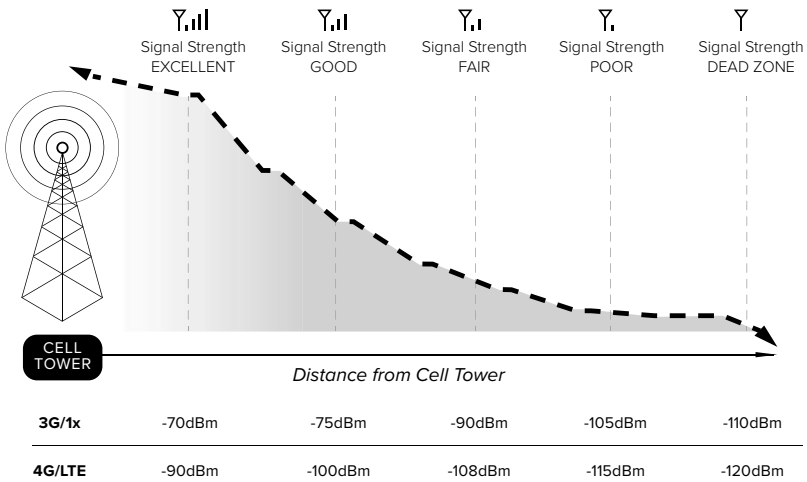

DECIBEL GAIN	POWER INCREASE
3dB	2 times the power and signal amplification
6dB	4 times the power and signal amplification
10dB	10 times the power and signal amplification
12dB	16 times the power and signal amplification
20dB	100 times the power and signal amplification

Step 8: Permanently Mount The Outside Antenna

Option **A**: Outside Roof/Pole Mount (Best Option)

Mount, or use an existing pipe in an optimal signal location. Watch out for power lines.

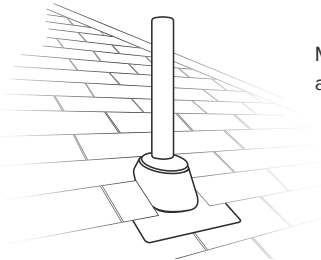
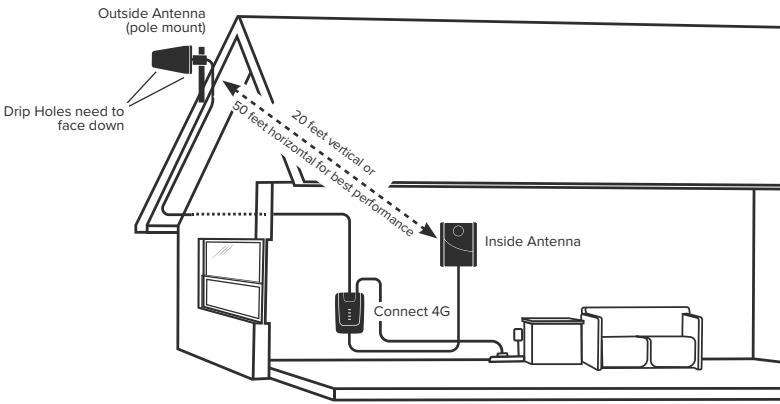

Mounting on existing roof exhaust pipe would be a good time-saver option.

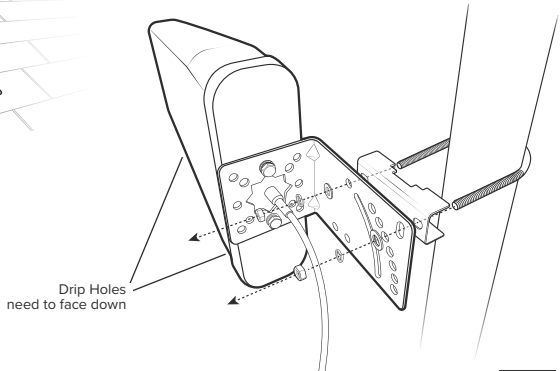

(STEP 8 cont.)

Option **B**: Mounting on side of roof (Good Option)

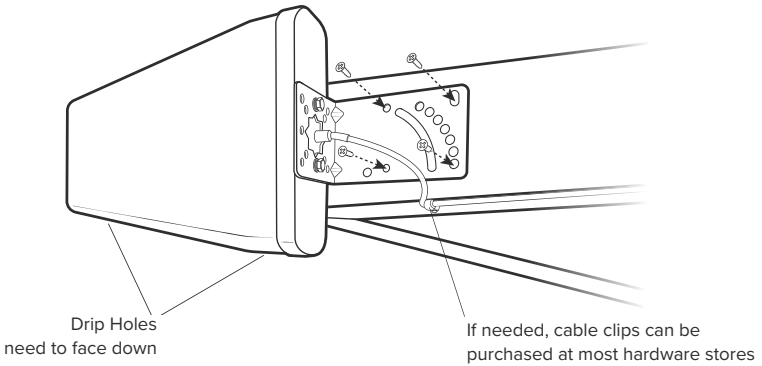
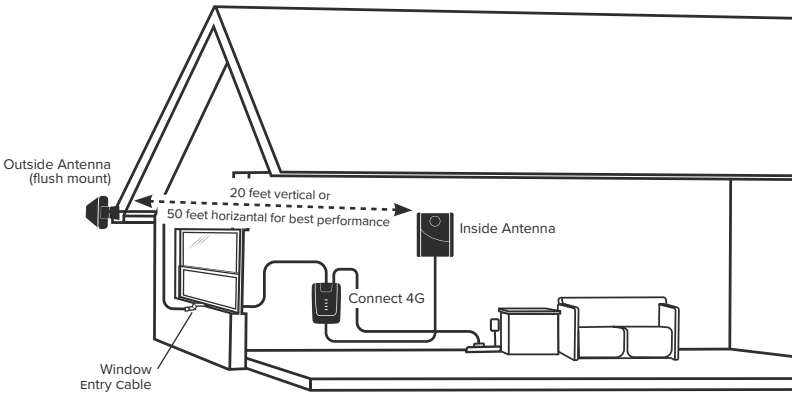

Step 9: Permanently Mount The Inside Antenna

Position bracket on wall and use a pencil to mark the holes. Drill holes using 3/16 inch bit. Use anchors, washers and screws to attach Wall Bracket.

Slip Inside Antenna onto the Wall Mount Bracket to secure.

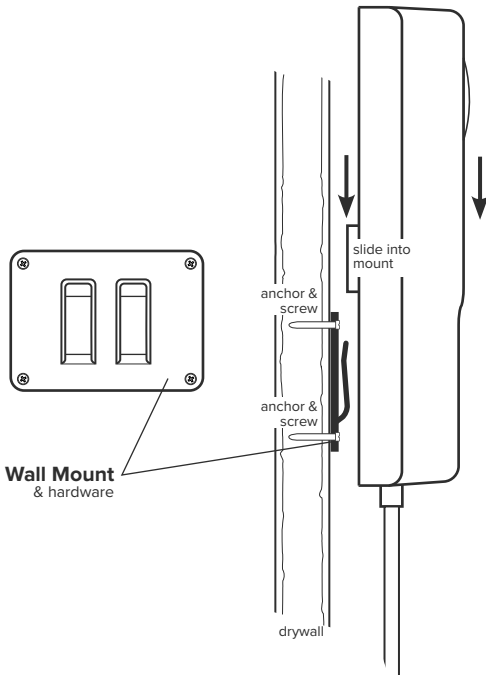

Step 10: Route & Secure The Cable

Secure cable on outside home/office. Some homes have eaves you can tuck the cable between the soffit and the exterior wall. If needed, cable clips can be purchased at most hardware stores.

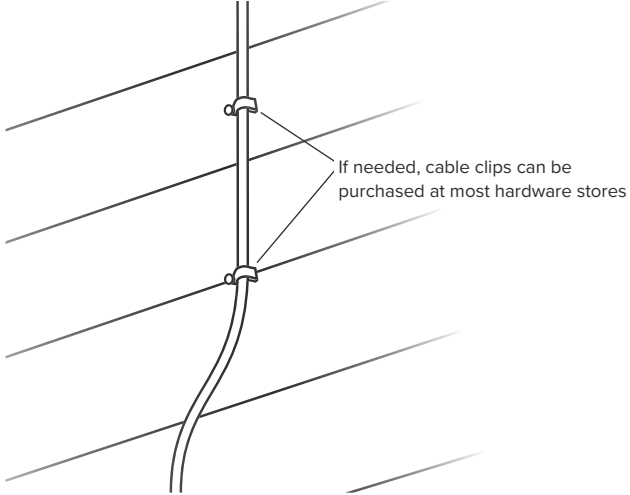
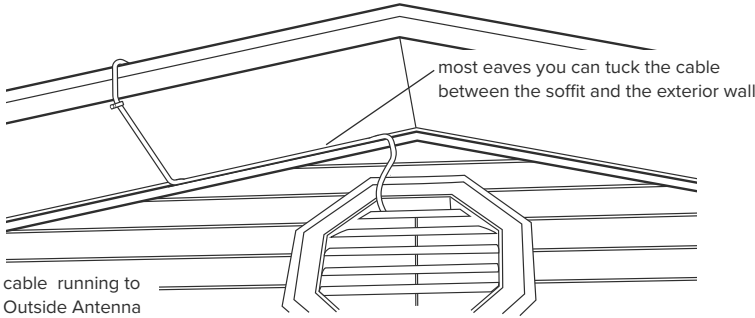

Test System: Lights

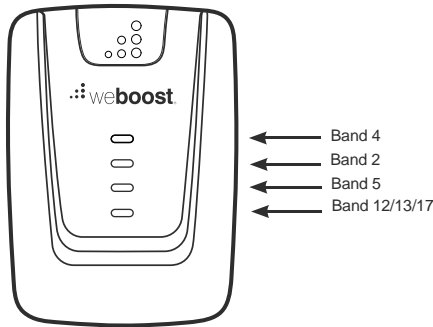

Each light corresponds to a frequency band.



IMPORTANT: To get an accurate reading of the lights, unplug and re-plug the power supply from the Booster.

No Lights

Booster does not have power. Un-plug and securely re-plug in power supply.

Fix Any Red Light Problems (red indicates oscillation)

• If you are happy with coverage, red lights don't have to be resolved.

- **Solid Red** = Band has shut off
- **Blinking Green/Red** = Band has reduced gain

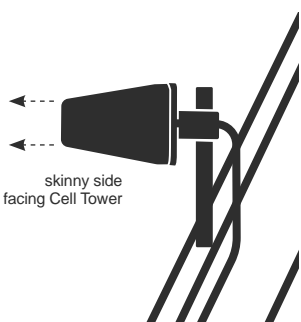

- 1 Verify Outside Antenna faces away from the Inside Antenna. Un-plug and re-plug in power supply.
- 2 Verify the Inside Antenna is at least 18" from the Booster and pointed away from the Booster. Un-plug and re-plug in power supply.
- 3 Tighten all cable connections. You may want to undo and redo the connection completely. Un-plug and re-plug in power supply.
- 4 BEST: Increase the distance (horizontally or vertically) between the Outside and Inside antenna. Add cable if needed. Un-plug and re-plug in power supply.

(TEST SYSTEM: LIGHTS cont.)

Fix Any Orange Light Problems (orange indicates a cell tower is close by)

If you are happy with coverage, orange lights don't have to be resolved

- **Solid Orange** = Band has shut off
- **Blinking Green/Orange** = Band has reduced gain.

- 1 If the light is **solid orange**, the Outside Antenna must be adjusted (see below). Wait 10 seconds between adjustments for the lights to reset.
 - For Roof/Pole Mount Option = Rotate the Outside Antenna away from the strongest cellular signal in small increments (45°) until the light turns **green**. Un-plug and re-plug power supply.
 - For All Other Mount Options = Change mount location. For example, if the Outside Antenna is a window mount, move the Outside Antenna to a wall outside the building to see if the lights turn **green**. Un-plug and re-plug power supply.
- 2 If the light is **blinking green/orange**, re-locate the Outside Antenna. Un-plug and re-plug power supply.

All Green Lights? = Band is set up optimally. Verify you have good coverage.

If you have green lights, but poor coverage:

- Rotate the Outside Antenna in small increments (roof/pole mount only). Un-plug and re-plug power supply.
- Move the Outside Antenna to a different location. Un-plug and re-plug power supply.
- Change the method of mounting the Outside Antenna. Un-plug and re-plug power supply.

Specifications

Connect 4G™					
Model Number	460020				
FCC ID	PWO460020				
IC	4726A-460020				
Connectors	F-Female				
Antenna Impedance	75 Ohms				
Frequency	698-716 MHz, 746-787 MHz, 824-894 MHz, 1850-1995 MHz, 1710-1755/2110-2155 MHz				
Passband Gain (nominal)	700 MHz Band17 58.7	700 MHz Band13 58.6	800 MHz Band 5 59.5	1700/2100 MHz Band 4 63.7	1900 MHz Band 25/2 63.7
20 dB Bandwidth (MHz)	700 MHz Band17	700 MHz Band13	800 MHz Band 5	1700/2100 MHz Band 4	1900 MHz Band 25/2
	Typical 31.8	32.1	37.9	79.9	81.9
Maximum	35.4	35.6	39.0	83.0	85.1
Power output for single cell phone (Uplink) dBm	700 MHz Band17 23.94	700 MHz Band13 24.19	800 MHz Band 5 23.49	1700 MHz Band 4 24.55	1900 MHz Band 25/2 23.61
Power output for single cell phone (Downlink) dBm	700 MHz Band17 11.64	700 MHz Band13 11.92	800 MHz Band 5 12.1	2100 MHz Band 4 11.9	1900 MHz Band 25/2 9.5
Power output for multiple received channels (Uplink) dBm	Maximum Power				
	No. Tones	700 MHz Band17	700 MHz Band13	800 MHz Band 5	1700 MHz Band 4
2	20.7	19.9	23.4	21.2	19.1
3	17.1	16.3	19.9	17.7	15.5
4	14.6	13.8	17.4	15.2	13.0
5	12.7	11.9	15.4	13.3	11.1
6	11.1	10.3	13.9	11.7	9.5
Power output for multiple received channels (Downlink) dBm	Maximum Power				
	No. Tones	700 MHz Band17	700 MHz Band13	800 MHz Band 5	2100 MHz Band 4
2	12.7	13.3	11.8	11.9	12.6
3	9.2	9.8	8.2	8.4	9.1
4	6.7	7.3	5.7	5.9	6.6
5	4.8	5.4	3.8	4.0	4.7
6	3.2	3.8	2.2	2.4	3.1
Noise Figure	5 dB nominal				
Isolation	> 110 dB				
Power Requirements	AC / DC 5V, 2.5A, w/2.5x5.5mm Jack				

The term "IC" before the radio certification number only signifies that Industry Canada technical specifications were met.

Each Signal Booster is individually tested and factory set to ensure FCC compliance. The Signal Booster cannot be adjusted without factory reprogramming or disabling the hardware. The Signal Booster will amplify, but not alter incoming and outgoing signals in order to increase coverage of authorized frequency bands only. If the Signal Booster is not in use for five minutes, it will reduce gain until a signal is detected. If a detected signal is too high in a frequency band, or if the Signal Booster detects an oscillation, the Signal Booster will automatically reduce the gain on that specific band.

The Manufacturer's rated output power of this equipment is for single carrier operation. For situations when multiple carrier signals are present, the rating would have to be reduced by 3.5 dB, especially where the output signal is re-radiated and can cause interference to adjacent band users. This power reduction is to be by means of input power or gain reduction and not by an attenuator at the output of the device.

Safety Guidelines

Warnings

To uphold compliance with network protection standards, all active cellular devices must maintain at least six feet of separation distance from Inside Panel and Dome antennas and at least four feet of separation distance from desktop Antenna.

Use only the power supply provided in this package. Use of a non-weBoost product may damage your equipment.

The Signal Booster unit is designed for use in an indoor, temperature-controlled environment (less than 100 degrees Fahrenheit). It is not intended for use in attics or similar locations subject to temperatures in excess of that range.

RF Safety Warning: Any antenna used with this device must be located at least 8 inches from all persons.

This is a CONSUMER device.

BEFORE USE, you **MUST REGISTER THIS DEVICE** with your wireless provider and have your provider's consent. Most wireless providers consent to the use of signal boosters. Some providers may not consent to the use of this device on their network. If you are unsure, contact your provider.

In Canada, **BEFORE USE** you must meet all requirements set out in ISED CPC-2-1-05. You **MUST** operate this device with approved antennas and cables as specified by the manufacturer. Antennas **MUST** be installed at least 20 cm (8 inches) from (i.e., **MUST NOT** be installed within 20 cm of) any person.

You **MUST** cease operating this device immediately if requested by the FCC (or ISED in Canada) or licensed wireless service provider.

WARNING. E911 location information may not be provided or may be inaccurate for calls served by using this device.

This device complies with Part 15 of FCC rules. Operation is subject to two conditions: (1) This device may not cause harmful interference, and (2) this device must accept any interference received, including interference that may cause undesired operation. Changes or modifications not expressly approved by weBoost could void the authority to operate this equipment.

FOR MORE INFORMATION ON REGISTERING YOUR SIGNAL BOOSTER WITH YOUR WIRELESS PROVIDER, PLEASE SEE BELOW:

Sprint: http://www.sprint.com/legal/fcc_boosters.html

T-Mobile/MetroPCS: <https://support.t-mobile.com/docs/DOC-9827>

Verizon Wireless: <http://www.verizonwireless.com/wcms/consumer/register-signal-booster.html>

AT&T: <https://securec45.securewebsession.com/attsignalbooster.com/>

U.S. Cellular: <http://www.uscellular.com/uscellular/support/fcc-booster-registration.jsp>

Antenna Kit Options

The following accessories are certified by the FCC to be used with the **Connect 4G Booster**.

INSIDE ANTENNA EXPANSION KITS

Kit 309900-50N
2- Wall Panel Antennas
1- 50 ohm 3-Way Splitter
Kit 309905-50N
3 - Wall Panel Antennas
3- 2-Way 50 Ohm Splitters
Kit 309902-75F
2 - Wall Panel Antennas
1-3-Way 75Ohm Splitter
Kit 309903-75F
3 - Wall Panel Antennas
3- 2-Way 75Ohm Splitters
Kit 309904-75F
1 - Wall Panel Antenna
1- 2-Way 75 Ohm Splitter
Kit 301213
Desktop Antenna w/ 5' RG174

INSIDE ANTENNAS

Kit 301121-40010
50 Ohm Dome Antenna
10' LMR400
Kit 301151-0610
75 Ohm Dome Antenna
10' RG6 Cable
Kit 311155-0630
75 Ohm Wall Mount Panel Antenna
30' RG6 Cable
Kit 311135-5820
50 Ohm Wall Mount Panel Antenna
20' RG58 Cable
Kit 311135-40060
50 Ohm Wall Mount Panel Antenna
60' LMR400 Cable
Kit 301151-1110
75 Ohm Dome Antenna
10' RG11 cable
Kit 311155-1150
75 Ohm Wall Mount Panel Antenna
50' RG11 Cable
Kit 311155-40060
75 Ohm Wall Mount Panel Antenna
60' LMR400 Cable
Kit 304412-40010
50 Ohm 4G Dome Antenna
10' Wilson400 Cable
Kit 304412-5810
50 Ohm 4G Dome Antenna
10' RG58 cable
Kit 304419-1110
75 Ohm 4G Dome Antenna
10' RG 11 cable
Kit 304419-17410
75 Ohm 4G Dome Antenna
10' RG174 cable
*May need separate adapter
Kit 304419-0610
75 Ohm 4G Dome Antenna
10' RG6 cable

50 OHM OUTSIDE ANTENNA KITS

Kit 314453-5825
50 Ohm Pole Mount Panel Antenna
25' RG58 Cable
Kit 314411-5825
50 Ohm Wide Band Directional
25' RG58 Cable
Kit 301111-5850
Yagi Directional Antenna
50' RG58 Cable
Kit 311129 - 5840
800 MHz Yagi Directional
40' RG58 Cable
Kit 311203-5820
Omni-Directional Antenna
20' RG58 Cable
Kit 311124-5830
1900 MHz Yagi Antenna
30' RG58 Cable
Kit 314411-40075
50 Ohm Wide Band Directional
75' LMR400 Cable
Kit 311203-40020
Omni-Directional Antenna
20' LMR400 Cable
Kit 301111-400170
Yagi Directional w/ N-Female
170' LMR400
Kit 311124 - 400100
1900 MHz Yagi Directional
100' LMR400 Cable
Kit 311129-400100
800 MHz Yagi Antenna
100' LMR400 Cable
Kit 314453-40075
50 Ohm Pole Mount Panel Antenna
75' LMR400 Cable
Kit 304422-40020
50 Ohm 4G Omni Antenna
20' Wilson400 cable
Kit 304422-5810
50 Ohm 4G Omni Antenna
10' RG58 cable
*May need separate adapter
Kit 304422-1120
50 Ohm 4G Omni Antenna
20' RG11 cable
*May need separate adapter
Mini-Mag
301126 w/ 12.5 RG174 cable- SMA

75 OHM OUTSIDE ANTENNA KITS

Kit 301111 - 0675
Yagi Directional Antenna
75' RG6 Cable
N-Male to F-Female adapter
Kit 311201-0620
Omni Directional w/ F-Female
20' RG6 Cable

Kit 311129-0660
800 MHz Yagi Directional
60' RG6 Cable
N-Male to F-Female adapter
Kit 311214-0650
1900 MHz Yagi Directional
50' RG6 Cable
N-Male to F-Female adapter
Kit 314473 - 0640
75 Ohm Pole Mount Panel Antenna
RG6 Cable
Kit 314475 - 0630
75 Ohm Wide Band Directional
30' RG6 Cable
Kit 311141 - 0620
75 Ohm Grey Brick Antenna
20' RG6 Cable
Kit 301111 - 11140
Yagi Directional Antenna
140' RG11 Cable
N-Male to F-Female adapter
Kit 311201-1120
Omni Directional w/ F-Female
20' RG11 Cable
Kit 311129-11110
800 MHz Yagi Directional
110' RG11 Cable
N-Male to F-Female adapter
Kit 311124-1180
1900 MHz Yagi Directional
80' RG11 Cable
N-Male to F-Female adapter
Kit 314473 - 1175
75 Ohm Pole Mount Panel Antenna
75' RG11 Cable
Kit 314475 - 1175
75 Ohm Wide Band Directional
75' RG11 Cable
Kit 311141 - 1120
75 Ohm Grey Brick Antenna
20' RG11 Cable
Kit 304421-1120
75 Ohm 4G Omni Antenna
20' RG 11 cable
Kit 304421-17410
75 Ohm 4G Omni Antenna
10' RG174 cable
*May need separate adapter
Kit 304421-0610
75 Ohm 4G Omni Antenna
10' RG6 cable
Kit 304421-5810
75 Ohm 4G Omni Antenna
10' RG58 cable
*May need separate adapter

Warranty

2 YEAR WARRANTY

weBoost Signal Boosters are warranted for two (2) years against defects in workmanship and/or materials. Warranty cases may be resolved by returning the product directly to the reseller with a dated proof of purchase.

Signal Boosters may also be returned directly to the manufacturer at the consumer's expense, with a dated proof of purchase and a Returned Material Authorization (RMA) number supplied by weBoost. weBoost shall, at its option, either repair or replace the product.

This warranty does not apply to any Signal Boosters determined by weBoost to have been subjected to misuse, abuse, neglect, or mishandling that alters or damages physical or electronic properties.

Replacement products may include refurbished weBoost products that have been recertified to conform with product specifications.

RMA numbers may be obtained by contacting Customer Support

DISCLAIMER: The information provided by weBoost is believed to be complete and accurate. However, no responsibility is assumed by weBoost for any business or personal losses arising from its use, or for any infringements of patents or other rights of third parties that may result from its use.



3301 East Deseret Drive, St. George, UT

T. 866.294.1660

www.weboost.com | support@weboost.com

Copyright © 2016 weBoost. All rights reserved.

weBoost products covered by U.S. patent(s) and pending application(s)

For patents go to: weboost.com/us/patents