

# Home 4G

Cellular Signal Booster

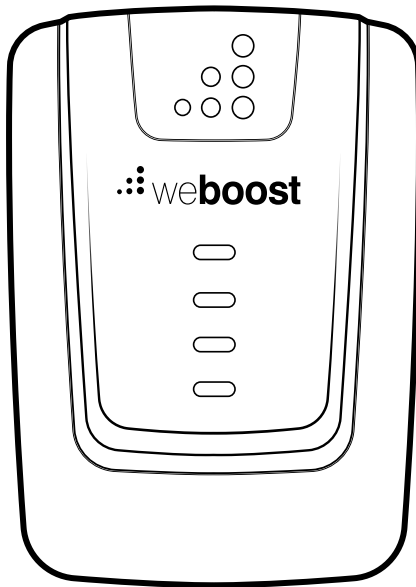

## User Manual

---

**NEED HELP?**



support.weboost.com



866.294.1660

---

# Index

Package Contents .....	1
Preparation .....	2
<b>STEP 1-A &amp; B:</b> Connect Inside Antenna To Booster .....	3
<b>STEP 2-A:</b> Point Outside Antenna Toward Nearest Cell Tower ....	4
<b>STEP 2-B:</b> Mount Bracket To Outside Antenna .....	5
<b>STEP 3:</b> Route & Connect Cable To System .....	7
<b>STEP 4:</b> Power Up The Booster .....	8
Measuring Booster Performance .....	9
Light Patterns .....	11
Troubleshooting .....	12
Safety Guidelines .....	14
Specifications .....	15
Warranty .....	16

---

# Package Contents



Home 4G



Inside Antenna

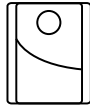

Outside Antenna

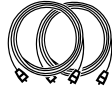

30' Cables  
Qty. 2



Window  
Entry Cable



Power  
Supply

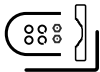

Roof/Pole  
Mount  
Bracket



Wall Mount  
Bracket



Cable  
Connector

---

# Preparation

## You Will Need (tools not included)

Make sure the following materials are prepared and ready for your installation.



1 to 2 hours



2 people (a person to help with antenna calibration)



- Ladder
- Phillips-head screwdriver
- 10mm open-end wrench or adjustable wrench
- Drill (*if routing cable through wall*)
- 1.25"-2" diameter pole existing pole (or order #901117)
- Recommended: Power Strip with surge protection

NOTE: These instructions will walk you through a “soft” install process to find the optimal locations for the inside and outside antennas, then through the process of the permanent installation.

---

# Step 1-A & B: Connect Inside Antenna To Booster

Connect **Inside Antenna** cable to the bottom port on **Home 4G booster** labeled 'INSIDE' and place Inside Antenna in weak signal area at least 18 inches away from booster.

NOTE: Do not connect booster to power until the system is fully installed.

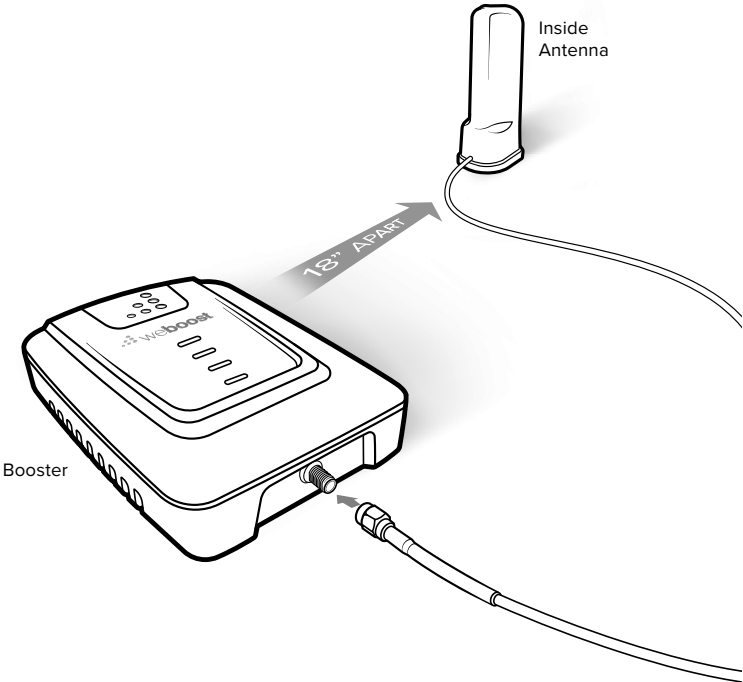

---

# Step 2-A: Point Outside Antenna Toward Nearest Cell Tower

Point the **Outside Antenna** toward the nearest cell phone tower. To find the nearest tower, use an app such as 'Open Signal'. This is the most critical step of the installation process because it will determine the overall performance of the booster system.

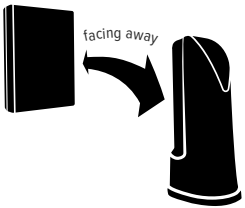
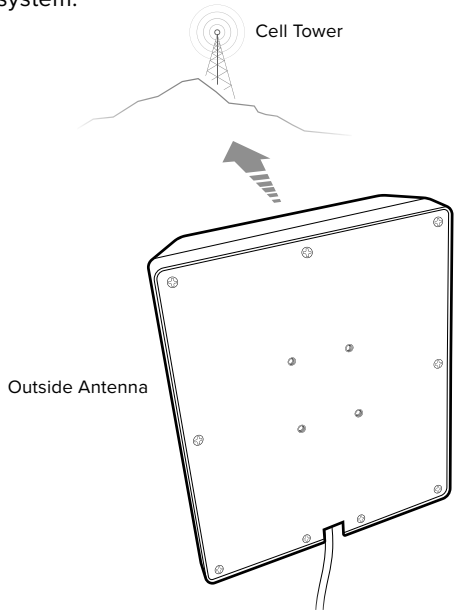

NOTE: The Outside Antenna must be at least **20 feet horizontal or 50 feet vertical** from the Inside Antenna for best performance. Make sure the Inside Antenna and Outside Antennas are setup so they are **facing away** from each other.

---

# Step 2-B: Mount Bracket To Outside Antenna

**Pole Mounting and Wall Mounting Options** are included. The pole mounting option is preferred because it would be easier to adjust to the direction of the cell tower.

Attach the **L-Bracket** to the Outside Antenna and use the **U-Bolts/Pole Bracket** to attach the L-Bracket to a pole.

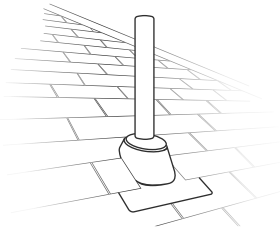
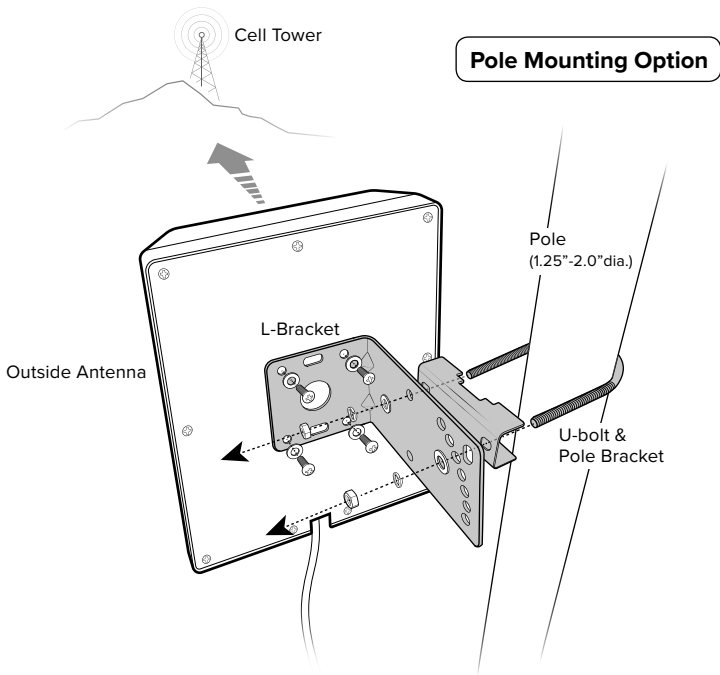

**NOTE:** Mounting on existing roof exhaust pipe would be a good time-saver option.

(STEP 2-B cont.)

**Wall Mounting Option**

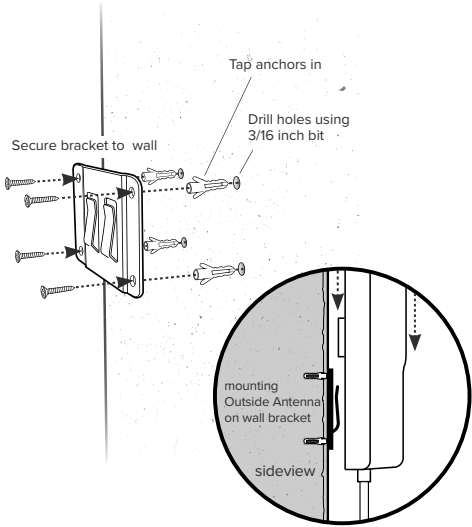
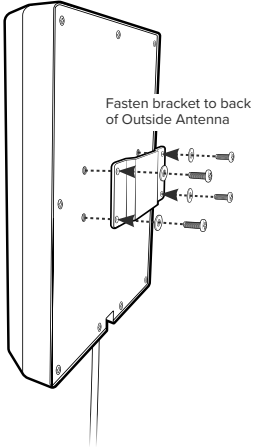



---

# Step 3: Route & Connect Cable To System

Connect the white **RG-6 Cable** to **Outside Antenna** and route cable into the home. All connections should be **hand tightened** only.

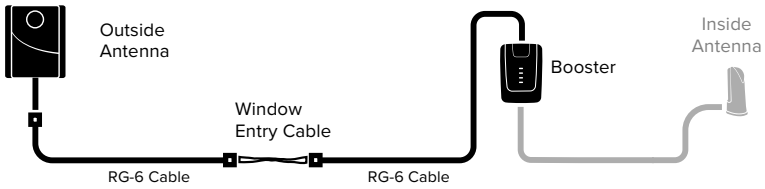

A Window Entry Cable is provided to help make cable entry easier. Route cable to the **Home 4G booster** and connect to top port labeled 'OUTSIDE'.

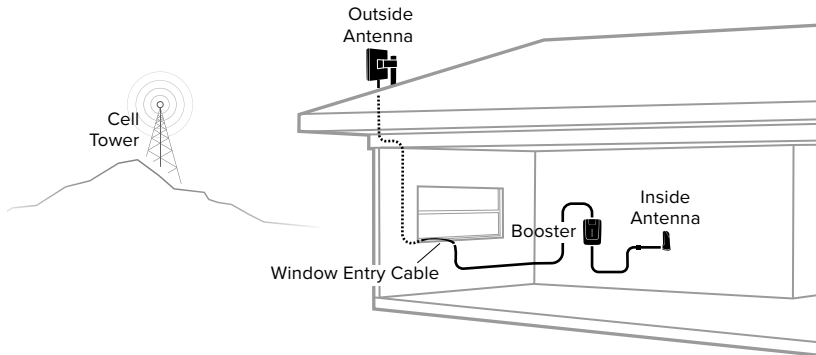

---

# Step 4: Power Up The Booster

Plug the **Power Supply** into wall outlet then connect to Home 4G Booster and enjoy your boosted cell signal!

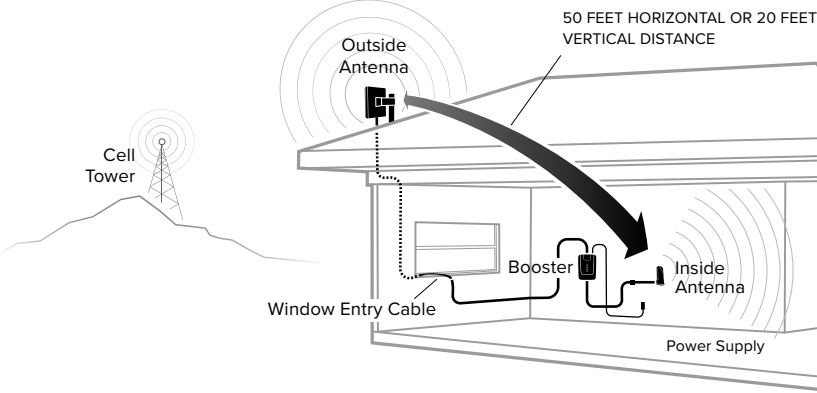
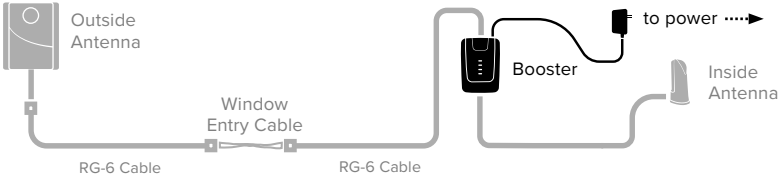

---

# Measuring Booster Performance

## How To Get Signal Strength As A Number

### iPhone®

Dial \*3001#12345## then press Call.

- 1 Hold down power button until you see 'Slide to Power Off'.
- 2 Then release the power button.
- 3 Hold the Home button until your main screen appears.

If you want to check 3G/1x but your iPhone is picking up 4G/LTE signal, go to Settings>Cellular>Cellular Data Options>Enable LTE>Select Off.

After you system is set up, you can go back to the dots signal by once again dialing \*3001#12345## then pressing call. When the menu comes back up, tap “phone” in the top left corner of your phone.

### iPhone® iOS 11 - current

iOS 11 no longer displays the decibel (dBm) reading in 'Field Test Mode'. Tip: Using the bar indicator on your cell phone can assist you in finding the strongest signal direction as well as placing calls in different locations. **For changes/updates on this issue, periodically go to [weboost.com/signalstrength](http://weboost.com/signalstrength).**

### Android™

Settings > About Phone > Status or Network > Signal Strength or Network Type and Strength (exact options/wording depends on phone model).

iPhone is a registered trademark of Apple Inc. Android is a trademark of Google Inc.

## All Other Phones & Alternate Methods

Go to [www.weboost.com/test-mode-instructions/](http://www.weboost.com/test-mode-instructions/)

(MEASURING BOOSTER PERFORMANCE cont.)

## Signal Strength without Booster

Note here: \_\_\_\_\_

## Signal Strength with Booster

Note here: \_\_\_\_\_

## Compare Results

Having an accurate measurement of signal strength in decibels (dBm) is crucial when installing your system. Decibels accurately measure the signal strength you are receiving.

SIGNAL STRENGTH	EXCELLENT	GOOD	FAIR	POOR	DEAD ZONE
3G/1x	-70dBm	-71 to -85dBm	-86 to -100dBm	-101 to -109dBm	-110dBm
4G/LTE	-90dBm	-91 to -105dBm	-106 to -110dBm	-111 to -119dBm	-120dBm

**DID YOU KNOW** a signal increase of just 3dB is 2 times the power and signal amplification!

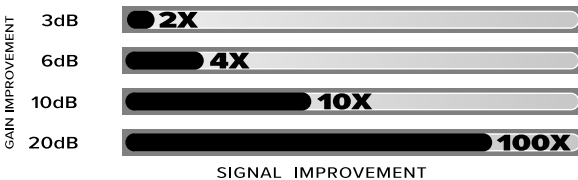

---

# Light Patterns

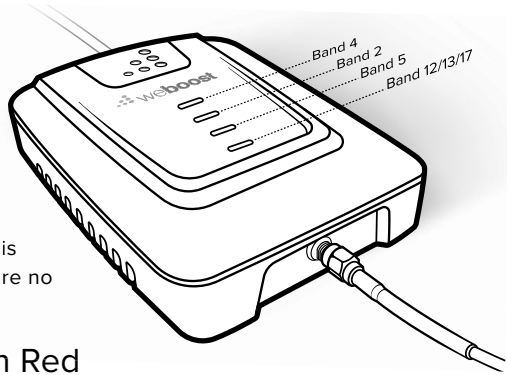

## Solid Green

This indicates that your booster is functioning properly and there are no issues with installation.

## Blinking Green, Then Red

Band has reduced gain. This indicates that one or more of the booster bands has reduced power due to a feedback loop condition called oscillation. This is a built in safety feature to prevent harmful interference with a nearby cell tower. If you are already experiencing the desired signal boost, then no further adjustments are necessary. If you are not experiencing the desired boost in coverage then refer to the Troubleshooting section.

## Solid Red

Band has shutoff. This is due to a feedback loop condition called oscillation. This is a built in safety feature that causes a band to shut off to prevent harmful interference with a nearby cell tower. Refer to Troubleshooting section.

## Blinking Green, Orange

Band has reduced gain. This indicates that one or more of the booster bands has reduced power due to overload from nearby cell tower. This is a built in safety feature to prevent harmful interference with a nearby cell tower. If you are already experiencing the desired signal boost, then no further adjustments are necessary. If you are not experiencing the desired boost in coverage then refer to the Troubleshooting section.

## Solid Orange

Band has shutoff due to overload from nearby cell tower. Outside Antenna must be adjusted. Refer to Troubleshooting section.

## Light Off

If the Signal Booster's light is off, verify your power supply has power.

---

# Troubleshooting

**IF YOU ARE HAPPY WITH THE COVERAGE, THESE LIGHT ISSUES DON'T HAVE TO BE RESOLVED. YOUR CARRIER'S BAND HAS NOT BEEN AFFECTED.**

## FIXING ANY RED LIGHT ISSUES

This involves Solid Red & Blinking Green/Red lights.

- 1 Verify Outside Antenna faces away from the Inside Antenna. Un-plug and re-plug in power supply.
- 2 Verify the Inside Antenna is at least 18" from the Booster and pointed away from the Booster. Unplug and re-plug in power supply.
- 3 Tighten all cable connections (be sure to handtighten only, do NOT use tools). You may want to undo and redo the connection completely. Unplug and re-plug in power supply.
- 4 Increase the distance (horizontally or vertically) between the Outside and Inside antenna. Add included cable if needed. Un-plug and re-plug in power supply.

## FIXING ANY ORANGE LIGHT ISSUES

This involves Solid Orange & Blinking Green/Orange lights.

**Outside Antenna must be adjusted.** Wait 10 seconds between adjustments for the lights to reset.

**Pole Mount Option:** Rotate the Outside Antenna away from the strongest cellular signal in small increments (45°) until the light turns green. Unplug and re-plug in power supply.

**Wall Mount Option:** Change mount location. Move the Outside Antenna to a wall outside the building to see if the lights turn green. Un-plug and re-plug in power supply.

---

**NEED HELP?**



support.weboost.com



866.294.1660

# Antenna Kit Options

The following accessories are certified by the FCC to be used with the **Connect 4G-X Booster**.

## INSIDE ANTENNA EXPANSION KITS

### Kit 309900-50N

2- Wall Panel antennas  
1- 50 ohm 3-Way Splitter

### Kit 309905-50N

3 - Wall Panel Antennas  
3- 2-Way 50 Ohm Splitters

### Kit 309902-75F

2 - Wall Panel Antennas  
1-3-Way 75Ohm Splitter

### Kit 309903-75F

3 - Wall Panel Antennas  
3- 2-Way 75Ohm Splitters

### Kit 309904-75F

1 - Wall Panel Antenna  
1- 2-Way 75 Ohm Splitter

### Kit 301213

Desktop Antenna w/ 5' RG174

## INSIDE ANTENNAS

### Kit 301121-40010

50 Ohm Dome Antenna  
10' LMR400

### Kit 301151-0610

75 Ohm Dome Antenna  
10' RG6 Cable

### Kit 311155-0630

75 Ohm Wall Mount Panel Antenna  
30' RG6 Cable

### Kit 311135-5820

50 Ohm Wall Mount Panel Antenna  
20' RG58 Cable

### Kit 311135-40060

50 Ohm Wall Mount Panel Antenna  
60' LMR400 Cable

### Kit 301151-1110

75 Ohm Dome Antenna  
10' RG11 cable

### Kit 311155-1150

75 Ohm Wall Mount Panel Antenna  
50' RG11 Cable

### Kit 311155-40060

75 Ohm Wall Mount Panel Antenna  
60' LMR400 Cable

### Kit 304412-40010

50 Ohm 4G Dome Antenna  
10' Wilson400 Cable

### Kit 304412-5810

50 Ohm 4G Dome Antenna  
10' RG58 cable

### Kit 304419-1110

75 Ohm 4G Dome Antenna  
10' RG 11 cable

### Kit 304419-17410

75 Ohm 4G Dome Antenna  
10' RG174 cable

\*May need separate adapter

### Kit 304419-0610

75 Ohm 4G Dome Antenna  
10' RG6 cable

## 50 OHM OUTSIDE ANTENNA KITS

### Kit 314453-5825

50 Ohm Pole Mount Panel Antenna  
25' RG58 Cable

### Kit 314411-5825

50 Ohm Wide Band Directional  
25' RG58 Cable

### Kit 301111-5850

Yagi Directional Antenna  
50' RG58 Cable

### Kit 311129 - 5840

800 MHz Yagi Directional  
40' RG58 Cable

### Kit 311203-5820

Omni-Directional Antenna  
20' RG58 Cable

### Kit 311124-5830

1900 MHz Yagi Antenna  
30' RG58 Cable

### Kit 314411-40075

50 Ohm Wide Band Directional  
75' LMR400 Cable

### Kit 311203-40020

Omni-Directional Antenna  
20' LMR400 Cable

### Kit 301111-400170

Yagi Directional w/ N-Female  
170' LMR400

### Kit 311124 - 400100

1900 MHz Yagi Directional  
100' LMR400 Cable

### Kit 311129-400100

800 MHz Yagi Antenna  
100' LMR400 Cable

### Kit 314453-40075

50 Ohm Pole Mount Panel Antenna  
75' LMR400 Cable

### Kit 304422-40020

50 Ohm 4G Omni Antenna  
20' Wilson400 cable

### Kit 304422-5810

50 Ohm 4G Omni Antenna  
10' RG58 cable

\*May need separate adapter

### Kit 304422-1120

50 Ohm 4G Omni Antenna  
20' RG11 cable

\*May need separate adapter

### Mini-Mag

301126 w/ 12.5 RG174 cable- SMA

## 75 OHM OUTSIDE ANTENNA KITS

### Kit 301111 - 0675

Yagi Directional Antenna  
75' RG6 Cable

N-Male to F-Female adapter

### Kit 311201-0620

Omni Directional w/ F-Female  
20' RG6 Cable

### Kit 311129-0660

800 MHz Yagi Directional  
60' RG6 Cable

N-Male to F-Female adapter

### Kit 311124-0650

1900 MHz Yagi Directional  
50' RG6 Cable

N-Male to F-Female adapter

### Kit 314473 -0640

75 Ohm Pole Mount Panel Antenna  
40' RG6 Cable

### Kit 314475 - 0630

75 Ohm Wide Band Directional  
30' RG6 Cable

### Kit 311141 - 0620

75 Ohm Grey Brick Antenna  
20' RG6 Cable

### Kit 301111 - 11140

Yagi Directional Antenna  
140' RG11 Cable

N-Male to F-Female adapter

### Kit 311201-1120

Omni Directional w/ F-Female  
20' RG11 Cable

### Kit 311129-11110

800 MHz Yagi Directional  
110' RG11 Cable

N-Male to F-Female adapter

### Kit 311124-1180

1900 MHz Yagi Directional  
80' RG11 Cable

N-Male to F-Female adapter

### Kit 314473 -1175

75 Ohm Pole Mount Panel Antenna  
75' RG11 Cable

### Kit 314475 - 1175

75 Ohm Wide Band Directional  
75' RG11 Cable

### Kit 311141 - 1120

75 Ohm Grey Brick Antenna  
20' RG11 Cable

### Kit 304421-1120

75 Ohm 4G Omni Antenna  
20' RG 11 cable

### Kit 304421-17410

75 Ohm 4G Omni Antenna  
10' RG174 cable

\*May need separate adapter

### Kit 304421-0610

75 Ohm 4G Omni Antenna  
10' RG6 cable

### Kit 304421-5810

75 Ohm 4G Omni Antenna  
10' RG58 cable

\*May need separate adapter

---

# Safety Guidelines

To uphold compliance with network protection standards, all active cellular devices must maintain at least six feet of separation distance from Inside Panel and Dome antennas and at least four feet of separation distance from desktop Antenna.

Use only the power supply provided in this package. Use of a non-weBoost product may damage your equipment.

The Signal Booster unit is designed for use in an indoor, temperature-controlled environment (less than 100 degrees Fahrenheit). It is not intended for use in attics or similar locations subject to temperatures in excess of that range.

**RF Safety Warning:** Any antenna used with this device must be located at least 8 inches from all persons.

**AWS Warning:** The Outside Antenna must be installed no higher than 10 meters (31'9") above ground.

## This is a CONSUMER device.

---

**BEFORE USE**, you **MUST REGISTER THIS DEVICE** with your wireless provider and have your provider's consent. Most wireless providers consent to the use of signal boosters. Some providers may not consent to the use of this device on their network. If you are unsure, contact your provider.

In Canada, **BEFORE USE** you must meet all requirements set out in ISED CPC-2-1-05.

You **MUST** operate this device with approved antennas and cables as specified by the manufacturer. Antennas **MUST** be installed at least 20 cm (8 inches) from (i.e., **MUST NOT** be installed within 20 cm of) any person.

You **MUST** cease operating this device immediately if requested by the FCC (or ISED in Canada) or licensed wireless service provider.

**WARNING.** E911 location information may not be provided or may be inaccurate for calls served by using this device.

This device may be operated **ONLY** in a fixed location (i.e., may operate in a fixed location only) for in-building use.

---

## FOR MORE INFORMATION ON REGISTERING YOUR SIGNAL BOOSTER WITH YOUR WIRELESS PROVIDER, PLEASE SEE BELOW:

**Sprint:** [http://www.sprint.com/legal/fcc\\_boosters.html](http://www.sprint.com/legal/fcc_boosters.html)

**T-Mobile/MetroPCS:** <https://support.t-mobile.com/docs/DOC-9827>

**Verizon Wireless:** <http://www.verizonwireless.com/wcms/consumer/register-signal-booster.html>

**AT&T:** <https://securec45.securewebsession.com/attsignalbooster.com/>

**U.S. Cellular:** <http://www.uscellular.com/uscellular/support/fcc-booster-registration.jsp>



# Specifications

Home 4G™					
Product Number	U470001				
Model Number	460020				
FCC ID:	PWO460020				
IC	IC: 4726A-460020				
Connectors	SMA-Female on the Inside Antenna / F-Female on the Outside Antenna				
Antenna Impedance	50 Ohms / 75 Ohms				
Frequency	698-716 MHz, 746-787 MHz, 824-894 MHz, 1850-1995 MHz, 1710-1755/2110-2155 MHz				
Power output for single cell phone (Uplink) dBm	700 MHz Band17 23.94	700 MHz Band13 24.19	800 MHz Band 5 23.49	1700 MHz Band 4 24.55	1900 MHz Band 2 23.61
Power output for single cell phone (Downlink) dBm	700 MHz Band17 11.64	700 MHz Band13 11.92	800 MHz Band 5 12.1	2100 MHz Band 4 11.9	1900 MHz Band 2 9.5
Noise Figure	5 dB nominal				
Isolation	> 110 dB				
Power Requirements	AC / DC 5V, 4A, w/2.5x5.5mm Jack				

The term "IC" before the radio certification number only signifies that Industry Canada technical specifications were met.

Each Signal Booster is individually tested and factory set to ensure FCC compliance. The Signal Booster cannot be adjusted without factory reprogramming or disabling the hardware. The Signal Booster will amplify, but not alter incoming and outgoing signals in order to increase coverage of authorized frequency bands only. If the Signal Booster is not in use for five minutes, it will reduce gain until a signal is detected. If a detected signal is too high in a frequency band, or if the Signal Booster detects an oscillation, the Signal Booster will automatically turn the power off on that band. For a detected oscillation the Signal Booster will automatically resume normal operation after a minimum of 1 minute. After 5 (five) such automatic restarts, any problematic bands are permanently shut off until the Signal Booster has been manually restarted by momentarily removing power from the Signal Booster. Noise power, gain, and linearity are maintained by the Signal Booster's microprocessor.

The Manufacturer's rated output power of this equipment is for single carrier operation. For situations when multiple carrier signals are present, the rating would have to be reduced by 3.5 dB, especially where the output signal is re-radiated and can cause interference to adjacent band users. This power reduction is to be by means of input power or gain reduction and not by an attenuator at the output of the device.

This device complies with Part 15 of FCC rules. Operation is subject to two conditions: (1) This device may not cause harmful interference, and (2) this device must accept any interference received, including interference that may cause undesired operation. Changes or modifications not expressly approved by weBoost could void the authority to operate this equipment.



## 2 YEAR WARRANTY

weBoost Signal Boosters are warranted for two (2) years against defects in workmanship and/or materials. Warranty cases may be resolved by returning the product directly to the reseller with a dated proof of purchase.

Signal Boosters may also be returned directly to the manufacturer at the consumer's expense, with a dated proof of purchase and a Returned Material Authorization (RMA) number supplied by weBoost. weBoost shall, at its option, either repair or replace the product.

This warranty does not apply to any Signal Boosters determined by weBoost to have been subjected to misuse, abuse, neglect, or mishandling that alters or damages physical or electronic properties.

Replacement products may include refurbished weBoost products that have been recertified to conform with product specifications.

RMA numbers may be obtained by contacting Customer Support

**DISCLAIMER:** The information provided by weBoost is believed to be complete and accurate. However, no responsibility is assumed by weBoost for any business or personal losses arising from its use, or for any infringements of patents or other rights of third parties that may result from its use.

---

**NEED HELP?**



support.weboost.com



866.294.1660





3301 East Deseret Drive, St. George, UT

 866.294.1660  [www.weboost.com](http://www.weboost.com)  [support.weboost.com](mailto:support.weboost.com)

Copyright © 2016 weBoost. All rights reserved.

weBoost products covered by U.S. patent(s) and pending application(s)

For patents go to: [weboost.com/us/patents](http://weboost.com/us/patents)