

DRIVE 4G-X

Vehicle Signal Booster Kit

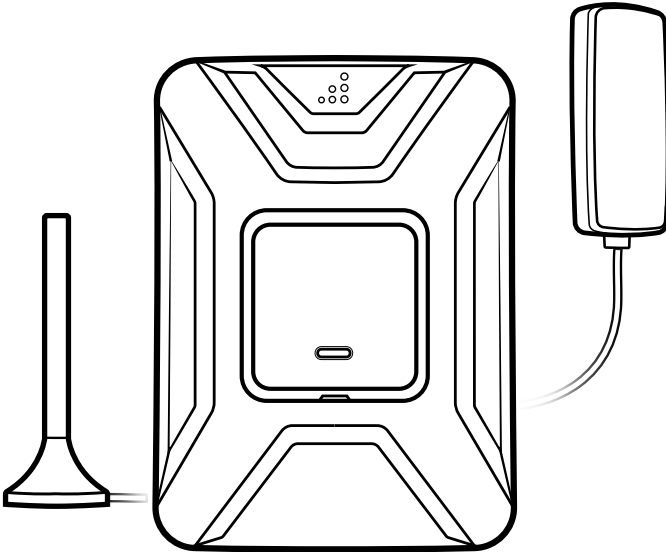

User Manual

Index

| | |
|---|----|
| Package Contents | 1 |
| STEP 1: Mount Outside Magnetic Antenna | 2 |
| STEP 2: Mount Inside Antenna | 4 |
| STEP 3: Connect Coax Cables To Booster | 5 |
| STEP 4: Connect Power Supply To Booster | 6 |
| STEP 5: Plug Power Adapter Into Vehicle's Power Supply ... | 7 |
| Light Patterns | 8 |
| Troubleshooting | 9 |
| Safety Guidelines | 10 |
| Specifications | 11 |
| Warranty | 12 |

Package Contents

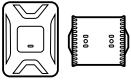

Booster
& Bracket



Outside
Antenna



Inside
Antenna



Power
Supply

Optional: Adhesive disk for aluminum vehicles

Step 1: Mount Outside Magnetic Antenna



Identify a location on the top of your vehicle that is:

- Near the center of the roof
- At least 12 inches away from any other antennas and from any windows (including sunroofs)



Clean the surface where you will place the outside antenna.



Mount the outside antenna by placing on top of vehicle.

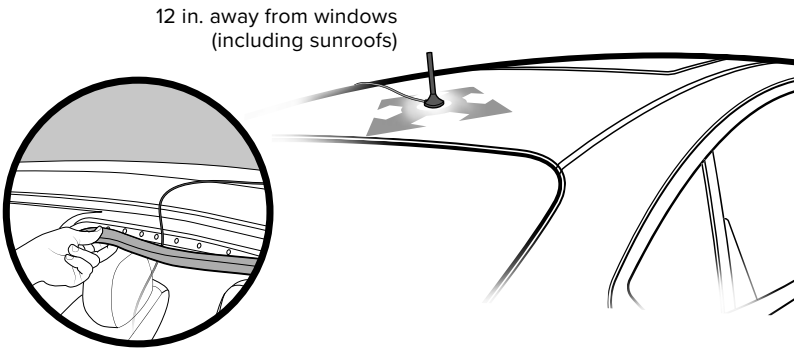

NOTE: For aluminum roofs, use the included adhesive disk to secure outside antenna in place.



WORKS WITH ALL VEHICLES

(STEP 1 cont.)

See options below on how cable can be routed with different vehicles.

NOTE: The cable is strong enough that it may be shut in most vehicle doors without damaging the doors without damaging the cable.

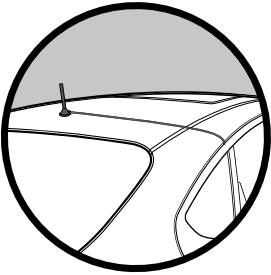

Car/Sedan: Cable routed into rear side door.

NOTE: When going through car wash, remember to remove your antenna.

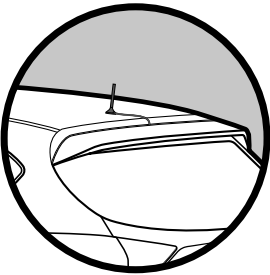

SUV/Van/Hatchback: Cable routed into top of hatchback door.

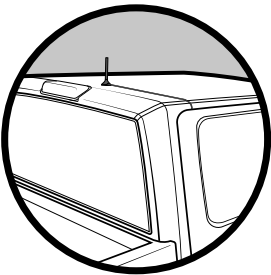

Truck: Cable routed into side door.

Step 2: Mount Inside Antenna

Identify a place to mount the 4G In-Vehicle Antenna, either on the side of the seat or on the dash and mount. The location should be at least 18 inches but no more than 36 inches from where the cellular device will be used. Use the Velcro® adhesive strip/adhesive strip provided and attach to desired location.

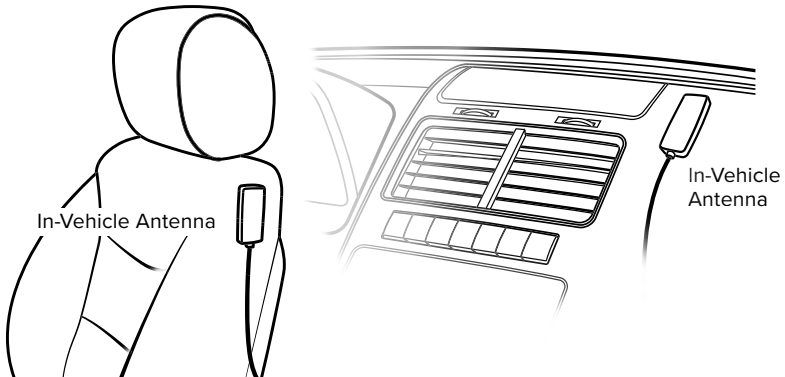

Step 3: Connect Coax Cables To Booster

Connect the cable from the Mini-Mag Mount Antenna to the port labeled “Outside Antenna” on the Drive 4G-X booster.

NOTE: Bracket can be used to fasten booster in a specific location if desired.

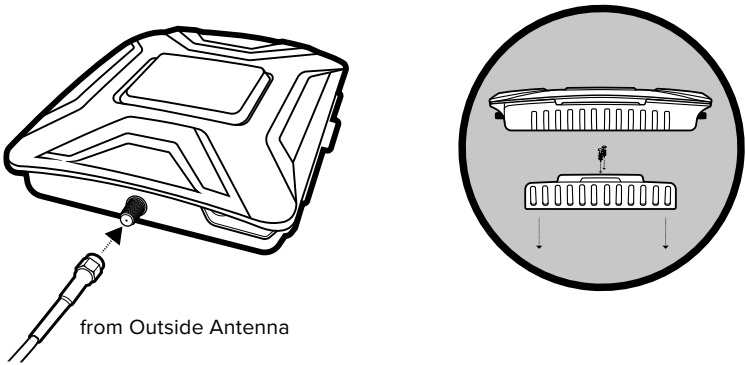

Connect the cable from the 4G In-Vehicle Antenna to the port labeled “Inside Antenna” on the booster.

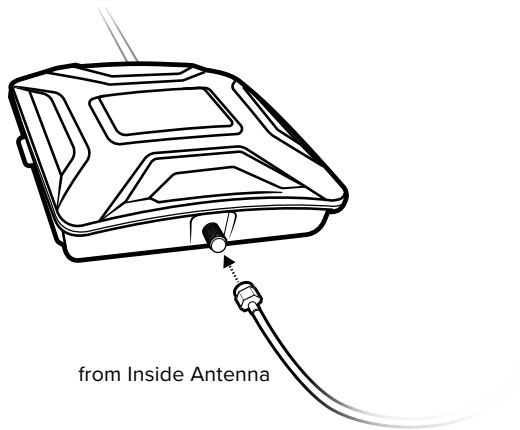

Step 4: Connect Power Supply To Booster

Connect the power supply cord to the end of the Drive 4G-X labeled “Power.”

NOTE: Do NOT connect the power to the Signal Booster until you have connected both the Inside and Outside Antennas.

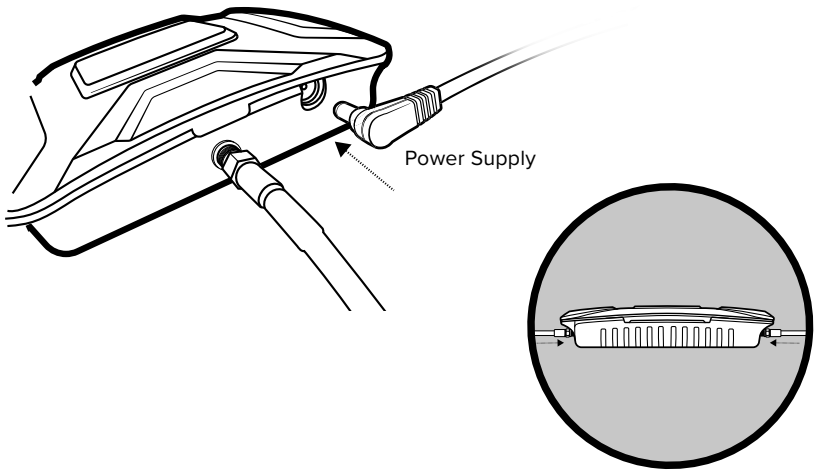

Step 5: Plug Power Adapter Into Vehicle's Power Supply

Plug the power adapter into vehicle's 12V DC power supply. Power up your Drive 4G-X by flipping the switch on the back of the DC power adapter on. If your Drive 4G-X is working correctly, the light on the power adapter will be red, and the light on the booster will be green.

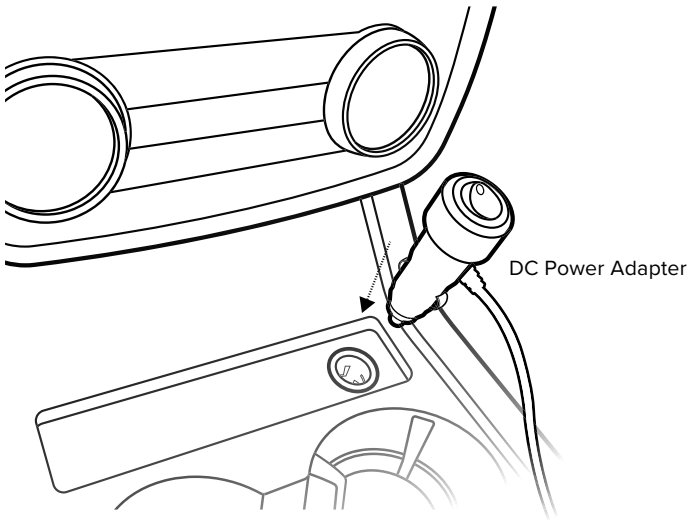

NEED HELP?



support.weboost.com



866.294.1660

Light Patterns

Solid Green

This indicates that your booster is functioning properly and there are no issues with installation.

Blinking Red, Then Solid Green

This indicates that one or more of the booster bands has reduced power due to a feedback loop condition called oscillation. This is a built in safety feature to prevent harmful interference with a nearby cell tower. If you are already experiencing the desired signal boost, then no further adjustments are necessary. If you are not experiencing the desired boost in coverage then refer to the Troubleshooting section below.

Solid Red

This is due to a feedback loop condition called oscillation. This is a built in safety feature that causes a band to shut off to prevent harmful interference with a nearby cell tower. Refer to Troubleshooting section below.

Light Off

If the Drive 4G-X Signal Booster's light is off, verify your power supply has power.

NOTE: The Signal Booster can be reset by disconnecting and reconnecting the power supply.

After troubleshooting you must initiate a new power cycle by disconnecting and then reconnecting power to the Booster.

NEED HELP?



support.weboost.com



866.294.1660

Troubleshooting

FIXING BLINKING OR SOLID RED ISSUES

This section is only applicable if the booster is red or blinking red and you are not experiencing the desired signal boost.

- 1 Unplug the Booster's power supply.
- 2 Relocate the inside and outside antenna further from each other. The objective is to increase the separation distance between them, so that they will not create this feedback condition discussed before.
- 3 Plug power supply back in.
- 4 Monitor the indicator light on your booster. If, after a few seconds of 'power on', a solid or blinking red light appears, repeat steps 1 through 3. Increase the separation distance until the condition is corrected and/or desired coverage area is achieved. Note: Horizontal separation of the two antennas typically requires a shorter separation distance than perpendicular separation.
- 5 If you are having any difficulties while testing or installing your booster, contact our weBoost Customer Support team for assistance (866.294.1660).

FREQUENTLY ASKED QUESTIONS

What hours can I contact customer support?

Customer Support can be reached Monday thru Friday by calling **866.294.1660**, or through our support site at support.weboost.com.

Why do I need to create distance between the booster and the antenna?

Antennas connected to a booster create spheres of signal. When these spheres overlap, a condition called oscillation occurs. Oscillation can be thought of as noise, which causes the booster to scale down its power or shut down to prevent damage. The best way to keep these spheres of signal from overlapping is to maximize separation between the inside and outside antennas.

Safety Guidelines

Use only the power supply provided in this package. Use of a non-weBoost product may damage your equipment.

The Signal Booster unit is designed for use in an indoor, temperature-controlled environment (less than 150 degrees Fahrenheit). It is not intended for use in attics or similar locations subject to temperatures in excess of that range.

All inside panel and dome antennas must have at least 6' of separation distance from all active users, and low profile antennas must have at least 1.5' separation distance from all active users.

Connecting the Signal Booster directly to the cell phone with use of an adapter will damage the cell phone.

RF Safety Warning: Any antenna used with this device must be located at least 8 inches from all persons.

This is a CONSUMER device.

BEFORE USE, you **MUST REGISTER THIS DEVICE** with your wireless provider and have your provider's consent. Most wireless providers consent to the use of signal boosters. Some providers may not consent to the use of this device on their network. If you are unsure, contact your provider.

In Canada, **BEFORE USE** you must meet all requirements set out in ISED CPC-2-1-05. You **MUST** operate this device with approved antennas and cables as specified by the manufacturer. Antennas **MUST** be installed at least 20 cm (8 inches) from (i.e., **MUST NOT** be installed within 20 cm of) any person.

You **MUST** cease operating this device immediately if requested by the FCC (or ISED in Canada) or licensed wireless service provider.

WARNING. E911 location information may not be provided or may be inaccurate for calls served by using this device.

FOR MORE INFORMATION ON REQUIREMENTS SET OUT IN ISED CPC-2-1-05, SEE BELOW:

<http://www.ic.gc.ca/eic/site/smt-gst.nsf/eng/sf08942.html>

FOR MORE INFORMATION ON REGISTERING YOUR SIGNAL BOOSTER WITH YOUR WIRELESS PROVIDER, PLEASE SEE BELOW:

Sprint: http://www.sprint.com/legal/fcc_boosters.html

T-Mobile/MetroPCS: <https://support.t-mobile.com/docs/DOC-9827>

Verizon Wireless: <http://www.verizonwireless.com/wcms/consumer/register-signal-booster.html>

AT&T: <https://securec45.securewebsession.com/attsignalbooster.com/>

U.S. Cellular: <http://www.uscellular.com/uscellular/support/fcc-booster-registration.jsp>

Specifications

Drive 4G-X

| | | | | | |
|---|--|-----------------------------|---------------------------|----------------------------|-----------------------------|
| Product Number | U470010 | | | | |
| Model Number | 460021 | | | | |
| FCC ID: | PWO460021 | | | | |
| IC: | 4726A-460021 | | | | |
| Connectors | SMA-Female | | | | |
| Antenna Impedance | 50 Ohms | | | | |
| Frequency | 699-716 MHz, 729-756 MHz, 777-786 MHz, 824-894 MHz, 1850-1995 MHz, 1710-1755 MHz/2110-2155 MHz | | | | |
| | Maximum Power | | | | |
| Power output for single cell phone (Uplink) dBm | 700 MHz Band 12/17 24.84 | 700 MHz Band 13 24.35 | 800 MHz Band 5 23.4 | 1700 MHz Band 4 21.3 | 1900 MHz Band 2 24.43 |
| Power output for single cell phone (Downlink) dBm | 700 MHz Band 12/17 2.87 | 700 MHz Band 13 2.79 | 800 MHz Band 5 2.8 | 2100 MHz Band 4 2.0 | 1900 MHz Band 2 1.92 |
| Noise Figure | 5 dB nominal | | | | |
| Isolation | > 90 dB | | | | |
| Power Requirements | 6 V 2 A | | | | |

The term "IC" before the radio certification number only signifies that Industry Canada technical specifications were met.

Each Signal Booster is individually tested and factory set to ensure FCC compliance. The Signal Booster cannot be adjusted without factory reprogramming or disabling the hardware. The Signal Booster will amplify, but not alter incoming and outgoing signals in order to increase coverage of authorized frequency bands only. If the Signal Booster is not in use for five minutes, it will reduce gain until a signal is detected. If a detected signal is too high in a frequency band, or if the Signal Booster detects an oscillation, the Signal Booster will automatically turn the power off on that band. For a detected oscillation the Signal Booster will automatically resume normal operation after a minimum of 1 minute. After 5 (five) such automatic restarts, any problematic bands are permanently shut off until the Signal Booster has been manually restarted by momentarily removing power from the Signal Booster. Noise power, gain, and linearity are maintained by the Signal Booster's microprocessor.

This device complies with Part 15 of FCC rules. Operation is subject to two conditions: (1) This device may not cause harmful interference, and (2) this device must accept any interference received, including interference that may cause undesired operation. Changes or modifications not expressly approved by weBoost could void the authority to operate this equipment.



2 YEAR WARRANTY

weBoost Signal Boosters are warranted for two (2) years against defects in workmanship and/or materials. Warranty cases may be resolved by returning the product directly to the reseller with a dated proof of purchase.

Signal Boosters may also be returned directly to the manufacturer at the consumer's expense, with a dated proof of purchase and a Returned Material Authorization (RMA) number supplied by weBoost. weBoost shall, at its option, either repair or replace the product.

This warranty does not apply to any Signal Boosters determined by weBoost to have been subjected to misuse, abuse, neglect, or mishandling that alters or damages physical or electronic properties.

Replacement products may include refurbished weBoost products that have been recertified to conform with product specifications.

RMA numbers may be obtained by contacting Customer Support

DISCLAIMER: The information provided by weBoost is believed to be complete and accurate. However, no responsibility is assumed by weBoost for any business or personal losses arising from its use, or for any infringements of patents or other rights of third parties that may result from its use.

NEED HELP?



support.weboost.com



866.294.1660



3301 East Deseret Drive, St. George, UT

 866.294.1660  www.weboost.com  support.weboost.com

Copyright © 2017 weBoost. All rights reserved.

weBoost products covered by U.S. patent(s) and pending application(s)

For patents go to: weboost.com/us/patents