

SAE Type I Fluid Endurance Time Test Protocol



Prepared for

Transportation Development Centre
On behalf of
Civil Aviation
Transport Canada

and

The Federal Aviation Administration
William J. Hughes Technical Center



October 2001

Final Version 1.0

SAE Type I Fluid Endurance Time Test Protocol



by

Peter Dawson



October 2001

The contents of this report reflect the views of APS Aviation Inc. and not necessarily the official view or opinions of the Transportation Development Centre of Transport Canada.

The Transportation Development Centre does not endorse products or manufacturers. Trade or manufacturers' names appear in this report only because they are essential to its objectives.

DOCUMENT ORIGIN AND APPROVAL RECORD

Prepared by:	 Peter Dawson Consultant	<u>June 27, 2002</u> Date
--------------	---	------------------------------

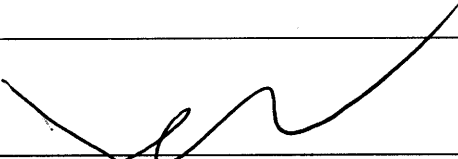
Reviewed by:	 John B. Airro Program Manager	<u>June 19 2002</u> Date
--------------	---	-----------------------------

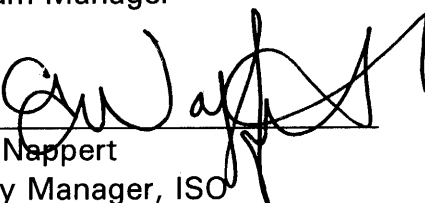
Approved by:	 Gilles Nappert Quality Manager, ISO	<u>20 June 2002</u> Date
--------------	---	-----------------------------

Un sommaire français se trouve avant la table des matières.

PREFACE

At the request of the Transportation Development Centre of Transport Canada, APS Aviation Inc. (APS) has undertaken a research program to advance aircraft ground de/anti-icing technology. The specific objectives of the APS test program are the following:

- To develop holdover time data for all newly qualified de/anti-icing fluids;
- To conduct endurance time frost tests for each temperature to substantiate the values in the current SAE holdover time guidelines for Type IV, Type II, and Type I fluids;
- To evaluate weather data from previous winters to establish a range of snow precipitation suitable for the evaluation of holdover time limits;
- To develop a protocol for Type I fluid testing;
- To examine the change in viscosity during the application of Type IV fluids;
- To compare holdover times in natural snow with those in NCAR's artificial snow;
- To prepare the JetStar and Canadair RJ wing for thermodynamic tests;
- To further evaluate the flow of contaminated fluid from the wing of a Falcon 20D aircraft during simulated take-off runs;
- To further evaluate hot water deicing;
- To provide support for tactile tests at Toronto Central Deicing Facility; and
- To investigate the use of ice sensors in the pre-take-off contamination check.

The research activities during the winter of 2000-2001 are documented in six reports. The last four objectives listed above have not yet been finalized and are not included in this series of reports. Results will be reported upon study completion. The titles of the documented reports are as follows:

- TP 13826E Aircraft Ground De/Anti-icing Fluid Holdover Time Development Program for the 2000-01 Winter;
- TP 13827E SAE Type I Fluid Endurance Time Test Protocol;
- TP 13828E Endurance Time Testing in Snow: Reconciliation of Indoor and Outdoor Data;
- TP 13829E Modification of Test Wing to Accommodate Fuel Load Effects for Deicing Research: 2001;
- TP 13830E Winter Weather Data Evaluation (1995-2001); and
- TP 13831E Endurance Time Tests in Simulated Frost Conditions.

In addition, an interim report entitled *Viscosity Measurement of Type IV Fluids on Wing Surfaces* has been drafted.

This report, TP 13827E, documents the project with the following objective:

- To develop a protocol for Type I fluid testing.

This objective was met by a series of activities that progressively provided information to support development of a new test protocol. These activities involved a review of related previous test data, testing on aircraft in the field to develop a benchmark for comparison, and testing on a test wing and on candidate test surfaces, both in the field and in laboratories.

ACKNOWLEDGEMENTS

This research was funded by the Civil Aviation Group, Transport Canada, with support from the U.S. Federal Aviation Administration. This program could not have been accomplished without the participation of many organizations. APS would therefore like to thank the Transportation Development Centre of Transport Canada, the Federal Aviation Administration, the National Research Council Canada, Atmospheric Environment Services Canada, and several fluid manufacturers. Special thanks are extended to US Airways Inc., Air Canada, American Eagle Airlines Inc., National Centre for Atmospheric Research, AéroMag 2000, Aéroports de Montreal, Hudson General Aviation Services Inc., Union Carbide, Cryotech, and Fortier Transfert Ltée for provision of personnel and facilities and for their co-operation with the test program. APS would also like to acknowledge the dedication of the research team, whose performance was crucial to the acquisition of hard data. The authors gratefully acknowledge the participation of Jorge Amorim, Roberto Angulo, Nicolas Blais, Richard Campbell, Michael Chaput, Derek Flis, Jeff Mayhew, Nicoara Moc, and Michael J. Walesiak. Special thanks are extended to Frank Eyre and Barry Myers of the Transportation Development Centre for their participation, contribution, and guidance in the preparation of this document.



1. Transport Canada Publication No. TP 13827E		2. Project No. 5031-34		3. Recipient's Catalogue No.		
4. Title and Subtitle SAE Type I Fluid Endurance Time Test Protocol				5. Publication Date October 2001		
				6. Performing Organization Document No. CM1680.001		
7. Author(s) Peter Dawson				8. Transport Canada File No. ZCD2450-B-14		
9. Performing Organization Name and Address APS Aviation Inc. 1100 René Lévesque Blvd. West Suite 1340 Montreal, Quebec H3B 4N4				10. PWGSC File No. MTB-0-02254		
				11. PWGSC or Transport Canada Contract No. T8200-000556/001/MTB		
12. Sponsoring Agency Name and Address Transportation Development Centre (TDC) 800 René Lévesque Blvd. West Suite 600 Montreal, Quebec H3B 1X9				13. Type of Publication and Period Covered Final		
				14. Project Officer Barry B. Myers		
15. Supplementary Notes (Funding programs, titles of related publications, etc.) <p>Research reports produced on behalf of Transport Canada for testing during previous winters are available from the Transportation Development Centre (TDC). Six reports (including this one) were produced as part of this winter's research program. Their subject matter is outlined in the preface.</p>						
16. Abstract <p>Fluid endurance time tests conducted during the 1999-2000 winter led to a recommendation that SAE Type I Holdover Times for snow conditions be reduced significantly. The extent of the change caused the validity of the test methodology to be questioned.</p> <p>A research program was initiated to develop a test protocol to measure the endurance times of SAE Type I fluids. Fluids were tested on a number of aircraft to develop data on temperature decay rates for wing surfaces, which together with previous test data served as a benchmark for assessing new potential test procedures and test surfaces.</p> <p>It was found that two procedures were required: one for laboratory testing in calm conditions; and another for outdoor testing in variable wind conditions. These procedures are described.</p> <p>The study recommends that the format for the existing SAE fluid holdover time guideline be modified to provide narrower temperature ranges.</p>						
17. Key Words SAE Type I fluid holdover time, holdover time testing, effect of heat on holdover time, HOT				18. Distribution Statement Limited number of copies available from the Transportation Development Centre		
19. Security Classification (of this publication) Unclassified		20. Security Classification (of this page) Unclassified		21. Declassification (date) —	22. No. of Pages xxii, 150, apps	23. Price Shipping/ Handling



1. N° de la publication de Transports Canada TP 13827E		2. N° de l'étude 5031-34		3. N° de catalogue du destinataire	
4. Titre et sous-titre SAE Type I Fluid Endurance Time Test Protocol				5. Date de la publication Octobre 2001	
				6. N° de document de l'organisme exécutant CM1680.001	
7. Auteur(s) Peter Dawson		8. N° de dossier - Transports Canada ZCD2450-B-14			
9. Nom et adresse de l'organisme exécutant APS Aviation Inc. 1100, boul. René-Lévesque Ouest Bureau 1340 Montréal, Québec H3B 4N4				10. N° de dossier - TPSGC MTB-0-02254	
				11. N° de contrat - TPSGC ou Transports Canada T8200-000556/001/MTB	
12. Nom et adresse de l'organisme parrain Centre de développement des transports (CDT) 800, boul. René-Lévesque Ouest Bureau 600 Montréal (Québec) H3B 1X9				13. Genre de publication et période visée Final	
				14. Agent de projet Barry B. Myers	
15. Remarques additionnelles (programmes de financement, titres de publications connexes, etc.) Les rapports de recherche produits au nom de Transports Canada sur les essais réalisés au cours des hivers antérieurs peuvent être obtenus auprès du Centre de développement des transports (CDT). Le programme de la saison hivernale a donné lieu à six rapports (dont celui-ci). On trouvera dans la préface l'objet de ces rapports.					
16. Résumé Les résultats des essais d'endurance de la saison 1999-2000 ont conduit à recommander une diminution importante des durées d'efficacité établies pour les liquides de type I de la SAE sous des précipitations neigeuses. Or, l'écart entre les anciennes et les nouvelles données était tel que la validité de la méthode d'essai a été mise en doute. Un programme de recherche a donc été entrepris pour mettre au point un protocole d'essai qui déboucherait sur une évaluation réaliste de l'endurance des liquides antigivre de type I de la SAE. Des essais réalisés à l'aide d'aéronefs ont d'abord permis de colliger de nouvelles données sur les taux de décroissance du gradient thermique à la surface d'une aile. Ces données, combinées aux résultats d'essais antérieurs, ont servi de point de repère pour l'évaluation de nouveaux protocoles et nouvelles surfaces d'essai potentiels. L'étude a révélé la nécessité de deux protocoles d'essai, un pour les essais en laboratoire, dans des conditions calmes, et un pour les essais extérieurs, dans des conditions de vent variables. Les deux protocoles sont décrits dans le rapport. L'étude recommande de modifier les tables de durée d'efficacité actuelles de la SAE de façon à restreindre les plages de températures.					
17. Mots clés Durée d'efficacité des liquides de type I de la SAE, essai de durée d'efficacité, effet de la chaleur sur la durée d'efficacité, durée d'efficacité			18. Diffusion Le Centre de développement des transports dispose d'un nombre limité d'exemplaires.		
19. Classification de sécurité (de cette publication) Non classifiée		20. Classification de sécurité (de cette page) Non classifiée		21. Déclassification (date) —	22. Nombre de pages xxii, 150, ann.
					23. Prix Port et manutention

EXECUTIVE SUMMARY

At the request of the Transportation Development Centre (TDC) of Transport Canada and the Federal Aviation Administration (FAA), APS Aviation undertook a research program to develop a protocol for measuring fluid holdover times of SAE Type I fluids.

Background

The 1999-2000 winter series of endurance time trials on SAE Type I fluids resulted in recommended holdover times for snow that were significantly shorter than those previously published. Nevertheless, the older holdover times had been used without incident since their implementation.

The reduction in fluid endurance times led to discussion at industry meetings and to the general realization that the testing method was suspect. It was generally believed that the reduction in endurance times was the result of a method that did not consider the contribution of the transfer of heat from the heated fluid to the wing surface.

Objective

The objective of this project was to develop a protocol for measuring endurance times for SAE Type I fluids that would reflect real field operations. The ideal protocol would simulate the full nature of actual de/anti-icing operations on real wings in the natural environment.

To achieve this objective, a series of activities were conducted. These progressively provided information to support development of a new test protocol. In overview, these activities were:

- Reviewing pertinent data from various test reports
- Collecting data on wing temperature decay rate to serve as a benchmark
- Selecting a suitable test surface
 - Examining prospective test surfaces in laboratory and field tests
 - Comparing test results from prospective test surfaces with data from tests on wings
- Conducting fluid endurance time tests on prospective test surfaces

- Conducting trials with a JetStar test wing in laboratory conditions and with operational aircraft in natural conditions to examine how prospective test surfaces correspond to aircraft wings
- Defining and documenting test procedures, using the selected test surface

Results and Conclusions

It was concluded that two test procedures are required: one for outdoor trials in natural precipitation and wind conditions; and one for laboratory trials in calm conditions.

The following procedures were recommended:

1. Test Procedure for Outdoor Trials

- The current Type I test procedure in outdoor conditions did not provide a good simulation of actual deicing operations; shortened fluid endurance times would result.
- The recommended procedure is based on an empty 7.5 cm cold-soak box, treated with 0.5 L of fluid. This protocol produced an accurate representation of the temperature decay rate demonstrated by wings in natural outdoor conditions.
- The recommended fluid temperature is 60°C with an acceptance range of + 2°C and 0°C. The recommended quantity is 0.5 L.
- The test surface is to be cleaned of contamination and wetted prior to applying fluid.
- The recommended method of applying fluid is with a fluid spreader positioned along the top edge of the test surface.

2. Test Procedure for Laboratory Trials

- The current Type I test procedure in laboratory calm conditions provided a sufficiently accurate representation of the temperature decay rate experienced by wings in natural outdoor conditions.
- The recommended fluid temperature is 20°C with an acceptance range of + 2°C and 0°C. The recommended quantity remains at 1.0 L.
- It is recommended that the method of applying fluid be the same as that described for outdoor trials.

Simultaneous trials on real wings and with the proposed test procedure for outdoor trials are still needed to confirm that endurance times are representative. These trials should be conducted early in the next winter season

(2001-2002), to support proceeding as soon as possible with actual fluid tests using the new procedures.

Use of a modern test wing would speed up this test process. To satisfy this need, the potential availability of a Canadair RJ wing should be explored.

Effect of SAE Guideline Temperature Ranges on Holdover Time

It was concluded that the current wide temperature range in the SAE holdover time guidelines, which extends from 0°C to -10°C, incurs significant penalties by bringing about shorter holdover times. A narrower range, which has -3°C as its lower limit, will provide much longer times.

As well, data on snowfall distribution indicate that the current range from 0°C to -10°C could encompass up to 70 percent of all snowfall events. A finer split would better represent actual snowfall distribution by temperature.

This page intentionally left blank.

SOMMAIRE

À la demande du Centre de développement des transports (CDT) de Transports Canada et de la Federal Aviation Administration (FAA), APS Aviation a entrepris un programme de recherche qui visait à élaborer un protocole devant servir à mesurer la durée d'efficacité des liquides de type I de la SAE.

Contexte

La série d'essais d'endurance réalisés sur les liquides de type I de la SAE pendant la saison 1999-2000 a conduit à recommander une diminution importante de la durée d'efficacité des liquides par rapport aux données précédemment publiées. Il demeurerait que ces anciennes durées d'efficacité étaient utilisées depuis leur publication, sans qu'aucun incident fâcheux ne soit survenu.

L'écart entre les anciennes et les nouvelles valeurs a suscité des discussions parmi les acteurs de l'industrie, ainsi que des doutes sur la validité du protocole d'essai. L'hypothèse généralement retenue pour expliquer les faibles valeurs d'endurance obtenues était que la méthode utilisée ne tenait pas compte du transfert de chaleur du liquide chauffé à la surface de l'aile.

Objectif

L'objectif du projet était d'élaborer un protocole d'essai qui permettrait de mesurer l'endurance des liquides de type I de la SAE dans des conditions de service réel. Le protocole idéal serait celui qui simulerait parfaitement les opérations de dégivrage/antigivrage menées sur de vraies ailes, dans un environnement naturel.

L'équipe de recherche a d'abord réuni l'information nécessaire pour appuyer l'élaboration d'un nouveau protocole d'essai. Voici les tâches auxquelles elle s'est consacrée :

- Revue des données pertinentes tirées des procès-verbaux d'essais
- Collecte de données sur le taux de décroissance du gradient thermique, afin d'établir un point de repère
- Choix d'une surface d'essai appropriée
 - Essais, en laboratoire et sur le terrain, sur diverses surfaces d'essai potentielles
 - Comparaison des résultats d'essais sur les surfaces d'essai potentielles avec les résultats d'essais sur des ailes

- Essais d'endurance des liquides sur les surfaces d'essai potentielles
- Essais des liquides en laboratoire, sur une aile de JetStar, et sur le terrain, sur une aile d'avion opérationnel, afin d'étudier dans quelle mesure les surfaces d'essai potentielles représentent bien des ailes d'aéronefs
- Définition et documentation d'un protocole d'essai mettant en jeu la surface d'essai retenue

Résultats et conclusions

L'étude a révélé la nécessité de deux protocoles d'essai : un pour les essais extérieurs, en présence de précipitations naturelles et de vent, et un pour les essais en laboratoire, dans des conditions calmes.

Voici les protocoles recommandés :

1. Protocole pour essais extérieurs

- Le protocole actuellement utilisé pour les essais extérieurs des liquides de type I ne simule pas de façon satisfaisante les opérations réelles de dégivrage; il en résulte une sous-estimation des durées d'efficacité.
- Le protocole recommandé utilise une boîte sur-refroidie de 7,5 cm vide, traitée à l'aide de 0,5 L de liquide. Ce protocole a permis une représentation fidèle du taux de décroissance du gradient thermique enregistré avec des ailes d'aéronefs dans des conditions extérieures naturelles.
- La température recommandée du liquide est de 60 °C, avec une tolérance de 2 degrés en plus et de 0 degré en moins. La quantité recommandée est de 0,5 L.
- La surface d'essai doit être exempte de toute contamination et il faut la mouiller avant d'appliquer le liquide.
- Il est recommandé d'appliquer le liquide à l'aide d'un étaleur placé le long du bord supérieur de la surface d'essai.

2. Protocole pour essais en laboratoire

- Le protocole actuellement en vigueur pour l'essai de liquides de type I dans des conditions calmes de laboratoire a fourni une représentation suffisamment précise du taux de décroissance du gradient thermique observé sur les ailes dans des conditions extérieures naturelles.
- La température recommandée du liquide est de 20 °C, avec une

tolérance de 2 degrés en plus et de 0 degré en moins. La quantité recommandée demeure 1,0 L.

- Il est recommandé d'appliquer le liquide de la même façon que pour les essais extérieurs.

Il reste à mener des essais simultanés sur des ailes d'aéronefs, en appliquant le protocole pour essais extérieurs, pour confirmer que les essais d'endurance sont représentatifs. Ces essais devraient être réalisés tôt au cours de l'hiver prochain (2001-2002), pour qu'il reste ensuite suffisamment de temps aux chercheurs pour mener des essais sur le terrain à l'aide des nouveaux protocoles.

L'utilisation d'une aile d'essai moderne accélérerait ce processus. Il y aurait lieu, à cette fin, d'explorer la possibilité de disposer d'une aile de RJ de Canadair.

Effet des plages de températures des tables de la SAE sur les durées d'efficacité

L'étude a permis de conclure que les plages de températures utilisées dans les tables de durées d'efficacité de la SAE (lesquelles s'étendent de 0 °C à -10 °C) mènent à une sous-estimation des durées d'efficacité, qui se répercute de façon sensible sur les coûts. Une plage restreinte, avec une limite inférieure de -3 °C, se traduira par des durées d'efficacité beaucoup plus longues.

De plus, selon les données sur la distribution des chutes de neige, jusqu'à 70 p. 100 de toutes les chutes de neige se retrouvent dans la plage de températures actuelle (de 0 °C à -10 °C). Des divisions plus fines représenteraient mieux la distribution réelle des chutes de neige selon la température.

This page intentionally left blank.

CONTENTS

	Page
1 INTRODUCTION	1
1.1 Background	1
1.2 Work Statement.....	3
1.3 Objective.....	3
2 METHODOLOGY.....	5
2.1 Current Test Method.....	5
2.2 Review of Test Data from Previous Studies.....	5
2.3 Tests to Collect Additional Data on Leading Edge Temperature Decay Rate.....	8
2.3.1 Lester B. Pearson International Airport, Toronto.....	8
2.3.2 Montreal International Airport, Dorval.....	8
2.3.3 Outdoor Temperature Trials on the JetStar Test Wing.....	9
2.4 Examination of Various Candidate Test Surfaces	10
2.4.1 Preliminary Laboratory Tests.....	10
2.4.2 Outdoor Temperature Profile Tests.....	12
2.5 Fluid Endurance Time on Test Surfaces	14
2.6 National Research Council (NRC) Canada Trials	14
2.6.1 Purpose	14
2.6.2 Procedure.....	16
2.7 Field Trials on Aircraft.....	17
2.7.1 Objectives	17
2.7.2 Procedure.....	19
3 DESCRIPTION AND PROCESSING OF DATA	35
3.1 Review of Related Test Data.....	35
3.1.1 Hot Water Deicing Trials.....	35
3.1.2 Deicing Only and First Step of Two-Step Deicing Trials	36
3.1.3 Hot Water Deicing of Aircraft.....	37
3.1.4 Aircraft Full-Scale Test Program for the 1996-1997 Winter.....	38
3.1.5 Data Review Summary	38
3.2 Tests to Collect Additional Data on Leading Edge Temperature Decay Rate.....	39
3.2.1 Generic Aircraft Leading Edge Temperature Profile	39
3.2.2 Lester B. Pearson International Airport, Toronto, 25 January 2001	40
3.2.3 Outdoor Temperature Trials on the JetStar Test Wing, 7 March 2001	43
3.2.4 Montreal International Airport, Dorval, 21-22 March 2001.....	43
3.3 Examination of Candidate Test Surfaces.....	46
3.3.1 Preliminary Laboratory Tests.....	46
3.3.2 Outdoor Temperature Profile Tests, 5 and 7 December 2000.....	47
3.3.3 Outdoor Temperature Profile Tests, 1 March 2001.....	50
3.3.4 Comparison of Ethylene-Based Type I Fluid to Kerosene Fuel, 1 Mar 2001.....	50
3.3.5 Effect of Rate of Fluid Application on Heat Transfer to the Test Surface	50
3.4 Fluid Endurance Times on Test Surfaces.....	52
3.5 NRC Canada Trials.....	52
3.6 Field Trials on Aircraft.....	57
4 ANALYSIS AND OBSERVATIONS	111
4.1 Review of Related Test Data.....	111
4.1.1 Wing Leading Edge	111
4.1.2 Influence of Wind on Cooling Rate	111
4.1.3 Heated Fluid Versus Unheated Fluid.....	112

TABLE OF CONTENTS

4.1.4 Quantity of Fluid Applied 112

4.2 Wing Leading Edge Temperature Profiles..... 113

4.2.1 Generic Wing Leading Edge Temperature Profile 113

4.2.2 JetStar Test Wing Temperature Profile..... 113

4.2.3 Effect of Fuel Load on Temperature Profile..... 114

4.2.4 Outdoor Trials on Saab 340 and B 737 Aircraft..... 115

4.3 Examination of Various Candidate Test Surfaces 116

4.3.1 Preliminary Laboratory Tests..... 116

4.3.2 Outdoor Temperature Profile Tests, 7 December 2000..... 116

4.3.3 Simultaneous Tests on Thick Aluminum Surfaces, Toronto Airport, 25
January 2001..... 119

4.3.4 Outdoor Temperature Profile Tests, 1 and 2 March 2000 119

4.3.5 Effect of Rate of Fluid Application on Heat Transfer to the Test Surface 122

4.3.6 Summary of Tests on Cold-Soak Box..... 122

4.3.7 Summary of Tests on Standard Flat Plate Procedure..... 122

4.4 Fluid Endurance Time on Test Surfaces 127

4.5 Effect of Temperature Range Limits on Holdover Time 127

4.5.1 Temperature Range 0°C to -10°C..... 134

4.5.2 Temperature Range 0°C to -3°C..... 134

4.6 NRC Canada Trials..... 137

4.6.1 Endurance Times in Snow 139

4.6.2 Effect of Freezing Rain on Surface Temperature 140

4.6.3 Endurance Times in Freezing Rain (10 g/dm²/hr) 141

4.6.4 Endurance Times in Freezing Rain (25 g/dm²/hr) 142

5 CONCLUSIONS 143

5.1 Test Procedure for Outdoor Trials..... 143

5.1.1 Outstanding Activities to Finalize the Test Protocol..... 144

5.1.2 Effect of Fuel Loads on the Proposed Test Protocol..... 144

5.1.3 Consideration of Cold-Soaked Wing Conditions 144

5.2 Test Procedure for Laboratory Trials 145

5.3 Selection of Temperature Ranges for SAE HOT Guidelines 145

5.4 JetStar Test Wing 145

6 RECOMMENDATIONS..... 147

REFERENCES 149

LIST OF APPENDICES

Appendix A: Terms of Reference – Project Description

Appendix B: Development of Type I Protocol Wing Leading Edge Temperature Profiles

Appendix C: JetStar Test Wing Leading Edge Temperature Profile

Appendix D: Trials to Determine Surface Temperature Profiles

Appendix E: Preliminary Examination of Potential Test Surfaces in Wind

Appendix F: Experimental Program Evaluation of Fluid Endurance Times on Candidate Test Surfaces

Appendix G: NRC Canada Trials for Type I HOT Test Protocol

Appendix H: Field Trials for Type I Test Protocol

LIST OF FIGURES

	Page
1.1 Effect of Rate of Precipitation on Endurance Time – Type I Diluted (10° Buffer)	2
3.1 Sample Wing Temperature Plot – HOT Water Skin Temperature Test at Dorval Airport	58
3.2 Wing Surface Temperature Decay Rate	59
3.3 Effect of Wind Speed, Volume Poured and Plate Thickness on Lag Time to Freeze Point.....	60
3.4 Varied Fluid Temperature – Tests Representing Snow Removal, Fluid Freeze Point and Surface Temperature Profile.....	61
3.5 Fluid Freeze Point and Surface Temperature Profile on Special Plates	62
3.6 Temperature Profiles of Test Surface and Fluid Freeze Point – First Step Trials 1997-1998.....	63
3.7 Effect of Fluid Amount on Temperature Profiles	64
3.8 Progression of Failures	65
3.9 Aircraft Leading Edge Temperature Profiles from Previous Tests.....	66
3.10 Aircraft Leading Edge Temperature Profiles	67
3.11 Average Wing Surface Temperature Profiles.....	68
3.12 JetStar Wing Surface Temperature Profiles, Wing Tank Empty.....	69
3.13 JetStar Wing Surface Temperature Profiles, Wing Tank 25% Filled.....	70
3.14 JetStar Wing Surface Temperature Profiles, Wing Tank 50% Filled.....	71
3.15 JetStar Wing Surface Temperature Profiles, Surface over Inner-Wing Tank, #2	72
3.16 JetStar Wing Surface Temperature Profiles, Surface over Mid-Wing Tank, #5.....	73
3.17 JetStar Wing Surface Temperature Profiles, Leading Edge, #7	74
3.18 JetStar Wing Surface Temperature Profiles, Outer Wing Surface, #10	75
3.19 JetStar Wing Surface Temperature Profiles, Outer Leading Edge, #11	76
3.20 Saab 340 Wing + Boxes/Plate Surface Temperature Profiles, Run #1	77
3.21 B-737 Wing + Boxes/Plate Surface Temperature Profiles, Run #1	78
3.22 Standard Plate Surface Temperature Profiles	79
3.23 Standard Plate Surface Temperature Profiles vs. Wing Leading Edge – from Previous Tests.....	80
3.24 7.5 cm Cold-Soak Box 40% Filled – Surface Temperature Profiles.....	81
3.25 C/FIMS Plate Surface (64 mm) Temperature Profiles.....	82
3.26 Standard Plate Surface Temperature Profiles vs. Wing Leading Edge, APS Test Site, Test 1.....	83
3.27 Standard Plate Surface Temperature Profiles vs. Wing Leading Edge, APS Test Site, Test 2.....	84

3.28 7.5 cm Box Plate Surface Temperature Profiles vs. Wing Leading Edge, APS Test Site, Test 1..... 85

3.29 7.5 cm Box Plate Surface Temperature Profiles vs. Wing Leading Edge, APS Test Site, Test 2..... 86

3.30 C/FIMS Plate Surface Temperature Profiles vs. Wing Leading Edge, APS Test Site, Test 1 87

3.31 C/FIMS Plate Surface Temperature Profiles vs. Wing Leading Edge, APS Test Site, Test 2..... 88

3.32 9.6 mm Plate Surface Temperature Profiles vs. Wing Leading Edge, APS Test Site, Test 1 89

3.33 9.6 mm Plate Surface Temperature Profiles vs. Wing Leading Edge, APS Test Site, Test 2..... 90

3.34 Effect of Wind on Standard 7.5 cm Box at 0.5 L Applied..... 91

3.35 Effect of Wind on Standard 7.5 cm Box at 1 L Applied..... 92

3.36 Effect of Wind on Box with 4.8 mm Surface at 0.5 L Applied..... 93

3.37 Effect of Wind on Box with 4.8 mm Surface at 1 L Applied..... 94

3.38 Effect of Wind on Box with 6.4 mm Surface at 0.5 L Applied..... 95

3.39 Effect of Wind on Box with 6.4 mm Surface at 1 L Applied..... 96

3.40 Effect of Simulated Fuel Load Surface Temperature Profiles 97

3.41 Effect of Rate of Fluid Application on Surface Temperature Profile..... 98

3.42 Effect of Rate of Precipitation on Endurance Time – Data Points 99

3.43 Effect of Rate of Precipitation on Endurance Time 100

3.44 Comparison of Fluid Endurance – JetStar Test Wing vs. Test Surfaces – Set 1 101

3.45 Comparison of Fluid Endurance – JetStar Test Wing vs. Test Surfaces – Set 2 102

3.46 Comparison of Fluid Endurance – JetStar Test Wing vs. Test Surfaces – Set 3 103

3.47 Comparison of Fluid Endurance – JetStar Test Wing vs. Test Surfaces – Set 5 104

3.48 Comparison of Fluid Endurance – JetStar Test Wing vs. Test Surfaces – Set 6 105

3.49 Comparison of Fluid Endurance – JetStar Test Wing vs. Test Surfaces – Set 7 106

3.50 Comparison of Fluid Endurance – JetStar Test Wing vs. Test Surfaces – Set 8 107

3.51 Comparison of Fluid Endurance – JetStar Test Wing vs. Test Surfaces – Set 9 108

3.52 Comparison of Fluid Endurance – JetStar Test Wing vs. Test Surfaces – Set 10..... 109

3.53 Plate/Box/Wing Surface Temperature Profiles – Runs 2 and 3..... 110

4.1 DC-9 Wing + C/FIMS Plate Surface Temperature Profiles, Run 3 120

4.2 7.5 cm Cold-Soak Box Temperature Profiles, Results from All Outdoor Tests 123

4.3 7.5 cm Cold-Soak Box Mean Curve..... 124

4.4	Comparison of 7.5 cm Cold-Soak Box Mean Curve to Wing Leading Edge Mean Curve.....	125
4.5	Comparison of 7.5 cm Box Std. Deviation to Wing Leading Edge	126
4.6	HOT Plate Temperature Profiles – Indoors	128
4.7	HOT Plate Temperature Profiles (Indoors) – Consolidated Data	129
4.8	HOT Plate Temperature Profiles (Indoors) – Comparison to Average Wing and Box	130
4.9	HOT Plate Temperature Profiles (Holdover Time Method) – Outdoors.....	131
4.10	HOT Plate Temperature Profiles (Holdover Time Method) – Outdoors – Consolidated Data	132
4.11	Plate Temperature Profile – Outdoors – Comparison to Average Wing and Box	133
4.12	Intersection of Wing Temperature and FFP Profiles at OAT -10°C	135
4.13	Intersection of Wing Temperature and FFP Profiles at OAT -3°C.....	136

LIST OF TABLES

	Page	
2.1	Sequence of Activities to Establish SAE Type I Fluid Test Protocol	6
2.2	Test Plan for Trials in Wind Conditions	13
2.3	Typical Test Plan for Fluid Endurance Times for Type I Protocol	15
2.4	NRC Canada Trials for Type I HOT Test Protocol.....	18
2.5	Field Trials for Type I HOT Test Protocol	20
3.1	Aircraft Leading Edge Temperature Profiles	41
3.2	Wing Temperature Profile Trials, January 25, 2001	42
3.3	JetStar Test-Wing Temperature Profile Trials.....	44
3.4	Wing Temperature Profile Trials, March 21 to 22, 2001	45
3.5	Test Surfaces Temperature Profile Trials.....	48
3.6	Temperature Profile Trials.....	49
3.7	Wing Temperature Profile Trials, March 1 to 2, 2001	51
3.8	Log of Fluid Endurance Tests in Snow.....	53
3.9	Type I Protocol Fluid Endurance Trials, JetStar Test Wing at NRC Canada CEF	55
4.1	Surfaces Tested in Conjunction with Aircraft Tests.....	115
4.2	Distribution of Snowfall Events Compared to HOT Table Range – Quebec, 1995 to 2000	138
4.3	Comparison of Endurance Times in Light Rain.....	142
4.4	Comparison of Endurance Times in Moderate Rain.....	142

LIST OF PHOTOS

	Page
2.1 Current Test Plate Surface.....	21
2.2 Current Method of Fluid Application	21
2.3 Field Tests on Operational Aircraft	23
2.4 Thermistor Probe Installation on Saab 340 Wing	23
2.5 7.5 cm Cold-Soak Boxes and Aluminum Test Surface Ready for Testing	25
2.6 Measuring Wind Speed with Hand-Held Anemometer	25
2.7 Proposed Method for Applying Fluid with a Spreader	27
2.8 Fluid Spreader Rate Control.....	27
2.9 JetStar Test Wing on Carriage.....	29
2.10 Wing Test Area	29
2.11 Leading Edge Grid.....	31
2.12 Wing Test Area Cleaned by Spraying	31
2.13 Wing Fluid Spreader	33
2.14 Test Stand beside Wing	33

GLOSSARY

APS	APS Aviation Inc.
CEF	Climatic Engineering Facility
FAA	Federal Aviation Administration
FFP	Fluid Freeze Point
HOT	Holdover Time
NCAR	National Center for Atmospheric Research
NRC Canada	National Research Council Canada
OAT	Outside Air Temperature
SAE	Society of Automotive Engineers, Inc.
TDC	Transportation Development Centre

This page intentionally left blank.

1 INTRODUCTION

At the request of the Transportation Development Centre (TDC) of Transport Canada and the Federal Aviation Administration (FAA) of the United States of America, APS Aviation undertook a research program to develop a protocol for measuring fluid holdover times of SAE Type I fluids.

1.1 Background

For several years, the Type I fluid holdover time range for snow conditions was 6 to 15 minutes. These values initially were based on operational experience and were substantiated in tests conducted in the early 1990s. In the winter of 1999-2000, a series of endurance time trials was conducted on SAE Type I fluids, using test parameters developed to test Type II and IV fluids. These tests resulted in a recommendation at the 2000 annual meeting of the SAE G-12 HOT Subcommittee held in Toulouse, France, that holdover times for snow be reduced to values significantly shorter than those previously published. Type I fluid holdover times before and after producing this new data are shown in Figure 1.1. At a precipitation rate of 10 g/dm²/hr, the fluid failure time was reduced from 15 minutes to 6 minutes; at a rate of 25 g/dm²/hr, the time was reduced from 6 minutes to 3 minutes.

The reduction in fluid endurance times led to concerned discussion at industry meetings and to the general realization that the testing method is suspect. It was generally believed that the reduction in endurance times was a result of test methodology that did not take into account the contribution of the heat transfer from the heated fluid to the wing surface. In deicing operations, Type I fluid is applied heated to clean frozen contamination from the wing. Any fluid remaining on the wing then provides some ongoing protection against refreezing. In contrast, Type II and IV fluids, when used for anti-icing protection, are applied unheated.

At the November 14-15, 2000 meeting of the SAE G-12 HOT Subcommittee, it was resolved that the *HOT committee will develop Type I testing protocols which consider the heat factor on simulated wing surfaces of various dilutions of Type I fluids for the purpose of developing Type I Holdover Tables that match operational use of the fluid.*

At that meeting, an associated discussion centred on the fact that whereas Type II and Type IV fluids diluted to 75/25 and 50/50 concentrations are sometimes used in heated form as a one-step deicing/anti-icing process, the test methodology for these fluids does not account for the heat factor. It was resolved that a test protocol which considers the heat factor involved

FIGURE 1.1
Effect Rate of Precipitation on Endurance Time
Type I Diluted (10° C Buffer)
Snow at -10° C

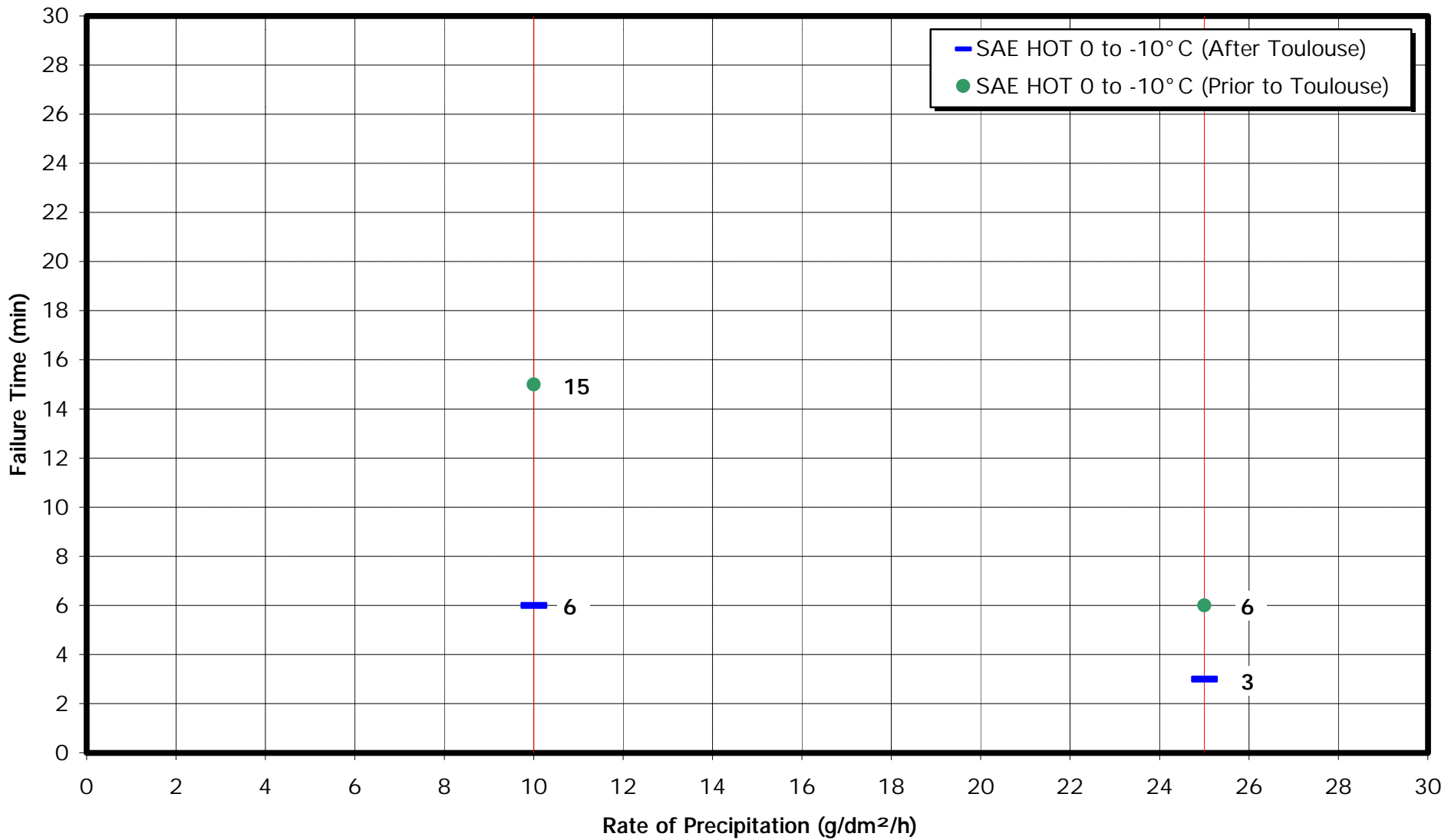

in this application would be developed for these fluids. This subject was not included in this study, and remains to be dealt with in a future study.

1.2 Work Statement

Appendix A presents an excerpt from the work statement for the APS Aviation 2000-2001 winter research program.

1.3 Objective

The objective of this project was to develop a protocol for measuring holdover times for SAE Type I fluids that reflect real field operations. The ideal protocol would simulate the full nature of actual deicing/anti-icing operations on real wings in the natural environment.

The protocol was to take into account the effect on endurance times of heat transferred to the wing from the heated fluid. To that end, the research was designed to provide a basis for a test surface that is thermodynamically similar to real wings in natural outdoor weather conditions. The influence of wing tank fuel on wing skin temperatures was also to be assessed and taken into account.

To achieve this objective, activities that progressively provided information to support development of a new test protocol were conducted. In overview, these activities were:

- Reviewing pertinent data from various test reports;
- Collecting data on wing temperature decay rate to serve as benchmarks for selecting a suitable test surface;
- Selecting a suitable test surface:
 - Examining prospective test surfaces in laboratory and field tests; and
 - Comparing test results from prospective test surfaces with data from tests on wings.
- Conducting fluid endurance time tests on prospective test surfaces;
- Conducting trials with JetStar test wing in laboratory conditions and with operational aircraft in natural conditions to examine how prospective test surfaces correspond to aircraft wings; and
- Defining and documenting test procedures using the selected test surface.

This page intentionally left blank.

2 METHODOLOGY

This section describes the overall approach, including test parameters and experimental procedures, followed in the development of a test protocol to replace the current test method.

The overall program included a sequence of activities as shown in Table 2.1.

2.1 Current Test Method

The current test method for measuring endurance times produced by Type I fluids does not differ for testing in laboratory and outdoor conditions. It consists of the following:

Test Surface

- aluminum plate
- 50 cm long by 30 cm wide
- 3.2 mm thick
- mounted with a slope of 10° to the horizontal on a test stand
- both top and bottom surfaces exposed to ambient conditions
- cleaned of any contamination prior to fluid application

Fluid Application

- fluid at room temperature (20°C)
- amount applied is 1 L
- fluid applied by pouring
- 1/3 L poured over the cleaned plate area and then removed by squeegee (rubber blade)
- remaining 2/3 L poured freely along the upper plate edge

Test plates on a test stand are shown in Photo 2.1. The current method of pouring is shown in Photo 2.2, in this case with the plate mounted on top of a wing surface.

2.2 Review of Test Data from Previous Studies

This activity involved a review of related data collected during past test programs. Results from these programs supported an improved understanding of the role that heat plays in delaying the formation of frozen contamination on aircraft surfaces.

TABLE 2.1

SEQUENCE OF ACTIVITIES TO ESTABLISH SAE TYPE I FLUID TEST
PROTOCOL

1.	Review of Related Test Data: <ul style="list-style-type: none">• Examine data from previous tests
2.	Determine wing leading edge temperature profiles to serve as a benchmark for evaluating prospective test surfaces: <ul style="list-style-type: none">• Analyze data from various previous tests• Gather further data for other aircraft types
3.	Examine various candidate test surfaces for suitability for testing: <ul style="list-style-type: none">• measure temperature profiles with different fluid applications (quantities, temperature, method of application)• Initial laboratory trials• Outdoor trials in wind conditions
4.	Compare fluid endurance time and fluid endurance time on selected candidate test surfaces versus current test procedure, in natural snow conditions.
5.	Conduct outdoor tests to compare endurance time of fluid during natural snow precipitation when applied on the proposed test surface(s) versus on the wing leading edge of operational aircraft: <ul style="list-style-type: none">• B737• Saab 340
6.	Measure leading edge temperature profiles for the JetStar test wing: <ul style="list-style-type: none">• with tanks empty• with tanks 25% filled• with tanks 50% filled
7.	Conduct tests in the NRC cold-chamber to compare Type I fluid endurance time on the proposed test surface(s) on the JetStar test wing, during artificial snow and freezing rain precipitation.

Previous studies on the use of hot water as the first-step fluid in a two-step deicing operation documented the contribution to holdover times due to heat transfer from the deicing fluid to the wing surface. These studies charted the rate of cooling of the wing surface at various outside ambient temperatures (OAT) and wind conditions, and then provided data on elapsed time for the wing surface to cool to 0°C and to OAT. The related reports are *Hot Water Deicing Trials for the 1994-1995 Winter* TP 12653E (1) and *Hot Water Deicing of Aircraft* TP 13483E (2).

During the winter of 1997-1998, an examination of the effectiveness of applying dilute fluids (with freeze points equal to or higher than OAT) to clean wings following periods of snowfall or freezing precipitation produced additional information on heat transfer to test surfaces and the subsequent temperature profile as the surface cooled. As well, an examination of fluid freeze point temperature limits for fluids used as the first-step fluid in a two-step deicing operation developed two kinds of data: cooling profiles of test surfaces under precipitation following treatment with heated Type I fluids; and the concurrent rate of dilution of the applied fluid. These studies were reported in *Aircraft Deicing Fluid Freeze Point Buffer Requirements, Deicing Only and First Step of Two-Step Deicing* TP 13315E (3), and *Aircraft Deicing Fluid Freeze Point Buffer Requirements for Deicing Only Conditions* TP 13478E (4).

All of the foregoing studies involved outdoor tests on operational aircraft in natural conditions as well as laboratory tests in controlled conditions.

An examination of the test methodology for simulating a cold-soaked wing, *Validation of Methodology for Simulating a Cold-Soaked Wing* TP 12899E (5), provided data on temperature time-constants for cold-soaked wings of aircraft as well as for test units.

Further information on operational temperatures of wing surfaces following refuelling was provided in the study *Aircraft Ground Operations in Canadian Winter Weather: Taxi Times, Wing Temperatures and Hot De-Icing* TP 12735E (6).

Trials to correlate the performance of deicing and anti-icing fluids on aircraft surfaces with the performance on flat test plates provided data regarding both the location on wings where fluid first fails and the subsequent fluid failure patterns. *Aircraft Full-Scale Test Program for the 1996/97 Winter* TP 13130E (7) is the principal report on this subject. The data are particularly useful in establishing which areas of the wing should be simulated in a test program.

The foregoing studies were conducted and reported by APS Aviation except for that reported in TP 12735E (6), which was performed by Aviation Research Corporation (ARC).

2.3 Tests to Collect Additional Data on Leading Edge Temperature Decay Rate

2.3.1 Lester B. Pearson International Airport, Toronto

To gather wing temperature profiles on as many aircraft as possible, it was decided that the most efficient approach would be to conduct tests on parked aircraft, thereby avoiding the need to tow them to deicing areas. As a limited level of deicing activity was permitted at the passenger terminal gate positions at Toronto airport, arrangements were made with Air Canada to conduct tests on aircraft parked overnight at Terminal 2 gate positions.

Tests on each aircraft consisted of first installing thermistor probes on the wing leading edge. The forward part of the wing, including the leading edge, was then sprayed with heated fluid, and skin temperatures were logged while the wing gradually cooled. Spraying was performed by Air Canada deicing personnel, using Air Canada deicing vehicles. The temperature and quantity of applied fluid were recorded. The temperature of the fluid, measured at the nozzle, ranged from 58°C to 76°C.

A reference test surface, also instrumented with a thermistor probe, was tested simultaneously with the wing. For the test on the reference surface, heated fluid was taken from the deicing vehicle. The fluid temperature was then adjusted to 60°C. A thick aluminum plate (6.4 mm) with an insulated backing (5 cm of blue rigid styrofoam insulation) was used as a reference surface for these tests.

For the test, the APS test team was split into two working groups. The first group was responsible for installing and removing sets of thermistor probes on wings. The second group then conducted the actual temperature profile test along with the Air Canada deicing crew.

The complete test procedure is reported in Appendix B.

2.3.2 Montreal International Airport, Dorval

Some measurements of wing temperature profiles were conducted during field test sessions planned for examining fluid endurance times on

wings of operational aircraft. Trials to measure temperature decay rates on wings already instrumented with thermistor probes were conducted while waiting for forecasted snow to begin. Candidate test surfaces were treated at the same time and their temperature profiles measured. This session provided a valuable comparison between temperature profiles on wings and on final candidate test surfaces exposed to common weather conditions.

The two test aircraft (Saab 340 and B 737) were parked side by side (Photo 2.3) at the Central Deicing Facility (CDF), and the two close-by wings were instrumented with thermistor probes. Photo 2.4 shows thermistor probes installed on the Saab 340 wing surface. Test stands for testing candidate test surfaces are seen in the background. Photo 2.5 shows some candidate test surfaces (7.5 cm cold-soak boxes) and the current aluminum test plate on the test stand, with thermistor probes installed. Photo 2.6 shows the method used to measure wind speed for all outdoor trials (hand-held anemometer at 2 m above ground). The B 737 aircraft wing in the background is being sprayed as part of the test.

2.3.3 Outdoor Temperature Trials on the JetStar Test Wing

During January and February 2001, the condition of the JetStar test wing was upgraded, and the wing was subsequently mounted on an improved carriage. The wing was intended as a surface for laboratory trials when comparing fluid endurance times for the wing with those for test surfaces. Hence, it was important to document wing temperature profiles. These trials served two purposes:

- comparing the test wing temperature profiles to profiles from other aircraft; and
- examining the effect of varied fuel loads on wing temperature profiles.

In preparation for these trials, in which a Type I fluid was used to simulate fuel in the JetStar test wing, a test was conducted at the APS test site. Two insulated aluminum boxes known as cold-soak boxes were loaded with equal quantities of Type I fluid and kerosene. Tests were conducted with boxes 50% filled (5 L), and then completely filled (10.4 L). Heated fluid was applied to the box surfaces and the surface temperatures were logged. The test examined whether any difference in surface temperature profiles resulted from Type I fluid (ethylene-based) versus kerosene. The differences were not substantial, and indicated that use of Type I fluid as a test substitute for fuel is acceptable.

The deicing fluid used to simulate fuel was loaded into the wing fuel tanks from a second deicing truck that had just been filled from storage tanks. At time of loading into the wing tank, the fluid temperature was 14°C, reflecting the fluid storage temperature. Although fluid at ambient temperature would have been preferred, the higher temperature did not seem to affect results.

The JetStar test wing trials were conducted at Ottawa International Airport, at its central deicing facility. The test wing, mounted on its carriage, was towed to the facility for testing. Hudson General sprayed the test wing. These trials were very similar to those conducted at Toronto airport, with the following exceptions:

- a. A different test surface was selected for comparison with the wing. In these trials, a 7.5 cm deep cold-soak box (empty) was tested simultaneously with the wing test. As well, a flat plate was treated in accordance with the standard HOT test procedure.
- b. Three trials were conducted:
 - The wing temperature profile was measured with empty fuel tanks.
 - Fuel tanks were then partially filled by boarding 750 L (25% filled) of deicing fluid; the wing was then re-sprayed and the temperature profile measured.
 - Fuel tanks were then filled to 50% capacity by boarding an additional 750 L; the wing was re-sprayed and the temperature profile measured.

The complete test procedure is reported in Appendix C.

2.4 Examination of Various Candidate Test Surfaces

2.4.1 Preliminary Laboratory Tests

2.4.1.1 Test Location

An initial series of trials on prospective test surfaces was conducted in a cold chamber at the Centre de recherche industrielle du Québec (CRIQ) in Montreal.

2.4.1.2 Test Procedure

The objective was to collect surface temperature decay data for prospective test surfaces following application of SAE Type I fluid in various quantities and temperatures. These data were then used to develop a series of cooling curves (temperature profiles) for comparison with similar curves developed for actual wings.

The prospective surfaces tested were:

- Standard aluminum test plate; 3.2 mm (0.13 in) thick
- Aluminum test plate used for C/FIMS installation; 6.4 mm (0.25 in) thick
- Cold-soak box test unit; 7.5 cm deep; filled to 1/3 capacity (4 L) with diluted Type I propylene-based fluid
- Cold-soak box test unit; 7.5 cm deep; filled to 1/3 capacity (4 L) with diluted Type I propylene-based fluid; top surface thickened by attaching a standard test plate
- Cold-soak box test unit; 15 cm deep; filled to 1/2 capacity (13 L) with diluted Type I propylene-based fluid

The test fluid was SAE Type I fluid (UCAR ADF). Fluid quantities and temperatures were tested in combinations of 60°C and 70°C and 0.5 L and 1.0 L. The Type I fluid was diluted to a freeze point 10°C below ambient temperature. The fluid was applied with a spreader (Photo 2.7). These spreaders had been made by APS for a previous study and had provided a consistent form of fluid application. The spreader is made from a length of PVC pipe, 30 cm long and 15 cm in diameter. The spreader is placed horizontally at the top end of the test plate, supported at a fixed distance above the plate surface by wood forms at each end. The upper side of the pipe has a large opening, which allows fluid to be poured quickly into the pipe. The underside has several drilled holes, 4.8 mm (3/16 in) diameter, at equal intervals along the pipe. The original design provided for 24 holes; this was reduced to 12, during the development of the test protocol, to control the rate of application. The 12-hole configuration shown in Photo 2.8 provided an application time of 10 seconds.

Base case trials, using current holdover time (HOT) procedures, were conducted for reference purposes. In these tests, fluid was applied by pouring 1/3 L of fluid over the entire test surface and then wiping the surface clean using a rubber squeegee; 2/3 L was then poured along the top edge of the plate and allowed to run down and spread over the plate surface.

The complete test procedure with test plan is included in Appendix D.

2.4.2 Outdoor Temperature Profile Tests

2.4.2.1 Test Location

These tests were conducted at the APS test site at Montreal International Airport (Dorval). Several sessions were conducted in order to experience a variety of temperatures and wind speeds.

2.4.2.2 Test Procedure

The objective of these tests was to record the rate of temperature decay for prospective test surfaces at various OATs and wind speeds. These temperature profiles were then compared to the wing leading edge temperature profiles to select surfaces that were most representative.

The general procedure was to treat candidate surfaces with heated fluid and to then measure the rate of surface temperature decay. Temperature profiles produced by the standard method of testing Type I HOT were recorded simultaneously. Temperature decay was logged with the use of thermistor probes attached to each surface. OAT and wind speed were recorded during each test. Fluids were applied using a fluid spreader, except for tests following the standard method described earlier.

Tests were conducted at night or in overcast conditions to reduce radiant heating of test surfaces. In some test sessions, a large electric fan was used to generate the wind speeds desired as test conditions.

The types of surfaces and fluid amounts tested are shown in the test plan included as Table 2.2.

As well, these sessions were used to evaluate the effect of varying the rate of fluid application.

The influence that fuel in wing tanks has on wing surface temperature profiles was explored further in these tests. The cold-soak boxes that were being examined as potential Type I protocol

TABLE 2.2

Test Plan for Trials in Wind Conditions

OAT to be -5°C or lower

Wind to be 15 km/h or greater

Skies to be overcast (no sun) or nighttime

Test #	OAT (°C)		WIND (km/h)				Surface	Fluid Amt. (L)	Fluid Temp. (°C)	Type of Appl.	Start time/date	Data File Name (Use test # for name)	Comments
	Before	After	0	5	10	15							
1							std plt-insul-p2	0.5	60	Spreader			
2							C/FIMS plt-p3	0.5	60	Spreader			
3							C/FIMS plt-insul-p4	0.5	60	Spreader			
4							9.6 mm plate-p5	0.5	60	Spreader			
5							9.6 mm plate-insul-p6	0.5	60	Spreader			
6							7.5 cm bx-empty-p7	0.5	60	Spreader			
7							7.5 cm bx-4l-p8	0.5	60	Spreader			
8							7.5 cm bx-full-p9	0.5	60	Spreader			
9							<i>std plt-p1</i>	<i>1</i>	<i>20</i>	<i>Pour</i>			
10							std plt-insul-p2	1	60	Spreader			
11							C/FIMS plt-p3	1	60	Spreader			
12							C/FIMS plt-insul-p4	1	60	Spreader			
13							9.6 mm plate-p5	1	60	Spreader			
14							9.6 mm plate-insul-p6	1	60	Spreader			
15							7.5 cm bx-empty-p7	1	60	Spreader			
16							7.5 cm bx-4l-p8	1	60	Spreader			
17							7.5 cm bx-full-p9	1	60	Spreader			
18							<i>std plt-p1</i>	<i>1</i>	<i>20</i>	<i>Pour</i>			

Enter Thermistor #s

Std Plate Surface = 3.2 mm thick

C/FIMS Surface = 6.4 mm thick

9.6 mm plate = 9.6 mm thick

7.5 cm bx = 7.5 cm cold-soak box with 3.2 mm surface

Surface	6" Left	6" Right
std plt-p1		
std plt-insul-p2		
C/FIMS plt-p3		
C/FIMS plt-insul-p4		
9.6 mm plate-5		
9.6 mm plate-insul-p6		
7.5 cm bx-empty-p7		
7.5 cm bx-4l-p8		
7.5 cm bx-full-p9		

test surfaces were filled with various levels of fluid to simulate partially and completely filled wing fuel tanks. Another test was conducted to examine the suitability of using an SAE Type I fluid to simulate actual aircraft jet fuel.

The procedure for these tests is included as Appendix E.

2.5 Fluid Endurance Time on Test Surfaces

The purpose of this series of tests was to compare the fluid endurance times produced on candidate test surfaces when using a new fluid application procedure with those produced by the current standard method.

Several potential test surfaces were evaluated as well as several fluid quantities. Base case tests using the existing HOT procedure were run in parallel to provide an ongoing consistent basis for comparison of results.

Tests were conducted on various occasions during snowstorms, thereby generating data at various ambient temperatures and wind speeds.

A typical test plan for one test is shown in Table 2.3.

In addition to measuring fluid endurance times, the research team collected data on surface temperature decay rates and fluid dilution rates. Surface temperatures were logged with thermistor probes attached to each test surface. Fluid dilution was measured by progressively sampling fluid strength with a Brixometer.

Ambient weather conditions (snow rate, OAT, wind speed) were recorded in accordance with standard holdover test procedures.

The procedure for this series of tests is reported as Appendix F.

2.6 National Research Council (NRC) Canada Trials

2.6.1 Purpose

The purpose of these trials was to compare fluid endurance times measured on the JetStar test wing surfaces with those on candidate test surfaces under the same ambient and precipitation conditions. Photo 2.9 shows the test wing mounted on its carriage outside the cold chamber building (U88) at NRC Canada.

TABLE 2.3
Typical Test Plan for Fluid Endurance Times for Type I Protocol

STAND POSITION	SURFACE TYPE	FLUID		RATE SEQUENCE
		AMOUNT (L)	TEMP (°C)	
1	Rate Pan			
2	C/FIMS insulated	0.5	60	2 nd
3	C/FIMS insulated	1	60	3 rd
4	7.5 cm box (empty)	0.5	60	
5	Standard plate for HOT test	1	20	1 st
6	Std plate for BRIX msmt	0.5	60	

C/FIMS = 6.4 mm thick plate

7.5 cm box = 7.5 cm cold-soak box with 3.2 mm thick surface

Standard plate = 3.2 mm thick plate

2.6.2 Procedure

Simultaneous trials on the JetStar test wing and on test surfaces were conducted in controlled laboratory conditions under artificial precipitation. The entire wing was not used for these trials. Rather, a limited test area was defined and marked with tape. This allowed the application of fluid in a controlled and repeatable way, like the one used to apply fluid on the test surfaces. The wing test area (1.5 m²) was a rectangle measuring 1 m along the leading edge and 1.5 m along the chord. A further 0.5 m buffer zone was marked along each side of the test area. Fluid was applied to the total area (4 m²) when testing, with the objective of reducing lateral transfer of heat from the test area to the surrounding wing. Photo 2.10 shows the test area marked out on the wing surface with the surrounding buffer zone. Thermistor probes were installed in a pattern within the test area and at several points outside the test area to identify heat loss into the surrounding wing.

In these wing trials, primary attention was given to fluid failure on the leading edge area. As an aid to calling failures on the leading edge and to estimating percentage area of the leading edge that was affected by failure, a grid was marked on the leading edge test area. The grid is shown in Photo 2.11. Various thermistor installations are shown in this photo.

For the first test, fluid was applied by spraying. The spray equipment was previously assembled and used for testing by APS. A reservoir of heated fluid was provided by household water heaters. This represented standard deicing procedures, wherein a heated fluid spray is used to remove snow contamination. The operator was instructed to spray until the test area was cleaned of snow, and the quantity of fluid applied was recorded. Photo 2.12 shows the test area after removing the snow by spraying. The snow on the remainder of the wing was untouched. This photo shows also the placement of rate pans on the wing, just outside the test area, to measure precipitation rates.

For the remainder of the tests, the test area was first cleaned using scrapers and squeegees. The fluid was then applied on the wing test area using a large fluid applicator similar in design to the spreader used to treat test surfaces. The spreader, being moved rearward over the wing, is shown in Photo 2.13. The spreader was designed to apply fluid over the buffer zone as well as the test area. The application was started at the leading edge, which allowed fluid to run forward onto the front part of the wing as the spreader was moved to the top and rear of the wing.

The fluid was applied from the spreader at a temperature of 60°C and at a rate equivalent to the 0.5 L used on the test surfaces. Practice runs were required to calibrate fluid temperature loss in the spreader (corrected by overheating the fluid) and the correct speed of spreader movement to ensure that the fluid was applied evenly over the test area.

Candidate test surfaces were subjected to the same precipitation as the wing and treated with SAE Type I fluid according to proposed test procedures (0.5 L at 60°C with the fluid spreader). Base case tests, using the existing Type I test procedure on flat plates, were conducted to serve as a reference. Initial attempts to produce snow rates on a stand beside the wing (Photo 2.14 shows the low visibility under these conditions) that would be consistent with rates on the wing test area were unsuccessful. This problem was solved by placing test surfaces on the wing, where they were exposed to the same rate as the wing. Alternating tests were then conducted on wing and test surfaces.

Fluid endurance times, surface temperature profiles, and fluid dilution rates on the wing and the test surfaces were measured and compared. Planned laboratory conditions for the trials were:

- snowfall at 25g/dm²/h
- OAT of -15°C
- calm wind conditions

As the trials progressed, it was decided to test also in simulated freezing rain conditions:

- freezing rain at 10g/dm²/h and 25g/dm²/h
- OAT of -10°C
- calm wind conditions

The planned test matrix for wing and test surfaces is given in Table 2.4. It describes fluid strength and temperature for each trial run.

The complete test procedure is reported in Appendix H.

2.7 Field Trials on Aircraft

2.7.1 Objectives

The purpose of these tests was to confirm that fluid endurance times on candidate test surfaces using projected test procedures are representative of fluid endurance times experienced on aircraft wing surfaces.

TABLE 2.4

NRC Canada Trials for Type I HOT Test Protocol

Ambient temperature -10°C

Precipitation – Snow at 25 g/dm²/hr

Wind calm

R U N	TESTS ON WING				TESTS ON SURFACES				
					CANDIDATE SURFACES			STD HOT TEST	
	FLUID FREEZE POINT (°C)	FLUID TEMP (°C)	FLUID QT'Y (L/m ²)	SNOW DEPTH (cm)	FLUID FREEZE POINT (°C)	FLUID TEMP (°C)	FLUID QT'Y (L)	FLUID TEMP (°C)	FLUID QT'Y (L)
1a	-20	60	As sprayed	> 2.5	-20	60	.5-1	20	1.0
1b	-20	60	As sprayed	> 2.5	-20	60	.5-1	20	1.0
2a	-20	60	3.3	0	-20	60	.5-1	20	1.0
2b	-20	60	3.3	0	-20	60	.5-1	20	1.0
3	-20	40	3.3	0	-20	40	.5-1	20	1.0
4	-20	20	3.3	0	-20	20	.5-1	20	1.0
5	Std strength	60	3.3	0	-20	60	.5-1	20	1.0

2.7.2 Procedure

Simultaneous trials on aircraft and test surfaces were planned. Candidate test surfaces mounted on a test stand were placed near the test aircraft, and subjected to the same natural precipitation and wind as the aircraft wing. The test surfaces were treated with SAE Type I fluid, according to proposed test procedures as well as the existing Type I test procedure, while the aircraft was deiced in accordance with standard deicing procedures.

Desired weather conditions for the trials were:

- moderate to heavy snowfall
- OAT in the range of -5°C to -15°C
- wind speeds in the range of 15 km/h to 25 km/h.

Test fluid was mixed to two concentrations: a fluid freeze point buffer of 10°C and full operational strength.

The test plan examined the effect of removing contamination by allowing snow to accumulate on aircraft surfaces between test runs. The operator was instructed to spray according to standard procedure, producing a clean wing surface. The applied fluid quantity was recorded.

Data collected in these trials included:

- fluid temperature, quantity, and initial strength
- ambient conditions: OAT, wind speed, precipitation rate
- aircraft fuel: quantity in tanks and temperature
- depth of contamination on wing at start of test
- temperature profiles of wing and test surfaces
- brix profile of fluid on wing and on a test surface
- failure times and patterns on wing and on test surfaces

The test plan is shown in Table 2.5. The complete test plan is given in Appendix H.

TABLE 2.5

Field Trials for Type I HOT Test Protocol

TEST SESSION	RUN	AIRCRAFT TYPE	OAT (°C)	FLUID FREEZE POINT (°C)	FLUID TEMP (°C)	FLUID QUANTITY (L)	SNOW DEPTH ON WING (cm)
1	1	B 737	-5 to -15	OAT – 10° buffer	As sprayed	As sprayed	> 1cm
1	2	B 737	-5 to -15	OAT – 10° buffer	As sprayed	As sprayed	> 1cm
1	3	B 737	-5 to -15	Full strength	As sprayed	As sprayed	> 1cm
2	4	Saab 340	-5 to -15	OAT – 10° buffer	As sprayed	As sprayed	> 1cm
2	5	Saab 340	-5 to -15	OAT – 10° buffer	As sprayed	As sprayed	> 1cm
2	6	Saab 340	-5 to -15	Standard mix	As sprayed	As sprayed	> 1cm

Photo 2.1
Current Test Plate Surface

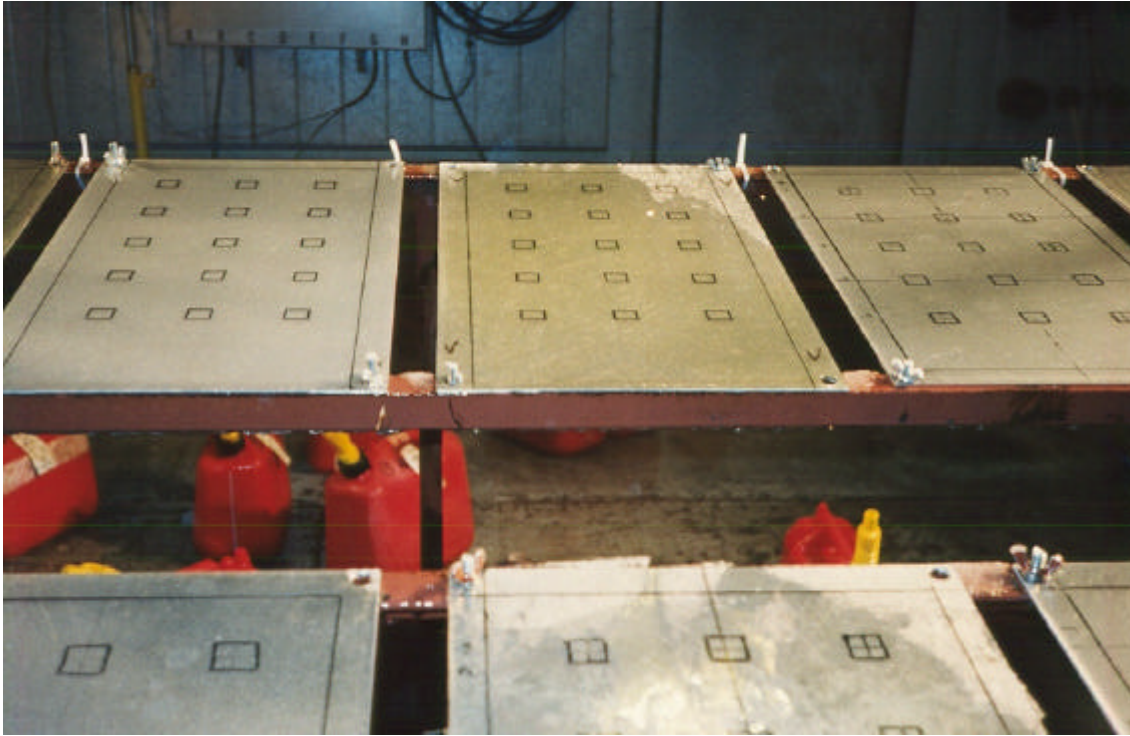

Photo 2.2
Current Method of Fluid Application



Photo 2.3
Field Tests on Operational Aircraft



Photo 2.4
Thermistor Probe Installation on Saab 340 Wing



Photo 2.5
7.5 cm Cold-Soak Boxes and Aluminum Test Surface Ready for Testing



Photo 2.6
Measuring Wind Speed with Hand-held Anemometer



Photo 2.7
Proposed Method for Applying Fluid with a Spreader



Photo 2.8
Fluid Spreader Rate Control

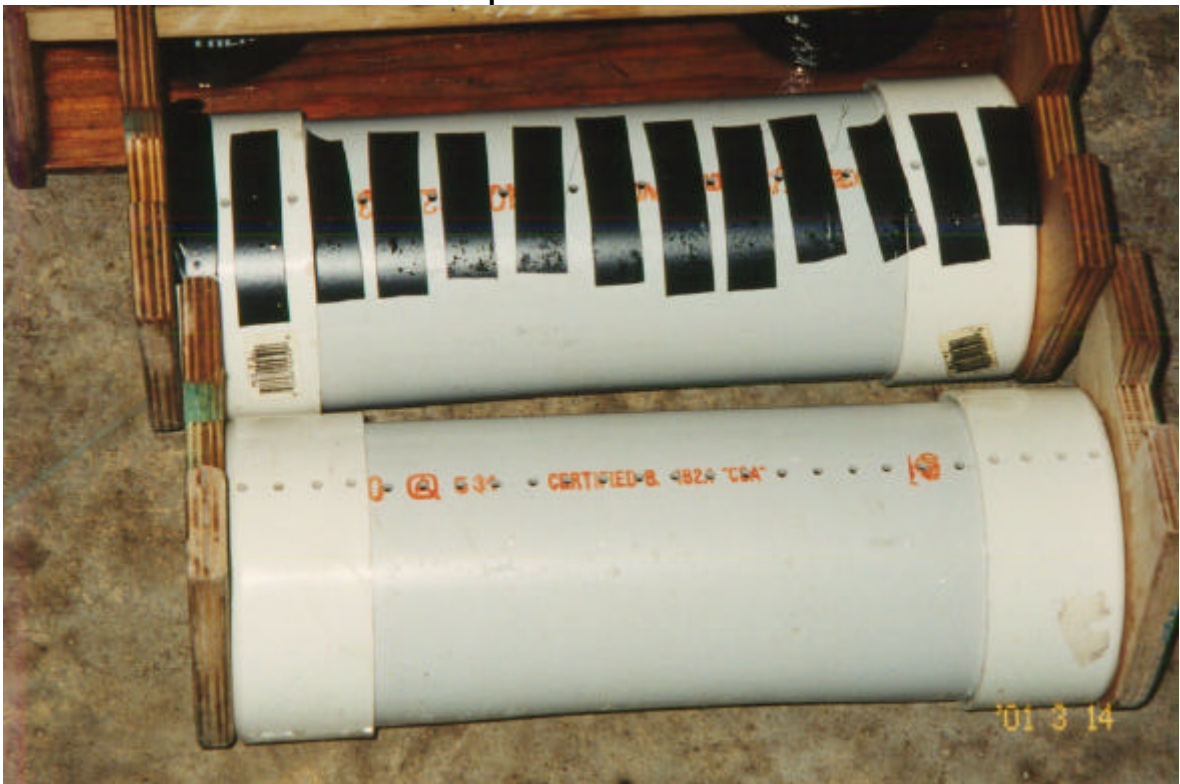

Photo 2.9
JetStar Test Wing on Carriage



Photo 2.10
Wing Test Area



Photo 2.11
Leading Edge Grid

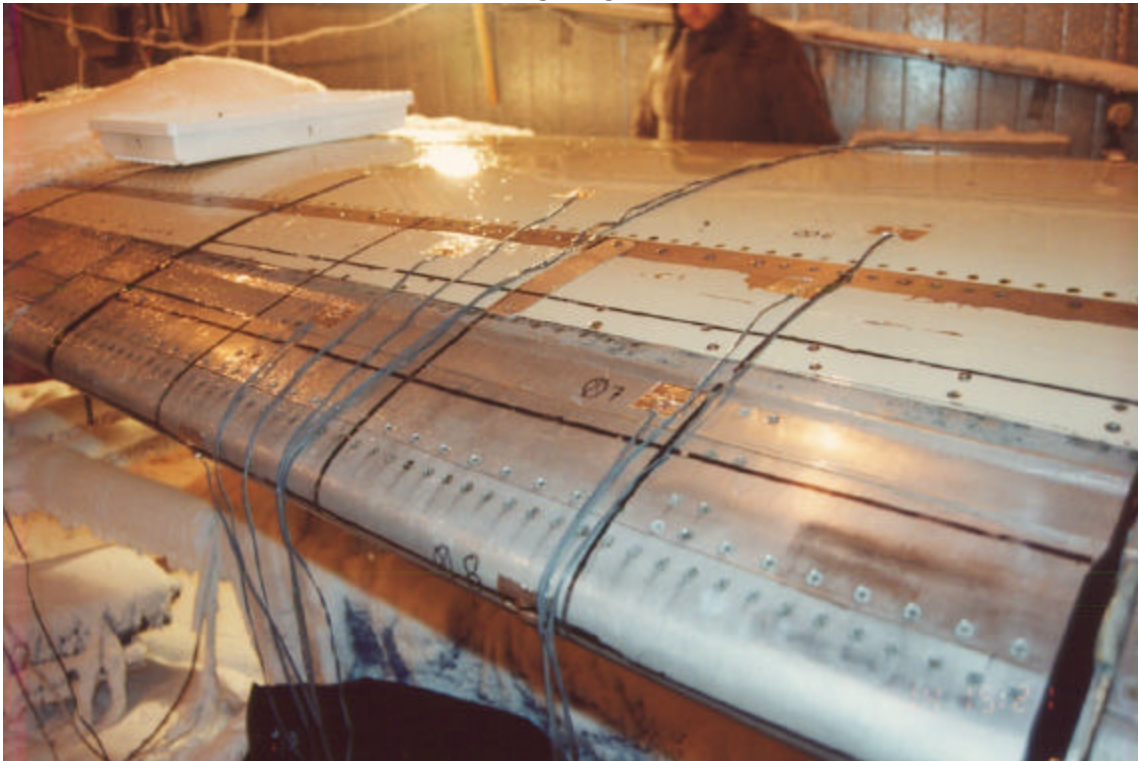

Photo 2.12
Wing Test Area Cleaned by Spraying



Photo 2.13
Wing Fluid Spreader



Photo 2.14
Test Stand beside Wing



3 DESCRIPTION AND PROCESSING OF DATA

This chapter describes the test data examined in the study, including data reported in past studies and newly generated data. A large number of figures representing data in chart format resulted. For ease of reading, all figures for this chapter are presented at chapter end.

3.1 Review of Related Test Data

3.1.1 Hot Water Deicing Trials

Results of this study were described in the report:

- *Hot Water Deicing Trials for the 1994-1995 Winter* TP 12653E (1).

This study was commissioned to examine the OAT lower limit for application of hot water as a first-step fluid, and decide whether the limit could safely be lowered beyond -3°C . Three field test sessions were performed on a McDonnell Douglas DC-9 aircraft in non-precipitation conditions at a range of OATs and wind speeds. The wing surface was instrumented with thermistor probes to record the time to cool to 0°C and to ambient temperature following the spray application of heated water. The fuel levels in the wing tanks were about one quarter full, less than the quantity required to wet the upper wing skin (about two thirds full).

Operators familiar with hot water deicing procedures sprayed the wing. Any ice remaining from previous tests was removed in the course of spraying; otherwise, the wing surface was clean at the start of each test.

Data from these tests produced a series of temperature decay rate profiles (temperature versus time) for various points on the wing. A typical profile is shown in Figure 3.1. The temperature peaks sharply at the time of fluid application and then progressively cools to ambient. As the temperature falls through 0°C , a brief rise in temperature can be seen when the water freezes, demonstrating the accuracy and sensitivity of the temperature measurement. A variety of similar curves produced for locations on the top of the main wing, the leading edge, and flight control surfaces (Figure 3.2) demonstrate the wing surface temperature decay rate for the various locations following the application of heated fluid.

Brief laboratory trials were conducted to examine the influence that wind exerted on the rate of cooling. Figure 3.3 shows the result on test

surfaces of various thicknesses, treated with various quantities of heated fluid, and at various wind speeds. The reported trials were conducted at controlled wind speeds in the NRC Canada cold chamber (calm, 10 km/h and 26 km/h), at OAT -5°C. The interval for the surface to cool to 0°C (y-axis values) is plotted versus wind speed. These tests indicated that the time for temperature to drop to 0°C decreased by a factor of four in a 26 km/h wind as compared with calm conditions. The thicker plates cooled more slowly, reflecting their greater capacity for absorbing heat. Applying greater amounts of fluid extended the cooling times of the thicker plates, but little benefit was noted for the thin plates.

3.1.2 Deicing Only and First Step of Two-Step Deicing Trials

These trials were conducted to examine limitations on Type I fluid dilution when used for deicing in specific conditions. The study was conducted over two seasons and one season's results are reported in each of following reports:

- *Aircraft Deicing Fluid Freeze Point Buffer Requirements Deicing Only and First Step of Two-Step Deicing* TP 13315E (3)
- *Aircraft Deicing Fluid Freeze Point Buffer Requirements for Deicing Only Conditions* TP 13478E (4).

This study examined enhancement to the strength of fluids as a result of water evaporating from the fluid mix in dry conditions in calm and wind. Fluids were applied at various temperatures, in various quantities, and on various types of surface. The temperature profile of the test surface was recorded as well as the resulting fluid strength. These data provide more information on potential test surfaces for comparison with wing data. Also, the test results provide information on the influence of fluid quantity and temperature and of wind on the surface temperature decay rate.

Figure 3.4 shows the results of one such study of the effect of varying fluid temperature. The peak temperature and surface temperature profiles resulting from fluid applied at 60°C are noticeably above those resulting from fluid applied at 40°C. The influence of the higher fluid temperature on enhancement of fluid strength is shown by fluid freeze point profiles dropping to colder values for the hotter fluid.

The effect of materials used in fabricating various components of modern wing surfaces was also examined. Figure 3.5 shows significant variances in cooling curves for typical composites and aluminum. These differences must be borne in mind when selecting a test surface to simulate any particular area of a wing.

The *First-Step* study examined the limits of the strength of fluids used as the first-step fluid in a two-step deicing operation. These tests were conducted in artificial freezing rain with and without wind. The rate of dilution of the applied fluid was measured as it progressively absorbed precipitation and its freeze point gradually rose. The resulting profiles for surface temperature and fluid freeze point (FFP) were plotted as shown in Figure 3.6. This type of plot is important, as it portrays the fluid-freeze delay mechanisms at work, and enables assessment of their individual contributions to the delay in freezing.

The interaction between surface temperature and fluid freeze point is illustrated; freezing is expected to occur when the two temperatures are equal.

The effect of wind on the time to freeze is clearly shown; the intersection of the surface temperature and FFP curves occurs earlier due to the faster rate of cooling with increased wind.

The speed with which the fluid strength diminishes, expressed as a rise in FFP, is shown (here under freezing rain at 25 g/dm²/h). After 5 to 6 minutes, the concentration of glycol in the fluid has fallen virtually to zero.

The importance of heated fluid versus fluid at ambient temperature can be inferred from the chart. Had the fluid been applied at a temperature of -10°C (OAT), freezing would have occurred after two minutes. For the particular surface under test, that time is more than doubled with the application of heated fluid (in calm conditions).

3.1.3 Hot Water Deicing of Aircraft

The interaction of surface temperature and FFP was also examined in the study *Hot Water Deicing of Aircraft* TP 13483E (2), in which the effectiveness of applying heated fluid was compared with that of applying hot water. Other test parameters of interest here were: influence of wind speed, OAT, fluid amount, and test surface composition.

Figure 3.7 shows the direct relation between greater fluid amounts and time to cool, and thereby time to freeze. The temperature profile resulting from applying a fluid quantity of 1020 ml reaches a higher peak than, and lies above, the profile resulting from a smaller fluid quantity such as 306 ml. The additional fluid increases the elapsed time for the surface temperature to cool to 0°C. The direct relationship

between larger fluid quantity and longer time to freeze is further shown in the chart in the small inset of Figure 3.7.

3.1.4 Aircraft Full-Scale Test Program for the 1996-1997 Winter

The study *Aircraft Full-Scale Test Program for the 1996/97 Winter* TP 13130E (7) provides some insight as to which areas of the wing should be simulated in the proposed test protocol. In this study, trials to correlate the performance of de/anti-icing fluids on aircraft surfaces with the performance on flat test plates provided data regarding the location on wings where fluid first fails and the subsequent fluid failure patterns. Figure 3.8 charts the point of initial failure and subsequent failure progression on the wing diagrams of a B 737 aircraft. This chart, typical of other cases studied, indicates that the perimeter of the wing (rear flight control surfaces and leading edge) experiences fluid failure earlier than other areas. Because contamination on the leading edge can severely degrade take-off performance, and because it experiences fluid failure earlier than most wing areas, it must be given strong consideration as the preferred wing surface for a test unit.

Extracting temperature decay rates for wing leading edges from past studies yielded a family of curves as shown in Figure 3.9. The studies covered a wide range of values for OAT, wind speed, and fluid quantity, and they included two aircraft types (DC-9 and B 737). In the legend, the fluid quantities applied per aircraft wing (controlled by the spray operator) are converted to equivalent amounts on a standard test plate (dimensions 30 cm by 50 cm). This family of curves provided an initial reference base for comparing surface temperature decay rates experienced by candidate test surfaces for the new test protocol, but additional data on other aircraft types are needed.

3.1.5 Data Review Summary

The review of past data helped crystallize those factors needing examination when selecting a surface for testing and defining a new test procedure.

The contribution of heat to longer endurance times through provision of slower cooling rates was confirmed. Factors affecting the rate of cooling were highlighted:

- wind
- surface thickness
- type of material used to fabricate surface
- quantity of applied fluid
- temperature of applied fluid.

Selection of a wing surface area to serve as a reference for evaluating potential test surfaces was resolved. Because freezing is first experienced on wing perimeters (leading edge and flight control surfaces), and the leading edge is a critical lift surface, the wing leading edge is a suitable reference surface for evaluating potential test surfaces.

Past data yielded useful information on rate of cooling of wing leading edges for some aircraft types. Additional data for other aircraft types are required.

3.2 Tests to Collect Additional Data on Leading Edge Temperature Decay Rate

This section describes the data on temperature decay rate collected for other types of wings.

Tests were performed at a variety of OATs. In the process of combining the various temperature decay rates, the data was adjusted to an OAT of -9°C (ie. The curves were lowered by an amount equal to the difference between ambient test temperature and -9°C).

3.2.1 Generic Aircraft Leading Edge Temperature Profile

Data were collected for various aircraft types, and involved various locations and spray operators:

- Lester B. Pearson International Airport, Toronto, 25 January 2001; Air Canada;
- Outdoor Temperature Trials on the JetStar Test Wing, Ottawa Airport, 07 March 2001; Hudson General Aviation Services Inc; and
- Montreal International Airport, Dorval, 21-22 March 2001; Aéromag 2000.

Each test session is discussed separately in the following sections. All test data used in this analysis were gathered in non-precipitation conditions. The temperature of the leading edge was measured at a point mid-way between the leading edge nose and the rear of the leading edge surface.

The temperature decay data for the wing leading edge from each of these tests were combined with earlier data using an adjustment process to form a single generic wing leading edge temperature profile.

The aircraft tests used to develop this generic profile are given in Table 3.1. In the table, the fluid quantities applied per aircraft wing (controlled by the spray operator) are compared with amounts applied to a standard test plate (dimensions 30 cm by 50 cm). The equivalent quantity per plate varied from 0.3 L to 1.3 L, with a mean of 0.6 L/plate. The average fluid temperature at the nozzle was 70°C.

Figure 3.10 shows the profiles for leading edges in all tests. In this chart, the profiles are shifted to align the peak temperatures (which represent the latest application of fluid at the temperature probe location).

Figure 3.11 presents a generic temperature profile, which is the calculated mean curve of all tests, along with curves representing variance in the data, at ± 1 and ± 2 standard deviations. This chart becomes the benchmark for evaluating whether prospective test surfaces are true representations of a wing. It is included as a background reference in many figures that show temperature profiles.

3.2.2 Lester B. Pearson International Airport, Toronto, 25 January 2001

The procedure for these tests is described in Section 2.3.1.

The list of tests conducted at Toronto Airport is given in Table 3.2. These tests were performed on a clear night with OAT of -7°C and low wind. By the end of the test session, frost was observed to have formed on the fuselage of aircraft parked at the passenger terminal.

Only the front portion of the wing, including the leading edge, was sprayed, thus complying with local regulations limiting the amount of deicing fluid that can be sprayed at the terminal ramp. The spray operator applied fluid to simulate the removal of light snow. The application progressed from the wingtip to the root, thus simulating cleaning of the wing, and finished with an overspray application from the wing root to the tip.

The sprayed fluid was cleaned from the ramp with a vacuum sweeper immediately following each test.

Test results (wing leading edge temperature decay rates) are included in Figure 3.10.

TABLE 3.1
Aircraft Leading Edge Temperature Profiles

	Aircraft Type	OAT (°C)	Wind (km/h)	Spray Application
a	DC-9	-13	28	106 L Water at 71°C (0.3 L/Plate)
b	DC-9	-13	28	136 L Water at 71°C, 110 L XL54 at 74°C (0.8 L/Plate)
c	DC-9	-9	7	163 L Water at 74°C (0.5 L/Plate)
d	DC-9	-9	7	155 L Water at 74°C, 95 L XL54 at 71°C (0.8 L/Plate)
e	DC-9	-3	6	412 L Water at 66°C (1.3 L/Plate)
f	DC-9	-3	6	110 L Water at 71°C (0.4 L/Plate)
g	B737	-9	Calm	184 L Std. Type I at 78°C (0.5 L/Plate)
h	A320	-7	4	41 L Type I at 58°C (LE only)
l	DC-9	-7	4	72 L Type I at 74°C (LE only)
j	B767	-6	4	18 L Type I at 76°C (LE only)
k	JetStar	-3	5	58 L Type I at 63°C (0.3 L/Plate)
l	B737	2	2	120 L Dilute Type I at 70°C (0.3 L/Plate)
m	Saab340	2	2	74 L Dilute Type I at 70°C (0.5 L/Plate)

TABLE 3.2
Wing Temperature Profile Trials
 YYZ T2 ramp, January 25, 2001

Date	Run	Test Surface	Time	OAT [°C]	Condition	Wind [km/h]	Type of Application	Fluid Amount [L]	Fluid Temp [°C]	FFP [°C]	Comments
25-Jan	1	A320	0:56	-7	dry	4	spray	41.0	58	XL54	sprayed LE only
25-Jan	1	6.4 mm plate /w inslt'd backing	0:56	-7	dry	4	spreader	0.5	58	XL54	
25-Jan	2	B 737	1:35	-7	dry	4	spray	49.0	72	XL54	sprayed LE only
25-Jan	2	6.4 mm plate /w inslt'd backing	1:35	-7	dry	4	spreader	0.5	52	XL54	
25-Jan	3	DC-9	2:10	-7	dry	4	spray	72.0	74	XL54	sprayed LE only
25-Jan	3	6.4 mm plate /w inslt'd backing	2:10	-7	dry	4	spreader	0.5	62	XL54	
25-Jan	4	B 767	2:45	-6	dry	4	spray	18.0	76	XL54	sprayed LE only
25-Jan	4	6.4 mm plate /w inslt'd backing	2:45	-6	dry	4	spreader	0.5	64	XL54	

Note 1: frost was forming on a/c cabins during the test. A clear cold night, causing wing temperatures to drop below OAT

Note 2: only the leading edge was sprayed to reduce amount of fluid on ramp

3.2.3 Outdoor Temperature Trials on the JetStar Test Wing, 7 March 2001

Table 3.3 lists the tests completed in this session. The procedure for these tests is described in Section 2.3.3.

Four runs were completed. Because the fluid application in the first run was unsatisfactory for the purpose of the test, it was treated as a dry run and the data disregarded. The spray technique for the other tests was satisfactory and quite consistent. Type I fluid was loaded into the wing tanks, following run 2 and run 3 (as shown in the table), to simulate partial fuel loads. The temperature of the fluid before being put in the fuel tanks was 14°C.

Figures 3.12 to 3.14 show temperature profiles for points on the leading edge for runs 2, 3, and 4 (empty, 25% filled, 50% filled). Profiles for the 7.5 cm cold-soak box and the standard test plate are also shown. The test on the standard plate was not repeated in the last run. The box was treated with 0.5 L of Type I fluid at 60°C, applied with the spreader. The plate was treated with 1.0 L at 20°C, applied by pouring as per current HOT test procedures.

Figures 3.15 to 3.19 compare temperature profiles for runs 2,3, and 4 (empty, 25% filled, 50% filled) for selected points on the wing.

The leading edge temperature decay rate from the test with the wing 50% filled is included in Figure 3.10.

3.2.4 Montreal International Airport, Dorval, 21-22 March 2001

The list of tests conducted is given in Table 3.4. The procedure for these tests is described in Section 2.3.2. These tests to measure wing temperature decay rates were performed while awaiting the beginning of forecasted snow, which was needed for conduct of fluid endurance tests. Although the snowfall did not begin in time for endurance testing, useful information was collected on wing temperature decay rates for the Saab 340 and Boeing 737.

TABLE 3.3
Jetstar Test-Wing Temperature Profile Trials
 YOW Deicing Centre, March 7, 2001

Date	Run	Test Surface	Fuel Load [L]	Fuel Temp [°C]	Time	OAT [°C]	Condition	Wind [km/h]	Type of Application	Fluid Amount [L]	Fluid Temp [°C]	FFP [°C]	Comments
7-Mar	1	Wing	empty		2000	-3	dry	5	spray	dry run	70	XL54	Dry run
7-Mar	1	Plate HOT			2000	-3	dry	5	pour	1.0	20	XL54	
7-Mar	1	7.5 cm box			2000	-3	dry	5	spreader	0.5	54	XL54	
7-Mar	2	Wing	empty		2030	-3	dry	5	spray	54.0	65	XL54	
7-Mar	2	Plate HOT			2030	-3	dry	5	pour	1.0	20	XL54	
7-Mar	2	7.5 cm box			2030	-3	dry	5	spreader	0.5	54	XL54	
7-Mar	3	Wing	745	-14	2114	-3	dry	5	spray	50.0	63	XL54	
7-Mar	3	Plate HOT			2114	-3	dry	5	pour	1.0	20	XL54	
7-Mar	3	7.5 cm box			2114	-3	dry	5	spreader	0.5	54	XL54	
7-Mar	4	Wing	1500	-14	2157	-3	dry	5	spray	58.0	63	XL54	
7-Mar	4	7.5 cm box			2157	-3	dry	5	spreader	0.5	54	XL54	

Note 1: spreader used was the taped spreader - number of drain holes reduced by 50%

Note 2: spray performed by Hudson General

TABLE 3.4
Wing Temperature Profile Trials
 YUL CDF, March 21 to 22, 2001

Date	Run	Test Surface	Time	OAT [°C]	Condition	Wind [km/h]	Type of Application	Fluid Amount [L]	Fluid Temp [°C]	FFP C	Comments
22-Mar	1	Saab wing	240	2	dry	2	spray	74	70	-12	
22-Mar	1	HOT plate	240	2	dry	2	poured	1	20	-12	
22-Mar	1	Std Box	240	2	dry	2	spreader	0.5	60	-12	
22-Mar	1	Thick box	240	2	dry	2	spreader	1	60	-12	
22-Mar	1	B737 wing	240	2	dry	2	spray	120	70	-12	
22-Mar	2	Saab wing	345	2	light rain	9	spray	54	62	-12	
22-Mar	2	HOT plate	345	2	light rain	9	poured	1	20	-12	
22-Mar	2	Std Box	345	2	light rain	9	spreader	0.5	60	-12	
22-Mar	2	Thick box	345	2	light rain	9	spreader	1	60	-12	
22-Mar	2	B737 wing	345	2	light rain	9	spray	172	62	-12	

Note: light rain approximately 20 g/dm²/hr
 Std. Box = 7.5 cm deep
 Thick Box = 15 cm deep

The two aircraft (Saab 340 and B 737) were parked side by side at the Central Deicing Facility (CDF), and the near wings both were instrumented with thermistor probes. For the temperature decay rate tests, they were sprayed in sequence, one immediately after the other. Two sessions were performed: the first in dry conditions, the second during rainfall (estimated at 20 g/dm²/hr). To meet the target time for returning the aircraft to the passenger terminal, the second test was initiated before the surfaces had returned fully to ambient temperature.

Temperature profiles for the first test, for points on the leading edge, are given in Figures 3.20 (for the Saab 340) and 3.21 (for the B 737). These figures present temperature profiles for the test surfaces, too, treated at the same time as the wings.

The temperature decay rates from tests in dry conditions on the Saab 340 and B 737 wing leading edges are included in Figure 3.10.

3.3 Examination of Candidate Test Surfaces

This section describes the data resulting from trials to select a test surface that produces a reasonable representation of the temperature decay rate demonstrated by wings. The generic temperature profile produced from test data on wings was used as a benchmark for evaluating suitability of various candidate test surfaces.

3.3.1 Preliminary Laboratory Tests

These tests were conducted while scheduled fluid endurance trials were underway at the CRIQ laboratory.

The test facility at CRIQ was a small cold chamber fitted with a cooling system. It was found that the facility's cooling capacity was unable to maintain the desired constant ambient temperature of -3°C. The additional cooling required (to cope with both the movement of personnel in and out of the chamber and heat input from the pouring of heated fluid for the Type I protocol tests and from the test personnel observing the Type I tests) was too great a challenge for the cooling unit. As a result, the ambient temperature warmed during trials. Rather than jeopardize the success of the scheduled fluid endurance trials, it was decided to cancel the Type I protocol trials following the second day of testing.

Despite the shortened test time, several runs were completed. These provided useful information on cooling curves for the various surfaces tested. Three test-sets were conducted on five prospective test surfaces, where the applied fluid was varied as follows:

- 0.5 L @ 60°C
- 1.0 L @ 60°C
- 1.0 L @ 70°C

Tests using the current Type I test procedure were conducted to serve as a reference base case.

As well, trials were conducted to examine the influence of various methods of applying fluid:

- pouring with a large spout versus pouring with a small spout, thereby controlling the speed of fluid application
- pouring only along the top edge of the test plate versus pouring over the entire plate surface
- pouring in one step (1.0 L) versus pouring in two steps (0.5 L each).

The current method of fluid application in fluid endurance trials involves pouring a portion of the fluid along the top edge of the test plate, cleaning the fluid off by squeegee, and then pouring the remaining fluid along the top edge of the plate.

Table 3.5 reports the tests completed at the CRIQ laboratory.

The temperature logs for these tests were charted as temperature profiles and assembled for comparison. The results are shown in Figures 3.22 to 3.25.

3.3.2 Outdoor Temperature Profile Tests, 5 and 7 December 2000

These tests were conducted at the APS test site at Dorval airport. The first two sessions (5 and 7 December 2000) were intended to generate data for a variety of potential test surfaces in wind conditions. The 5 December session was unsuccessful, as the forecasted natural winds did not occur. For the 7 December tests, a large fan was rented and positioned to provide a suitable wind over the test surfaces. Table 3.6 reports the types of plate surface tested and the test conditions for these two sessions. Where reference is made to "*insulated*", the plate in question had a 5 cm layer of insulation attached to the bottom side.

Charts showing the results from the 7 December test session are given in Figures 3.26 to 3.33.

TABLE 3.5
Test Surfaces Temperature Profile Trials
 CRIQ, October 25 to 26, 2000

Date	Test	Test Surface	Time	OAT [°C]	Condition	Wind [km/h]	Type of Application	Fluid Amount [L]	Fluid Temp [°C]	FFP [°C]	Comments
26-Oct	13	Std plate HOT	9:30	-3	dry	calm	poured	1	20	-13	
25-Oct	1	Std plate	14:05	-3	dry	calm	spreader	0.5	60	-13	
25-Oct	2	C/FIMS plate	14:05	-3	dry	calm	spreader	0.5	60	-13	
25-Oct	3	7.5 cm box at 4 L	14:05	-3	dry	calm	spreader	0.5	60	-13	
25-Oct	5	7.5 cm box with 6.4 mm surface; 4 L	14:05	-3	dry	calm	spreader	0.5	60	-13	
25-Oct	6	15 cm box at 13 L	14:05	-3	dry	calm	spreader	0.5	60	-13	
25-Oct	7	Std plate	10:05	-3	dry	calm	spreader	1	60	-13	
25-Oct	8	C/FIMS plate	10:05	-3	dry	calm	spreader	1	60	-13	
26-Oct	11	7.5 cm box at 4 L	14:10	-3	dry	calm	spreader	1	60	-13	
26-Oct	21	Std plate	11:20	-3	dry	calm	spreader	1	70	-13	
26-Oct	22	C/FIMS plate	11:20	-3	dry	calm	spreader	1	70	-13	
26-Oct	23	7.5 cm box at 4 L	11:20	-3	dry	calm	spreader	1	70	-13	
26-Oct	25	7.5 cm box with 6.4 mm surface; 4 L	11:38	-3	dry	calm	spreader	1	70	-13	
26-Oct	26	15 cm box at 13 L	11:38	-3	dry	calm	poured	1	70	-13	
26-Oct	45	Std plate	15:00	-3	dry	calm	poured - note	1	60	-13	big spout
26-Oct	46	Std plate	15:00	-3	dry	calm	poured - note	1	60	-13	small spout

7.5 cm box capacity = 10.4 L

7.5 cm box with 4 L = approx. 40% capacity

15 cm box capacity = 70 L

15 cm box with 13 L = 60% capacity

TABLE 3.6
Temperature Profile Trials
 APS Test Site, December 7, 2001

Date	Run	Time	Ambient Temp [°C]	Wind [km/h]	Test Condn	Rate [g/dm ² /h]	Test Surface (see notes)	Condition of Test Surface	Type of Application	Fluid Amount on Test Area [L]	Fluid Temp [°C]	FFP [°C]	Comments
7-Dec	1	11:10	-8	15 to 25	dry	0	Std plate - HOT	cleaned	poured	1	20	-15	
7-Dec	1	10:25	-8	15 to 25	dry	0	Std plate	cleaned	spreader	0.5	60	-15	
7-Dec	1	10:25	-8	15 to 25	dry	0	Std plate - insul	cleaned	spreader	0.5	60	-15	
7-Dec	1	10:05	-8	20 to 43	dry	0	C/FIMS plate	cleaned	spreader	0.5	60	-15	
7-Dec	1	10:05	-8	20 to 43	dry	0	C/FIMS plate- insul	cleaned	spreader	0.5	60	-15	
7-Dec	1	10:05	-8	20 to 43	dry	0	9.6 mm plate	cleaned	spreader	0.5	60	-15	
7-Dec	1	10:05	-8	20 to 43	dry	0	9.6 mm plate - insul	cleaned	spreader	0.5	60	-15	
7-Dec	1	12:10	-10	20 to 25	dry	0	7.5 cm box - empty	cleaned	spreader	0.5	60	-15	
7-Dec	1	12:10	-10	20 to 25	dry	0	7.5 cm box - 4 L	cleaned	spreader	0.5	60	-15	
7-Dec	1	12:10	-10	20 to 25	dry	0	7.5 cm box - full	cleaned	spreader	0.5	60	-15	
7-Dec	2	11:24	-10	20 to 25	dry	0	Std plate	cleaned	spreader	1	60	-15	
7-Dec	2	10:47	-8	20 to 25	dry	0	Std plate - insul	cleaned	spreader	1	60	-15	
7-Dec	2	10:47	-8	20 to 25	dry	0	C/FIMS plate	cleaned	spreader	1	60	-15	
7-Dec	2	10:47	-8	20 to 25	dry	0	C/FIMS plate- insul	cleaned	spreader	1	60	-15	
7-Dec	2	10:47	-8	20 to 25	dry	0	9.6 mm plate	cleaned	spreader	1	60	-15	
7-Dec	2	10:47	-8	20 to 25	dry	0	9.6 mm plate - insul	cleaned	spreader	1	60	-15	
7-Dec	2	11:52	-8	22 to 28	dry	0	7.5 cm box - empty	cleaned	spreader	1	60	-15	
7-Dec	2	11:52	-8	22 to 28	dry	0	7.5 cm box - 4 L	cleaned	spreader	1	60	-15	
7-Dec	2	11:52	-8	22 to 28	dry	0	7.5 cm box - full	cleaned	spreader	1	60	-15	

Note: The test session conducted on December 05, 2000 was identical except that OAT was -2°C and wind speed was 2 km/h

- 7.5 cm box capacity = 10.4 L
- 7.5 cm box with 4 L = approx. 40% capacity
- 15 cm box capacity = 70 L
- 15 cm box with 13 L = 60% capacity

3.3.3 Outdoor Temperature Profile Tests, 1 March 2001

More trials were conducted on 1 March 2001 to examine the effect of thicker surfaces on temperature profiles. Two cold-soak boxes were modified with thicker surfaces for these tests by attaching another aluminum plate. The surface thicknesses tested were:

Empty Box with standard surface	3.2 mm
Empty Box with medium surface	4.8 mm
Empty Box with thick surface	6.4 mm

These tests were conducted at night to avoid radiation heating of the surfaces. A large fan was used to generate a range of wind speeds over the test surfaces.

Table 3.7 (runs 1 to 6) lists the tests conducted. The resulting temperature profiles were grouped for comparison and are reported in Figures 3.34 to 3.39.

3.3.4 Comparison of Ethylene-Based Type I Fluid to Kerosene Fuel, 1 Mar 2001

In preparation for using a Type I fluid as a simulated fuel load in the JetStar test wing, Type I fluid (ethylene-based) was compared with kerosene in respect to effect on surface temperature profiles.

For this test, two cold-soak boxes were loaded with equal quantities of Type I fluid and kerosene. Tests were conducted with boxes 50% filled (5 L) and completely filled (10.4 L). Heated fluid was applied to the box surfaces and the surface temperatures were logged.

The list of tests conducted is shown in Table 3.7 (runs 7 and 8). The resulting temperature profiles are reported in Figure 3.40.

3.3.5 Effect of Rate of Fluid Application on Heat Transfer to the Test Surface

The interval that heated fluid remains in contact with the wing or test surface has an influence on heat transfer. Since changing the rate of application alters the contact interval, an examination of rate effect was conducted. This consisted of altering the number of drain holes in the fluid spreader and then comparing the surface temperature decay rate when heated fluid was applied with the altered versus unaltered spreader. In this test, the number of drain holes was reduced by 50% by

TABLE 3.7
Wing Temperature Profile Trials
 APS Test Site, March 1 to 2, 2001

Date	Run	Test Surface	Time	OAT [°C]	Condition	Wind [km/h]	Type of Application	Fluid Amount [L]	Fluid Temp. [°C]	FFP [°C]	Comments
1-Mar	1	Std plate HOT	19:15	-13.0	dry	calm	poured	1	20	-25	
1-Mar	1	Std 7.5 cm Box	19:15	-13.0	dry	calm	spreader	0.5	60	-25	
1-Mar	1	Box with 1.6 mm plate	19:15	-13.0	dry	calm	spreader	0.5	60	-25	
1-Mar	1	Box with 3.2 mm plate	19:15	-13.0	dry	calm	spreader	0.5	60	-25	
1-Mar	2	Std plate HOT	19:45	-13.0	dry	calm	poured	1	20	-25	
1-Mar	2	Std 7.5 cm Box	19:45	-13.0	dry	calm	spreader	1	60	-25	
1-Mar	2	Box with 1.6 mm plate	19:45	-13.0	dry	calm	spreader	1	60	-25	
1-Mar	2	Box with 3.2 mm plate	19:45	-13.0	dry	calm	spreader	1	60	-25	
1-Mar	3	Std plate HOT	23:00	-13.0	dry	11	poured	1	20	-25	
1-Mar	3	Std 7.5 cm Box	23:00	-13.0	dry	11	spreader	0.5	60	-25	
1-Mar	3	Box with 1.6 mm plate	22:35	-13.0	dry	13	spreader	0.5	60	-25	
1-Mar	3	Box with 3.2 mm plate	22:35	-13.0	dry	13	spreader	0.5	60	-25	
1-Mar	4	Std plate HOT	20:35	-13.0	dry	22	poured	1	20	-25	
1-Mar	4	Std 7.5 cm Box	20:35	-13.0	dry	22	spreader	0.5	60	-25	
1-Mar	4	Box with 1.6 mm plate	20:35	-13.0	dry	14	spreader	0.5	60	-25	
1-Mar	4	Box with 3.2 mm plate	20:35	-13.0	dry	14	spreader	0.5	60	-25	
1-Mar	5	Std plate HOT	21:07	-13.0	dry	23	poured	1	20	-25	
1-Mar	5	Std 7.5 cm Box	21:07	-13.0	dry	23	spreader	0.5	60	-25	
1-Mar	5	Box with 1.6 mm plate	21:46	-13.0	dry	20	spreader	0.5	60	-25	
1-Mar	5	Box with 3.2 mm plate	21:46	-13.0	dry	20	spreader	0.5	60	-25	
1-Mar	6	Std 7.5 cm Box	21:22	-13.0	dry	23	spreader	1	60	-25	
1-Mar	6	Box with 1.6 mm plate	22:17	-13.0	dry	20	spreader	1	60	-25	
1-Mar	6	Box with 3.2 mm plate	22:17	-13.0	dry	20	spreader	1	60	-25	
2-Mar	7	Std 7.5 cm Box	0:40	-13.5	dry	calm	spreader	1	60	-25	box with 50% (5 L) kerosene
2-Mar	7	Std 7.5 cm Box	0:40	-13.5	dry	calm	spreader	1	60	-25	box with 50% (5 L) Type I 50/50
2-Mar	8	Std 7.5 cm Box	1:06	-13.5	dry	calm	spreader	1	60	-25	box filled with kerosene
2-Mar	8	Std 7.5 cm Box	1:06	-13.5	dry	calm	spreader	1	60	-25	box filled with Type I 50/50
1-Mar	9	Std 7.5 cm Box	23:54	-13.5	dry	calm	spreader - note	1	60	-25	spreader with 1/2 holes covered
1-Mar	9	Std 7.5 cm Box	23:54	-13.5	dry	calm	spreader - note	1	60	-25	std spreader

Std plate HOT surface = 3.2 mm thick
 Std 7.5 cm box surface = 3.2 mm thick
 Box with 1.6 mm plate = total 4.8 mm thick
 Box with 3.2 mm plate = total 6.4 mm thick

taping over half the holes (Photo 2.8). This caused the application interval to increase from 5 seconds to 10.

The list of tests conducted is shown in Table 3.7 (run 9). The resulting temperature profiles are reported in Figure 3.41.

3.4 Fluid Endurance Times on Test Surfaces

The procedure for the trials to measure fluid endurance times on different candidate test surfaces is described in Section 2.4.

Table 3.8 lists the tests performed. Five test sessions, which covered a range of OAT, wind speeds, and snowfall rates, are reported.

In these runs, candidate surfaces were treated with various quantities of fluid, which was heated to 60°C and applied with the spreader. The surface was cleaned prior to fluid application and wetted with ambient temperature fluid. In all test runs, fluid endurance times were measured, using the current standard test procedure (HOT) for Type I fluids, to serve as a comparison.

Endurance times for the 7.5 cm cold-soak box and the standard HOT test are shown in Figure 3.42. Endurance times experienced for the two test procedures are plotted versus rate of precipitation. In figure 3.43, best-fit curves are developed for the box procedure and plate procedure (HOT test).

3.5 NRC Canada Trials

Tests were conducted at the NRC Canada cold chamber from 12-15 March 2001, in accordance with procedures described in Section 2.5.

These tests examined fluid endurance times on the JetStar test wing and on selected candidate test surfaces. They were conducted under conditions of artificial snow and freezing rain precipitation. Table 3.9 lists the tests conducted.

In one test, a thick layer of snow was removed from the wing by spraying. In this test (Set 1 in Figure 3.9), the equivalent of 36.0 L/m² was applied. In the remaining tests on the wing, the wing test surface was first cleaned and then fluid was applied with a large spreader at a rate of 3.3 L/m².

The data collected are displayed graphically in Figures 3.44 to 3.52. In these figures, the surface temperature decay profiles for the wing leading

TABLE 3.8
Log of Fluid Endurance Tests in Snow (continued on next page)

Test no.	Form no.	Date	Run no.	Stand no.	Start time (Local)	Fail time (Local)	Fluid Name	Fluid Butter (°C)	Fluid temp. (°C)	Surface type	Fail time [min.]	AVG PAN [g/dm ² /hr]	Temp [°C]	Wind Speed (km/h)	Fluid Quantity
1	1	Jan-15-01	1	1	19:55:18	20:02:59	Lyondell Arco Plus	10	58	C/FIMS	7.7	13.3	-8.0	10.0	0.5 L
2	1	Jan-15-01	1	1	19:54:25	20:01:43	Lyondell Arco Plus	10	57	Box	7.3	13.3	-8.0	10.0	0.5 L
3	1	Jan-15-01	1	1	19:52:32	19:57:30	Lyondell Arco Plus	10	22	STD	5.0	13.3	-8.0	10.0	1 L
4	2	Jan-15-01	2	1	20:46:50	20:59:59	Lyondell Arco Plus	10	60	C/FIMS	13.2	6.89	-8.0	9.4	1 L
5	2	Jan-15-01	2	1	20:46:12	20:57:02	Lyondell Arco Plus	10	59	Box	10.8	6.89	-8.0	9.4	0.5 L
6	2	Jan-15-01	2	1	20:47:46	20:56:00	Lyondell Arco Plus	10	21	STD	8.2	6.89	-8.0	9.4	1 L
7	3	Jan-15-01	3	1	21:24:55	21:58:00	Lyondell Arco Plus	10	61	C/FIMS	33.1	2.5	-8.0	12.0	0.5 L
8	3	Jan-15-01	3	1	21:24:14	21:56:00	Lyondell Arco Plus	10	61	Box	31.8	2.5	-8.0	12.0	0.5 L
9	3	Jan-15-01	3	1	21:25:40	21:42:45	Lyondell Arco Plus	10	23	STD	17.1	2.5	-8.0	12.0	1 L
10	4	Jan-15-01	4	1	22:52:20	23:00:55	Lyondell Arco Plus	10	59	C/FIMS	8.6	17.5	-8.0	12.0	1 L
11	4	Jan-15-01	4	1	22:51:30	22:57:30	Lyondell Arco Plus	10	58	Box	6.0	17.5	-8.0	12.0	0.5 L
12	4	Jan-15-01	4	1	22:52:51	22:56:53	Lyondell Arco Plus	10	25	STD	4.0	17.5	-8.0	12.0	1 L
13	5	Jan-15-01	5	1	23:30:02	23:37:00	Lyondell Arco Plus	10	61	C/FIMS	7.0	23.9	-8.0	11.5	0.5 L
14	5	Jan-15-01	5	1	23:29:24	23:34:40	Lyondell Arco Plus	10	61	Box	5.3	23.9	-8.0	11.5	0.5 L
15	5	Jan-15-01	5	1	23:30:33	23:34:00	Lyondell Arco Plus	10	23	STD	3.5	23.9	-8.0	11.5	1 L
16	6	Jan-15-01	6	1	0:03:32	0:16:30	Lyondell Arco Plus	10	61	C/FIMS	13.0	11.9	-8.0	9.5	1 L
17	6	Jan-15-01	6	1	0:02:45	0:08:35	Lyondell Arco Plus	10	59	Box	5.8	11.9	-8.0	9.5	0.5 L
18	6	Jan-15-01	6	1	0:04:05	0:08:00	Lyondell Arco Plus	10	22	STD	3.9	11.9	-8.0	9.5	1 L
19	7	Jan-31-01	1	1	14:11:20	14:18:25	Lyondell Arco Plus	10	20	STD	7.1	12.0	-8.0	10.0	1 L
20	7	Jan-31-01	1	1	14:11:40	14:20:25	Lyondell Arco Plus	10	60	Box	8.8	12.0	-8.0	10.0	0.5 L
21	8	Jan-31-01	2	1	14:48:40	14:54:15	Lyondell Arco Plus	10	20	STD	5.6	14.0	-8.0	10.0	1 L
22	8	Jan-31-01	2	1	14:49:10	14:56:15	Lyondell Arco Plus	10	60	Box	7.1	14.0	-8.0	10.0	0.5 L
23	9	Feb-05-01	1	1	13:04:00	13:51:10	Lyondell Arco Plus	10	20	STD	47.2	1.2	-6.3	8.0	1 L
24	10	Feb-19-01	3	1	14:59:15	15:05:00	Lyondell Arco Plus	10	60	15 cm BOX	5.8	41.0	-2.4	13.0	0.75 L
25	10	Feb-19-01	3	1	15:00:20	15:05:00	Lyondell Arco Plus	10	60	Thick BOX	4.7	41.0	-2.4	13.0	0.75 L
26	10	Feb-19-01	3	1	15:01:20	15:06:20	Lyondell Arco Plus	10	60	Thin BOX	5.0	41.0	-2.4	13.0	0.75 L
27	10	Feb-19-01	3	1	15:02:10	15:07:20	Lyondell Arco Plus	10	60	Box	5.2	41.0	-2.4	13.0	0.75 L
28	10	Feb-19-01	3	1	15:03:40	15:07:40	Lyondell Arco Plus	10	20	STD	4.0	41.0	-2.4	13.0	0.75 L
29	11	Feb-19-01	4	1	15:53:30	15:59:10	Lyondell Arco Plus	10	60	Thick BOX	5.7	27.9	-2.3	7.2	0.75 L
30	11	Feb-19-01	4	1	15:54:00	15:59:20	Lyondell Arco Plus	10	60	Thin BOX	5.3	27.7	-2.3	7.2	0.75 L
31	11	Feb-19-01	4	1	15:54:35	15:59:20	Lyondell Arco Plus	10	60	Box	4.8	27.5	-2.3	7.2	0.75 L
32	11	Feb-19-01	4	1	15:55:00	15:58:20	Lyondell Arco Plus	10	20	STD	3.3	27.5	-2.3	7.2	0.5 L
33	12	Feb-19-01	5	1	16:22:57	16:26:50	Lyondell Arco Plus	10	60	15 cm BOX	3.9	23.0	-2.5	6.7	0.5 L
34	12	Feb-19-01	5	1	16:23:30	16:28:40	Lyondell Arco Plus	10	60	Thick BOX	5.2	23.0	-2.5	6.7	0.5 L
35	12	Feb-19-01	5	1	16:24:00	16:29:10	Lyondell Arco Plus	10	60	Thin BOX	5.2	23.0	-2.5	6.7	0.5 L
36	12	Feb-19-01	5	1	16:24:35	16:29:35	Lyondell Arco Plus	10	60	Box	5.0	23.0	-2.5	6.7	0.5 L

TABLE 3.8
Log of Fluid Endurance Tests in Snow (cont'd)

Test no.	Form no.	Date	Run no.	Stand no.	Start time (Local)	Fail time (Local)	Fluid Name	Fluid Butter (°C)	Fluid temp. (°C)	Surface type	Fail time [min.]	AVG PAN [g/dm ² /hr]	Temp [°C]	Wind Speed (km/h)	Fluid Quantity
37	12	Feb-19-01	5	1	16:24:55	16:27:50	Lyondell Arco Plus	10	20	STD	2.9	23.0	-2.5	6.7	1 L
38	13	Feb-19-01	6	1	16:46:10	16:58:45	Lyondell Arco Plus	10	60	Thin BOX	12.6	9.5	-2.7	5.5	0.5 L
39	14	Feb-25-01	1	1	7:27:51	7:32:30	Lyondell Arco Plus ST	10	20	STD	4.7	17.6	-9.5	10.0	1 L
40	14	Feb-25-01	1	1	7:29:10	7:34:00	Lyondell Arco Plus ST	10	60	STD	4.8	17.5	-9.5	10.0	0.5 L
41	14	Feb-25-01	1	1	7:30:10	7:36:48	Lyondell Arco Plus ST	10	60	Box	6.6	17.3	-9.5	10.0	0.5 L
42	14	Feb-25-01	1	1	7:31:00	7:37:10	Lyondell Arco Plus ST	10	60	Thin BOX	6.2	17.3	-9.5	10.0	0.5 L
43	14	Feb-25-01	1	1	7:31:40	7:37:40	Lyondell Arco Plus ST	10	60	Thick BOX	6.0	17.2	-9.5	10.0	0.5 L
44	15	Feb-25-01	2	1	8:41:30	8:45:40	Lyondell Arco Plus ST	10	20	STD	4.2	30.1	-9.8	10.0	1 L
45	15	Feb-25-01	2	1	8:42:20	8:47:10	Lyondell Arco Plus ST	10	60	STD	4.8	30.5	-9.8	10.0	0.75 L
46	15	Feb-25-01	2	1	8:43:15	8:48:50	Lyondell Arco Plus ST	10	60	Box	5.6	30.3	-9.8	10.0	0.75 L
47	15	Feb-25-01	2	1	8:43:55	8:49:30	Lyondell Arco Plus ST	10	60	Thin BOX	5.6	30.2	-9.8	10.0	0.75 L
48	15	Feb-25-01	2	1	8:44:30	8:49:45	Lyondell Arco Plus ST	10	60	Thick BOX	5.3	30.2	-9.8	11.0	0.75 L

NOTE:

"BOX" - is empty 7.5 cm cold-soak box with surface 3.2 mm thick.

"C/FIMS" - is aluminum plate 6.2 mm thick.

"STD" - is standard aluminum test plate 3.2 mm thick

"Thick BOX" - is 7.5 cm cold-soak box with surface 6.2 mm thick.

"Thin BOX" - is 7.5 cm cold-soak box with surface 4.8 mm thick.

TABLE 3.9
Type I Protocol Fluid Endurance Trials, JetStar Test Wing at NRC Canada CEF (continued on next page)
 March 12 to 15, 2001, Wing test area 1.5 m²

Set	#	Date	Run	Time	%	Start Time	Fail Time	Fail Time [min.]	Rate [g/dm ² /h]	Ambient Temp [°C]	Test Condn	Test Surface	Condition of Test Surface	Type of Application	Fluid Amount on Test Area [L]	Fluid Temp [°C]	FFP [°C]	Comments
1	1	13-Mar	1	10:40	10	10:41:18	10:45:26	4.1	23	-15	snow	Wing	7.5 cm snow	spray	54	60	-25	
					20	10:41:18	10:46:01	4.7	23	-15	snow	Wing	7.5 cm snow	spray	54	60	-25	
					30	10:41:18	10:46:48	5.5	23	-15	snow	Wing	7.5 cm snow	spray	54	60	-25	
	2	13-Mar	1	10:40	30	10:44:44	10:49:40	4.9	23	-15	snow	HOT plate	cleaned	poured	1	20	-25	
2	3	13-Mar	1	10:40	30	10:48:10	10:52:20	4.2	23	-15	snow	Std Box	cleaned	spreader	0.5	60	-25	
	4	13-Mar	1	10:40	30	10:46:40	10:51:10	4.5	23	-15	snow	Thick box	cleaned	spreader	0.5	60	-25	
	5	13-Mar	2	14:45	30	14:50:29	14:53:50	3.4	21	-15	snow	HOT plate	cleaned	poured	1	20	-25	
	6	13-Mar	2	14:45	30	14:48:57	14:53:35	4.6	21	-15	snow	Std Box	cleaned	spreader	0.5	60	-25	
3	7	13-Mar	2	14:45	30	14:47:00	14:51:37	4.6	21	-15	snow	Thick box	cleaned	spreader	0.5	60	-25	
	8	13-Mar	3	15:25	30	15:25:49	15:30:17	4.5	18	-15	snow	HOT plate	cleaned	poured	1	20	-25	
	9	13-Mar	3	15:25	30	15:23:22	15:28:29	5.1	18	-15	snow	Std Box	cleaned	spreader	0.5	60	-25	
	10	13-Mar	3	15:25	30	15:21:26	15:26:56	5.5	18	-15	snow	Thick box	cleaned	spreader	0.5	60	-25	
4	11	13-Mar	4	16:00	30	16:01:14	16:05:20	4.1	19	-15	snow	HOT plate	cleaned	poured	1	20	-25	rates and distribution
	12	13-Mar	4	16:00	30	15:59:27	16:08:12	8.8	19	-15	snow	Std Box	cleaned	spreader	0.5	60	-25	suspect due stuck
	13	13-Mar	4	16:00	30	15:57:06	16:04:21	7.3	19	-15	snow	Thick box	cleaned	spreader	0.5	60	-25	nozzle
	14	13-Mar	5	16:40	10	16:43:00	16:46:30	3.5	11	-15	snow	Wing	cleaned	spreader	5	60	-25	rates and distribution suspect
5					30	16:43:00	16:48:03	5.1	11	-15	snow	Wing	cleaned	spreader	5	60	-25	due stuck nozzle
	15	13-Mar	6	17:51	10	17:51:50	17:55:10	3.3	26	-15	snow	Wing	cleaned	spreader	5	60	-25	
					20	17:51:50	17:56:21	4.5	26	-15	snow	Wing	cleaned	spreader	5	60	-25	
					30	17:51:50	17:56:45	4.9	26	-15	snow	Wing	cleaned	spreader	5	60	-25	
6	16	13-Mar	7	18:41	30	18:41:26	18:46:30	5.1	21	-15	snow	HOT plate	cleaned	poured	1	20	-25	
	17	13-Mar	7	18:41	30	18:40:11	18:46:40	6.5	21	-15	snow	Std Box	cleaned	spreader	0.5	60	-25	
	18	13-Mar	7	18:41	30	18:38:41	18:44:58	6.3	21	-15	snow	Thick box	cleaned	spreader	0.5	60	-25	
	19	14-Mar	8	11:44	30	11:44:30	11:47:45	3.3	28	-15	snow	HOT plate	cleaned	poured	1	20	-25	
7	20	14-Mar	8	11:44	30	11:43:00	11:48:02	5.0	28	-15	snow	Std Box	cleaned	spreader	0.5	60	-25	
	21	14-Mar	8	11:44	30	11:43:46	11:48:00	4.2	28	-15	snow	Thick box	cleaned	spreader	0.5	60	-25	
	22	14-Mar	9	11:57	10	11:57:37	12:00:50	3.2	29	-15	snow	Wing	cleaned	spreader	5	60	-25	
					20	11:57:37	12:01:30	3.9	29	-15	snow	Wing	cleaned	spreader	5	60	-25	
8					30	11:57:37	12:01:40	4.1	29	-15	snow	Wing	cleaned	spreader	5	60	-25	
	23	14-Mar	10	14:29	30	14:31:15	14:37:45	6.5	10	-10	LZR	HOT plate	cleaned	poured	1	20	-20	
	24	14-Mar	10	14:29	30	14:29:20	14:38:20	9.0	10	-10	LZR	Std Box	cleaned	spreader	0.5	60	-20	
	25	14-Mar	10	14:29	30	14:30:16	14:39:30	9.2	10	-10	LZR	Thick box	cleaned	spreader	0.5	60	-20	
9	26	14-Mar	11	15:08	10	15:08:35	15:16:47	8.2	10	-10	LZR	Wing	cleaned	spreader	0.5	60	-20	
					20	15:08:35	15:19:24	10.8	10	-10	LZR	Wing	cleaned	spreader	0.5	60	-20	
					30	15:08:35	15:20:15	11.7	10	-10	LZR	Wing	cleaned	spreader	0.5	60	-20	
	27	14-Mar	12	16:28	30	16:30:23	16:37:49	7.4	10	-10	LZR	HOT plate	cleaned	poured	1	20	-20	
10	28	14-Mar	12	16:28	30	16:29:17	16:40:36	11.3	10	-10	LZR	Std Box	cleaned	spreader	0.5	60	-20	increased fluid this test
	29	14-Mar	12	16:28	30	16:26:25	16:38:00	11.6	10	-10	LZR	Std Box	cleaned	spreader	1	60	-20	
	30	14-Mar	12	16:28	30	16:28:12	16:40:48	12.6	10	-10	LZR	Thick box	cleaned	spreader	1	60	-20	increased fluid this test
	31	14-Mar	13	16:52	10	16:52:32	16:59:40	7.1	10	-10	LZR	Wing	cleaned	spreader	5	60	-20	
11					20	16:52:32	17:00:52	8.3	10	-10	LZR	Wing	cleaned	spreader	5	60	-20	
					30	16:52:32	17:01:49	9.3	10	-10	LZR	Wing	cleaned	spreader	5	60	-20	
	32	15-Mar	14	10:08	30				23	-10	FZR	HOT plate	cleaned	poured	1	20	-20	test stopped
	33	15-Mar	14	10:08	30	10:08:38	10:14:48	6.2	23	-10	FZR	Plate	cleaned	spreader	0.5	60	-20	
12	34	15-Mar	14	10:08	30	10:06:08	10:13:15	7.1	23	-10	FZR	Std Box	cleaned	spreader	0.5	60	-20	
	35	15-Mar	14	10:08	30	10:09:48	10:22:00	12.2	23	-10	FZR	Thick box	cleaned	spreader	1	60	-20	increased fluid this test

TABLE 3.9
Type I Protocol Fluid Endurance Trials, JetStar Test Wing at NRC Canada CEF (cont'd)
 March 12 to 15, 2001, Wing test area 1.5 m²

Set	#	Date	Run	Time	%	Start Time	Fail Time	Fail Time [min.]	Rate [g/dm ² /h]	Ambient Temp [°C]	Test Condn	Test Surface	Condition of Test Surface	Type of Application	Fluid Amount on Test Area [L]	Fluid Temp [°C]	FFP [°C]	Comments
9	36	15-Mar	15	11:20	30	11:21:20	11:25:51	4.5	25	-10	FZR	HOT plate	cleaned	poured	1	20	-20	
	37	15-Mar	15	11:20	30	11:19:37	11:26:37	7.0	25	-10	FZR	Plate	cleaned	spreader	0.5	60	-20	
	38	15-Mar	15	11:20	30	11:22:20	11:29:17	7.0	25	-10	FZR	Std Box	cleaned	spreader	0.5	60	-20	
	39	15-Mar	15	11:20	30	11:17:32	11:28:33	11.0	25	-10	FZR	Thick box	cleaned	spreader	1	60	-20	increased fluid this test
	40	15-Mar	16	12:22	10	12:23:07	12:30:40	7.6	28	-10	FZR	Wing	cleaned	spreader	5	60	-20	
					20	12:23:07	12:31:55	8.8	28	-10	FZR	Wing	cleaned	spreader	5	60	-20	
				30	12:23:07	12:33:00	9.9	28	-10	FZR	Wing	cleaned	spreader	5	60	-20		
10	41	15-Mar	17	13:10	10	13:11:14	13:19:20	8.1	29	-10	FZR	Wing	cleaned	spreader	5	60	-20	
					20	13:11:14	13:20:00	8.8	29	-10	FZR	Wing	cleaned	spreader	5	60	-20	
					30	13:11:14	13:21:23	10.2	29	-10	FZR	Wing	cleaned	spreader	5	60	-20	
	42	15-Mar	18	13:55	30	13:55:19	13:58:30	3.2	24	-10	FZR	HOT plate	cleaned	poured	1	20	-20	
	43	15-Mar	18	13:55	30	13:57:01	14:03:01	6.0	24	-10	FZR	Plate	cleaned	spreader	0.5	60	-20	
	44	15-Mar	18	13:55	30	13:58:38	14:08:15	9.6	24	-10	FZR	Std Box	cleaned	spreader	0.5	60	-20	
	45	15-Mar	18	13:55	30	13:59:42	14:15:19	15.6	24	-10	FZR	Thick box	cleaned	spreader	1	60	-20	increased fluid this test

LZR = Light Freezing Rain
 FZR = Freezing Rain

edge and the candidate surfaces under test precipitation are charted. Fluid freeze point temperature, too, is charted over time as the fluid progressively dilutes under the precipitation. The time when the fluid failed (over 30% of the test surface area) is noted on the fluid freeze point curves for candidate test surfaces. For the wing leading edge, the times when the fluid failed over 10%, 20%, and 30% of the leading edge test area are noted. In some tests, particularly under snow precipitation, it was very difficult to estimate the area affected; complete data on percentage failed are not available for all tests.

Temperature decay rate was measured for the wing and test surfaces in dry conditions also. Figure 3.53 compares temperature profiles for a location on the leading edge and on the standard cold-soak box. The wing leading edge profile shows the rapid early cooling noted earlier.

3.6 Field Trials on Aircraft

Although trials to collect data on fluid endurance times on actual aircraft wings for comparison to those on test surfaces were attempted, the forecasted precipitation did not occur. The only data collected for these trials were temperature decay rate data, which is described in Section 3.2.4.

FIGURE 3.1
Sample Wing Temperature Plot
Hot Water Skin Temperature Test at Dorval Airport
Aircraft Wing (Starboard Side "B")
March 28, 1995, Run #2
Thermistor 3

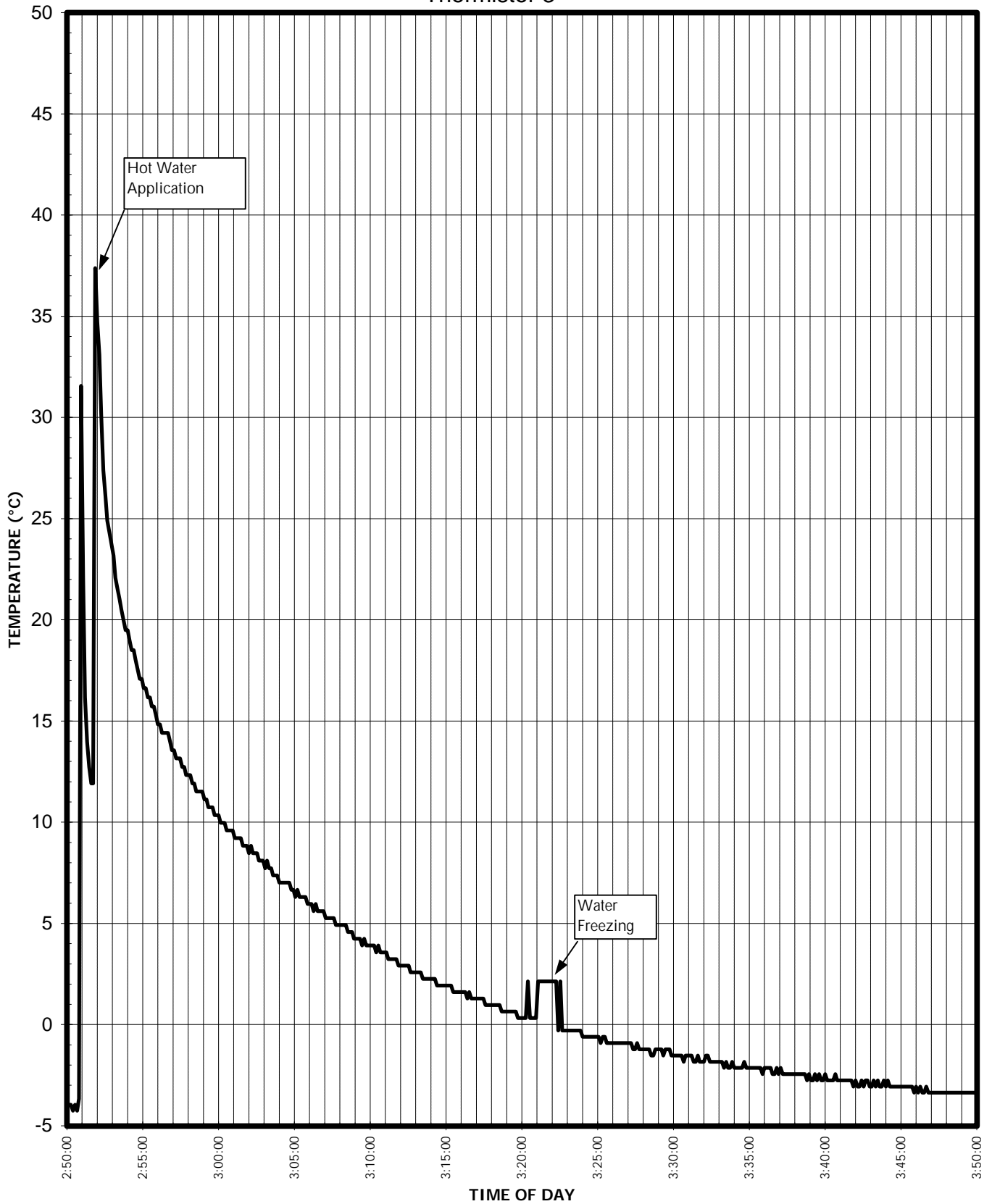

FIGURE 3.2
Wing Surface Temperature Decay Rate

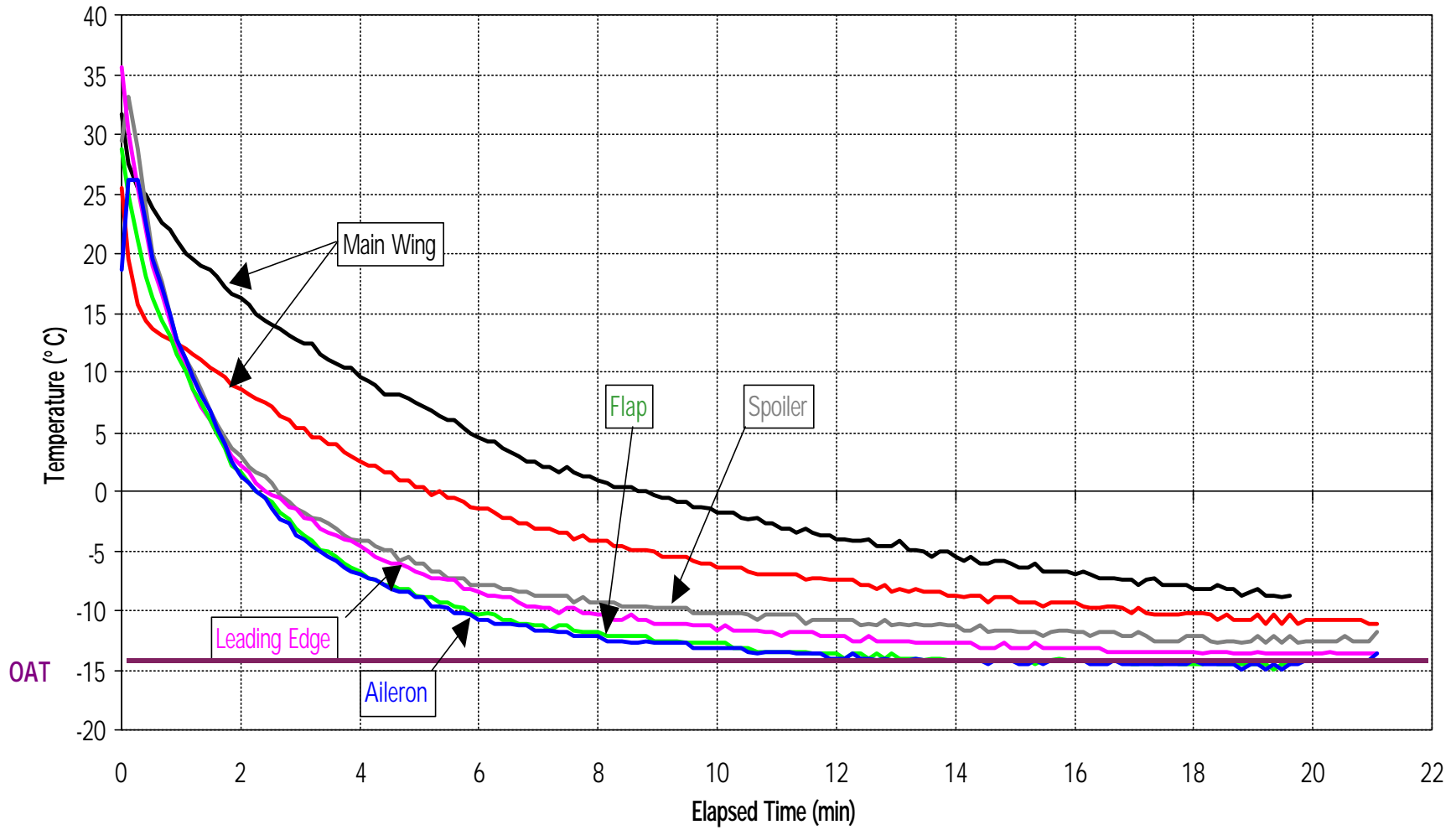
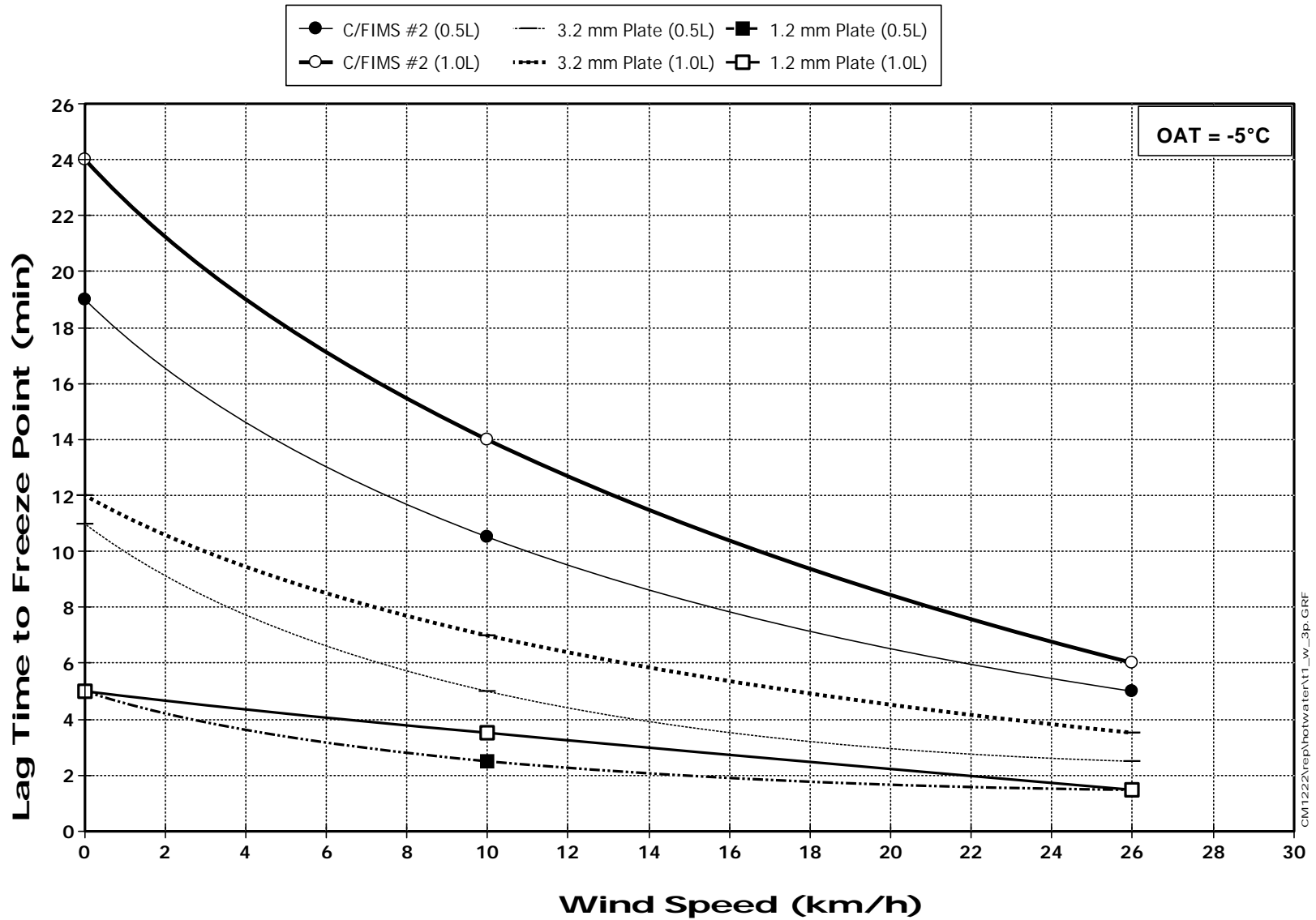

FIGURE 3.3
Effect of Wind Speed, Volume Poured & Plate Thickness
on Lag Time to Freeze Point
 Tests Conducted at National Research Council Climatic Engineering Facility
 April 12, 1995



CM1222rep\hotwater\T1_w_3p.GRF

FIGURE 3.4
Varied Fluid Temperature – Tests Representing Snow Removal,
Fluid Freeze Point and Surface Temperature Profile

OAT -5° C, FFP -15° C, Type I EG Fluid, Winds Calm
 Fluid Freeze Point and Surface Temperature Profile

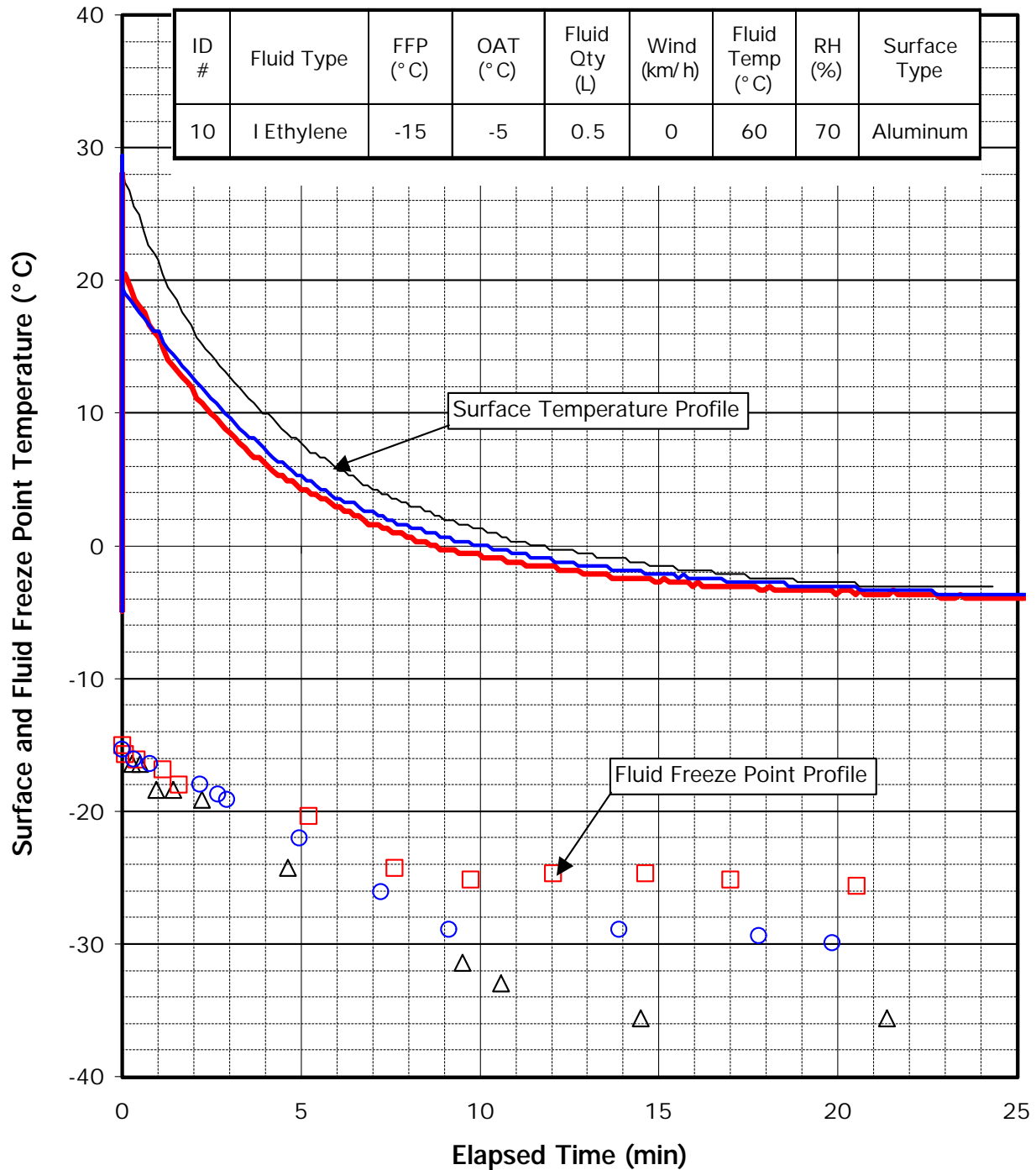

FIGURE 3.5
Fluid Freeze Point and Surface Temperature Profile
on Special Plates

OAT -25°C, Winds Calm, Composites

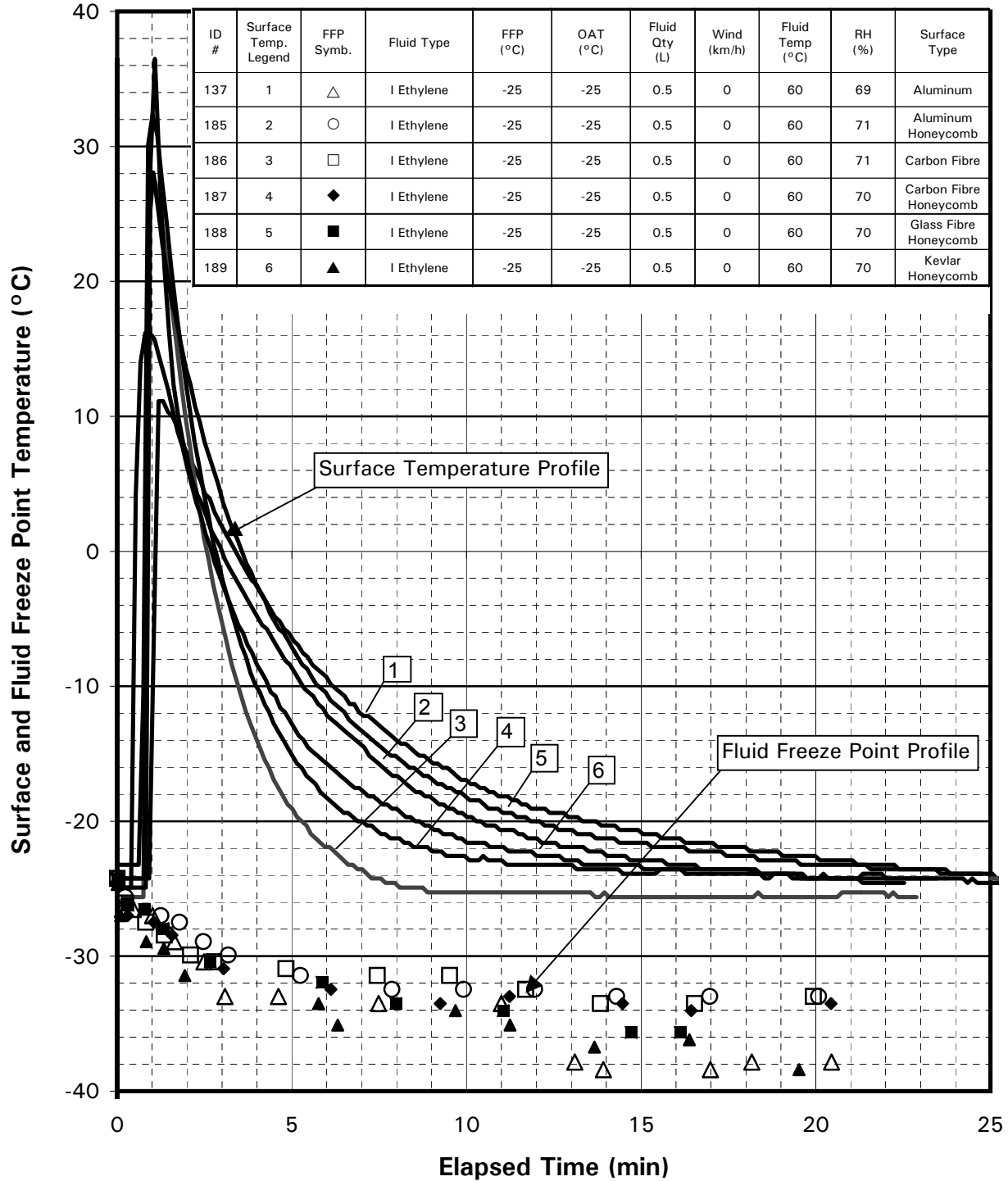
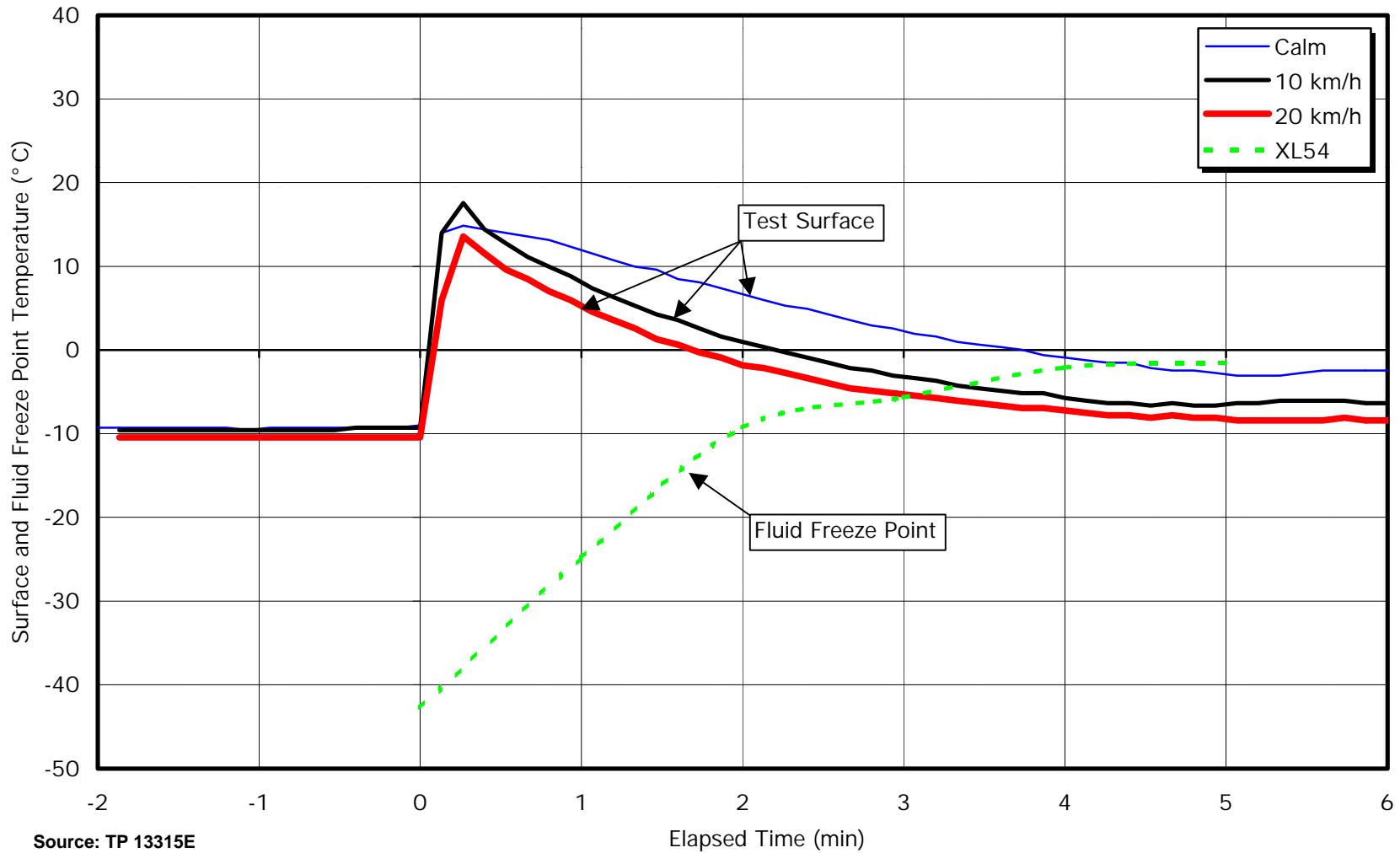

FIGURE 3.6
FIRST STEP TRIALS 1997-1998
TEMPERTURE PROFILES OF TEST SURFACE AND FLUID FREEZE POINT

Light Freezing Rain (25 g/dm²/hr), OAT = -10°C
Full Strength Type I Fluid



Source: TP 13315E

FIGURE 3.7
Effect of Fluid Amount on Temperature Profiles

Wind = 10 km/h, OAT = -12°C, Hot Water
 Simulated Light Freezing Rain (25 g/dm²/hr)
 ID# 18, 20, 27, & 28

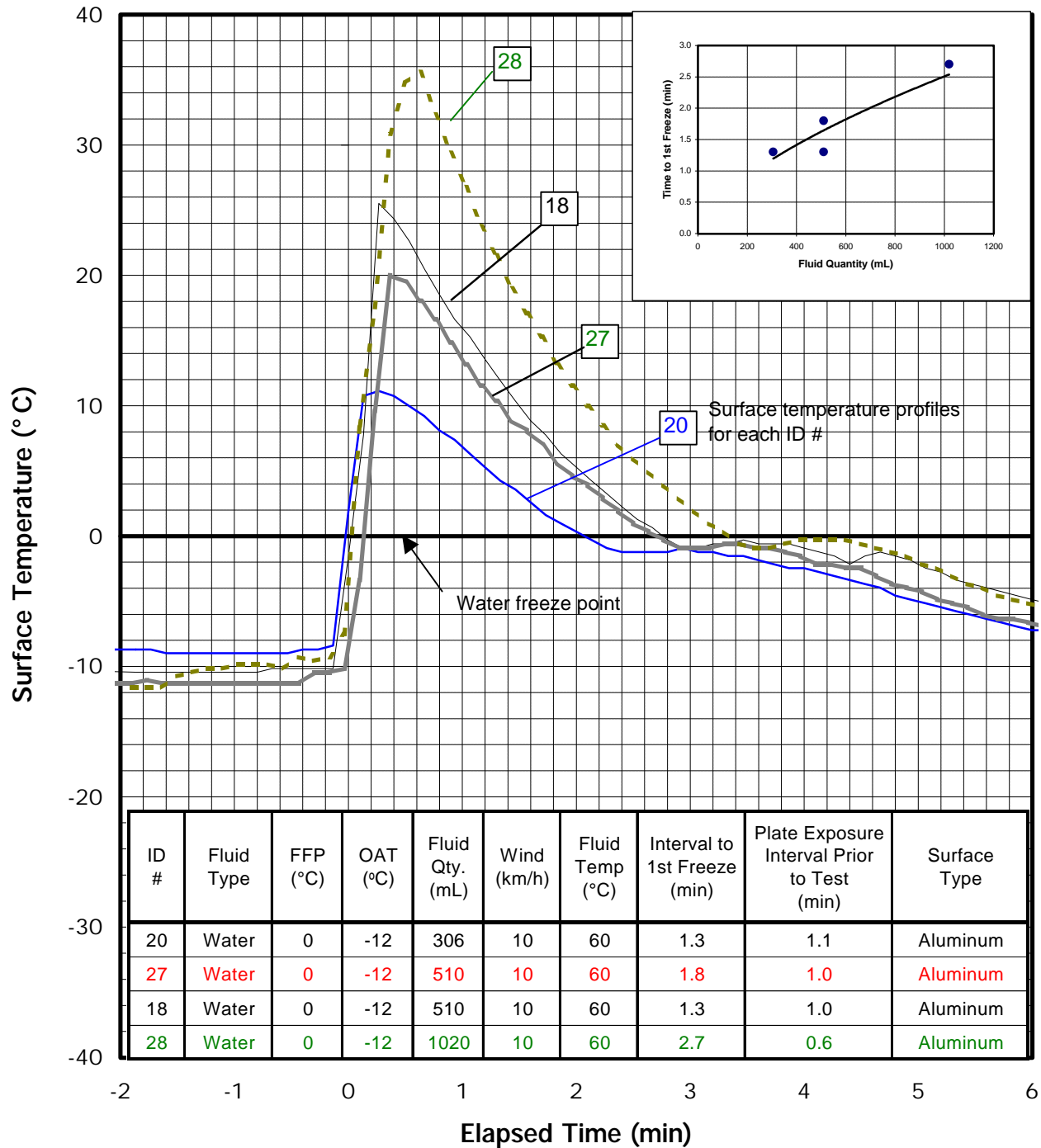

FIGURE 3.8
Progression of Failures
 ID 24

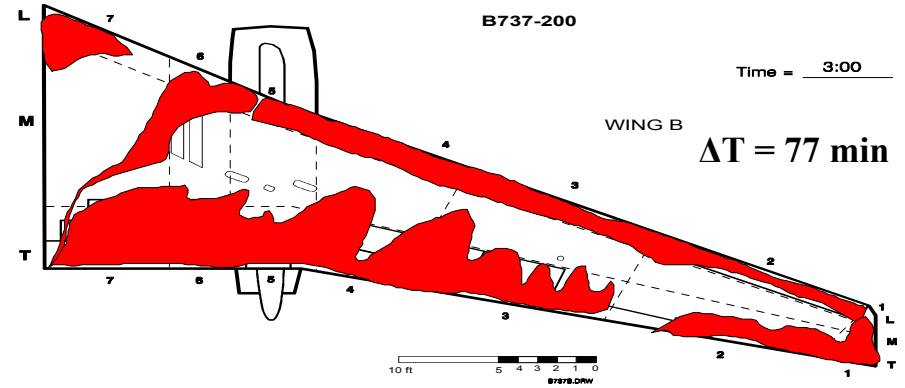
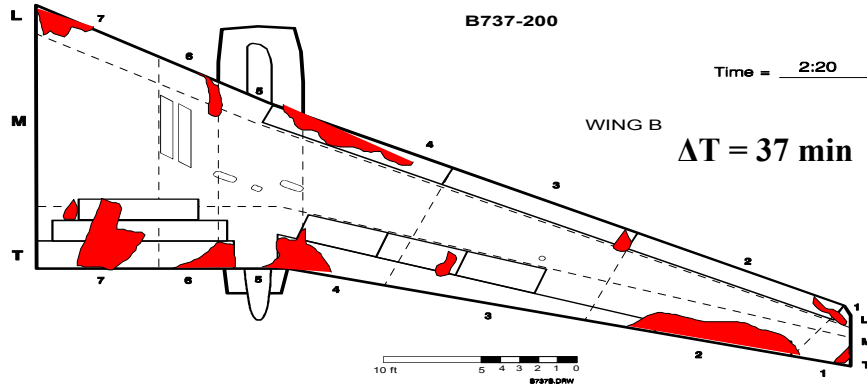
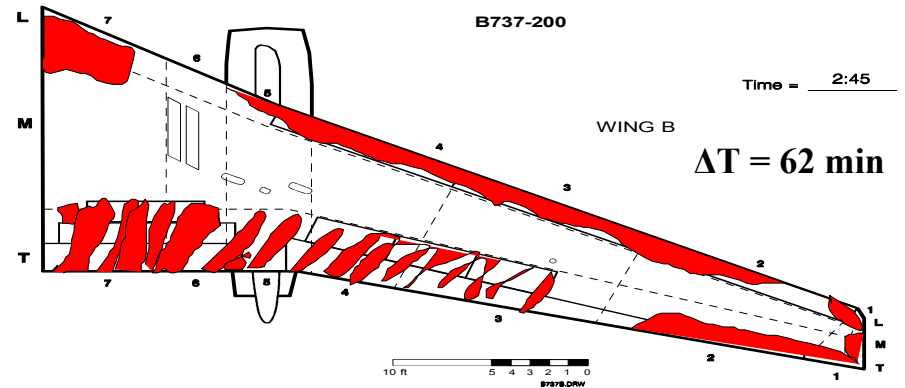
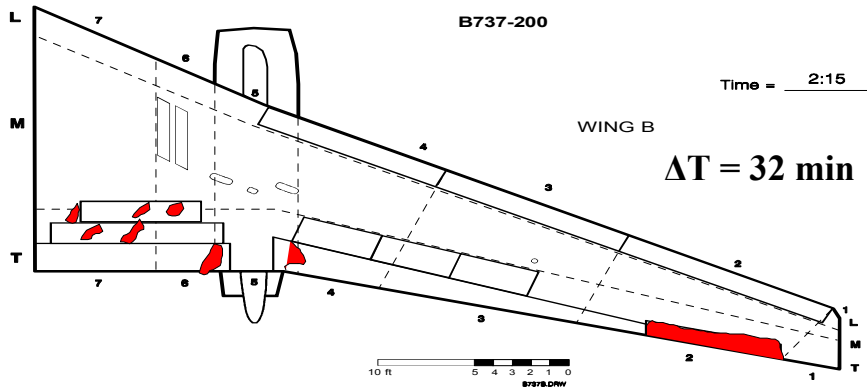
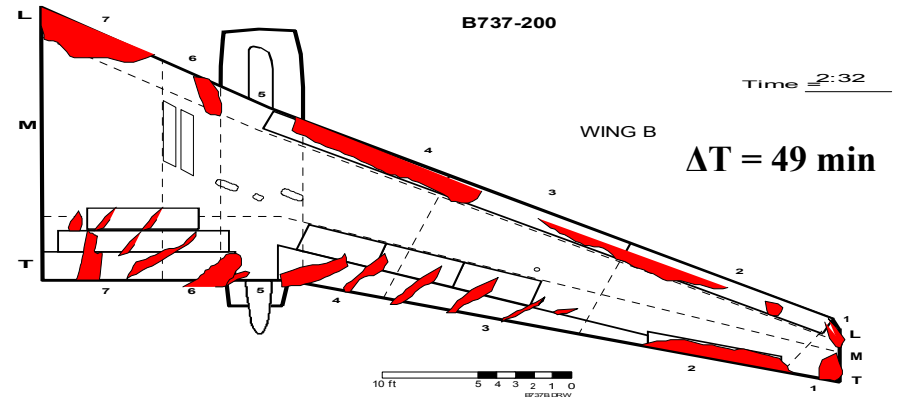
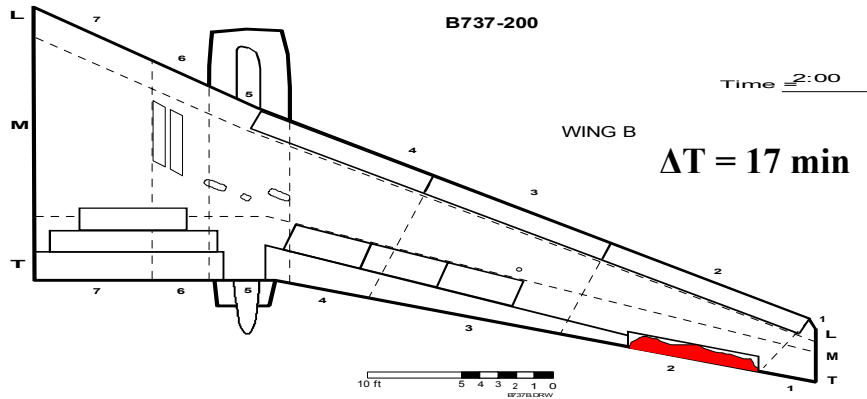

FIGURE 3.9
Aircraft Leading Edge Temperature Profiles from Previous Tests
 Adjusted to OAT -9°C

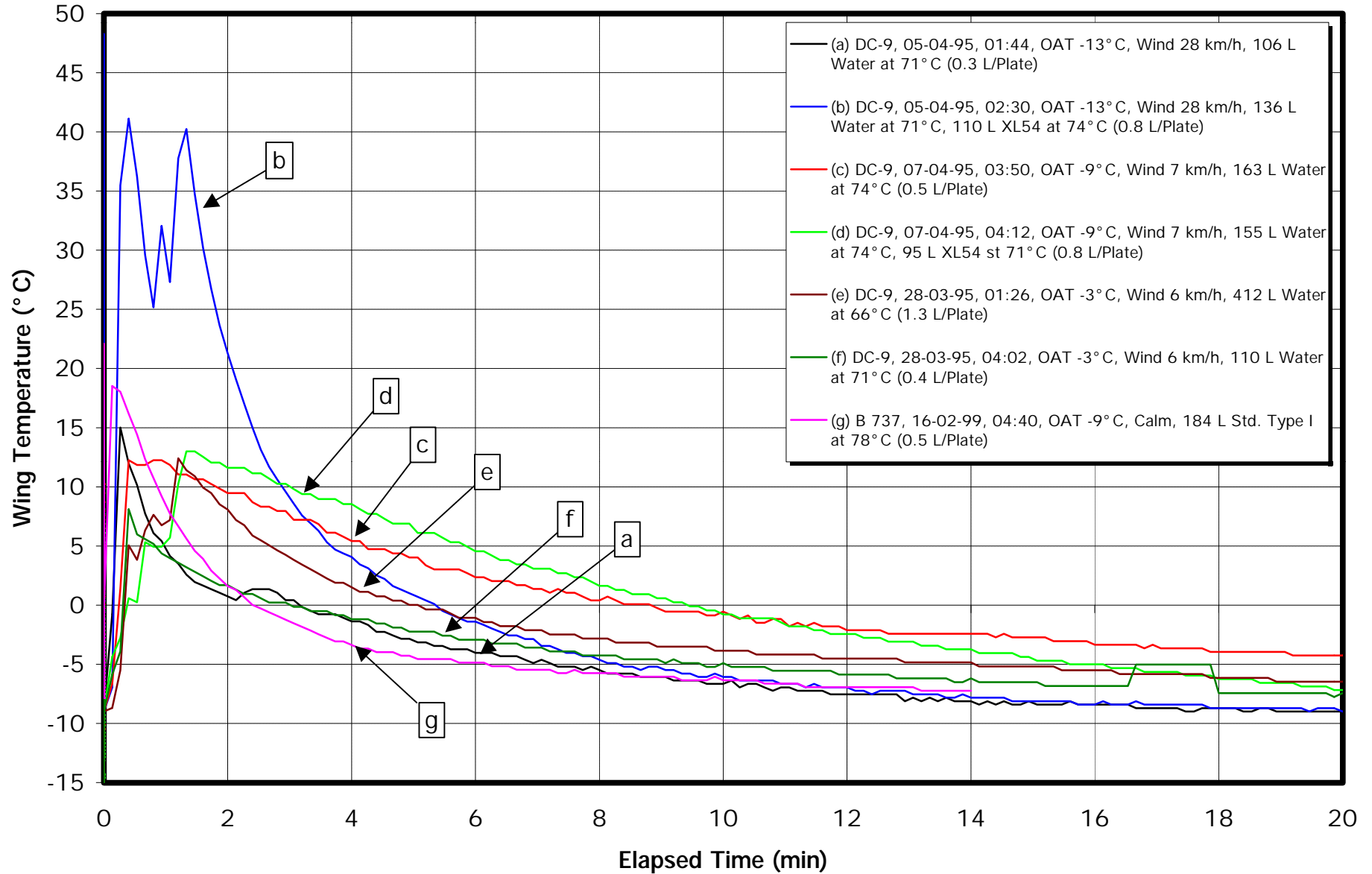

FIGURE 3.10
Aircraft Leading Edge Temperature Profiles
 Adjusted to OAT -9°C

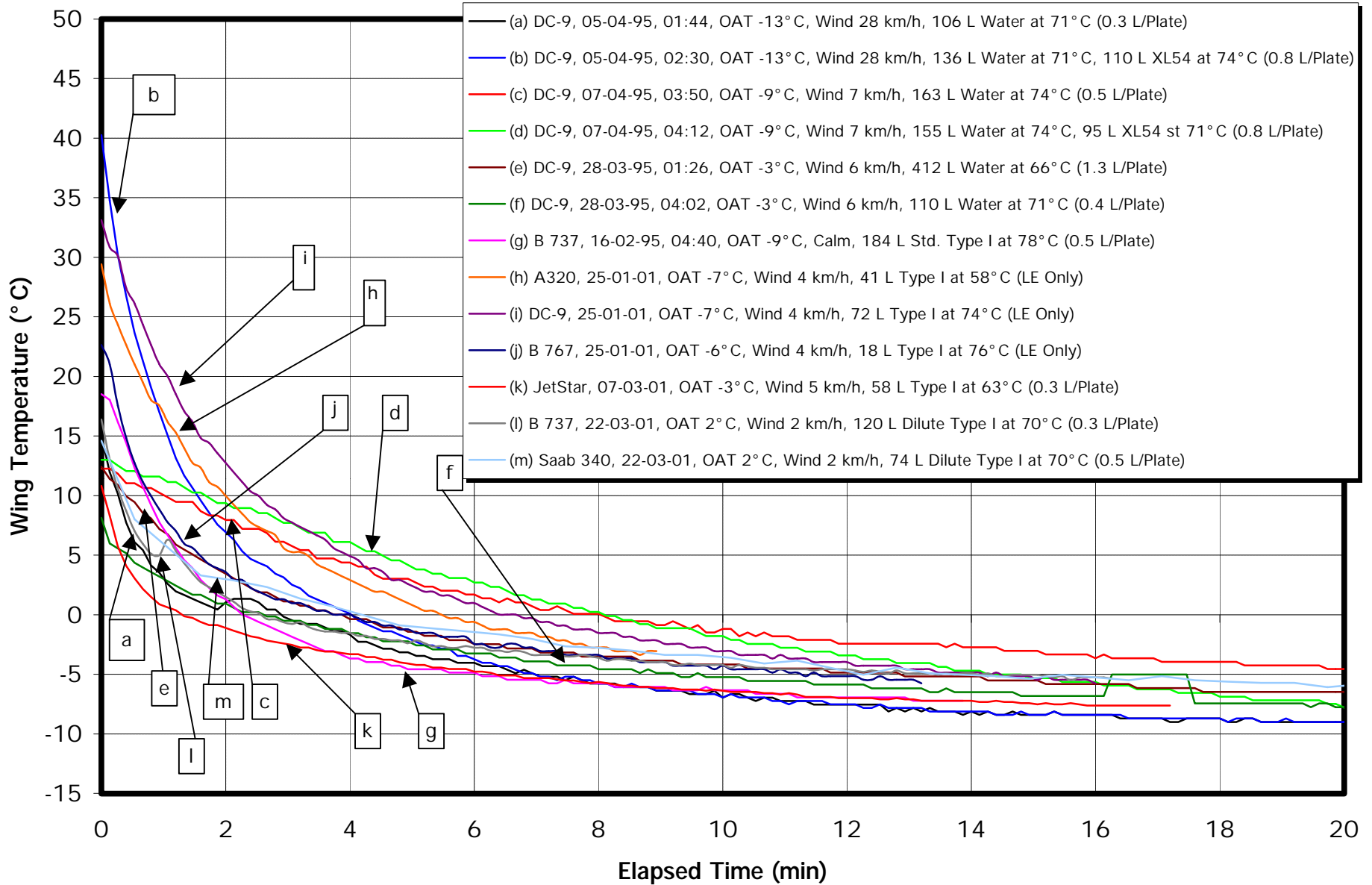

FIGURE 3.11
Average Wing Surface Temperature Profiles

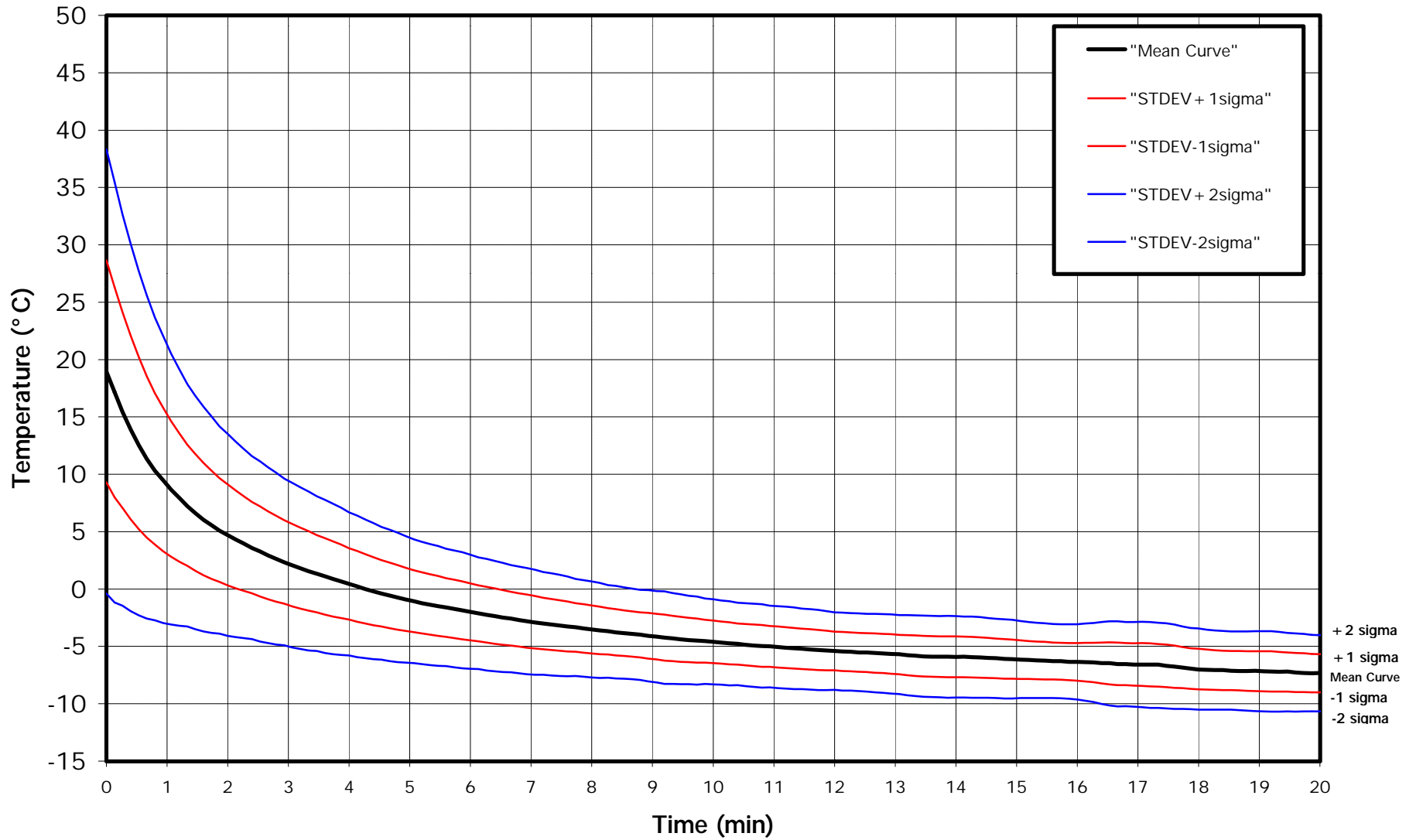

FIGURE 3.12

JetStar Wing Surface Temperature Profiles, Wing Tank Empty

March 7, 2001, UCAR XL-54 Type I Fluid, Run # 2, 54 L @ 65°C, Adjusted at -9°C

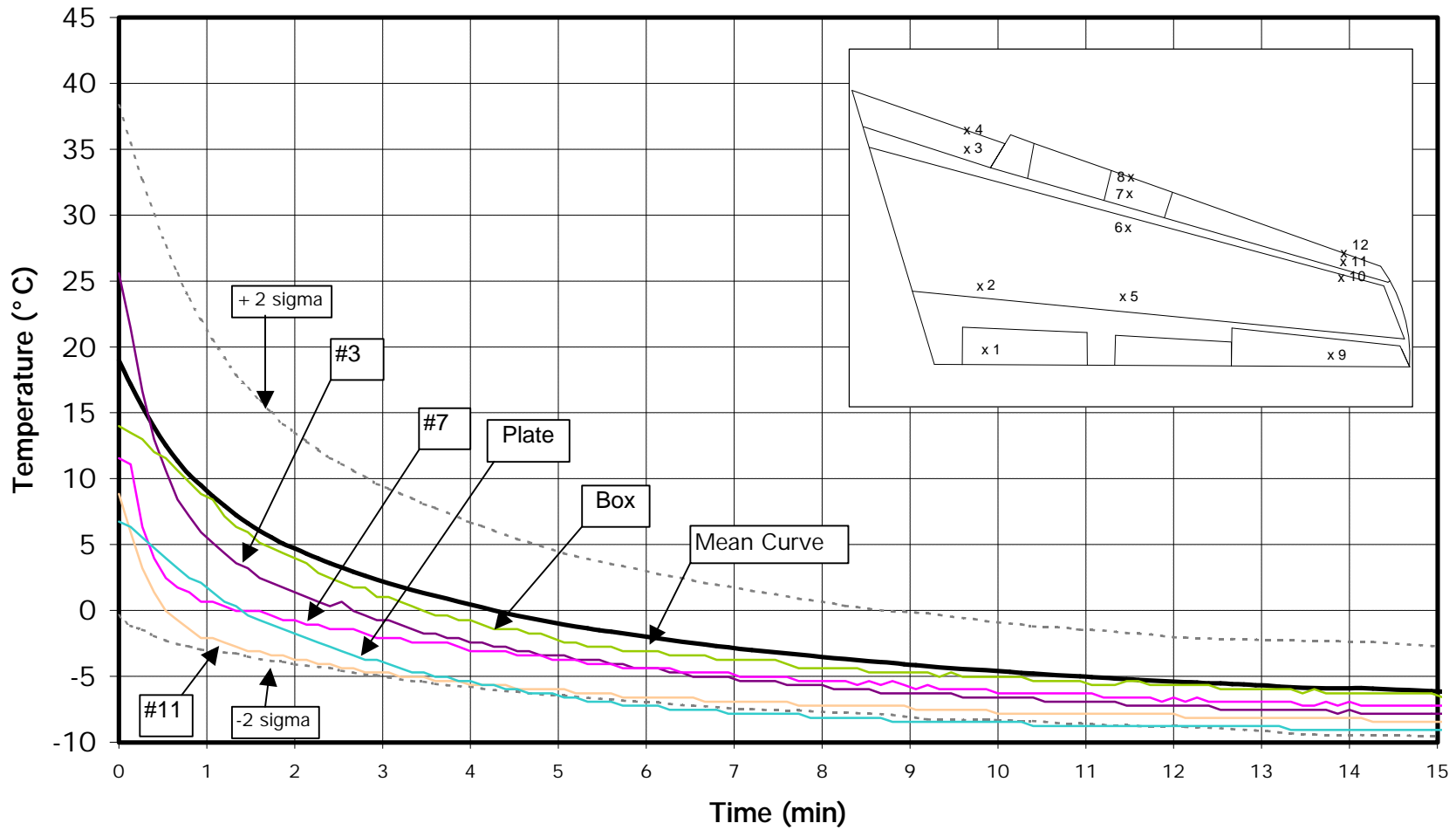

FIGURE 3.13

JetStar Wing Surface Temperature Profiles, Wing Tank 25% Filled

March 7, 2001, UCAR XL-54 Type I Fluid, Run # 3, 50 L @ 63°C, Adjusted at -9°C

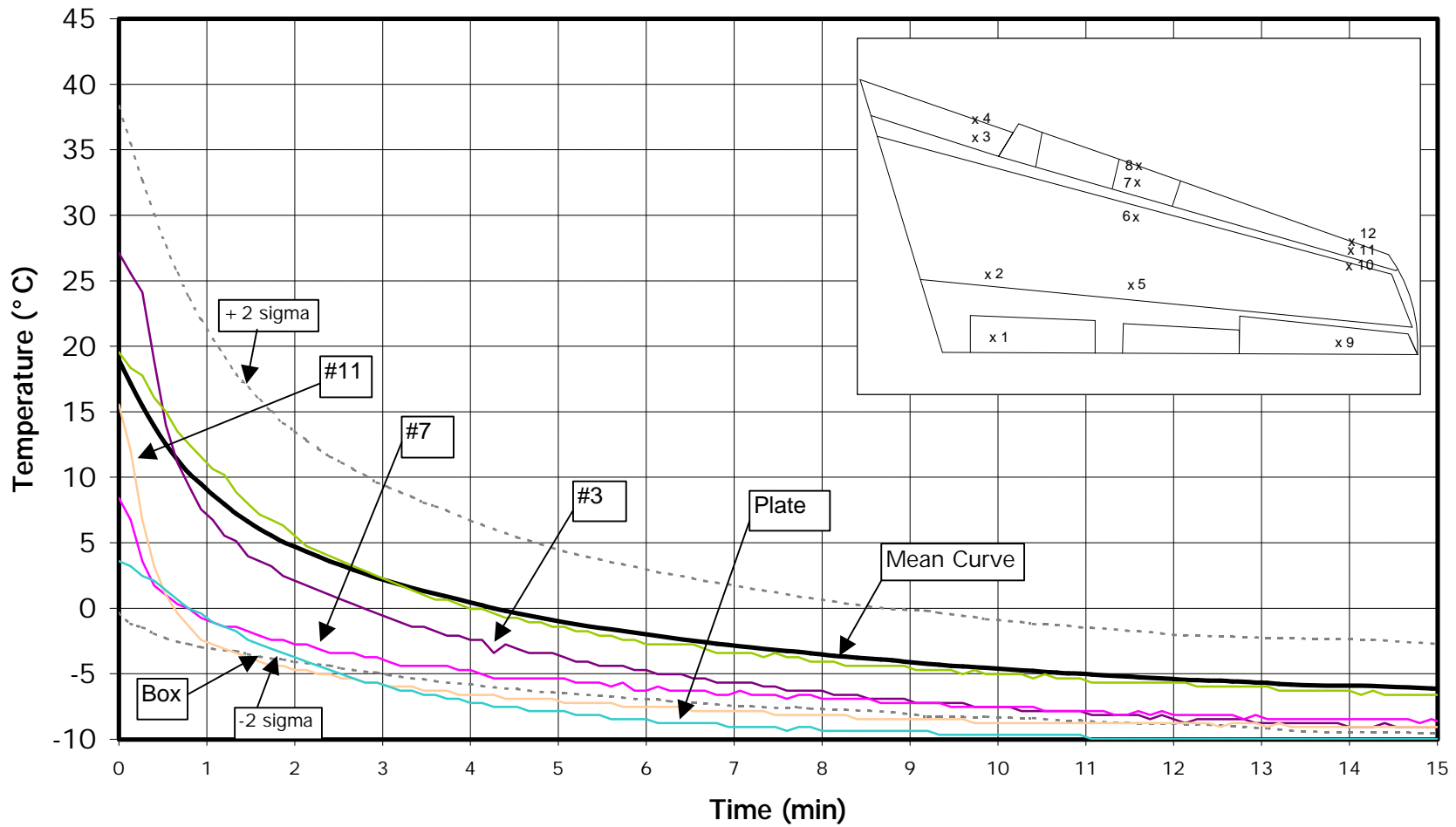

FIGURE 3.14

JetStar Wing Surface Temperature Profiles, Wing Tank 50% Filled

March 7, 2001, UCAR XL-54 Type I Fluid, Run # 4, 58 L @ 63°C, Adjusted at -9°C

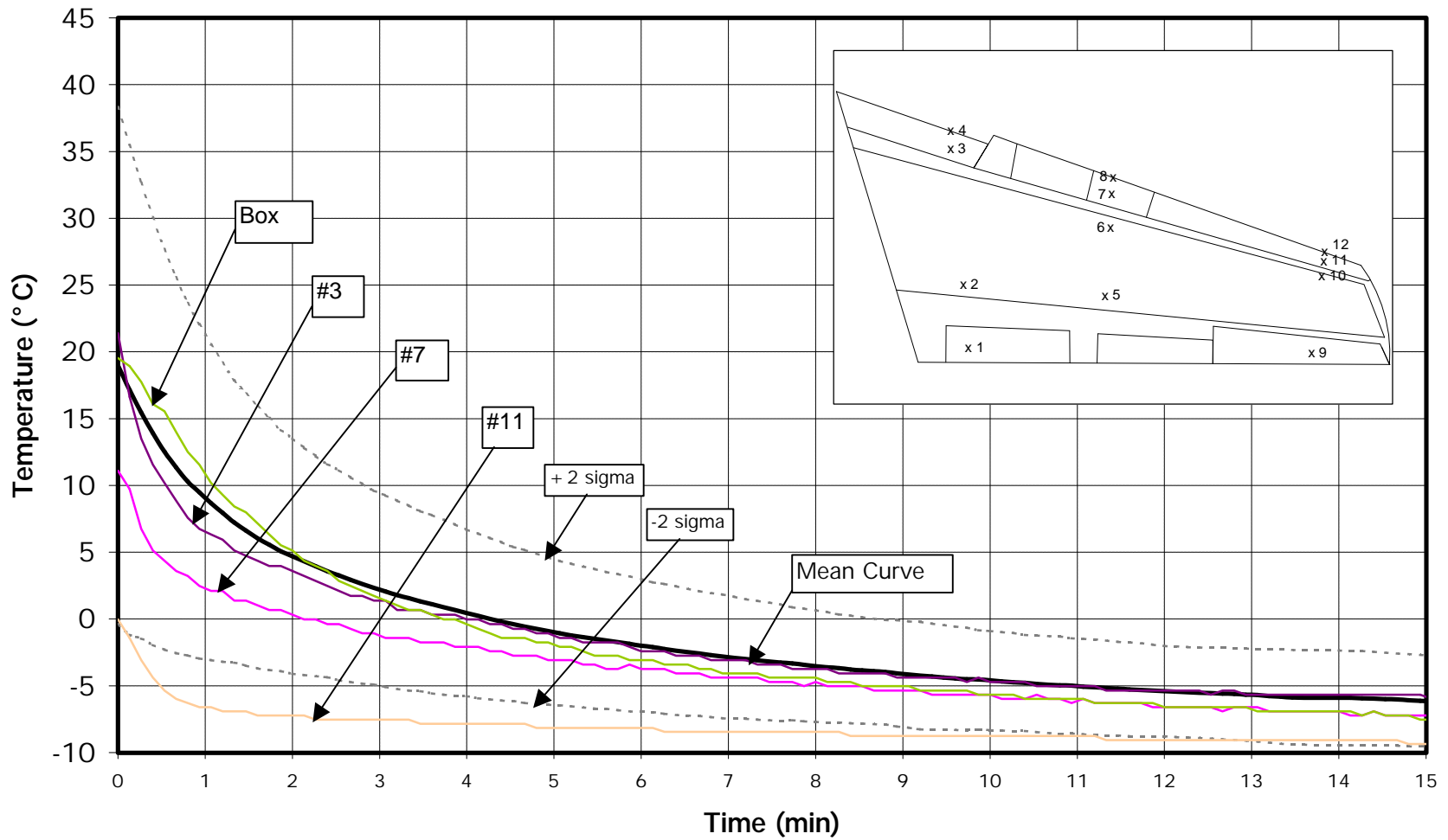

FIGURE 3.15

JetStar Wing Surface Temperature Profiles, Surface over Inner-Wing Tank, # 2

March 7, 2001 Central Deicing Pad, Ottawa Airport, UCAR XL-54 Type I Fluid,

OAT = -3°C , Adjusted at -9°C , Wind Speed = 5 km/h

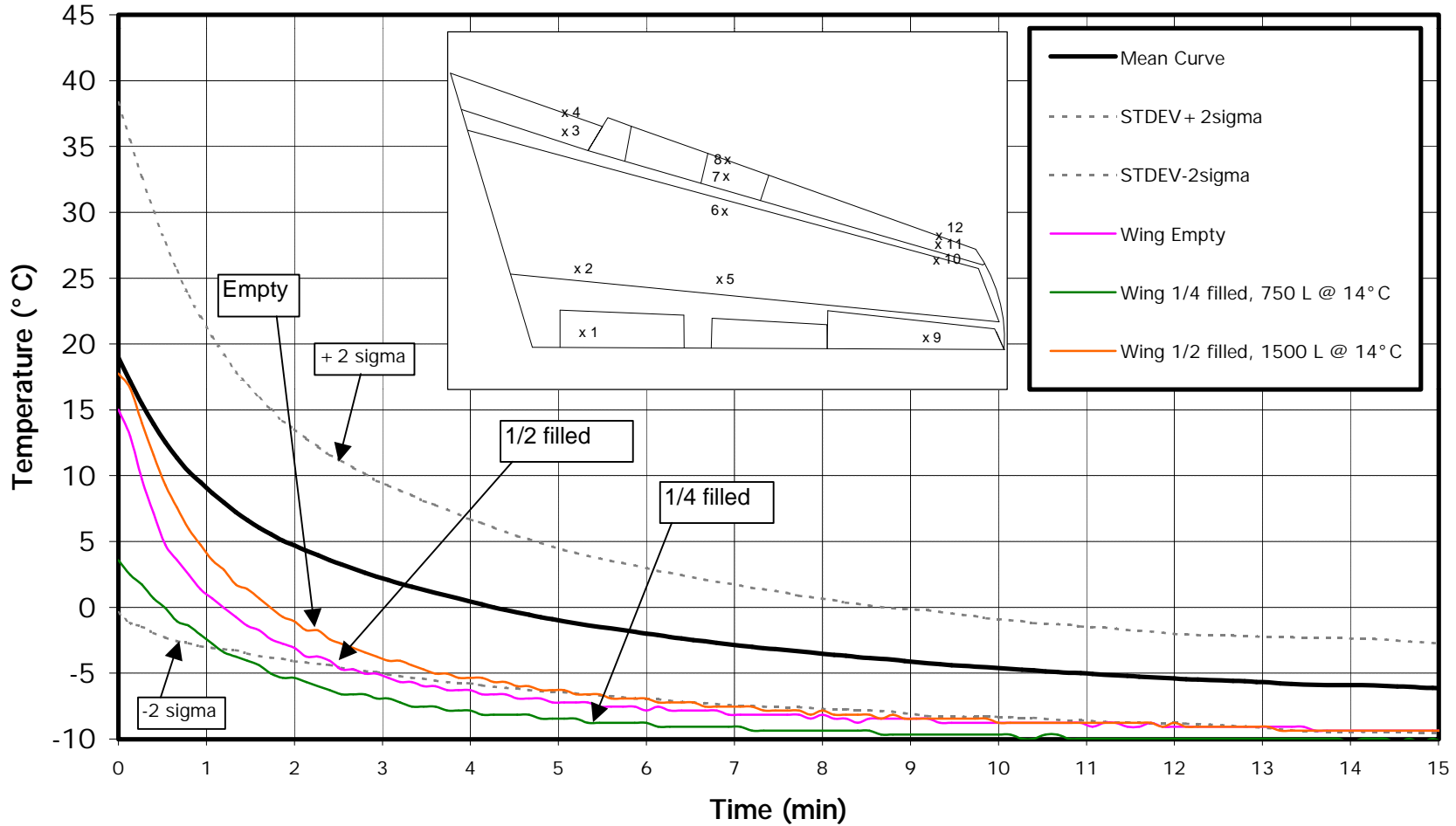

FIGURE 3.16

JetStar Wing Surface Temperature Profiles, Surface over Mid-Wing Tank, # 5

March 7, 2001 Central Deicing Pad, Ottawa Airport, UCAR XL-54 Type I Fluid,

OAT = -3°C , Adjusted at -9°C , Wind Speed = 5 km/h

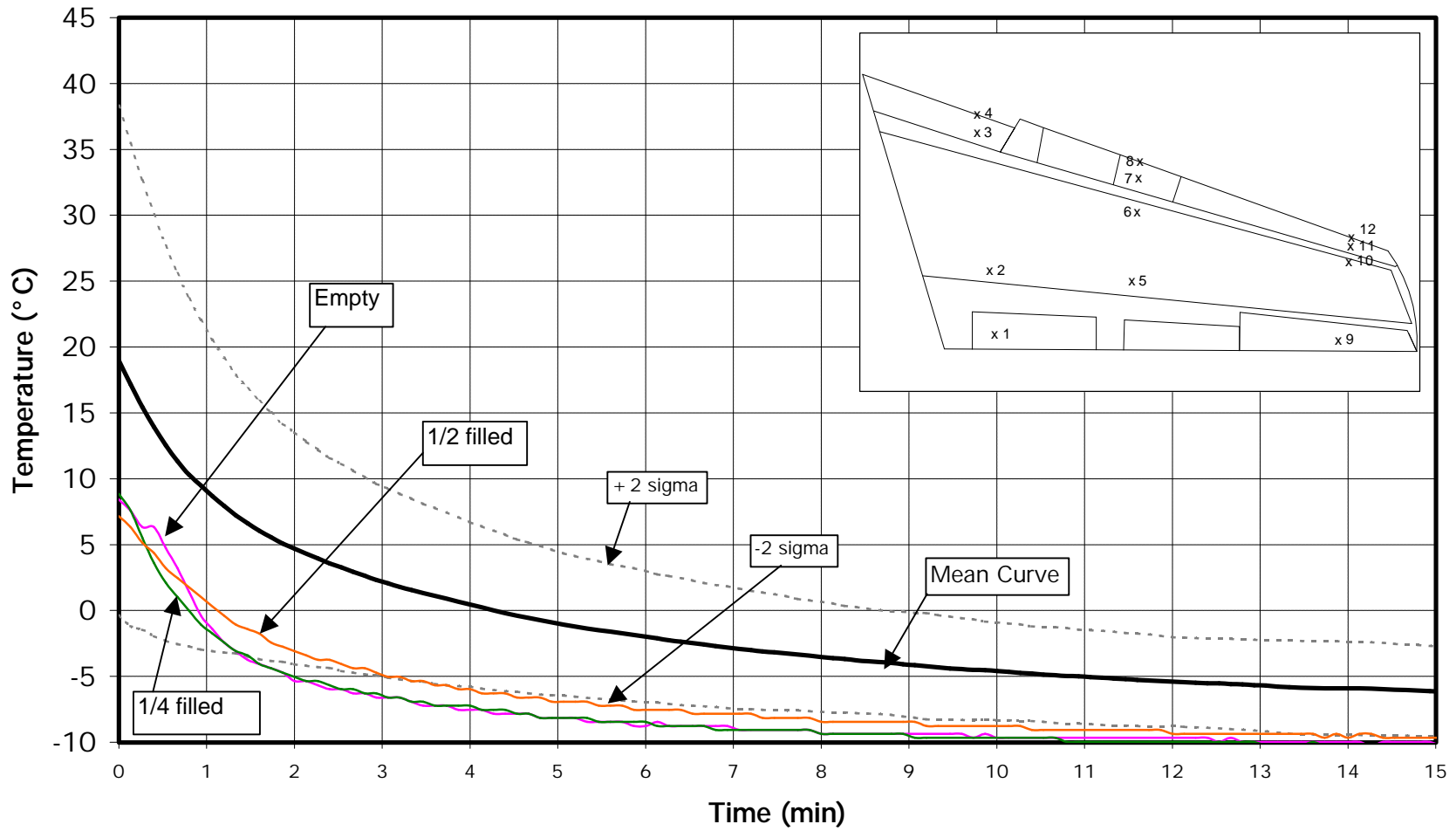

FIGURE 3.17

JetStar Wing Surface Temperature Profiles, Leading Edge, # 7

March 7, 2001 Central Deicing Pad, Ottawa Airport, UCAR XL-54 Type I Fluid,

OAT = -3°C , Adjusted at -9°C , Wind Speed = 5 km/h

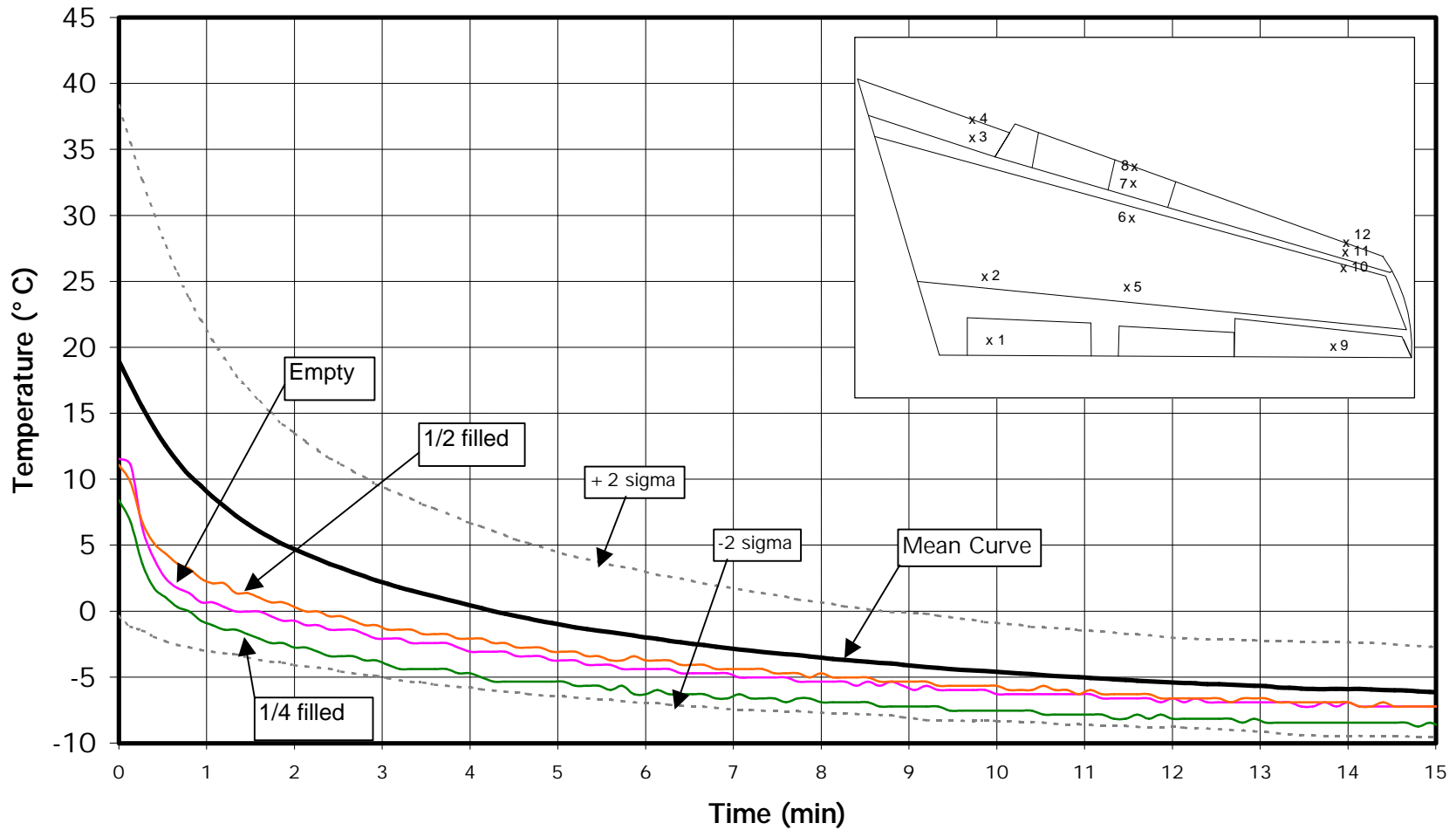

FIGURE 3.18

JetStar Wing Surface Temperature Profiles, Outer Wing Surface, # 10

March 7, 2001 Central Deicing Pad, Ottawa Airport, UCAR XL-54 Type I Fluid,

OAT = -3°C, Adjusted at -9°C, Wind Speed = 5 km/h

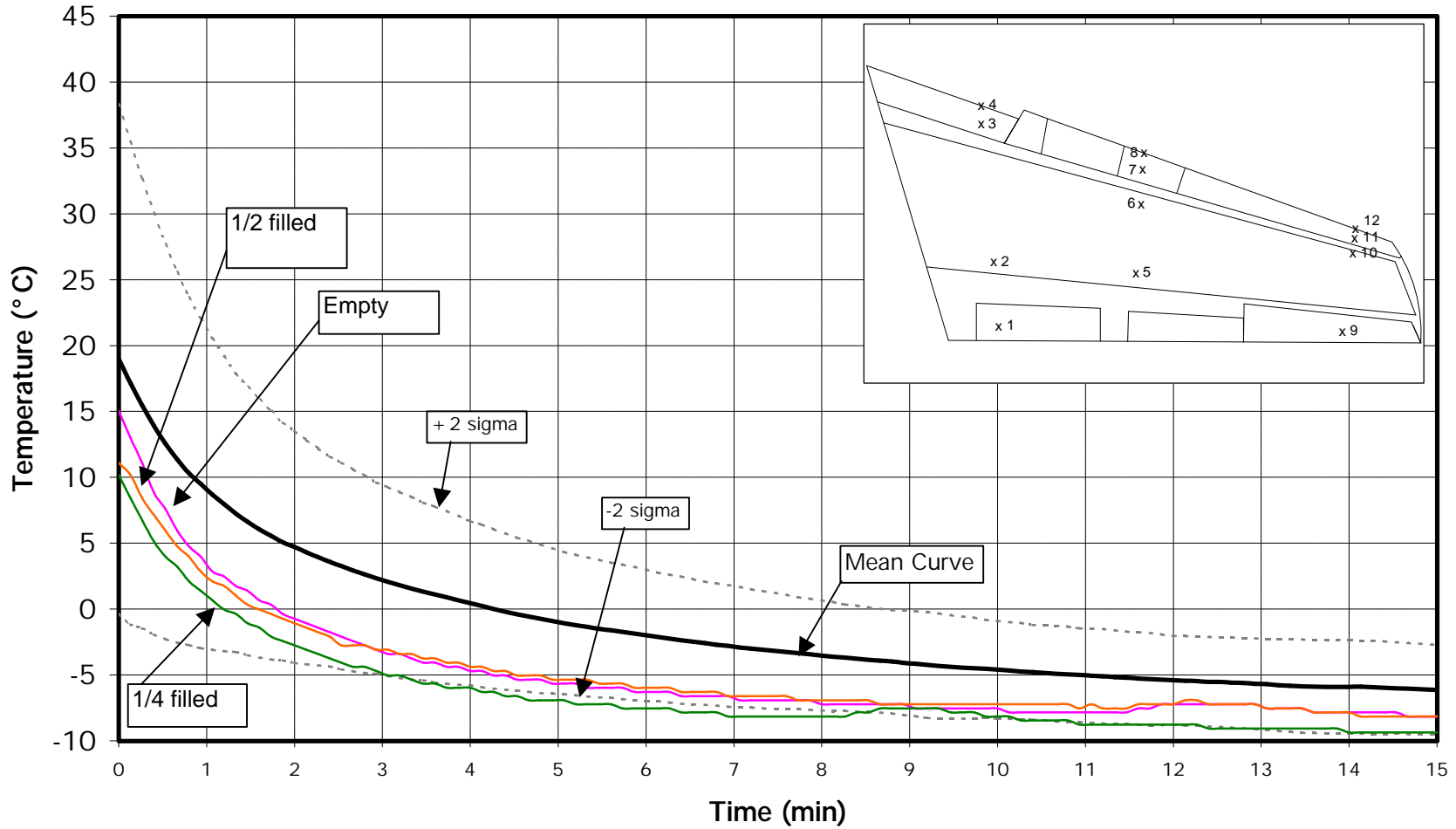

FIGURE 3.19

JetStar Wing Surface Temperature Profiles, Outer Leading Edge, # 11

March 7, 2001 Central Deicing Pad, Ottawa Airport, UCAR XL-54 Type I Fluid,

OAT = -3°C, Adjusted at -9°C, Wind Speed = 5 km/h

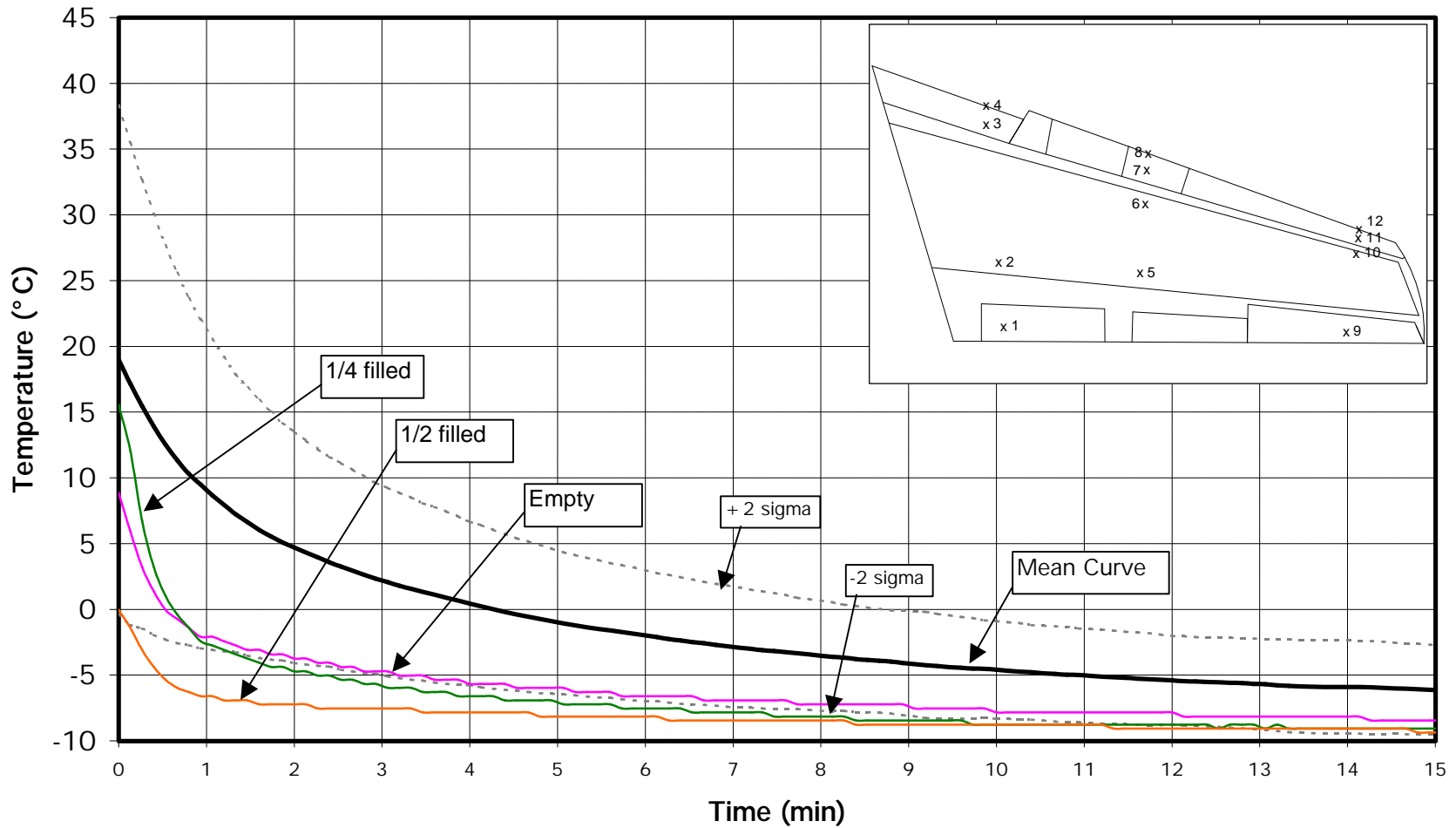

FIGURE 3.20

Saab 340 Wing + Boxes/Plate Surface Temperature Profiles, Run # 1

Central Deicing Facility, Dorval Airport, March 22, 2001

Type I Fluid @ FFP -12°C, Wing Spray 74 L @ 70°C, Wind 2 km/h, Dry, OAT -2°C, Adjusted to OAT -9°C

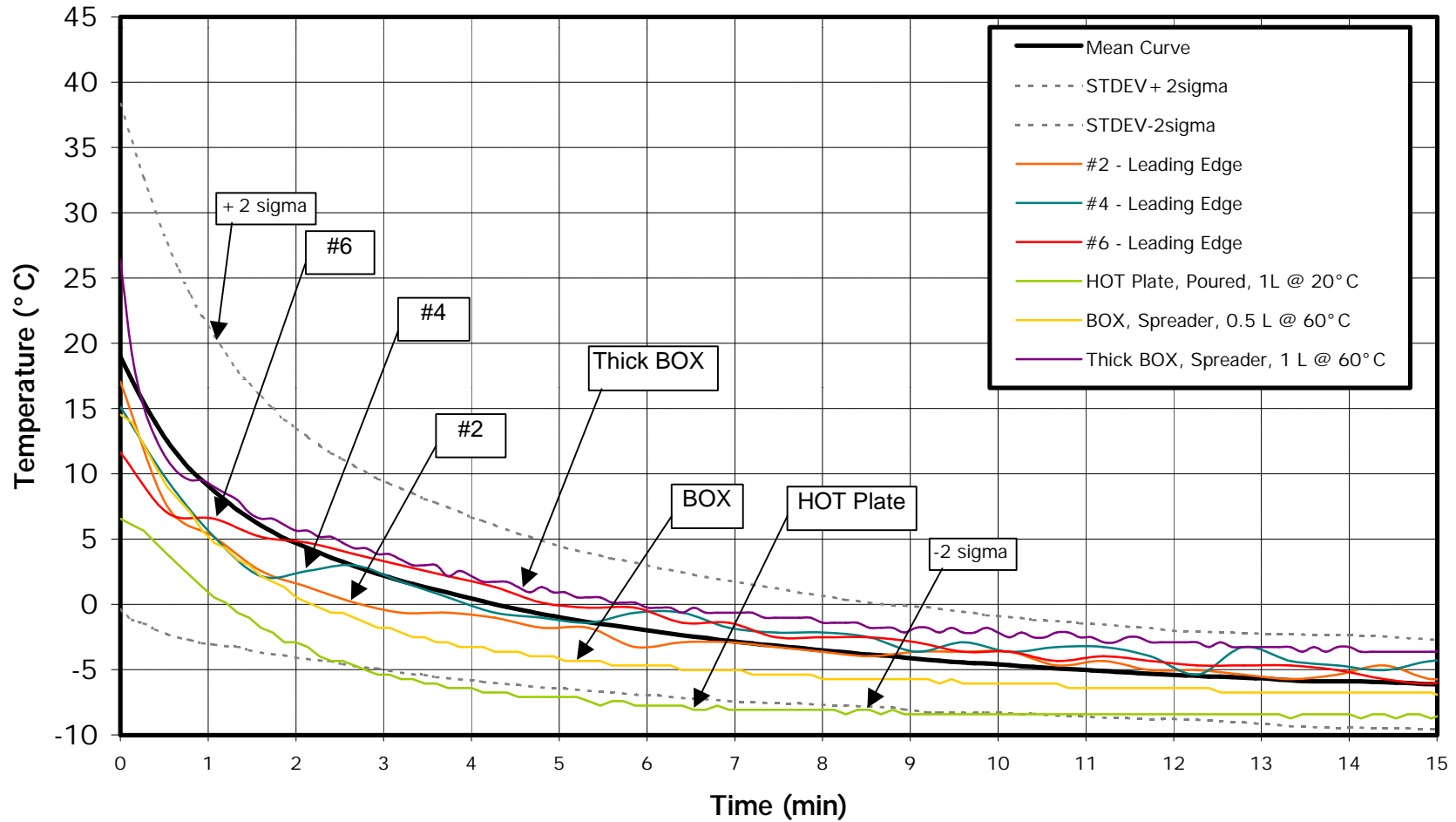

FIGURE 3.21

B 737 Wing + Boxes/Plate Surface Temperature Profiles, Run # 1

Central Deicing Facility, Dorval Airport, March 22, 2001

Type I Fluid @ FFP -12°C, Wing Spray 120 L @ 70°C, Wind 2 km/h, Dry, OAT -2°C, Adjusted to OAT -9°C

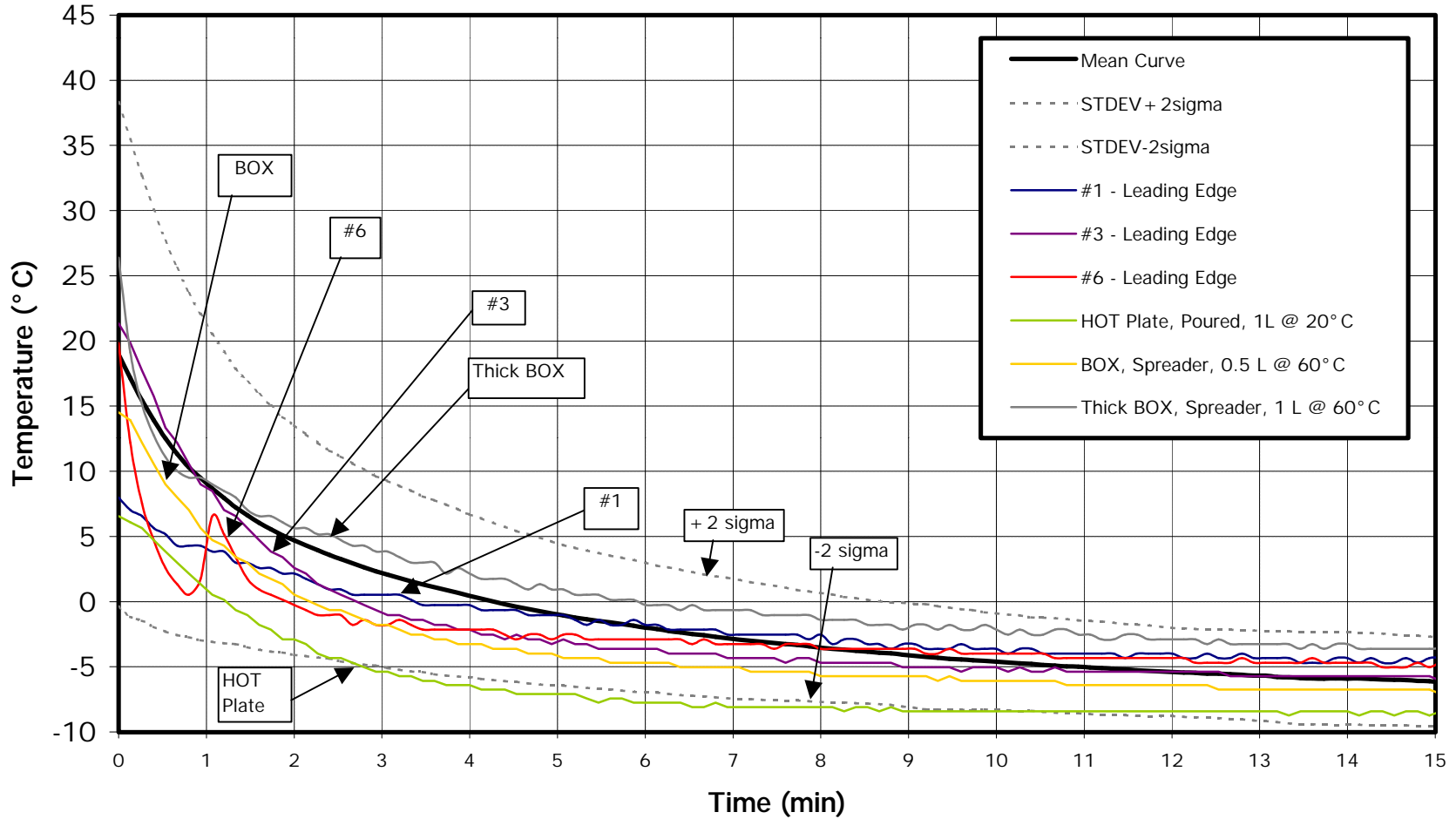

FIGURE 3.22

Standard Plate Surface Temperature Profiles

Temperature Profiles Adjusted to OAT -9°C

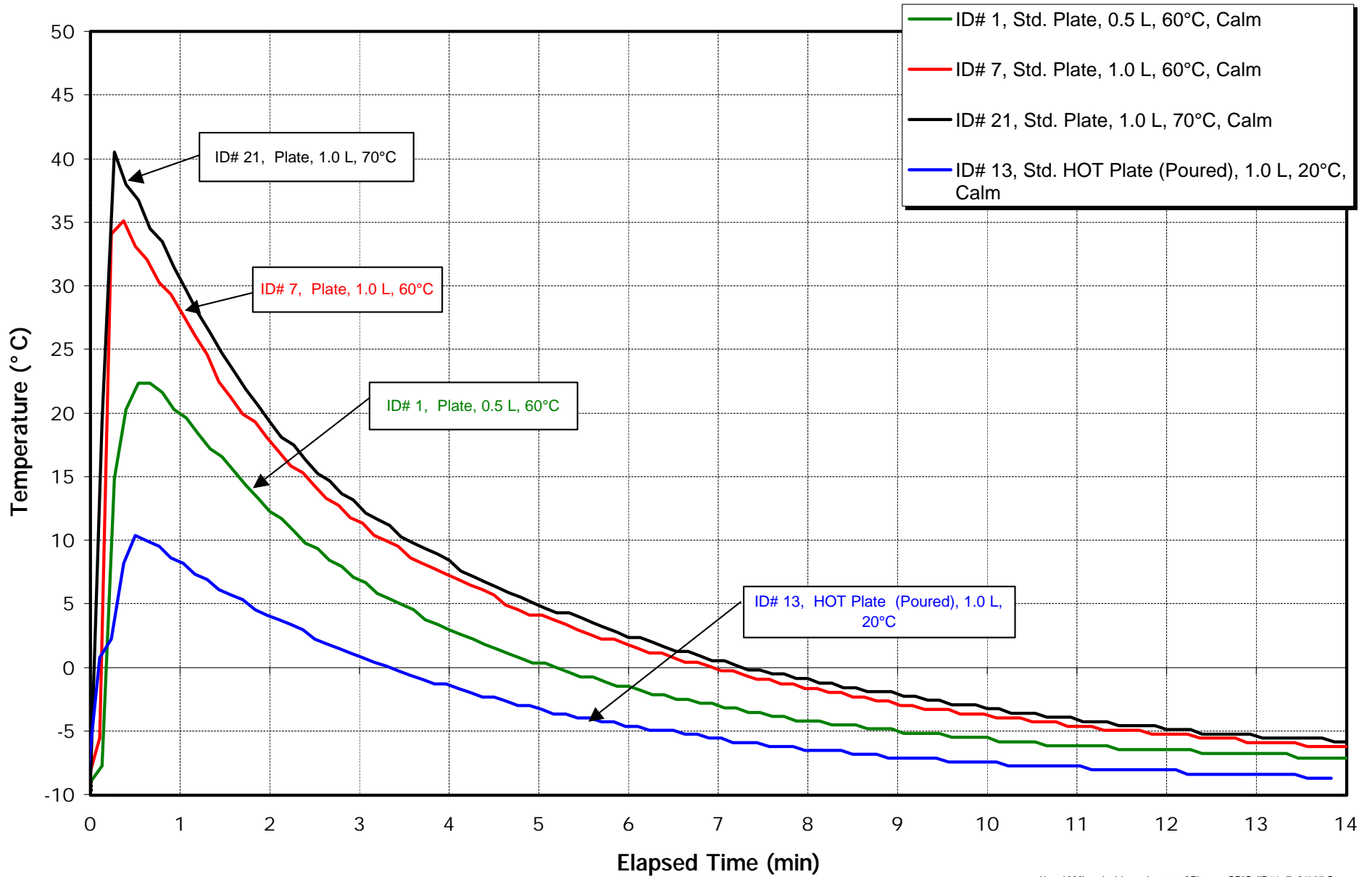

FIGURE 3.23
Standard Plate Surface Temperature Profiles
vs. Wing Leading Edge – from Previous Tests
 Temperature Profiles Adjusted to OAT -9°C

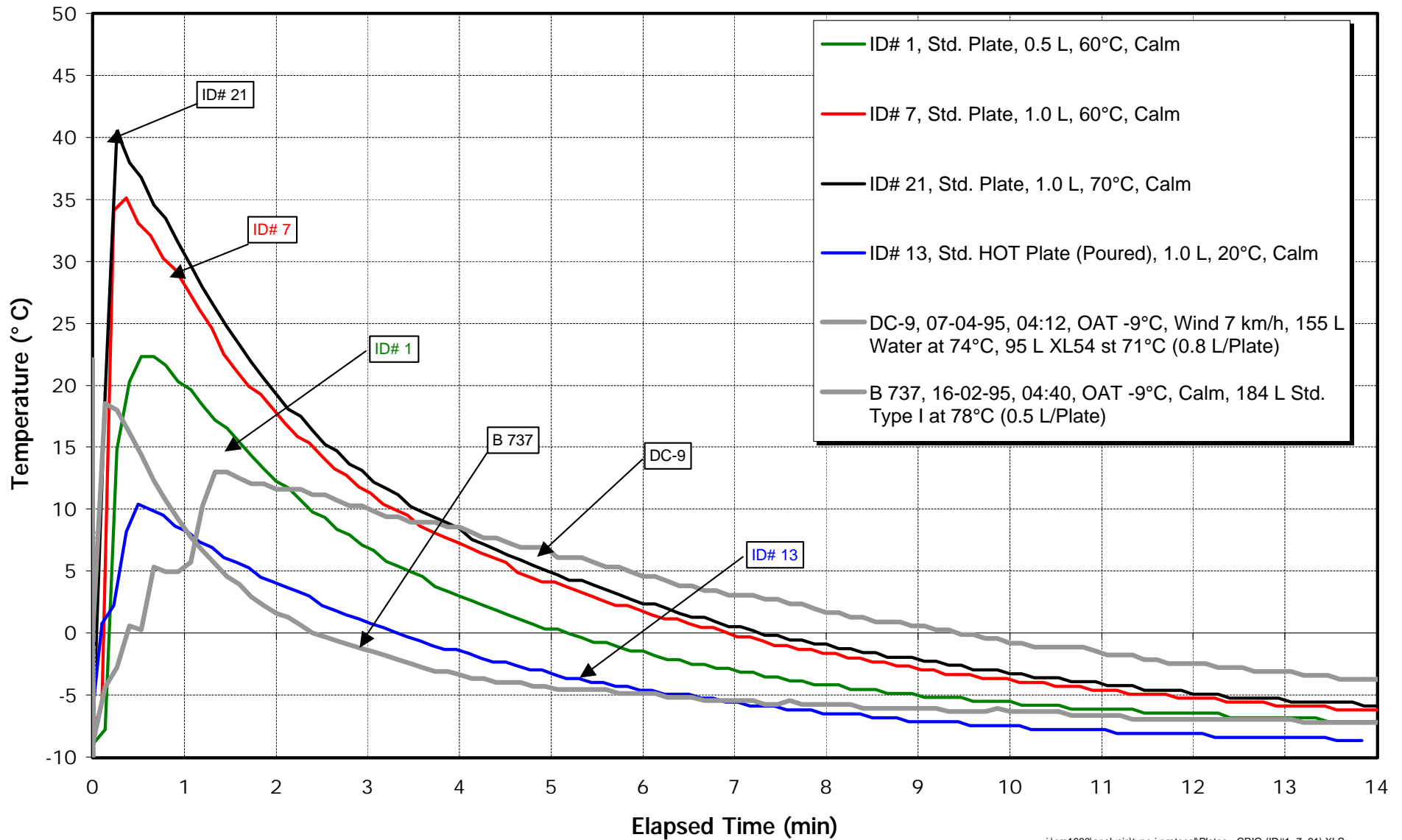

FIGURE 3.24

7.5 cm Cold-Soak Box 40% Filled – Surface Temperature Profiles

Temperature Profiles Adjusted to OAT -9°C

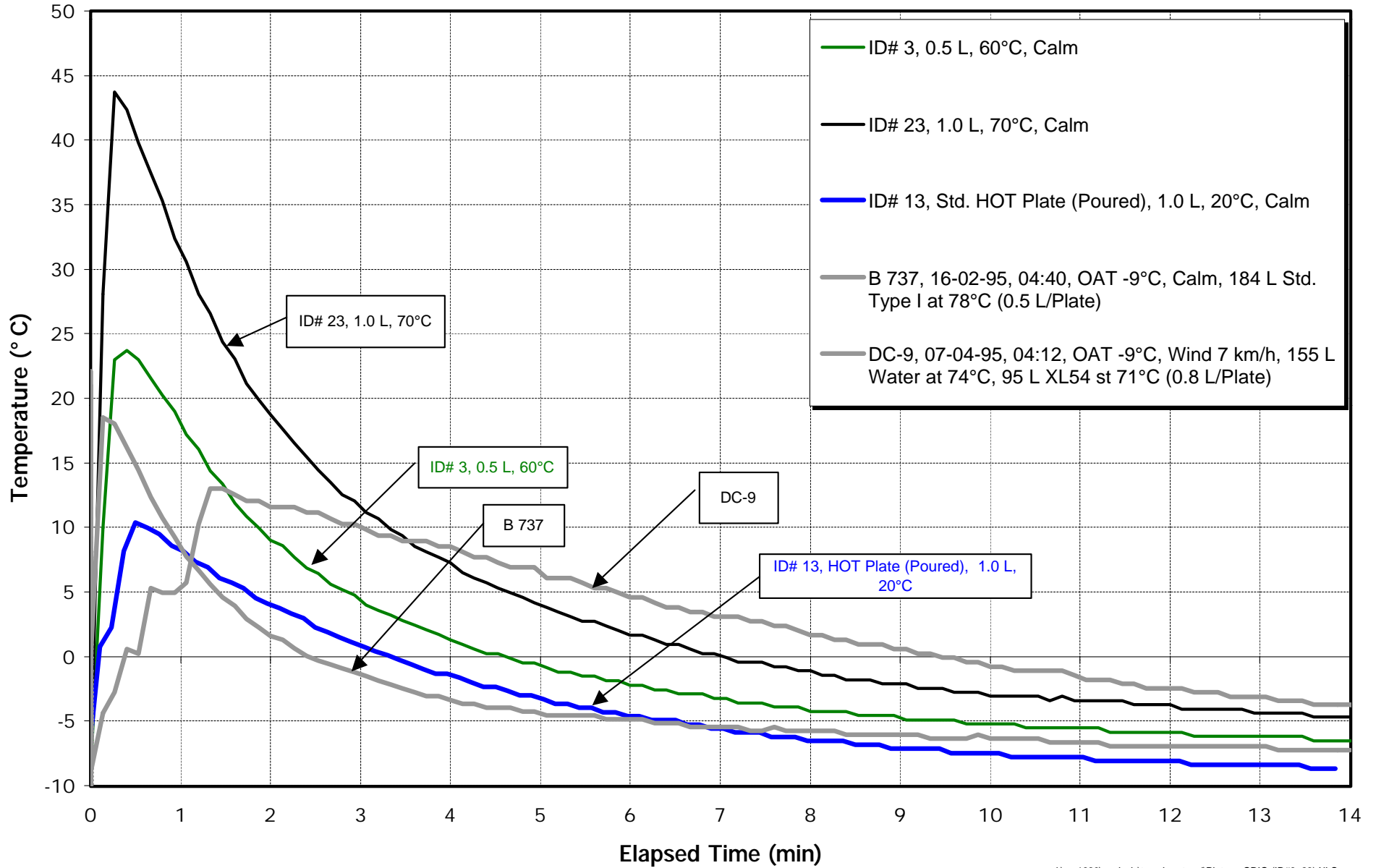

FIGURE 3.25

C/FIMS Plate Surface (6.4 mm) Temperature Profiles Temperature Profiles Adjusted to OAT -9° C

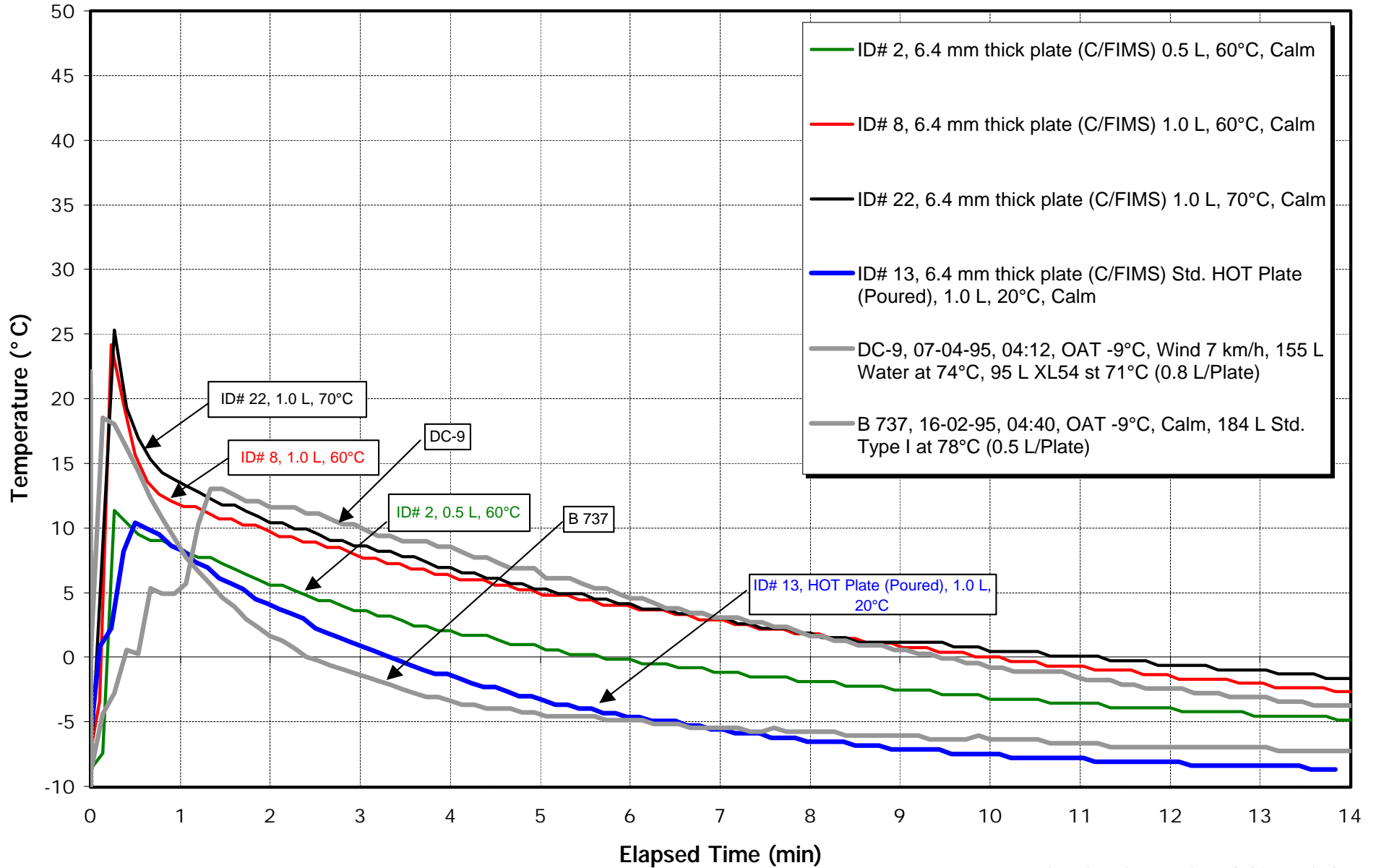

FIGURE 3.26

Standard Plate Surface Temperature Profiles vs. Wing Leading Edge

APS Test Site, Test 1, SAE Type I Fluid: 0.5 L @ Freeze Point -15°C ,
Wind Speed 15-25 km/h, OAT -8°C , Adjusted to OAT -9°C , December 07, 2000

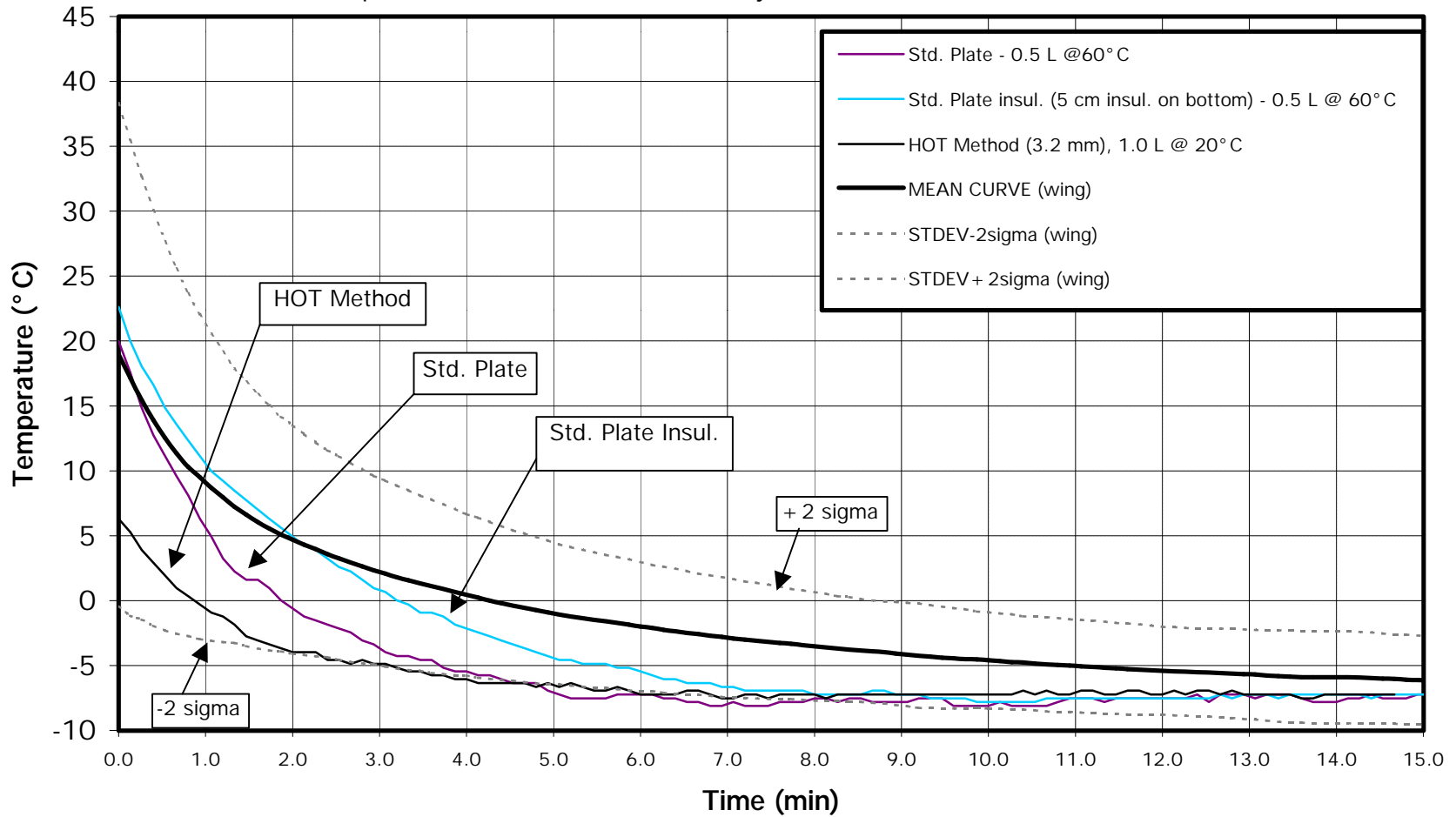

FIGURE 3.27

Standard Plate Surface Temperature Profiles vs. Wing Leading Edge

APS Test Site, Test 2, SAE Type I Fluid: 1.0 L @ Freeze Point -15°C , Wind Speed 20-25 km/h, OAT -8°C , Adjusted to OAT -9°C , December 7, 2000

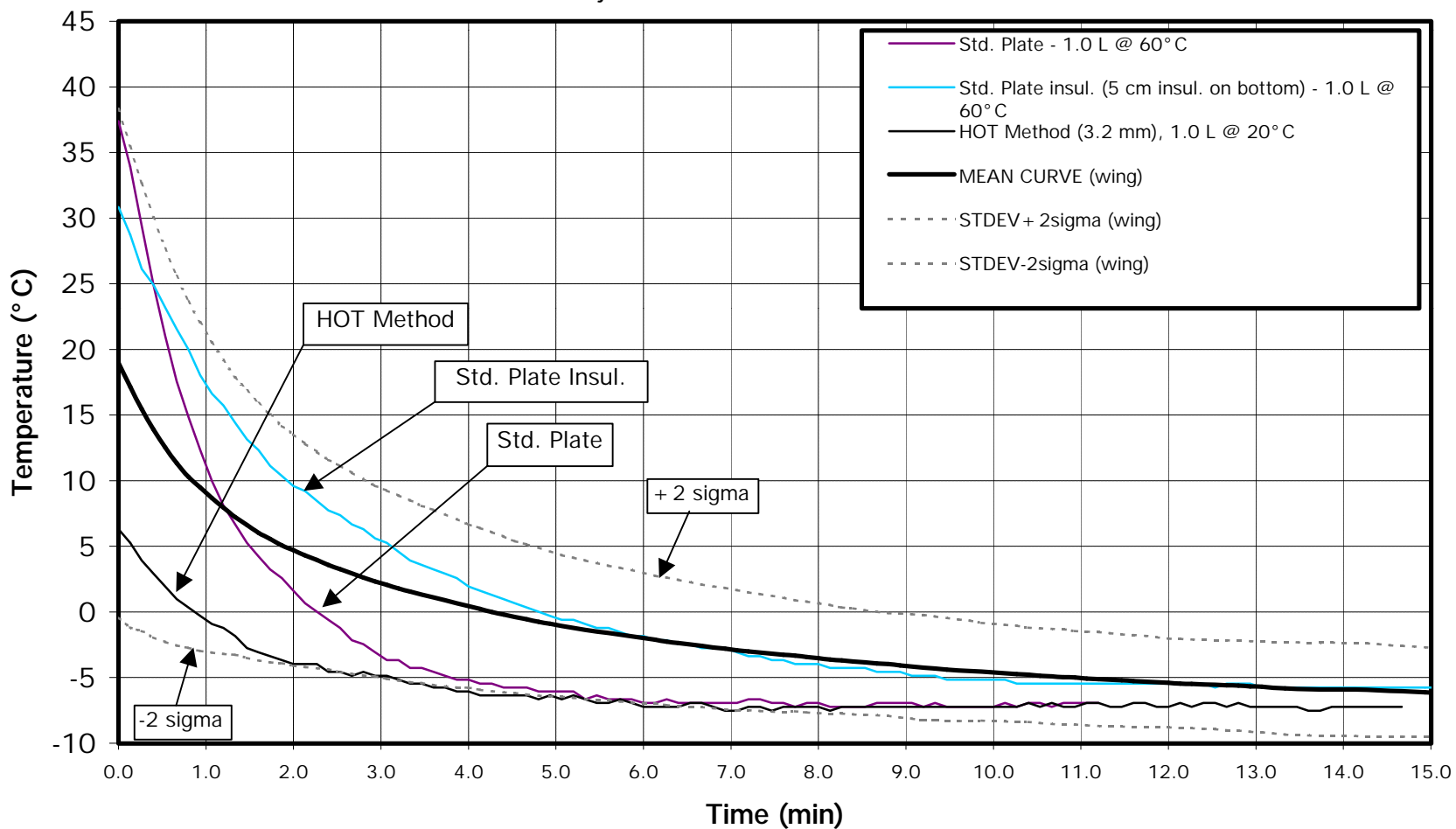

FIGURE 3.28

7.5 cm Box Plate Surface Temperature Profiles vs. Wing Leading Edge

APS Test Site, Test 1, SAE Type I Fluid: 0.5 L @ Freeze Point -15°C, Wind Speed 20-25 km/h, OAT -10°C, Adjusted to OAT -9°C, December 7, 2000

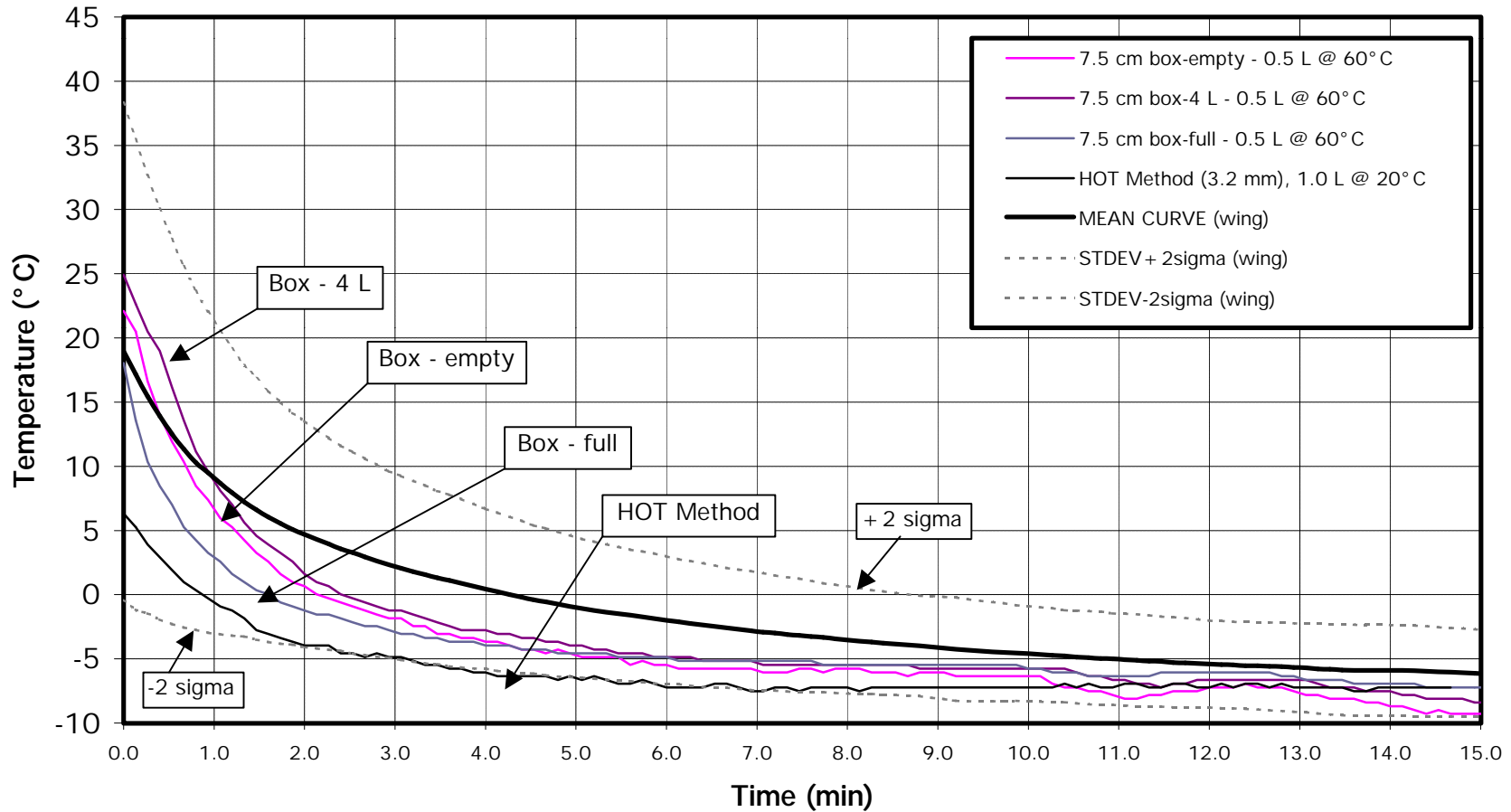

FIGURE 3.29

7.5 cm Box Plate Surface Temperature Profiles vs. Wing Leading Edge

APS Test Site, Test 2, SAE Type I Fluid: 1.0 L @ Freeze Point -15° C, Wind Speed 22-28 km/h,
OAT -8° C, Adjusted to OAT -9 ° C, December 07, 2000

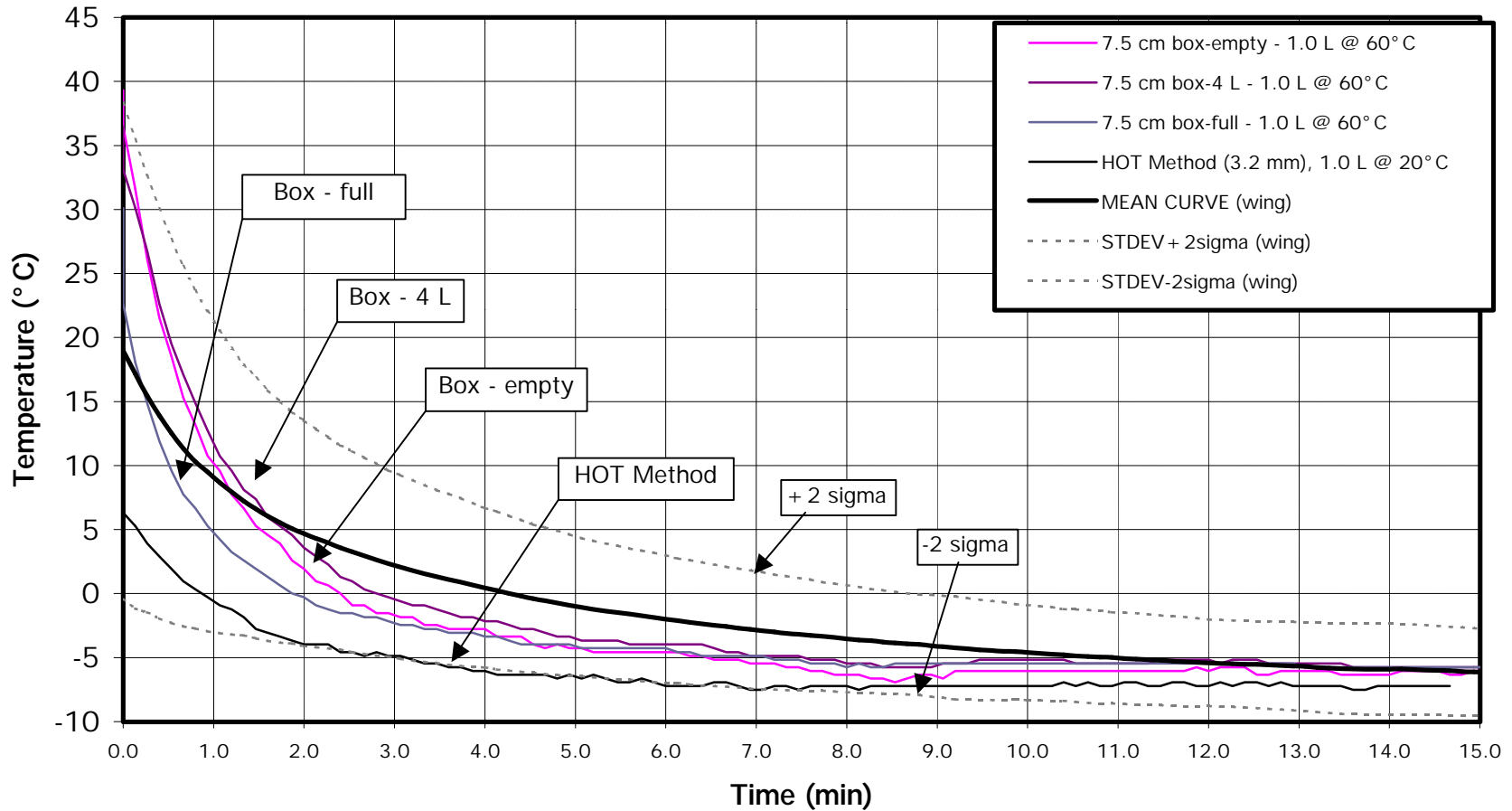

FIGURE 3.30

C/FIMS Plate Surface Temperature Profiles vs. Wing Leading Edge

APS Test Site, Test 1, SAE Type I Fluid: 0.5 L @ Freeze Point -15°C, Wind Speed 20-43 km/h, OAT -8°C, Adjusted to OAT -9°C, December 7, 2000

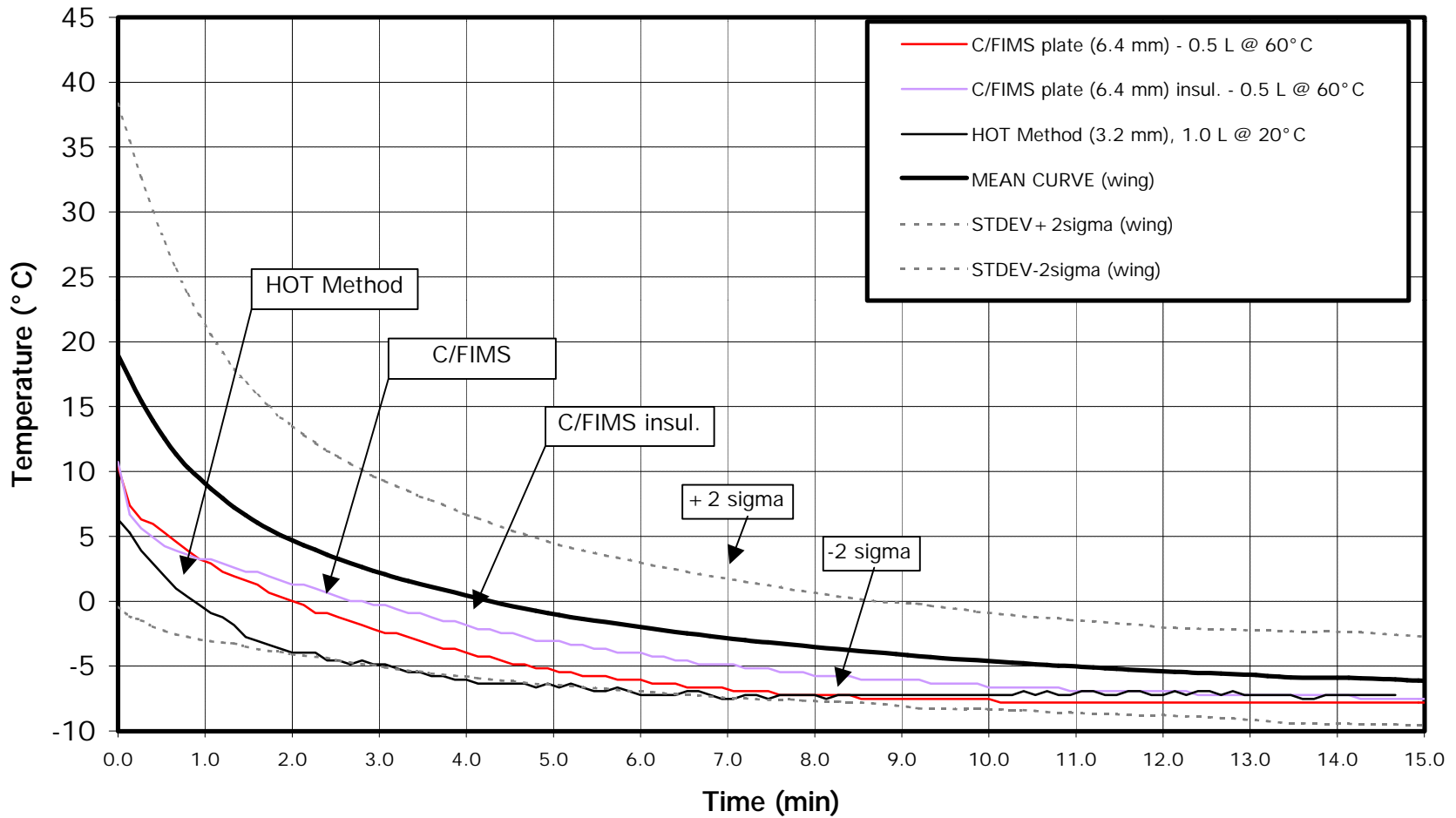

FIGURE 3.31

C/FIMS Plate Surface Temperature Profiles vs. Wing Leading Edge

APS Test Site, Test 2, SAE Type I Fluid: 1.0 L @ Freeze Point -15°C ,
Wind Speed 20-25 km/h, OAT -8°C , Adjusted to OAT -9°C , December 7, 2000

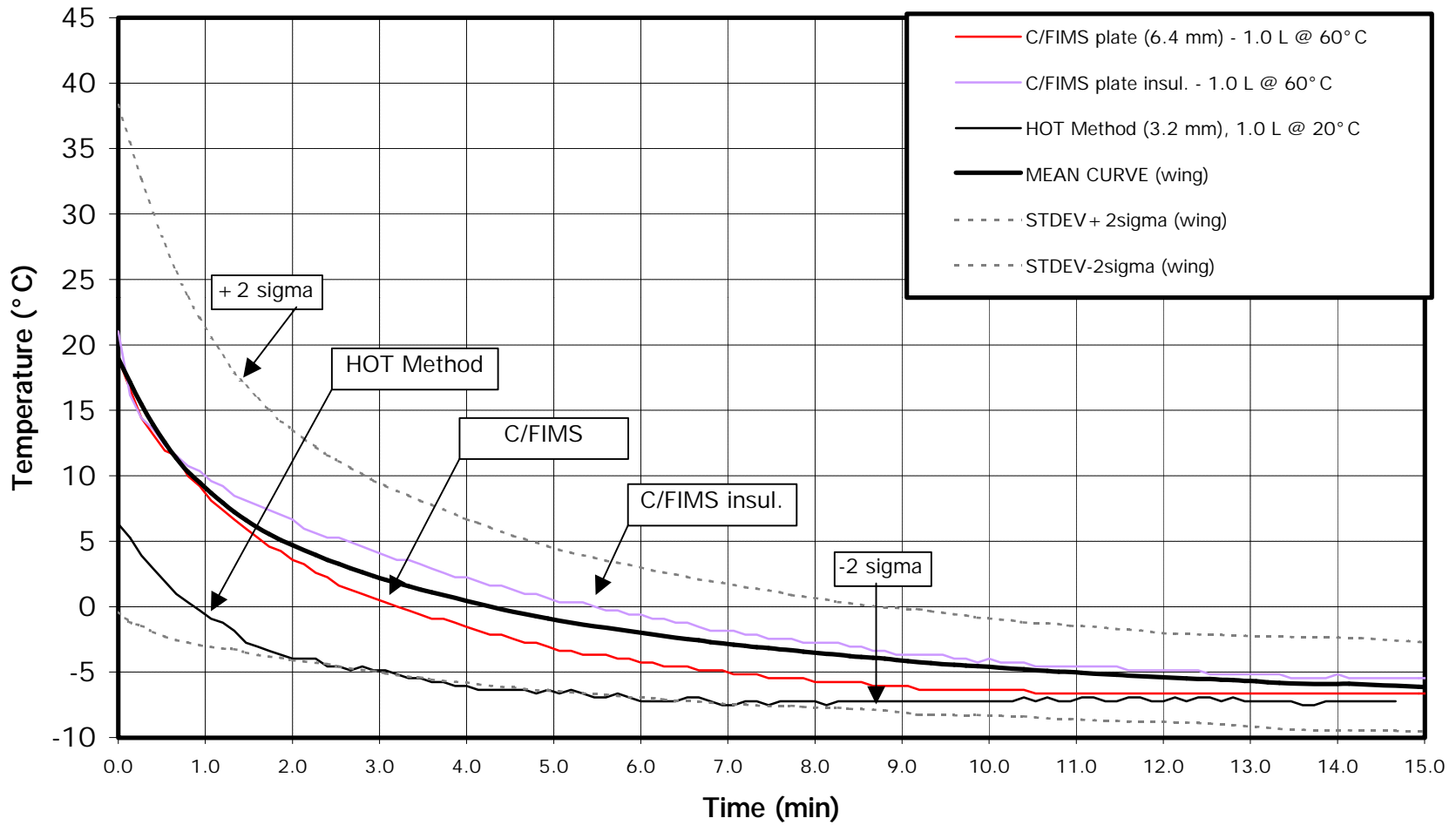

FIGURE 3.32

9.6 mm Plate Surface Temperature Profiles vs. Wing Leading Edge

APS Test Site, Test 1, SAE Type I Fluid: 0.5 L @ Freeze Point -15°C, Wind Speed 20-43 km/h,
OAT -8°C, Adjusted to OAT -9°C, December 7, 2000

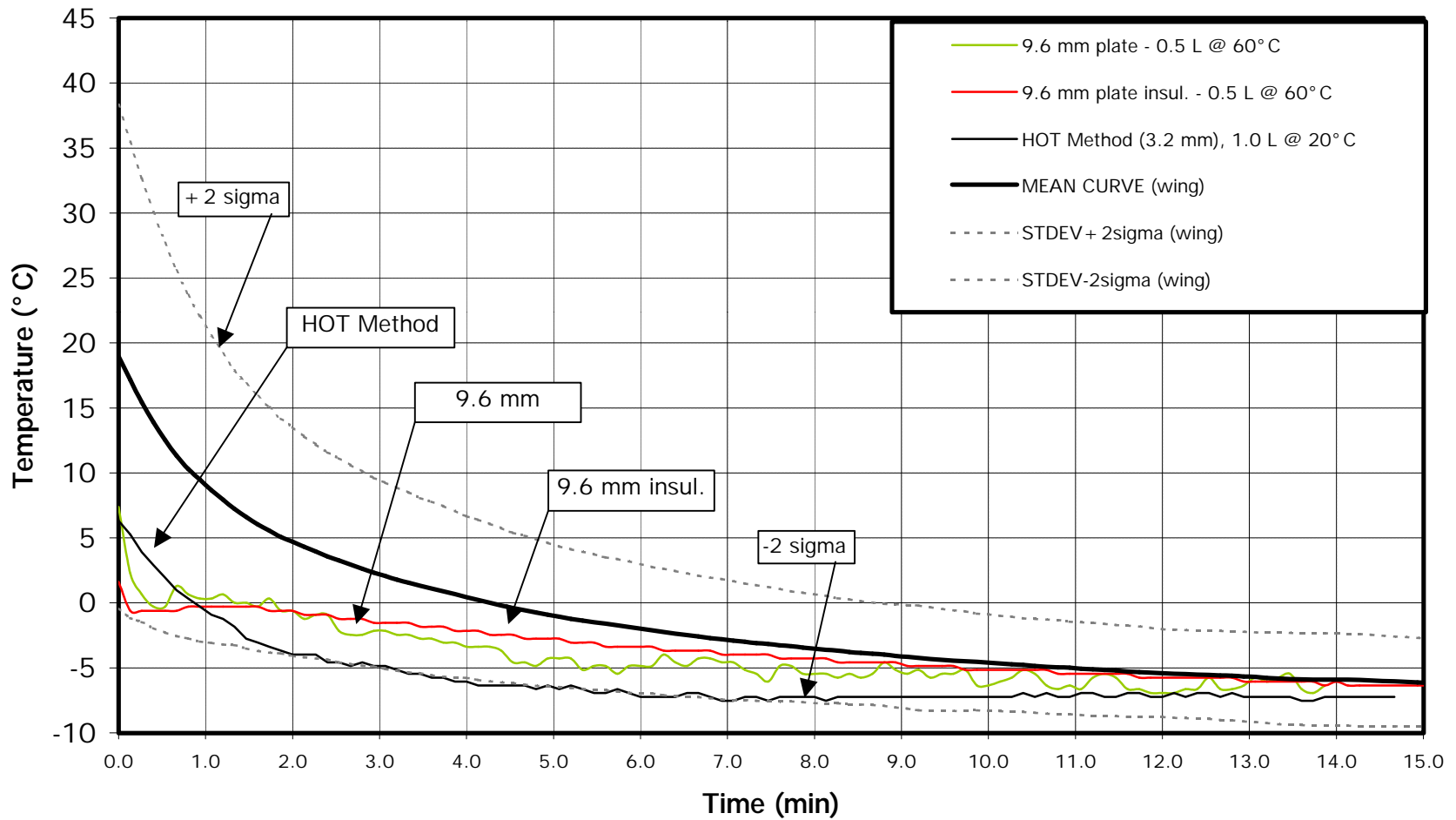

FIGURE 3.33

9.6 mm Plate Surface Temperature Profiles vs. Wing Leading Edge

APS Test Site, Test 1, SAE Type I Fluid: 1.0 L @ Freeze Point -15°C , Wind Speed 20-25 km/h,
OAT -8°C , Adjusted to OAT -9°C , December 7, 2000

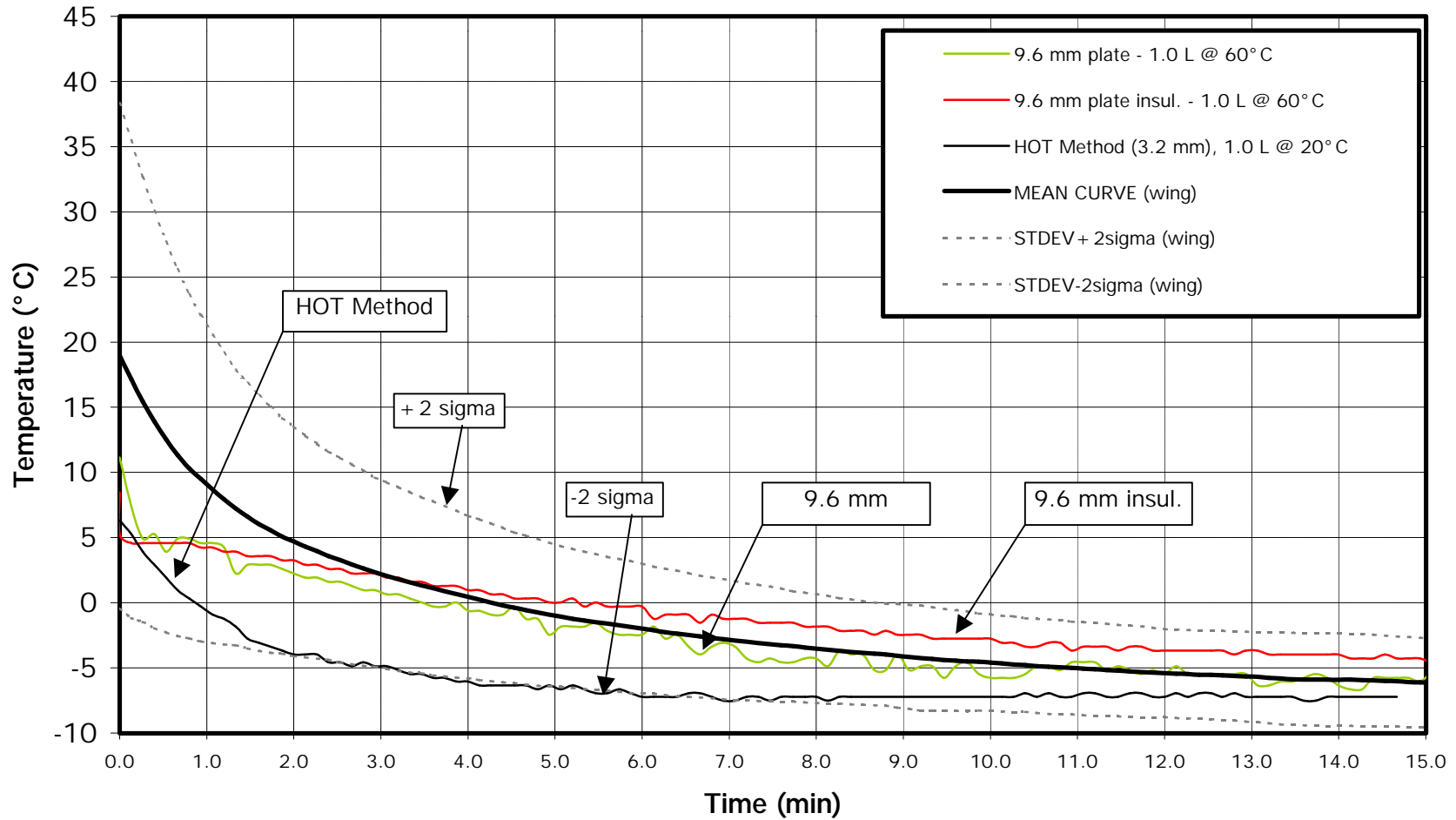

FIGURE 3.34

Effect of Wind on Standard 7.5 cm Box at 0.5 L Applied

7.5 cm Cold-Soak Box, Empty, Std. Surface (3.2 mm), APS Test Site, Dorval Airport, March 1, 2001
Type I Fluid @ 60°C, FFP @ 10°C Buffer, OAT -13°C, Adjusted to OAT -9°C

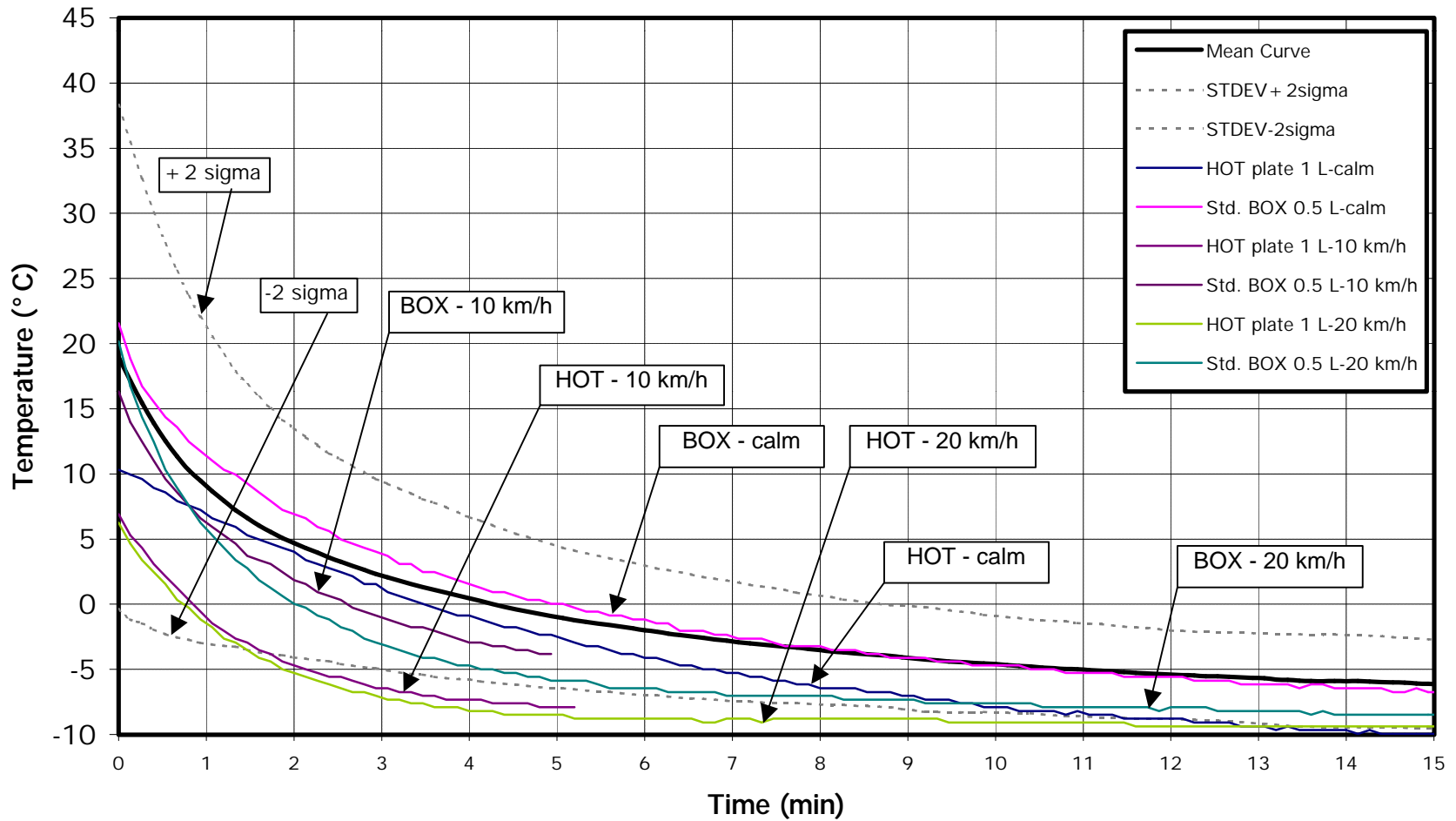

FIGURE 3.35

Effect of Wind on Standard 7.5 cm Box at 1 L Applied

7.5 cm Cold-Soak Box, Empty, Std. Surface (3.2 mm), APS Test Site, Dorval Airport, March 1, 2001
Type I Fluid @ 60°C, FFP @ 10°C Buffer, OAT -13°C, Adjusted to OAT -9°C

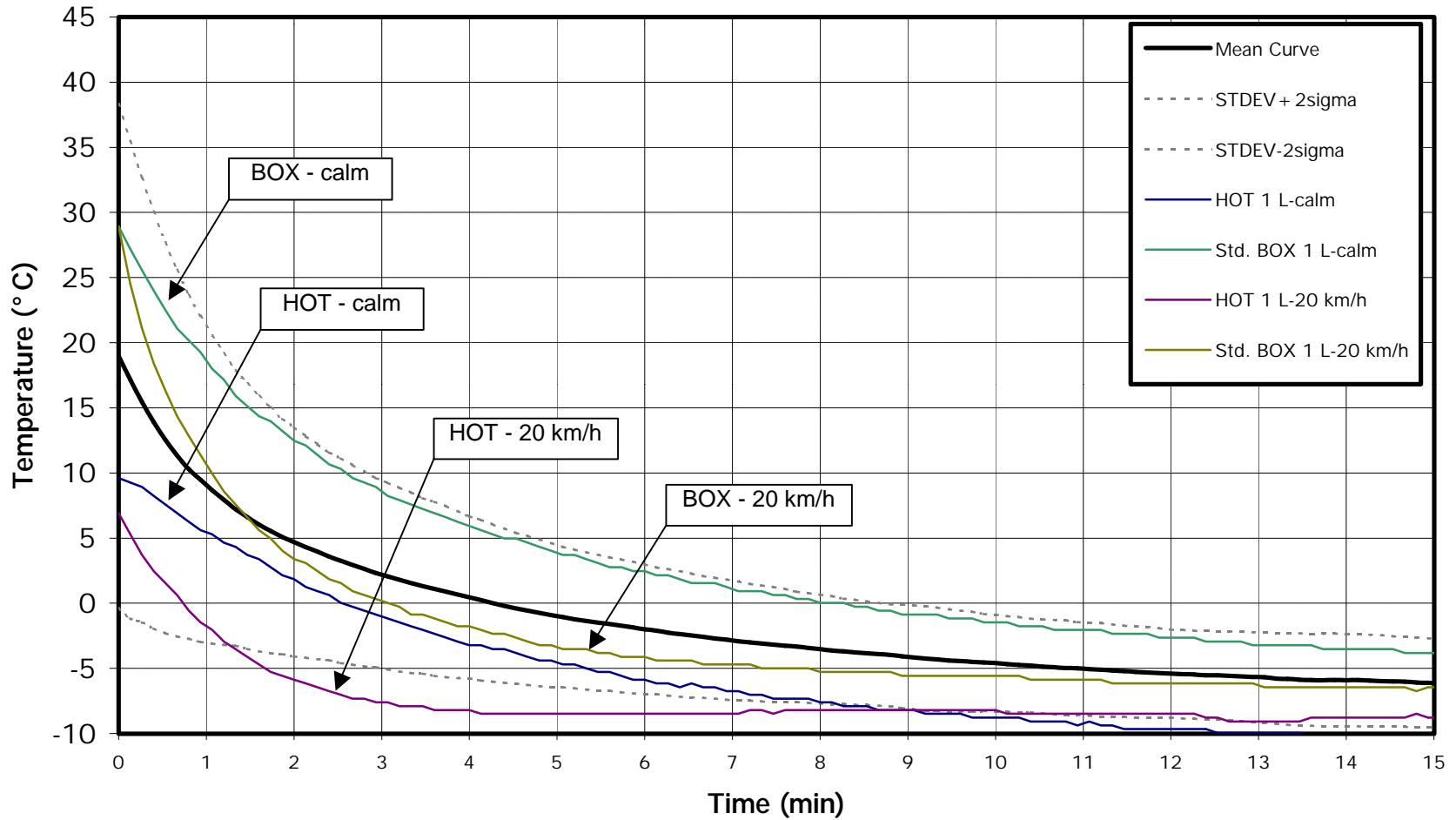

FIGURE 3.36

Effect of Wind on Box with 4.8 mm Surface at 0.5 L Applied

7.5 cm Cold-Soak Box, Empty, Surface 4.8 mm thick, APS Test Site, Dorval Airport, March 1, 2001
Type I Fluid @ 60°C, FFP @ 10°C Buffer, OAT -13°C, Adjusted to OAT -9°C

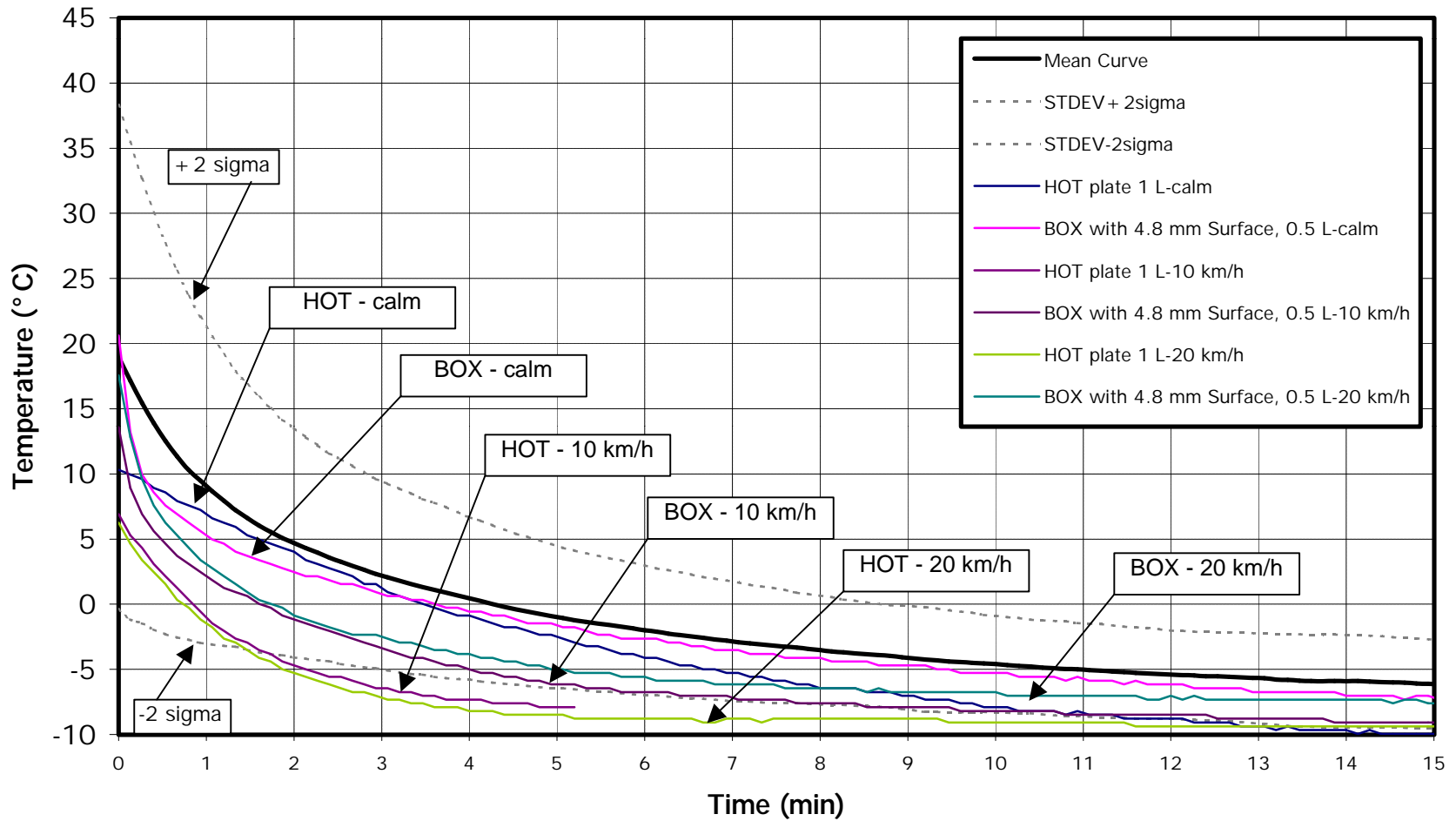

FIGURE 3.37

Effect of Wind on Box with 4.8 mm Surface at 1 L Applied

7.5 cm Cold-Soak Box, Empty, Surface 4.8 mm thick, APS Test Site, Dorval Airport, March 1, 2001

Type I Fluid @ 60°C, FFP @ 10°C Buffer, OAT -13°C, Adjusted to OAT -9°C

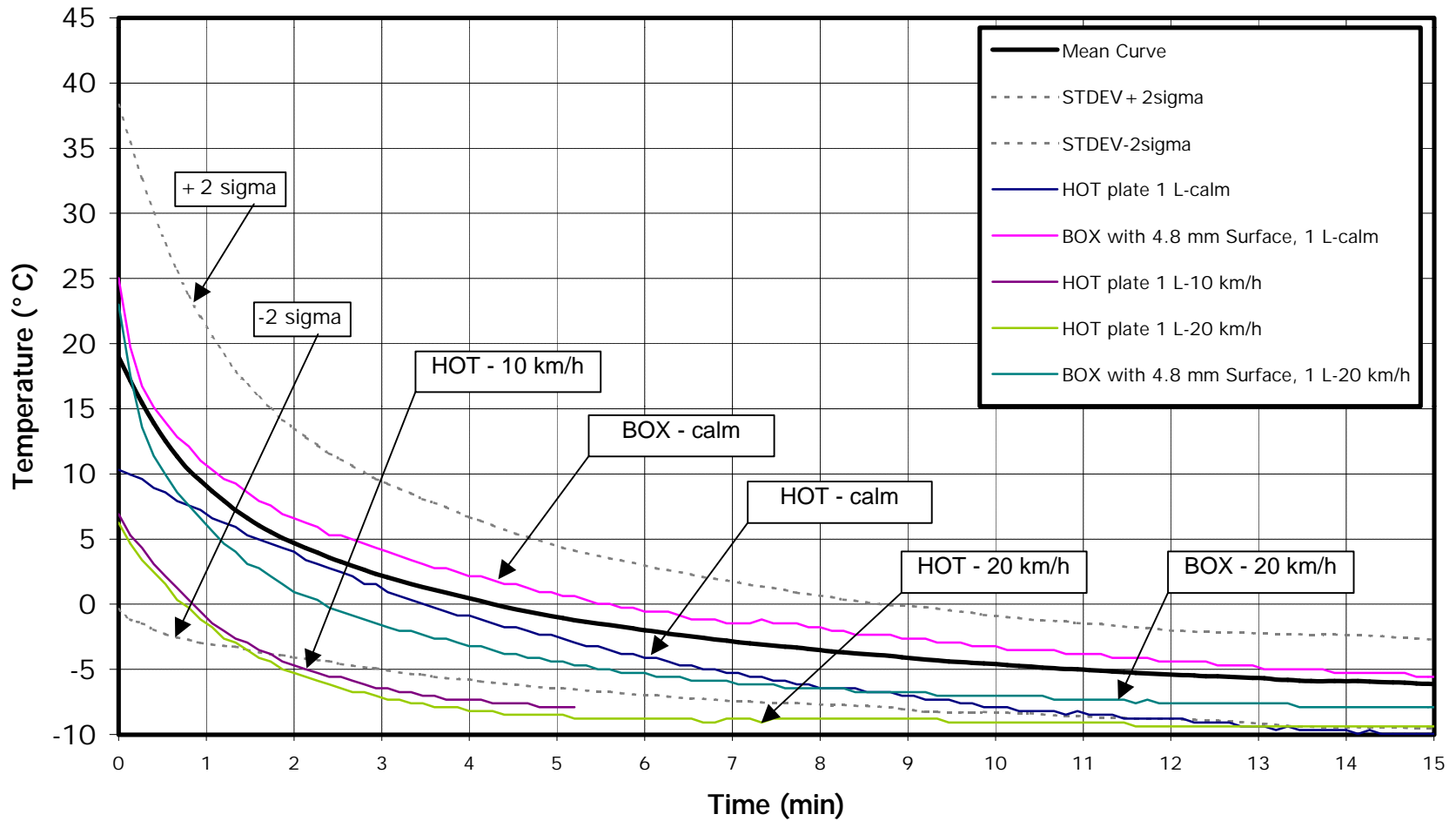

FIGURE 3.38

Effect of Wind on Box with 6.4 mm Surface at 0.5 L Applied

7.5 cm Cold-Soak Box, Empty, Surface 6.4 mm thick, APS Test Site, Dorval Airport, March 1, 2001
Type I Fluid @ 60°C, FFP @ 10°C Buffer, OAT -13°C, Adjusted to OAT -9°C

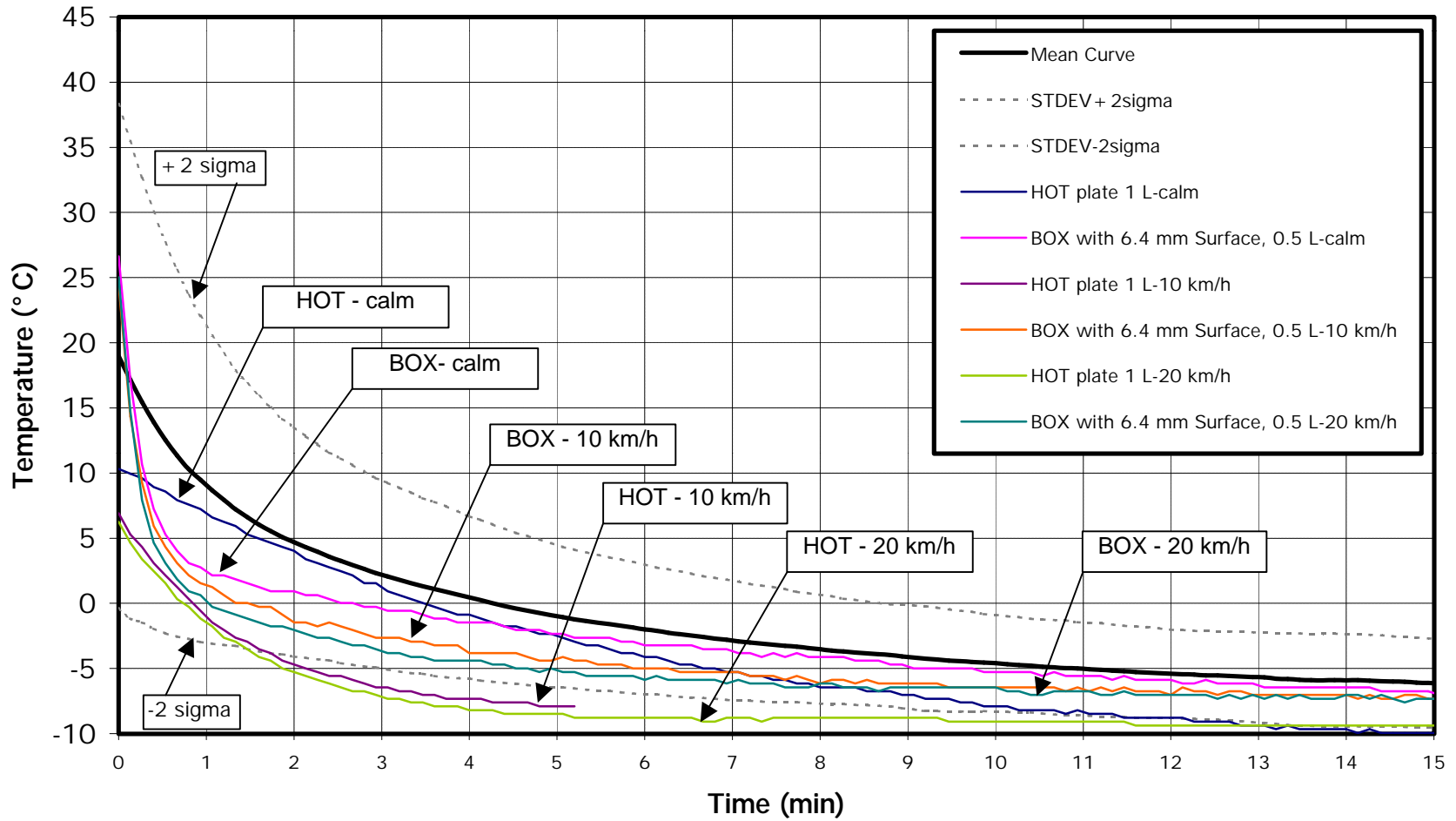

FIGURE 3.39

Effect of Wind on Box with 6.4 mm Surface at 1 L Applied

7.5 cm Cold-Soak Box, Empty, Surface 6.4 mm thick, APS Test Site, Dorval Airport, March 1, 2001
Type I Fluid @ 60°C, FFP @ 10°C Buffer, OAT -13°C, Adjusted to OAT -9°C

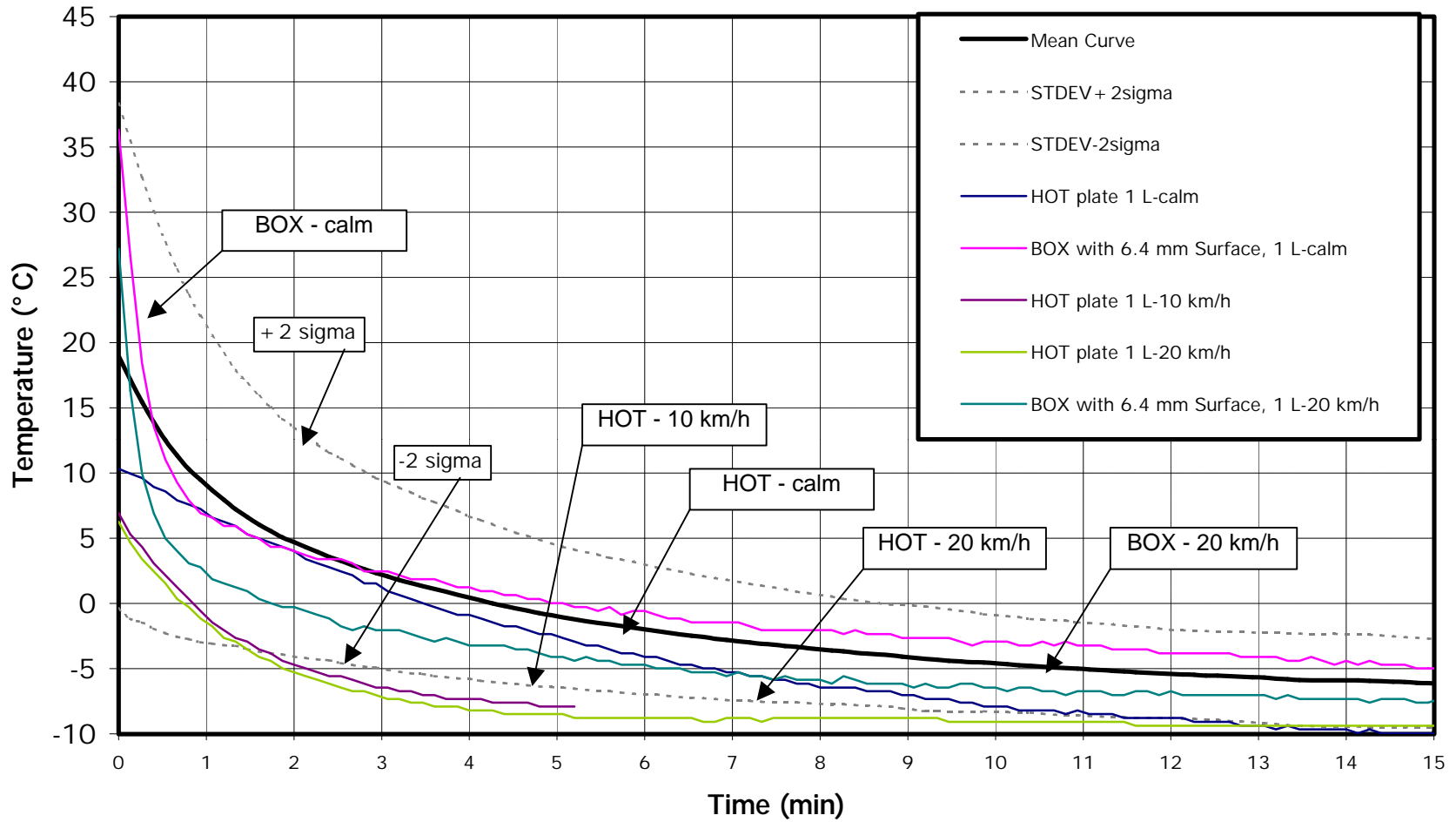

FIGURE 3.40

Effect of Simulated Fuel Load Surface Temperature Profiles

APS Test Site, Dorval Airport, March 1, 2001, Type I Fluid, 1 L @ 60°C, Spreader, OAT = -13°C

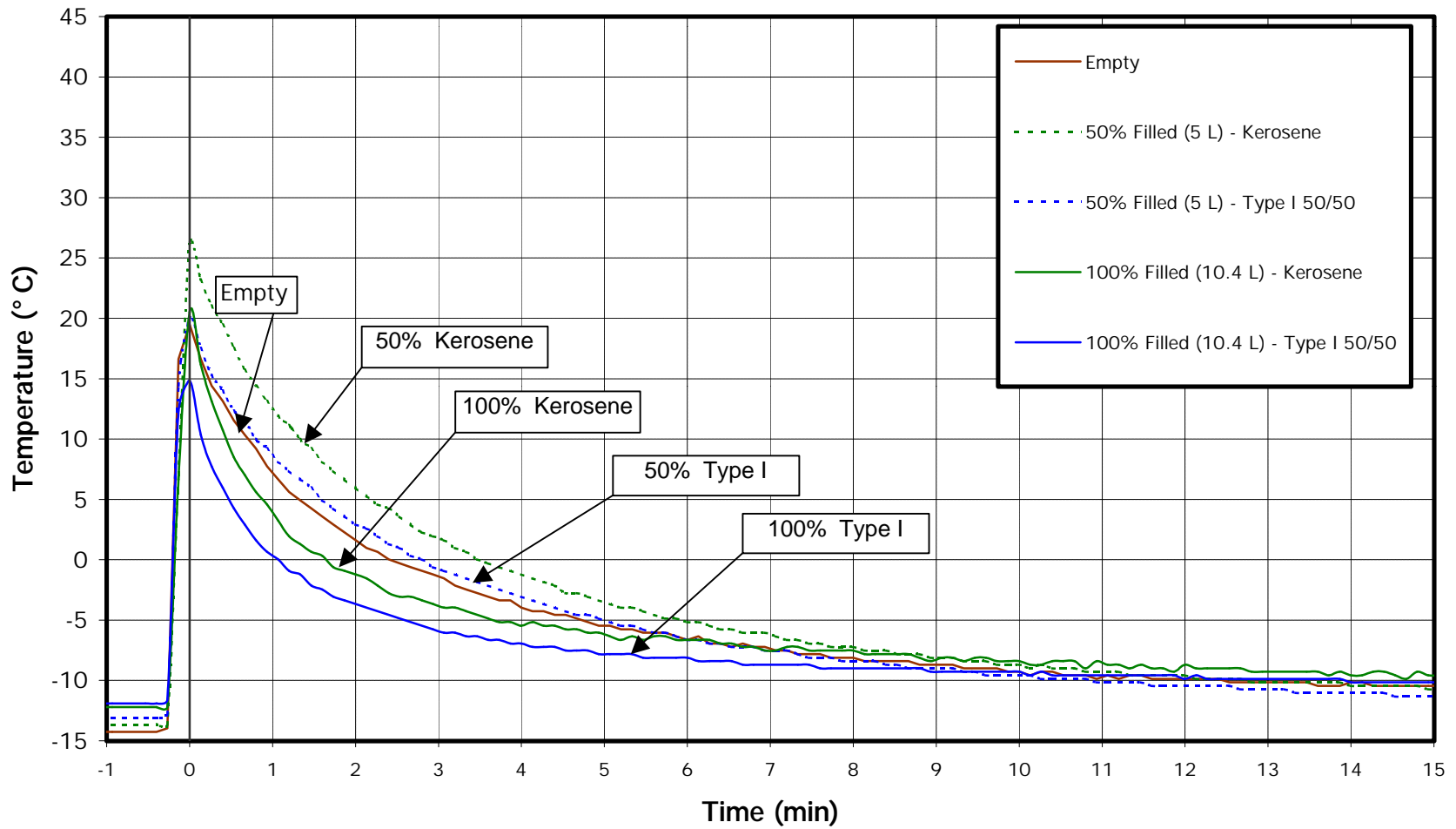

FIGURE 3.41

Effect of Rate of Fluid Application on Surface Temperature Profile

Type I Fluid at 10°C Buffer, Wind Calm, Dry, OAT -13°C, Adjusted at -9°C,
APS Test Site, Dorval Airport, March 1, 2001

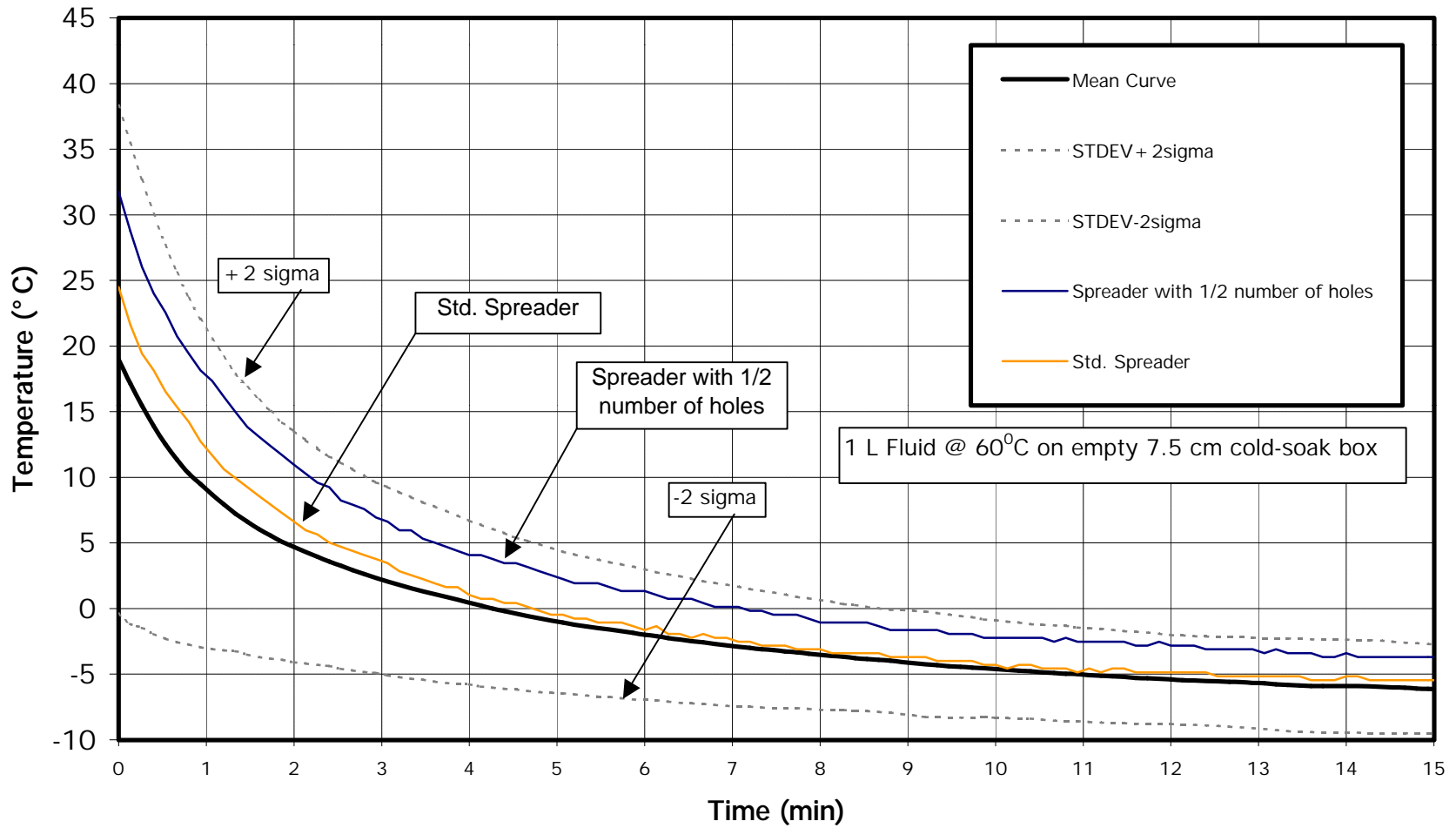

FIGURE 3.42
Effect of Rate Precipitation on Endurance Time – Data Points
 Type I Diluted (10°C Buffer), Natural Snow

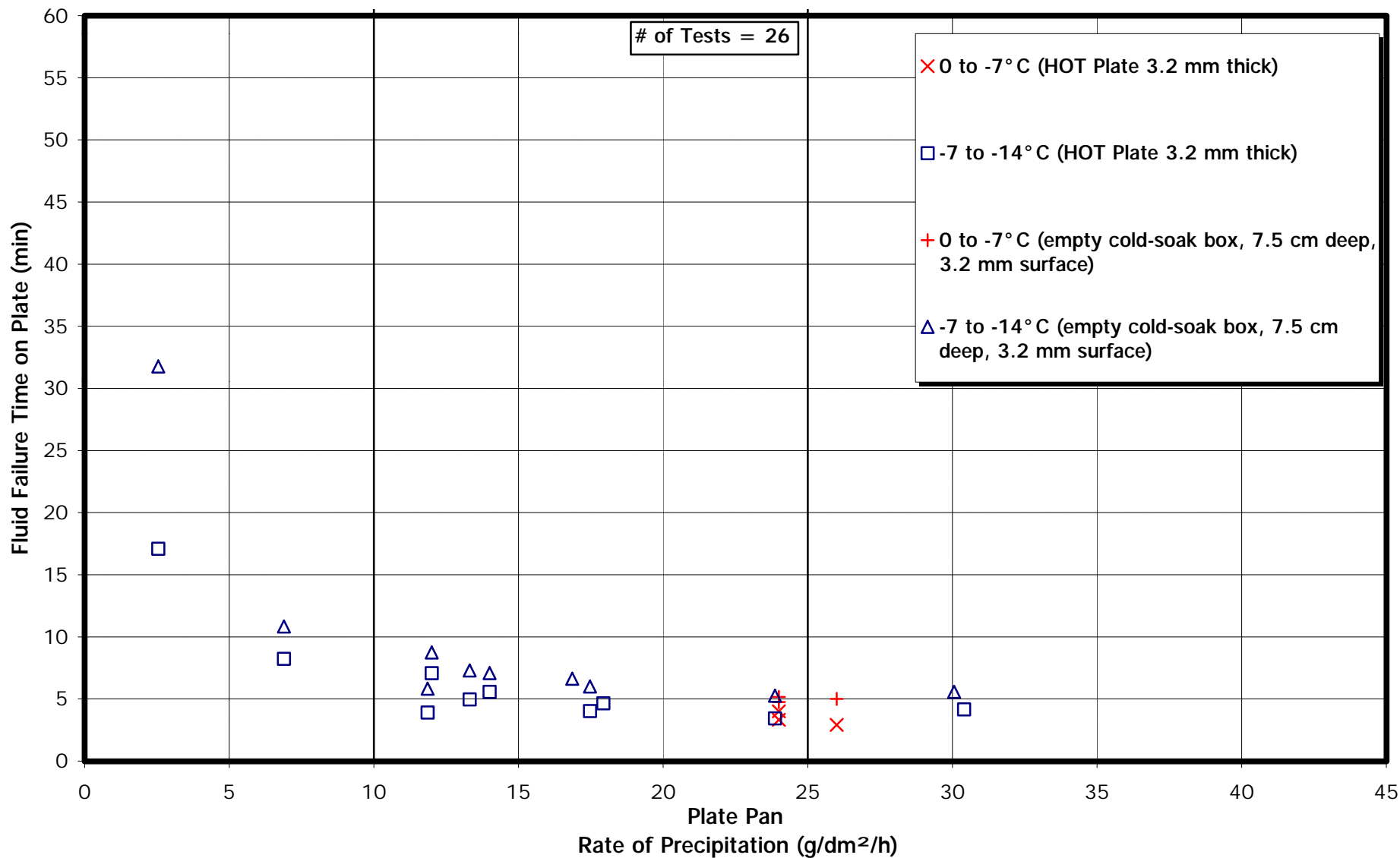

FIGURE 3.43
Effect of Rate of Precipitation on Endurance Time
 Type I Diluted (10°C Buffer), Natural Snow

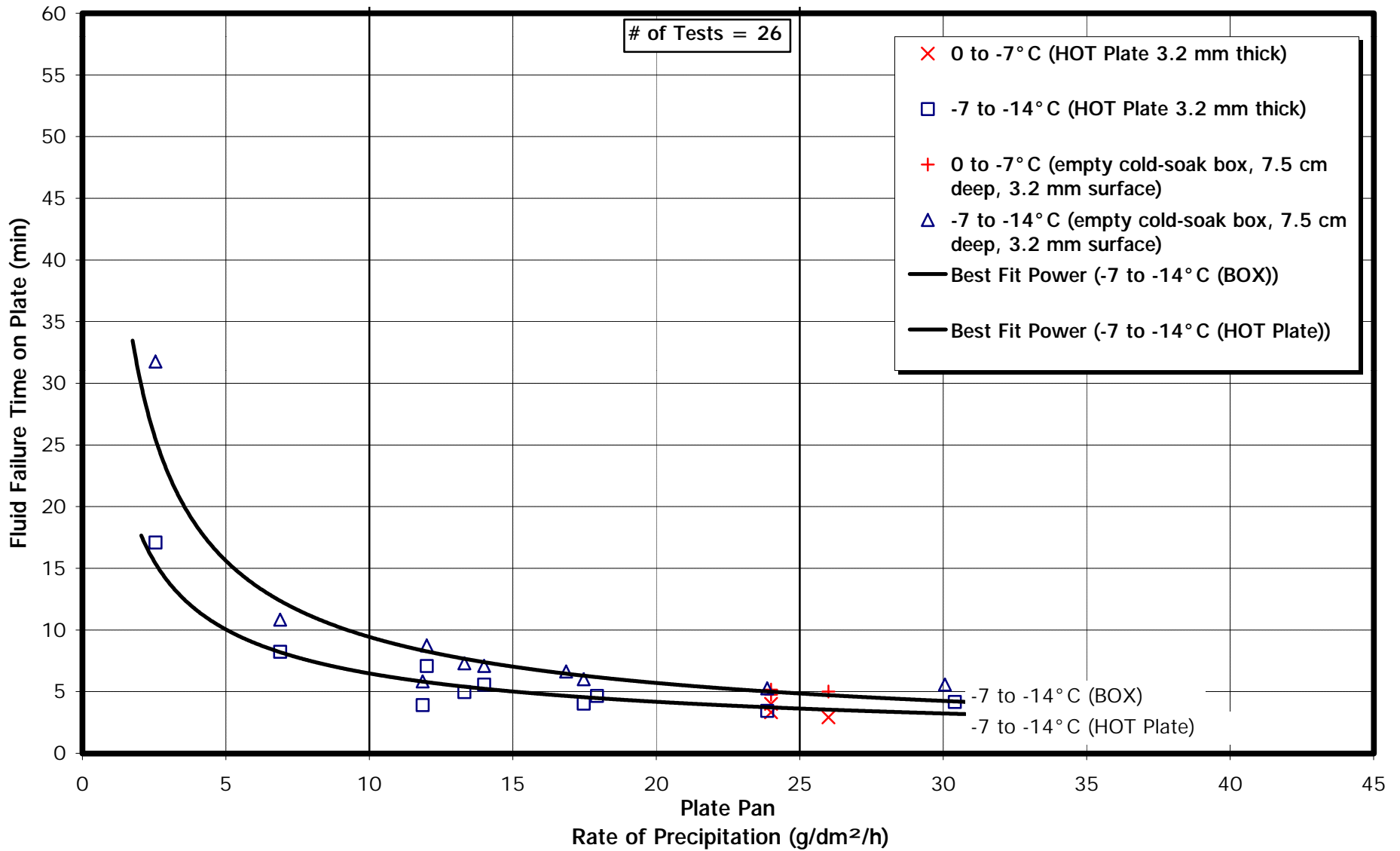

FIGURE 3.44

Comparison of Fluid Endurance – JetStar Test Wing vs. Test Surfaces – Set 1

National Research Council Canada Climatic Engineering Facility

March 13, 2001, Type I Fluid @ 10°C Buffer, Wind Calm, Artificial Snow @ 23 g/dm²/h, OAT -15°C

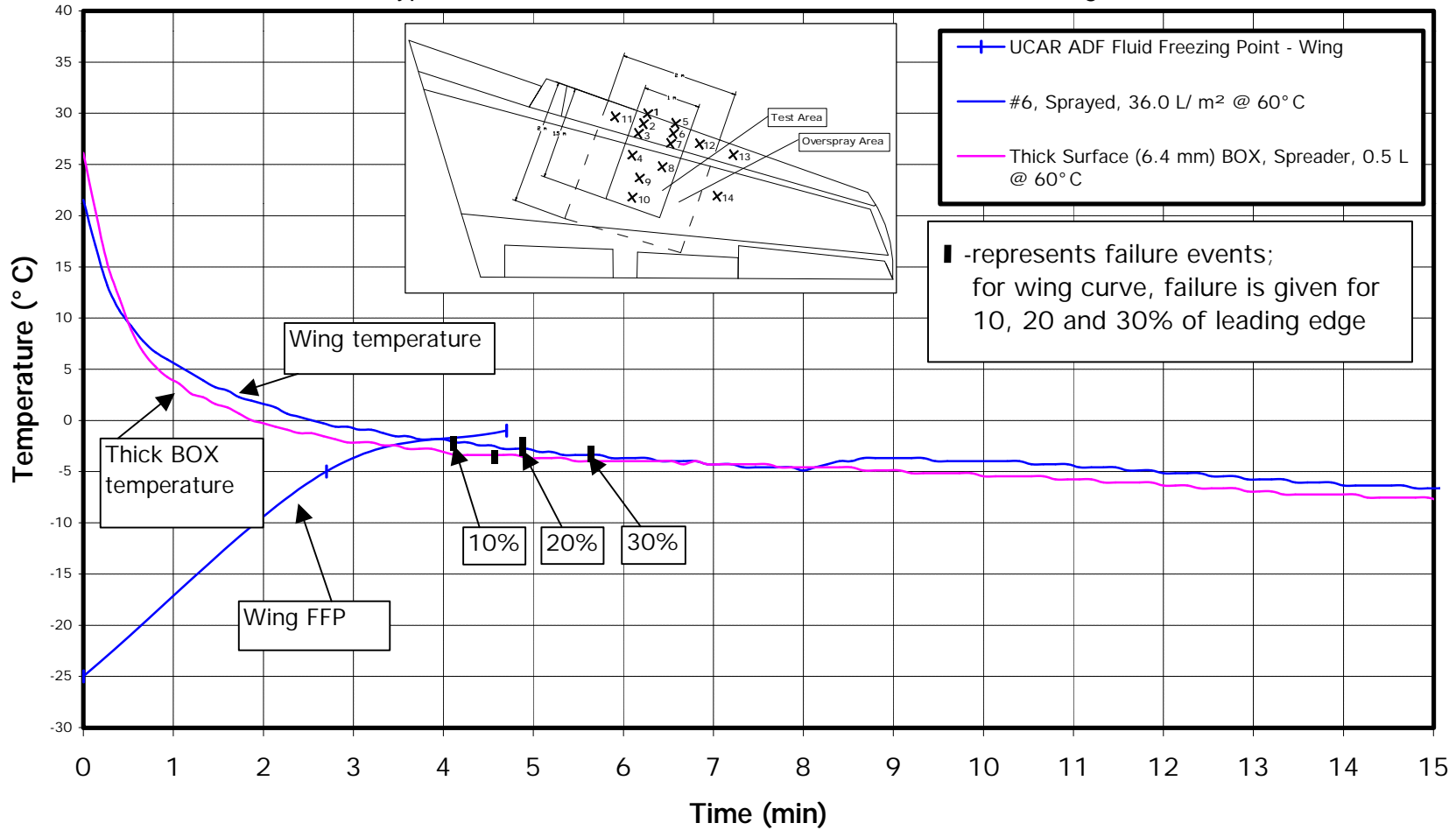

FIGURE 3.45

Comparison of Fluid Endurance – JetStar Test Wing vs. Test Surfaces – Set 2

National Research Council Canada Climatic Engineering Facility

March 13, 2001, Type I Fluid @ 10°C Buffer, Wind Calm, Artificial Snow @ 21 g/dm²/h, OAT -15°C

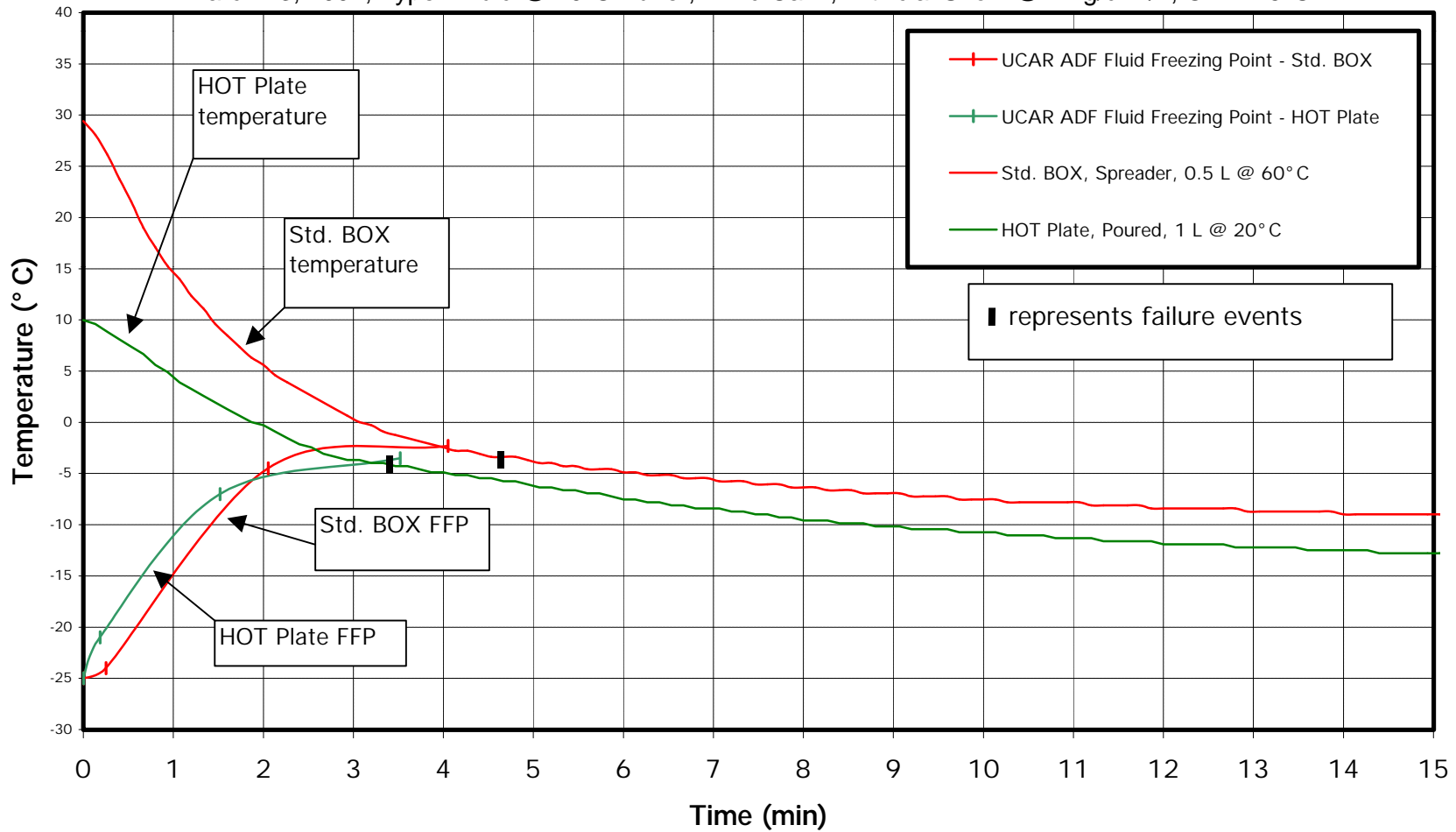

FIGURE 3.46

Comparison of Fluid Endurance – JetStar Test Wing vs. Test Surfaces – Set 3

National Research Council Canada Climatic Engineering Facility

March 13, 2001, Type I Fluid @ 10°C Buffer, Wind Calm, Artificial Snow @ 18 g/dm²/h, OAT -15°C

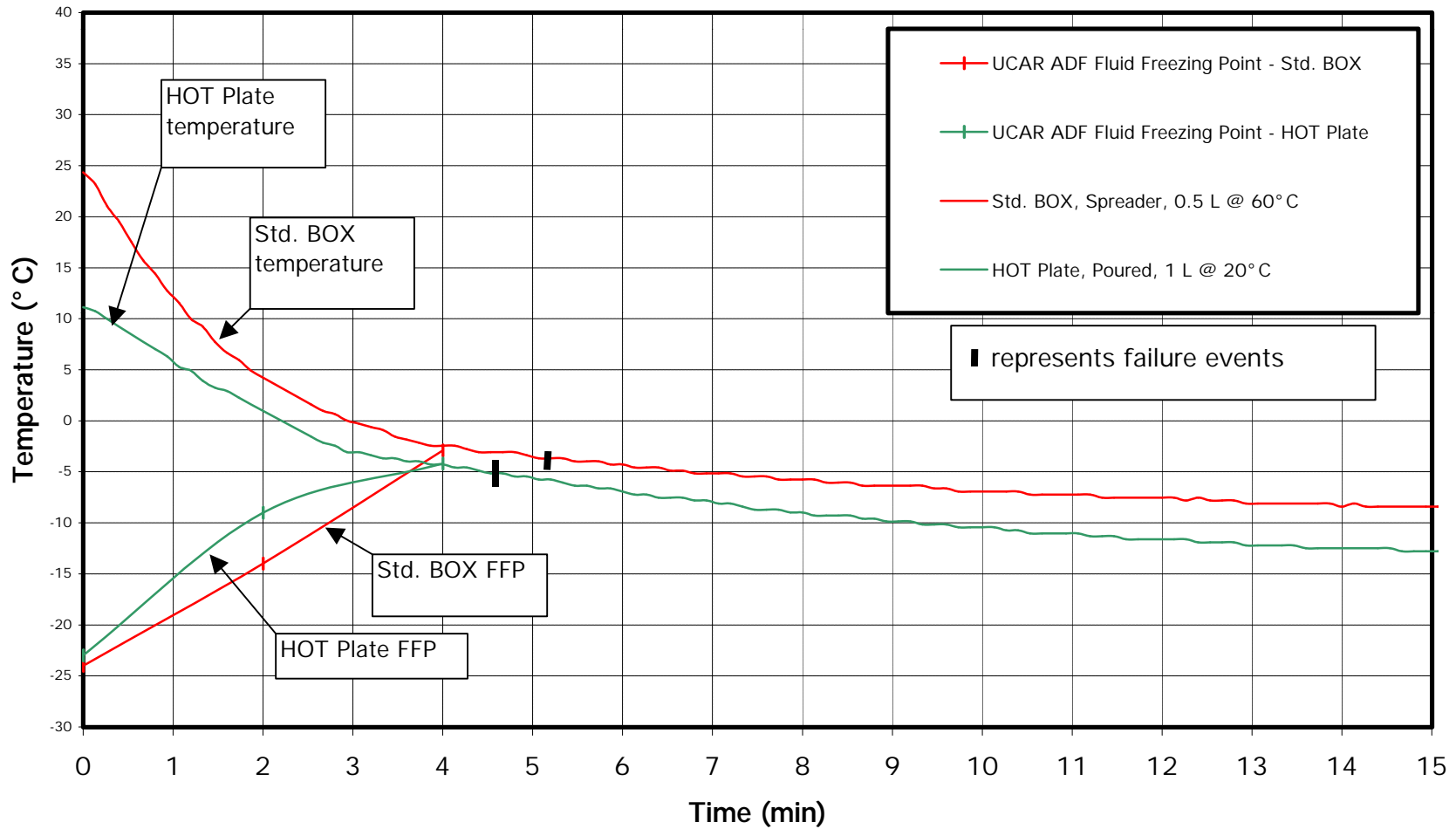

FIGURE 3.47

Comparison of Fluid Endurance – JetStar Test Wing vs. Test Surfaces – Set 5

National Research Council Canada Climatic Engineering Facility

March 13, 2001, Type I Fluid @ 10°C Buffer, Wind Calm, Artificial Snow @ 21 g/dm²/h on Test Surfaces, Artificial Snow @ 26 g/dm²/h on Wing, OAT -15°C

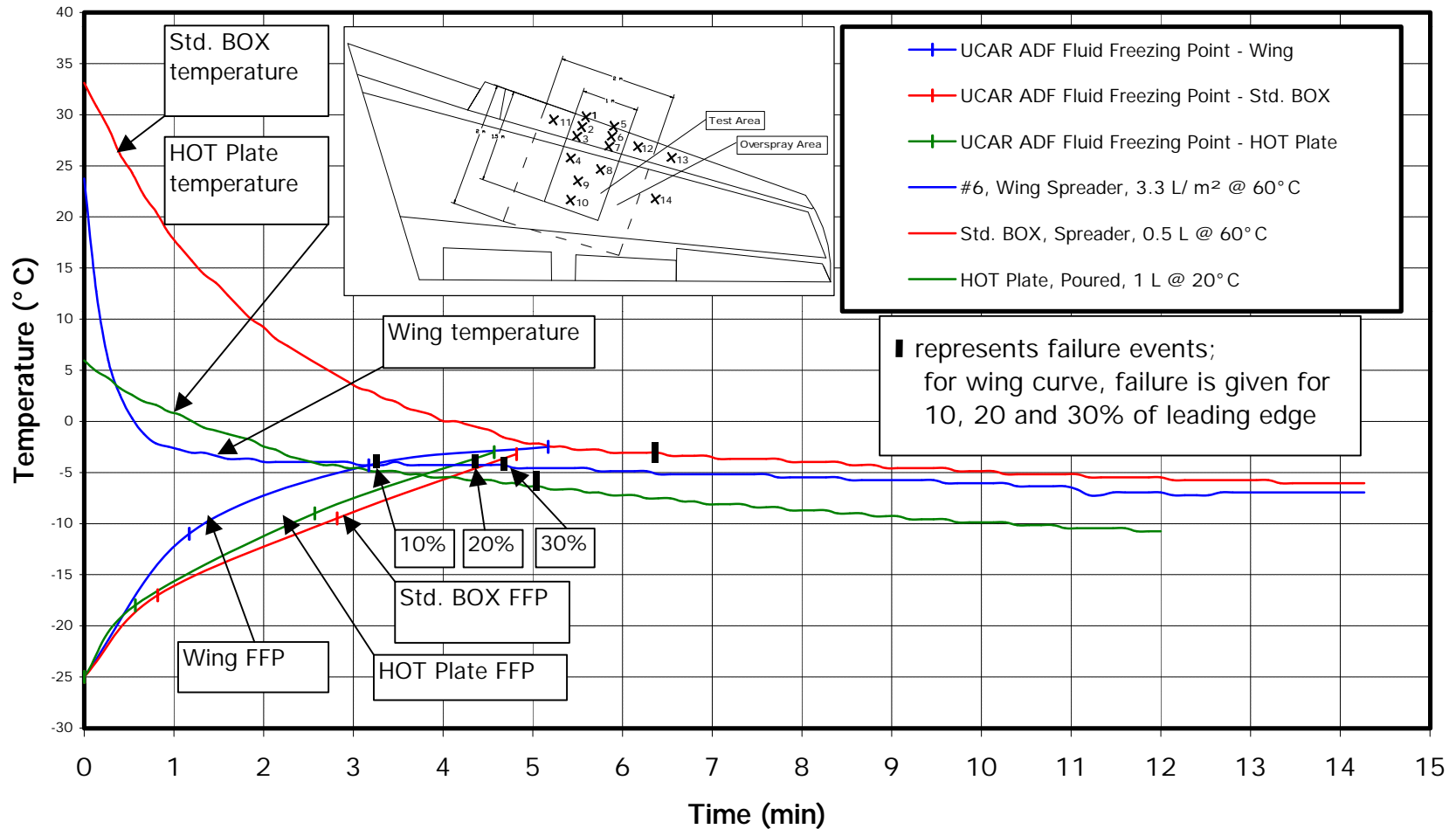

FIGURE 3.48

Comparison of Fluid Endurance – JetStar Test Wing vs. Test Surfaces – Set 6

National Research Council Canada Climatic Engineering Facility

March 14, 2001, Type I Fluid @ 10°C Buffer, Wind Calm, Artificial Snow @ 28 g/dm²/h, OAT -15°C

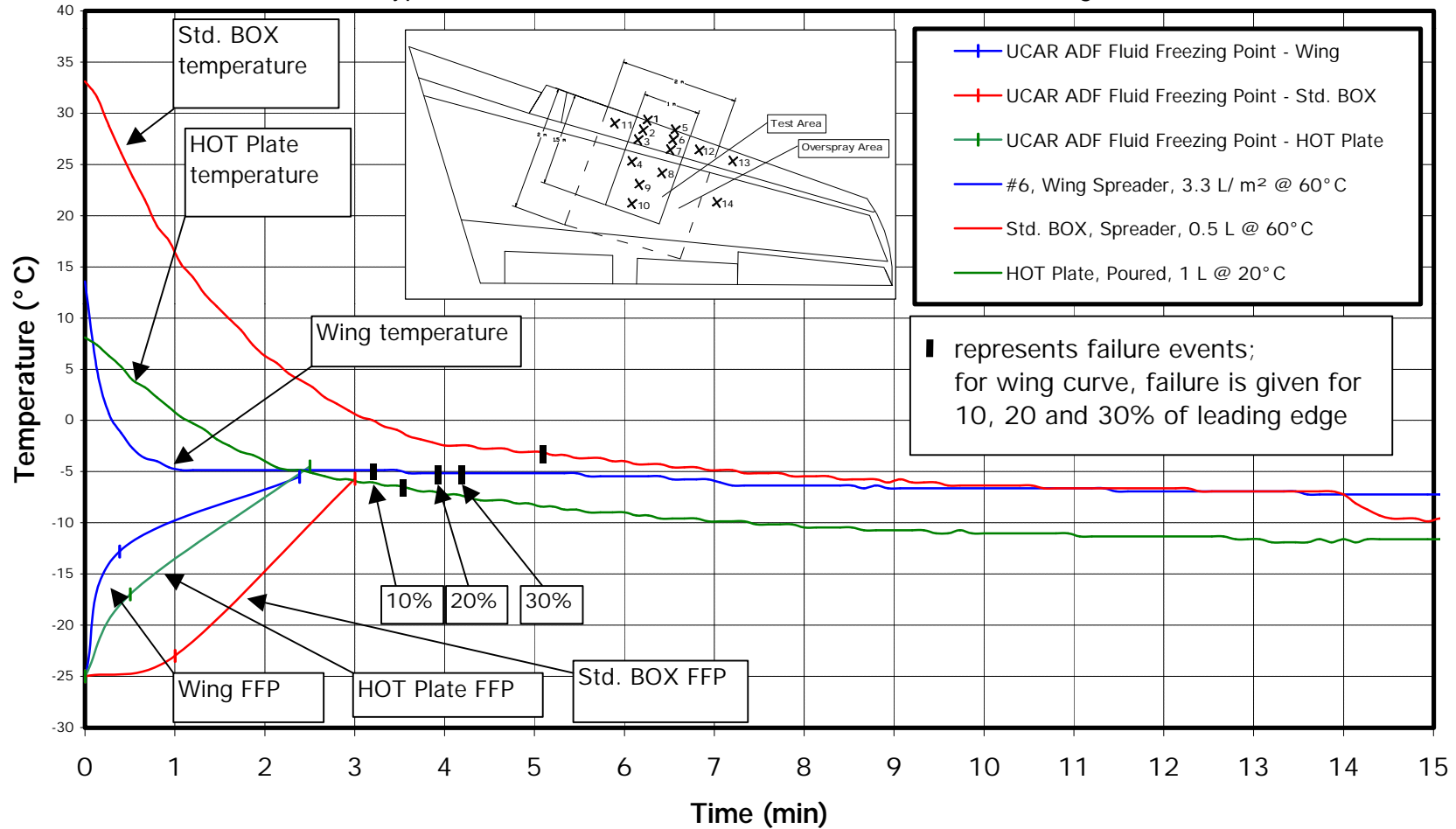

FIGURE 3.49

Comparison of Fluid Endurance – JetStar Test Wing vs. Test Surfaces – Set 7

National Research Council Canada Climatic Engineering Facility

March 14, 2001, Type I Fluid @ 10°C Buffer, Wind Calm, Freezing Rain @ 10 g/dm²/h, OAT -10°C

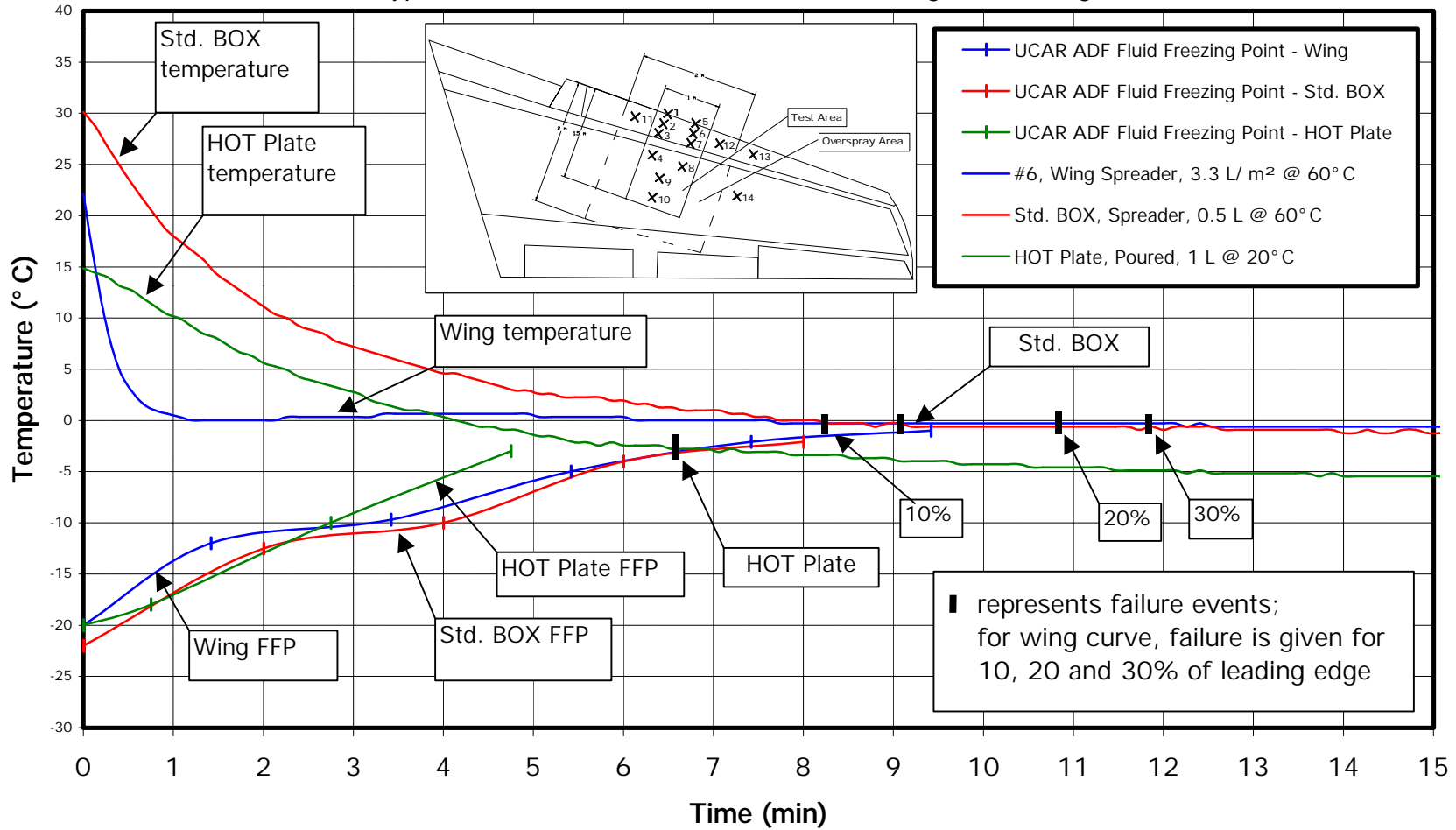

FIGURE 3.50

Comparison of Fluid Endurance – JetStar Test Wing vs. Test Surfaces – Set 8

National Research Council Canada Climatic Engineering Facility

March 14, 2001, Type I Fluid @ 10°C Buffer, Wind Calm, Freezing Rain @ 10 g/dm²/h, OAT -10°C

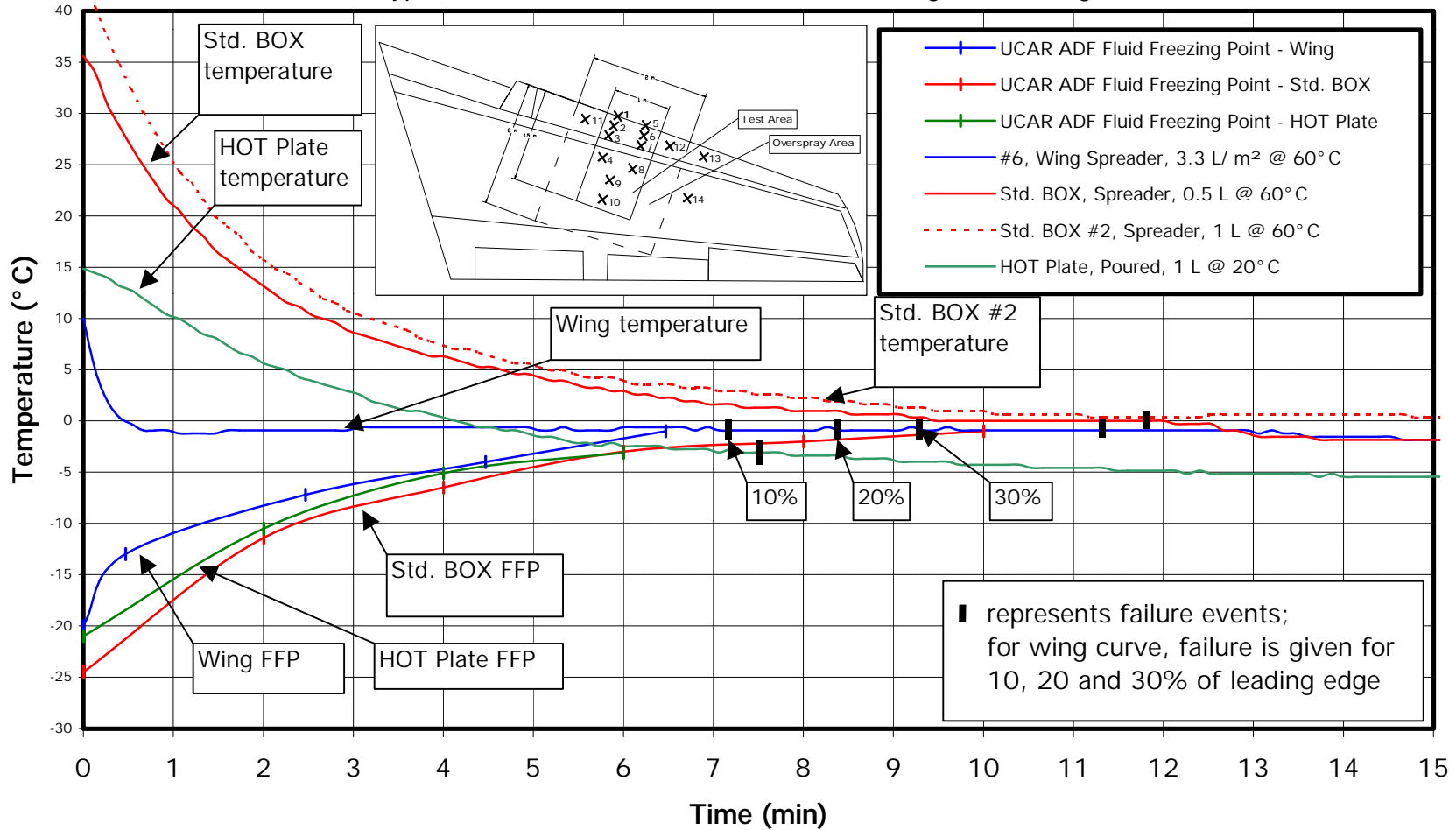

FIGURE 3.51

Comparison of Fluid Endurance – JetStar Test Wing vs. Test Surfaces – Set 9

National Research Council Canada Climatic Engineering Facility

March 15, 2001, Type I Fluid @ 10°C Buffer, Wind Calm, Freezing Rain @ 25 g/dm²/h on Test Surfaces, Freezing Rain @ 28 g/dm²/h on Wing, OAT -10°C

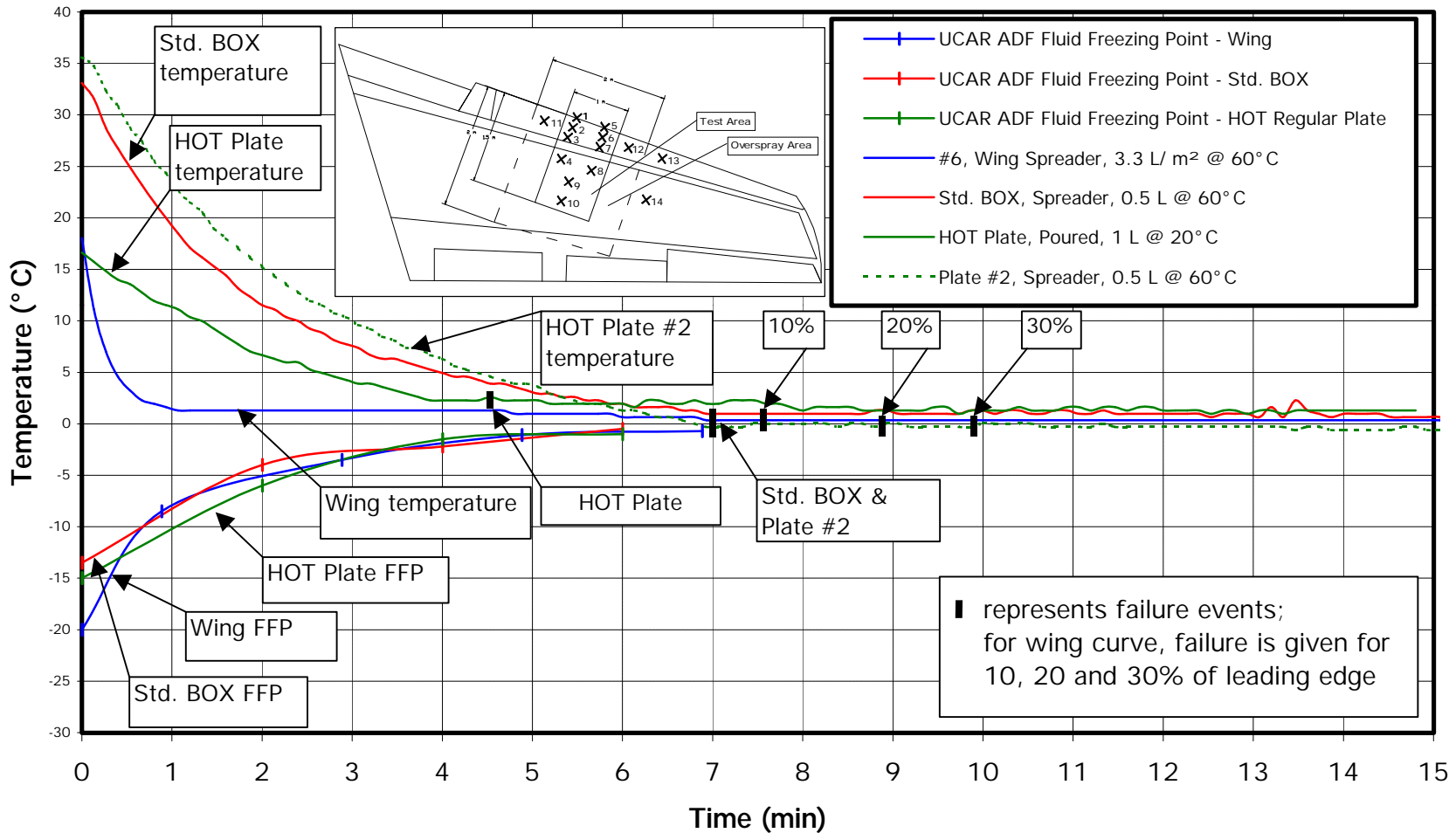

FIGURE 3.52

Comparison of Fluid Endurance – JetStar Test Wing vs. Test Surfaces – Set 10

National Research Council Canada Climatic Engineering Facility

March 15, 2001, Type I Fluid @ 10°C Buffer, Wind Calm, Freezing Rain @ 24 g/dm²/h on Test Surfaces, Freezing Rain @ 28 g/dm²/h on Wing, OAT -10°C

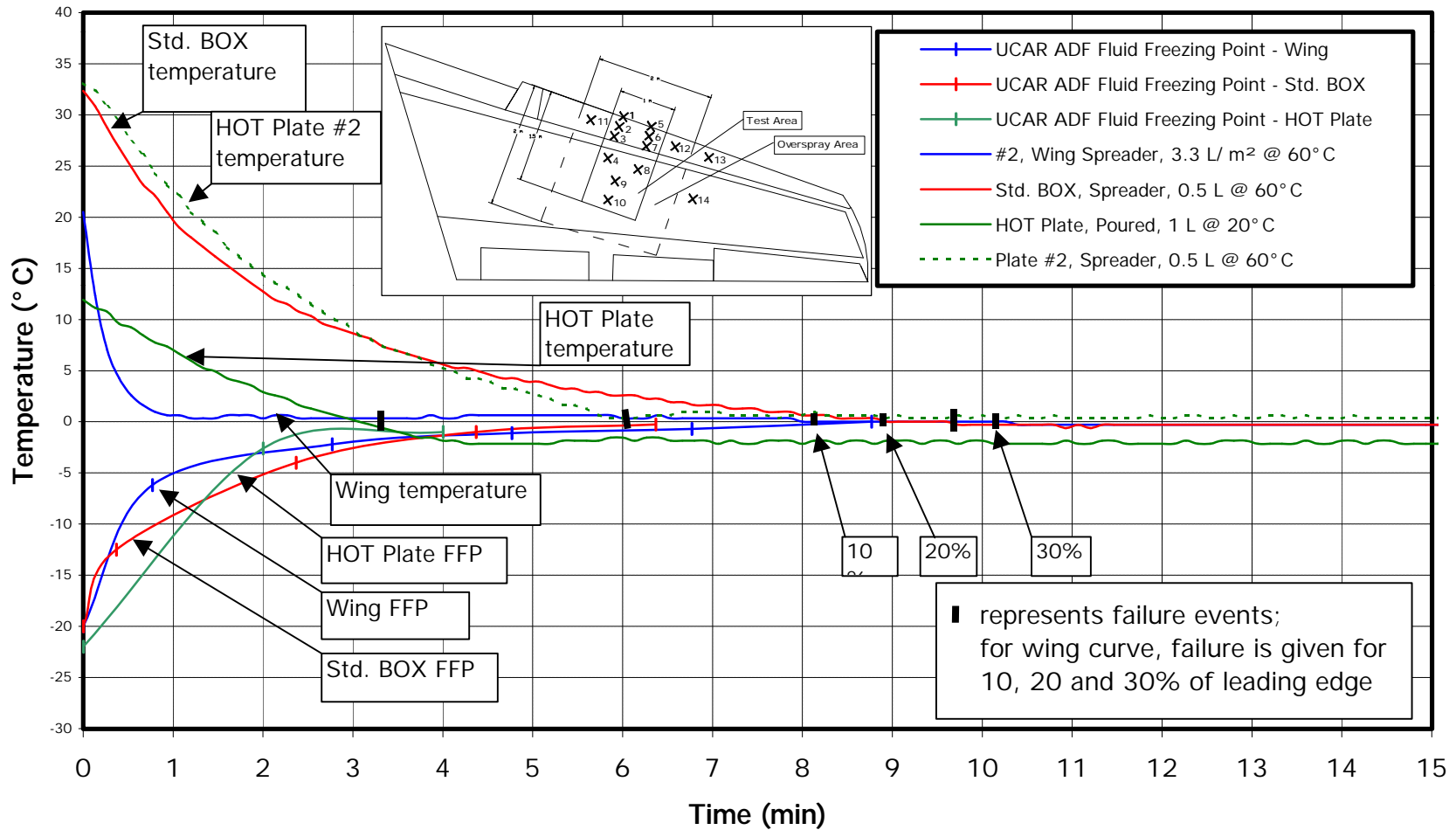
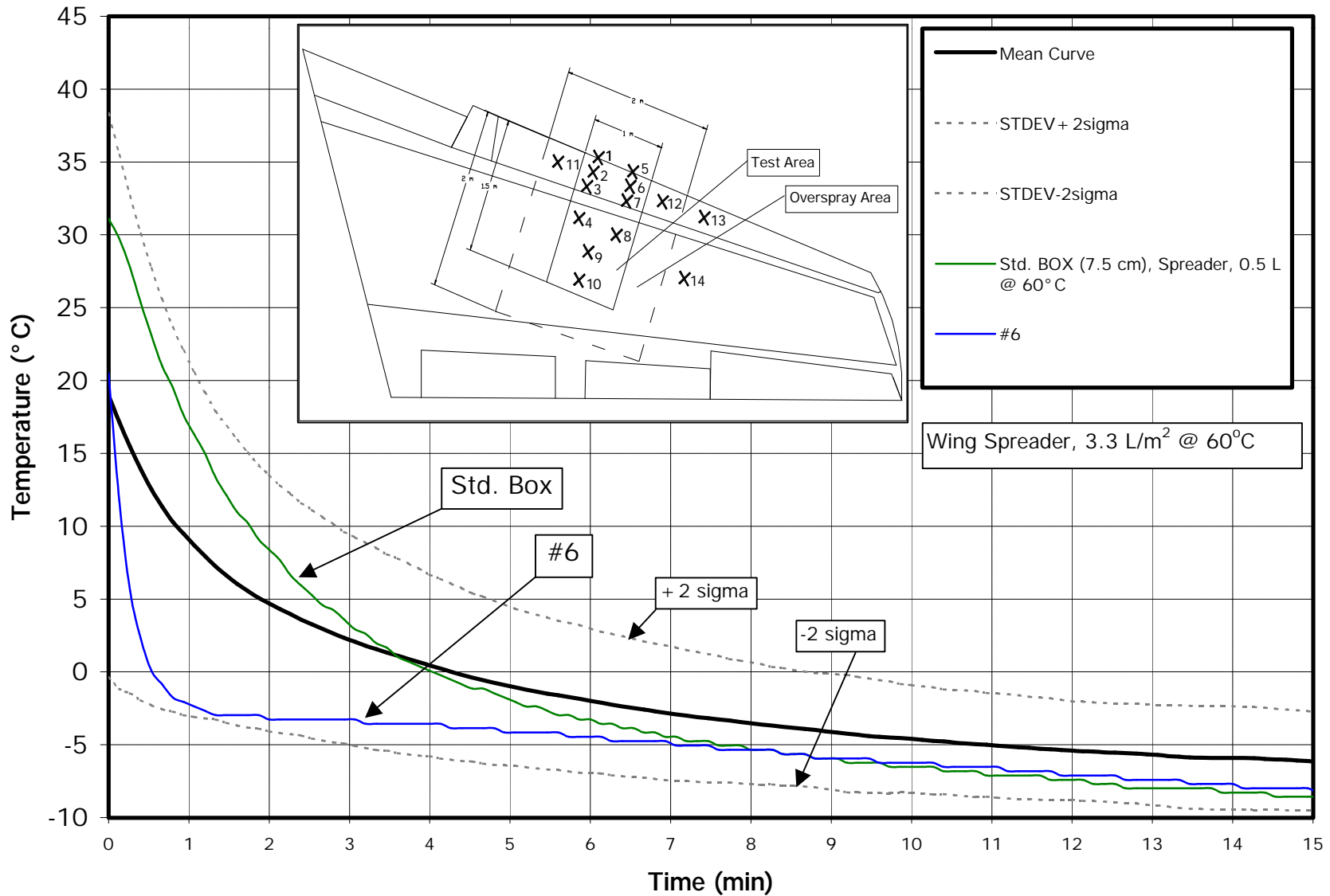

FIGURE 3.53

Plate/Box/Wing Surface Temperature Profiles – Runs 2 and 3

National Research Council Canada Climatic Engineering Facility

March 14, 2001 Type I Fluid @ 10°C Buffer, Wind Calm, Dry, OAT -15°C, Adjusted at -9°C



4 ANALYSIS AND OBSERVATIONS

In this chapter, data from previous and new tests is discussed.

4.1 Review of Related Test Data

4.1.1 Wing Leading Edge

A review of Figure 3.2 indicates the importance of the wing leading edge when considering fluid endurance times on actual wings. This chart demonstrates that the temperature decay rate of the wing leading edge is significantly faster than that of the main wing and similar to that of the control surfaces at the rear of the wing. Accepting that the wing surface temperature contributes to longer fluid endurance times, then the faster drop in temperature on the leading edge will lead to earlier fluid failures on that surface.

Selection of the wing leading edge as the critical area of interest for this study is supported by test data on the location of earliest fluid failure on actual wings (Figure 3.8).

4.1.2 Influence of Wind on Cooling Rate

Figure 3.3 illustrates the considerable influence of wind on the rate of cooling. These tests indicate that the time for the temperature to drop to 0°C was decreased by a factor of four in a wind of 26 km/h (as compared with calm conditions). In these tests, surface thickness also varied. Thicker plates reached an initially higher temperature than thinner plates and generated a longer interval for cooling to 0°C. Applying greater amounts of fluid extended the cooling times of the thicker plates, but little benefit was noted for the thin plates.

Figure 3.6 illustrates the effect of wind. Temperature decay profiles are given for calm, 10 km/h and 20 km/h, under freezing rain (25 g/dm²/hr), and at OAT -10°C. The curve, representing fluid freeze point, intersects with the surface temperature profile for surfaces exposed to high wind much earlier than the temperature profile for calm conditions. Fluid failure would be expected to occur at the time of intersection.

Testing for fluid endurance times can be conducted either in controlled laboratory conditions or outdoors in natural weather conditions. When conducted outdoors, the test equipment is exposed to variable weather conditions (OAT, wind, type of snow, etc.) similar to the actual aircraft experience in deicing situations. Thus, the influence that wind exerts on

the cooling rate of the test surface is inherently accounted for in tests conducted outdoors.

In laboratory tests however, wind would greatly interfere with generation of accurate rates of precipitation on test surfaces; consequently, the important condition of wind is missing. To compensate, the laboratory test procedure (in calm conditions) must produce fluid endurance times corresponding to times produced on wing surfaces in variable wind conditions. When examining candidate test surfaces in this study, this equivalency was ascertained by comparing temperature profiles of surfaces in calm conditions with the generic aircraft curves (which represent various wind conditions).

As a result, two test procedures are needed, one for outdoor testing, where natural winds are experienced, and another for laboratory tests in calm conditions.

4.1.3 Heated Fluid Versus Unheated Fluid

The importance of applying heated fluid rather than fluid at ambient temperature can be inferred from Figure 3.6. Had fluid at -10°C (OAT) been applied, freezing would have occurred after two minutes. For the particular surface under test, the elapsed time until freezing is more than doubled with the application of heated fluid (in calm conditions).

The speed with which the fluid strength diminishes, expressed as a rise in FFP, is worthy of note (here under freezing rain at $25\text{ g/dm}^2/\text{h}$). After 5 to 6 minutes, the concentration of glycol in the fluid has fallen to virtually zero.

4.1.4 Quantity of Fluid Applied

The quantity of applied fluid is examined in Figure 3.7. In these trials, the quantity of fluid applied using a fluid spreader was varied. Because the spreader feeds at a fixed rate, increasing the quantity is actually expressed as an increased duration that the fluid is in contact with the surface. The beneficial effect of extending the duration of fluid contact with the surface is significant and should be considered in developing a test protocol.

4.2 Wing Leading Edge Temperature Profiles

4.2.1 Generic Wing Leading Edge Temperature Profile

The generic temperature profile presented in Figure 3.11 is the calculated mean curve of several tests. The variance between the various aircraft test decay rate curves is represented in this figure by sets of parallel curves at ± 1 and ± 2 standard deviations. This chart of mean plus standard deviation curves is important, because it provides a benchmark for evaluating whether prospective test surfaces are true representations of a wing. It is included as a background reference in many figures that show temperature profiles.

Each temperature profile used to construct the generic profile was based on tests where the wing was not in a *cold-soaked fuel* condition combined with high fuel loads typical of a *tankered-fuel* turn-around. In all cases, the aircraft tested were over-nighting aircraft, and the tests were initiated typically two hours after the aircraft arrived. Fuel loads were typical of arriving aircraft, which require additional fuel to be boarded before morning departure.

4.2.2 JetStar Test Wing Temperature Profile

As well as adding one further aircraft type to the family of wing temperature profiles, tests on the JetStar wing provided useful information about its use as a wing test-bed.

The shape of the temperature decay rate profile for the wing leading edge showed that it cooled faster than other wings. As shown in Figure 3.12, the temperature drops quite rapidly immediately after fluid application and then flattens out. Figures 3.13 and 3.14 (with simulated fuel loaded) show the same characteristic. As a result, the JetStar leading edge profile was in the lower half of the generic wing temperature profiles range. The temperature profile for a measured location on the leading edge of the outer wing fell at -2 standard deviations of the generic wing range.

In the course of testing in the NRC Canada cold chamber, one test involved cleaning snow from the wing by spraying hot fluid. The fluid quantity necessary to clean the wing was equivalent to 36 L/m². The resulting temperature profile in this case took on a shape more typical of other wings.

It is suspected that the gauge of the metal in the leading edge is relatively thick. This would explain the early cooling, as the limited amount of heat applied with controlled fluid application tests would be quickly absorbed into the larger heat sink offered by the thicker skin. In the case of the spray test where a substantial quantity of fluid was applied, the capacity of the larger heat sink to absorb more heat was satisfied, and the surface temperature did not drop as rapidly as when smaller fluid quantities were applied.

The initial rapid cooling exhibited by the JetStar test wing leading edge can have a detrimental effect on elapsed time until the fluid fails, especially in conditions of heavy precipitation, when the fluid dilutes rapidly and heat is the main contributor to endurance time. This characteristic needs to be recognized in any tests conducted on the wing in which heat is an important factor.

4.2.3 Effect of Fuel Load on Temperature Profile

Outdoor tests with the JetStar test wing included measuring temperature decay profiles with the wing empty and loaded to 25% and 50% of fuel capacity. Type I fluid at full operational strength was used to simulate real fuel. This fluid was taken from storage just prior to the tests, and had a temperature of 14°C. The OAT was -3°C.

Figures 3.15 to 3.19 present temperature profiles for locations on the wing and various fuel loads. In examining these profiles, no clear trend can be seen. The curves are always reasonably close to each other. The differences appear to be random and are probably due more to variance in spray pattern than to anything else.

This subject is discussed further in Section 4.3.2.2 which examines temperature decay rates on cold-soak boxes containing different fluid amounts.

4.2.3.1 Comparison of Ethylene-based Type I Fluid with Kerosene Fuel; 1 Mar 2001

The objective of this test was to examine the effect of using a Type I fluid to simulate real jet fuel in the JetStar test wing.

In Figure 3.40, the temperature profile for the cold-soak box with kerosene is slightly higher than that for the box with Type I 50/50 fluid, both 50% filled and completely filled. The difference is not

substantial, and indicates that use of Type I fluid as a test substitute for real fuel is acceptable.

4.2.4 Outdoor Trials on Saab 340 and B 737 Aircraft

These trials produced comparative data for wing leading edge and candidate test surfaces exposed to identical natural weather conditions.

Figure 3.20 presents temperature profiles for three locations along the leading edge of the Saab 340. The three curves fall in the middle of the generic wing temperature curves and follow the same progression. The results for the B 737 aircraft (Figure 3.21) were very similar.

The surfaces tested at the same time were as shown in Table 4.1

**Table 4.1
Surfaces Tested in Conjunction with Aircraft Tests**

TEST UNIT	FLUID QUANTITY (L)	FLUID TEMPERATURE (°C)	METHOD OF APPLICATION
Std. 7.5 cm cold-soak box, empty	0.5	60	Fluid spreader
7.5 cm cold-soak box with double thickness surface, empty	1.0	60	Fluid spreader
Std. aluminum plate	1.0	20	Poured

The resulting temperature profiles show that:

- the curve for the standard 7.5 cm cold-soak box falls just below the wing curves, with a very similar shape;
- the curve for the thickened surface cold-soak box falls just above the wing; and
- the curve for the standard HOT test falls at the lower range of the generic wing temperature curves. This result was noted in other outdoor tests and will be discussed in the next section.

4.3 Examination of Various Candidate Test Surfaces

4.3.1 Preliminary Laboratory Tests

Figure 3.22 presents results for trials on the standard aluminum test plate. Fluid amount and temperature were varied. The resulting temperature profiles give an appreciation of the longer time to cool due to increased fluid temperature and quantity.

Figure 3.23 compares the previous curves to wing data available at that time (from historic studies). The standard HOT procedure produced a temperature profile near the lower range of the family of wing curves. Higher temperature fluid produced curves higher in the wing family. When 0.5 L at 60°C was applied, a curve near the middle of the wing family was produced.

Figure 3.24 examines temperature profiles from tests on a cold-soak box, 7.5 cm deep, and filled to 40% with a glycol mix. The box, when treated with 0.5 L at 60°C, generated a temperature profile near the middle of the family of wing curves. When treated with 1.0 L at 70°C, it generated a temperature profile closer to the top.

Figure 3.25 examines temperature profiles from tests on a thick (6.4 mm) aluminum plate. This particular plate was previously used for testing an installed (C/FIMS) ice detector sensor. When treated with 0.5 L at 60°C, the plate generated a temperature profile near the middle of the family of wing curves. When treated with 1.0 L at 60°C and at 70°C, it generated one at the upper limit.

These tests were performed in calm conditions, whereas the wing curves were generated in various wind conditions. From this test, it was seen that the standard HOT test procedure, on flat plates in calm (laboratory) conditions, was a conservative representation of real wings in the field. When used for outdoor testing in wind conditions, the resulting temperature profile would be even lower and not form an adequate representation of the wing.

These test results showed that further tests in outdoor wind conditions were required as described in the following paragraphs.

4.3.2 Outdoor Temperature Profile Tests, 7 December 2000

These test sessions examined temperature decay rates for various test units with various fluid amounts applied and at wind speeds ranging

from 15 km/h to 40 km/h. In all the test results, temperature profiles for candidate plates are shown against a reference background consisting of the average wing leading edge temperature profile and curves representing ± 1 and ± 2 standard deviations. The profile for the current Type I test method (standard aluminum plate; 1 L at 20°C, poured) is shown as a benchmark.

4.3.2.1 Standard Thickness Aluminum Plate

Figure 3.26 examines the use of a standard thickness (3.2 mm) aluminum test plate, both insulated and without insulation. The beneficial effect of applying hotter fluid (0.5 L at 60°C versus 1 L at 20°C) is demonstrated in the early part of the curve, although the wind caused rapid cooling, and no difference from the current method after 4 minutes.

Adding insulation to the underside of the plate slowed the rate of cooling and produced a temperature profile that was higher and lasted longer than that of the corresponding non-insulated plate.

In this and in following charts, a family of curves is shown in the background, representing the generic wing temperature profile. Neither of the two candidate surfaces in this test provided a good match to the wing.

Figure 3.27 examines the same plates but with additional fluid applied (1 L at 60°C versus 0.5 L at 60°C). Of these, the insulated plate provides a near-match to the average wing, though it is somewhat higher in the first few minutes.

4.3.2.2 Effect of Simulated Fuel Loads on Cold-Soak Box

Figure 3.28 examines the use of the 7.5 cm cold-soak box: empty, partially (40%) filled, and completely filled.

It made no difference whether the box was empty or partially filled. Both curves start at about the same temperature and follow the same shape.

When the box was completely filled, the initial temperature cooled more rapidly, presumably because of heat transfer to the mass of fluid directly in contact with the under-side of the surface. After about 10 minutes, the surface temperature for the filled box

matched that of the other two boxes and then settled at a higher temperature. This would indicate that a greater amount of heat was transferred from the applied fluid in the case of the filled box. The completely filled box (with internal fluid touching the upper surface) creates a greater heat-sink than the other cases.

Applying a greater amount of fluid (1 L) gave similar results.

It can be concluded from these tests, in conjunction with the tests conducted on the JetStar test wing, that partial fuel loads (not touching the inner side of the top wing skin) do not noticeably affect the wing surface cooling rate. Because fuel loads are never in contact with the inner side of wing leading edge surfaces, it follows that fuel loads do not influence leading edge cooling rates.

4.3.2.3 Thick Aluminum (C/FIMS) Plate (6.4 mm)

These plates were tested both insulated and uninsulated. The thicker surface produced rather straight profiles and a colder initial temperature. When 0.5 L was applied (Figure 3.30), the surface temperature profiles were colder than the average wing. The addition of insulation contributed a smaller benefit than in the case of the standard thickness plate. The application of a greater amount of fluid (Figure 3.31) produced better results, with curves closely approaching the average wing.

After these tests, the insulated surface was eliminated as a candidate (based on results of tests conducted in conjunction with wing sprays at Toronto Airport).

4.3.2.4 Thick Aluminum Plate (9.6 mm)

The additional thermal mass associated with these very thick plates resulted in a very flat temperature profile (Figure 3.32) with a much lower initial temperature. The addition of more fluid (Figure 3.33) raised the initial temperature, but the subsequent profiles were still flat and did not represent the average wing.

The wind speeds during this session were quite high again, causing rapid initial cooling. Additional test sessions to examine results at various wind speeds are planned.

4.3.3 Simultaneous Tests on Thick Aluminum Surfaces, Toronto Airport, 25 January 2001

In these trials, a thick (6.4 mm) aluminum plate with insulated backing was tested in conjunction with tests conducted on wings. This test surface was treated with 0.5 L of fluid at 60°C. The resulting temperature profiles for the plate have low initial temperatures and are very flat, not of the same shape as the wing curves. One example of this result is demonstrated in Figure 4.1.

As a result of these tests, this surface was eliminated as a potential candidate.

4.3.4 Outdoor Temperature Profile Tests, 1 and 2 March 2000

This test session examined empty 7.5 cm cold-soak boxes. Three versions having different surface thickness were tested:

- Box with standard surface 3.2 mm
- Box with medium surface 4.8 mm
- Box with thick surface 6.4 mm

FIGURE 4.1
DC-9 Wing + C/FIMS Plate Surface Temperature Profiles,
Run 3, January 25, 2001
Toronto Airport, Terminal 2 Ramp , OAT -7° C, Wind 4 km/h

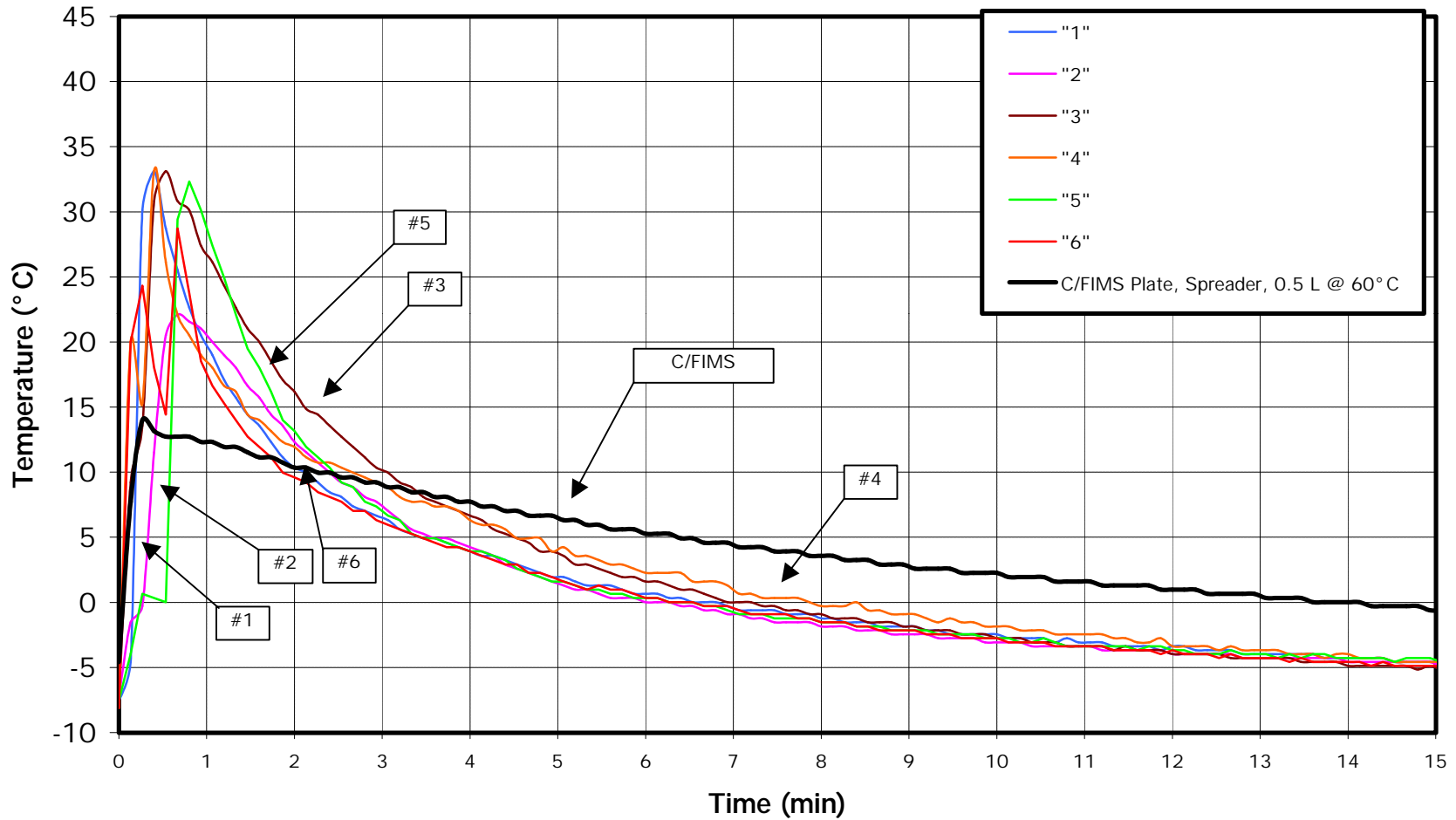

4.3.4.1 Box with Standard (3.2 mm) Surface

In calm conditions, the standard box produced a temperature profile (Figure 3.34) very close to and similar in shape to that of the average wing. At 10 km/h, the profile was close to the wing -1 standard deviation limit, and at 20 km/h, the profile met the wing lower limit at the -2 standard deviation limit. These curves were promising, but they were still slightly lower than desired for best representation of a wing.

Application of a greater fluid quantity (Figure 3.35) did not offer improvement in matching the average wing.

The standard Type I test on the aluminum plate in calm conditions followed a line between the mean and -1 standard deviation limit; eventually, it dropped to the -2 standard deviation limit. In wind conditions, the standard test profile dropped quickly; after two minutes, it was below the -2 standard deviation line. In wind conditions as discussed previously, the standard plate is not a good representation of the real wing. In calm conditions, it is a reasonably conservative representation.

4.3.4.2 Box with Thick (4.8 and 6.4 mm) Surfaces

The effect of thicker surfaces (Figures 3.36 to 3.39) was to lower all temperature profiles to below the average wing curve. In the case of the thickest surface, the shape of the profile was not similar to that of the wing. Instead, it showed rapid cooling in the initial stages and subsequently took on a very flat line. The profile for the thickest surface was very similar to that of the leading edge on the JetStar test wing, which later lay at the bottom limit of the family of wing curves.

It was concluded that making the surfaces thicker did not improve the results produced from the standard thickness surface.

4.3.5 Effect of Rate of Fluid Application on Heat Transfer to the Test Surface

When the number of drain holes in the fluid application spreader was reduced by 50%, the application interval doubled, increasing from 5 seconds to 10. Figure 3.41 shows the effect on temperature profiles of the longer application time; it has curves similar in shape to each other and to that of the average wing but with the curve from the longer application time located above the other throughout the cooling interval. This higher position of the profile solved the remaining problem: how to match the 7.5 cm box to the average wing as discussed in Section 4.3.3.1 (the curves are somewhat lower than desired for best representation of a wing).

Use of the spreader, modified as described to deliver the longer application time, was adopted for all further tests.

4.3.6 Summary of Tests on Cold-Soak Box

The temperature decay curves for all tests conducted on the 7.5 cm cold-soak box (empty and when treated with 0.5 L of fluid at 60°C using the modified spreader) were consolidated onto one chart (Figure 4.2). As with the wing temperature curves, an average cold-soak box curve with limits at ± 1 and ± 2 standard deviations was calculated (Figure 4.3).

The average box temperature profile was then overlaid on the average wing curve (Figures 4.4 and 4.5) for comparison. The mean curve and the standard deviation limits were almost identical to those of the wing.

It is important that the variance produced by the box be similar to that of the wing. This characteristic indicates that the range of temperature profiles experienced in outdoor tests conducted on the box (using the defined fluid application method) will be similar to those experienced on real wings.

4.3.7 Summary of Tests on Standard Flat Plate Procedure

Tests on the plate were treated separately for outdoor tests (in wind) and indoor tests (in calm conditions).

FIGURE 4.2
7.5 cm Cold-Soak Box Temperature Profiles, Results from all Outdoor Tests
 Box Empty, 0.5 L @ 60°C, Spreader, Adjusted to OAT -9°C, Winter 2000-2001

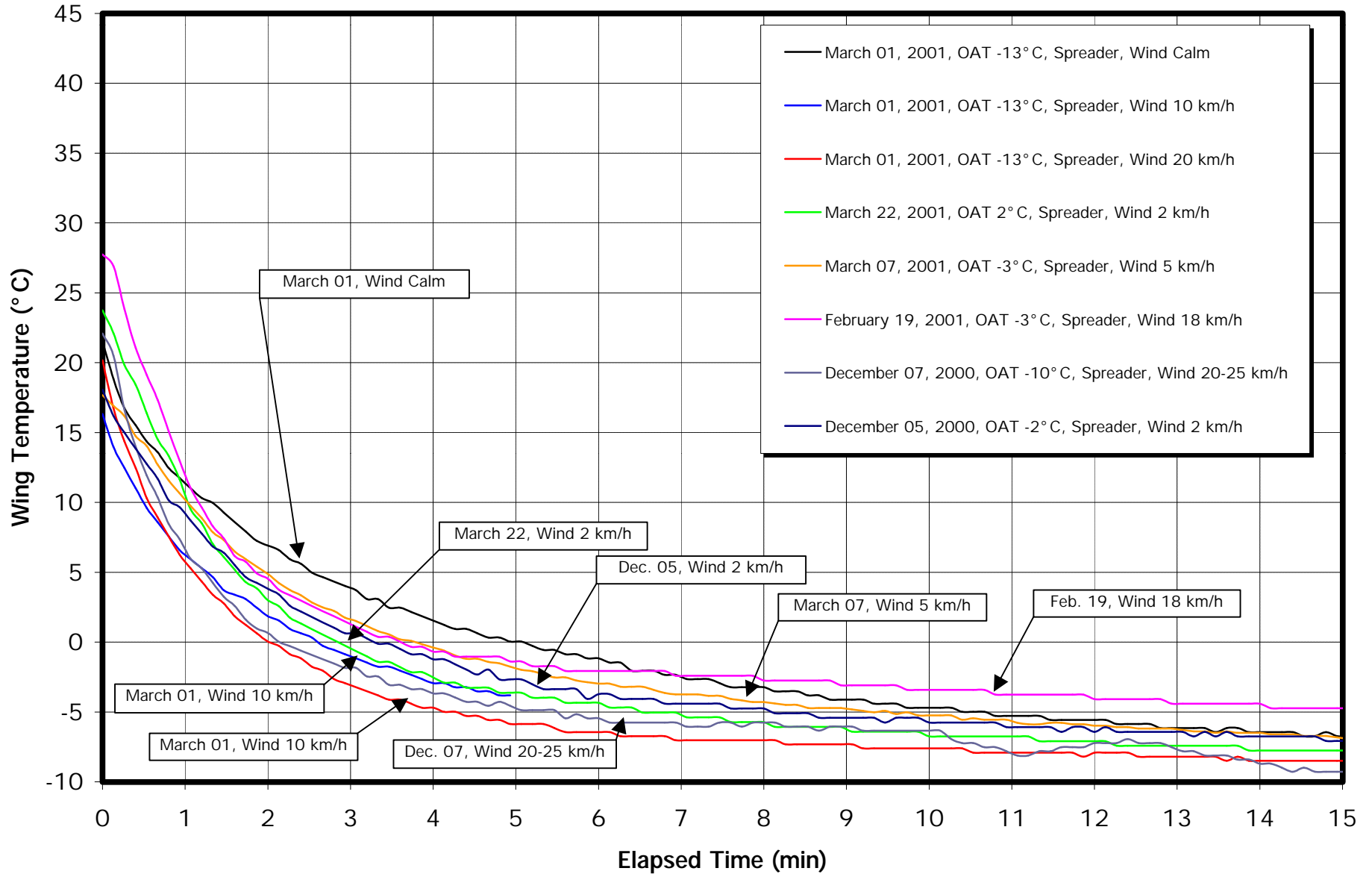

FIGURE 4.3

7.5 cm Cold-Soak Box Mean Curve

Box Empty, 0.5 L @ 60°C, Spreader, Adjusted to OAT -9°C, Winter 2000 - 2001

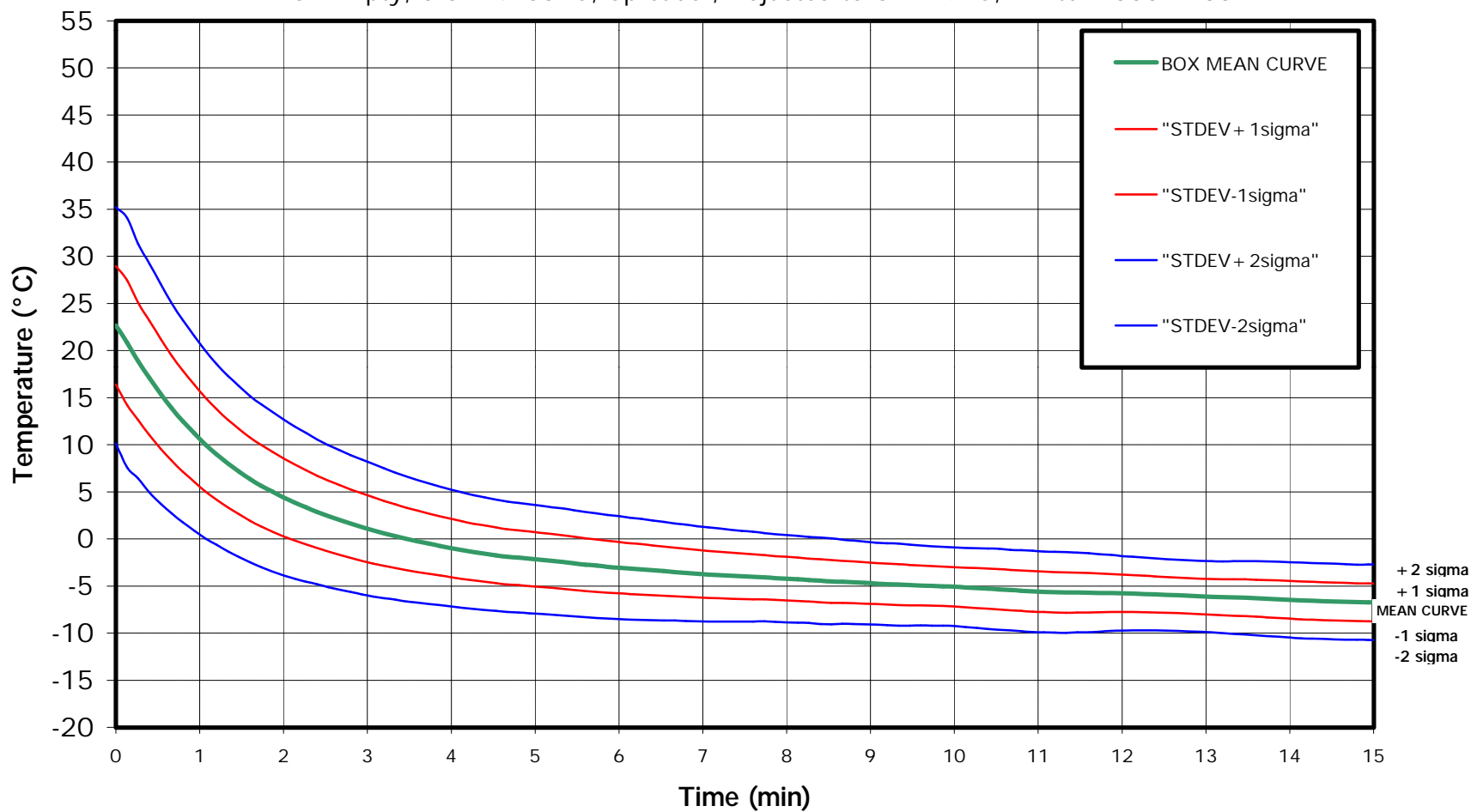

FIGURE 4.4
Comparison of 7.5 cm Cold-Soak Box Mean Curve to Wing Leading Edge Mean Curve
 Spreader, Adjusted to OAT -9° C

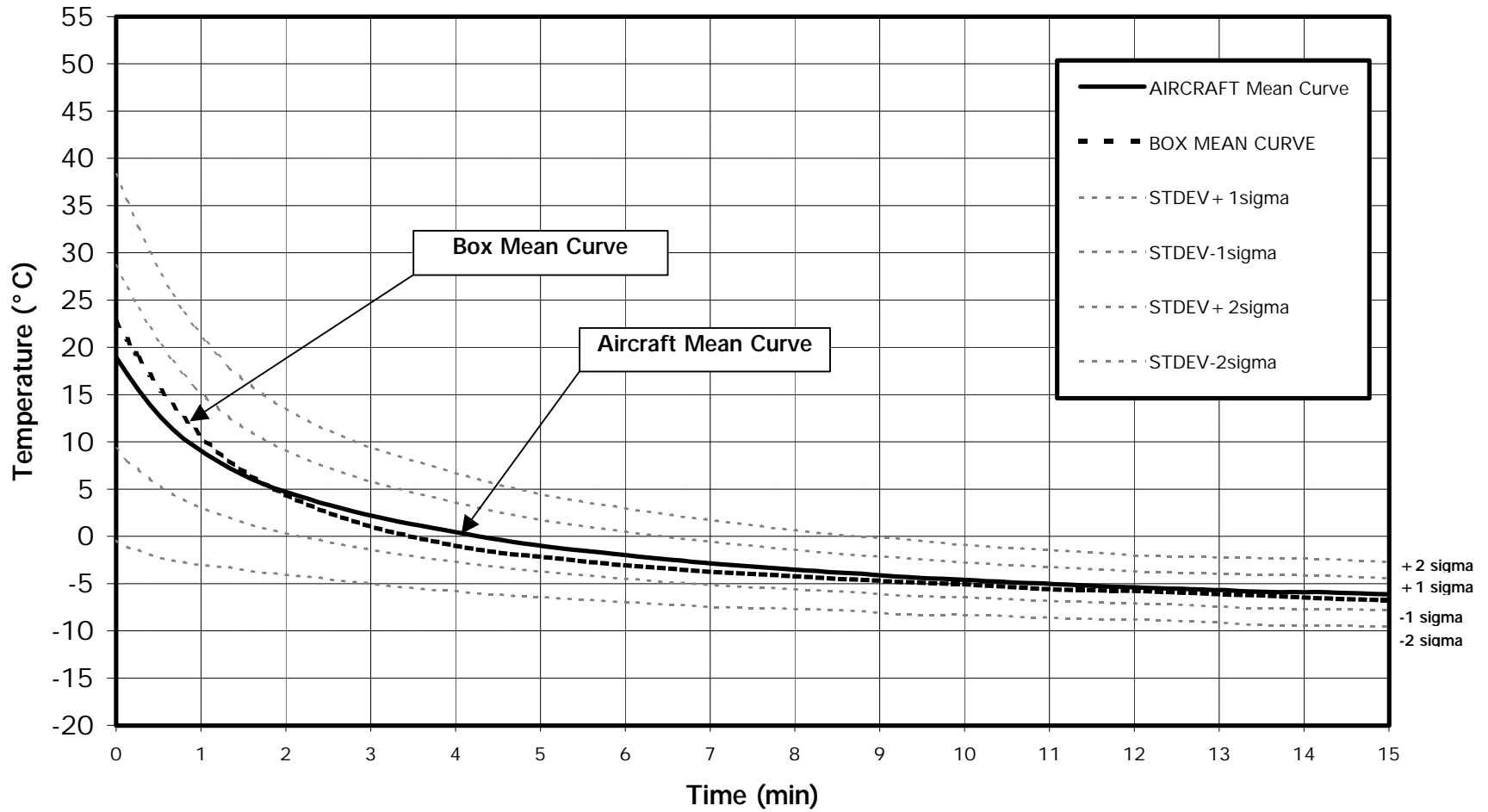
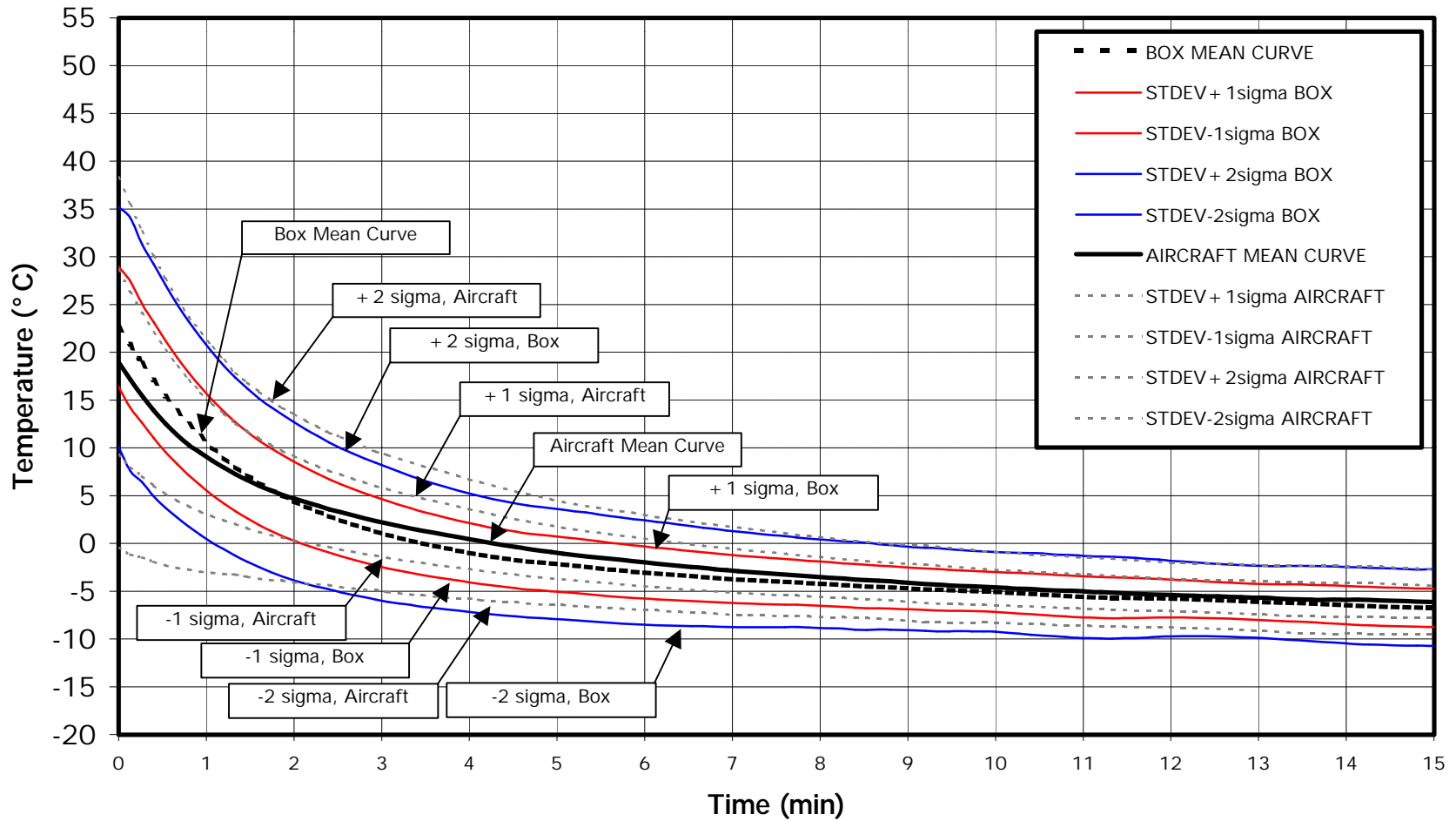

FIGURE 4.5

Comparison of 7.5 cm Box Std. Deviation to Wing Leading Edge

7.5 cm Cold-Soak Box, Box Empty, 0.5 L @ 60°C, Spreader, Adjusted to OAT -9°C



The series of temperature decay curves for plates in calm conditions is given in Figures 4.6 to 4.8. Figure 4.8 shows that the current flat plate test procedure, in calm conditions, gives a reasonable, if conservative, representation of the wing in outdoor conditions.

The series of temperature decay curves for plates in outdoor conditions is given in Figures 4.9 to 4.11. Figure 4.11 shows that the current flat plate test procedure, in outdoor conditions, is not a good representation of the wing. Fluid endurance times generated by testing on the flat plate in outdoor conditions would be considerably shorter than those on the wing.

4.4 Fluid Endurance Time on Test Surfaces

Fluid endurance times, shown in Figures 3.42 and 3.43, demonstrate that the cold-soak box, in combination with application of 0.5 L of fluid at 60°C, produces longer times than the current method, using the aluminum plate and 1 L of fluid at 20°C. The tests were numerous enough to establish a trend but too few to estimate actual holdover times.

Trials comparing endurance times on an aircraft wing with times using the proposed test protocol are planned for the next winter season.

A detailed examination of data collected during previous fluid-failure tests on aircraft could provide supplementary information on the equivalence of failure times on wings and those achieved under the proposed test protocol.

4.5 Effect of Temperature Range Limits on Holdover Time

A comparison of the cold-soak box test endurance time results with existing SAE guidelines indicated that the guidelines are presented for only three ranges of OAT, as follows:

- above 0°C
- 0°C to -10°C
- below -10°C

This range structure results in a significant reduction in holdover times for snow at milder temperatures.

The following attempts to demonstrate the inherent penalty imposed by formatting holdover time guidelines in sets of large temperature ranges (such as from 0°C to -10°C and below -10°C).

FIGURE 4.6
HOT Plate Temperature Profiles – Indoors
1.0 L @ 20°C, Poured, Adjusted to OAT -9°C

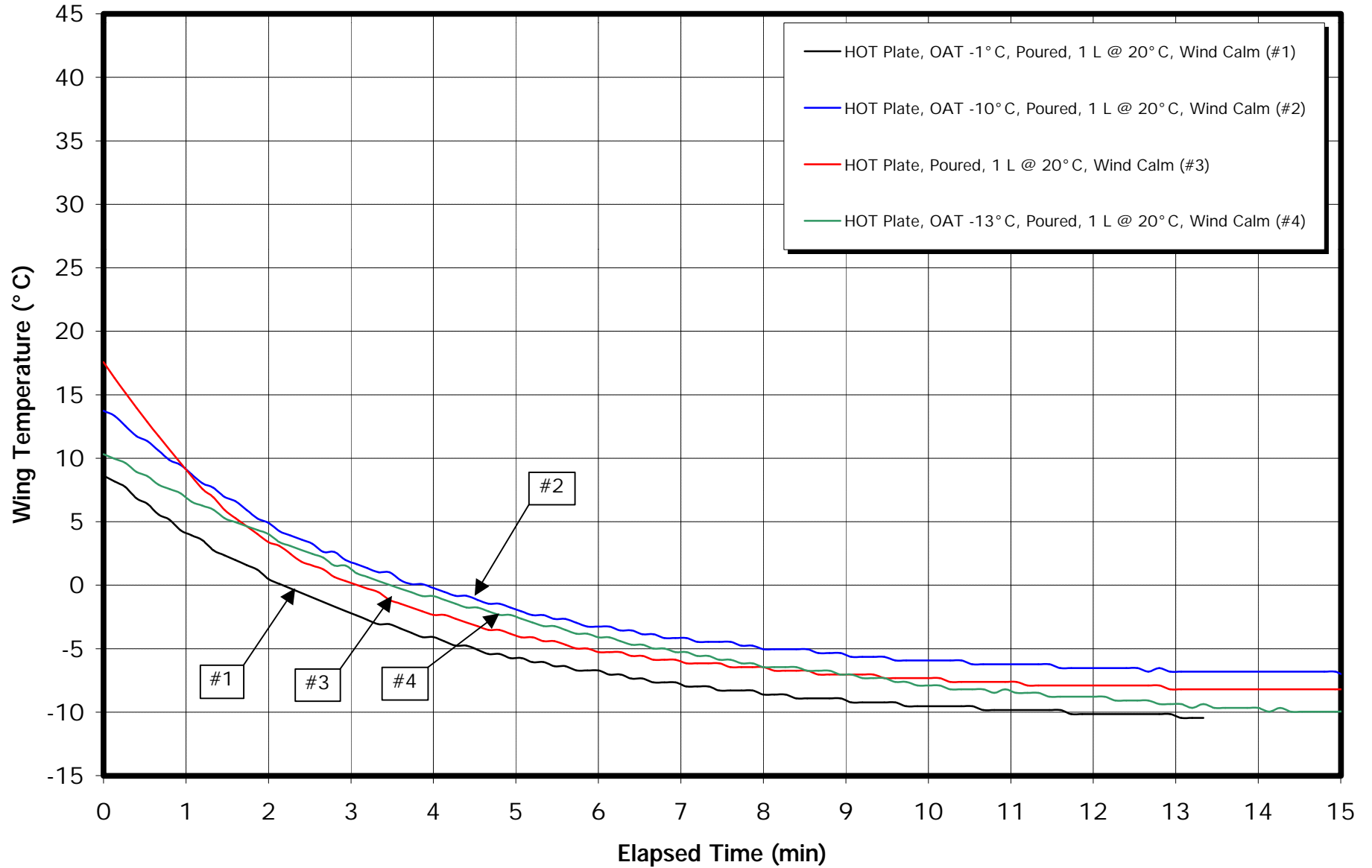

FIGURE 4.7
HOT Plate Temperature Profiles (Indoors) – Consolidated Data
 1.0 L @ 20° C, Poured, Adjusted to OAT -9° C

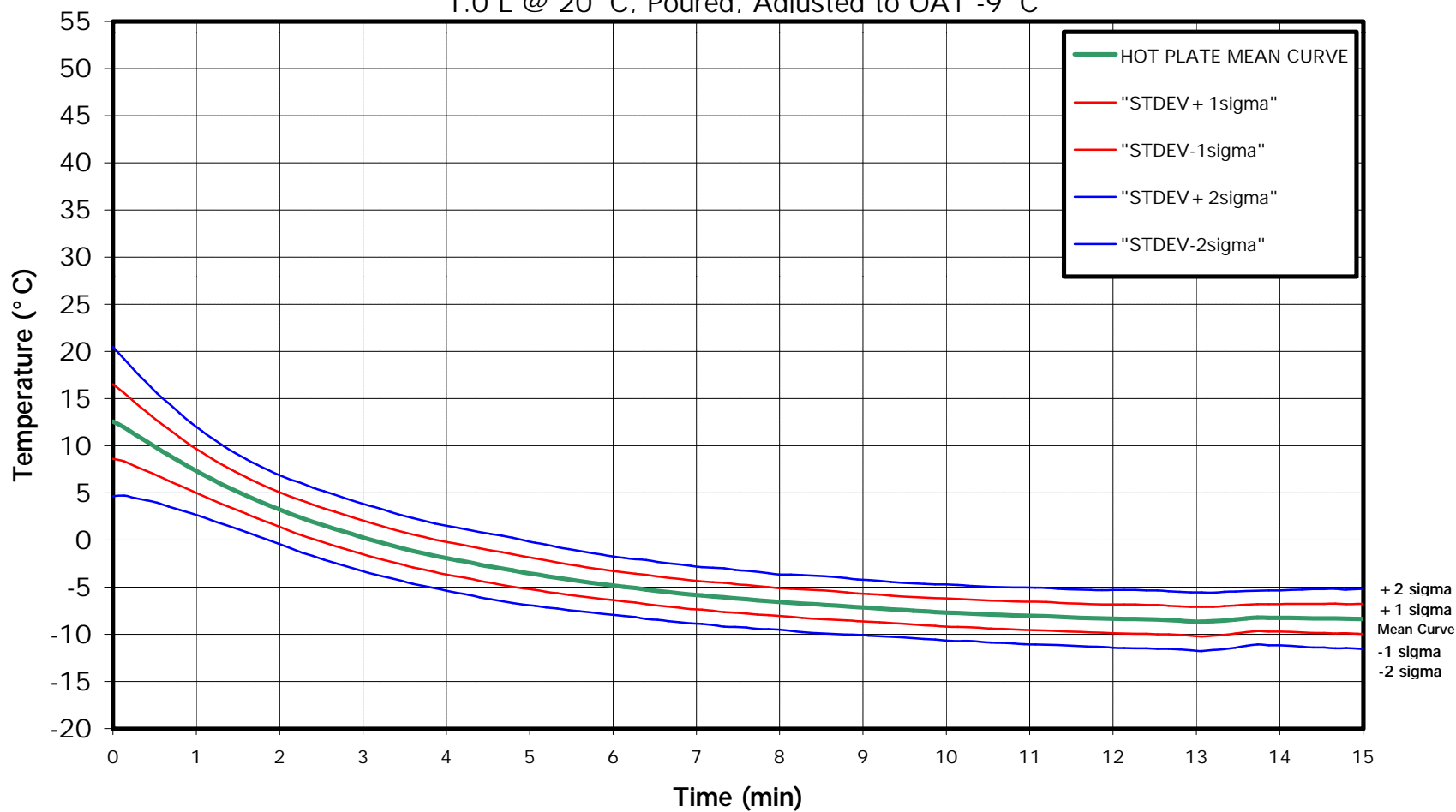

FIGURE 4.8
HOT Plate Temperature Profiles (Indoors) – Comparison to Average Wing and Box
 1.0 L @ 20°C, Poured, Adjusted to OAT -9°C

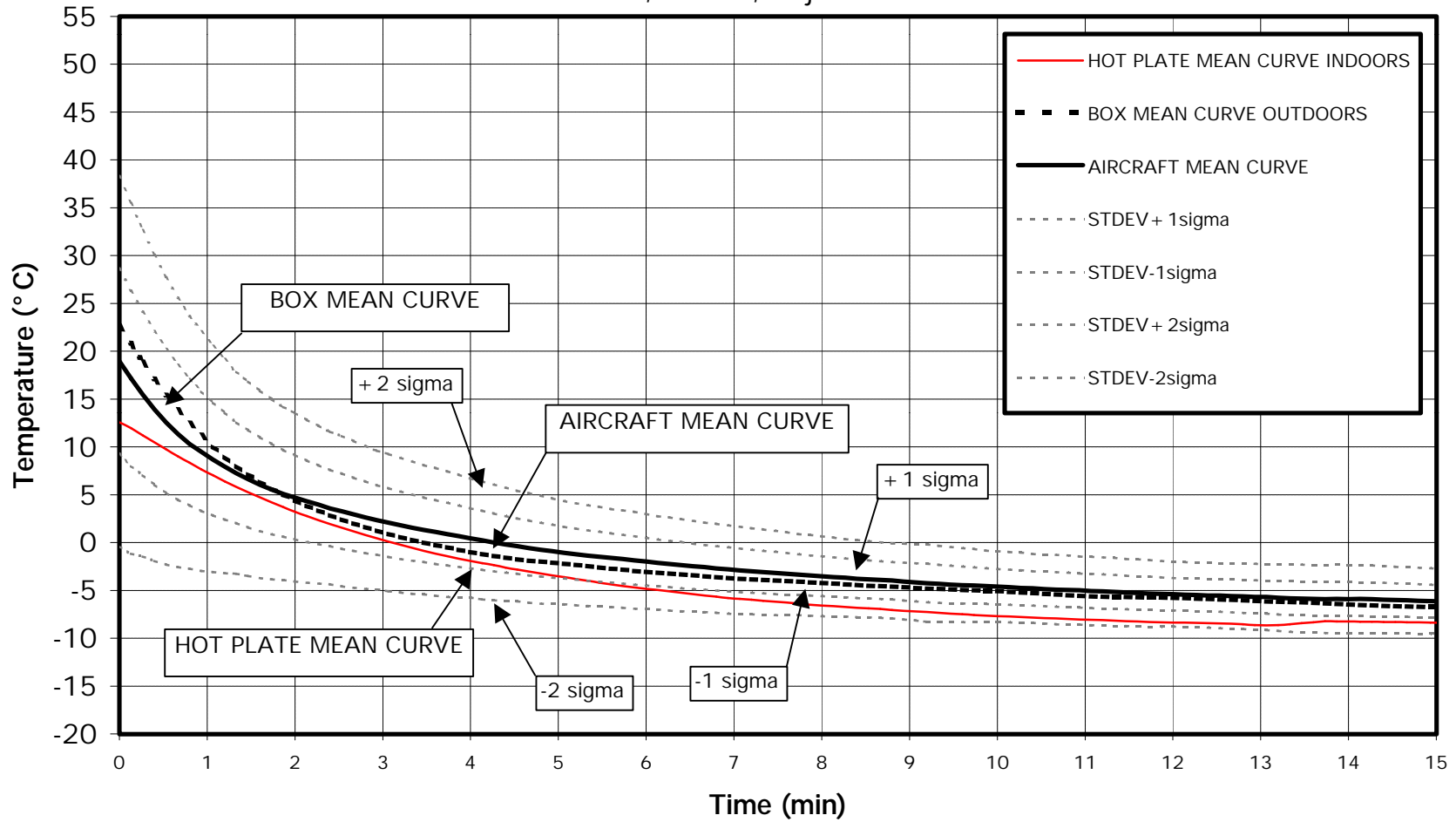

FIGURE 4.9
HOT Plate Temperature Profiles (Holdover Time Method) – Outdoors
1.0 L @ 20°C, Poured, Adjusted to OAT -9°C

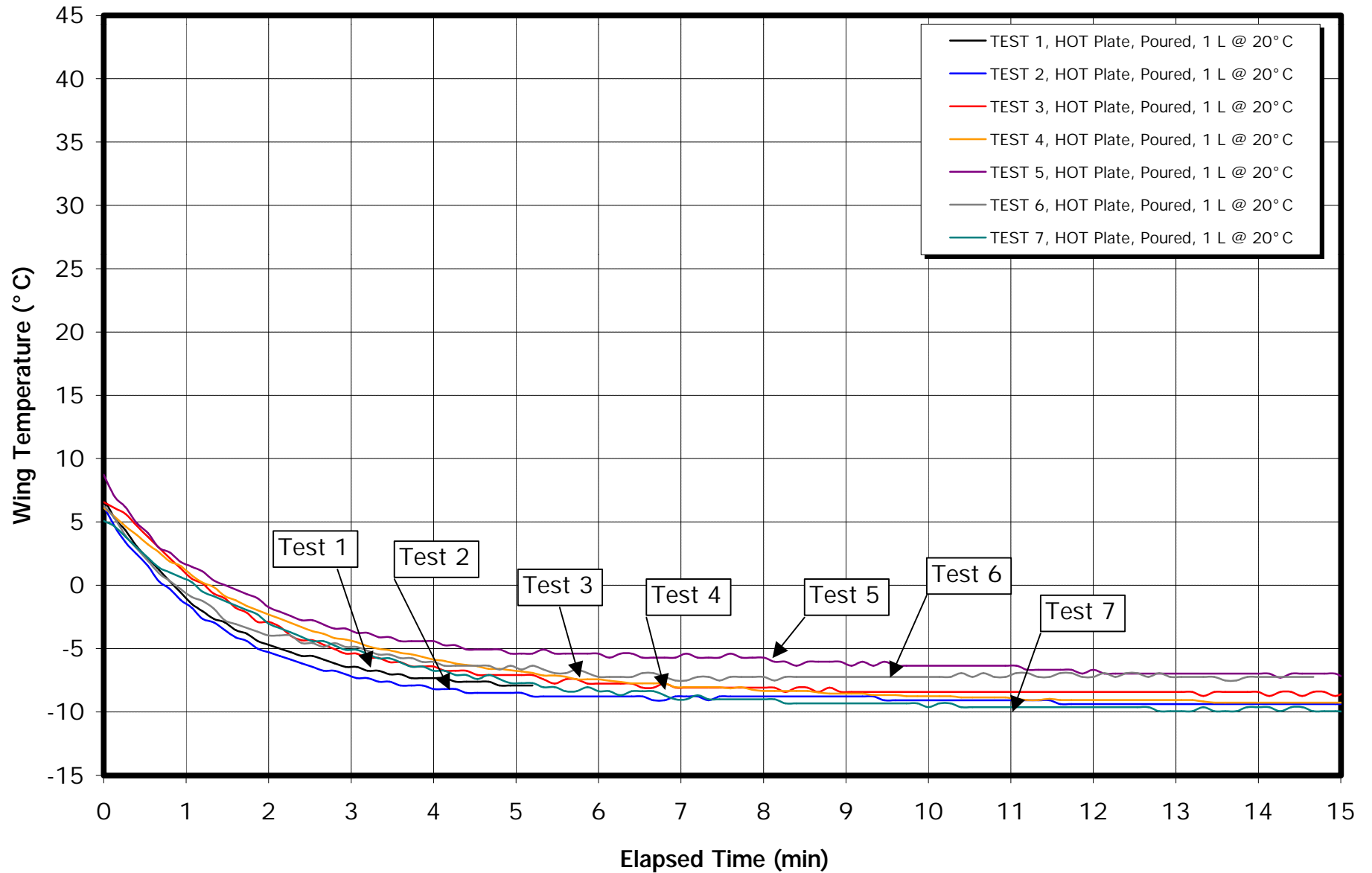

FIGURE 4.10

HOT Plate Temperature Profiles (Holdover Time Method) – Outdoors – Consolidated Data
1.0 L @ 20°C, Poured, Adjusted to OAT -9°C

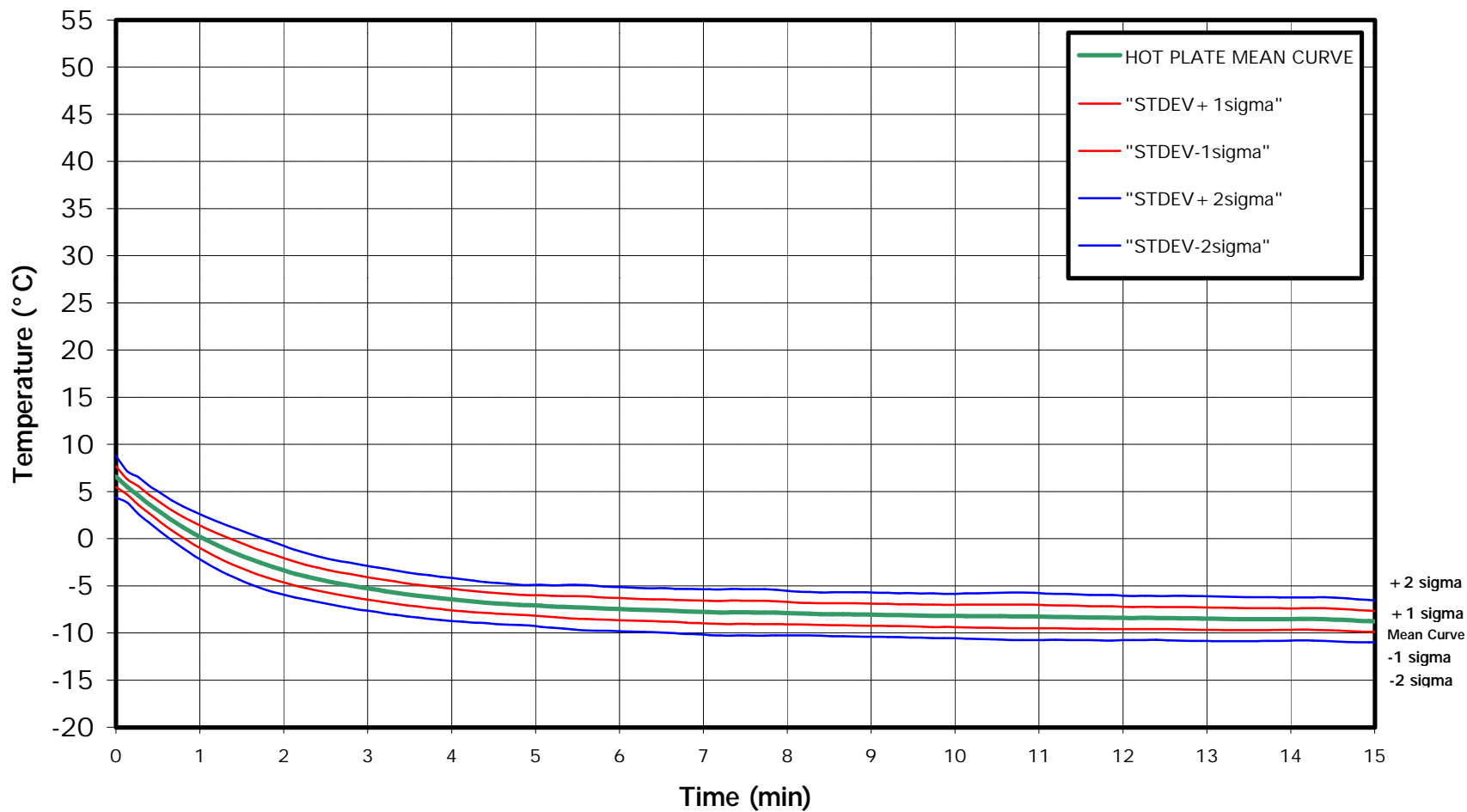
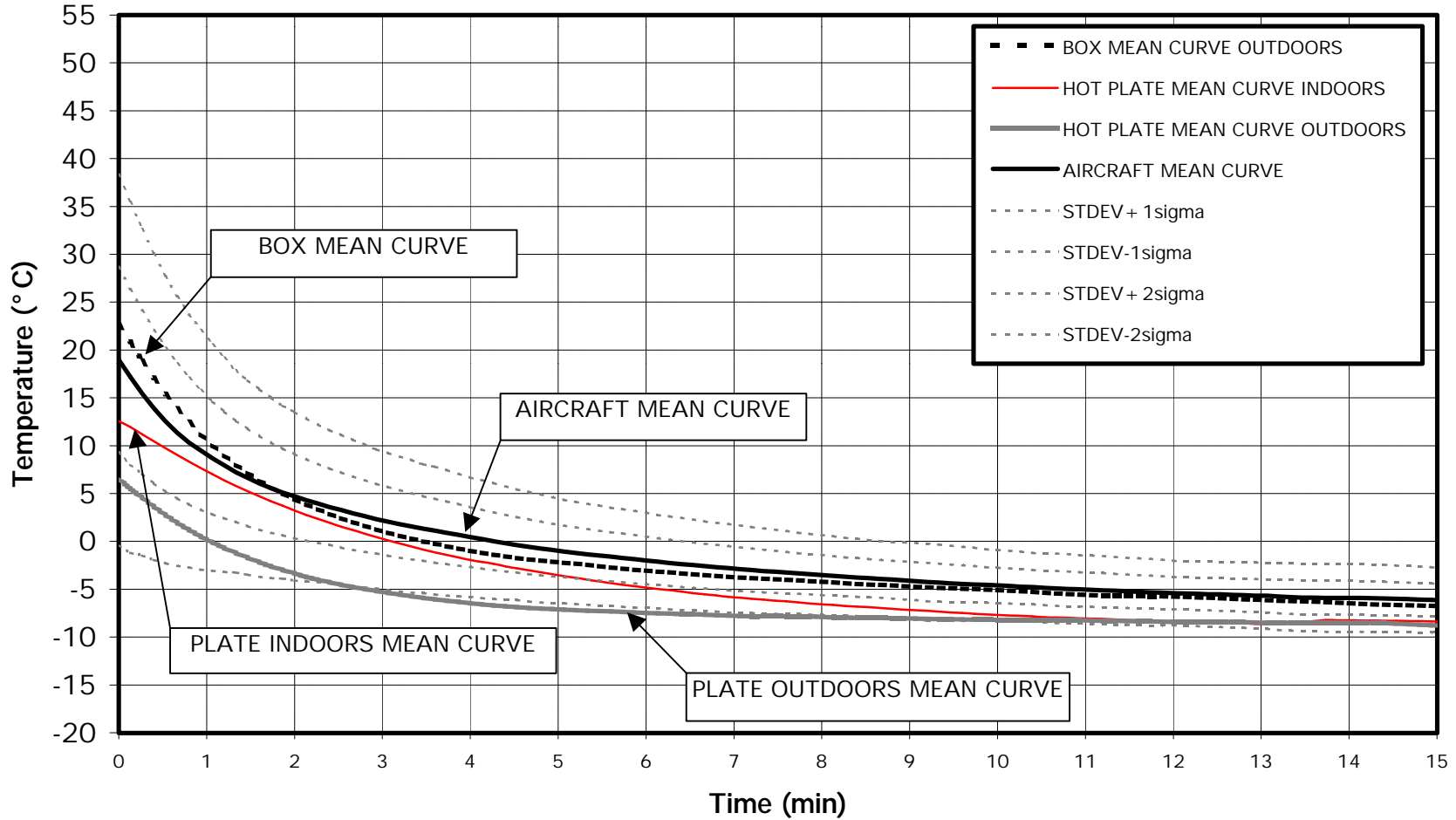

FIGURE 4.11

Plate Temperature Profile (Outdoors) – Comparison to Average Wing and Box

HOT Plate Temperature Profiles, 1.0 L @ 20° C, Poured, Adjusted to OAT -9° C

BOX Plate Temperature Profile, 0.5 L @ 60° C, Spreader, Adjusted to OAT -9° C



4.5.1 Temperature Range 0°C to -10°C

Figure 4.12 illustrates the surface temperature and fluid freeze point mechanisms that influence fluid failure at OAT -10°C, a range lower limit in the current SAE guidelines.

The average wing leading edge temperature profile curve is shown, adjusted to an OAT of -10°C. The curve gradually approaches its ultimate value, ambient temperature.

The fluid freeze point temperature curve is derived from an amalgamation of fluid concentration (Brix) values measured progressively during several actual tests in precipitation conditions. This curve represents the fluid freeze point temperature as the fluid gradually dilutes, increasing from its initial value of -20°C (10°C buffer) and approaching its ultimate value of 0°C.

If unheated fluid had been applied, thereby allowing the wing surface temperature to remain at -10°C, initial freezing of the fluid would have occurred when its freeze point reached -10°C, in this case about 2 minutes after spraying.

Had hot water at the same temperature been applied, initial freezing of the fluid would have occurred when its freeze point reached 0°C, in this case about 3 to 4 minutes after spraying.

The combination of heat and fluid freeze point depressant provides the endurance times experienced in actual operations. When heated fluid is applied, freezing will occur when the fluid freeze point and the surface temperature match. In this case, a match occurs between 5 and 6 minutes following spray.

4.5.2 Temperature Range 0°C to -3°C

Figure 4.13 represents the surface temperature and fluid freeze point mechanisms that influence fluid failure at a different lower limit for the range, in this case -3°C.

The generic wing leading edge temperature profile curve used here is normalized to an OAT of -3°C. The leading edge temperature reaches a higher peak temperature than in the previous case (because it started at a higher temperature). In this discussion, it is assumed that leading edge temperature progressively approaches its ultimate value (OAT -3°C) at the same rate as it approached OAT -10°C in the previous case. Any errors in this assumption do not change the nature of the argument.

FIGURE 4.12

Intersection of Wing Temperature and FFP Profiles

Typical dilution curve, Snow @ 25 g/dm²/h, FFP @ 10°C Buffer, OAT -10°C

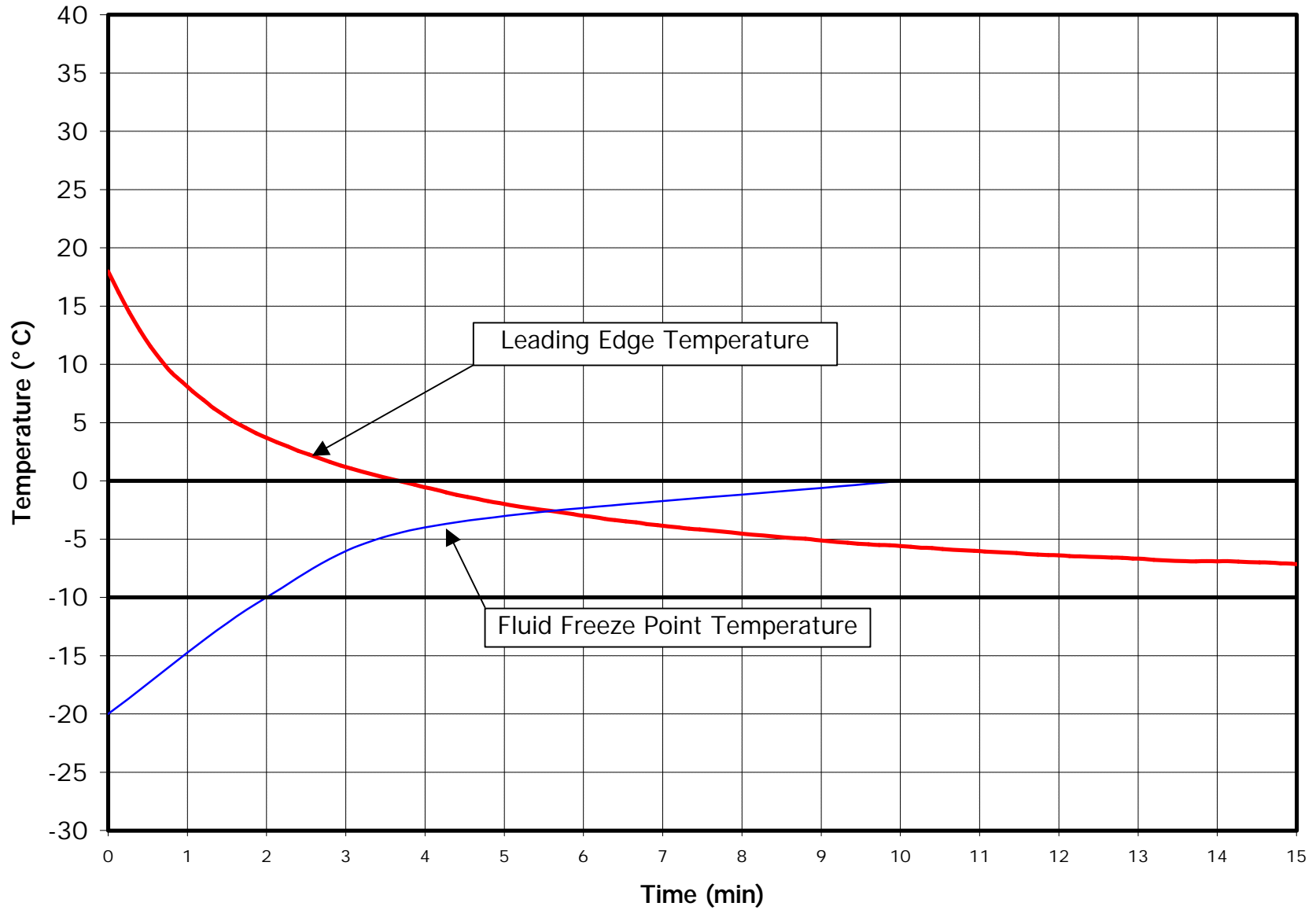
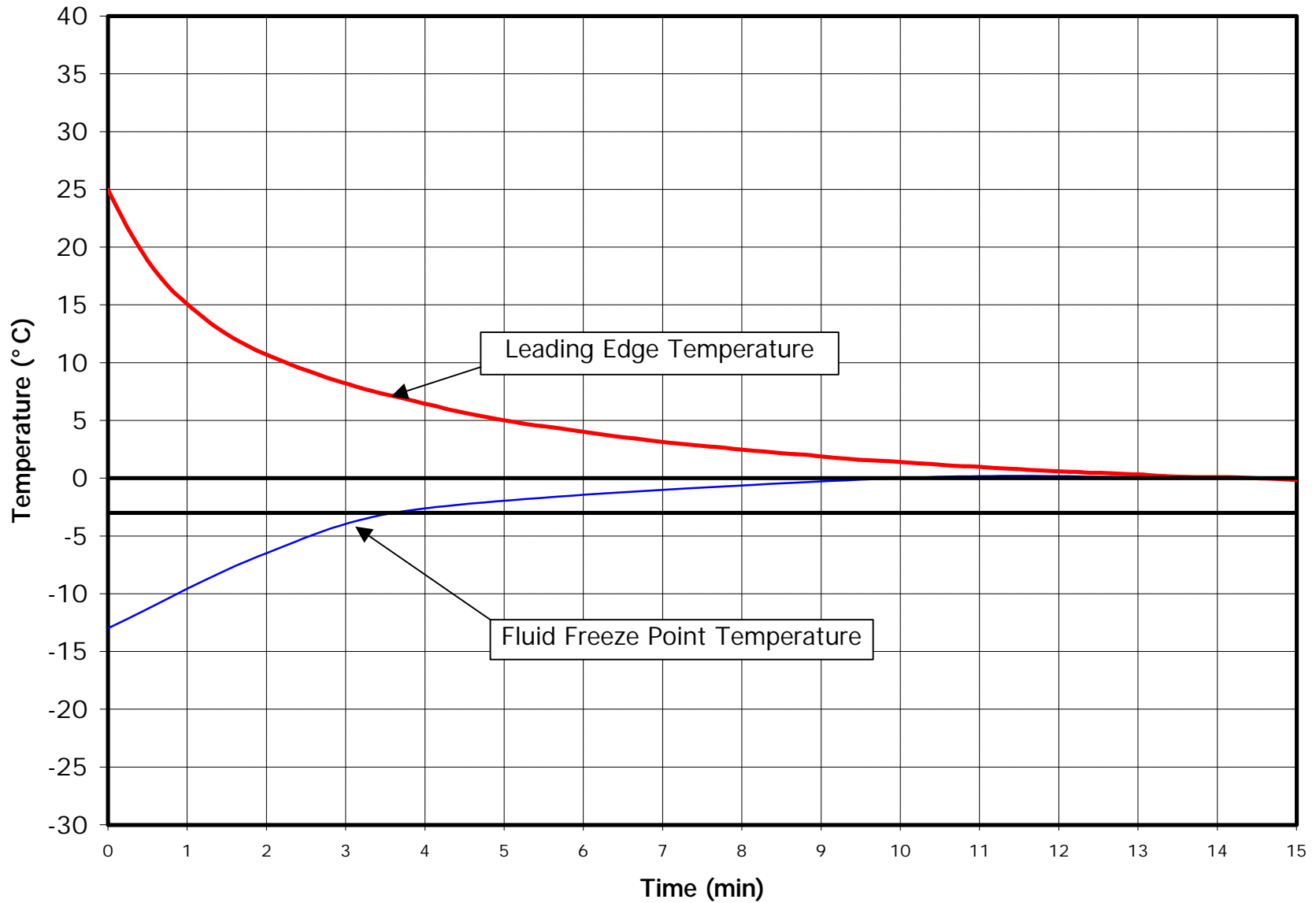

FIGURE 4.13

Intersection of Wing Temperature and FFP Profiles

Typical dilution curve, Snow @ 25 g/dm²/h, FFP @ 10°C Buffer, OAT -3°C



The fluid freeze point temperature curve shown here is also derived from fluid concentration values measured periodically during actual tests. The fluid freeze point temperature gradually rises from its initial value of -13°C (10° fluid freeze point buffer) and approaches 0°C as a result of ongoing dilution under precipitation.

In this case, the point of intersection (at 13 minutes or more) is much later than in the previous case. This later intersection is influenced by the increasing flatness of the two curves as they near their ultimate values, which in this case are very close to each other (-3°C and 0°C).

The benefit of using smaller ranges in the SAE guideline is demonstrated in the comparison of these two cases. Adoption of a range having a lower limit such as -3°C offers much longer holdover times than one with a lower limit of -10°C .

A further observation on this case (OAT = -3°C) is that a small variation in the wing temperature profile can cause a large difference in the time of intersection and thus in the time to fluid failure. Outdoor tests at -3°C can result in much scatter in observed endurance times, and it might be necessary to account for this when designing the test plan.

Further to this discussion, Table 4.2 provides a distribution of snowfall events by temperature range. This table was based on weather reports from weather stations in Quebec between 1995 and 2000.

As the table shows, when the distribution is re-sorted to match the temperature ranges in the current SAE guideline, nearly 70% of snowfall events are included in one range (0°C to -10°C). The use of narrower ranges would provide better representation of actual snowfall event distribution, as well as offering longer holdover time guidelines at warmer temperatures.

4.6 NRC Canada Trials

As noted earlier, different procedures are needed for the two types of test:

- Outdoor tests in variable wind conditions
- Laboratory tests in calm conditions

Whereas outdoor tests experience the same range of natural weather conditions as aircraft do in deicing conditions, the test protocol for laboratory tests *in calm conditions* must produce fluid endurance times to reflect real wing surfaces *in variable wind conditions* in the field.

TABLE 4.2

**Distribution of Snowfall Events Compared to HOT Table Range
Quebec, 1995 to 2000**

Distribution of Snowfall Events		Snowfall Events Sorted by HOT Table Range	
Temperature Range [°C]	Frequency [%]	Temperature Range [°C]	Frequency [%]
above 0	8	above 0	8
0 to -3	23	0 to -10	69
-3 to -7	30	below -10	23
-7 to -14	32		
-14 to -25	7		

Source: Evaluation of Winter Data (1995-2000) Transport Canada Report TP 13665E

These trials were conducted later in the winter season, following the temperature profile test sessions and the outdoor fluid endurance trials. By this time, the concept for the outdoor test protocol had evolved into the following:

- Use empty 7.5 cm cold-soak box as test surface
- Clean contamination from surface and wet with ambient temperature test fluid
- Apply 0.5 L @ 60°C using modified fluid spreader

This proposed test procedure was followed during the NRC Canada trials. As with previous test sessions, benchmark tests were conducted simultaneously using the current Type I protocol:

- Use standard flat plate as test surface;
- Test fluid at 20°C;
- Clean contamination from surface and rinse by pouring 1/3 L test fluid over plate and removing by squeegee; and
- Pour 2/3 L test fluid along the top edge, allowing it to run down over the plate.

Some trials were conducted using a cold-soak box with a thick (6.4 mm) surface.

It had been found that temperature profiles for the average cold-soak box and average wing were very similar. The fact that these laboratory tests were conducted without wind was expected to affect box and wing surfaces to the same extent. In calm conditions, longer endurance times than in outdoor conditions would be expected, but the additional time should be similar for the two surfaces. Thus the trials form a valid basis for assessing the reliability of the cold-soak box as a wing simulation.

However, viewing the flat plate trials as a simulation of a wing in outdoor conditions and comparing the results to those of tests on the wing in the laboratory are not so simple. Because the wing in the lab was expected to produce holdover times longer than when exposed to outdoor conditions, the plate in the lab should produce times correspondingly shorter than the wing (and the box). Because we don't know the extent of the difference, some judgment must be used in assessing the results.

4.6.1 Endurance Times in Snow

Figures 3.45 and 3.46 compare fluid endurance times of the box with those of the plate test. The difference in temperature profile is apparent,

the box temperature being higher than that of the plate throughout the tests. The fluid dilution curves (fluid freeze points) rise rapidly to intersect the surface temperature curves. Fluid failure times are shown; the plate failed about one minute earlier than the box in both tests.

Figures 3.47 and 3.48 report failures on the wing leading edge as well as on the test surfaces. Failures on the wing (reported at 10%, 20% and 30% of the leading edge test area) occurred earlier than on the box. Examination of the temperature profiles provides an explanation for this. As mentioned earlier, the test wing displays a period of rapid cooling immediately after fluid application, and the cooling curve then flattens out. The early cooling, in combination with the rapid rate of fluid dilution under the test snowfall rate (21 g/dm²/hr and 28 g/dm²/hr), results in early intersection of profiles and early initial freezing.

Again, the box lasted longer than the plate by about one minute.

Fluid was applied to the pre-cleaned wing in the foregoing tests using the specially built spreader, at a rate of 3.3 L/m². This is equivalent to 0.5 L on a flat plate (or box) surface.

In the first test of the session, the wing was cleaned by spraying a heated fluid. The snow depth was about 7.5 cm (3 in). Much steam was generated during the spray operation, interfering with the spray operator's view of the wing and probably causing more fluid than usual to be used. Thirty-six L/m² of fluid was used to clean the wing test area.

In this test (see Figure 3.44), the wing temperature profile and the thick-surface box were well matched, and their respective failure times were close. The profiles for the standard box and the plate were not available for this test.

4.6.2 Effect of Freezing Rain on Surface Temperature

Fluid was applied with the wing fluid spreader for tests in freezing rain at the same rate as in the snow tests, 3.3 L/m².

In freezing rain tests, the temperature profiles for both the wing test area and the test cold-soak box levelled off at 0°C (see Figure 3.49). The rapid cooling of the wing leading edge was still seen, but here the curve flattened off at 0°C. The cold-soak box cooled at a slower rate than seen in other tests, reaching 0°C in 8 minutes (and then staying there) instead of in the expected 4 minutes at this OAT.

The HOT plate, as well, took longer to cool to 0°C: 4 minutes versus the expected time of 3 minutes. However, as opposed to the box and wing, the plate temperature did tend to cross the 0°C line to approach lower temperatures. This was seen more at the lighter rainfall rate of 10 g/dm²/hr than at 25 g/dm²/hr.

The explanation for the slower cooling and the stagnation of the surface temperature at 0°C must lie with the fact that liquid water is continually striking the surface. As long as the water on the surface remains in its liquid form, its temperature cannot be below 0°C. The metal substrate and the water on it then reach a common temperature of 0°C. Because the surface water is continually being replaced, even though it might be slightly super-cooled, there is insufficient transfer of thermal energy from the test unit (surface and water film) to the surrounding environment to offset the needed transfer of latent heat from the water to allow it to freeze. A state of temperature equilibrium is then reached. The water is trying to freeze and gives up its latent heat; but this heat, in turn, might raise the temperature of the substrate surface and re-melt the ice.

In the case of the plate, which is unprotected and exposed to the environment on its underside, there is a faster transfer of heat from plate to the surrounding environment. This allows the plate temperature to continue to decrease below 0°C in the -10°C environment.

This explanation raises the question as to what is the best simulation of a wing for freezing rain. Presumably the wing temperature will respond in a similar way and will sit at 0°C until enough heat energy is lost to the environment to allow freezing. In that case, the plate is not a good representation, because it will give endurance times that are shorter than actual experience. A second influence, however, is the degree of super-cooling of the raindrop in nature as opposed to that in the laboratory. Raindrops in natural freezing-rain conditions are super-cooled to a much greater degree than those in the lab, which start from the sprayhead at 2°C and whose cooling time in the -10°C environment is limited by the 4.5 m fall-distance.

Because of the many unknowns in the freezing rain condition, it is recommended that the more conservative test unit (the current test plate procedure) continue to be used.

4.6.3 Endurance Times in Freezing Rain (10 g/dm²/hr)

Duplicate tests are reported in Figures 3.49 and 3.50. The lower rate of precipitation results in slower dilution of fluid than in the snow case. At

the same time, the surface temperatures stagnate at 0°C instead of cooling to ambient. As a result, the points of intersection of the surface temperature and fluid freeze point temperature are notably later than in the snow case.

Because the test wing cools faster than the average wing, comparisons of endurance times between test surfaces and wing must be treated cautiously. Table 4.3 shows some failure times for plate, box and wing.

**Table 4.3
Comparison of Endurance Times in Light Rain**

Rate (g/dm ² /hr)	Figure #	Plate (min)	Box (min)	Wing Leading Edge		
				10% (min)	20% (min)	30% (min)
10	3.49	6.5	9.1	8.2	10.8	11.8
10	3.50	7.5	11.3	7.2	8.3	9.3

4.6.4 Endurance Times in Freezing Rain (25 g/dm²/hr)

In tests at the higher rate of precipitation (25 g/dm²/hr), failure times were as shown in Table 4.4:

**Table 4.4
Comparison of Endurance Times in Moderate Rain**

Rate (g/dm ² /hr)	Figure #	Plate (min)	Box (min)	Wing Leading Edge		
				10% (min)	20% (min)	30% (min)
25	3.51	4.6	7.0	7.6	8.9	9.9
25	3.52	3.3	6.0	8.2	8.9	10.2

In these tests, the box failed earlier than the wing. The plate failed much earlier than either the box or the wing.

5 CONCLUSIONS

Based on discussions in Section 4.1.2, it is concluded that two test procedures are required:

- a procedure for outdoor trials in natural precipitation and wind conditions; and
- a procedure for laboratory trials in calm conditions.

It was concluded that the following procedures were potentially suitable for Type I fluid endurance time testing.

5.1 Test Procedure for Outdoor Trials

The current Type I test procedure, when conducted outdoors in natural wind, did not provide a good simulation of actual deicing operations and did not produce a surface temperature decay rate that matched real wings. Shortened fluid endurance times would result.

Following examination of several test surfaces and various procedures for fluid application, it was concluded that the 7.5 cm cold-soak box, empty, when treated with 0.5 L of fluid at 60°C, produced a reasonable representation of the temperature decay rate demonstrated by wings in natural outdoor conditions.

The 7.5 cm cold-soak box, empty, is the test surface that should be used for outdoor tests. It is important that the test unit be allowed to cool to OAT following each test and before starting the next. If new units are to be built for test purposes, it might be useful to modify the design to facilitate faster cooling between tests. This could involve placing large openings in the walls of the unit, which could be opened between tests to allow circulation of ambient air through the box cavity.

The fluid temperature should be 60°C with an acceptance range of +2°C and 0°C and the fluid quantity should be 0.5 L.

The plate preparation procedure is to clean the test surface of all contamination, then, to ensure spreading of the test fluid, wet the entire surface with test fluid at ambient temperature. Next, remove the wetting fluid by use of a rubber wiper blade or squeegee, and apply the test fluid.

Test fluid should be applied with a fluid spreader placed along the top edge of the test surface. The spreader should be equipped with enough drain holes to allow 0.5 L to drain in 10 seconds. In wind conditions, a windshield

should temporarily be held in position to prevent the wind from blowing the fluid away until the fluid has spread across the entire test surface. The windshield can be any flat surface that serves the purpose.

Fluid endurance time trials demonstrated that the cold-soak box, in combination with application of 0.5 L of fluid at 60°C, produced longer times than the current test method using the aluminum plate and 1 L of fluid at 20°C.

5.1.1 Outstanding Activities to Finalize the Test Protocol

It is still necessary to conduct simultaneous trials on real wings and the proposed outdoor test procedure to confirm equivalence. These trials should be conducted early in the next winter season (2001–2002) to support proceeding as soon as possible with actual fluid tests using the new procedures. Use of a modern test wing would speed up this process. The potential availability of a Canadair RJ wing should be explored.

A detailed examination of data collected during previous fluid-failure tests on aircraft could provide supplementary information on the equivalence of failure times on wings and the proposed test protocol.

5.1.2 Effect of Fuel Loads on the Proposed Test Protocol

Results of tests conducted on a cold-soak box empty, partially (40%) filled and completely filled, and tests conducted on the JetStar test wing with various fuel loads, showed that partial fuel loads (not touching the inner side of the top wing skin) do not noticeably affect the surface cooling rate.

Because fuel loads are never in contact with the inner side of wing leading edge surfaces (which have been proposed as the critical surface to be represented in tests), it can be concluded that fuel loads do not influence leading edge cooling rates.

5.1.3 Consideration of Cold-Soaked Wing Conditions

A concern exists that the wing top surface might be more critical than the leading edge for cases of tankered-fuel loads that are cold-soaked. In these situations, the fuel might be in contact with the upper wing skin, and the heat from the applied fluid might be dissipated quickly into the

heat-sink that consists of fuel and wing-skin. The colder upper wing surface could then experience fluid failure before the leading edge.

Currently, the holdover tables address only the *rain on cold soaked wing* condition at temperatures above 0°C. Consideration should be given to extending this to *snow on cold-soaked wings* at temperatures below freezing.

5.2 Test Procedure for Laboratory Trials

It was concluded that the temperature profile produced by the current Type I test procedure on the standard flat plate in calm laboratory conditions provided a sufficiently accurate representation of the temperature decay rate demonstrated by wings in natural outdoor conditions.

The fluid temperature should be 20°C with an acceptance range of + 2°C and 0°C, and the fluid quantity should remain at 1.0 L.

The method of applying fluid should be modified to be the same as described for outdoor trials.

5.3 Selection of Temperature Ranges for SAE HOT Guidelines

It was concluded that the current wide temperature range from 0°C to -10°C in the SAE holdover time guidelines incurs significant operational penalties, as short holdover times throughout the range are imposed by the lower limit (-10°C).

A range with -3°C as its lower limit will have much longer holdover times than one with -10°C as the lower limit.

As well, data on snowfall distribution indicates that the current wide range, from 0°C to -10°C, could encompass up to 70% of all snowfall events. A finer split would better represent actual snowfall distribution by temperature.

5.4 JetStar Test Wing

Tests on the JetStar test wing showed that the rate of cooling on the leading edge was much faster than for other aircraft tested. During the first 4 minutes after fluid application, the temperature curve for the JetStar test

wing was the steepest of all types tested. The curve then took the shape of a flat line, ending with a temperature more typical of other wings.

This characteristic of the JetStar test wing must be considered when using the wing for tests in which heat is an important factor.

6 RECOMMENDATIONS

It is recommended that:

1. Simultaneous trials on real wings and with the proposed test procedure for outdoor trials should be conducted early in the next winter season (2001–2002) to confirm that endurance times are representative.
2. The offer of a Canadair RJ wing for test purposes should be acted upon, readying the wing for outdoor tests with a target of December 2001.
3. Data from previous fluid failure trials on aircraft should be examined to provide supplementary information on equivalence of failure times between wings and test surfaces.
4. The procedures for indoor and outdoor testing should be documented and submitted for approval.
5. The SAE guidelines for Type I fluid holdover times should be evaluated to incorporate finer temperature ranges. Based on the evaluation, recommendations should be made to the SAE G-12 HOT Subcommittee.
6. Consideration should be given to extending holdover times for *rain on cold-soaked wings* to include *snow on cold soaked wings* at temperatures below freezing.
7. Type I fluid outdoor testing should be conducted in the next winter season (2001-2002) using the new test procedure at the new proposed temperature ranges.
8. A test protocol should be developed to measure endurance times of heated Type II and Type IV fluids diluted to 75/25 and 50/50 concentrations, used in a one-step deicing/anti-icing process.
9. The rate of dilution of applied Type I fluid should be documented at various precipitation rates, to support a better understanding of the influence of initial fluid strength on fluid endurance times.

This page intentionally left blank.

REFERENCES

1. Dawson, P., D'Avirro, J., *Hot Water De-icing Trials for the 1994-1995 Winter*, APS Aviation Inc., Montreal, December 1995, Transportation Development Centre report, TP 12653E, 48.
2. Dawson, P., Hanna, M., *Hot Water Deicing of Aircraft*, APS Aviation Inc., Montreal, October 1999, Transportation Development Centre report, TP 13483E, 92.
3. Dawson, P., Hanna, M., Chaput, M., *Aircraft Deicing Fluid Freeze Point Buffer Requirements: Deicing Only and First Step of Two-Step Deicing*, APS Aviation Inc., Montreal, December 1998, Transportation Development Centre report, TP 13315E, 168.
4. Dawson, P., Hanna, M., Chaput, M., Peters, A., Blais, N., *Aircraft Deicing Fluid Freeze Point Buffer Requirements for Deicing Only Conditions*, APS Aviation Inc., Montreal, October 1999, Transportation Development Centre report, TP 13478E, 176.
5. Dawson, P., D'Avirro, J., *Validation of Methodology for Simulating a Cold-Soaked Wing*, APS Aviation Inc., Montreal, October 1996, Transport Canada report, TP 12899E, 92.
6. Singh, K. Romi, *Aircraft Ground Operations in Canadian Winter Weather: Taxi Times, Wing Temperatures and Hot De-Icing*, Aviation Research Corporation, Montreal, April 1996, Transport Canada report, TP 12735E, 128.
7. D'Avirro, J., Chaput, M., Dawson, P., Hanna, M., Fleming, S., *Aircraft Full-Scale Test Program for the 1996/97 Winter*, APS Aviation Inc., Montreal, December 1997, Transport Canada report, TP 13130E, 180.

This page intentionally left blank.

APPENDIX A

Terms of Reference – Project Description

**EXCERPT FROM
TRANSPORTATION DEVELOPMENT CENTRE
WORK STATEMENT
DC 187
AIRCRAFT & ANTI-ICING FLUID WINTER TESTING
2000 -2001
(January 2001)**

5.2 Type I Holdover Time Test Protocol

The 1999-2000 winter series of endurance time trials on SAE Type I fluids resulted in recommended holdover times for snow which were significantly shorter than those previously published, and which have been used without incident since their implementation. It is generally believed that the reduction in endurance times is due to the test methodology, which does not take advantage of the implicit effect of heat transfer from the heated fluid to the surface. The objective is to develop a protocol for testing Type I fluids that reflects real field operations, not only by giving consideration to the effect of heat on endurance times, but also by selecting a test unit that is thermodynamically similar to real wings.

To achieve this objective, several steps are proposed:

- a) Review existing test data from various reports related to thermodynamic properties and endurance times measured on real wings and test units;
- b) Conduct initial trials on current test units;
- c) Define those parameters that must be included in a test protocol;
- d) Select and fabricate a test unit;
- e) Confirm through laboratory testing that the proposed test unit behaves thermodynamically, as required;
- f) Draft a test protocol;
- g) Confirm the validity of the protocol and fine-tune it through a series of tests run in parallel with a real wing in natural outdoor deicing conditions;
- h) Refine the findings through additional laboratory tests;
- i) Conduct HOT trials on Type I fluids with the New Test Protocol;
- j) Perform analysis;
- k) Prepare report; and
- l) Present at SAE G-12 Annual Meeting in May 2001.

The detail of these steps follows.

- 5.2.1 Conduct an initial review of previous test data published in various reports. The reports for review were written by APS, Aviation Research Corporation (ARC), and United Airlines (UA). The type of data and information related to deicing with heated fluid include the following:
- Wing and cold-soak box thermal time constants;
 - Wing skin and various test unit temperature profiles following application of heated fluid recorded in hot water and *deicing only* trials. This would include a review of the influence of:
 - fluid temperature, quantity, and method of application
 - wind
 - removal of existing contamination
 - Influence of heat on fluid freeze point profile;
 - Measured temperatures of wing surfaces relative to ambient;
 - Distribution of typical failure patterns on wing surfaces from APS and UA studies; and
 - Comparison of fluid endurance times on test units and wings of operational aircraft.
- Review the parameters in the FAA, United Airlines and TDC proposals
- 5.2.2 Conduct initial trials on current test units. Three days of testing in a laboratory are proposed. These tests will be conducted in conjunction with planned HOT trials and will involve:
- Conducting trials on plates and cold-soaked boxes during Octagon fluid trials;
 - Measuring surface temperature profiles with boxes filled to various depths; and
 - Adapting the existing box with fins (top to bottom surface).
- 5.2.3 Define test parameters and document and quantify those parameters required for a suitable test methodology. These would potentially include:
- Box/Plate configuration;
 - Nature of fluid in box:
 - Type of fluid
 - Temperature
 - Quantity (fixed or variable)
 - Starting temperature of the test unit;
 - Test fluid;
 - Temperature;
 - Quantity; and
 - Method of application, including clean or contaminated surface.
- 5.2.4 Review the recommendations for test parameters with TDC, FAA and other parties as required.
- 5.2.5 Select and fabricate a test unit. Based on an understanding of the test requirements; fabricate prototype test units for evaluation:

- Design the test unit to operate within the NCAR snowmaker;
 - Calculate the physical mass required in the test unit structure in order to produce the desired thermal mass and conductivity and surface temperature profile; and
 - Fabricate 2 to 3 alternative prototype test units for evaluation.
- 5.2.6 Conduct laboratory tests to evaluate the thermal behaviour of the selected test units. A total of five days (two sessions) of testing in a laboratory are proposed to evaluate the thermal behaviour of the selected test unit. The initial three-day session will be conducted prior to writing the first draft of the test protocol, and the second session (if still required) will follow the field tests on aircraft wings. Activities will include test planning and co-ordination, and the conduct of the tests.
- 5.2.7 Evaluate the performance of the alternative test unit prototypes in a controlled laboratory environment:
- Measure time constants;
 - Evaluate the fabricated test units against a range of values for the parameters in (Subsection 5.2.4) to define surface temperature profiles; and
 - Based on findings and known information on Fluid Freeze Point (FFP) profiles for various conditions, predict values for HOT.
- 5.2.8 Review the results with TDC, the FAA and other parties as required.
- 5.2.9 Draft a test protocol; prepare a documented description of the parameter values and the procedures for testing with the new test unit; include a description of the construction of the selected test unit.
- 5.2.10 Validate test protocol through tests on aircraft wings in natural deicing conditions and conduct comparative tests with an operational wing outdoors during natural snowfall. Activities include test planning and co-ordination, and conduct of tests.
- Develop test methodology;
 - Prepare for tests;
 - Schedule tests based on forecast weather conditions;
 - Fabricate sufficient additional new test units for testing;
 - Mount a new test unit on wing for spraying by deicing operator;
 - The contractor, with the co-operation of the Transportation Development Centre, will arrange for aircraft to conduct full-scale tests on wings as follows (aircraft will be tested with wing leading edge into the wind):
 - 3 test sessions: operating aircraft including at least one hard wing and one with leading-edge slats
 - conduct simultaneous tests on the test wing if it is ready and does not constrain aircraft tests
 - Document fuel condition (amount and temperature);
 - Conduct simultaneous trials using the new protocol on the new test unit and the previous protocol with the standard test

- unit. These units will be mounted on a test stand located near the wing (facing into the wind);
 - Compare fluid endurance results seen on the wing to the results on the new test unit, both on wing and on test stand;
 - Document patterns of failure on the wing;
 - Measure FFP profiles on all surfaces tested;
 - Record and compare surface temperature profiles for areas of interest on the wing, and on all test units; and
 - Document the conduct and results of all tests and the application of the new test protocol through photography and video.
- 5.2.11 Provide a test team of 10 members. Their responsibilities will include the co-ordination, test stand observation, meteo observation, photo and video recording, wing observation and instrumentation.
- 5.2.12 Refine findings through additional laboratory tests: adjust test protocol parameter values to better reflect the results observed on wing as needed.
- 5.2.13 Conduct HOT trials using the Type I fluids tested in the Winter Season 1999-2000, by testing at a limited number of selected conditions following the first field test session on aircraft.
- 5.2.14 Analyze the results of hot trials.
- 5.2.15 Prepare report including a summary of findings from the literature and data review giving attention to the role that heat plays in the deicing process. The basis of decision-making in developing the new protocol and selecting the new test unit will be documented. The results of laboratory and field trials, and of HOT trials conducted on the new surfaces, will be included in the report.
- 5.2.16 Present new Type I test protocol at SAE G-12 annual meeting in May 2001.

APPENDIX B

Development of Type I Protocol Wing Leading Edge Temperature Profiles

BM3833

**DEVELOPMENT OF TYPE I PROTOCOL
WING LEADING EDGE
TEMPERATURE PROFILES**

Winter 2000/2001

Prepared for

**Transportation Development Centre
Transport Canada**

Prepared by: Peter Dawson

Reviewed by: John D'Avirro



25 January 2001
Version 1.0

**DEVELOPMENT OF TYPE I PROTOCOL
WING LEADING EDGE
TEMPERATURE PROFILES**

Version 1.0
12 January 2001

1. OBJECTIVES

The objective of this procedure is to document temperature profiles for a variety of aircraft wings, for comparison to the temperature profile produced by proposed surfaces for testing Type I fluids.

These tests will be conducted at Pearson International Airport, Toronto.

2. PROCEDURE

These trials will be conducted on aircraft parked overnight at the passenger terminal.

Two sets of thermistor probes and data loggers will be used. Six probes will be installed on the wing, leaving one free logger channel to record a test surface temperature. A team of two will attach a set of thermistor probes to the leading edge of a selected aircraft type, and then move to a second aircraft to attach the second set. This team will be supported by the Air Canada high-lift pickup truck, to enable reaching the leading edge.

A separate team will conduct the temperature logging. This team will be accompanied by an Air Canada spray vehicle. A test surface will be placed on the portable test stand situated near the wing but clear of the deicing vehicle, and treated with heated fluid according to the test procedure. The wing leading edge and forward part of the wing will be sprayed to simulate a snow removal operation. At the same time, the heated fluid will be applied to the test surface. Wind speed and OAT will be measured at the stand.

The collected data will be the temperature profile of the wing leading edge and the test surface, OAT and wind speed and direction.

3. EQUIPMENT AND FLUIDS

3.1 Equipment

See list Attachment 1

ATTACHMENT 1

**EQUIPMENT CHECKLIST
LEADING EDGE TEMPERATURE PROFILES**

TEST EQUIPMENT	RESPONSIBLE	STATUS
Thermistor kit:2 loggers, at least 16 probes with extensions, 3M speed tape, PC/logger linking cables		
Isopropyl alcohol and wiping rags		
Paint dryer		
Wing forms		
Measuring tape		
Laptop PC X 2		
12vDC/110v60cycle converter for PC		
Containers for fluid preparation		
Vacuum containers		
Brixometer		
Anemometer with spare batteries		
Air thermometer		
Fluid temperature probe with spare batteries		
Fluid spreaders X 2		
Measuring container for 0.5 litre		
Portable stand		
CFIMS test surface, insulated		
Digital Camera		
AA batteries for digital camera		
Flashlights		
Clipboards and pencils		
Small generator		
Fuel		
Extension cords X 2 long & 1 short		
Surface temperature probes X 2		

ATTACHMENT 2

TEST TEAM TASKS

Probe Installation Team

- Participate in discussions with Air Canada team to identify sequence of testing and aircraft locations
- Assist in setting up portable stand with thermistor-equipped plate.
- Assist in preparing fluids for plate pouring.
- When advised, proceed with installing thermistor probes on designated aircraft. Air Canada will provide a pick-up truck with installed scissor-lift to reach leading edge for installation and removal.
- Test to confirm all probes are logging. Leave probe position #7 for plate probe.
- When second set of probes has been installed, return to aircraft # 1 to remove probes, and proceed to aircraft # 3 for installation. Follow this routine until end of test, as indicated on the Gantt chart. It is expected that five aircraft may be tested in this session.
- *Ensure that no trace of speed tape remains on wing surface!*

Temperature Logging Team

- Set up loggers.
- Take fluid from deicing truck, bring to correct temperature (62°C) and pour into vacuum containers for treating test plate.
- Record truck fluid temperature.
- For each test, record data required on data sheet. Retrieve fluid amount sprayed from truck operator.
- Advise sprayer when to spray.
- Apply fluid to plate with spreader when spray operation is underway.
- Backup data to PC following each aircraft test.
- At end of session ensure all data is saved, by displaying temperature curves on PC.

YYZ Trials

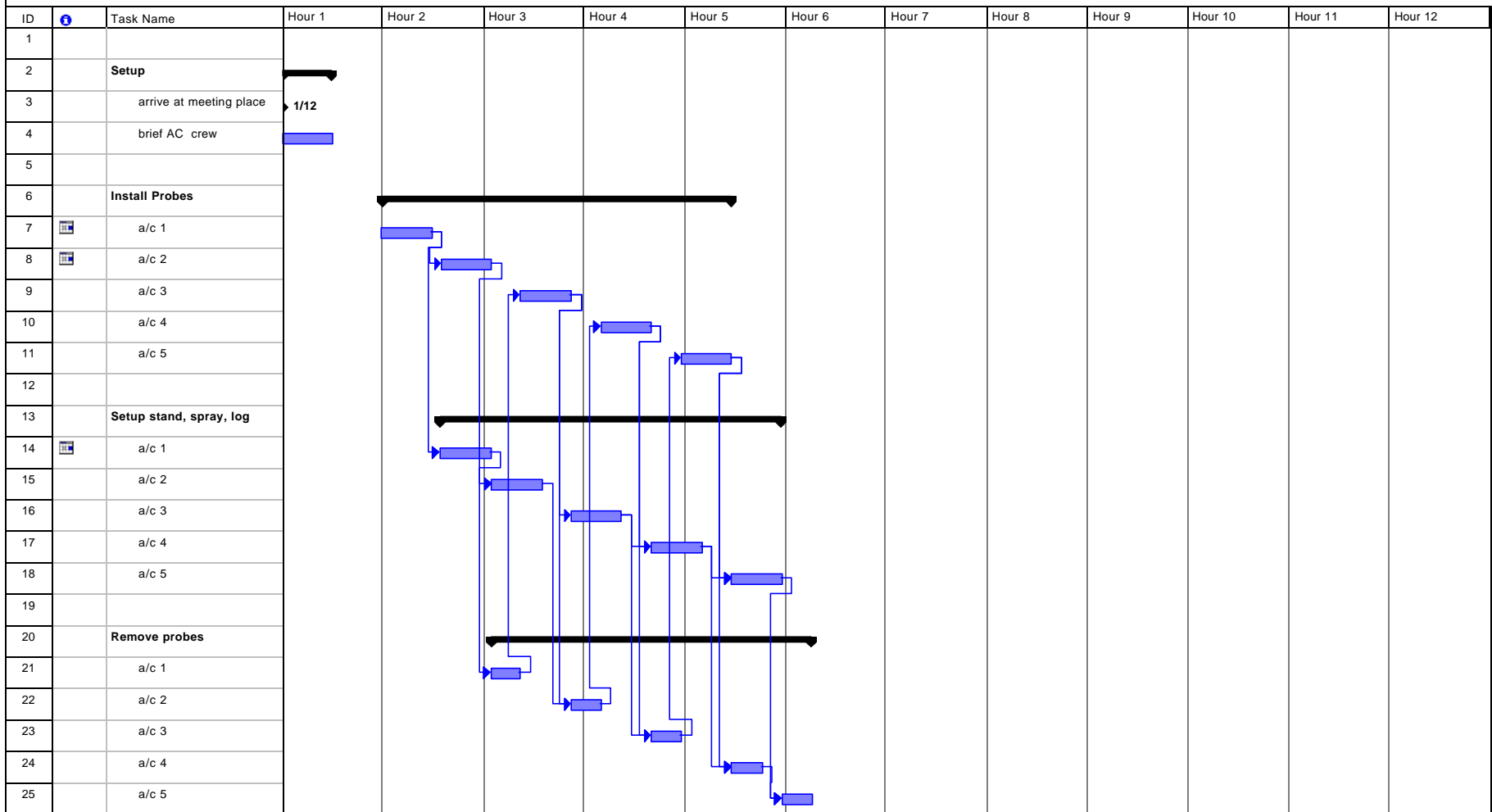

Project: Project1
Date: Fri 5/31/02

Task		Milestone		Rolled Up Split		External Tasks	
Split		Summary		Rolled Up Milestone		Project Summary	
Progress		Rolled Up Task		Rolled Up Progress			

Arrangements for YYZ Test

Expect to meet with YYZ contact about 2200h 25Jan

Our contact will be Andy or Mike – ph 905 676-2452

Where to go?

- Drive toward T2, beside parking garage, stay in right lane marked ***busses and taxis***
- Take lane on the right marked ***deliveries***
- Arrive at security gate (across from Air Ontario)
- Call from there. Deicing office is close by.
- They will have security passes

Note: Lou Grenier won't be there, but his cell phone is 416 436-1121

THERMISTOR LOCATION AND DATA FORM LEADING EDGE TEMPERATURE PROFILES

Location	Pearson International Airport – Terminal 2		
Truck Fluid temperature	_____ °C	Aircraft Fin #	_____
Time of Spray	_____	Fluid Amount Sprayed	_____
OAT at spray time	_____ °C	Wind at spray time	_____
Plate Fluid temperature	_____ °C	Fluid Amount Poured	_____

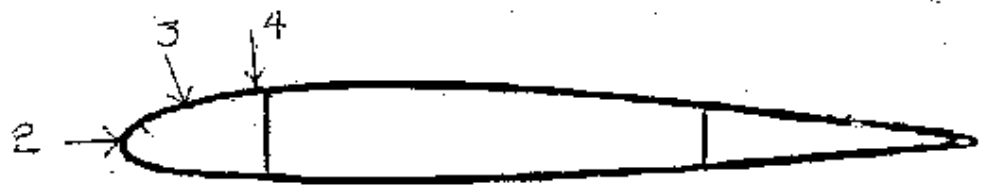
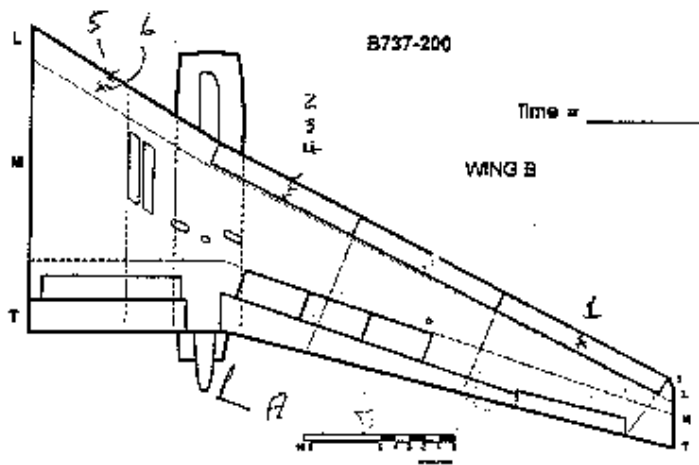
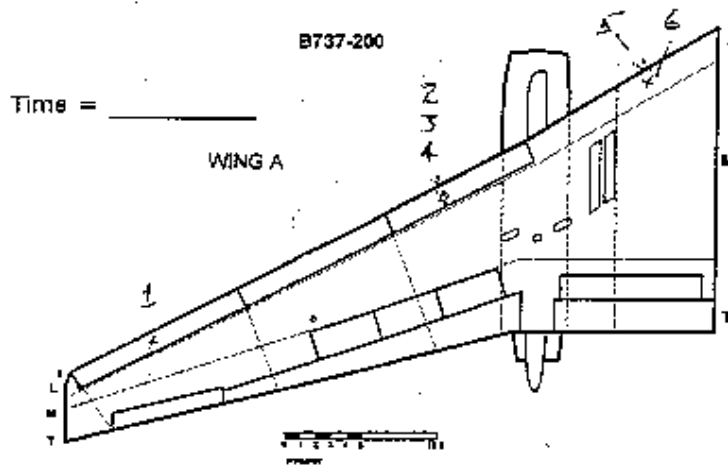

SECTION A-A

THERMISTOR LOCATION AND DATA FORM LEADING EDGE TEMPERATURE PROFILES

Location Pearson International Airport - Terminal 2
 Truck Fluid temperature _____ °C Aircraft Fin # _____
 Time of Spray _____ Fluid Amount Sprayed _____
 OAT at spray time _____ °C Wind at spray time _____
 Plate Fluid temperature _____ °C Fluid Amount Poured _____

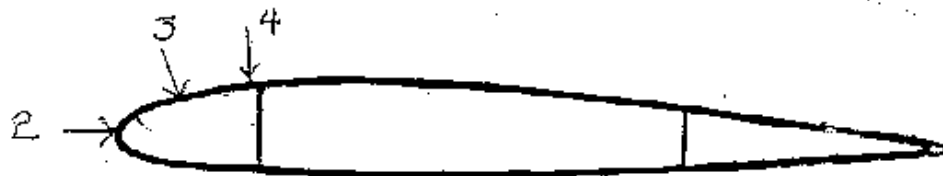
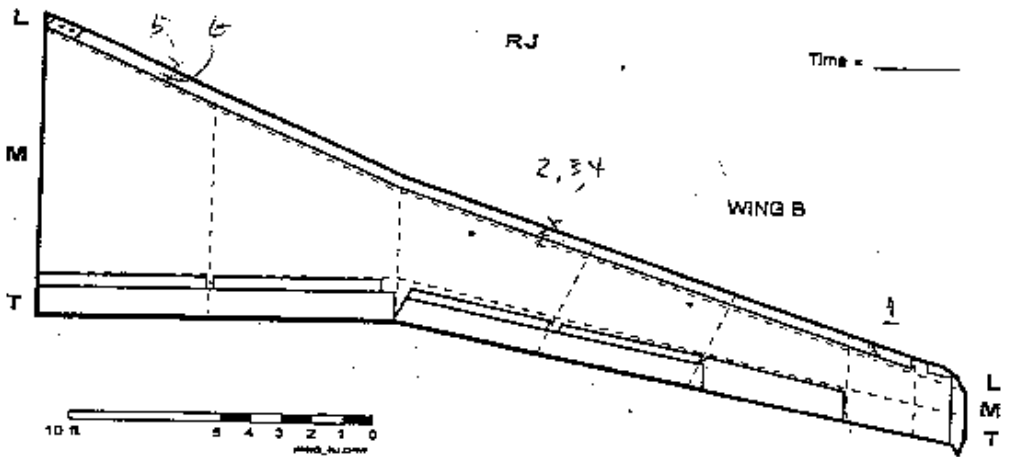
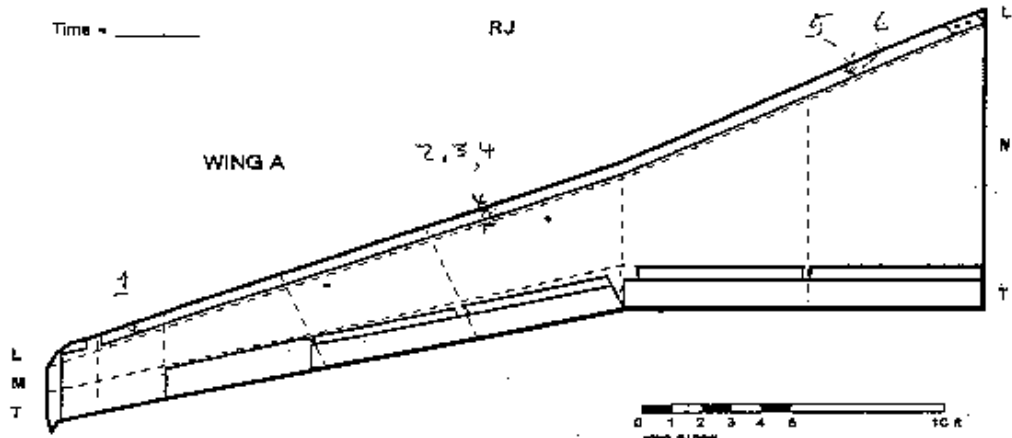

SECTION A-A

THERMISTOR LOCATION AND DATA FORM LEADING EDGE TEMPERATURE PROFILES

Location	Pearson International Airport – Terminal 2		
Truck Fluid temperature	_____ °C	Aircraft Fin #	_____
Time of Spray	_____	Fluid Amount Sprayed	_____
OAT at spray time	_____ °C	Wind at spray time	_____
Plate Fluid temperature	_____ °C	Fluid Amount Poured	_____

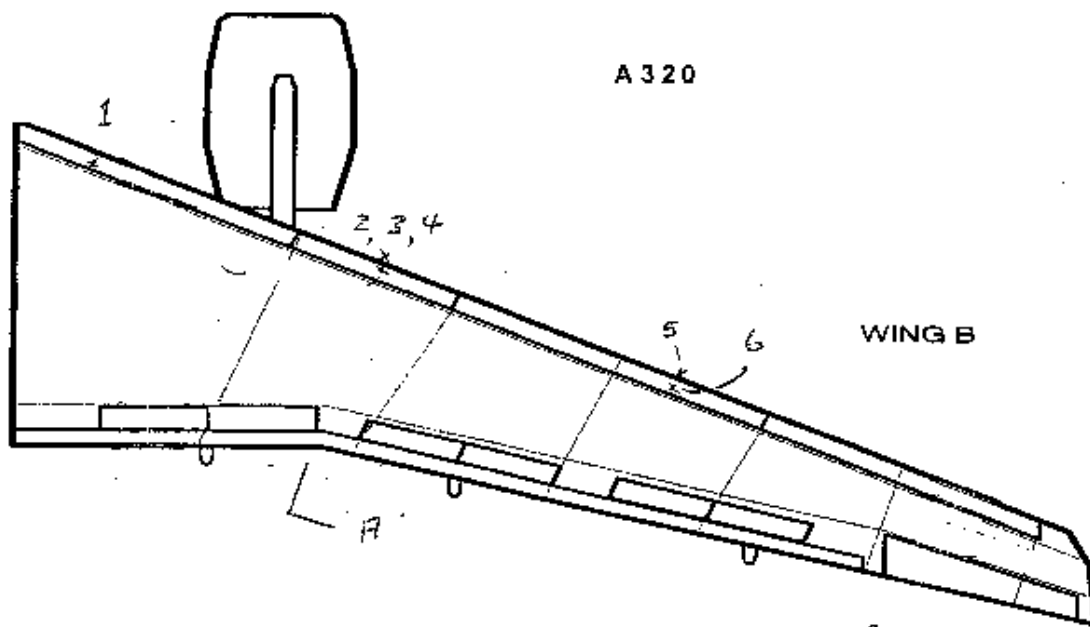

SECTION A-A

THERMISTOR LOCATION AND DATA FORM LEADING EDGE TEMPERATURE PROFILES

Location Pearson International Airport - Terminal 2
 Truck Fluid temperature _____ °C Aircraft Fin # _____
 Time of Spray _____ Fluid Amount Sprayed _____
 OAT at spray time _____ °C Wind at spray time _____
 Plate Fluid temperature _____ °C Fluid Amount Poured _____

Time = _____ DC-9 Series 30

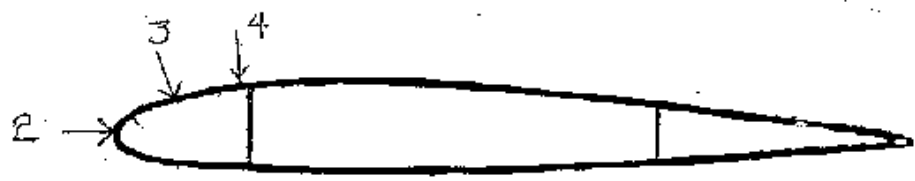
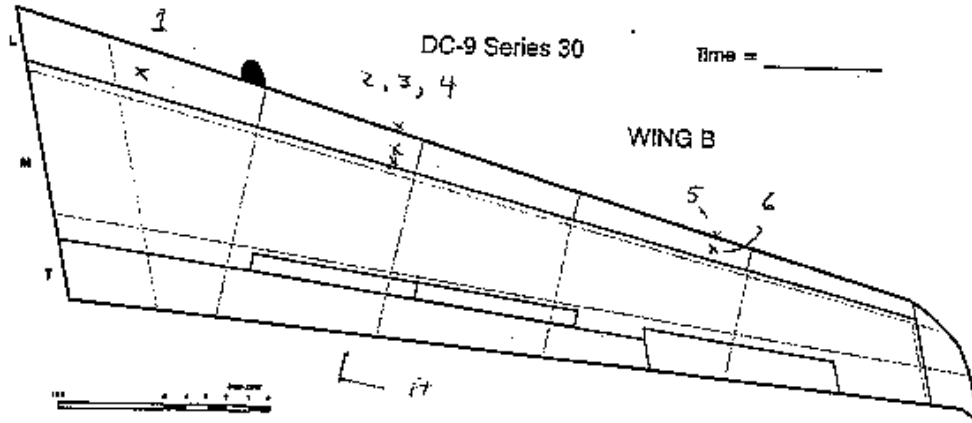
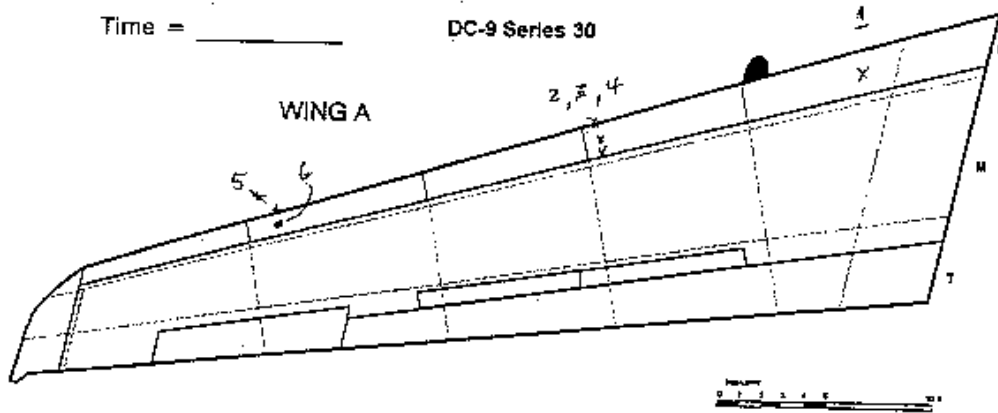

THERMISTOR LOCATION AND DATA FORM LEADING EDGE TEMPERATURE PROFILES

Location Pearson International Airport – Terminal 2

Truck Fluid temperature <u> </u> °C	Aircraft Fin # <u> </u>
Time of Spray <u> </u>	Fluid Amount Sprayed <u> </u>
OAT at spray time <u> </u> °C	Wind at spray time <u> </u>
Plate Fluid temperature <u> </u> °C	Fluid Amount Poured <u> </u>

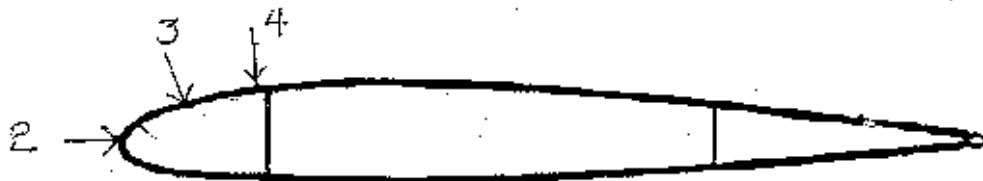
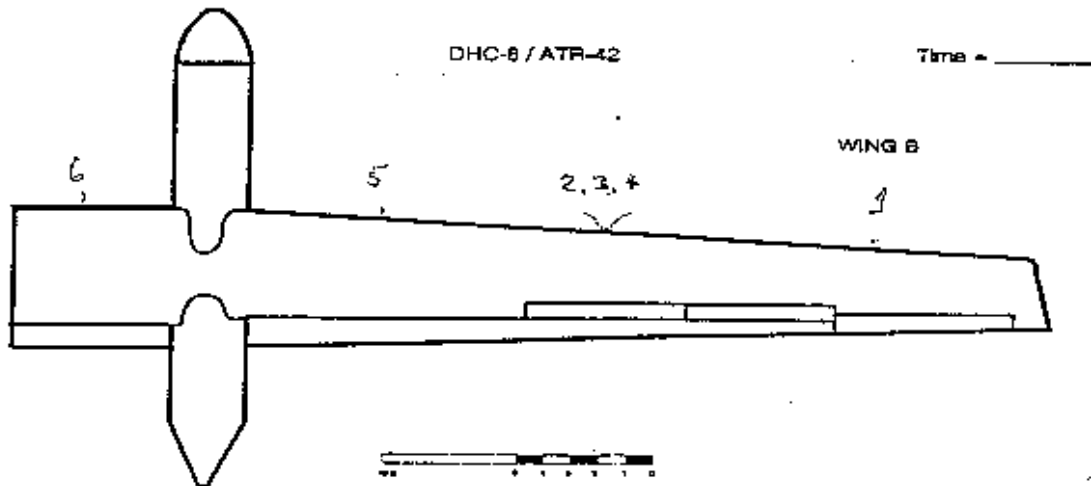
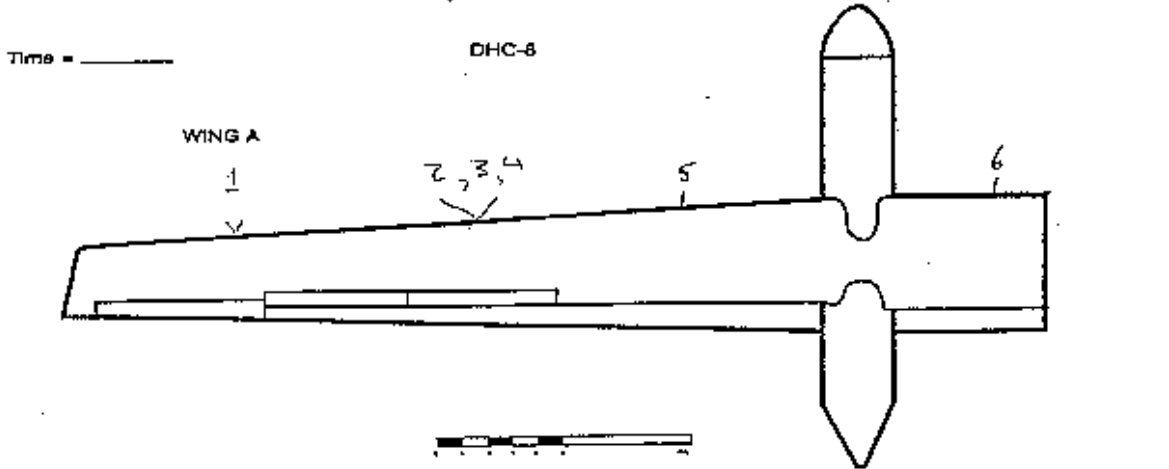

SECTION A-A

APPENDIX C

JetStar Test Wing Leading Edge Temperature Profile

BM3833

**JETSTAR TEST WING
LEADING EDGE TEMPERATURE PROFILES**

Winter 2000-2001

Prepared for

**Transportation Development Centre
Transport Canada**

Prepared by: Peter Dawson

Reviewed by: John D'Avirro



15 February 2001
Version 1.0

JETSTAR TEST WING LEADING EDGE TEMPERATURE PROFILES

1. OBJECTIVES

The objective of this procedure is to document temperature profiles for the JetStar test wing, for comparison to the temperature profile produced by candidate test surfaces for evaluating HOT for SAE Type I fluids.

These tests will be conducted at Ottawa International Airport under dry conditions, at night or during overcast conditions.

2. PROCEDURE

These trials will be conducted on the Jetstar test wing with various loads of simulated fuel. The initial test will be conducted with the wing empty. Following this test, the wing will be partially filled to 25% capacity with SAE Type I Ethylene glycol-based deicing fluid (at ambient temperature) to simulate a partial fuel load, and the temperature profile test will be repeated. This will be repeated with the wing filled to 50% capacity.

Thermistor probes will be installed on the wing according to positions shown in Figure 1.

A standard aluminium test surface and a coldsoak box (7.5 cm, empty) will be placed on the test stand situated near the wing but clear of the deicing vehicle, and treated with heated fluid according to the test procedure. The wing will be sprayed to simulate a snow removal operation. At the same time, the heated fluid will be applied to the test surfaces. Wind speed and OAT will be measured at the stand.

The collected data will be the temperature profiles of the wing and of the test surfaces, OAT and wind speed.

PROPOSED TEST MATRIX

Run	Wing Fuel Load	Test Wing Fluid Spray Temp (°C)	Test Box Fluid Pour Temp (°C)/L	Test Plate Fluid Pour Temp (°C)/L
1	Empty	80 in tank	60/0.5	20/1.0
2	25%	80 in tank	60/0.5	20/1.0
3	50%	80 in tank	60/0.5	20/1.0

3. EQUIPMENT AND FLUIDS

3.1 Equipment

See list Attachment 1

3.2 Fluids

The wing will be sprayed with SAE Type I fluid at standard strength, heated to 80°C in the truck tank.

The test surfaces will be treated with SAE Type I fluid at standard strength, heated as per the test matrix.

The simulated fuel will consist of SAE Type I fluid at standard strength, and at OAT.

4. PERSONNEL

Three APS personnel are required for these tests:

- Coordinator
- Thermistor data manager
- Plate tester

5. DATA FORMS

Figure 1 Thermistor probe locations for JetStar wing
Figure 2 General Form (Every Test)

ATTACHMENT 1

**EQUIPMENT CHECKLIST
LEADING EDGE TEMPERATURE PROFILES**

TEST EQUIPMENT	RESPONSIBLE	STATUS
Thermistor kit:2 loggers, at least 16 probes with extensions, 3M speed tape, PC/logger linking cables		
Isopropyl alcohol and wiping rags		
Paint dryer		
Wing forms		
Measuring tape		
Laptop PC X 2		
12vDC/110v60cycle converter for PC		
Containers for fluid preparation		
Vacuum containers		
Brixometer		
Anemometer with spare batteries		
Air thermometer		
Fluid temperature probe with spare batteries		
Fluid spreaders X 2		
Measuring container for 0.5 litre		
Stand for two test surfaces		
7.5cm coldsoak box, empty, std surface		
Digital Camera		
AA batteries for digital camera		
Flashlights		
Clipboards and pencils		
Small generator		
Fuel		
Extension cords X 2 long & 1 short		
Surface temperature probes X 2		
Step ladders X 2		

ATTACHMENT 2

SET-UP ACTIVITIES

- Make arrangements for spraying the wing during the test. The test will be done at an approved deicing location at the airport to facilitate sprayed fluid recovery.
- Make arrangements for fluid recovery.
- Make arrangements for loading fluid (at ambient temperature) into the wing during the test session.
- Make arrangements for towing the wing between the maintenance hangar and the deicing location.
- Make arrangements for security passes and escort as necessary.

ATTACHMENT 3

TEST TEAM TASKS

- Set up portable stand with thermistor-equipped plate.
- Install thermistor probes on test wing in accordance with Figure 1.
- Set up loggers and confirm that all probes are logging.
- Take fluid from deicing truck, bring to correct temperature and pour into vacuum containers for treating test plate.
- Record truck fluid temperature at the tank and from the nozzle.
- For each test, record data required on data sheet. Retrieve data on fluid amount sprayed from truck operator.
- Advise sprayer when to spray.
- Apply fluid to plate with spreader when spray operation is underway.
- Backup data to PC following each aircraft test.
- Assist in boarding simulated fuel load into wing.
- At end of session ensure all data is saved, by displaying temperature curves on PC.
- At end of test session, dismantle all equipment and assist in returning test wing to maintenance facility.

FIGURE 1
THERMISTOR PROBE LOCATIONS FOR JETSTAR WING
FIELD TRIALS FOR JETSTAR WING TEMPERATURE PROFILES

Thermistor Probes Mounting Locations

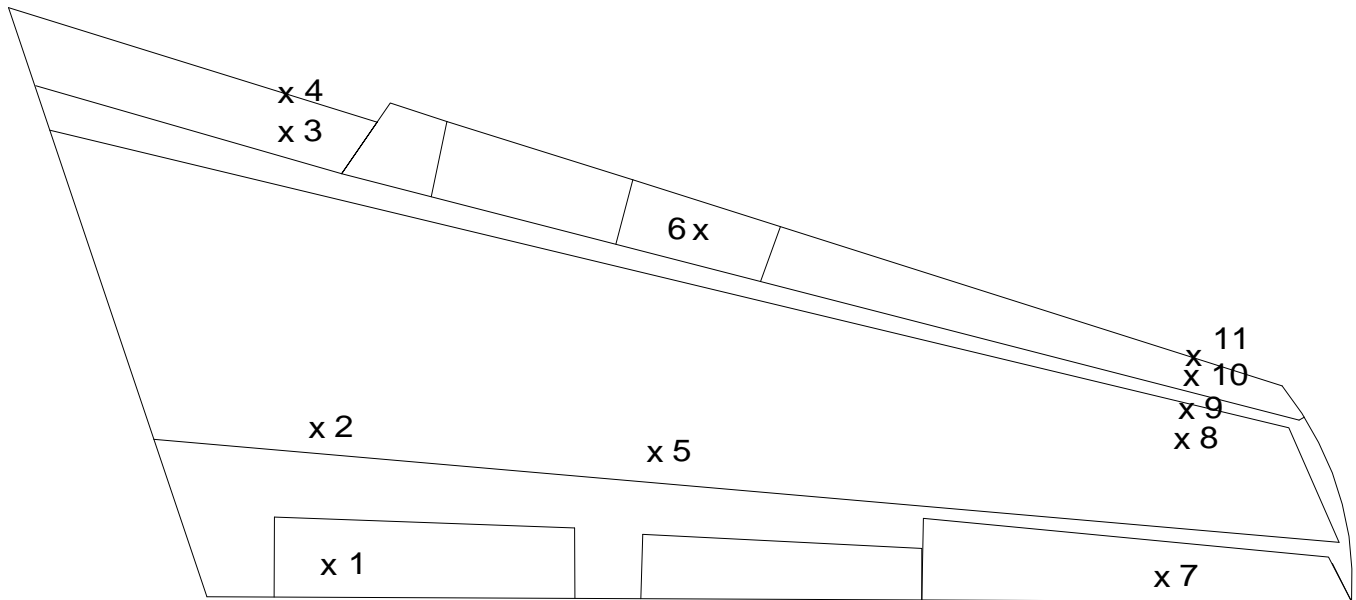

1. Mid-way forward on surface, 1/3 distance from inner end of surface
2. 15 cm forward from edge of main wing, in line between 1 and 4
3. Mid-way on LE, in line between 1 and 4
4. On LE nose, 1/4 distance from surface outer end
5. 15 cm forward from edge of mainwing
6. Mid-way chord wise and 1/2 way laterally
7. Mid-way chordwise, 1/3 distance from outer end
8. 30 cm back from edge of main wing in line with # 7
9. 15 cm back from edge of main wing in line with # 7
10. 1/2 way on LE, in line with # 7
11. On LE nose, in line with # 7

FIGURE 2
GENERAL FORM (EVERY TEST)
 FIELD TRIALS FOR JETSTAR WING TEMPERATURE PROFILES

DATE: _____

AIRCRAFT TYPE: ATR-42 F-100 B-737 RJ DHC-8

RUN #: _____

WING: PORT (A) STARBOARD (B)

AIRLINE: _____

DRAW DIRECTION OF WIND WRT WING:



FIN #: _____

TRUCK #: _____

TYPE I FLUID NOZZLE TYPE: _____

FUEL LOAD: _____ LB / KG

<i>FLUID APPLICATION</i>	
Actual Start Time: _____ am / pm	Actual End Time: _____ am / pm
Amount of Fluid Sprayed: _____ L / gal	Type of Fluid: _____
Fluid Temperature: Tank: _____ °C	Nozzle: _____ °C
Fluid Brix: _____	

COMMENTS:

MEASUREMENTS BY: _____

HANDWRITTEN BY: _____

APPENDIX D

Trials to Determine Surface Temperature Profiles

Development of Type I Protocol
TRIALS TO DETERMINE SURFACE TEMPERATURE PROFILES
Version 2.0
October 18, 2000

1. OBJECTIVES

The objective of this project is to develop a protocol for testing Type I fluids that reflects real field operations, not only by giving consideration to the effect of heat on endurance times, but also by selecting a test unit that is thermodynamically similar to the leading edge of wings.

This procedure was developed to conduct preliminary surface temperature trials. These tests will be scheduled at CRIQ while conducting tests with the NCAR snowmaker for Octagon to save on costs.

2. PROCEDURE (SET-UP)

0. Pretest on day before: freeze ice cores and bring fluid for boxes;
1. Mount 14 thermistors on 6 surfaces (2 per surface on top at 6" and 12" line, 1 on bottom surface of 7.5 cm box and other on bottom of 15 cm [13 L] box);
2. Ensure loggers are functional and labelled;
3. Fill boxes with 65%/35% propylene glycol;
4. Check that all thermistors are within 2°C; and
5. Set-up E-Mail on laptop for data transmission.

3. PROCEDURE (TEST)

1. Apply fluids on 6 surfaces (for spreader tests, keep spreaders at 20°C);
2. Monitor temperatures (8 seconds logging) until temperature decays to within 10% of original value (OAT); and
3. Start new test (See Test Plan).

4. EQUIPMENT

- Stand (6 plates);
- 6 surfaces as per test plan table;
- Thermistor kit
 - At least 14 thermistors
 - Software
 - Laptop
 - Loggers

- Spreaders X 6
- Type I fluid (10° buffer on -3°C [30 L], -14°C [18 L], -25°C [18 L]);
- Microwave;
- Measuring containers;
- Thermos X 12;
- Tarp to contain fluid within plywood containment;
- Heat gun;
- Aluminum tape;
- Temperature probe (Wahl); and
- Rubbing alcohol (Isopropyl); and
- 4 black clips from office (to secure plate).

5. DATA FORMS

Fill in test plan.

6. PERSONNEL

One technician required to run tests.

TABLE 1
TEST PLAN

Test #	Chamber Temp. (°C)	Surface	Fluid Amt. (L)	Fluid Temp. (°C)	Type of Appl.	Day/Time	Approx start time/date	Data File Nname (Use test # for name)	Comments
1	-3	std plt-p1	0.5	60	Spreader	D1 10-12			
2	-3	C/FIMS plt-p2	0.5	60	Spreader	D1 10-12			
3	-3	7.5 cm bx-4l-p3	0.5	60	Spreader	D1 10-12			
4	-3	15 cm bx-7l-p4	0.5	60	Spreader	D1 10-12			
5	-3	15 cm bx-13l-p5	0.5	60	Spreader	D1 10-12			
6	-3	15 cm bx+plt-13l-p6	0.5	60	Spreader	D1 10-12			
7	-3	std plt-p1	1	60	Spreader	D1 12-2			
8	-3	C/FIMS plt-p2	1	60	Spreader	D1 12-2			
9	-3	7.5 cm bx-4l-p3	1	60	Spreader	D1 12-2			
10	-3	15 cm bx-7l-p4	1	60	Spreader	D1 12-2			
11	-3	15 cm bx-13l-p5	1	60	Spreader	D1 12-2			
12	-3	15 cm bx+plt-13l-p6	1	60	Spreader	D1 12-2			
13	-3	std plt-p1	1	20	Pour	D1 12-2			
14	-3	std plt-p1	0.5	70	Spreader	D1 2-4			
15	-3	C/FIMS plt-p2	0.5	70	Spreader	D1 2-4			
16	-3	7.5 cm bx-4l-p3	0.5	70	Spreader	D1 2-4			
17	-3	15 cm bx-7l-p4	0.5	70	Spreader	D1 2-4			
18	-3	15 cm bx-13l-p5	0.5	70	Spreader	D1 2-4			
19	-3	15 cm bx+plt-13l-p6	0.5	70	Spreader	D1 2-4			
20	-3	std plt-p1	1	20	Pour	D1 2-4			
21	-3	std plt-p1	1	70	Spreader	D3 9-11			
22	-3	C/FIMS plt-p2	1	70	Spreader	D3 9-11			
23	-3	7.5 cm bx-4l-p3	1	70	Spreader	D3 9-11			
24	-3	15 cm bx-7l-p4	1	70	Spreader	D3 9-11			
25	-3	15 cm bx-13l-p5	1	70	Spreader	D3 9-11			
26	-3	15 cm bx+plt-13l-p6	1	70	Spreader	D3 9-11			
27	-3	std plt-p1	0.5	60	Pour	D3 11-1			
28	-3	C/FIMS plt-p2	0.5	60	Pour	D3 11-1			
29	-3	7.5 cm bx-4l-p3	0.5	60	Pour	D3 11-1			
30	-3	15 cm bx-7l-p4	0.5	60	Pour	D3 11-1			
31	-3	15 cm bx-13l-p5	0.5	60	Pour	D3 11-1			
32	-3	15 cm bx+plt-13l-p6	0.5	60	Pour	D3 11-1			
33	-3	std plt-p1	0.5	60	Spreader	D3 1-2			repeat of 1-6
34	-3	C/FIMS plt-p2	0.5	60	Spreader	D3 1-2			repeat of 1-6
35	-3	7.5 cm bx-4l-p3	0.5	60	Spreader	D3 1-2			repeat of 1-6
36	-3	15 cm bx-7l-p4	0.5	60	Spreader	D3 1-2			repeat of 1-6
37	-3	15 cm bx-13l-p5	0.5	60	Spreader	D3 1-2			repeat of 1-6
38	-3	15 cm bx+plt-13l-p6	0.5	60	Spreader	D3 1-2			repeat of 1-6
39	-3	std plt-p1	0.5	60	Spreader	D3 2-3			repeat of 1-6
40	-3	C/FIMS plt-p2	0.5	60	Spreader	D3 2-3			repeat of 1-6
41	-3	7.5 cm bx-4l-p3	0.5	60	Spreader	D3 2-3			repeat of 1-6
42	-3	15 cm bx-7l-p4	0.5	60	Spreader	D3 2-3			repeat of 1-6
43	-3	15 cm bx-13l-p5	0.5	60	Spreader	D3 2-3			repeat of 1-6
44	-3	15 cm bx+plt-13l-p6	0.5	60	Spreader	D3 2-3			repeat of 1-6

**TABLE 1
TEST PLAN**

Test #	Chamber Temp. (°C)	Surface	Fluid Amt. (L)	Fluid Temp. (°C)	Type of Appl.	Day/Time	Approx start time/date	Data File Nname (Use test # for name)	Comments
45	-25	std plt-p1	0.5	60	Spreader	D2 9-10			
46	-25	C/FIMS plt-p2	0.5	60	Spreader	D2 9-10			
47	-25	7.5 cm bx-4l-p3	0.5	60	Spreader	D2 9-10			
48	-25	15 cm bx-7l-p4	0.5	60	Spreader	D2 9-10			
49	-25	15 cm bx-13l-p5	0.5	60	Spreader	D2 9-10			
50	-25	15 cm bx+plt-13l-p6	0.5	60	Spreader	D2 9-10			
51	-25	<i>std plt-p1</i>	<i>1</i>	<i>20</i>	<i>Pour</i>	<i>D1 9-10</i>			
52	-25	std plt-p1	1	60	Spreader	D2 10-11			
53	-25	C/FIMS plt-p2	1	60	Spreader	D2 10-11			
54	-25	7.5 cm bx-4l-p3	1	60	Spreader	D2 10-11			
55	-25	15 cm bx-7l-p4	1	60	Spreader	D2 10-11			
56	-25	15 cm bx-13l-p5	1	60	Spreader	D2 10-11			
57	-25	15 cm bx+plt-13l-p6	1	60	Spreader	D2 10-11			
58	-25	std plt-p1	1	70	Spreader	D2 11-12			
59	-25	C/FIMS plt-p2	1	70	Spreader	D2 11-12			
60	-25	7.5 cm bx-4l-p3	1	70	Spreader	D2 11-12			
61	-25	15 cm bx-7l-p4	1	70	Spreader	D2 11-12			
62	-25	15 cm bx-13l-p5	1	70	Spreader	D2 11-12			
63	-25	15 cm bx+plt-13l-p6	1	70	Spreader	D2 11-12			
64	-25	<i>std plt-p1</i>	<i>1</i>	<i>20</i>	<i>Pour</i>	<i>D2 11-12</i>			
65	-14	std plt-p1	0.5	60	Spreader	D2 12-1			
66	-14	C/FIMS plt-p2	0.5	60	Spreader	D2 12-1			
67	-14	7.5 cm bx-4l-p3	0.5	60	Spreader	D2 12-1			
68	-14	15 cm bx-7l-p4	0.5	60	Spreader	D2 12-1			
69	-14	15 cm bx-13l-p5	0.5	60	Spreader	D2 12-1			
70	-14	15 cm bx+plt-13l-p6	0.5	60	Spreader	D2 12-1			
71	-14	<i>std plt-p1</i>	<i>1</i>	<i>20</i>	<i>Pour</i>	<i>D2 12-1</i>			
71	-14	std plt-p1	1	60	Spreader	D2 1-2			
72	-14	C/FIMS plt-p2	1	60	Spreader	D2 1-2			
73	-14	7.5 cm bx-4l-p3	1	60	Spreader	D2 1-2			
74	-14	15 cm bx-7l-p4	1	60	Spreader	D2 1-2			
75	-14	15 cm bx-13l-p5	1	60	Spreader	D2 1-2			
76	-14	15 cm bx+plt-13l-p6	1	60	Spreader	D2 1-2			
77	-14	std plt-p1	0.5	70	Spreader	D2 2-3			
78	-14	C/FIMS plt-p2	0.5	70	Spreader	D2 2-3			
79	-14	7.5 cm bx-4l-p3	0.5	70	Spreader	D2 2-3			
80	-14	15 cm bx-7l-p4	0.5	70	Spreader	D2 2-3			
81	-14	15 cm bx-13l-p5	0.5	70	Spreader	D2 2-3			
82	-14	15 cm bx+plt-13l-p6	0.5	70	Spreader	D2 2-3			
83	-14	<i>std plt-p1</i>	<i>1</i>	<i>20</i>	<i>Pour</i>	<i>D2 2-3</i>			
83	-14	std plt-p1	0.5	60	Pour	D2 3-4			
84	-14	C/FIMS plt-p2	0.5	60	Pour	D2 3-4			
85	-14	7.5 cm bx-4l-p3	0.5	60	Pour	D2 3-4			
86	-14	15 cm bx-7l-p4	0.5	60	Pour	D2 3-4			
87	-14	15 cm bx-13l-p5	0.5	60	Pour	D2 3-4			
88	-14	15 cm bx+plt-13l-p6	0.5	60	Pour	D2 3-4			

Enter Thermistor #s

Surface	6"	12"	Bottom
std plt-p1			
C/FIMS plt-p2			
7.5 cm bx-4l-p3			
15 cm bx-7l-p4			
15 cm bx-13l-p5			
15 cm bx+plt-13l-p6			

Note: If additional time is available, run tests on std. plate 1 using different pour technique (big vs small spout).

APPENDIX E

Preliminary Examination of Potential Test Surfaces in Wind

BM3833

**PRELIMINARY EXAMINATION
OF POTENTIAL TEST SURFACES IN WIND**

Winter 2000/2001

Prepared for

**Transportation Development Centre
Transport Canada**

Prepared by: Peter Dawson

Reviewed by: John D'Avirro



November 10, 2000
Version 1.0

Development of Type I Protocol
**PRELIMINARY EXAMINATION
OF POTENTIAL TEST SURFACES IN WIND**
Version 1.0
November 10, 2000

1. OBJECTIVES

The objective of this procedure is to document temperature profiles in wind conditions for various surfaces that potentially may serve as a test surface for Type I fluid HOT evaluation. Previous tests conducted in the CRIQ laboratory provided temperature profiles from a variety of potential surfaces in calm conditions. The temperature profiles resulting from the tests in wind will then be compared to temperature profiles developed from previous test data for aircraft wings.

These tests will be scheduled at the APS test site, Dorval.

2. PROCEDURE (SET-UP)

1. Prepare one example of each plate type (standard, CFIMS and 9.6 mm) with an insulated backing on the underside.
2. Mount thermistors on each surface at the 6" line and confirm operation. Certain plates require 2 thermistors as indicated in the test plan. Record the thermistor numbers related to each plate on the test plan;
3. Ensure loggers are functional and labelled;
4. Using a mix of 65%/35% propylene glycol, fill one 7.5 cm box completely taking care that it is entirely filled. Fill a second with 4 liters of the fluid mix. A third 7.5 cm box will be tested empty. Tag or mark each box to distinguish between them. At least a day prior to expected testing, set the boxes outdoors under the trailer or otherwise in the shade to allow the boxes and fluid to come to ambient temperature;
5. Set-up E-Mail on laptop for data transmission;
6. Prepare mix of Type I fluid (40 L) to a fluid freeze point of -15°C or low enough to prevent freezing on the surfaces;
7. Heat fluids to designated temperatures for testing.
8. Synchronize clocks with Environment Canada time.

3. PROCEDURE (TEST)

1. Record the wind speed at the stand every five minutes. Measure the wind speed by moving the handheld anemometer along the rear of the test stand, about 30 cm above the test surface, and taking an average wind speed.
2. Before and after each test run, measure and record the OAT using the Vaisala

meter.

3. Before each test on a cold-soaked box, first shake the box to stir the fluid then invert the box for a period long enough for the top surface to come to the same temperature as the interior fluid. Take care not to dislodge the thermistor probes. Take note of the surface temperature (which will be the temperature of the interior fluid) to ensure it is at OAT. Then place the boxes top-side-up at their stand positions and allow the temperature of the top surface to stabilize prior to pouring fluid.
4. Apply fluid at designated temperature on each surface (for spreader tests, keep spreaders at 20°C. If this cannot be done by keeping the spreaders in the trailer, then warm them prior to each test by pouring water heated to 20°C into the spreader and letting it drain just prior to test. As only one fluid mix is used in these tests, tests can be run in rapid succession on consecutive plates using the same spreader thereby avoiding the need to reheat the spreader.)
5. Monitor temperatures (8 seconds logging) until temperature decays to within 10% of original value (OAT).

4. EQUIPMENT

- Stand;
- 9 surfaces as per test plan table;
- Vaisala meter for OAT
- Anemometer for wind speed
- Thermistor kit
 - At least 14 thermistors
 - Software
 - Laptop
 - Loggers
- Spreaders
- Type I fluid mix (40 L);
- Microwave;
- Measuring containers;
- Thermos containers (14);
- Heat gun;
- Aluminum tape;
- Temperature probe (Wahl); and
- Rubbing alcohol (Isopropyl).

5. DATA FORMS

Fill in test plan.

6. PERSONNEL

Two technicians required to run tests.

Test Plan

OAT to be -5°C or lower
 Wind to be 15 km/h or greater
 Skies to be overcast (no sun) or nighttime

Test #	OAT (°C)		WIND (km/h)				Surface	Fluid Amt. (L)	Fluid Temp. (°C)	Type of Appl.	Start time/date	Data File Name (Use test # for name)	Comments
	Before	After	0	5	10	15							
1							std plt-insul-p2	0.5	60	Spreader			
2							C/FIMS plt-p3	0.5	60	Spreader			
3							C/FIMS plt-insul-p4	0.5	60	Spreader			
4							9.6 mm plate-p5	0.5	60	Spreader			
5							9.6 mm plate-insul-p6	0.5	60	Spreader			
6							7.5 cm bx-empty-p7	0.5	60	Spreader			
7							7.5 cm bx-4l-p8	0.5	60	Spreader			
8							7.5 cm bx-full-p9	0.5	60	Spreader			
9							<i>std plt-p1</i>	<i>1</i>	<i>20</i>	<i>Pour</i>			
10							std plt-insul-p2	1	60	Spreader			
11							C/FIMS plt-p3	1	60	Spreader			
12							C/FIMS plt-insul-p4	1	60	Spreader			
13							9.6 mm plate-p5	1	60	Spreader			
14							9.6 mm plate-insul-p6	1	60	Spreader			
15							7.5 cm bx-empty-p7	1	60	Spreader			
16							7.5 cm bx-4l-p8	1	60	Spreader			
17							7.5 cm bx-full-p9	1	60	Spreader			
18							<i>std plt-p1</i>	<i>1</i>	<i>20</i>	<i>Pour</i>			

Enter Thermistor #s

Std Plate Surface = 3.2 mm thick

C/FIMS Surface = 6.4 mm thick

9.6 mm plate = 9.6 mm thick

7.5 cm bx = 7.5 cm cold-soak box with 3.2 mm surface

Surface	6" Left	6" Right
std plt-p1		
std plt-insul-p2		
C/FIMS plt-p3		
C/FIMS plt-insul-p4		
9.6 mm plate-5		
9.6 mm plate-insul-p6		
7.5 cm bx-empty-p7		
7.5 cm bx-4l-p8		
7.5 cm bx-full-p9		

APPENDIX F

Experimental Program Evaluation of Fluid Endurance Times on Candidate Test Surfaces

BM3833.001

**EXPERIMENTAL PROGRAM
EVALUATION OF FLUID ENDURANCE TIMES ON CANDIDATE TEST SURFACES**

Winter 2001/2001

Prepared for

**Transportation Development Centre
Transport Canada**

Prepared by: Peter Dawson

Reviewed by: John D'Avirro

January 9, 2001
Version 1.0



EXPERIMENTAL PROGRAM
EVALUATION OF FLUID ENDURANCE TIMES ON CANDIDATE TEST SURFACES
 Winter 2000/2001

1. OBJECTIVES

To measure the effect on fluid endurance times, of proposed test surfaces and procedures.

This series of tests will be conducted in conjunction with scheduled HOT trials on SAE Type I fluid, and the fluid endurance times resulting from the candidate test surfaces and new procedures will be compared to times resulting from the current standard procedure.

2. PROCEDURE/TEST REQUIREMENTS

1. Follow standard procedures for HOT tests except as described in the following.
2. Prepare surfaces on stand, placed on the top row in accordance with the following table. Installed thermocouples will be used to log surface temperatures, rather than thermistor probes. Connect thermocouple leads as required and initiate logger. Ensure all surfaces are logging temperature. Make note of which logger channel represents which test surface.
3. Prepare fluid (Section 3.2) for testing. Each test run will require fluid as shown in the following:

STAND POSITION	SURFACE TYPE	FLUID		RATE SEQUENCE
		AMOUNT (L)	TEMP (°C)	
1	Rate Pan			
2	C/FIMS insulated	0.5	60	2 nd
3	C/FIMS insulated	1	60	3 rd
4	7.5 cm box (empty)	0.5	60	
5	Standard plate for HOT test	1	20	1 st
6	Std plate for BRIX msmt	0.5	60	

4. Pour required amount of heated fluid into thermos containers for application.
5. Apply fluid to the standard HOT surface according to the standard method. (clean the plate with scraper and squeegee, pour about 1/3 of the fluid over the plate, squeegee dry, and then pour the remainder of the fluid along the top edge.)
6. Apply fluid on candidate surfaces according to the table. First pour the fluid for the Brix measurement (position 6), which will serve to heat up the fluid spreader. Then treat the three candidate test surfaces in quick succession to avoid cooling of the spreader between pours. Use the following procedure for cleaning the surface and pouring fluid.

Clean the plate of all contamination with scraper and squeegee. Wet a clean wiper cloth with fluid at ambient temperature and wipe the plate over its entire surface. (This is intended to ensure that the surface is wetted as well as clean, to assist in complete coverage with the applied fluid.)

Standing behind the stand, place the shield device over the plate, and pour the test fluid from the thermos into the spreader. Remove the shield when the spreader has emptied.

7. Determine failure times on test surfaces, and record using standard HOT data forms (Attachment 1).
8. Conduct precipitation rate measures using the Meteo/Plate data form Attachment 3.

Record rates at specific times during the test.

- 1st following failure call of the standard HOT plate (position 5)
- 2nd following failure call of the C/FIMS surface treated with 0.5 L (position 2)
- 3rd following failure call of the C/FIMS surface treated with 1.0 L (position 3)

Use two rate pans in a staggered routine, exchanging one pan for the other at the time that a measurement is required.

Record wind speed at the test stand before and after each run. Measure wind speed by moving along the rear of the stand, with the anemometer held over the rear edge of the test surfaces at a 2 m height above ground.

9. If the lower row of the stand is not occupied by other tests, position a

second rate pan on that row at the end opposite to the top row rate pan. Use two rate pans in a staggered routine for this position as well.

10. Measure brix, every two minutes, on plate 6, at the 15 cm line. Record BRIX on the Fluid Brix data form. Stagger consecutive measured positions along the 15 cm line.
11. Synchronize computer and test clocks to atomic clock.

3. EQUIPMENT AND FLUIDS

3.1 Equipment

Candidate test surfaces used for these trials will be:

- Two C/FIMS plates with an insulated backing
- One 7.5 cm cold-soak box (empty)

A standard test plate will be also used as a reference test surface, with fluid applied in accordance with the existing standard test procedure.

These surfaces will be equipped with thermocouple probes.

A further standard test plate will serve as a surface for measuring progressive BRIX values. This surface need not be instrumented with thermocouples.

A wind shield/fluid spreader device will be used for applying fluids in the proposed test procedure.

A handheld anemometer is needed to measure wind speed at the test stand.

3.2 Fluids

Tests shall be conducted with Type I fluids undergoing HOT trials. Lyondell ARCO+ is suggested. Fluids are to be mixed to a freeze point 10°C below OAT.

Fluids to be applied to the candidate test surfaces will be heated to 60°C. Fluids for reference tests (standard HOT tests) will be heated to 20°C according to the standard procedure.

4. PERSONNEL

Three technicians:

- First calls failures, prepares fluid samples, checks logger.
- Second helps prepare and pour fluids, and measures brix.
- Third measures rates and wind.

5. DATA FORMS

Use end condition forms from standard HOT procedure (Attachment 1).

For brix measurements, see Attachment 2.

For rate measurements, see Attachment 3.

Attachment 1

REMEMBER TO SYNCHRONIZE TIME WITH AES - USE REAL TIME

END CONDITION DATA FORM

VERSION 6.0 Winter 1999/2000

LOCATION: _____ DATE: _____ RUN #: _____ STAND #: _____

CIRCLE SENSOR PLATE: u v w x y z

SENSOR NUMBER: _____

DIRECTION OF STAND: _____ °

OTHER COMMENTS (Fluid Batch, etc):

PRINT SIGN

FAILURES CALLED BY : _____

HAND WRITTEN BY : _____

TEST SITE LEADER : _____

*TIME (After Fluid Application) TO FAILURE FOR INDIVIDUAL CROSSHAIRS (hr:min)

Time of Fluid Application: _____ hr:min:ss _____ hr:min:ss _____ hr:min:ss

	Plate U	Plate V	Plate W
FLUID NAME			
B1 B2 B3	<input type="text"/>	<input type="text"/>	<input type="text"/>
C1 C2 C3	<input type="text"/>	<input type="text"/>	<input type="text"/>
D1 D2 D3	<input type="text"/>	<input type="text"/>	<input type="text"/>
E1 E2 E3	<input type="text"/>	<input type="text"/>	<input type="text"/>
F1 F2 F3	<input type="text"/>	<input type="text"/>	<input type="text"/>
TIME TO FIRST PLATE FAILURE WITHIN WORK AREA	<input type="text"/>	<input type="text"/>	<input type="text"/>
CALCULATED FAILURE TIME (MINUTES)	<input type="text"/>	<input type="text"/>	<input type="text"/>
BRIX / TEMPERATURE AT START	<input type="text"/>	<input type="text"/>	<input type="text"/>

Time of Fluid Application: _____ hr:min:ss _____ hr:min:ss _____ hr:min:ss

	Plate X	Plate Y	Plate Z
FLUID NAME			
B1 B2 B3	<input type="text"/>	<input type="text"/>	<input type="text"/>
C1 C2 C3	<input type="text"/>	<input type="text"/>	<input type="text"/>
D1 D2 D3	<input type="text"/>	<input type="text"/>	<input type="text"/>
E1 E2 E3	<input type="text"/>	<input type="text"/>	<input type="text"/>
F1 F2 F3	<input type="text"/>	<input type="text"/>	<input type="text"/>
TIME TO FIRST PLATE FAILURE WITHIN WORK AREA	<input type="text"/>	<input type="text"/>	<input type="text"/>
CALCULATED FAILURE TIME (MINUTES)	<input type="text"/>	<input type="text"/>	<input type="text"/>
BRIX / TEMPERATURE AT START	<input type="text"/>	<input type="text"/>	<input type="text"/>

**Attachment 2
FLUID BRUX TEST**

DATE: _____

PERFORMED BY: _____

RUN #: _____

WRITTEN BY: _____

STAND: _____

LOCATION: _____

BRUX					
Plate: Fluid:		Plate: Fluid:		Plate: Fluid:	
TIME	6" LINE	TIME	6" LINE	TIME	6" LINE

APPENDIX G

NRC Canada Trials for Type I HOT Test Protocol

BM3833.001

**EXPERIMENTAL PROGRAM
NRC CANADA TRIALS FOR TYPE I HOT TEST PROTOCOL**

Winter 2000-2001

Prepared for

**Transportation Development Centre
Transport Canada**

Prepared by: Peter Dawson

Reviewed by: John D'Avirro



March 1, 2001
Version 1.0

**EXPERIMENTAL PROGRAM
NRC CANADA TRIALS FOR TYPE I HOT TEST PROTOCOL
Winter 2000-2001**

1. OBJECTIVES

To confirm that fluid endurance times developed on candidate test surfaces using proposed test procedures are representative of fluid endurance times as experienced on aircraft wing surfaces under the same conditions.

Simultaneous trials on the Jetstar test wing and on test surfaces will be conducted in controlled laboratory conditions during artificial precipitation. Candidate test surfaces will be subjected to the same precipitation as the wing. The test surfaces will be treated with SAE Type I fluid according to proposed test procedures as well as the existing Type I test procedure. A designated area of the wing will be treated with fluid as described in procedures. At least one wing treatment will represent standard deicing procedures, wherein snow contamination will be removed by a heated fluid spray. Fluid endurance times and surface temperature profiles on the wing and the test surfaces will be measured and compared.

2. PROCEDURE/TEST REQUIREMENTS

A limited area of the test wing will be designated and marked as the test area for fluid-failure-on-wing tests. An overspray area will also be marked on the wing. In tests, fluid will be applied over the entire overspray area in order to input heat to the wing outside the test area boundaries and thereby reduce the lateral transfer of heat from the test area to the surrounding wing. The proposed test area is shown on Figure 1. Thermistor probes will be installed on the wing at locations within the test area and in the surrounding overspray area.

Laboratory conditions for the trials are:

- Snowfall at 25g/dm²/h
- OAT of -10°C
- Calm conditions

Two types of trials will be conducted on the wing;

- One type will incorporate the effect of the removal of contamination, by allowing snow to accumulate on the wing between test runs. The wing will then be sprayed to clean all snow from the test area, using the APS fluid sprayer. The spray operator, who will be instructed to spray according to standard procedure, will spray until the wing is cleaned.
- The second type of wing trial will involve first cleaning the snow from the

test and overspray area, and then applying heated fluid in a controlled, repeatable manner. A special fluid applicator built for this purpose will be used.

A proposed test matrix for wing and test surfaces is given in Table 1. The test matrix describes fluid strength and temperature for each trial run.

Trials on the candidate test surfaces will follow a procedure described later in this document. Thermistor probes will also be installed on the test surfaces.

Data collected in these trials will include:

- Fluid temperature, quantity applied and initial strength
- Ambient conditions
- Depth of contamination on wing at start of test
- Temperature profiles of wing and test surfaces
- Brix profile of fluid on wing and test surface
- Failure times on wing and test surfaces.

Previous field studies examining fluid failures on aircraft concluded that the wing leading edge and rear flight control surfaces are the earliest surfaces to experience fluid failure. Because contamination on the leading edge can severely degrade airfoil, wing and take-off performance, this study will give primary attention to fluid condition on the leading edge.

Attachment I provides a description of test procedures.

3. EQUIPMENT

A list of equipment is given in Attachment II.

4. FLUIDS

SAE Type I ethylene glycol-based fluid (UCAR ADF) will be used.

5. PERSONNEL

APS personnel required for these tests are as follows:

- wing observer
- brix sampler, wing and plates
- test surface observer
- meteo recorder
- photo/video

- equipment and deicing fluid manager
- coordinator.

Attachment III lists task assignments.

6. DATA FORMS

Figure 1	Jetstar Test Wing Dimensions
Figure 2	Test Area and Thermistor probe locations for Jetstar test wing
Figure 3	General Form (Every test)
Figure 4	Fluid Failure Form for for Jetstar test wing
Figure 5	Brix Form
Figure 6	End Condition Data Form
Figure 7	Meteo/Plate Pan Data Form

**TABLE 1
TEST PLAN
NRC CANADA TRIALS FOR TYPE I HOT TEST PROTOCOL**

Ambient temperature -10°C
 Precipitation – Snow at 25 g/dm²/hr
 Wind calm

R U N	TESTS ON WING				TESTS ON SURFACES				
					CANDIDATE SURFACES			STD HOT TEST	
	FLUID FREEZE POINT (°C)	FLUID TEMP (°C)	FLUID QT'Y (L/m ²)	SNOW DEPTH (cm)	FLUID FREEZE POINT (°C)	FLUID TEMP (°C)	FLUID QT'Y (L)	FLUID TEMP (°C)	FLUID QT'Y (L)
1a	-20	60	As sprayed	> 2.5	-20	60	.5-1	20	1.0
1b	-20	60	As sprayed	> 2.5	-20	60	.5-1	20	1.0
2a	-20	60	3.3	0	-20	60	.5-1	20	1.0
2b	-20	60	3.3	0	-20	60	.5-1	20	1.0
3	-20	40	3.3	0	-20	40	.5-1	20	1.0
4	-20	20	3.3	0	-20	20	.5-1	20	1.0
5	Std strength	60	3.3	0	-20	60	.5-1	20	1.0

Runs 1 and 2 will be repeated as shown. During the progress of testing, it may be decided to test other parameters in accordance with findings.

ATTACHMENT I

**TEST PROCEDURES
NRC CANADA TRIALS FOR TYPE I HOT TEST PROTOCOL**

PRE-TEST SETUP

- Establish ambient test temperature
- Synchronize all timepieces, loggers and cameras with atomic clock.
- Setup wing-fluid heating tanks.
- Setup fluid sprayer.
- Measure flow rate of sprayer.
- Position the test wing in the cold chamber.
- Mark the test area and overspray area on the wing with use of coloured tape.
- Install test surfaces at 10 degrees on stand beside wing. The stand positioning will be checked for precipitation rates equivalent to that measured on the wing test area, and may need to be relocated. If equivalent rates can not be established on the stand located beside the wing, as a last resort, test surfaces will be mounted on the wing using the surfaces designed for that purpose.
- Install thermistor probes on the wing as per Figure 2, and on test surfaces at the 15 cm (6 in) line.
- Set-up data logger; test thermistor probes for function. Ensure that logger channels are labeled with correct test surface and wing location.
- Set-up rate station.
- Set-up fluid preparation station for test surfaces.
- Ensure all cameras are functional.

TESTS ON WING

For Each Run

- Measure fluid Brix and temperature prior to application.
- Measure depth of snow coverage on wing prior to spray.
- Videotape entire fluid application from an appropriate vantage point.
- For spray tests, measure fluid temperature at nozzle, spraying away from wing. Spray enough to clear the lines of cold fluid. Deice the complete wing test and overspray area with test fluid, cleaning away all snow, and then apply a light overspray. Record amount of fluid applied by timing the spray interval and converting to volume based on flow rate.
- For tests using the fluid applicator, clean the snow from the wing with squeegees just prior to applying the fluid. Position the applicator at the leading edge to start application, and then move it in a steady movement to reach the rear of the overspray area in about 15 seconds. Practice application runs will be necessary to develop a repeatable technique.

Observe Time to Freeze

- Observe wing test area for first freezing and record on the wing form. Thereafter, record failure pattern of the entire test area when advised by the test surface observer at the following events:
 - at failure call of the standard HOT plate
 - at failure call of the standard 7.5 cm cold-soak box surface
 - when 10% of the leading edge area has failed
 - If the time interval between any of the failure events is longer than 5 minutes, make additional records of failure pattern. Depending on leading edge condition following all test surface failures, continue until the leading edge is at least 50% failed.
- Photograph and videotape the condition of the test area when the fluid failure patterns are being recorded.
- Measure fluid strength on the wing and test surfaces at the specified locations. Take measurements immediately after fluid application and then every two minutes during the test run and at test end. Ensure sampled locations are shifted each time to avoid repeat sampling at the same point. Protect the fluid sample from precipitation.

Prepare for Next Test

- Allow sufficient time for wing to cool to ambient temperature, and in the case of applying fluid by spraying, time for snow to re-form on wing surfaces (at least 2.5 cm deep).

TESTS ON CANDIDATE SURFACES

Setup

- Follow standard procedures for HOT tests except as described in the following.
- Candidate test surfaces are 7.5 cm cold-soak boxes, empty. The surface of one box is thickened with the addition of a 3.2 mm plate, attached with contact cement and rivets to ensure good contact. Fluid will be applied to these surfaces using the spreader.
- Install surfaces on the wing. Ensure all thermistor probes on surfaces are operating and logging.
- Prepare fluid for testing. Each test run will require fluid as shown in the following table.

SURFACE TYPE	FLUID		POUR SEQUENCE
	AMOUNT (L)	TEMP (°C)	
Std 7.5 cm box 3.2 mm surface	0.5	As per test matrix	2nd
7.5 cm box plus attached 3.2 mm plate	1.0	As per test matrix	1st
Standard plate for HOT test (3.2 mm surface)	1.0	20	3rd

- Pour required amount of heated fluid into thermos containers in preparation for application and keep in heated area along with the spreader until ready to pour.
- Protect the fluid spreader from cooling.

When wing application commences:

- Apply fluid on surfaces according to the above table.
- Treat box surfaces in quick succession to avoid cooling of the spreader between pours. Use the following procedure for cleaning the surface and pouring fluid:
 - Clean the surface of all contamination with scraper and squeegee. Apply a small amount of fluid at ambient temperature and squeegee the plate over its entire surface. This is intended to ensure that the surface is wetted as well as clean, to assist in complete coverage with the applied fluid.
- Apply fluid to the standard HOT surface according to the standard method. (clean the plate with scraper and squeegee, pour about 1/3 of the fluid over the plate, squeegee dry, and then pour the remainder of the

- fluid along the top edge.)
- Determine failure times on test surfaces, and record using standard HOT data forms. Record failure times in the surface divisions shown on the form.
 - Conduct precipitation rate measures using the Meteo/Plate data form. Use two rate pans for each rate position in a staggered routine, exchanging one pan for the other at the time that a measurement is required. Record rates at specific times during the test:
 - at failure call of the standard HOT plate
 - at failure call of the 7.5 cm cold-soak box with standard surface
 - at 10% failure call on the test area leading edge.
 - Measure brix, every two minutes, on the standard HOT plate surface and on the 7.5 cm cold-soak box with standard surface, at the 15 cm line. Record BRIX on the Fluid Brix data form. Stagger consecutive measured positions along the 15 cm line.

ATTACHMENT II
TEST EQUIPMENT CHECKLIST
NRC CANADA TRIALS FOR TYPE I HOT TEST PROTOCOL

TASK	STATUS
Logistics For Every Test	
Assign Personnel	
Rent cube van	
Rent personnel van	
Confirm hotel rooms	
Pick up fluid from Aéromag 2000	
Test Equipment	
Test procedures	
Data Forms	
Clipboards	
Pencils	
Paper towels	
Electrical extension cables	
Tools	
Brixometers X 2	
Scrapers and squeegees	
Wiper rags	
PC X 2 (1 laptop, 1 PC from office)	
Color printer from office	
Big clock (1)	
Wing Setup	
NRC Canada Stairs	
Stepladders X 4	
Markers, solvent and cloth wipers	
Tape measures X 4 (2 long, 2 short)	
Thermistor probes and cables	
Logger kits	
Speed Tape	
Heat gun	
Rubbing alcohol	
Thickness gauges	
Scale to measure snow depth	
Coloured plastic tape to mark test and overspray area.	
Tarpaulin for under-wing to catch fluid	
Wet-dry vacuum	
Containers for waste fluid	

Test Surface Setup	
Test stand (2 X 3 position or 6 position)	
Plates on legs: 2 standard and one large skirted	
Test surfaces: 7.5 cm cold-soak box (empty) X 2	
7.5 cm box (empty) with attached std (1.6 mm) plate	
7.5 cm box (empty) with attached std (3.2 mm) plate	
Standard plate for HOT test X2	
Inclinometer	
Fluid Preparation/Application	
Heating pots	
Hot plates	
Microwave	
Vacuum bottles and rack	
Fluid spreaders for plate and for box	
Fluid spreader for wing	
Type I fluid from AeroMag	
Fluid heaters (3 X 60 gal hot water tanks)	
Fluid temperature probe and spare batteries	
Type IV fluid sprayer	
Container for measuring sprayer flow rate	
Scale for measuring sprayer flow rate	
Rate Station	
Rate pans X 12	
Scale; 2 g accuracy	
Vaisala RH meter	
Wind gauge (from NRC Canada)	
Photo/Video	
Digital Video Camera	
Still Camera and film	
Video logging equipment for rate station	
Lighting for wing and stand	

ATTACHMENT III

RESPONSIBILITIES/DUTIES OF TEST PERSONNEL NRC CANADA TRIALS FOR TYPE I HOT TEST PROTOCOL

Team leader (1)

- Initiate test with NRC Canada, TDC, and FAA.
- Advise APS test team
- Ensure that all required equipment is available and functional.
- Brief all involved on test procedure and assignments.
- Ensure that all data are collected and saved, and that all test records are submitted.

Photo and Video (1)

- Videotape and photograph all test set-up. The record is to include location of thermistor probes on wing surface.
- Photograph and videotape:
 - Fluid application
 - Freezing pattern on wing test area at the times that the leading edge observer is recording failure patterns.

Wing Observer (1)

- install thermistor probes on wing.
- Assist in general set-up.
- Record time and location of first freezing on the wing leading edge form. Disregard any early freezing caused by Brix sampling.
- Record test area failure pattern when advised of surface failures by the test surface observer.
- Record test area failure pattern when the leading edge has failed to 10%.
- If the time interval between any above events is longer than 5 minutes, make additional records of failure pattern. Depending on leading edge condition following all test surface failures, continue recording failure patterns until the leading edge is at least 50% failed.
- Call attention of photographer to failed areas for recording.

Brix Sampler (1)

- records spray specifics and measures Brix on wing.
 - Complete the general form for every test, recording specifics on spray and snow depth on wing.
 - Record wing fluid temperature and Brix.
 - Record spray start and end times, and calculate amount of fluid applied. Estimate amount of overspray beyond the marked area.
- Measure Brix on test surfaces and wing at designated locations. Record on Brix Form. Commence taking measurements on the test surfaces

immediately after fluid application, and then sample at the wing locations. For the test surfaces, stagger consecutive measured positions along the 15 cm line. Circulate continuously between test surfaces and wing, with the objective of completing a circuit every two minutes. Ensure sampled locations are shifted each time to avoid repeat sampling at the same point. Protect the fluid sample from precipitation.

- Ensure all data forms completed and submitted at test end.
- Assist the fluid manager in preparing fluids, and applying on the wing.

Equipment and Deicing Fluid Manager X 1

- Prepare all equipment for transport to NRC Canada.
- Co-ordinate setting up major equipment.
- Oversee dismantling and orderly return of equipment.
- Prepare fluids for testing
- Apply fluid to wing by spraying or with wing applicator.

Test Surface Observer (1)

- Examine the snow distribution to determine if a stand situated beside the wing will receive equivalent rates. Alternatively, install the test surfaces on the wing using the wing-plates designed for this purpose.
- Co-ordinate set-up of thermistor logger and Laptop PC. Monitor to ensure all probes are operating throughout the test session. Enter location description is entered for individual probes. Save logger data onto PC following each test run.
- When fluid is applied on the wing test area, treat the test surfaces as described in the procedure.
- Record fluid failures on the test surfaces.
- Alert the wing observer and the meteo recorder when the following events occur:
 - failure call of the standard HOT plate
 - failure call of the 7.5 cm cold-soak box surface

Meteo Recorder (1)

- Set-up equipment for measuring precipitation rate. Two rate pans will be positioned on the stand for ongoing rates during the test. Prior to test, rates will be measured at test positions.
- Two rate pans will be positioned on the wing, beside the test area, for ongoing rates during the test. Prior to test, rates will be measured within the test area.
- Assist in pouring the fluid for the test surfaces.
- Conduct precipitation rate measures using the Meteo/Plate data form Figure. Use two rate pans in a staggered routine, exchanging one pan for the other at the time that a measurement is required. Record rates at specific times during the test:
 - at failure call of the standard HOT plate
 - at failure call of the 7.5 cm cold-soak box with standard surface

- at 10% failure call of the test area leading edge
- at test end.

Figure 1
JetStar Wing Dimensions

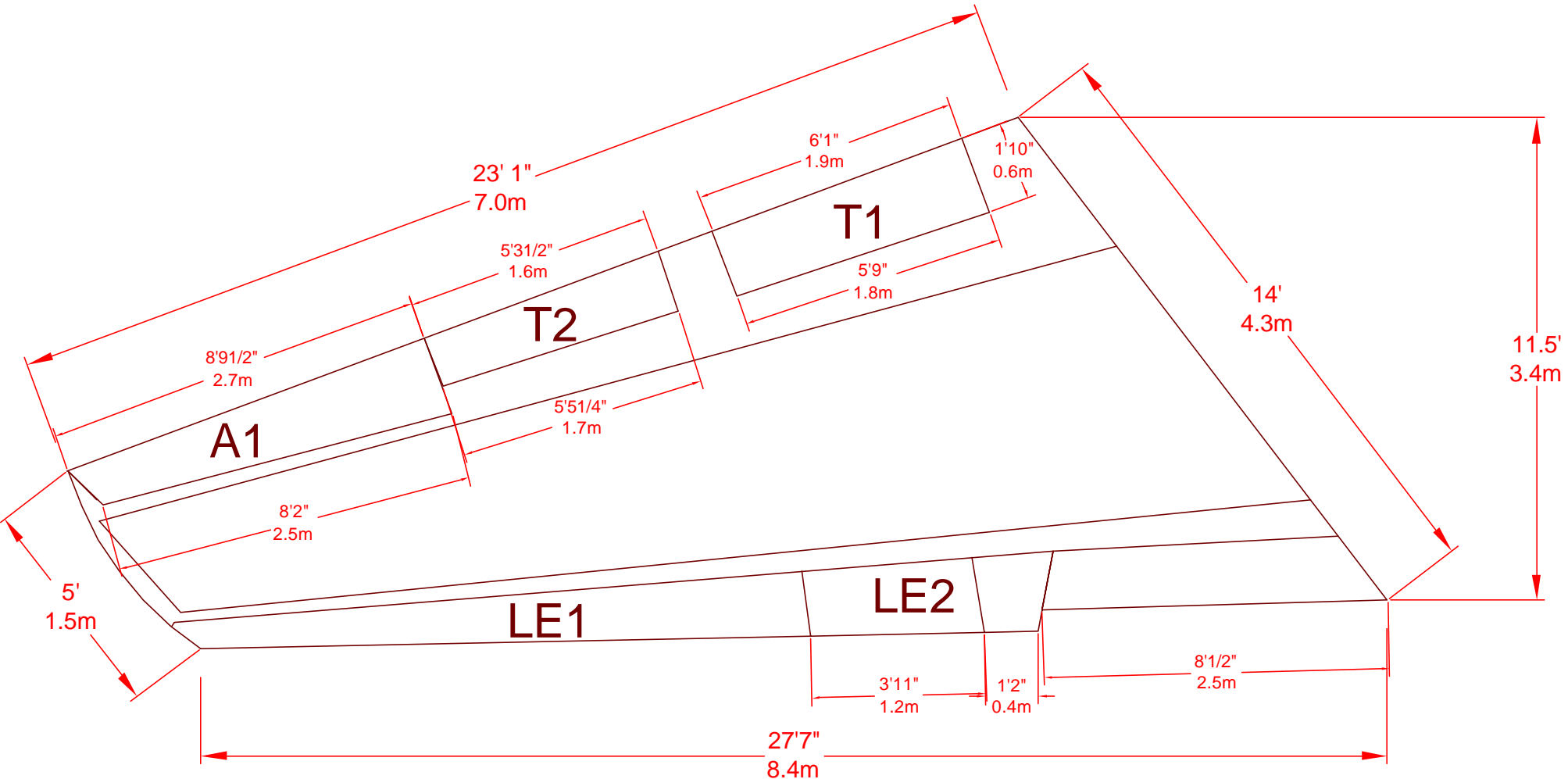
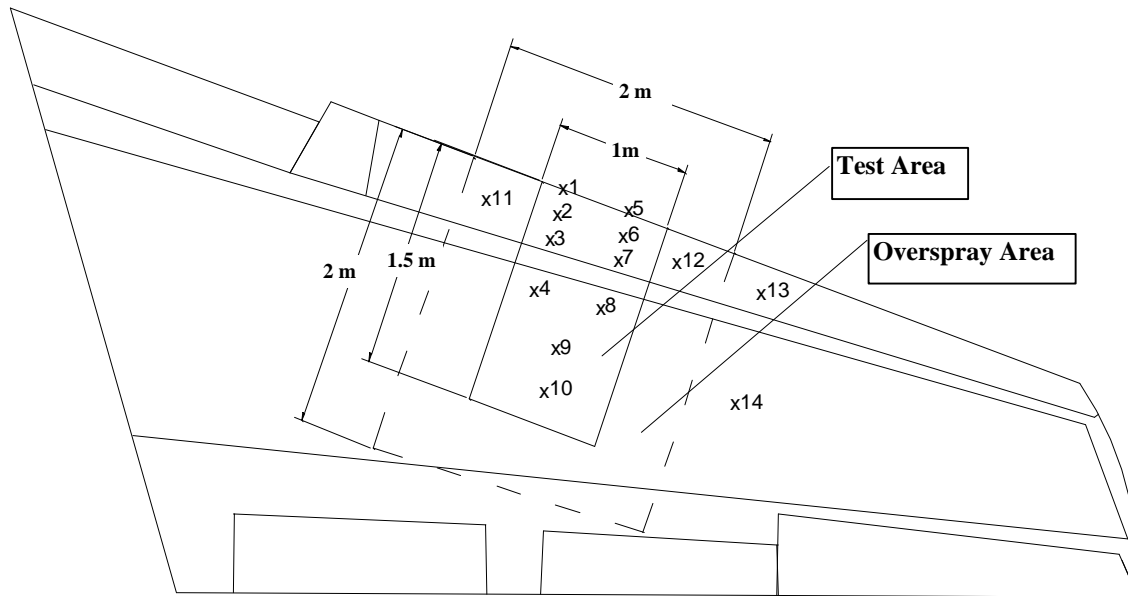

FIGURE 2
THERMISTOR PROBE LOCATIONS FOR JETSTAR WING
TEST AREA & NRC TRIALS FOR JETSTAR WING TEMPERATURE PROFILES

Thermistor Probes Mounting Locations



- 1 and 5. On LE nose, 30 cm from outer edge of test area
- 2 and 6. Mid-way on LE, 30 cm from outer edge of test area
- 3 and 7. Rear of LE, 30 cm from outer edge of test area
- 4 and 8. 15 cm back from edge of main wing, 30 cm from outer edge of test area
- 9. 50 cm forward from rear of test area, midpoint laterally
- 10. 15 cm forward from rear of test area, midpoint laterally
- 11 and 12. Mid-way on LE, 25 cm from outer edge of test area
- 13. Mid-way on LE, 25 cm from outer edge of overspray area
- 14. Laterally from point 9, 25 cm from outer edge of overspray area

FIGURE 3
GENERAL FORM (EVERY TEST)
(TO BE FILLED IN BY BRIX SAMPLER)

DATE: _____

AIRCRAFT TYPE: F-100 B-737 RJ Saab 340

RUN #: _____

WING: PORT (A) STARBOARD (B)

DIRECTION OF AIRCRAFT: _____ DEGREES

DRAW DIRECTION OF WIND WRT WING:



1st FLUID APPLICATION

Snow Depth on Wing _____ cm

Actual Start Time: _____ am / pm

Actual End Time: _____ am / pm

Amount of Fluid Sprayed: _____ L / gal

Type of Fluid: _____

Temp. of Fluid at Nozzle _____ °C

Fluid Brix: _____

End of Test Time: _____ (hr:min:ss) am/pm

COMMENTS: _____

MEASUREMENTS BY: _____

HAND WRITTEN BY: _____

FIGURE 4
FLUID FAILURE FORM FOR JETSTAR WING
NRC TRIALS FOR TYPE I TEST PROTOCOL

VERSION 10 WINTER 2000/2001

REMEMBER TO SYNCHRONIZE TIME

DATE:	RUN NUMBER:	SPRAY TYPE:
FAILURES RECORDED BY: _____		

TIME:

TIME:

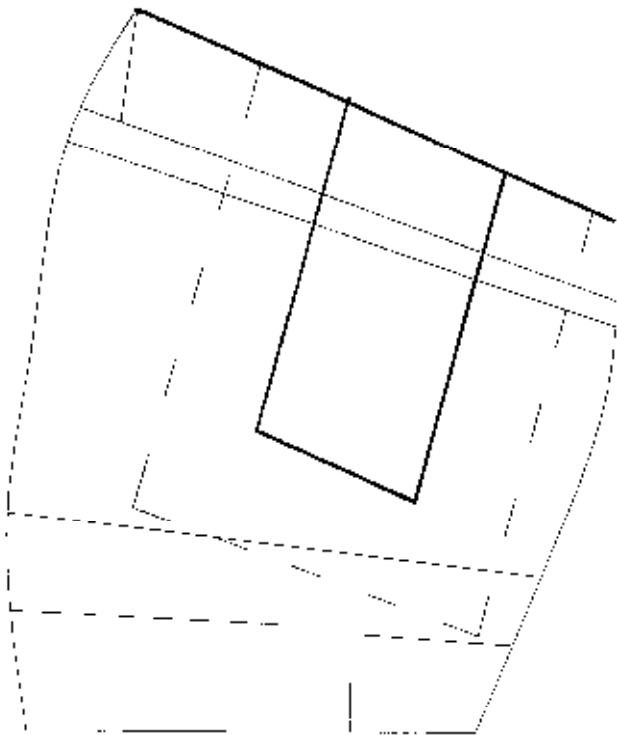
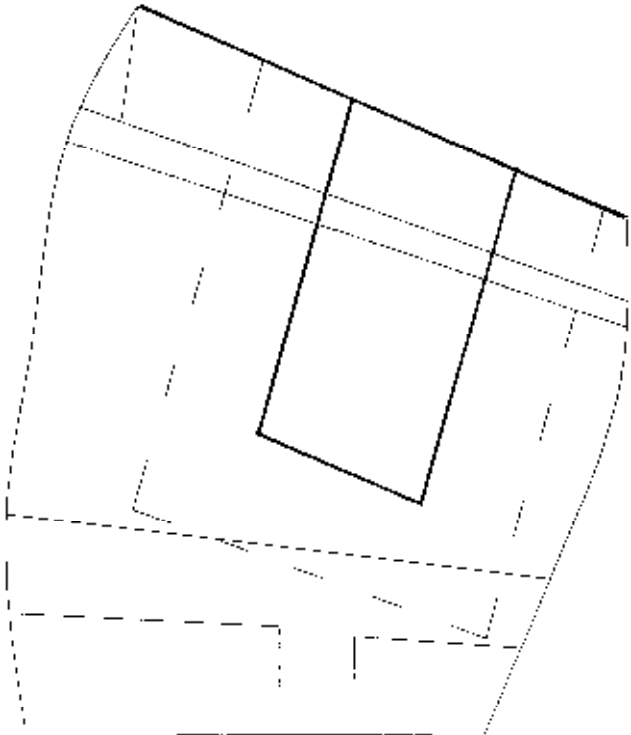

FIGURE 5
BRIX FORM FOR JETSTAR WING
 NRC TRIALS FOR TYPE I TEST PROTOCOL

DATE: _____

RUN #: _____

Final Drip Line Brix: _____

Snow Depth on Wing: _____

Wing Location 5		Wing Location 6		Std. HOT Plate		Std. BOX		Location	
Time	Brix	Time	Brix	Time	Brix	Time	Brix	Time	Brix

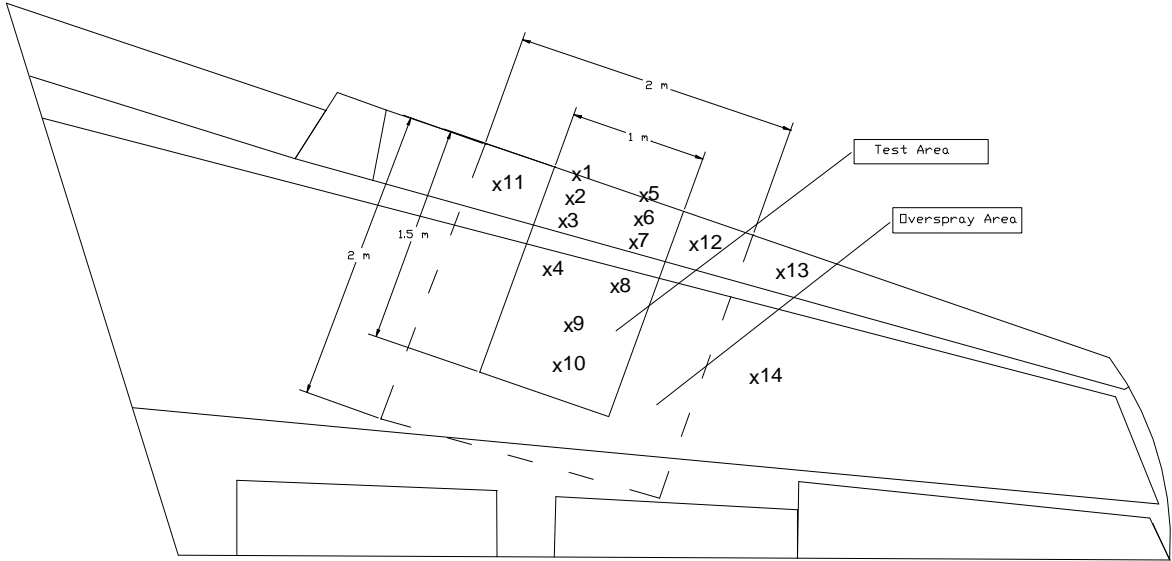

COMMENTS: _____

BRIX MEASUREMENTS BY: _____
 HANDWRITTEN BY: _____

Figure 6
END CONDITION DATA FORM
NRC TRIALS FOR TYPE I TEST PROTOCOL

REMEMBER TO SYNCHRONIZE TIME WITH AES - USE REAL TIME

VERSION 6.0 Winter 2000/2001

LOCATION: _____	DATE: _____	RUN # : _____	STAND # : _____
------------------------	--------------------	----------------------	------------------------

OTHER COMMENTS (Fluid Batch, etc):

PRINT **SIGN**

FAILURES CALLED BY : _____

HAND WRITTEN BY : _____

TEST SITE LEADER : _____

***TIME (After Fluid Application) TO FAILURE FOR INDIVIDUAL CROSSHAIRS (hr:min)**

Time of Fluid Application: _____ hr:min:ss _____ hr:min:ss _____ hr:min:ss

	Std. HOT	Std. BOX	Thick BOX
FLUID NAME			
B1 B2 B3	<input type="text"/>	<input type="text"/>	<input type="text"/>
C1 C2 C3	<input type="text"/>	<input type="text"/>	<input type="text"/>
D1 D2 D3	<input type="text"/>	<input type="text"/>	<input type="text"/>
E1 E2 E3	<input type="text"/>	<input type="text"/>	<input type="text"/>
F1 F2 F3	<input type="text"/>	<input type="text"/>	<input type="text"/>
TIME TO FIRST PLATE FAILURE WITHIN WORK AREA	<input type="text"/>	<input type="text"/>	<input type="text"/>
CALCULATED FAILURE TIME (MINUTES)	<input type="text"/>	<input type="text"/>	<input type="text"/>
BRIX / TEMPERATURE AT START	<input type="text"/>	<input type="text"/>	<input type="text"/>

Time of Fluid Application: _____ hr:min:ss _____ hr:min:ss _____ hr:min:ss

	Std. HOT	Std. BOX	Thick BOX
FLUID NAME			
B1 B2 B3	<input type="text"/>	<input type="text"/>	<input type="text"/>
C1 C2 C3	<input type="text"/>	<input type="text"/>	<input type="text"/>
D1 D2 D3	<input type="text"/>	<input type="text"/>	<input type="text"/>
E1 E2 E3	<input type="text"/>	<input type="text"/>	<input type="text"/>
F1 F2 F3	<input type="text"/>	<input type="text"/>	<input type="text"/>
TIME TO FIRST PLATE FAILURE WITHIN WORK AREA	<input type="text"/>	<input type="text"/>	<input type="text"/>
CALCULATED FAILURE TIME (MINUTES)	<input type="text"/>	<input type="text"/>	<input type="text"/>
BRIX / TEMPERATURE AT START	<input type="text"/>	<input type="text"/>	<input type="text"/>

Figure 7
METEO/PLATE PAN DATA FORM - TYPE I PROTOCOL

REMEMBER TO SYNCHRONIZE TIME WITH AES - USE REAL TIME

VERSION 1.0 Winter 2000/2001

LOCATION:	DATE:	RUN #:	STAND #:
------------------	--------------	---------------	-----------------

PLATE PAN WEIGHT MEASUREMENTS *

PAN #	t TIME BEFORE	BUFFER TIME	t TIME AFTER	BUFFER TIME	w WEIGHT BEFORE	w WEIGHT AFTER	COMPUTE RATE
	(hh:mm:ss)	Seconds	(hh:mm:ss)	Seconds	(grams)	(grams)	($\Delta w * 4.7 / \Delta t$) (g/dm ² /h)

*MEASUREMENTS AT 5 MIN. INTERVALS (STAGGERED).

METEO OBSERVATIONS **

TIME (hr:min)	TYPE ZR, ZL, S, SG IP, IC, BS, SP	SNOW CLASSIF. (See Fig. 3)	OAT (°C)	WIND SPEED at 2 m (km/h)

**observations at beginning, end, and every 10 min. intervals. Additional observations when there are significant changes.

COMMENTS :

PRINT **SIGN**

WRITTEN & PERFORMED BY : _____

PHOTO BY : _____

TEST SITE LEADER : _____

APPENDIX H

Field Trials for Type I Test Protocol

BM3833.001

**EXPERIMENTAL PROGRAM
FIELD TRIALS FOR TYPE I HOT TEST PROTOCOL**

Winter 2000-2001

Prepared for

**Transportation Development Centre
Transport Canada**

Prepared by: Peter Dawson

Reviewed by: John D'Avirro



5 March 2001
Version 1.0

EXPERIMENTAL PROGRAM
FIELD TRIALS FOR TYPE I HOT TEST PROTOCOL
Winter 2000-2001

1. OBJECTIVES

To confirm that fluid endurance times developed on candidate test surfaces using proposed test procedures are representative of fluid endurance times experienced on aircraft wing surfaces in field conditions during natural precipitation.

Simultaneous trials on aircraft and test surfaces will be conducted. Candidate test surfaces mounted on a test stand will be positioned near the test aircraft, subjected to the same natural precipitation and wind as the aircraft wing. The test surfaces will be treated with SAE Type I fluid according to proposed test procedures as well as the existing Type I test procedure, while the aircraft is being deiced in accordance with standard deicing procedures. Fluid endurance times and surface temperature profiles will be measured and compared.

2. PROCEDURE/TEST REQUIREMENTS

Simultaneous trials on aircraft and candidate surfaces will be conducted on two occasions in natural precipitation. At least one of these trial sessions will be conducted on a Boeing 737 aircraft. Because the construction of the wing of the Saab 340 aircraft includes different composite materials, this aircraft would be useful for test. American Eagle has agreed to provide a Saab 340 aircraft.

Desired weather conditions for the trials are:

- Medium to heavy snowfall
- OAT in the range of -5 to -15°C
- Wind speeds in the range of 15 to 25 km/h.

Fluids will be tested at two concentrations; mixed to a fluid freeze point buffer of 10°C, and at full operational strength.

Trials on the aircraft will incorporate the effect of the removal of contamination, by allowing snow to accumulate on aircraft surfaces between test runs. The spray operator, who will be instructed to spray according to standard procedure, will control the quantity of fluid sprayed. The fluid temperature will be in accordance with standard operating practice (fluid tank temperature of 80°C).

Trials on the candidate test surfaces will follow a proposed procedure described later in this document.

Data collected in these trials will include:

- Fluid temperature, quantity and initial strength
- Ambient conditions; OAT, wind speed, precipitation rate
- Aircraft fuel; quantity in tanks and temperature
- Depth of contamination on wing at start of test
- Temperature profiles of wing and test surfaces
- Brix profile of fluid on wing and on a test surface
- Failure times and patterns on wing and on test surfaces.

Previous field studies examining fluid failures on aircraft concluded that the wing leading edge and rear flight control surfaces are the earliest surfaces to experience fluid failure. Because contamination on the leading edge can severely degrade airfoil, wing and take-off performance, this study will give primary attention to fluid condition on the leading edge.

A proposed test matrix for the tests on the aircraft wing is given in Table 1. Attachment 1 describes test procedures on the wing and the simultaneous tests on candidate surfaces.

3. EQUIPMENT

A list of equipment is given in Attachment II.

Two deicing vehicles will be required; one for dilute fluid, and one for standard strength.

US Airways has offered to provide a B737 aircraft. American Eagle has offered to provide a Saab340.

4. FLUIDS

SAE Type I ethylene glycol-based fluid (UCAR ADF) will be used. Fluid concentrations will be diluted to a fluid freeze point buffer of 10°C and standard operating mix (50/50).

Fluids will be heated to a tank temperature in accordance with the standard operating procedure followed by AéroMag 2000.

5. PERSONNEL

Nine APS personnel are required for these tests as follows:

At the aircraft:

- leading edge observer
- wing observer
- lead brix sampler

At the test stand:

- test surface observer
- assistant brix sampler and fluid preparation
- meteo recorder

Other

- photo
- video
- coordinator.

Attachment III lists task assignments.

Aéromag 2000 will perform the aircraft spraying.

6. DATA FORMS

Figure 1	Equipment Position
Figure 2- B737	Thermistor probe locations for B737 Wing
Figure 2- Saab340	Thermistor probe locations for Saab340 Wing
Figure 3	General Form (Once per Session)
Figure 4	General Form (Every test)
Figure 5- B737 Port	Fluid Failure Form for Leading Edge and Wing
Figure 5- B737 Stbd	Fluid Failure Form for Leading Edge and Wing
Figure 6- B737	Brix Form for B737 Wing
Figure 5- Saab340 Port	Fluid Failure Form for Leading Edge and Wing
Figure 5- Saab340 Stbd	Fluid Failure Form for Leading Edge and Wing
Figure 6- Saab340	Brix Form for Saab340 Wing
Figure 7	End Condition Data Form
Figure 8	Test Surface Brix Form
Figure 9	Meteo/Plate Pan Data Form – Type I protocol

**TABLE 1
TEST PLAN
FIELD TRIALS FOR TYPE I HOT TEST PROTOCOL**

TEST SESSION	RUN	AIRCRAFT TYPE	OAT (°C)	FLUID FREEZE POINT (°C)	FLUID TEMP (°C)	FLUID QUANTIT Y (L)	SNOW DEPTH ON WING (cm)
1	1	B 737	-5 to -15	OAT – 10° buffer	As sprayed	As sprayed	> 1cm
1	2	B 737	-5 to -15	OAT – 10° buffer	As sprayed	As sprayed	> 1cm
1	3	B 737	-5 to -15	Standard mix	As sprayed	As sprayed	> 1cm
2	4	Saab 340	-5 to -15	OAT – 10° buffer	As sprayed	As sprayed	> 1cm
2	5	Saab 340	-5 to -15	OAT – 10° buffer	As sprayed	As sprayed	> 1cm
2	6	Saab 340	-5 to -15	Standard mix	As sprayed	As sprayed	> 1cm

Note: these test runs will be repeated during the test session if additional information can be collected, for example, due to a change in ambient conditions.

Attachment 1 describes the procedure for these tests, and the simultaneous tests conducted on candidate test surfaces.

ATTACHMENT I

TEST PROCEDURES FIELD TRIALS FOR TYPE I HOT TEST PROTOCOL

PRE-TEST SETUP

- Brief team members on test procedure and individual assignments. Distribute data forms.
- Synchronise all timepieces, loggers and cameras with atomic clock.
- Prepare fluids for testing on candidate surfaces.
- Brief AéroMag on procedure. Discuss fluid mix and temperature requirements.
- Ensure all cameras are functional.
- Park the aircraft, nose into the wind.
- Record fuel load in test wing.
- Arrange equipment about aircraft in accordance with Figure 1.
- Set-up mobile light unit. Ensure adequate illumination of wing.
- Set-up generators and power cords.
- Set-up stairs near the wing.
- Install thermistor probes on wing in accordance with Figure 2.
- Set-up test-stand with candidate test surfaces and thermistor probes installed. Position test stand into the wind.
- Set-up data logger; test thermistor probes for function. Make note of which logger channel represents which test surface and wing location.
- Position cube van to support precipitation-rate measurement.
 - Set-up rate station table, scale, lights in van.
 - Set-up fluid preparation station.
 - Set-up thermistor laptop for logger display.
- Position second cube van for personnel use.

TESTS ON AIRCRAFT

For Each Run

- Measure truck tank fluid Brix and temperature.
- Measure depth of snow coverage on wing prior to spray.
- Videotape entire fluid spray from an appropriate vantage point.
- Measure fluid temperature at nozzle, spraying away from wing. Spray enough to clear the lines of cold fluid.
- Deice wing with test fluid. Record amount of fluid applied.
- Record OAT, wind speed and direction.
- Photograph and videotape the test setup. Ensure that location of thermistor probe installations on wing surface are recorded.

Observe Time to Freeze and record failure pattern

- Observe wing leading edge for first freezing and record on the wing form. Disregard any early freezing caused by the sampling activity. Thereafter, record failure pattern on the leading edge when advised by the test surface observer at the following events:
 - at failure call of the standard HOT plate
 - at failure call of the standard 7.5 cm cold-soak box surface
 - If the time interval before or between any of the failure events is longer than 5 minutes, make additional records of failure pattern. Depending on leading edge condition following all test surface events, continue at 5-minute intervals until the leading edge is at least 25% failed.
- Photograph and videotape the leading edge condition when the fluid failure patterns are being recorded.
- Measure fluid strength on the wing at the specified locations. Ensure sampled locations are shifted each time to avoid repeat sampling at the same point. Protect the fluid sample from precipitation.
- Measure and record roughness profiles, adhesion and distribution of failed areas, and changes in these parameters with time, following failure call.

Prepare for Next Test

- Allow sufficient time for wing to cool to ambient temperature, and for snow to re-form on wing surfaces (at least 1 cm deep).

End of Test Session

- Deice wing with deicing fluid.
- Remove thermistor probes from wing, ensuring that no trace of tape remains.

TESTS ON CANDIDATE SURFACES

Setup

- Follow standard procedures for HOT tests except as described in the following.
- Prepare surfaces on stand, placed on the top row in accordance with the following table. Ensure all thermistor probes on surfaces are logging temperature.
- Prepare fluid for testing. Mix fluid to a 10°C freeze point buffer. Each test run will require fluid as shown in the following table.

STAND POSITION	SURFACE TYPE	FLUID		POUR SEQUENCE
		AMOUNT (L)	TEMP (°C)	
1	Rate Pan			
2	7.5 cm box (empty)	0.5	60	3 rd
3	7.5 cm box (empty) with attached (1.6 mm) aluminum plate	0.75	60	2 nd
4	7.5 cm box (empty) with attached std (3.2 mm) plate	1.0	60	1 st
5	Standard plate for HOT test	1	20	4 th
6	Rate Pan			

- Pour required amount of heated fluid into thermos containers in preparation for application.
- Protect the fluid spreader from cooling.

When aircraft spraying commences:

- Apply fluid on candidate surfaces according to the table. Treat the candidate test surfaces in quick succession to avoid cooling of the spreader between pours. Use the following procedure for cleaning the surface and pouring fluid:
 - Clean the plate of all contamination with scraper and squeegee. Apply a small amount of fluid at ambient temperature and squeegee the plate over its entire surface. This is intended to

ensure that the surface is wetted as well as clean, to assist in complete coverage with the applied fluid.

- Shield the plate from wind when pouring the test fluid from the thermos into the spreader. Remove the shield when the spreader has emptied.
- Apply fluid to the standard HOT surface according to the standard method. (clean the plate with scraper and squeegee, pour about 1/3 of the fluid over the plate, squeegee dry, and then pour the remainder of the fluid along the top edge.)
- Determine failure times on test surfaces, and record using standard HOT data forms.
- Conduct precipitation rate measures using the Meteo/Plate data form. Use two rate pans in a staggered routine, exchanging one pan for the other at the time that a measurement is required. Record rates at specific times during the test:
 - at failure call of the standard HOT plate
 - at failure call of the 7.5 cm cold-soak box with standard surface
 - at failure call on the aircraft leading edge
 - at test end
- Record wind speed at the test stand before and after each run. Measure wind speed by moving along the rear of the stand, with the anemometer held over the rear edge of the test surfaces at a 2 m height above ground.
- Measure brix, every two minutes, on the brix box surface, at the 15 cm line. Record BRIX on the Fluid Brix data form. Stagger consecutive measured positions along the 15 cm line.

ATTACHMENT II
TEST EQUIPMENT CHECKLIST
FIELD TRIALS FOR TYPE I HOT TEST PROTOCOL

TASK	STATUS
Logistics For Every Test	
Monitor Forecast	
Co-ordinate with aircraft provider; arrange for a/c delivery, contact person for a/c overnight, a/c orientation	
Co-ordinate with AÉromag 2000; review truck and fluid needs	
Call Personnel	
Rent 2 cube vans: one for lab, one for personnel	
Rent mast light	
Test Equipment	
General for all Tests	
Security Passes	
Deicing Truck with 10°C buffer fluid	
Deicing truck with standard deicing fluid	
Test procedures	
Data Forms	
Temperature Probe and spare batteries	
Clipboards	
Pencils	
Paper towels	
Electrical extension cables	
Fluid containers for truck fluid sampling	
Temperature Probe for truck fluid at nozzle	
Tools	
Compass	
First aid kit	
Fire extinguisher	
Squeegees	
Large clock	
Preparing Wing	
Rolling Stairs X 6	
Markers, solvent and cloth wipers	
Tape measures X 4 (2 long, 2 short)	
Thermistor probes and cables	
Logger kits	

ATTACHMENT II – TEST EQUIPMENT CHECKLIST

Laptop PC X 2 (in cube van)	
Table for laptop in van	
Speed Tape	
Heat gun	
Rubbing alcohol	
Marker	
Pylons	
Stepladder X 2	
<i>Wing Observers</i>	
Brixometers X 2	
Large clock	
Whistle	
Depth gauges and scale to measure snow depth	
<i>Test surface observers</i>	
Test stand (6 plus 6)	
Test surfaces: 7.5 cm cold-soak box (empty)	
7.5 cm box (empty) with attached std (3.2 mm) plate X 2	
Standard plate for HOT test	
Brixometer	
Scrapers and squeegees	
Wiper rags	
Wind shield	
Fluid spreaders for plate and for box	
<i>Preparing Fluids for Test Stand</i>	
Table in cube van	
Heating pots	
Hot plates	
Generator and cable	
Fluid thermometer	
Vacuum bottles and rack	
Cold Type 1 fluid	
<i>Meteo</i>	
Rate pans X 4	
Light for cube van	
Table	
Scale; 2 g accuracy	
Laptop PC for rates	
Generator	

ATTACHMENT II – TEST EQUIPMENT CHECKLIST

Fuel for Generator	
Vaisala RH meter	
Wind gauge	
<i>Camera Equipment</i>	
Digital Video Camera	
Still Camera and film	
Video Camera	
Digital still camera	

ATTACHMENT III

RESPONSIBILITIES/DUTIES OF TEST PERSONNEL FIELD TRIALS FOR TYPE I HOT TEST PROTOCOL

Team leader (1)

- Monitor weather, and initiate test with Airline providing aircraft for test, Aéromag, TDC, and FAA.
- Advise APS test team
- Ensure that all required equipment is available and functional.
- Brief all involved on test procedure and assignments.
- Co-ordinate delivery of aircraft to Central Deicing Facility; advise re parking orientation.
- Ensure that all data are collected and saved, and that all test records are submitted.
- Ensure that all personnel are aware of safety issues (Attachment IV).

Photo (1)

- Photograph all test set-up. The record is to include location of thermistor probes on wing surface.
- Photograph freezing pattern on leading edge at the times that the leading edge observer is recording failure patterns.
- Photograph freezing pattern on test surfaces following failure call.
- Photograph roughness of iced areas following failure call, as indicated by leading edge observer.

Video (1)

- Videotape all test set-up. The record is to include location of thermistor probes on wing surface.
- Videotape freezing pattern on leading edge at the times that the leading edge observer is recording failure patterns.

Leading Edge Observer, Wing Observer (2)

- Confirm assigned position with team leader.
- Install mast light.
- Position stairs at wing
- Working together, install thermistor probes at assigned location.
- Assist in general set-up.
- Ensure all data forms completed and submitted at test end.
- Dismantle thermistor system at end of test session. Ensure no remnants of speed tape are left on wing.
- Clean any markings from wing surface with approved solvent.

Leading Edge Observer

- Concentrate on observing wing leading edge and leads the activity at the wing. Record time and location of first freezing on the wing leading edge form. Disregard any early freezing caused by Brix sampling. Thereafter, record failure pattern on the leading edge when advised by the test surface observer whistle at the following events:
 - at failure call of the standard HOT plate
 - at failure call of the standard 7.5 cm cold-soak box surface
 - If the time interval between any of the failure events is longer than 5 minutes, make additional records of failure pattern. Depending on leading edge condition following all test surface events, continue at 5-minute intervals until the leading edge is at least 25% failed.
 - Advise the coordinator and meteo when wing leading edge has reached failure.
 - Advise the wing observer each time recording is started for the leading edge.
 - Call attention of photographer and video to failed areas for recording.
 - Following fluid failure call on the leading edge and with the assistance of the photographer, record the roughness profiles, distribution, adhesion, and changes in these parameters with time. Select one or two failed areas on the wing to observe and sketch those areas on a wing diagram. Then at 5-minute intervals, measure the thickness of the ice in the selected area, and record the maximum and minimum. The forensic scales or a thickness gauge would be used for this. If the ice is adhered, the pin end of a caliper could alternatively be used. Adhesion may be assessed simply by testing the ice for ease of movement, with a pencil. The observed area would be photographed at the times of observation, with the forensic scale in the photo view. The camera time stamp must be operational for this test.

Wing Observer

- Concentrate on remainder of the wing, less the leading edge.
 - Record failure patterns on the wing form at the same time that the leading edge observer records.

Lead Brix Sampler (1)

- Record spray specifics and measures Brix on wing.
 - Work with Aéromag 2000 to prepare fluid in truck for test (type, strength, temperature).
 - Complete the general form for every test, recording specifics on spray and snow depth on wing. Before test, take sample of fluid from truck tank; measure temperature and Brix.
 - Measure fluid temperature at truck nozzle just prior to each fluid application. Measure Brix of truck fluid.
 - Record start and end times, and amount of fluid applied.

- With the help of the Brix assistant, measure Brix on test surfaces and wing at designated locations. Record on Brix Form. Commence taking measurements on the test surfaces immediately after fluid application, and then sample at the wing locations. For the test surfaces, stagger consecutive measured positions along the 15 cm line. Circulate continuously between test surfaces and wing, with the objective of completing a circuit every two minutes. Ensure sampled locations are shifted each time to avoid repeat sampling at the same point. Protect the fluid sample from precipitation.

Test Surface Observer (1)

- Prepare all equipment for moving from trailer to the CDF.
- Co-ordinate setting up major equipment at the test site.
- Oversee dismantling and orderly return of equipment.
- Set up stand according to the test procedure.
- Co-ordinate set-up of thermistor logger and Laptop PC. Monitor to ensure all probes are operating throughout the test session. Enter location description for individual probes. Save logger data onto PC following each test run.
- Concentrate on recording fluid failures and leading the activity at the stand
- When aircraft spraying commences, treat the test surfaces as described in the procedure.
- Alert the leading edge observer and the meteo recorder by blowing the whistle when the following events occur:
 - failure call of the standard HOT plate
 - failure call of the 7.5 cm cold-soak box surface

Assistant Brix Sampler (1)

- Set up test-surface-fluid preparation station and prepare fluids for application. Assist in pouring.
- Assist the lead brix sampler in measuring and recording brix, on the test surfaces and wing.

Meteo Recorder (1)

- Set up equipment for measuring precipitation rate.
- Assist in pouring fluid on test surfaces.
- Conduct precipitation rate measures using the Meteo/Plate data form Figure 9. Use two rate pans for each pan position, exchanging one pan for the other at the time that a measurement is required. Record rates at specific times during the test:
 - at failure call of the standard HOT plate
 - at failure call of the 7.5 cm cold-soak box with standard surface
 - at failure call on the aircraft leading edge
 - at test end
- Record wind speed at the test stand before and after each run. Measure

- wind speed by moving along the rear of the stand, with the anemometer held over the rear edge of the test surfaces at a 2 m height above ground
- Record OAT and RH using the Vaisala meter with probe installed at a location free from influence of test equipment.

ATTACHMENT IV

SAFETY AWARENESS ISSUES FIELD TRIALS FOR HOT WATER DEICING LIMITS

- 1) Review MSDS sheets for fluids at site.
- 2) Protective clothing is available.
- 3) Care should be taken when climbing rolling stairs due to slipperiness.
- 4) When moving rolling stairs, ensure they do not touch aircraft.
- 5) When taking fluid samples or measuring snow thickness on the aircraft, ensure minimum pressure is applied to the wing.
- 6) Entry into the aircraft cabin is not authorised.
- 7) When aircraft is being sprayed with fluid, testers and observers should be positioned away in the hold area.
- 8) First aid kit and fire extinguisher is available in mobile truck.
- 9) No smoking permitted on the ramp area.
- 10) Care to be taken when moving generators and fuel for the generators.
- 11) Electrical and instrumentation cabling will be present in the test area; do not trip over them. Do not roll stairs or other equipment over cables.
- 12) Gasoline containers are needed to power the generators - ensure you know where these are.
- 13) Ensure lights and rolling stairs are stabilised to not damage the wing.
- 14) Ensure all objects and equipment are removed from deicing pad at end of night.
- 15) Ensure all markings removed from wing.
- 16) Personnel with escort-required passes must always be accompanied by someone with a permanent pass.
- 17) Rolling stairs should always be positioned such that the stairs are into the wind. Small ladders should be laid down under windy conditions.
- 18) Tests involving personnel not trained and experienced in ramp operations must take particular care to ensure safety of personnel.

FIGURE 1
EQUIPMENT POSITION

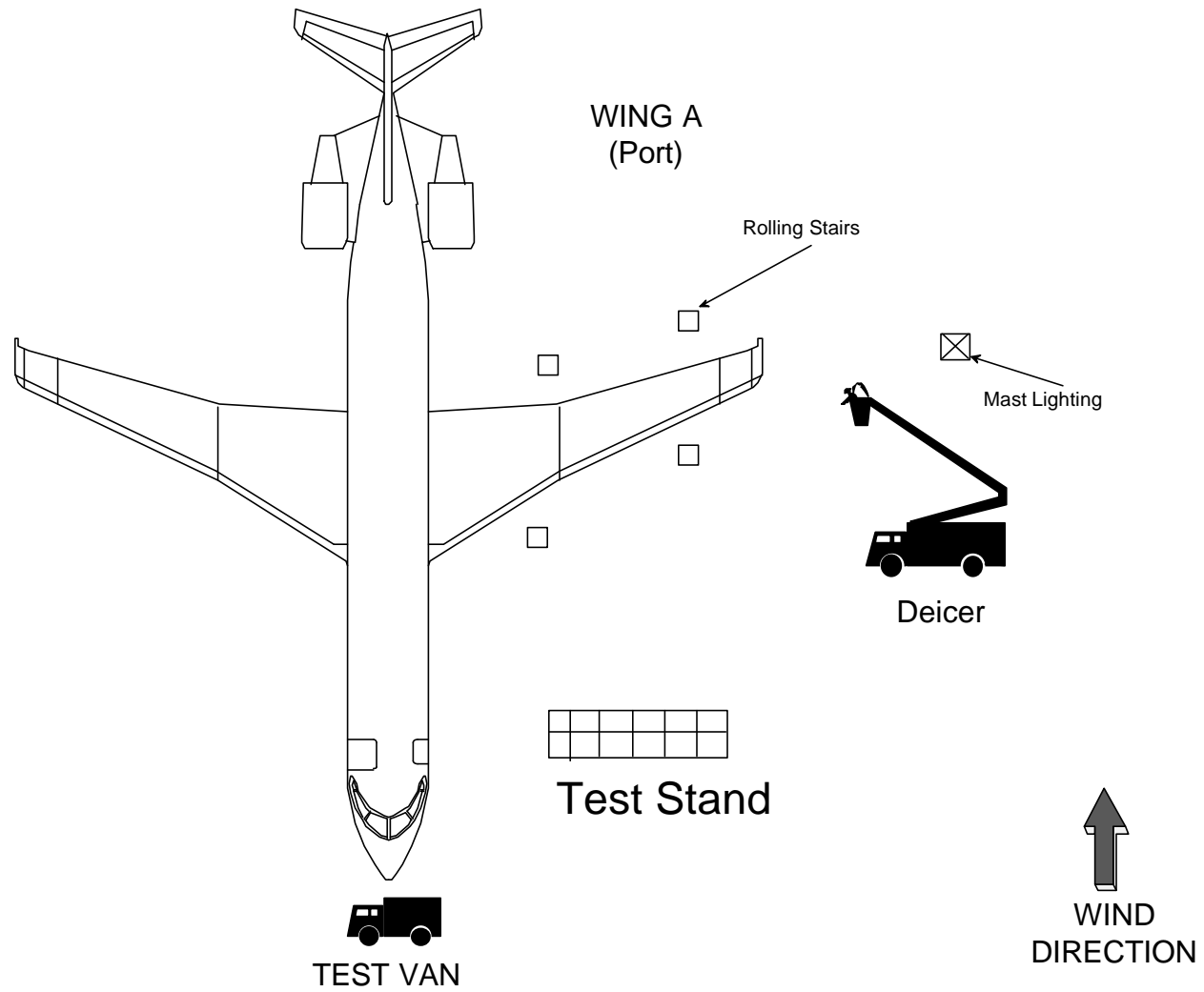

Note: These positions are approximate.
The actual positions will be
dependent upon the site.

FIGURE 2
Thermistor Probes Locations for B737 Wing
FIELD TRIALS FOR TYPE I TEST PROTOCOL

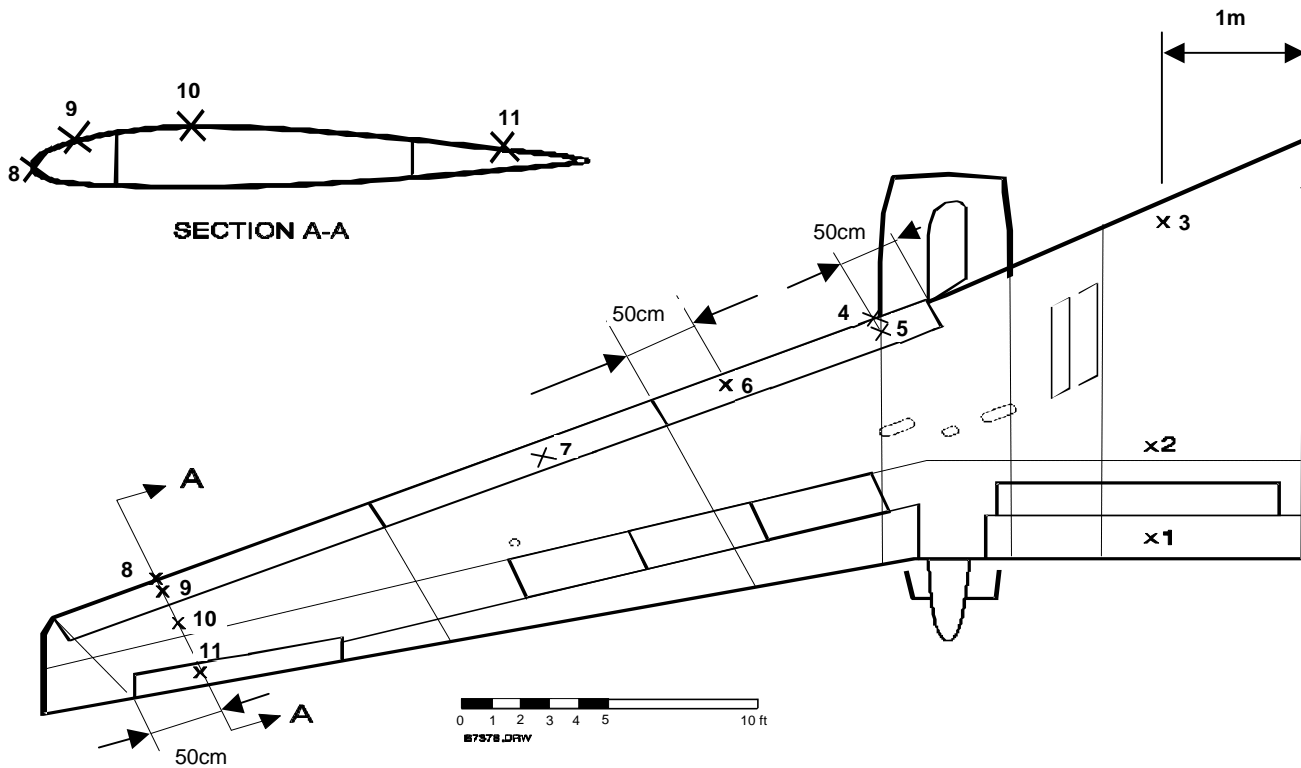

1. Mid-way on flap, 1 m from root
2. On main wing, max. distance reachable, 1m from fuselage
3. 25cm back from LE nose, 1m from fuselage
4. On nose of LE, 50 cm from inner end
5. Mid-way on surface, 50 cm from inner end
6. Mid-way on LE, 50cm from outer end
7. Mid-way on LE, midpoint of LE section
8. On nose of LE, in chord with # 11
9. Mid way on LE, in chord with # 11
10. High point of wing in chord with # 11
11. Mid-way on aileron, 50 cm from outer end.

FIGURE 3
GENERAL FORM (ONCE PER SESSION)
(TO BE FILLED IN BY OVERALL COORDINATOR)

AIRPORT: YUL YYZ YOW

AIRCRAFT TYPE: F-100 B-737 RJ Saab 340

EXACT PAD LOCATION
 OF TEST: _____

AIRLINE: _____

DATE: _____

FIN #: _____

APPROX. AIR TEMPERATURE: _____ °C

WING TANK FUEL LOAD: _____ LB / KG

<u>STD TYPE I FLUID APPLICATION</u>	<u>-10 °C BUFFER TYPE I FLUID APPLICATION</u>
FLUID TEMP: _____ °C Truck #: _____ Type I Fluid Nozzle Type: _____	FLUID TEMP: _____ °C Truck #: _____ Type I Fluid Nozzle Type: _____

COMMENTS:

MEASUREMENTS BY: _____

HAND WRITTEN BY: _____

FIGURE 4
GENERAL FORM (EVERY TEST)
(TO BE FILLED IN BY BRIX SAMPLER)

DATE: _____

AIRCRAFT TYPE: F-100 B-737 RJ Saab 340

RUN #: _____

WING: PORT (A) STARBOARD (B)

DIRECTION OF AIRCRAFT: _____ DEGREES

DRAW DIRECTION OF WIND WRT WING:



1st FLUID APPLICATION

Snow Depth on Wing _____ cm

Actual Start Time: _____ am / pm

Actual End Time: _____ am / pm

Amount of Fluid Sprayed: _____ L / gal

Type of Fluid: _____

Temp. of Fluid at Nozzle _____ °C

Fluid Brix: _____

End of Test Time: _____ (hr:min:ss) am/pm

COMMENTS: _____

MEASUREMENTS BY: _____

HAND WRITTEN BY: _____

FIGURE 5 - B737 Port
FLUID FAILURE FORM FOR LEADING EDGE AND WING OBSERVERS
FIELD TRIALS FOR TYPE I TEST PROTOCOL

REMEMBER TO SYNCHRONIZE TIME

VERSION 10

WINTER 2000/2001

DATE: _____ RUN NUMBER: _____ SPRAY TYPE: _____

FAILURES RECORDED BY: _____

TIME: _____

DRAW Failure Contours at initial failure and every 2 to 5 minutes after.

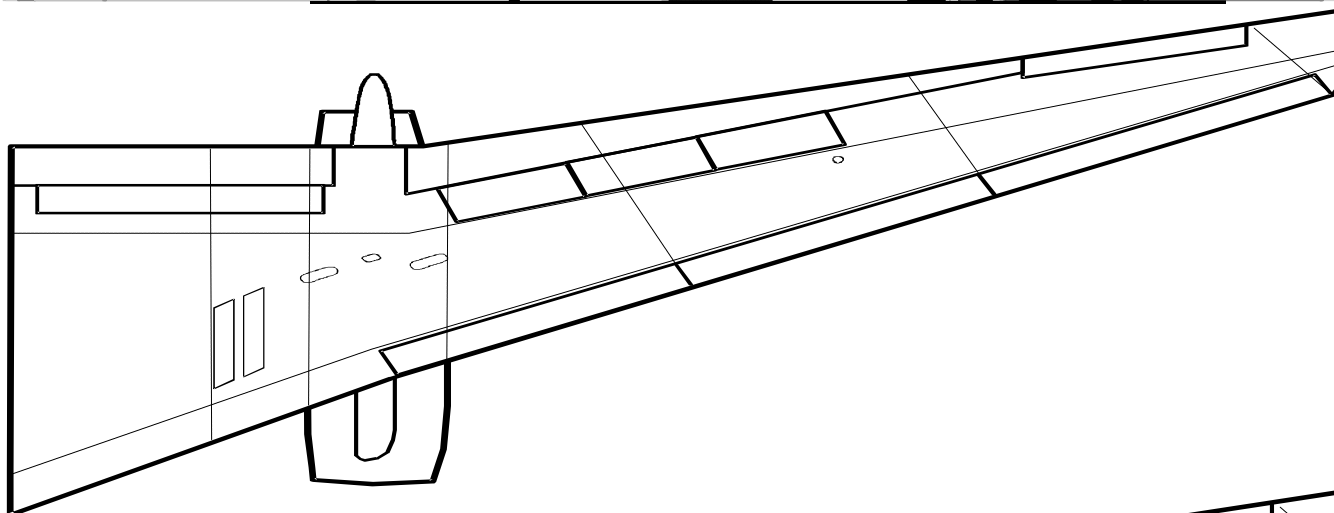

TIME: _____

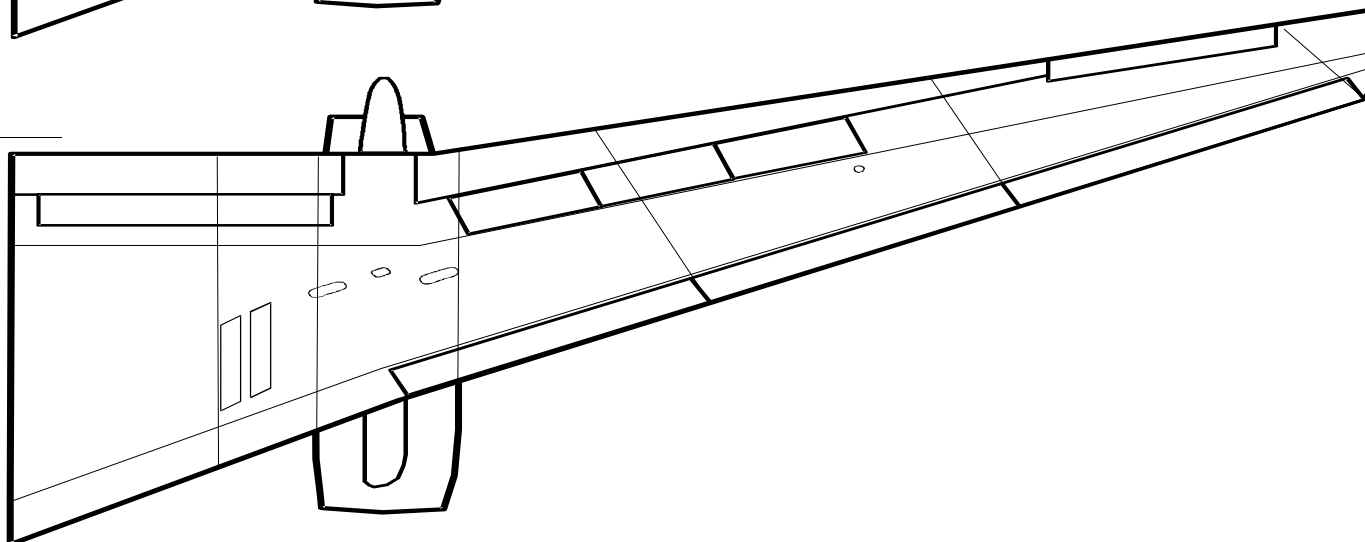

FIGURE 5 - B737 Stbd.
FLUID FAILURE FORM FOR LEADING EDGE AND WING OBSERVERS
FIELD TRIALS FOR TYPE I TEST PROTOCOL

REMEMBER TO SYNCHRONIZE TIME

VERSION 10

WINTER 2000/2001

DATE: _____ RUN NUMBER: _____ SPRAY TYPE: _____

FAILURES RECORDED BY: _____

TIME: _____

DRAW Failure Contours at initial failure and every 2 to 5 minutes after.

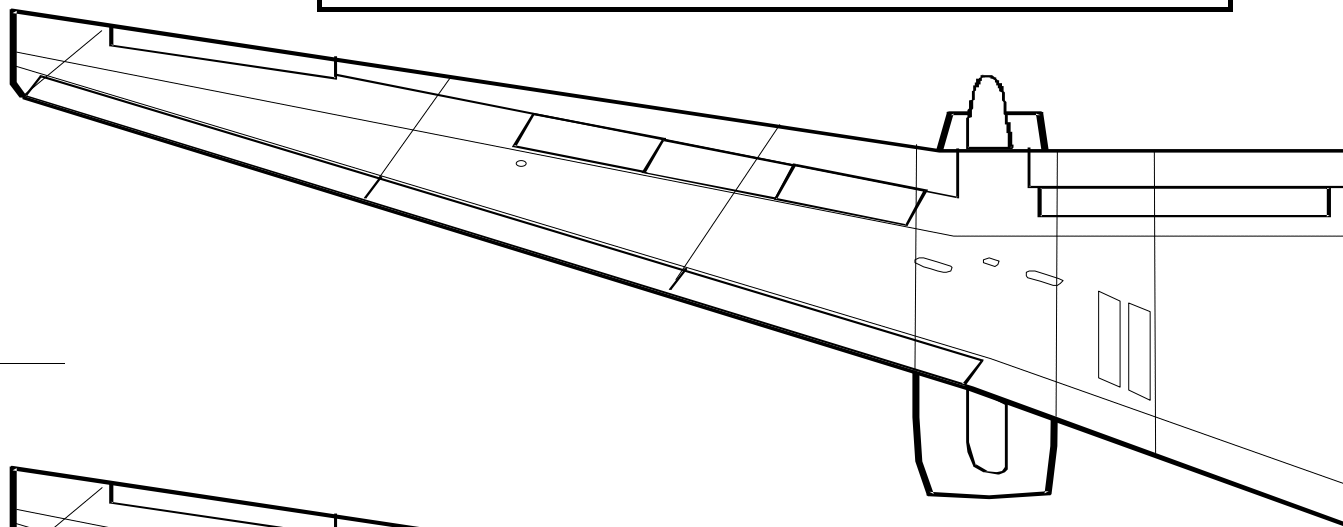

TIME: _____

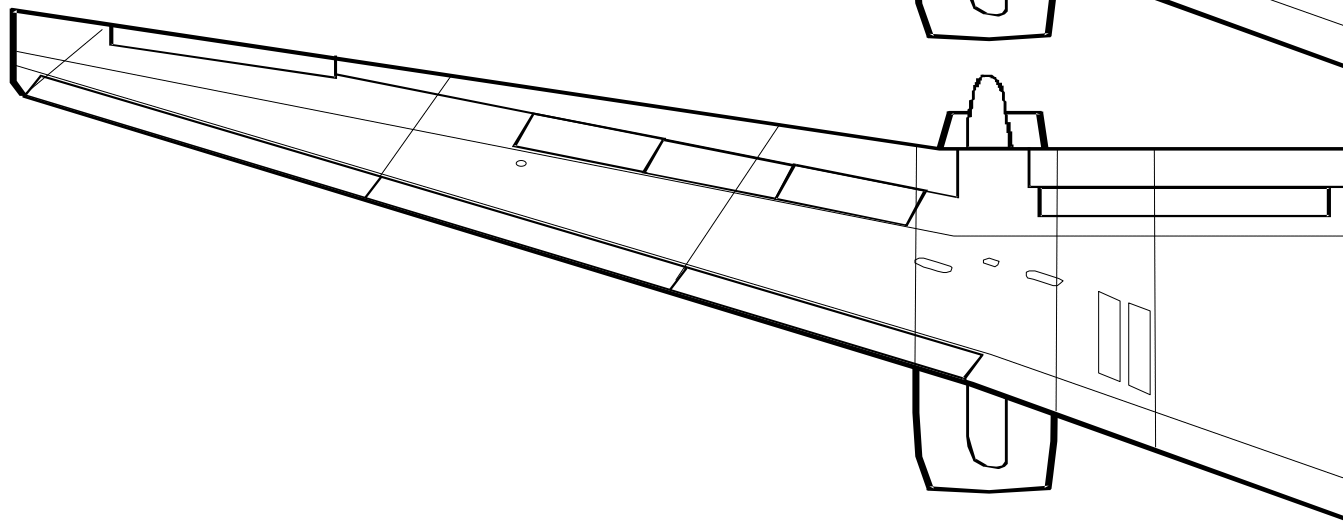

FIGURE 6 - B737
BRIX FORM FOR B737 WING TRIALS
 TYPE I TEST PROTOCOL

DATE: _____

RUN #: _____

Final Drip Line Brix: _____

Snow Depth on Wing: _____

Wing Location 4		Wing Location 5		Wing Location 11		Cold-soak BOX EG		Std. HOT Plate EG	
Time	Brix	Time	Brix	Time	Brix	Time	Brix	Time	Brix

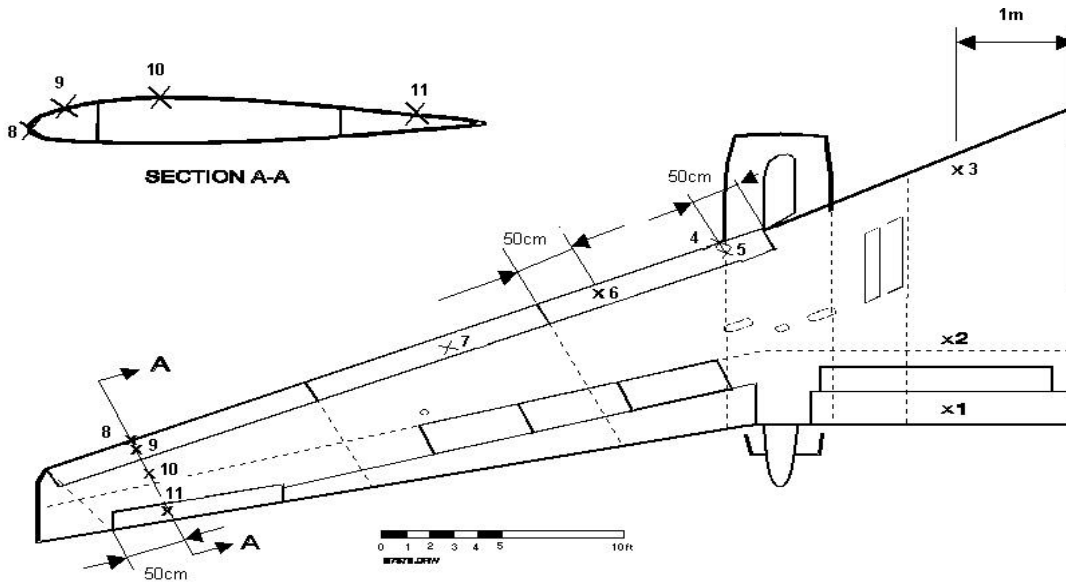

COMMENTS: _____

BRIX MEASUREMENTS BY: _____
 HANDWRITTEN BY: _____

Figure 7

END CONDITION DATA FORM

REMEMBER TO SYNCHRONIZE TIME WITH AES - USE REAL TIME

VERSION 6.0 Winter 2000/2001

LOCATION: _____ DATE: _____ RUN #: _____ STAND #: _____

CIRCLE SENSOR PLATE: u v w x y z

SENSOR NUMBER: _____

DIRECTION OF STAND: _____ °

OTHER COMMENTS (Fluid Batch, etc):

PRINT SIGN

FAILURES CALLED BY : _____

HAND WRITTEN BY : _____

TEST SITE LEADER : _____

*TIME (After Fluid Application) TO FAILURE FOR INDIVIDUAL CROSSHAIRS (hr:min)

Time of Fluid Application: _____ hr:min:ss _____ hr:min:ss _____ hr:min:ss

	Plate U	Plate V	Plate W
FLUID NAME			
B1 B2 B3	<input type="text"/>	<input type="text"/>	<input type="text"/>
C1 C2 C3	<input type="text"/>	<input type="text"/>	<input type="text"/>
D1 D2 D3	<input type="text"/>	<input type="text"/>	<input type="text"/>
E1 E2 E3	<input type="text"/>	<input type="text"/>	<input type="text"/>
F1 F2 F3	<input type="text"/>	<input type="text"/>	<input type="text"/>
TIME TO FIRST PLATE FAILURE WITHIN WORK AREA	<input type="text"/>	<input type="text"/>	<input type="text"/>
CALCULATED FAILURE TIME (MINUTES)	<input type="text"/>	<input type="text"/>	<input type="text"/>
BRIX / TEMPERATURE AT START	<input type="text"/>	<input type="text"/>	<input type="text"/>

Time of Fluid Application: _____ hr:min:ss _____ hr:min:ss _____ hr:min:ss

	Plate X	Plate Y	Plate Z
FLUID NAME			
B1 B2 B3	<input type="text"/>	<input type="text"/>	<input type="text"/>
C1 C2 C3	<input type="text"/>	<input type="text"/>	<input type="text"/>
D1 D2 D3	<input type="text"/>	<input type="text"/>	<input type="text"/>
E1 E2 E3	<input type="text"/>	<input type="text"/>	<input type="text"/>
F1 F2 F3	<input type="text"/>	<input type="text"/>	<input type="text"/>
TIME TO FIRST PLATE FAILURE WITHIN WORK AREA	<input type="text"/>	<input type="text"/>	<input type="text"/>
CALCULATED FAILURE TIME (MINUTES)	<input type="text"/>	<input type="text"/>	<input type="text"/>
BRIX / TEMPERATURE AT START	<input type="text"/>	<input type="text"/>	<input type="text"/>

**FIGURE 8 - B737 Port
 FAILED FLUID ROUGHNESS FORM
 FIELD TRIALS FOR TYPE I TEST PROTOCOL**

REMEMBER TO SYNCHRONIZE TIME

WINTER 2001/2002

DATE: _____	RUN NUMBER: _____	SPRAY TYPE: _____
RECORDED BY: _____	SIGNATURE: _____	

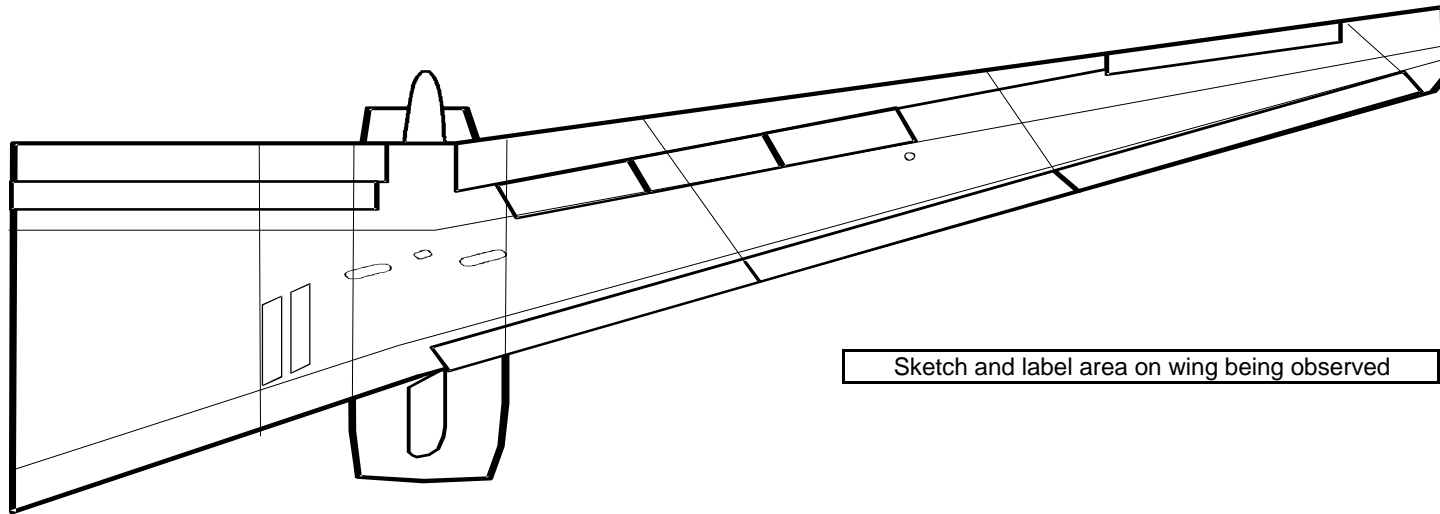

Sketch and label area on wing being observed

OBSERVED AREA	TIME	ICE HEIGHT		ADHERENCE Y / N
		MAX.	MIN.	

Figure 9
METEO/PLATE PAN DATA FORM - TYPE I PROTOCOL

REMEMBER TO SYNCHRONIZE TIME WITH AES - USE REAL TIME

VERSION 1.0 Winter 2000/2001

LOCATION: _____	DATE: _____	RUN #: _____	STAND #: _____
------------------------	--------------------	---------------------	-----------------------

PLATE PAN WEIGHT MEASUREMENTS *

PAN #	t TIME BEFORE	BUFFER TIME	t TIME AFTER	BUFFER TIME	w WEIGHT BEFORE	w WEIGHT AFTER	COMPUTE RATE ($\Delta w * 4.7 / \Delta t$)
	(hh:mm:ss)		(hh:mm:ss)		(grams)	(grams)	

*MEASUREMENTS AT 5 MIN. INTERVALS (STAGGERED).

METEO OBSERVATIONS **

TIME (hr:min)	TYPE ZR, ZL, S, SG IP, IC, BS, SP	SNOW CLASSIF. (See Fig. 3)	OAT (°C)	WIND SPEED at 2 m (km/h)

**observations at beginning, end, and every 10 min. intervals. Additional observations when there are significant changes.

COMMENTS : _____

PRINT SIGN

WRITTEN & PERFORMED BY : _____

PHOTO BY : _____

TEST SITE LEADER : _____