

HI98169

Professional pH Meter for Wine



INSTRUCTION MANUAL

Dear
Customer,

Thank you for choosing a Hanna Instruments product.

Please read this instruction manual carefully before using this meter.

This manual will provide you with the necessary information for correct use of this meter, as well as a precise idea of its versatility.

If you need additional technical information, do not hesitate to e-mail us at tech@hannainst.com or view our contact list at www.hannainst.com.

All rights are reserved. Reproduction in whole or in part is prohibited without the written consent of the copyright owner, Hanna Instruments Inc., Woonsocket, Rhode Island, 02895, USA.

TABLE OF CONTENTS

1. Preliminary Examination 5

2. General Description & Intended Use 6

3. Specifications 7

4. Functional Description 8

 4.1. Keypad Description 8

 4.2. Top View 9

5. General Operations 10

 5.1. Battery Replacement 10

 5.2. Connecting The Electrode 11

 5.3. Turning The Meter On 11

 5.4. Selecting Measurement Mode & Range 11

 5.5. Contextual Help 11

 5.6. Backlight Feature 11

6. Troubleshooting Guide 12

7. Setup 13

 7.1. General Setup 13

 7.2. pH Measurement Setup 16

8. Logging 18

 8.1. Logging the Current Data 18

 8.2. Data Management 18

 8.3. AutoEnd 19

9. PC Interface 20

 9.1. Hanna PC Software 20

 9.2. Terminal Programs 20

10. Good Laboratory Practice (GLP) 24

 10.1. Last pH Calibration Data 24

 10.2. Expired Calibration 24

11. Electrode Maintenance 25

 11.1. Preparation Procedure 25

 11.2. Storage Procedure 26

 11.3. Periodic Maintenance 26

 11.4. Ph Cleaning Procedure 26

12. pH 27

 12.1. pH Calibration 27

 12.2. pH Measurement 29

 12.3. pH Measurement Messages & Warnings..... 30

 12.4. Temperature Measurements 31

13. mV..... 32

 13.1. mV Measurement..... 32

 13.2. Relative mV Calibration 32

 13.3. Relative mV Mode..... 32

 13.4. mV Measurement Messages & Warnings..... 33

14. mV & Temperature Calibration (for technical personnel only) 34

 14.1. Temperature Calibration..... 34

 14.2. mV Calibration..... 35

15. Accessories..... 36

Certification..... 38

Recommendations For Users..... 38

Warranty 38

1. PRELIMINARY EXAMINATION

Remove the instrument and accessories from the packaging and examine it carefully. For further assistance please contact your local Hanna Instruments Customer Office or email us at tech@hannainst.com.

Each [HI98169](#) is delivered in a rugged carrying case and is supplied with:

- [FC10483](#) preamplified pH/temperature probe with glass body and DIN connector with 1 m (3.3') cable
- pH 3.00 Buffer solution (2 sachets)
- pH 7.01 Buffer solution (2 sachets)
- [HI700635](#) Cleaning solution for wine deposits (1 sachet)
- [HI700636](#) Cleaning solution for wine stains (1 sachet)
- 100 mL Plastic beaker (2 pcs.)
- 1.5V AA Batteries (4 pcs.)
- [HI920015](#) Micro USB cable
- [HI720169](#) Rugged carrying case
- Winemakers guidebook
- Instrument quality certificate
- Instruction manual

Note: Save all packing material until you are sure that the instrument works correctly. Any damaged or defective item must be returned in its original packing material with the supplied accessories.

2. GENERAL DESCRIPTION & INTENDED USE

The [HI98169](#) portable pH meter together with a [FC10483](#) combination pH electrode is specifically designed to measure pH during wine production.

It is a rugged pH meter designed to provide rapid and reliable results. New diagnostic features improve reliability and accuracy of pH measurements.

Main features

- Dedicated pH probe with integrated temperature sensor
- Simultaneous pH and temperature measurements on a large LCD display
- Up to five-point pH calibration with seven standard calibration buffers and five custom buffers
- Messages and warnings are clearly displayed on the backlit LCD
- Content sensitive help is available at the touch of a button
- Micro USB port for easy data transfer to USB storage device, PC or other compatible device

Additional features

- Available log space for up to 200 samples
- Auto-hold feature, to freeze first stable reading on the LCD
- GLP feature, to view pH last calibration data

Electrode description

[FC10483](#) is a specially designed pH electrode intended for the direct determination of pH in wine production; from freshly pressed juice all the way to the final fermented product.

The [FC10483](#) pH probe features a refillable double junction reference electrode that uses a KCl electrolyte, an open junction with Clogging Prevention System (CPS™) technology, a built-in temperature sensor for temperature compensated pH readings and an integrated preamplifier to provide measurements impervious to noise and electrical interferences.

3. SPECIFICATIONS









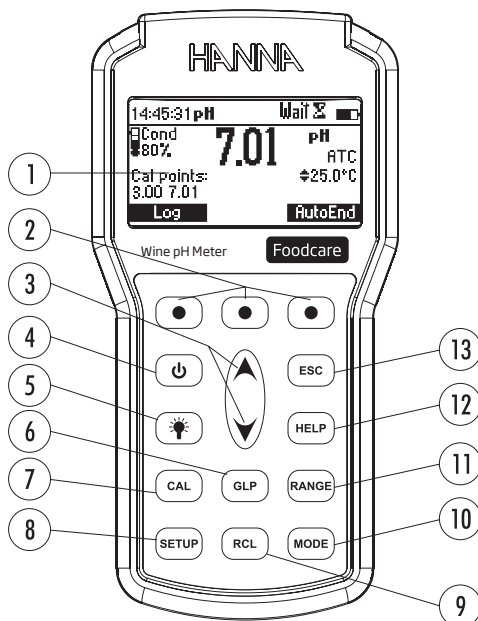



pH	Range	-2.0 to 20.0 / -2.00 to 20.00 / -2.000 to 20.000 pH
	Resolution	0.1 / 0.01 / 0.001 pH
	Accuracy	± 0.1 / ± 0.01 / ± 0.002 pH
mV	Range	± 2000.0 mV
	Resolution	0.1 mV
	Accuracy	± 0.2 mV (pH-mV)
Temperature	Range	-20.0 to 120.0 °C (-4.0 to 248.0 °F)*
	Resolution	0.1 °C (0.1 °F)
	Accuracy	± 0.4 °C (± 0.8 °F) (excluding probe error)
pH calibration	Up to five-point calibration points, seven standard buffers available (1.68, 3.00, 6.86, 7.01, 9.18, 10.01, 12.45), and five custom buffers	
Slope calibration	From 80 to 110%	
Temperature compensation	Automatic	
pH Electrode	FC10483 preamplified pH & temperature probe with glass body, DIN connector and 1 m (3.3') cable	
LOG	On demand, 200 samples (100 pH and 100 mV)	
Input impedance	10^{12} Ω	
Battery type/life	1.5V AA batteries (4 pcs.) / approx. 200 hours of continuous use without backlight (50 hours with backlight)	
Auto power off	User selectable: 5, 10, 30, 60 minutes or disabled	
PC interface	micro USB	
Dimension	185 x 93 x 35.2 mm (7.3 x 3.6 x 1.4")	
Weight	400 g (14.2 oz)	
Environment	0 to 50 °C (32 to 122 °F) max. RH 100%	
Case ingress protection rating	IP67	

*the FC10483 probe is limited to be used from 0 to 12 pH and from -5 to 60 °C temperature (23 to 140 °F)

4. FUNCTIONAL DESCRIPTION

4.1. KEYPAD DESCRIPTION



1. Liquid Crystal Display (LCD)
2.  Press the functional keys to perform the function displayed above them on the LCD
3.  Press to move up or down in a menu or help screen or increment or decrement a set value
4.  Press to turn the instrument ON and OFF
5.  Press to turn the backlight ON and OFF
6.  Press to view the GLP (Good Laboratory Practice) for the selected measurement mode
7.  Press to enter / exit calibration mode
8.  Press to enter / exit the setup screen
9.  Press to enter / exit / review logged data
10.  Press to change the pH resolution or, when in mV mode, to change between mV and Rel mV
11.  Press to toggle between pH and mV mode
12.  Press to display / exit the help screen
13.  Press to exit the current screen

4.2. TOP VIEW

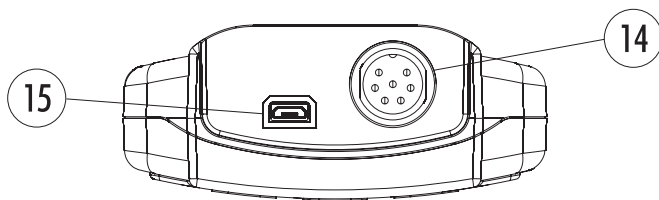

- 14. Electrode **DIN** connector
- 15. Micro USB type connector

5. GENERAL OPERATIONS

5.1. BATTERY REPLACEMENT

To replace the batteries, follow the next steps:

- Turn OFF the instrument.
- Remove the four screws on the back of the instrument to open the battery compartment.
- Remove the old batteries.
- Insert four new 1.5V AA batteries in the battery compartment while paying attention to the correct polarity.
- Close the battery compartment using the four screws.

Note: *If the battery capacity is less than 20%, the serial communication and the backlight feature are not available.*

The instrument is equipped with the BEPS (Battery Error Prevention System) feature, which automatically turns the instrument off when the battery level is too low to ensure reliable readings.

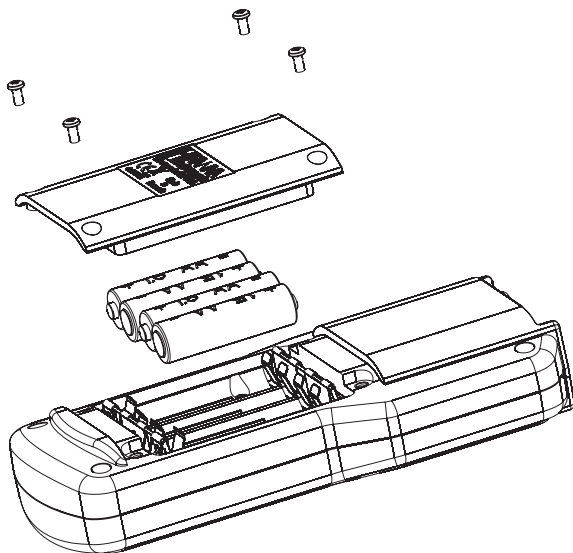

5.2. CONNECTING THE ELECTRODE

Connect the pH/temperature electrode to the DIN connector. The protective micro USB cover should be placed into the socket when the meter is not connected to a computer to ensure waterproof protection.

5.3. TURNING THE METER ON

Turn the instrument on by pressing **ON/OFF** key. At start-up the display will show the Hanna Instruments logo.

5.4. SELECTING MEASUREMENT MODE & RANGE

Press the **MODE** key while in measurement mode to change the measurement resolution. Press the **RANGE** key while in measurement mode to cycle between pH and mV.

5.5. CONTEXTUAL HELP

HI98169 offers an interactive contextual help mode that assists the user at any time.

To access the help screen press **HELP** key. The instrument will display additional information related to the current screen. To read all the available information, scroll the text using the **▲/▼** keys.

To exit help mode press **HELP** key again or **ESC** key and the meter will return to the previous screen.

5.6. BACKLIGHT FEATURE

Press the backlight key to toggle backlight features ON and OFF.



Note: The backlight automatically shuts off after a set period (for details see SETUP section).

6. TROUBLESHOOTING GUIDE

IMPORTANT: After cleaning rinse the electrode thoroughly with distilled water, refill the reference chamber with fresh electrolyte and soak the electrode in [HI70300](#) or [HI80300](#) Storage solution for at least 1 hour before taking measurements.

Symptoms	Problem	Solution
Slow response / Excessive drift	Dirty pH electrode	Soak the electrode tip in Hanna HI7061 General cleaning solution for 30 minutes and then follow the Cleaning Procedure.
Reading fluctuates up and down (noise).	Clogged/dirty junction Low electrolyte level	Clean the electrode. Refill with fresh electrolyte.
Display shows full-scale value blinking.	Reading out of range	Check that sample is within measurable range.
Display shows "Clean electrode" blinking.	Difference between new and previous calibration has been detected.	Clean electrode and recalibrate. If the problem remains, check the buffer solutions.
Meter fails to calibrate or gives faulty readings.	Broken pH electrode	Replace electrode.
Error messages are displayed during pH calibration procedure.	Wrong or contaminated buffer, electrode dirty or broken	Check that buffer solution is correct and fresh.
Meter shuts off.	Dead batteries Auto-off feature is enabled: in this case, meter shuts off after selected non-use period.	Replace the batteries. Turn the meter on.
"Errxx" message at start up	Internal error	Contact your local Hanna Instruments Office.
The instrument does not start when pressing the ON/OFF key.	Initialization error	Press and hold down the ON/OFF key for about 20 seconds or remove and replace the batteries.

7. SETUP

Setup mode allows parameters, that do not directly relate to measurement, to be viewed and modified. Press **SETUP** key to enter Setup menu, highlight desired option using the ▲/▼ keys.

7.1. GENERAL SETUP

Temperature Unit

Option: °C or °F (default option: °C)

Press the displayed functional key in order to change the temperature unit.

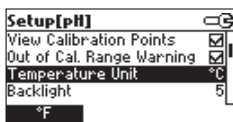

Backlight

Option: 0 to 7 (default option: 4)

Press **Modify** to enter backlight intensity setup screen.

Use ←/→ functional keys or the ▲/▼ keys to increase or decrease the intensity. Press **Accept** to confirm or press **ESC** key to leave without saving.

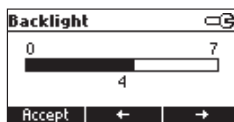

Contrast

Option: 0 to 20 (default option: 10)

Press **Modify** to enter contrast level setup screen.

Use ←/→ functional keys or the ▲/▼ keys to increase or decrease the contrast. Press **Accept** to confirm or press **ESC** key to leave without saving.

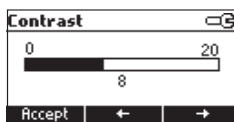
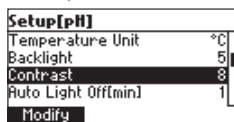

Auto Light Off (min.)

Option: 1, 5, 10, 30 min. (default option: 1 min.)

Press allocated functional key to change required auto light off.

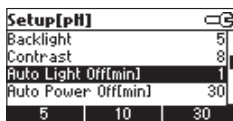

Auto Power Off (min.)

Option: Disabled, 5, 10, 30, 60 min. (default option: 30 min.)

Press **Modify** to enter auto power off setup screen.

Use $\blacktriangle/\blacktriangledown$ keys to select the desired interval. Press **Accept** to confirm or press **ESC** key to leave without saving.

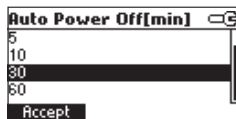

Date/Time

Option: 01.01.2000 to 12.31.2099, 00:00 to 23:59 (default option: current date/time)

Press **Modify** to enter date and time setup screen.

Use \leftarrow/\rightarrow functional keys to highlight the value to be modified (year, month, day, hour, minute or second). Use $\blacktriangle/\blacktriangledown$ keys to change the value. Press **Accept** to confirm new setting or **ESC** key to leave without saving.

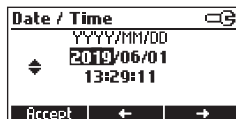
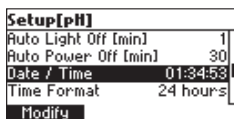

Time Format

Option: AM/PM or 24 hours (default option: 24 hours)

Press the functional key to change to desired time format.

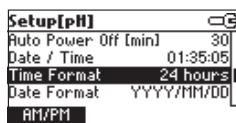

Date Format

Option: DD/MM/YYYY; MM/DD/YYYY; YYYY/MM/DD; YYYY-MM-DD; Mon DD, YYYY; DD-Mon-YYYY; YYYY-Mon-DD (default option: YYYY/MM/DD)

Press **Modify** to access date format setup screen.

Use the $\blacktriangle/\blacktriangledown$ keys to select the desired date format. Press **Accept** to confirm or press **ESC** key to leave without saving.

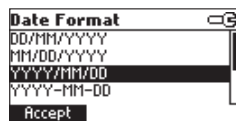
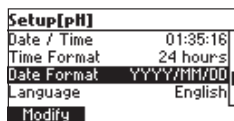

Language

Option: English, Italiano, Português, Español (default option: English)

Press the allocated functional key to select the desired language.

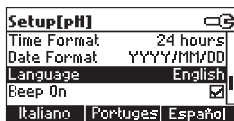

Beep ON

Option: Enabled or Disabled (default option: Disabled)

When enabled, a short beep is heard every time a key is pressed. A long beep alert sounds when the pressed key is not active or an error is detected.

Press the functional key to enable/disable the beeper.

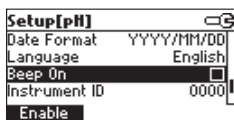

Instrument ID

Option: 0000 to 9999 (default option: 0000)

This option is used to set the instrument's ID (identification number).

Press **Modify** to enter instrument ID setup screen.

Use the $\blacktriangle/\blacktriangledown$ keys to change the instrument ID. Press **Accept** to confirm or press **ESC** key to leave without saving.

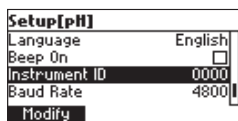

Baud Rate

Option: 600, 1200, 2400, 4800, 9600 (default option: 9600)

Press **Modify** to access baud rate setup screen.

Use the $\blacktriangle/\blacktriangledown$ keys to change to the desired communication baud. Press **Accept** to confirm or press **ESC** key to leave without saving.

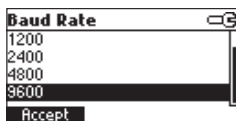
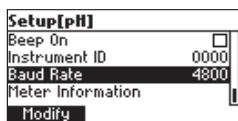

Meter information

Press **Select** to view the firmware, language, mV and temperature factory calibration time and date, battery capacity. Press **ESC** key to return to the Setup menu.

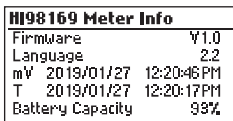
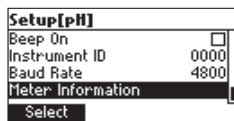

7.2. pH MEASUREMENT SETUP

The following parameters are directly related to pH measurement mode and are only visible when pH measurement is selected.

Calibration Timeout

Option: Disabled, 1 to 7 days (default option: Disabled)

Press **Modify** to enter the calibration timeout screen. Use the **▲/▼** keys to select the desired option. Press **Accept** to confirm or press **ESC** key to leave without saving.

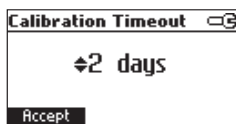
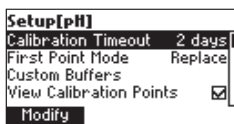

Note: If enabled, “CAL DUE” warning will be displayed after the selected time has elapsed.

First-Point Mode

Option: Replace or Offset (default option: Replace)

Press the functional key to change to desired option.

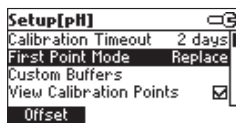

If *Replace* is selected and a one-point calibration is done, the new buffer will replace the existing buffer and the slopes will be adjusted.

If *Offset* is selected and a one-point calibration is done, the meter will update the offset and the slope will not be updated.

Custom Buffers

Option: 1 to 5

Press **Modify** to access custom buffers screen.

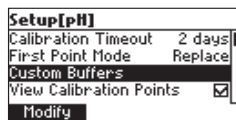

Press **Add** to add a custom buffer to the list (maximum five).

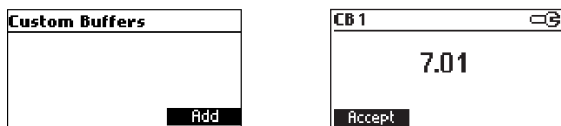

Use the **▲/▼** keys to change the custom buffer value. Press **Accept** to confirm the value or press **ESC** key to leave without saving.

If custom buffers have been added previously, use the **▲/▼** keys to select a calibration buffer.

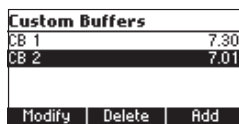

Press **Modify** to edit the buffer value.

Press **Delete** to delete the selected custom buffer from the list.

Press **Add** to add buffer to the list (maximum five).

View Calibration Points

Option: Enabled or Disabled (default option: Enabled)

Press the functional key to change to desired option.

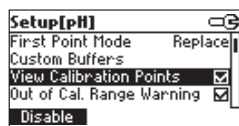

If enabled, the buffers used in the last calibration are displayed on the pH measurement screen.

Out of Calibration Range

Option: Enabled or Disabled (default option: Enabled)

Press the functional key to change to desired option.

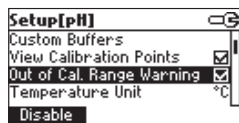

If enabled, when the pH reading is outside the calibration range, the “Out of calibration range” message is displayed.

8. LOGGING

The meter can hold up to 200 log on demand data points (100 pH and 100 mV). All logged data can be transferred to a PC through the USB port using the [HI9200](#) application.

8.1. LOGGING THE CURRENT DATA

To store the current reading press **Log** while in measurement mode. Data points are added to the log file every time **Log** is pressed.

The instrument will display the record number for few seconds and percentage of available space. If the log space is full, the “Log space is full” message will be displayed for few seconds when **Log** functional key is invoked. Enter View Logged Data Mode and delete records in order to free log space.

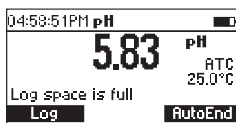
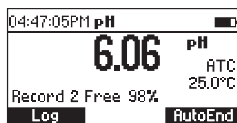

8.2. DATA MANAGEMENT

You can view, export, delete data by pressing **RCL** key.

Use the **▲/▼** keys to scroll between stored data points.

To delete all of the data points, press **Delete All**. To delete the selected data point, press **Delete**.

	pH	Date
1	6.06	2019/01/18
2	6.06	2019/01/18
3	6.06	2019/01/18
4	6.06	2019/01/18

Delete All Delete More

A confirmation screen will be displayed, press **CFM** to continue or press **ESC** key to return to the previous screen.

Delete Record?		
1	6.06	2019/01/18
2	6.06	2019/01/18
3	6.06	2019/01/18
4	6.06	2019/01/18

CFM

To view additional information about the selected data point, press **More**.

Record number: 1	
2019/06/01	02:38:06
6.06pH	23.4°C
78mV	
Offset: 78mV	
Slope: 100.0%	

↓

If no data was logged, the instrument will display “No Records!” message.

8.3. AUTOEND

To freeze the first stable reading in measurement mode, press **AutoEnd**. The hourglass symbol appears with “Wait” blinking until a stable reading is obtained. Once the reading is stable “Hold” is displayed.

05:10:48PM	pH	Wait	⌚	■
Cond	80%	7.01	pH	ATC
Cal points:				25.0°C
	3.00	7.01		
Log			Continue	

05:10:48PM	pH	Hold	■	■
Cond	80%	7.01	pH	ATC
Cal points:				25.0°C
	3.00	7.01		
Log			Continue	

Press **Continue** to enter continuous reading mode.

9. PC INTERFACE

9.1. HANNA PC SOFTWARE

The HI92000 PC application supports communications between the meter and PC. The PC compatible software is available for download at <http://software.hannainst.com>. Select the product code and click **Download Now**. After download is complete, use the **setup.exe** file to install the software.

Data can be exported to the most popular spreadsheet programs for further analysis.

To connect your instrument to a PC, use an USB cable connector. Make sure that your instrument is switched off and plug one connector to the instrument USB socket and the other to the serial or USB port of your PC.

9.2. TERMINAL PROGRAMS

If you are not using HI92000 it is also possible to remotely control the instrument with any terminal program. Use an USB cable to connect the instrument to a PC, start the terminal program and set the communication options as

8, N, 1, no flow control.

Command Types

To send a command to the instrument follow the next scheme:

<command prefix> <command> <CR>

where:

<command prefix> is the 16 ASCII character

<command> is the command code.

Note: Either small or capital letters can be used.

Simple Commands

KF1	equivalent to pressing functional key 1
KF2	equivalent to pressing functional key 2
KF3	equivalent to pressing functional key 3
RNG	equivalent to pressing RANGE key
MOD	equivalent to pressing MODE key
CAL	equivalent to pressing CAL key
UPC	equivalent to pressing the UP arrow key
DWC	equivalent to pressing the DOWN arrow key
RCL	equivalent to pressing RCL key
SET	equivalent to pressing SETUP key
CLR	equivalent to pressing CLR key
OFF	equivalent to pressing OFF key

CHR xx Change the instrument range according with the parameter value (xx):

- xx=00 pH range/0.001 resolution
- xx=01 pH range/0.01 resolution
- xx=02 pH range/0.1 resolution
- xx=03 mV range

The instrument will answer for these commands with:

<STX> <answer> <ETX>

where:

<STX> is 02 ASCII code character (start of text)

<ETX> is 03 ASCII code character (end of text)

<answer>

<ACK> is 06 ASCII code character (recognized command)

<NAK> is 21 ASCII code character (unrecognized command)

<CAN> is 24 ASCII code character (corrupted command)

Commands Requiring an Answer

The instrument will answer for these commands with:

<STX> <answer> <checksum> <ETX>

where

<checksum> is the bytes sum of the answer string sent as 2 ASCII characters.

All the answer messages are with ASCII characters.

RAS Causes the instrument to send a complete set of readings in according with the current range; pH, temperature and mV reading pH range.

The answer string contains:

- Meter mode (2 chars):
 - 00 - pH range (0.001 resolution)
 - 01 - pH range (0.01 resolution)
 - 02 - pH range (0.1 resolution)
 - 03 - mV range
- Meter status (2 chars of status byte): represents a 8 bit hexadecimal encoding.
 - 0x10 - temperature probe is connected
 - 0x01 - new GLP data available
 - 0x02 - new SETUP parameter
 - 0x04 - out of calibration range
 - 0x08 - the meter is in autoend point mode
- Reading status (2 chars): R - in range, O - over range, U - under range. First character corresponds to the primary reading. Second character corresponds to mV reading.
- Primary reading (corresponding to the selected range) - 11 ASCII chars, including sign and decimal point and exponent.

- Secondary reading (only when primary reading is not mV) - 7 ASCII chars, including sign and decimal point.
- Temperature reading - 7 ASCII chars, with sign and two decimal points, always in °C.

MDR

Requests the instrument model name and firmware code (16 ASCII chars).

GLP

Requests the calibration data record.

The answer string contains:

- GLP status (1 char): represents a 4 bit hexadecimal encoding.
 - 0x01 - pH calibration available
- pH calibration data (if available), which contains
 - the number of calibrated buffers (1 char)
 - the offset, with sign and decimal point (7 chars)
 - the average of slopes, with sign and decimal point (7 chars)
 - the calibration time, **yymmddhhmmss** (12 chars)
 - buffers information (for each buffer)
 - type (1 char): 0 - standard, 1 - custom
 - status (1 char): N (new) - calibrated in last calibration; O (old) - from an old calibration
 - warnings during calibration (2 chars): 00 - no warning, 04 - "Clean Electrode" warning
 - buffer value, with sign and decimal point and exponent (11 chars)
 - calibration time, yymmddhhmmss (12 chars)
 - electrode condition, with sign (3 chars). The "-01" code means not calculated

PAR

Requests the setup parameters setting.

The answer string contains:

- Instrument ID (4 chars)
- Calibration Alarm time out for pH (2 chars)
- SETUP information (2 chars): 8 bit hexadecimal encoding.
 - 0x01 - beep ON (else OFF)
 - 0x04 - degrees Celsius (else degrees Fahrenheit)
 - 0x08 - Offset calibration (else Point calibration)
- Auto Light Off time (3 chars)
- Auto Power Off time (3 chars)
- The number of custom buffers (1 char)
- The custom buffer values, with sign and decimal point, for each defined custom buffer (7 chars)
- The short name of the selected language (3 chars)

NSLx Requests the number of logged samples (4 chars).

The command parameter (1 char)

- P - request for pH range

LODPxxx Requests the xxxth pH record logged data.

LODPALL Requests all pH Log on demand.

The answer string for each record contains

- The logged mode (2 chars)
 - 00 - pH range (0.001 resolution)
 - 01 - pH range (0.01 resolution)
 - 02 - pH range (0.1 resolution)
 - 03 - mV range
- Reading status (1 char): R, O, U
- Calculated reading, with sign and decimal point and exponent (11 chars) - for pH
- Temperature reading, with sign and two decimal points (7 chars)
- mV reading status (1 char): R, O, U
- The mV reading, with sign and decimal point (7 chars)
- The logged time, yymmddhhmmss (12 chars)
- The calibration slope, with sign and decimal point (7 chars)
- The calibration offset, with sign and decimal point (7 chars)
- Temperature probe presence (1 char)

Notes: "Err8" is sent if the instrument is not in measurement mode.

"Err6" is sent if the requested range is not available.

"Err4" is sent if the requested set parameter is not available.

"Err3" is sent if the Log on demand is empty.

"Err9" is sent if the battery power is less than 30%.

Invalid commands will be ignored.

10. GOOD LABORATORY PRACTICE (GLP)

GLP is a set of functions that allows storage and retrieval of data regarding the maintenance and status of the electrode.

All data regarding the pH calibration is stored for the user to review when necessary.

10.1. LAST PH CALIBRATION DATA

The last pH calibration data is stored automatically after a successful calibration.

To view the pH calibration data, press **GLP** when the instrument is in the measurement mode.

Last pH cal	Buffer(pH)
Date: 2019/05/31	7.01*
Time: 10:03:04	3.00
Cal Expire: Disabled	7.01
Offset: -1.4mV	
Aver. Slope: 99.3%	

The instrument will display a lot of data including calibration buffer, offset, slope, electrode condition.

Note: Highlighted buffers are from previous calibrations. The custom buffers are marked with an "*" on the right side of the buffer value. "No user calibration" message is displayed if all calibrations are cleared or the instrument was not calibrated.

10.2. EXPIRED CALIBRATION

The instrument is provided with a real time clock (RTC), in order to monitor the time elapsed since the last pH calibration.

The calibration timeout is reset every time the instrument is calibrated. The "Expired Calibration" message will be displayed in the GLP screen and "CAL DUE" tags will blink on the measurement screen after the set time has elapsed, to warn the user that the instrument should be recalibrated.

If the meter is not calibrated or the calibration has been reset to default values, only the "CAL DUE" tags will blink.

Note: If an abnormal condition is detected in the RTC, the instrument forces the "Expired Calibration" status.

11. ELECTRODE MAINTENANCE

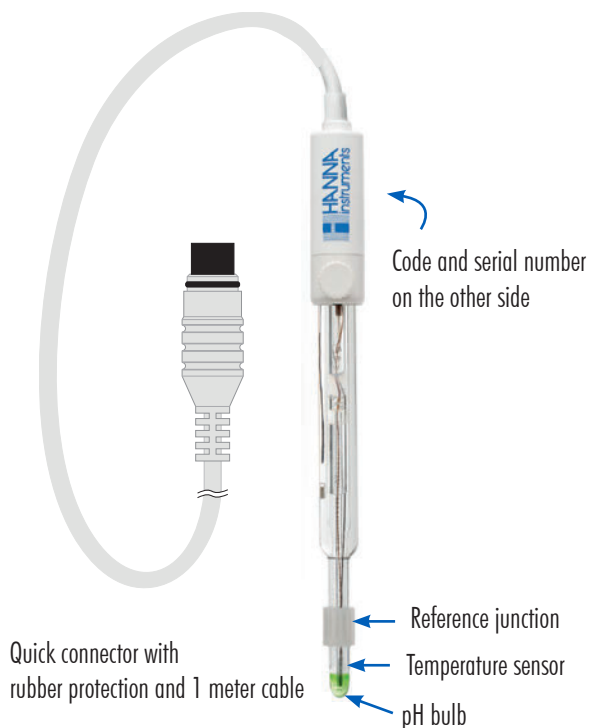

11.1. PREPARATION PROCEDURE

1. Remove the protective cap. Do not be alarmed if salt deposits are present, this is normal. Rinse the electrode with water.
2. Shake the electrode down as you would do with a clinical thermometer to eliminate any air bubbles inside the glass bulb.
3. Remove the fill hole cover to ensure the reference junctions are flowing. Set aside for storage.
4. Top off the electrolyte filling solution using Hanna [HI7082](#) Electrolyte solution.
5. If the glass bulb and/or junction are dry, soak the electrode in [HI70300](#) Storage solution for a minimum of 30 minutes.
6. Rinse with water and calibrate before using.

For a faster response and to avoid cross-contamination of the samples, before taking measurements, rinse the electrode tip with a few drops of the solution to be tested.

11.2. STORAGE PROCEDURE

To ensure a quick response, the glass bulb and the junction should be kept moist and not allowed to dry.

Add a few drops of [HI70300](#) Storage solution or pH 3.00 buffer to the protective cap. Follow preparation steps above before taking measurements. Replace the storage cap when the electrode is not in use.

Note: *Never store the electrode in distilled or deionized water.*

11.3. PERIODIC MAINTENANCE

1. Inspect the electrode for any scratches or cracks. If any are present, replace the electrode.
2. Inspect the cable. The connection cable and insulation must be intact.
3. Connectors should be clean and dry.
4. Rinse off any salt deposits with water.
5. Follow the storage procedure above.

11.4. PH CLEANING PROCEDURE

1. Soak the electrode in Hanna [HI7061](#) General cleaning solution or [HI700635](#) Cleaning solution for wine deposits or [HI700636](#) Cleaning solution for wine stains for 20 minutes. Rinse the electrode with water.
2. Soak the electrode in [HI70300](#) Storage solution for a minimum of 30 minutes, rinse with water and calibrate before using.

12. pH

12.1. PH CALIBRATION

For high accuracy, frequent calibrations are recommended.

Additionally, the pH range should be recalibrated:

- whenever the pH electrode is replaced
- at least once a week
- after testing aggressive chemical,
- if "CAL DUE" tag is blinking (if enabled)
- if "Out of calibration range" message blinks during measurement (if enabled).

HI98169 offers a choice of seven standard buffers (pH 1.68, 3.00, 6.86, 7.01, 9.18, 10.01 and 12.45) and up to five custom buffers.

For accurate pH measurements a five-point calibration is recommended, a minimum of a two-point calibration is suggested.

The instrument will automatically skip the buffers used during calibration and the buffers which are in a ± 0.2 pH window around one of the calibrated buffers.

Clear Calibration

To clear the previous calibrations, press the **CAL** key, then press **Clear**. All of the old calibration data is cleared and the calibration continues. If the calibration is cleared before confirming the first calibration point the instrument returns to the measurement mode.

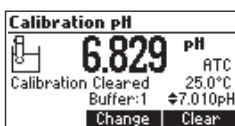

Custom Buffers

Custom buffers are set to the value at 25 °C. When calibrating with custom buffers the buffer value can be modified by pressing **Custom**. Use the \blacktriangle / \blacktriangledown keys to change the buffer value (± 1.00 pH) based on the temperature reading. Press **Accept** to save the value or press the **ESC** key to return to the calibration screen.

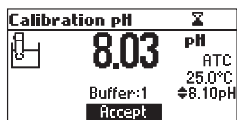
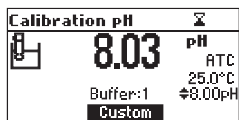

Mili pH Buffers

Mili pH buffers are only available if the pH resolution is set to 0.001 pH when you enter calibration. The exact value of the mili pH buffer is reported in the label, buffers can be modified in a ± 0.020 pH window.

Press **Change** to modify the buffer value. Use the $\blacktriangle/\blacktriangledown$ keys to change the buffer value. Press **Accept** to save the value or press the **ESC** key to return to the calibration screen.

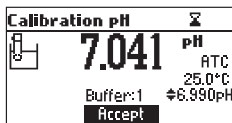
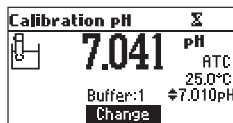

Calibration

Calibration can be performed directly in the sachets or using clean beakers.

1. Immerse the pH electrode approximately 4 cm (1½") into a buffer solution and stir gently.

Note: When using beakers, in order to minimize cross-contamination, use two beakers for each buffer solution: one for rinsing the electrode and one for calibration.

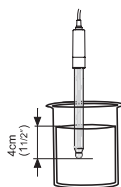

2. Press the **CAL** key. The instrument will display the measured pH, the first expected buffer and the temperature reading.

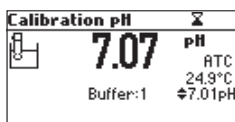

3. If necessary, use the $\blacktriangle/\blacktriangledown$ keys to select a different buffer value. The "⊗" tag will blink on the LCD until the reading is stable. After the reading has stabilized and is within the range of the selected buffer, **CFM** functional key is displayed.

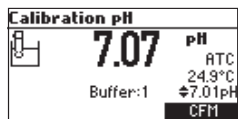

4. Press **CFM** to confirm first point. The calibrated value and the second expected buffer value are then displayed on the LCD.

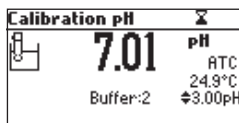

- Press the **CAL** or **ESC** key to save the current calibration.
- To continue calibrating with additional buffers, rinse and submerge the electrode approximately 4 cm (1½") into the next buffer solution and stir gently. Follow the procedure above to add the buffer to the calibration.

Electrode Condition

The display is provided with an icon and a numeric value (unless the feature is disabled) which gives an indication of the electrode status after calibration.

The "condition" remains active until the end of the calibration day.

Note: The electrode condition is evaluated only if current calibration includes at least two standard buffers.

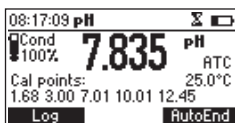

12.2. PH MEASUREMENT

To take a pH measurement remove the electrode protective cap and immerse the tip of the electrode (4 cm/1½") into the sample to be tested.

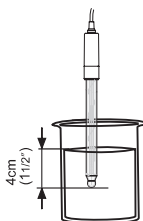

Press **RANGE** key to choose between pH and mV ranges and use **MODE** key to select the pH resolution. The hourglass symbol will turn off when the reading is stable. After the reading has stabilized, the pH screen will display:

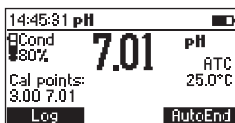

- pH reading with the selected resolution
- temperature reading displayed in Celsius degrees (°C) or Fahrenheit degrees (°F)
- electrode condition on calibration day (if available)
- the buffers used in last pH calibration (if enabled)
- battery level indicator
- available functional keys

For improved accuracy, calibration of the instrument is recommended (see pH Calibration section details). When not in use, add a few drops of Storage solution to the protective cap to keep the electrode hydrated. Ensure the electrode is rinsed thoroughly with the sample to be measured before use. As pH readings are directly affected by temperature, it is recommended to allow the sample and the pH electrode to reach thermal equilibrium.

12.3. PH MEASUREMENT MESSAGES & WARNINGS

Wrong Buffer

The pH reading is not within range of the selected buffer. Select another buffer using the ▲/▼ keys or use fresh buffer solution.

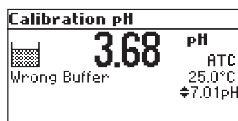

Electrode Dirty/Broken alternatively with Buffer Contaminated

The offset of the electrode is not within the accepted range. Check if the electrode is broken. If it is not broken, clean the electrode by following the cleaning procedure (see Electrode Maintenance section for details). Use fresh buffer solution or select a different buffer.

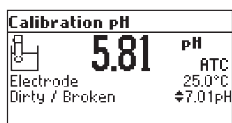
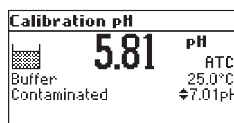

Wrong Slope

The current slope is under 80% or over 110% of the default slope. Recalibrate the instrument using fresh buffers.

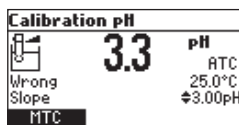
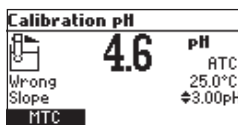

Wrong Old Slope

An inconsistency between new and previous (old) calibration is detected. Clear old calibration parameters and proceed with the calibration from the current point. The instrument will keep all confirmed values during current calibration.

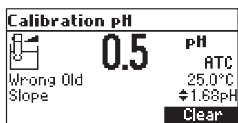

Note: Each time a buffer is confirmed, the new calibration parameters replace the old calibration parameters of the corresponding buffer.

If the current confirmed buffer has no equivalent within stored calibration buffers and it is not full, the current buffer is added to the existing stored calibration buffers.

If the existing stored calibration is full (five calibration points), after confirming the calibration point, the instrument will ask which buffer will be replaced by current buffer.

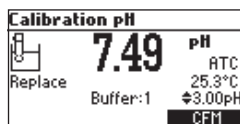

Use ▲/▼ keys to select another buffer to be replaced.

Press **CFM** to confirm the buffer that will be replaced.

Press **CAL** or **ESC** key to leave replace mode. In this case, the buffer will not be stored.

Note: The replaced buffer is not removed from calibration list and can be selected for the next calibration points.

Clean Electrode

Each time pH calibration is performed, the instrument compares the new calibration with the previously stored one.

When a significant difference is seen, the “Clean Electrode” warning message is displayed to advise the user that the pH electrode may need to be cleaned (see Electrode Maintenance section for details).

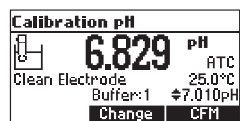

After the electrode has been cleaned, perform a new calibration.

Note: If the calibration data is cleared, the comparison is done with the default values.

12.4. TEMPERATURE MEASUREMENTS

For **HI98169** the temperature sensor is integrated in the **FC10483** probe.

Note: The temperature can be displayed in Celsius degrees (°C) or in Fahrenheit degrees (°F) (for details see the **SETUP** section).

13. MV

13.1. MV MEASUREMENT

Submerge the electrode tip (4 cm/1½") into the sample to be tested and wait a few seconds for the reading to stabilize. mV measurements are generated by the pH electrode and are displayed with 0.1 mV resolution.

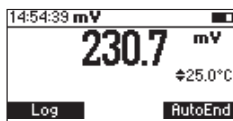

13.2. RELATIVE MV CALIBRATION

1. Press **CAL** when the instrument is in mV measurement mode. The relative mV value and the temperature values are displayed.
2. Use the $\blacktriangle/\blacktriangledown$ keys if you want to change the displayed relative mV value.

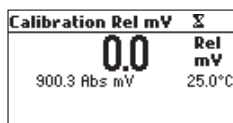

3. After the reading has stabilized and the relative mV offset is inside the offset window (± 2000 mV), **CFM** functional key is displayed. Press **CFM** to confirm relative mV calibration. The instrument will return to measurement mode.

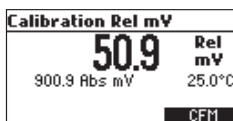

13.3. RELATIVE MV MODE

To enter relative mV mode, press **MODE** while in mV measurement mode. The Relative mV reading will be displayed along with the absolute mV value and the current temperature readings. The relative mV reading is equal to the difference between the absolute mV input value and relative mV offset established in the relative mV calibration.

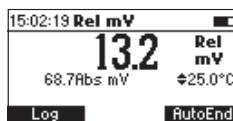

13.4. MV MEASUREMENT MESSAGES & WARNINGS

Wrong Relative Offset

The absolute mV reading is out of range or the relative mV offset is out of the offset window. Change the input value or the relative mV value to complete the calibration process.

Calibration Rel mV	
-1200.0	Rel mV
901.2 Abs mV	25.0°C
Wrong relative offset	

14. MV & TEMPERATURE CALIBRATION (FOR TECHNICAL PERSONNEL ONLY)

All instruments are factory calibrated. Calibration is only required if the temperature or mV measurements are inaccurate.

Recalibration should only be performed by technical personnel. Contact your local Hanna Instruments Office or follow the instructions below to recalibrate the instrument.

To enter technical calibration, turn the meter off, press and hold the ▲/▼ keys and press the ON/OFF key. The technical calibration screen is displayed.

Use the ▲/▼ keys to select temperature or mV. Press **Modify** to calibrate the selected option.

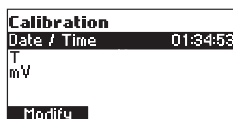

14.1. TEMPERATURE CALIBRATION

- Prepare two vessels, one with ice and water and the second with hot water (at approximately 50 °C or 122 °F). Insulate the vessels to minimize temperature changes.

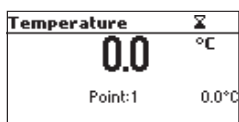

- Immerse the pH probe and a reference thermometer with 0.1 °C resolution into the vessel containing ice and water. The pH probe and the reference thermometer should be as close as possible. Allow a few seconds for the probe to stabilize.
- Use the ▲/▼ keys to set the calibration point value, measured by the reference thermometer. After the reading has stabilized and is within the range of the calibration point, press **CFM** to update the calibration point.
- The second expected calibrated point is displayed.

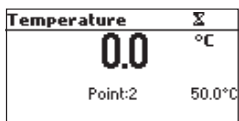

- Immerse the pH probe, and reference thermometer with 0.1 °C resolution into the vessel containing hot water. The pH probe and the reference thermometer should be as close as possible. Allow a few seconds for the probe to stabilize.

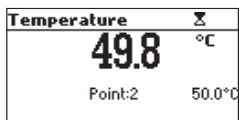

- Use the ▲/▼ keys to set the calibration point value measured by the reference thermometer.
- After the reading has stabilized and is within selected calibration range, press **CFM** to update the calibration point.

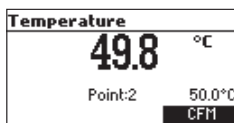

- The instrument returns to measurement mode.

Note: Use ▲/▼ keys to change calibration point if necessary (± 10.0 °C). If the reading is not within selected calibration range, “Wrong” message will blink. Change the pH probe, and restart calibration.

14.2. mV CALIBRATION

A two-point calibration can be performed at 0 mV and 1800 mV.

1. Attach a mV simulator with ± 0.1 mV to the pH connector.
2. Set the simulator to 0.0 mV.
3. Wait a few seconds for the probe to stabilize.
4. After the reading has stabilized and is within the range of the calibration point, press **CFM** to update the calibration point.
5. Set the simulator to 1800.0 mV.
6. Wait a few seconds for the probe to stabilize.
7. After the reading has stabilized and is within the range of the calibration point, press **CFM** to update the calibration point.

Notes: The “WRONG” tag will blink if the reading is not within the range of the selected calibration point. Verify calibration condition or contact your local Hanna Instruments Office if you cannot calibrate. Press **CAL** (or **ESC**) key to return to measurement mode.

15. ACCESSORIES

Electrode Cleaning Solution

Code	Description
HI70000P	Electrode rinse solution, 20 mL sachet (25 pcs.)
HI700601P	General purpose cleaning solution for laboratories, 20 mL sachet (25 pcs.)
HI70635L	Electrode cleaning solution for wine deposits, 500 mL
HI70636L	Cleaning solution for wine stains, 500 mL
HI700635P	Cleaning solution for wine deposits, 20 mL sachet (25 pcs.)
HI700636P	Cleaning solution for wine stains, 20 mL sachet (25 pcs.)
HI7061L	General purpose cleaning solution, 500 mL
HI8061L	General purpose cleaning solution, FDA approved bottle, 500 mL

pH Calibration Solution

Code	Description
HI50003-02	pH 3.00 buffer solution, 20 mL sachet (25 pcs.)
HI50007-01	pH 7.01 buffer solution, 20 mL sachet (10 pcs.)
HI50007-02	pH 7.01 buffer solution, 20 mL sachet (25 pcs.)
HI50010-01	pH 10.01 buffer solution, 20 mL sachet (10 pcs.)
HI50010-02	pH 10.01 buffer solution, 20 mL sachet (25 pcs.)
HI5016	pH 1.68 buffer solution, 500 mL
HI5003	pH 3.00 buffer solution, 500 mL
HI5068	pH 6.86 buffer solution, 500 mL
HI5007	pH 7.01 buffer solution, 500 mL
HI5091	pH 9.18 buffer solution, 500 mL

HI5010	pH 10.01 buffer solution, 500 mL
HI5124	pH 12.45 buffer solution, 500 mL
HI8006L	pH 6.86 buffer solution in FDA approved bottle, 500 mL
HI8007L	pH 7.01 buffer solution in FDA approved bottle, 500 mL
HI8009L	pH 9.18 buffer solution in FDA approved bottle, 500 mL
HI8010L	pH 10.01 buffer solution in FDA approved bottle, 500 mL

Electrode Storage Solution

Code	Description
HI70300L	Storage solution, 500 mL
HI80300L	Storage solution in FDA approved bottle, 500 mL

Other Accessories

Code	Description
FC10483	Preamplified pH/temperature probe with glass body and DIN connector with 1 m (3.3') cable
HI7082L	pH electrolyte solution for double-junction electrodes, 500 mL
HI920015	USB type A to micro USB cable
HI740155P	Electrode refilling capillary pipette (20 pcs.)
HI720169	Rugged carrying case
HI710035	Blue protective rubber boot

CERTIFICATION

All Hanna Instruments conform to the **CE European Directives**.



Disposal of Electrical & Electronic Equipment. The product should not be treated as household waste. Instead hand it over to the appropriate collection point for the recycling of electrical and electronic equipment which will conserve natural resources.

Disposal of waste batteries. This product contains batteries, do not dispose of them with other household waste. Hand them over to the appropriate collection point for recycling.

Ensuring proper product and battery disposal prevents potential negative consequences for the environment and human health. For more information, contact your city, your local household waste disposal service, or the place of purchase.



RECOMMENDATIONS FOR USERS

Before using this product, make sure it is entirely suitable for your specific application and for the environment in which it is used. Any variation introduced by the user to the supplied equipment may degrade the meter's performance. For yours and the meter's safety do not use or store the meter in hazardous environments.

WARRANTY

The **HI98169** is warranted for two years (sensors, electrodes and probes for six months) against defects in workmanship and materials when used for its intended purpose and maintained according to instructions. This warranty is limited to repair or replacement free of charge. Damage due to accidents, misuse, tampering or lack of prescribed maintenance is not covered.

If service is required, contact your local Hanna Instruments Office. If under warranty, report the model number, date of purchase, serial number (engraved on the bottom of the meter) and the nature of the problem. If the repair is not covered by the warranty, you will be notified of the charges incurred. If the meter is to be returned to Hanna Instruments, first obtain a Returned Goods Authorization (RGA) number from the Technical Service department and then send it with shipping costs prepaid. When shipping any meter, make sure it is properly packed for complete protection.

Hanna Instruments reserves the right to modify the design, construction or appearance of its products without advance notice.

World Headquarters

Hanna Instruments Inc.
Highland Industrial Park
584 Park East Drive
Woonsocket, RI 02895 USA
www.hannainst.com



MAN98169

Printed in ROMANIA