



Innovative Thinking for Power Control

OZip-AFE Intelligent Power Solution

Hardware User's Manual

UM-0058

(603) 546-0090
oztekcorp.com

11 Continental Boulevard
Merrimack NH 03054

About Oztek

Oztek Corp. is a proven innovator of power, control, and instrumentation solutions for the most demanding industrial applications. Oztek products include variable motor drives, grid tie inverters, frequency converters, standalone inverters, DC/DC converters, and DSP based control boards for power control applications.

Trademarks

OZip and OZip-R are trademarks of Oztek Corp. Other trademarks, registered trademarks, and product names are the property of their respective owners and are used herein for identification purposes only.

Notice of Copyright

Oztek OZip-AFE Intelligent Power Solution Hardware User's Manual © March 2016 Oztek Corp. All rights reserved.

Exclusion for Documentation

UNLESS SPECIFICALLY AGREED TO IN WRITING, Oztek Corp. ("Oztek")

- (A) MAKES NO WARRANTY AS TO THE ACCURACY, SUFFICIENCY OR SUITABILITY OF ANY TECHNICAL OR OTHER INFORMATION PROVIDED IN ITS MANUALS OR OTHER DOCUMENTATION.

- (B) ASSUMES NO RESPONSIBILITY OR LIABILITY FOR LOSSES, DAMAGES, COSTS OR EXPENSES, WHETHER SPECIAL, DIRECT, INDIRECT, CONSEQUENTIAL OR INCIDENTAL, WHICH MIGHT ARISE OUT OF THE USE OF SUCH INFORMATION. THE USE OF ANY SUCH INFORMATION WILL BE ENTIRELY AT THE USER'S RISK.

- (C) IF THIS MANUAL IS IN ANY LANGUAGE OTHER THAN ENGLISH, ALTHOUGH STEPS HAVE BEEN TAKEN TO MAINTAIN THE ACCURACY OF THE TRANSLATION, THE ACCURACY CANNOT BE GUARANTEED. APPROVED OZTEK CONTENT IS CONTAINED WITH THE ENGLISH LANGUAGE VERSION WHICH IS POSTED AT WWW.OZTEKCORP.COM.

Date and Revision

December 2019 Rev C

Part Number

UM-0058

Contact Information

USA

Telephone: 603-546-0090

Email techsupport@oztekc corp.com

Table of Contents

| | |
|--|-----------|
| 1. Introduction | 1 |
| 1.1 Referenced Documents | 1 |
| 1.2 General Information | 1 |
| 1.3 Safety Notices | 2 |
| 1.3.1 Definitions and Symbols | 2 |
| 1.3.2 Electrical Safety | 2 |
| 2. Shipping Information | 4 |
| 2.1 Packaged Weights | 4 |
| 2.2 Packaged Dimensions | 4 |
| 2.3 Unpacking and Inspection | 4 |
| 3. OZip-AFE Model Identifier | 5 |
| 4. Physical Characteristics | 6 |
| 4.1 Product Weights | 6 |
| 4.2 Product Dimensions | 6 |
| 4.2.1 Open Frame Plate Models (OZip-AFEA10PA*480***) | 7 |
| 4.2.2 Enclosed Cabinet Models (OZip-AFEA10CA*480***) | 9 |
| 5. Electrical Characteristics | 11 |
| 5.1 Power Circuitry | 11 |
| 5.1.1 Absolute Maximum Ratings | 11 |
| 5.1.2 Recommended Maximum Operating Conditions | 11 |
| 5.2 Control Signal Electrical Specifications | 11 |
| 5.3 Circuit Isolation | 12 |
| 6. Environmental Characteristics | 13 |
| 6.1 Operating Specifications | 13 |
| 6.2 Storage Specifications | 14 |
| 7. Open-Frame (OZip-AFEA10PA*480***) Interfaces | 14 |
| 7.1 Earth (Safety) Ground | 14 |
| 7.2 Power Interfaces | 16 |
| 7.2.1 AC Line Connections | 16 |
| 7.2.2 DC Link Connections | 17 |
| 7.2.3 Wire Sizing | 20 |
| 7.3 Signal Interfaces | 20 |
| 7.3.1 Serial Communication Interface Definition | 21 |
| 7.3.2 Customer I/O Interface Definition | 23 |
| 8. Enclosed Cabinet (OZip-AFEA10CA*480***) Interfaces | 24 |
| 8.1 Ground & Power Cable Access Ports | 25 |
| 8.2 Cabinet Emergency Stop Button | 26 |
| 8.3 Signal Interfaces | 26 |
| 8.3.1 Serial Communication Interface Definition | 27 |
| 8.3.2 Customer I/O Interface Definition | 28 |
| 9. Installation | 29 |
| 9.1 Mechanical Mounting | 29 |
| 9.2 Power Cable Connections | 30 |
| 9.3 Communication and Customer I/O Connections | 31 |
| 10. Servicing the Unit | 31 |
| 11. Maintenance and Upgrade | 31 |
| 12. Oztek Power Studio™ Tool | 31 |
| Warranty and Product Information | 33 |
| Return Material Authorization Policy | 35 |

Table of Figures

| | |
|--|----|
| Figure 1: OZip-AFE Part Number Identifier | 5 |
| Figure 2: OZip-AFEA10PA*480*** Illustration in Perspective | 7 |
| Figure 3: OZip-AFEA10PA*480*** View from Critical Sides | 8 |
| Figure 4: OZip-AFEA10CA*480*** Illustration in Perspective | 9 |
| Figure 5: OZip-AFEA10CA*480*** View from Critical Sides | 10 |
| Figure 6: Ground Stud Locations on the OZip-AFE IPS Base Plate | 15 |
| Figure 7: Power Terminal Hardware Stackup | 16 |
| Figure 8: Circuit Breaker for AC Line Connection..... | 16 |
| Figure 9: AC Line Connection Points on OZip-AFE IPS Base Plate | 17 |
| Figure 10: Compression Terminal for DC Link Connections..... | 17 |
| Figure 11: OZip-AFE IPS DC Link Positive Terminal Connection Point on Base Plate..... | 18 |
| Figure 12: OZip-AFE IPS DC Link Negative Terminal Connection Point on Base Plate | 19 |
| Figure 13: OZip-AFEA10PA*480*** Interface Assembly Illustration (11237-01) | 21 |
| Figure 14: Illustration of Communication Connector at P4 & P5 of 11237-01 | 21 |
| Figure 15: Image of Communication Connector at P4 & P5 of 11237-01..... | 22 |
| Figure 16: SW1 Setting for CAN Termination | 23 |
| Figure 17: Illustration of I/O Interface Connectors at J10-J14 of 11237-01 | 23 |
| Figure 18: Image of I/O Interface Connectors at J10-J14 of 11237-01 | 24 |
| Figure 19: OZip-AFEA10CA*480*** Cabinet Access Ports | 25 |
| Figure 20: Enclosed Cabinet Cord Grip at Each Access Port | 26 |
| Figure 21: OZip-AFEA10CA*480*** Interface Assembly Illustration (11177-01) | 27 |
| Figure 22: Illustration of Communication Connector at Cabinet Bulkhead..... | 27 |
| Figure 23: Image of Communication Connector at Cabinet Bulkhead | 28 |
| Figure 24: Illustration of I/O Interface Connector at 11177-01 | 29 |
| Figure 25: Image of I/O Interface Connector at 11177-01 | 29 |
| Figure 26: Mechanical Mounting Diagram, Models OZip-AFEA10PA*480*** | 30 |
| Figure 27: Oztek Power Studio™ GUI | 32 |

Table of Tables

| | |
|---|----|
| Table 1 – Document Acronyms | 1 |
| Table 2 – Serial Communication and Customer I/O Interface Signal Specifications | 11 |
| Table 3 – Isolation Boundary Comparison | 13 |
| Table 4 – Wire Sizing Guidelines | 20 |
| Table 5 – Serial Communication Signal Interfaces for OZip-AFEA10PA*480*** | 22 |
| Table 6 – Customer I/O Interface Signal Interfaces for OZip-AFEA10PA*480*** | 24 |
| Table 7 – Serial Communication Signal Interfaces for OZip-AFEA10CA*480*** | 28 |
| Table 8 – Customer I/O Interface Signal Interfaces for OZip-AFEA10CA*480*** | 29 |

1. Introduction

This document is intended to provide detailed specifications and instructions on how to properly install all valid configurations of the OZip-AFE Intelligent Power Solution. In order to provide for safe installation and operation of the equipment, please read the safety guidelines at the beginning of this manual and follow the procedures outlined before connecting power to the OZip-AFE IPS.

1.1 Referenced Documents

| Document | Owner | Description |
|----------|-----------------|--|
| 1776508 | Phoenix Contact | Specification for MSTB 2,5/ 2-GF-5,08 Order No.: 1776508 (extracted from online catalog) |
| UM-0052 | Oztek | Oztek Power Studio™ User's Manual |
| UM-0055 | Oztek | OZip-R Intelligent Power Module Hardware User's Manual |
| UM-0056 | Oztek | OZIP AFE/GTI Inverter User's Manual |

1.2 General Information

Throughout this document, acronyms may be employed for brevity and readability. These are summarized in Table 1.

Table 1 – Document Acronyms

| Acronym | Full Text Equivalent |
|----------------|-----------------------------|
| AC | Alternating Current |
| AFE | Active Front End |
| AWG | American Wire Gauge |
| CAN | Controller Area Network |
| DC | Direct Current |
| ESD | Electro Static Discharge |
| GTI | Grid Tie Inverter |
| GUI | Graphical User Interface |
| I/O | Input/Output |
| IPS | Intelligent Power Solution |
| RH | Relative Humidity |
| RMS | Root Mean Square |



This document applies to all valid models within the OZip-AFE Intelligent Power Solution family. Consult the Model Identifier in Section 3 for orderable part numbers. Within this manual, the

wildcard "*" is used, as appropriate, to signify a universal character which applies to any model option.

1.3 Safety Notices

The following safety notices are provided for your safety and as a means of preventing damage to the product or components in the application. Specific Dangers, Warnings, and Cautions that apply to particular activities are listed at the beginning of the relevant sections and are repeated or supplemented at critical points throughout these sections. Please read the information carefully, since it is provided for your personal safety and will also help prolong the service life of your OZip-AFE IPS and the equipment you connect to it.

1.3.1 Definitions and Symbols

| | |
|--|---|
|  DANGER | <p><i>This symbol indicates high voltage. It calls your attention to items or operations that could be dangerous to you and other persons operating this equipment. Read the message and follow the instructions carefully.</i></p> |
|  WARNING | <p>Indicates a potentially hazardous situation which, if not avoided, can result in serious injury or death.</p> |
|  CAUTION | <p>Indicates a potentially hazardous situation which, if not avoided, can result in minor to moderate injury, or serious damage to the product. The situation described in the CAUTION may, if not avoided, lead to serious results. Important safety measures are described in CAUTION (as well as WARNING).</p> |

1.3.2 Electrical Safety



DANGER

Power inverters, such as the OZip-AFE IPS, are typically connected to hazardous voltages. When servicing the OZip-AFE IPS, there may be exposed terminals at or above line potential, as well as residual charge in place for some time after the removal of the input source. Extreme care should be taken to protect against shock.

- 1. Before startup, observe the warnings and safety instructions provided throughout this manual. All power terminals should be considered to be at utility AC or high DC***

potential unless verified to be otherwise. These voltages are extremely dangerous and may cause death or severe injury if contacted.

2. *All power terminals should be considered live with the application of input voltage regardless of operating mode of the load.*
3. *Do not make any connections when the OZip-AFE IPS is connected to its power source.*
4. *Never work on the OZip-AFE IPS, power wires, or load when input power is applied.*



WARNING

1. Depending upon model, the OZip-AFE IPS may or may not be configured to disconnect AC mains and DC link voltages from the majority of the assembly in seconds after disconnecting the control bias power. If internal discharge is not assured through contactor population and control, it becomes the customer's responsibility to develop and implement a means at the application level to assure that charge is dissipated in a limited and controlled fashion for operator safety and product longevity. Regardless of configuration and depending upon system conditions outside the OZip-AFE IPS, dangerous AC voltage may remain present on the AC circuit breaker and high DC voltage may be present on the fuse and negative power terminal, respectively. Therefore, qualified personnel must make a determination that no AC mains or DC link voltage remains present on the system before any service can occur.
2. Do not make any insulation or voltage withstand tests on the OZip-AFE IPS.
3. Before servicing the unit, always ensure by measuring with a multimeter that
 - a. There is no voltage at either side of the AC contactor between the AC terminals (A, B, & C) and the base plate of the OZip-AFE IPS, considered chassis ground.
 - b. There is no voltage between the DC interface terminals (+ & -), nor between either DC terminal and the base plate, considered chassis ground. Ensure that measurements of DC+ are made to both sides of the fuse.



CAUTION

1. The OZip-AFE IPS operates on several electrical reference points, whether these be earth ground, communication ground, signal ground, etc. Proper system design with regard to equipotential bonding must be employed so that all simultaneously accessible conductive parts are electrically connected to prevent hazardous voltages appearing between them. This is accomplished by a proper factory grounding.
2. Ensure sufficient cooling for safe operation of the OZip-AFE IPS. Even so, power range capabilities will allow numerous sub-assemblies or portions thereof to reach and maintain temperatures high enough to burn skin on contact. Allow adequate time for cooling before attempting to service the unit.

3. Remove any external enabling signals before resetting system faults to prevent an unintentional restart of the OZip-AFE IPS, which could result in personal injury or equipment damage.
4. The OZip-AFE IPS is not field repairable. Never attempt to repair a malfunctioning unit; contact Oztek for a replacement.
5. Within each OZip-AFE IPS, its comprising OZip-R Intelligent Power Module is sealed with a warranty void sticker across the top cover which will tear if the cover is removed. A torn warranty void sticker shall be interpreted as unauthorized access to the internal contents of the OZip-R Intelligent Power Module, in violation of warranty terms, thereby terminating any remaining warranty otherwise in effect for the OZip-AFE Intelligent Power Solution.

2. Shipping Information

2.1 Packaged Weights

| Models | Description | Weight kgf (lbs) |
|----------------------|---|---------------------|
| OZip-AFEA10PA*480*** | 100 kW Open-Frame Plate, 480V, Fan-Cooled | 132 (291) |
| OZip-AFEA10CA*480*** | 100 kW Enclosed Cabinet, 480V, Fan-Cooled | 190 (419) |

2.2 Packaged Dimensions

| Models | Description | Length cm (in) | Width cm (in) | Height cm (in) |
|----------------------|---|-------------------|------------------|-------------------|
| OZip-AFEA10PA*480*** | 100 kW Open-Frame Plate, 480V, Fan-Cooled | 122 (48) | 102 (40) | 76 (30) |
| OZip-AFEA10CA*480*** | 100 kW Enclosed Cabinet, 480V, Fan-Cooled | 122 (48) | 102 (40) | 76 (30) |

2.3 Unpacking and Inspection



CAUTION

1. Using the provided packing list and marking on the product itself, verify that the model received corresponds to that ordered.
2. Inspect packaging for any signs of shipping damage. Immediately seek assistance from

the freight carrier for any visible signs that the packaging or product has been compromised.

3. The OZip-AFE IPS is a sensitive electronic product. While it has been designed to mitigate risks of ESD damage under normal circumstances, care should be taken not to handle electrical interfaces unnecessarily.
4. The OZip-AFE IPS is equipped with eye hooks for hoisting and movement. Lift only by these eye hooks, using equipment rated for the weight of the product.



WARNING

1. Verify that the product itself has not been damaged in shipping or handling.
2. Do not install or operate an OZip-AFE IPS which is either the incorrect model for the intended application or shows evidence of damage as a result of shipping or handling. Doing so risks serious injury to the operator and severe damage to the OZip-AFE IPS and related equipment.

3. OZip-AFE Model Identifier

Use Figure 1 to identify the model of OZip-AFE Intelligent Power Solution in question. As shown, the model would be OZip-AFEA10CAC480B, a system based on the OZip-R Intelligent Power Module platform, configured as a CAN-controlled, fan-cooled, cabinet connected to the 480V line with embedded contactors, and rated for 100 kW without any factory customization.

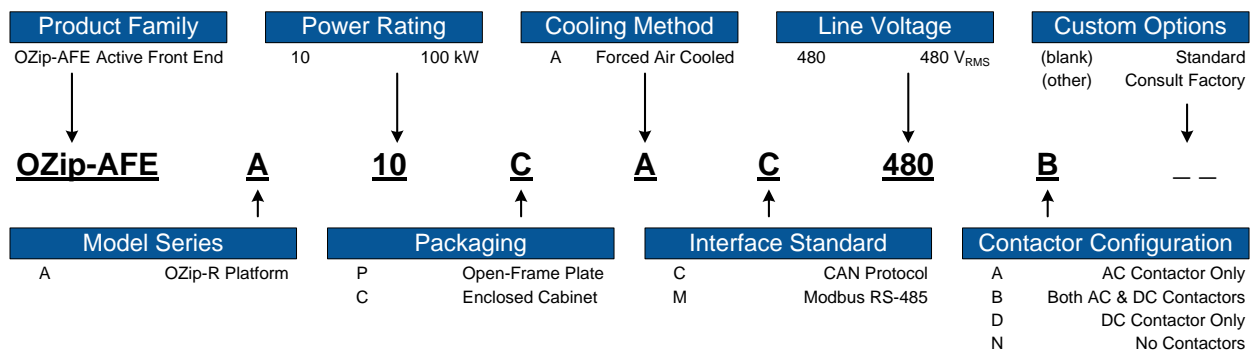

Figure 1: OZip-AFE Part Number Identifier

4. Physical Characteristics

4.1 Product Weights

| Models | Description | Weight kgf (lbs) |
|----------------------|---|---------------------|
| OZip-AFEA10PA*480*** | 100 kW Open-Frame Plate, 480V, Fan-Cooled | 93 (205) |
| OZip-AFEA10CA*480*** | 100 kW Enclosed Cabinet, 480V, Fan-Cooled | 139 (306) |

4.2 Product Dimensions

The product dimensions are associated with the selected “Packaging”, as defined by the Part Number Identifier of Figure 1. The following sections provide illustrations of the various packaging options. Consult the Oztek website (www.oztecorp.com) for the latest para-solid models of each configuration.

Note that in the representative images to follow, several subassemblies, including but not limited to power wires, interface harnesses, and mounting hardware, are omitted to avoid clutter that would otherwise obstruct the critical information intended to be provided.

4.2.1 Open Frame Plate Models (OZip-AFEA10PA*480***)

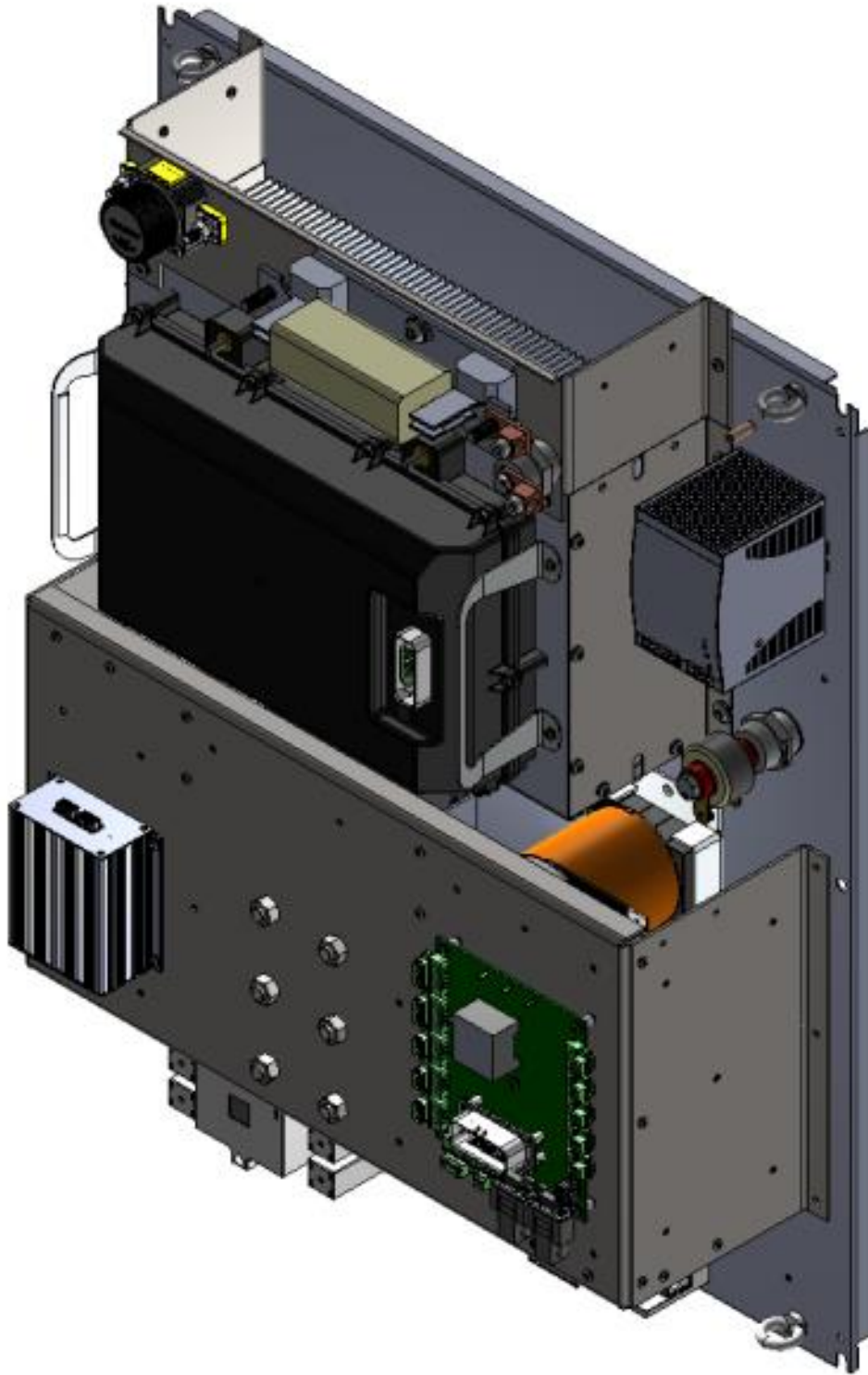

Figure 2: OZip-AFEA10PA*480*** Illustration in Perspective

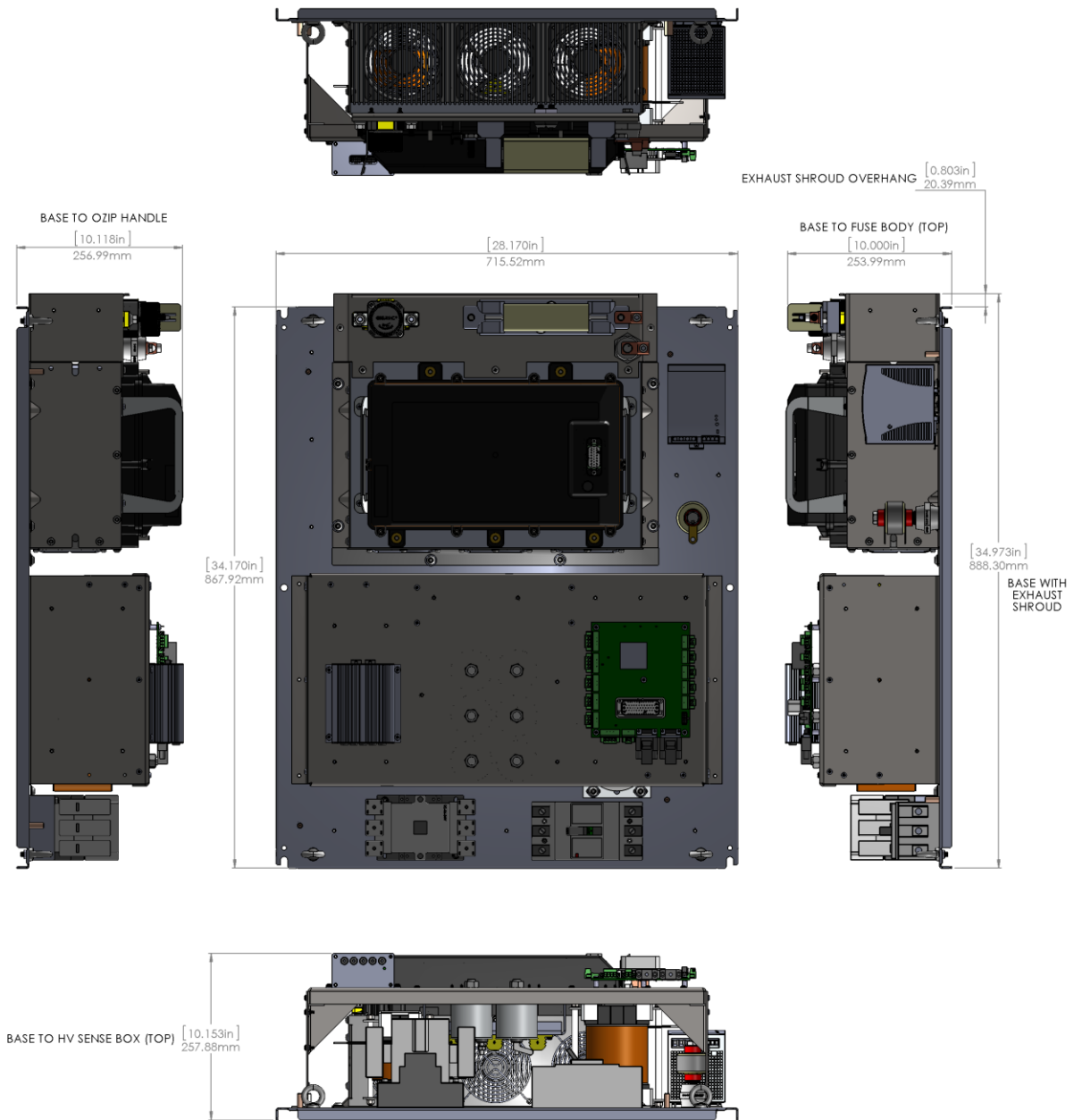

Figure 3: OZip-AFEA10PA*480*** View from Critical Sides

4.2.2 Enclosed Cabinet Models (OZip-AFEA10CA*480***)

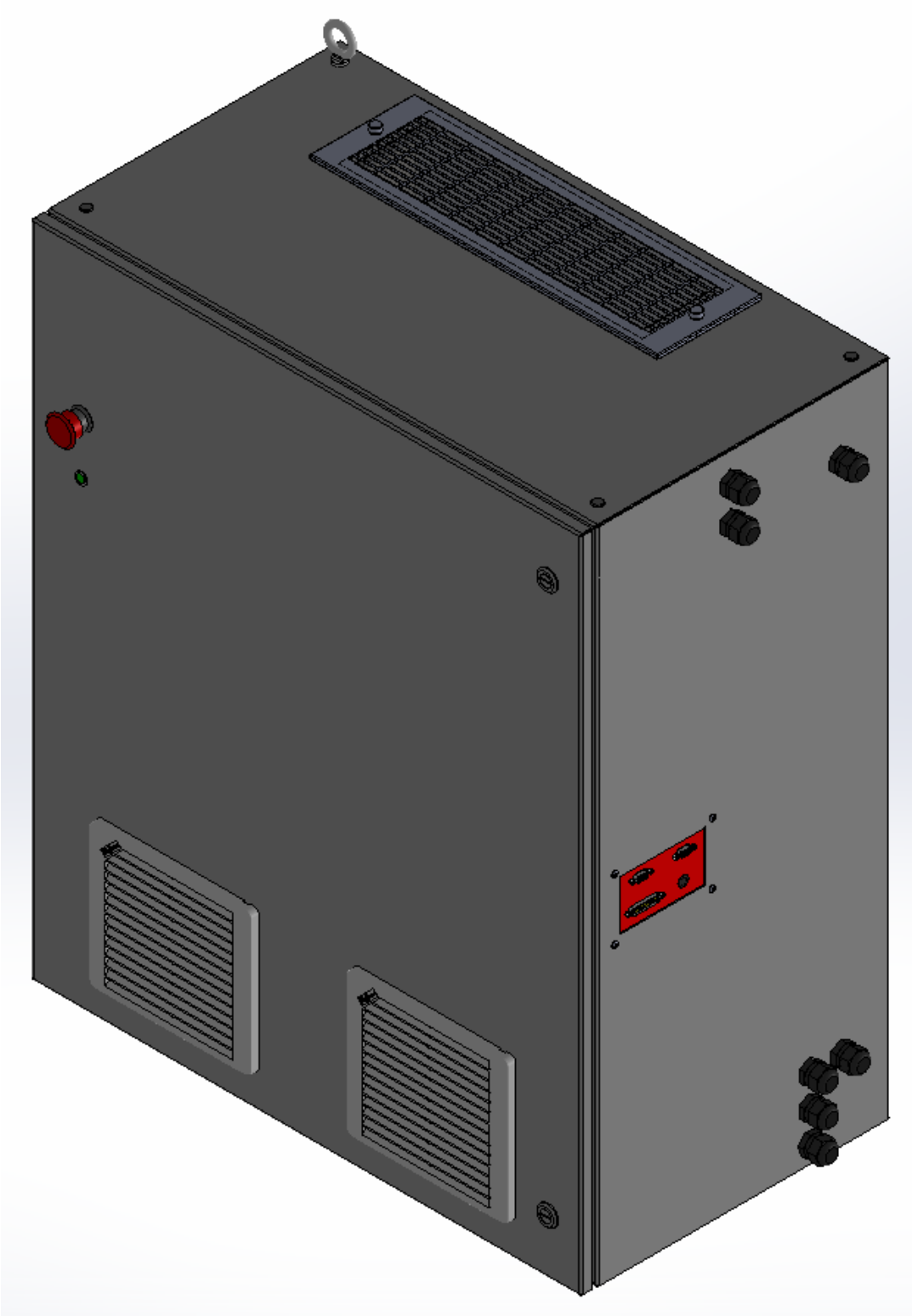

Figure 4: OZip-AFEA10CA*480*** Illustration in Perspective

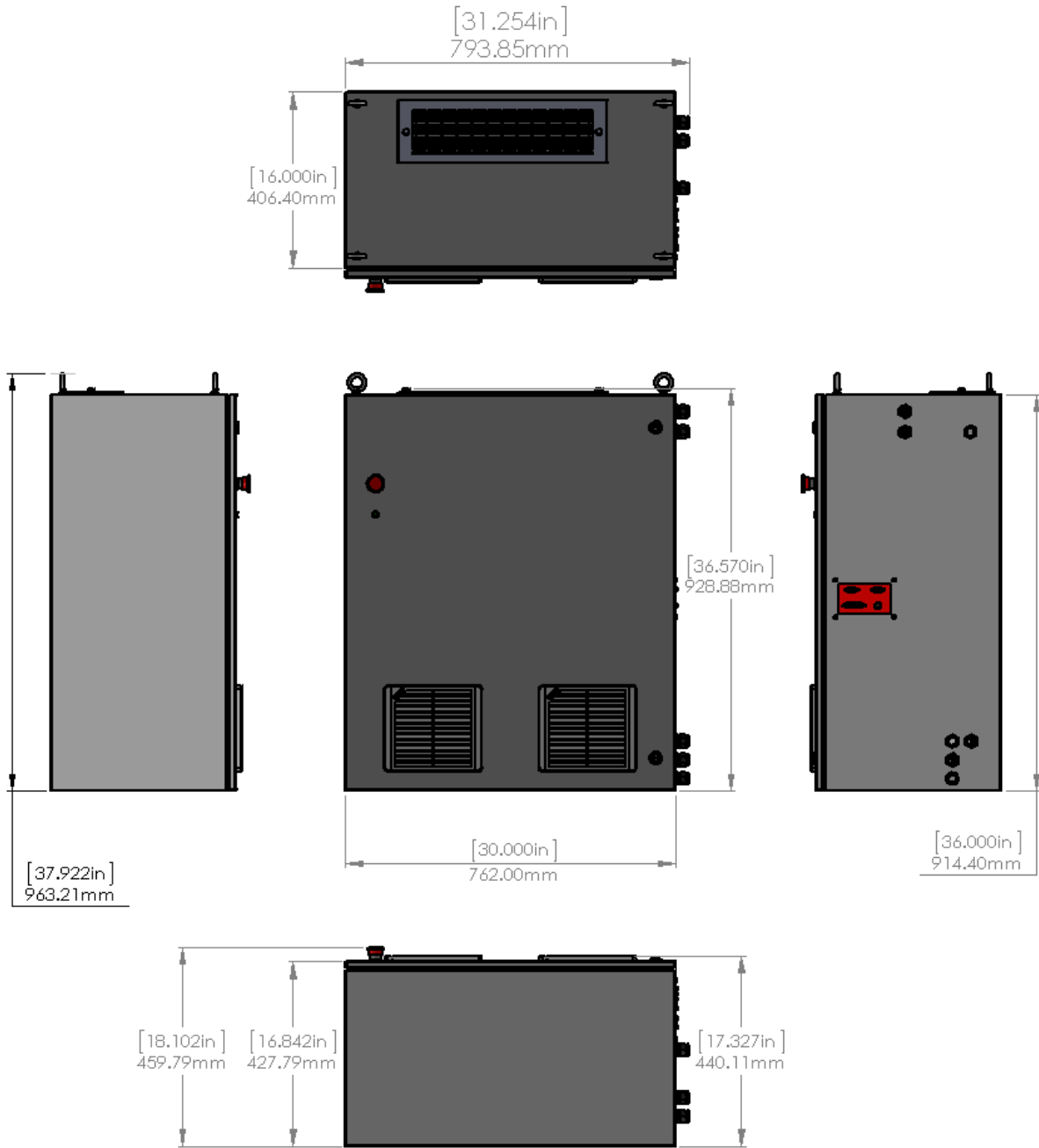

Figure 5: OZip-AFEA10CA*480*** View from Critical Sides

5. Electrical Characteristics

5.1 Power Circuitry

5.1.1 Absolute Maximum Ratings

- DC Link Voltage: **1000 V_{DC}**⁽¹⁾
- Phase Current: **300 A_{RMS}**

⁽¹⁾ Protection disables switching at 900 V_{DC}.

5.1.2 Recommended Maximum Operating Conditions

- DC Link Voltage: **850 V_{DC}**
- Continuous Phase Current⁽²⁾: **205 A_{RMS}** at 3 kHz, 45°C ambient temperature
- Transient Load Current⁽²⁾⁽³⁾: **267 A**

⁽²⁾ Assumes like voltage of 750 V_{DC} and 50/60 Hz inverter operation or DC/DC converter with 50% duty cycle.

⁽³⁾ Duration of less than 10 seconds.

5.2 Control Signal Electrical Specifications

Serial communication and customer interface signal specifications are as defined in Table 2. Details of signals and their functions can be found in UM-0056 OZIP AFE/GTI Inverter User's Manual. Additionally, several signals ("COM+" and "COM-") vary in functionality depending upon whether the "Interface Standard", as again defined by the Part Number Identifier of Figure 1, indicates that the unit is configured for CAN protocol [OZip-AFEA10*AC480***] or for Modbus RS-485 serial communication [OZip-AFEA10*AM480***].

Table 2 – Serial Communication and Customer I/O Interface Signal Specifications

| <i>Signal</i> | <i>Function</i> | <i>Electrical Specifications</i> |
|---------------|--|---|
| FAULT_RESET | Fault reset input signal (dry contact) | Open Circuit Voltage Level: 18 to 32V _{DC} (relative to RETURN). Load current when active: 3 to 6 mA. |
| RETURN | Input reference node | 0V reference level for dry contact inputs. |
| INTERLOCK | Interlock input signal (dry contact) | Open Circuit Voltage Level: 18 to 32V _{DC} (relative to RETURN). Load current when active: 3 to 6 mA. |
| RETURN | Input reference node | 0V reference level for dry contact inputs. |
| ENABLE | Enable input signal (dry contact) | Open Circuit Voltage Level: 18 to 32V _{DC} (relative to RETURN). Load current when active: 3 to 6 mA. |
| RETURN | Input reference node | 0V reference level for dry contact inputs. |

| <i>Signal</i> | <i>Function</i> | <i>Electrical Specifications</i> |
|---------------|---|--|
| FLT_OUT | Fault output signal, open collector | Maximum open collector voltage: 45V _{DC} (relative to FLT_OUT_RTN). Maximum load current < 10 mA at 25°C. Recommended nominal load current = 2 mA. |
| FLT_OUT_RTN | Fault output return | 0V reference level for open collector fault output signal. |
| TEMP | Thermistor temperature sensor | Maximum voltage: 3.6V _{DC} (relative to AGND). Minimum voltage: -0.5V _{DC} (relative to AGND). Typical thermistor value ranging from 1kΩ to 10kΩ. |
| TEMP_RTN | Thermistor temperature sensor return | 0V analog reference level for temperature measurement. |
| COM+ | Communications port positive differential input | CAN Models OZip-AFE*****C** <ul style="list-style-type: none"> - Maximum voltage range: -36 to 36V (relative to COM-). - Recommended operating voltage: -7 to 12V (relative to COM_GND). - Recommended operating differential voltage: -6 to 6V (relative to COM-). RS-485 Models OZip-AFE*****M** <ul style="list-style-type: none"> - Maximum voltage range: -13 to 16.5V (relative to COM-). - Recommended operating voltage: -7 to 12V (relative to COM_GND). Recommended operating differential voltage: -12 to 12V (relative to COM-). |
| COM- | Communications port negative differential input | CAN Models OZip-AFE*****C** <ul style="list-style-type: none"> - Maximum voltage range: -36 to 36V (relative to COM+). - Recommended operating voltage: -7 to 12V (relative to COM_GND). - Recommended operating differential voltage: -6 to 6V (relative to COM+). RS-485 Models OZip-AFE*****M** <ul style="list-style-type: none"> - Maximum voltage range: -13 to 16.5V (relative to COM+). - Recommended operating voltage: -7 to 12V (relative to COM_GND). - Recommended operating differential voltage: -12 to 12V (relative to COM+). |
| COM_GND | Isolated communications port ground | 0V communication circuit reference level. |
| COM_SHIELD | Chassis ground connection for shielding communication signals | Maximum voltage offset from heatsink (chassis): 45V. |

5.3 Circuit Isolation

Circuit isolation shall be defined in reference to the following islands of electrical potential:

- Chassis – the open-frame plate or enclosed cabinet itself, presumed to be tied to Earth (Safety) ground per Section 7.1.

- Power terminals – AC phase terminals and DC rail terminals, as specified in Section 7.2.
- Bias potential – references for module control (RETURN & TEMP_RTN), as specified in Section 5.2.
- Communication reference – COM_GND for CAN/Modbus communication, as specified in Section 5.2.
- Differential output – FLT_OUT_RTN, as specified in Section 5.2.
- Shield – Communication cable braid or foil, as specified in Section 5.2.

Isolation boundaries shall conform to the specifications of Table 3.

Table 3 – Isolation Boundary Comparison

| <i>Units = V</i> | <i>Chassis (Earth)</i> | <i>Power Terminals</i> | <i>Bias Potential</i> | <i>Communication Reference</i> | <i>Differential Output</i> | <i>Shield</i> |
|--------------------------------|------------------------|------------------------|-----------------------|--------------------------------|----------------------------|---------------|
| <i>Chassis (Earth)</i> | | 2500 | 45 | 550 | 600 | 45 |
| <i>Power Terminals</i> | 2500 | | 2500 | 3000 | 3000 | 3000 |
| <i>Bias Potential</i> | 45 | 2500 | | 500 | 550 | 90 |
| <i>Communication Reference</i> | 550 | 3000 | 500 | | 1000 | 600 |
| <i>Differential Output</i> | 600 | 3000 | 550 | 1000 | | 600 |
| <i>Shield</i> | 45 | 3000 | 90 | 600 | 600 | |

6. Environmental Characteristics

Environmental characteristics vary slightly depending upon the selected “Packaging”, as defined by the Part Number Identifier of Figure 1.

6.1 Operating Specifications

| Condition | Open-Frame Plate Models (OZip-AFE***P*****) | Enclosed Cabinet Models (OZip-AFE***C*****) |
|-------------------------|---|---|
| Ambient Temperature | -40°C to +65°C (-40°F to +149°F) | -40°C to +65°C (-40°F to +149°F) |
| Air Flow | 5.7 m ³ / minute (200 ft ³ / minute) | 5.7 m ³ / minute (200 ft ³ / minute) |
| Humidity | 0 – 95% RH non-condensing | 0 – 95% RH non-condensing |
| Pollution Degree Rating | Pollution Degree 2 | Pollution Degree 3 |

6.2 Storage Specifications

| Condition | Open-Frame Plate Models (OZip-AFE***P*****) | Enclosed Cabinet Models (OZip-AFE***C*****) |
|---------------------|---|---|
| Ambient Temperature | -55°C to +65°C (-67°F to +149°F) | -55°C to +65°C (-67°F to +149°F) |
| Thermal Shock | +/- 10°C (18°F) per second within ambient storage limits | +/- 10°C (18°F) per second within ambient storage limits |
| Ingress Protection | None | IP20 |

7. Open-Frame (OZip-AFEA10PA*480***) Interfaces

For models of the OZip-AFE Intelligent Power Solution having been configured on an open-frame plate (OZip-AFEA10PA*480***), defined by the “Packaging” parameter of the Part Number Identifier of Figure 1, the interface requirements are as specified herein.

Information pertaining to Earth (Safety) Ground, Section 7.1, and Power Interfaces, Section 7.2, also hold for models in an enclosed cabinet (OZip-AFEA10CA*480***) after wires have been routed through the appropriate access ports. See Section 8.1 for details on enclosed cabinet access ports.

7.1 Earth (Safety) Ground

The base plate of the OZip-AFE Intelligent Power Solution has been designated as chassis potential and shall require proper earth grounding in accordance with standards of the local electrical code.

The base plate has been constructed with several dedicated M8 x 25 ground studs which can be used at customer convenience to secure safety ground wires from either or both of AC and DC power harnesses. These ground studs are as shown in Figure 6.

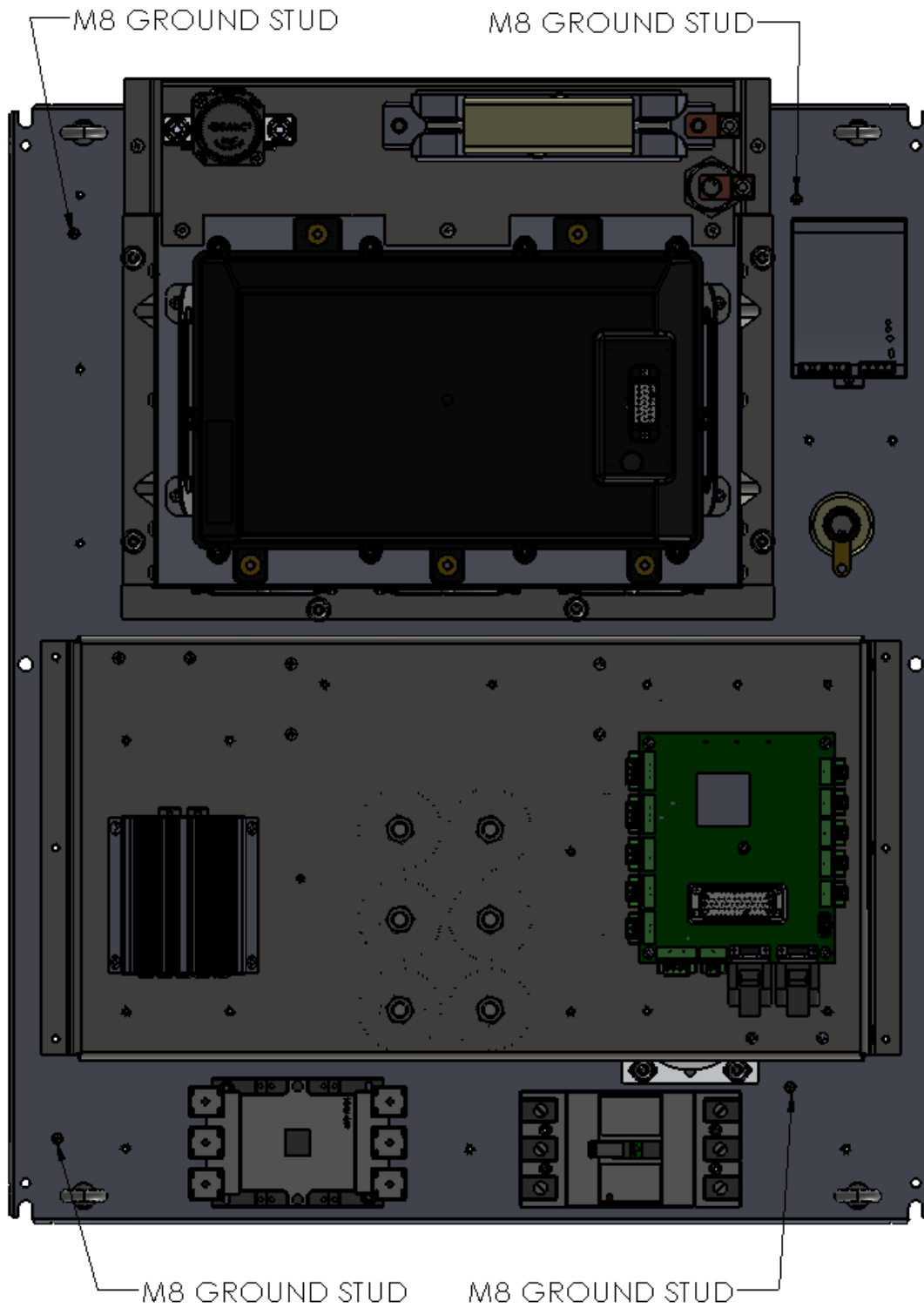

Figure 6: Ground Stud Locations on the OZip-AFE IPS Base Plate

Each ground stud is supplied with the appropriate mounting hardware to be used for electrical connection. The proper fastener stackup sequence, from the mounting tab upward, is as shown in Figure 7. Note that one, and only one, customer supplied compression terminal lug or formed buss bar may be used at each terminal. Torque targets of 15Nm (133 in-lb) must be satisfied to a tolerance of +/- 5%.



Figure 7: Power Terminal Hardware Stackup

7.2 Power Interfaces

7.2.1 AC Line Connections

Three-phase AC line connections are made to the exposed terminals of the circuit breaker, part number BW125JAGU-3P125SB from Fuji Electric, or its equivalent. This breaker, shown in Figure 8, can accommodate wire diameter up to 16.5 mm (0.65 in) wide.



Figure 8: Circuit Breaker for AC Line Connection

Connection points for the AC line connections on the base plate are as shown in Figure 9. These compression terminal interfaces should be torqued to 5.8 Nm (51 in-lb).

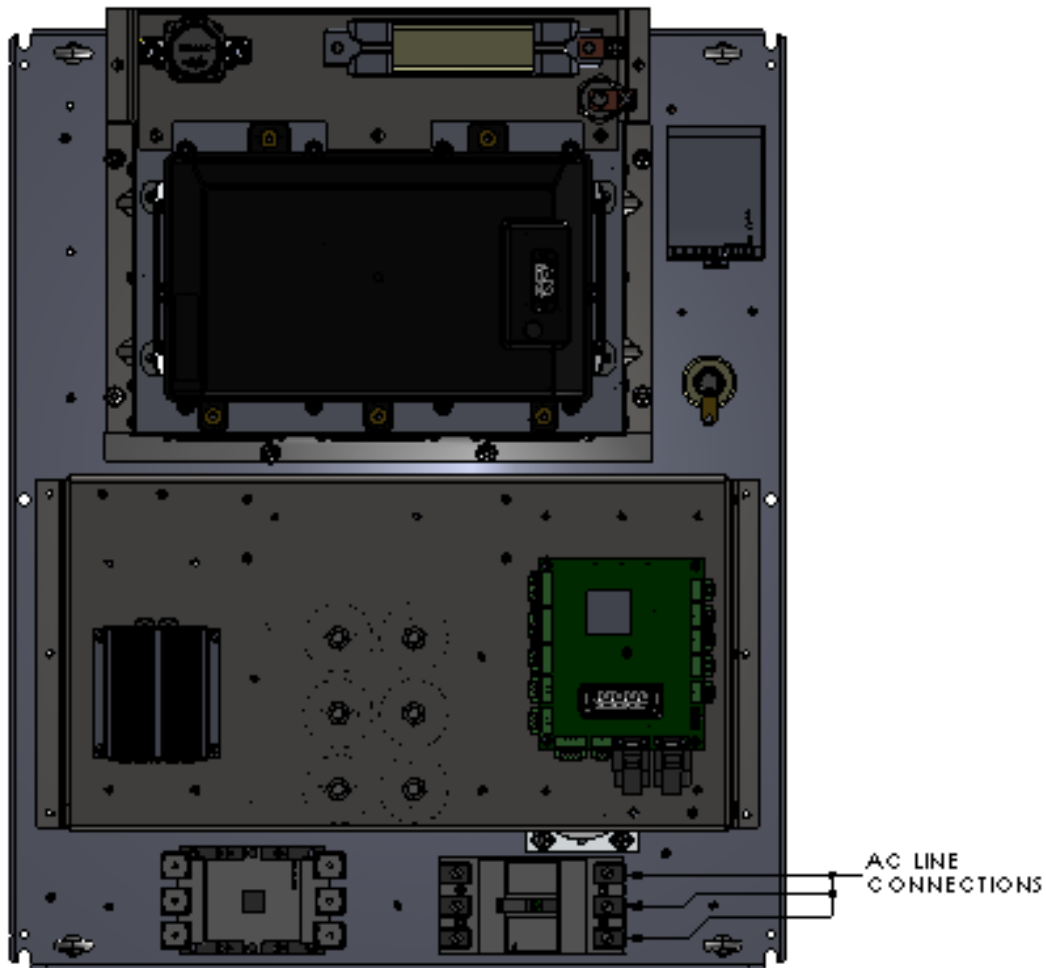

Figure 9: AC Line Connection Points on OZip-AFE IPS Base Plate

7.2.2 DC Link Connections

DC link connections are made to the two instances of the Burndy KA25NK compression terminal, or its equivalent, shown in Figure 10. This terminal has a hole diameter of 10.6 mm (0.42 in) and can support wire sizes from 25 to 50 mm² (4 to 1/0 AWG). Torque requirements on this terminal are 22.6 Nm (200 in-lb).



Figure 10: Compression Terminal for DC Link Connections

**WARNING**

Observe proper polarity when connecting the positive DC link terminal. Reversing polarity will result in damage to the OZip-AFE IPS.

The proper mounting location for the DC+ terminal on the base plate is at the compression terminal connected to the fuse, as shown in Figure 11.

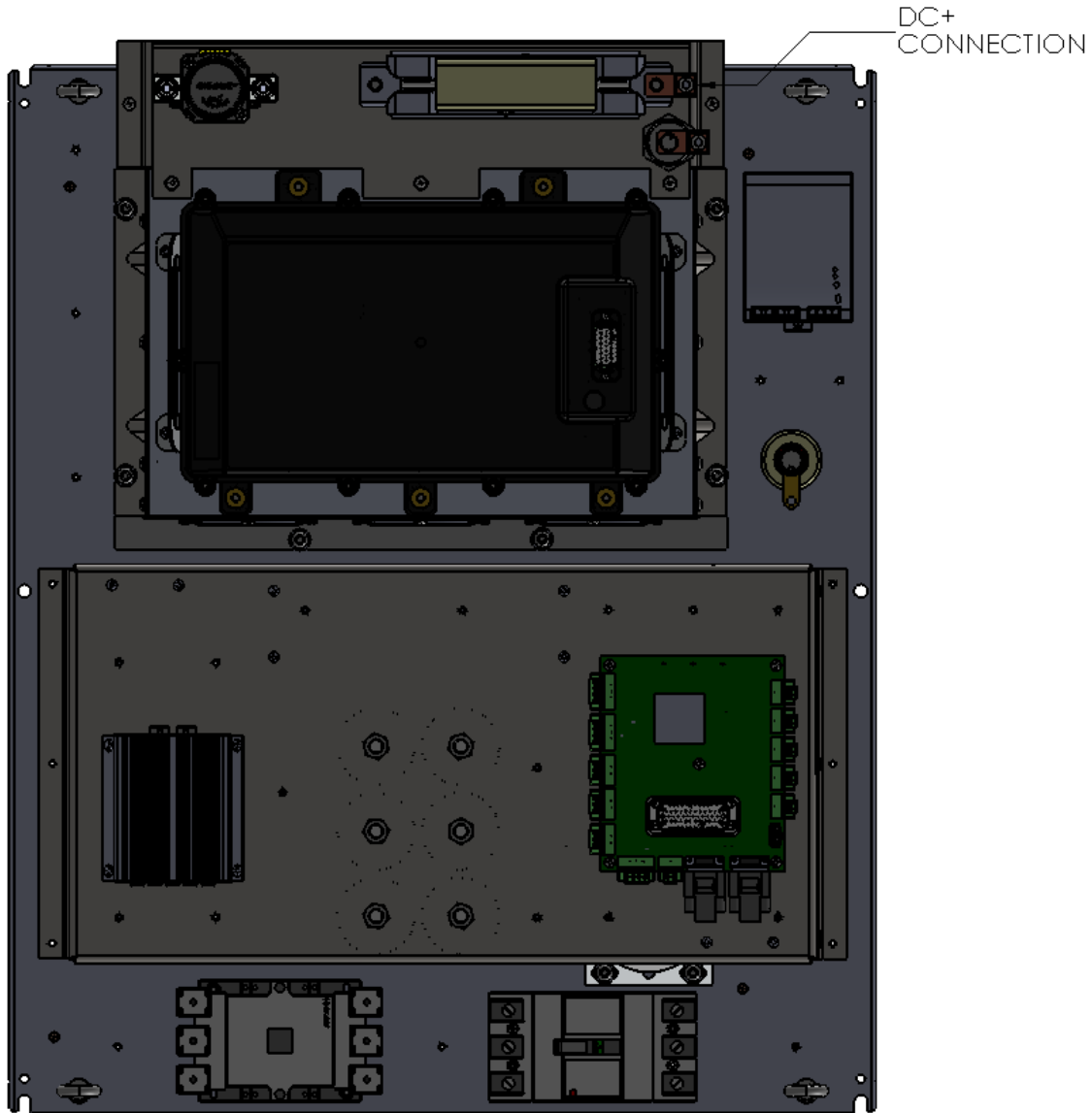

Figure 11: OZip-AFE IPS DC Link Positive Terminal Connection Point on Base Plate

**WARNING**

Observe proper polarity when connecting the negative DC link terminal. Reversing polarity will result in damage to the OZip-AFE IPS.

The proper mounting location for the DC- terminal on the open-frame plate is at the compression terminal which is not connected to the fuse, as shown in Figure 12.

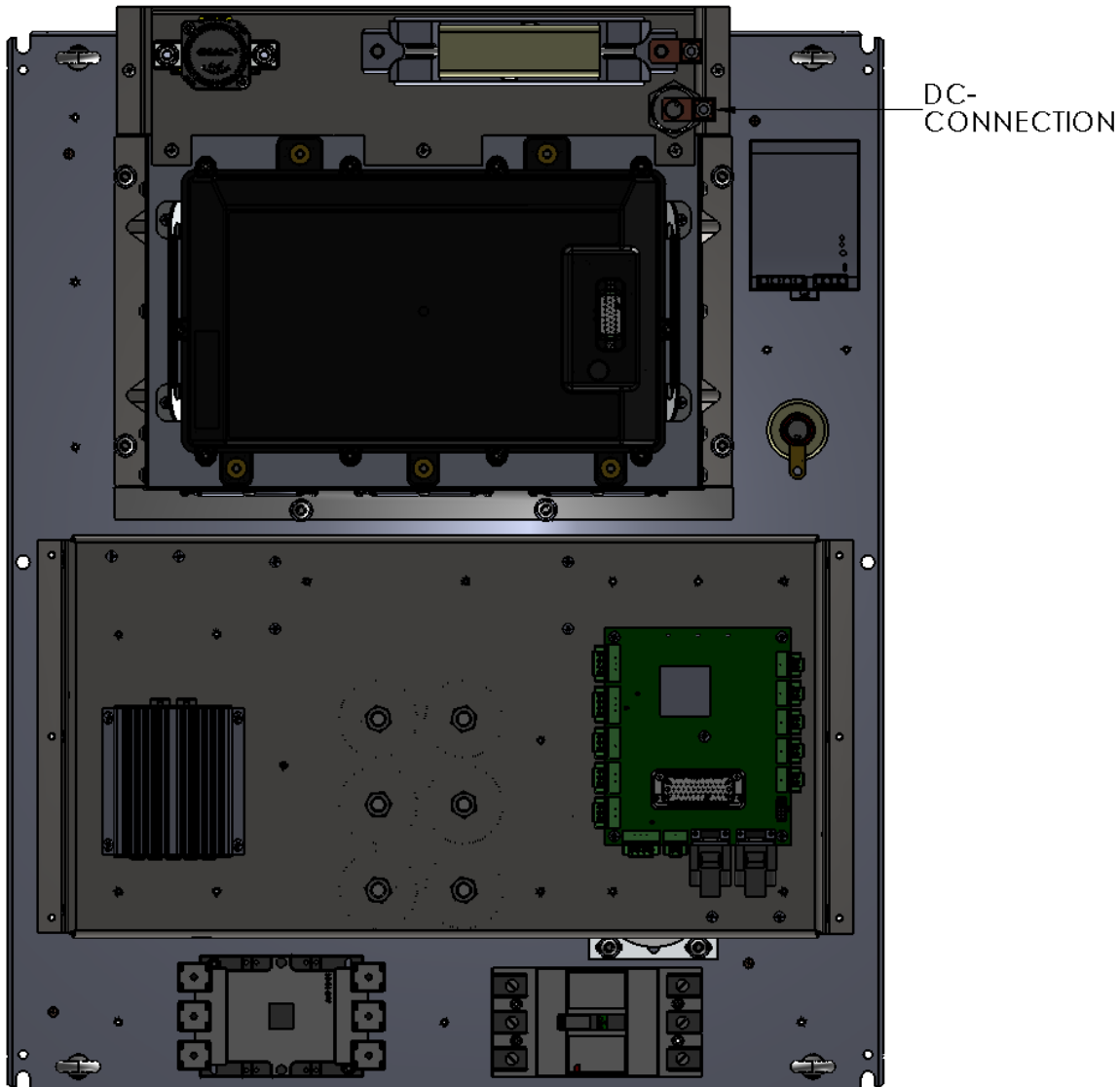

Figure 12: OZip-AFE IPS DC Link Negative Terminal Connection Point on Base Plate

7.2.3 Wire Sizing

It is assumed that any system application has been properly designed to account for the current carrying limitations of the associated wiring and allowable temperature rise. High current carrying wires are subject to forces that may require support to avoid long-term fatigue. Wire lengths must be minimized, and closely coupled to minimize current loops, while adequately spaced to allow heat dissipation so as to minimize temperature rise.

Table 4 provides general guidelines for wire sizing selections when run lengths are constricted to less than 15m (50 ft). Consult factory for recommendations as to wire sizing for installations with longer cabling requirements.

Table 4 – Wire Sizing Guidelines

| RMS Current | Wire Size | |
|-------------|--------------------|---------|
| | Metric | US |
| 105 A | 10 mm ² | 6 AWG |
| 140 A | 25 mm ² | 4 AWG |
| 190 A | 35 mm ² | 2 AWG |
| 220 A | 50 mm ² | 1 AWG |
| 260 A | 50 mm ² | 1/0 AWG |

7.3 Signal Interfaces

Control signal interfaces vary according to the “Packaging” configuration of the OZip-AFE IPS, as defined by the Part Number Identifier of Figure 1. In the case of systems based upon the open-frame plate [OZip-AFEA10PA*480***], interfaces are made exclusively to select connectors of the embedded 11237-01 OZip AFE Interface Board, shown in Figure 13. This assembly can be seen in Figure 2, on the mezzanine bracket under which the AC filter components are located.

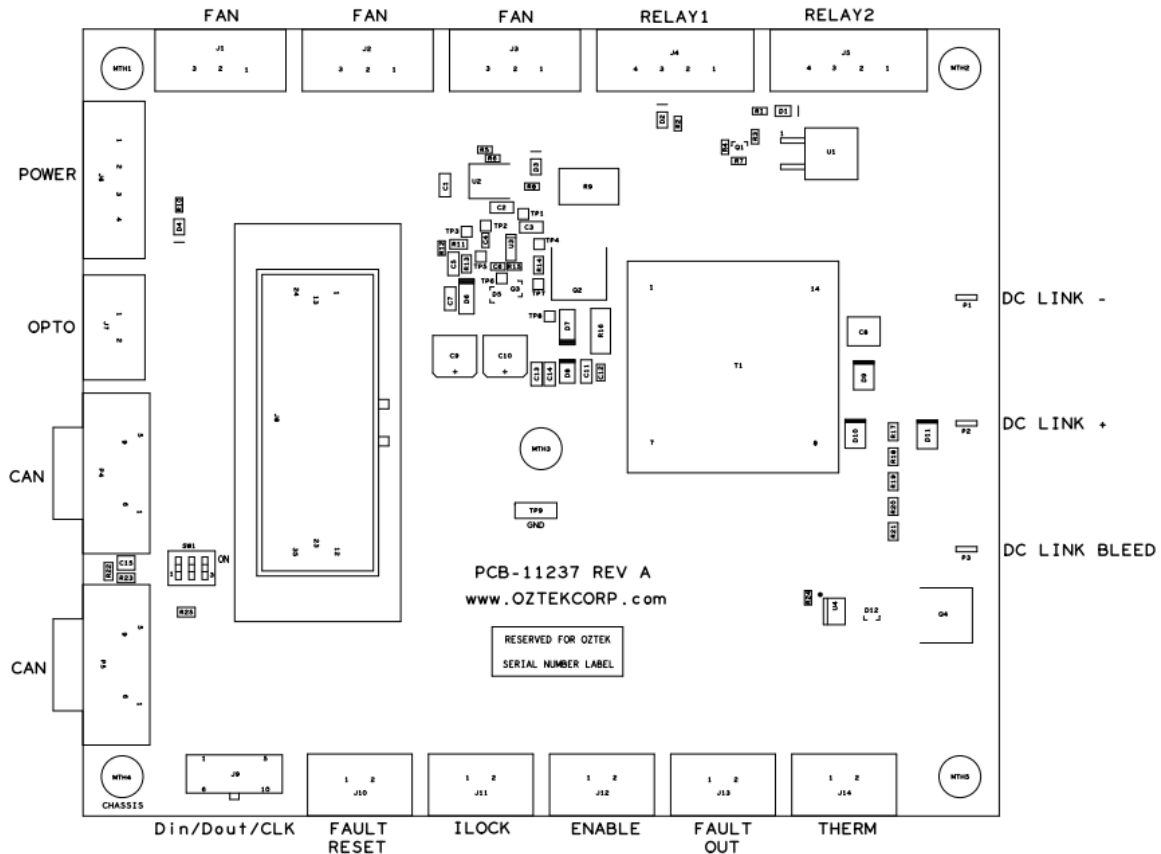

Figure 13: OZip-AFEA10PA*480*** Interface Assembly Illustration (11237-01)

7.3.1 Serial Communication Interface Definition

The serial communication interface connectors on the embedded 11237-01 OZip AFE Interface Board are normal density DE-09S D-subminiature interfaces with 4-40 threaded screw locks for mating cable attachment. There are two such connectors available, denoted as P4 and P5, so that communication can be easily daisy-chained within a system's network. These interfaces are as shown schematically in Figure 14 and physically in Figure 15. The connector is part number 5747844-5 from Amphenol, or its equivalent.

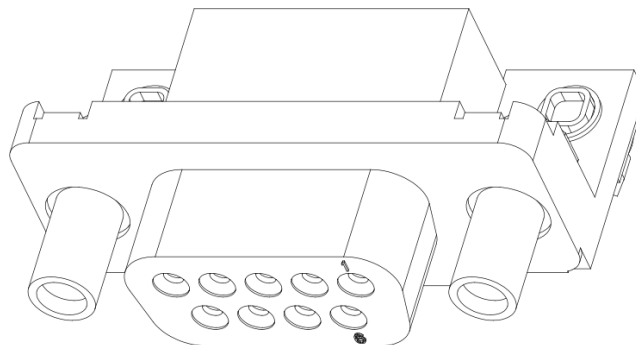

Figure 14: Illustration of Communication Connector at P4 & P5 of 11237-01



Figure 15: Image of Communication Connector at P4 & P5 of 11237-01

The customer supplied serial communication interface connectors to the OZip-AFE IPS shall terminate with normal density DE-09P D-subminiature interfaces with 4-40 threaded screws for mating cable attachment. As factory set, the user is expected to connect a single such communication cable to the OZip-AFE IPS. That cable can be attached either to P4 or P5 on the embedded 11237-01 OZip AFE Interface Board interchangeably.

The contact assignment and electrical specifications for the serial interfaces are as defined in Table 5.

Table 5 – Serial Communication Signal Interfaces for OZip-AFEA10PA*480***

| <i>Connector</i> | <i>Contact</i> | <i>Signal</i> |
|------------------|----------------|---------------|
| P4 / P5 | 2 | COM- |
| P4 / P5 | 3 | COM_GND |
| P4 / P5 | 7 | COM+ |
| P4 / P5 | shell | COM_SHIELD |

Proper termination is required at the end nodes of any serial communication link for network integrity. Note that SW1, shown in the magnified subset of 11237-01 OZip AFE Interface Board in Figure 16, is factory set to terminate the line. It accomplishes this by setting the leftmost switch to the “ON” position, assuming that the OZip-AFE IPS is not daisy-chained. If only one serial communication cable is employed, either connector interface may be used interchangeably.

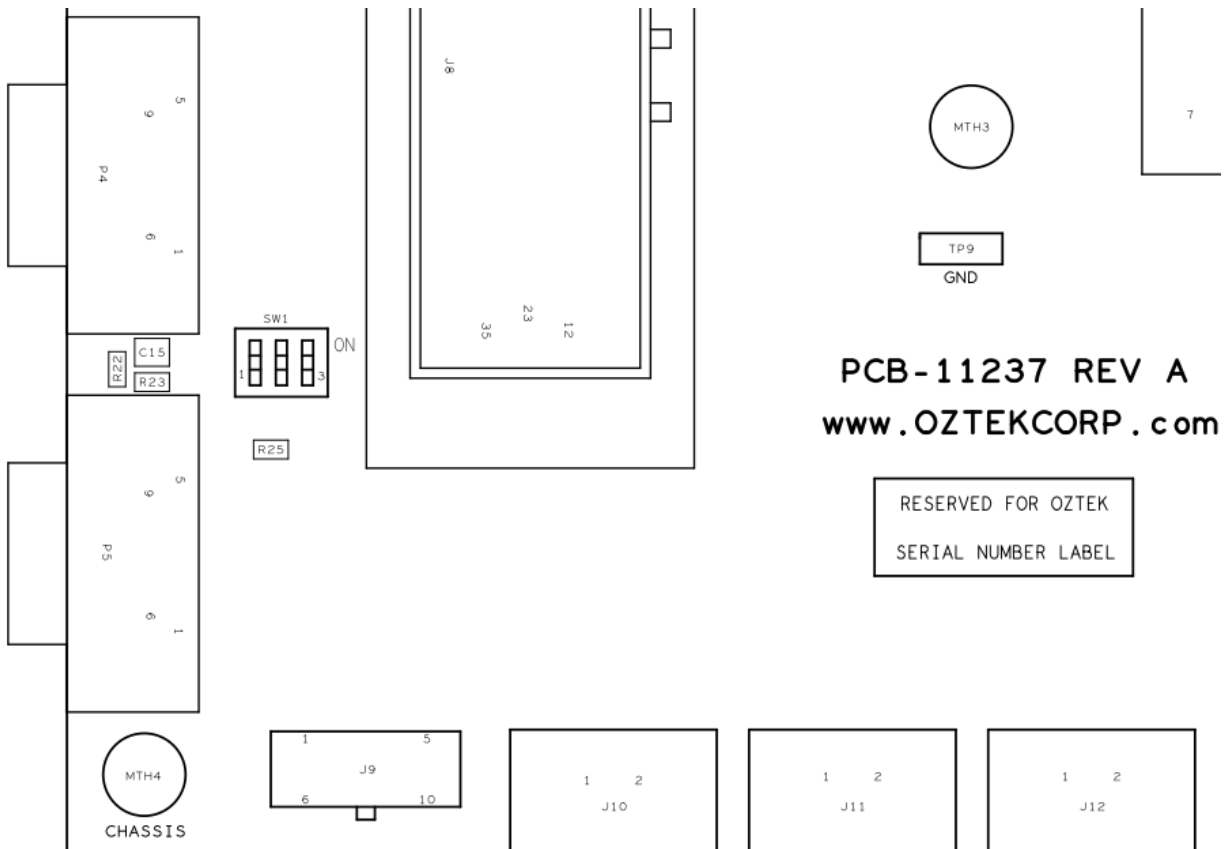

Figure 16: SW1 Setting for CAN Termination

If instead the OZip-AFE IPS is to be daisy-chained within a larger communication network, this leftmost switch of SW1 should be set by the operator to the opposite side to induce an open circuit condition. The remaining switches on SW1 serve no function.

7.3.2 Customer I/O Interface Definition

Customer I/O interfaces are also made to the embedded 11237-01 OZip AFE Interface Board, shown in Figure 13, as discrete wire pairs to board connectors. The connector is part number 1776508 from Phoenix Contact, or its equivalent. It is shown schematically in Figure 17, where the notch represents signal 1, and physically in Figure 18.

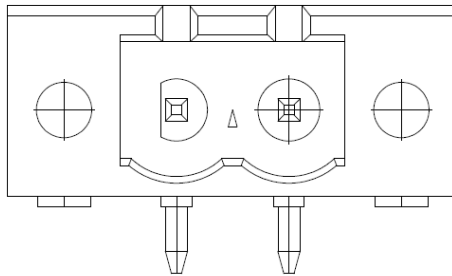

Figure 17: Illustration of I/O Interface Connectors at J10-J14 of 11237-01



Figure 18: Image of I/O Interface Connectors at J10-J14 of 11237-01

Regarding the harness receptacles that can be used to mate to the connectors of the 11237-01 OZip AFE Interface Board, see the Phoenix Contact specification for 1776508 for a complete list of mating options. These are not provided. The contact assignment and electrical specifications for the customer I/O interfaces are as defined in Table 6.

Table 6 – Customer I/O Interface Signal Interfaces for OZip-AFEA10PA*480***

| <i>Connector</i> | <i>Contact</i> | <i>Signal</i> |
|------------------|----------------|---------------|
| J10 | 1 | FAULT_RESET |
| J10 | 2 | RETURN |
| J11 | 1 | INTERLOCK |
| J11 | 2 | RETURN |
| J12 | 1 | ENABLE |
| J12 | 2 | RETURN |
| J13 | 1 | FLT_OUT |
| J13 | 2 | FLT_OUT_RTN |
| J14 | 1 | TEMP |
| J14 | 2 | TEMP_RTN |

8. Enclosed Cabinet (OZip-AFEA10CA*480***) Interfaces

For models of the OZip-AFE Intelligent Power Solution having been configured as an enclosed cabinet (OZip-AFEA10CA*480***), defined by the “Packaging” parameter of the Part Number Identifier of Figure 1, the interface requirements are as specified herein.

Ground and power wires must penetrate the cabinet wall, as detailed in Section 8.1. Thereafter, the connection of those wires shall be as specified in Section 7.1 for Earth (Safety) Ground and in Section 7.2 for all current carrying power wires.

8.1 Ground & Power Cable Access Ports

Ground and power wire access ports on the enclosed cabinet are as shown in Figure 19. In each case, access is made through a cord grip for wire strain relief. The cord grip is Remke part number RD13NA, or equivalent, as shown in Figure 20. The wire diameter range supported by this grip is 5.9 to 11.9 mm (0.23 to 0.47 in). Be sure to determine whether there is adequate pass through clearance for the terminal lug prior to crimping it onto the ground wire(s).

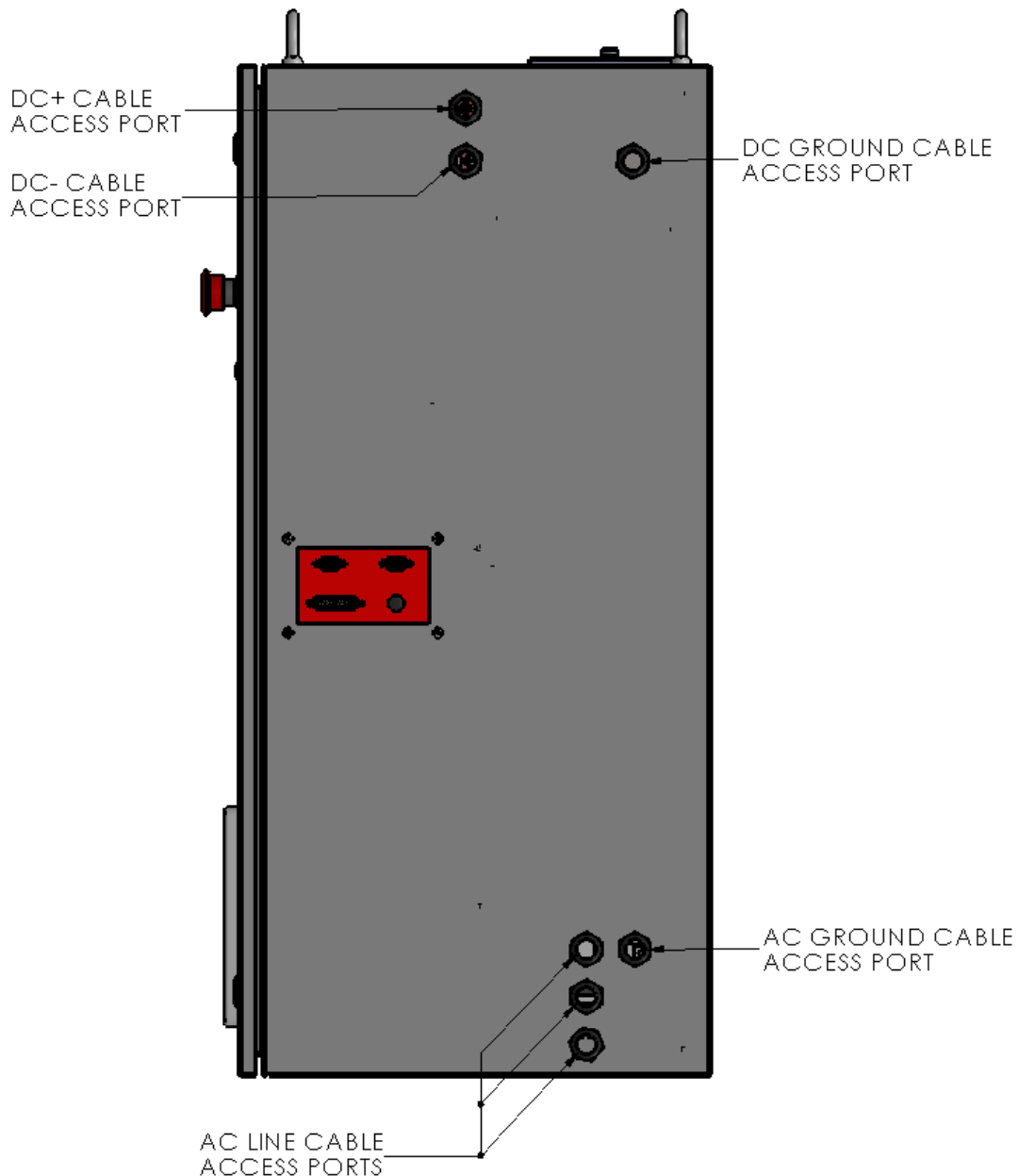

Figure 19: OZip-AFEA10CA*480*** Cabinet Access Ports



Figure 20: Enclosed Cabinet Cord Grip at Each Access Port

8.2 Cabinet Emergency Stop Button

The OZip-AFEA10CA*480*** comes equipped with an Emergency Stop button which, if triggered, will disable bias power, engaging internal contactors, as equipped, to disconnect the OZip-AFE IPS from the circuit and bleed the energy in the DC link.

It is the customer's responsibility to understand the limitations of the Emergency Stop button in configurations in which any or all of contactor functionality is performed at the system level and outside the scope of the OZip-AFE IPS.

8.3 Signal Interfaces

Control signal interfaces vary according to the "Packaging" configuration of the OZip-AFE IPS, as defined by the Part Number Identifier of Figure 1. In the case of systems based upon the enclosed cabinet [OZip-AFEA10CA*480***], interfaces are made exclusively to the custom cabinet interface 11177-01 Controller Communication Interface Bulkhead, shown in Figure 21. This bulkhead can be seen in Figure 4, on the side wall opposite the door hinges.

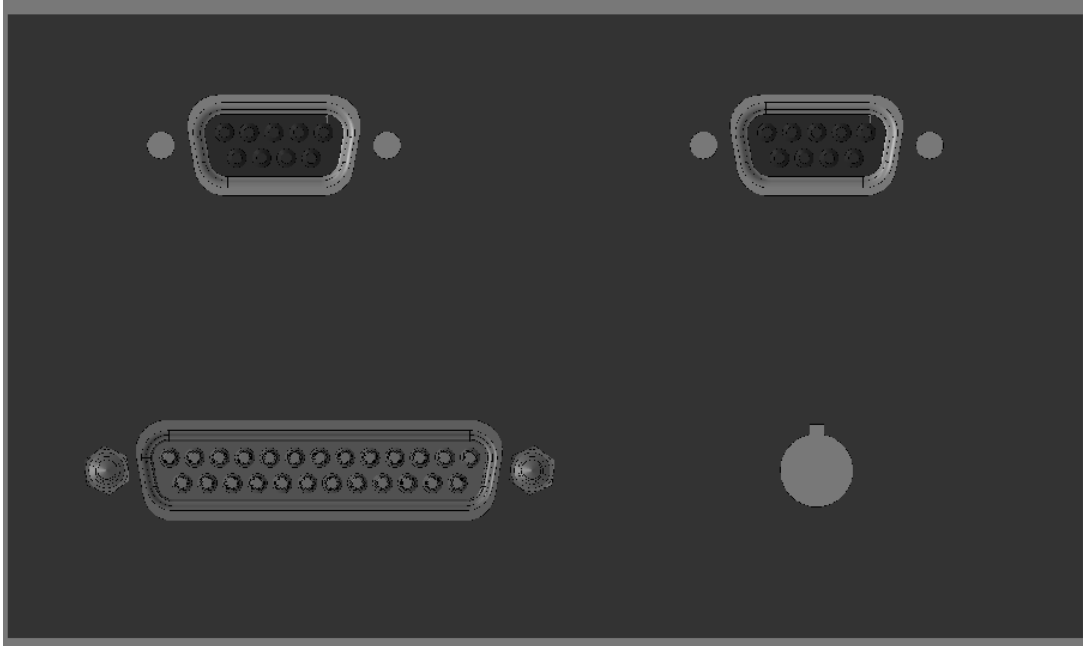

Figure 21: OZip-AFEA10CA*480*** Interface Assembly Illustration (11177-01)

8.3.1 Serial Communication Interface Definition

The serial communication interface connectors on the 11177-01 Controller Communication Interface Bulkhead are normal density DE-09S D-subminiature interfaces with 4-40 threaded screw locks for mating cable attachment. There are two such connectors available so that communication can be easily daisy-chained within a system's network. These interfaces are as shown schematically in Figure 22 and physically in Figure 23. The bulkhead connector is the receptacle side of cable part number CRMN9MF-2.5 from L-Com, or its equivalent.

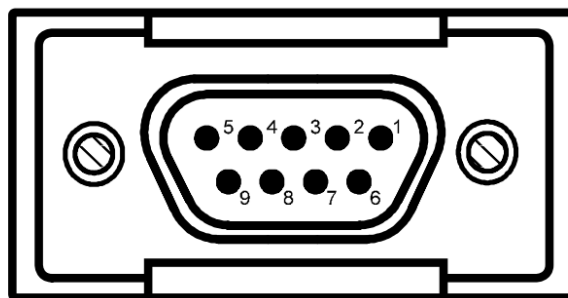

Figure 22: Illustration of Communication Connector at Cabinet Bulkhead



Figure 23: Image of Communication Connector at Cabinet Bulkhead

The customer supplied serial communication interface connectors to the OZip-AFE IPS shall terminate with normal density DE-09P D-subminiature interfaces with 4-40 threaded screws for mating cable attachment. As factory set, the user is expected to connect a single such communication cable to the OZip-AFE IPS. That cable can be attached to either DE-09S on the 11177-01 Controller Communication Interface Bulkhead interchangeably.

The contact assignment and electrical specifications for the serial interfaces are as defined in Table 7.

Table 7 – Serial Communication Signal Interfaces for OZip-AFEA10CA*480***

| <i>Connector</i> | <i>Contact</i> | <i>Signal</i> |
|------------------|----------------|---------------|
| DE-09S | 2 | COM- |
| DE-09S | 3 | COM_GND |
| DE-09S | 7 | COM+ |
| DE-09S | shell | COM_SHIELD |

Proper termination is required at the end nodes of any serial communication link for network integrity. There is a switch internal to the cabinet, located at SW1 of the embedded 11237-01 OZip AFE Interface Board, which can be set for proper network termination. Consult Section 7.3.1 regarding changes to the factory default setting if the application calls for the cabinet to be daisy-chained to other equipment on the network.

8.3.2 Customer I/O Interface Definition

Customer I/O interfaces are also made to the 11177-01 Controller Communication Interface Bulkhead shown in Figure 21. These interfaces are made to a normal density DB-25P D-subminiature interface with 4-40 threaded screw locks for mating cable attachment. These interfaces are as shown schematically in Figure 24 and physically in Figure 25. The bulkhead connector is part number 5-747912-2 from TE Connectivity, or its equivalent.

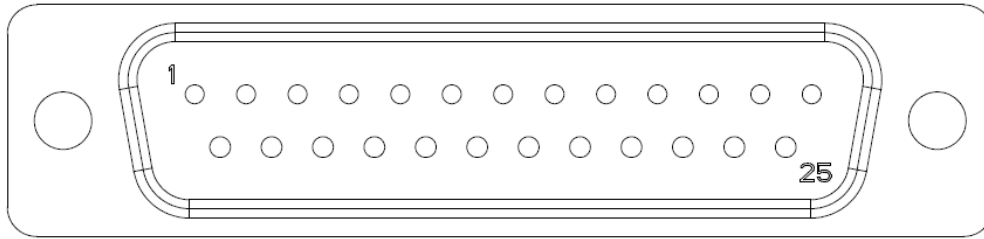

Figure 24: Illustration of I/O Interface Connector at 11177-01

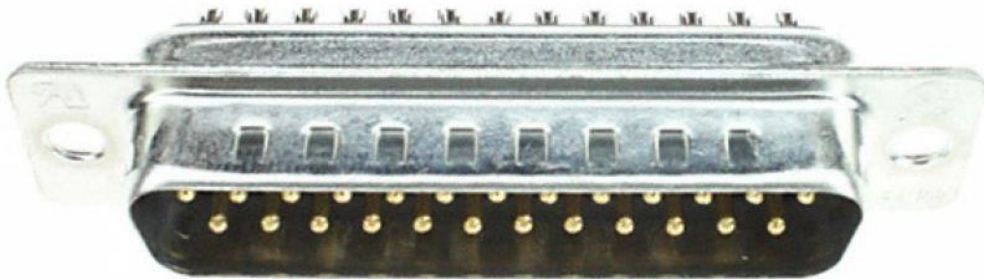

Figure 25: Image of I/O Interface Connector at 11177-01

The customer I/O interface is made through a normal density DB-25S D-subminiature interface with 4-40 threaded screws for mating cable attachment, not provided. The contact assignment and electrical specifications for the customer I/O interface is as defined in Table 8.

Table 8 – Customer I/O Interface Signal Interfaces for OZip-AFEA10CA*480***

| <i>Connector</i> | <i>Contact</i> | <i>Signal</i> |
|------------------|----------------|---------------|
| DB-25P | 7 | FAULT_RESET |
| DB-25P | 19 | RETURN |
| DB-25P | 8 | INTERLOCK |
| DB-25P | 20 | RETURN |
| DB-25P | 9 | ENABLE |
| DB-25P | 21 | RETURN |
| DB-25P | 11 | FLT_OUT |
| DB-25P | 23 | FLT_OUT_RTN |
| DB-25P | 13 | TEMP |
| DB-25P | 25 | TEMP_RTN |

9. Installation

9.1 Mechanical Mounting

The OZip-AFE IPS is designed to be a flexible platform for prototype development, standalone service, and/or drop in capability. As such, mechanical mounting requirements are by

definition minimized. The open-frame plate models (OZip-AFEA10PA*480***) have slotted corners as shown in Figure 26. The enclosed cabinet models (OZip-AFEA10CA*480***) have three of six sides of the comprising cube unmodified to allow maximum orientation flexibility for the end user. As shown in Figure 4, these sides are the left edge, the bottom edge, and the back edge from this vantage point.

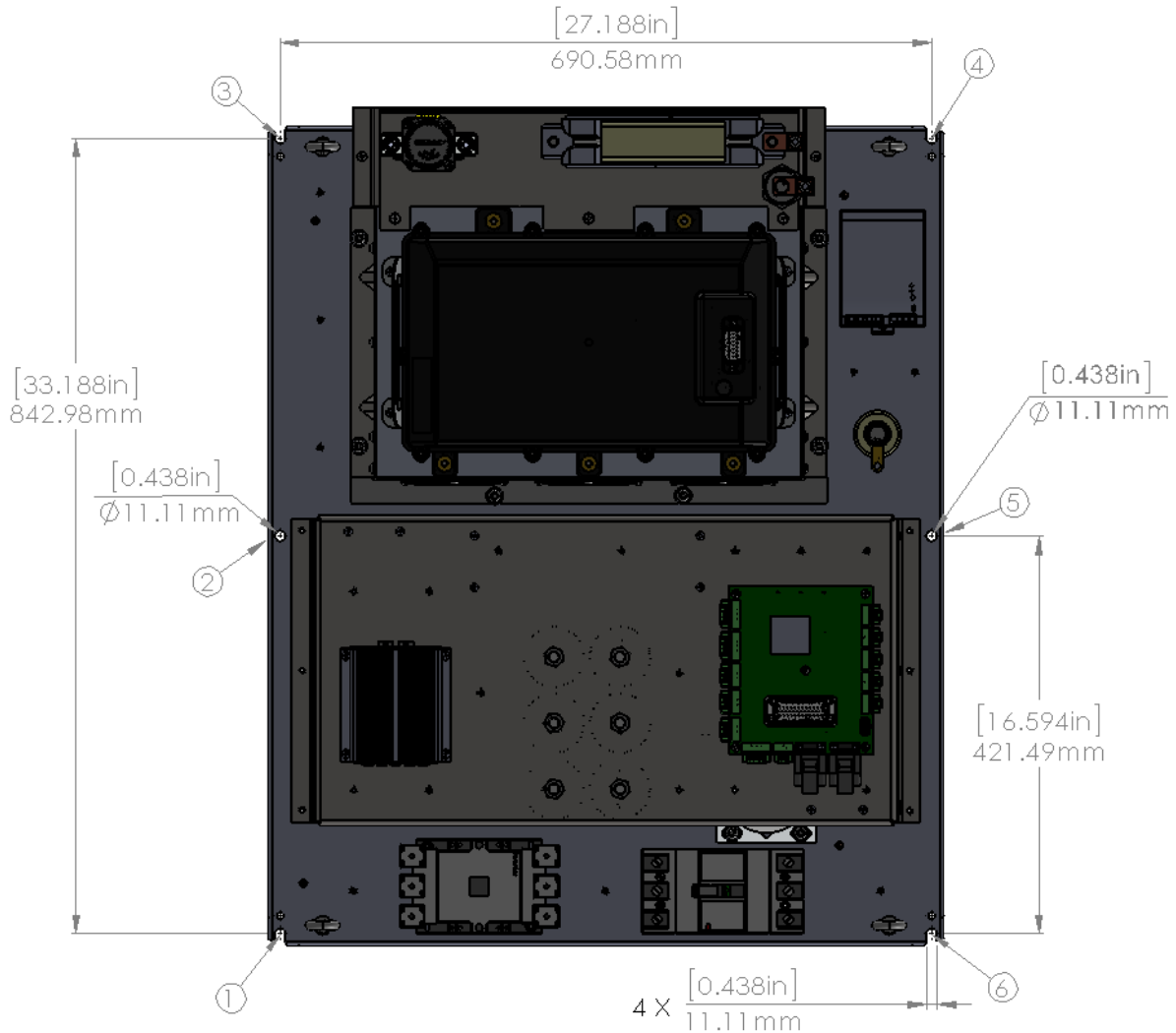

SECURE MOUNTING PLATE (6 PLACES) WITH M8 (5/16") HARDWARE.

Figure 26: Mechanical Mounting Diagram, Models OZip-AFEA10PA*480***

9.2 Power Cable Connections

Provide an earth (safety) ground to the heatsink in accordance with local electrical codes, at locations shown in Section 7.1.

**DANGER**

With no bias, AC, or DC voltage present, connect each power terminal using the proper torque level and hardware stackup as defined in Section 7.2. It is highly recommended that contact lubricant be applied prior to installation to extend cable interface longevity.

9.3 Communication and Customer I/O Connections

**DANGER**

With no bias, AC, or DC voltage present, engage the communication cable(s) and customer I/O cables, as defined in Section 7.3 (OZip-AFEP*****) or Section 0 (OZip-AFE-***C*****). It is recommended that these connections be secured with the threaded cable locks as provided.***

10. Servicing the Unit

The OZip-AFE IPS not field serviceable. Consult the Return Material Authorization Policy at the end of this document for instructions in the event that the unit needs to be returned to Oztek for evaluation and possible repair. In removing the OZip-AFE IPS from system installation, consult and follow the Electrical Safety precautions of Section 1.3.2.

11. Maintenance and Upgrade

Electrical connections should be regularly checked for mechanical integrity and thermal degradation. Airflow must be maintained unobstructed for maximum performance as specified.

12. Oztek Power Studio™ Tool

The Oztek Power Studio™ tool is a Microsoft Windows based Graphical User Interface (GUI), as shown in Figure 27, which can be used to easily configure and control the OZip-R IPM. The tool communicates with the unit over the CAN or RS-485 serial port and provides a simple, intuitive user interface. Some of the features provided by Power Studio™ include:

- Simple tabbed interfaces:
 - Dashboard
 - Configuration

- Instrumentation
- Dashboard for inverter control and monitoring
- Inverter configuration control, including:
 - Editing configurations
 - Downloading/uploading configurations
 - Archiving multiple configuration files
- Firmware Update Utility

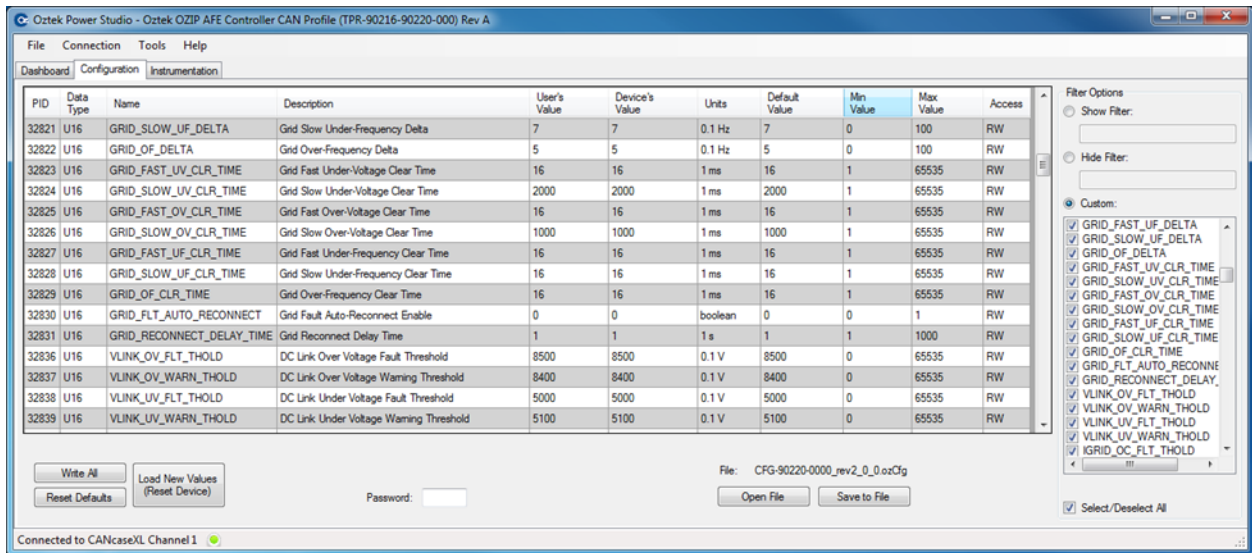

Figure 27: Oztek Power Studio™ GUI

For detailed information and operating instructions, please refer to UM-0052 Oztek Power Studio™ User's Manual.

Warranty and Product Information

Limited Warranty

What does this warranty cover and how long does it last? This Limited Warranty is provided by Oztek Corp. ("Oztek") and covers defects in workmanship and materials in your OZip-AFE IPS. This Warranty Period lasts for 18 months from the date of purchase at the point of sale to you, the original end user customer, unless otherwise agreed in writing. You will be required to demonstrate proof of purchase to make warranty claims. This Limited Warranty is transferable to subsequent owners but only for the unexpired portion of the Warranty Period. Subsequent owners also require original proof of purchase as described in "What proof of purchase is required?"

What will Oztek do? During the Warranty Period Oztek will, at its option, repair the product (if economically feasible) or replace the defective product free of charge, provided that you notify Oztek of the product defect within the Warranty Period, and provided that through inspection Oztek establishes the existence of such a defect and that it is covered by this Limited Warranty.

Oztek will, at its option, use new and/or reconditioned parts in performing warranty repair and building replacement products. Oztek reserves the right to use parts or products of original or improved design in the repair or replacement. If Oztek repairs or replaces a product, its warranty continues for the remaining portion of the original Warranty Period or 90 days from the date of the return shipment to the customer, whichever is greater. All replaced products and all parts removed from repaired products become the property of Oztek.

Oztek covers both parts and labor necessary to repair the product, and return shipment to the customer via an Oztek-selected non-expedited surface freight within the contiguous United States and Canada. Alaska, Hawaii and locations outside of the United States and Canada are excluded. Contact Oztek Customer Service for details on freight policy for return shipments from excluded areas.

How do you get service? If your product requires troubleshooting or warranty service, contact your merchant. If you are unable to contact your merchant, or the merchant is unable to provide service, contact Oztek directly at:

USA
Telephone: 603-546-0090
Email techsupport@oztekcorp.com

Direct returns may be performed according to the Oztek Return Material Authorization Policy described in your product manual.

What proof of purchase is required? In any warranty claim, dated proof of purchase must accompany the product and the product must not have been disassembled or modified without prior written authorization by Oztek. Proof of purchase may be in any one of the following forms:

- The dated purchase receipt from the original purchase of the product at point of sale to the end user
- The dated dealer invoice or purchase receipt showing original equipment manufacturer (OEM) status
- The dated invoice or purchase receipt showing the product exchanged under warranty

What does this warranty not cover? Claims are limited to repair and replacement, or if in Oztek's discretion that is not possible, reimbursement up to the purchase price paid for the product. Oztek will be liable to you only for direct damages suffered by you and only up to a maximum amount equal to the purchase price of the product.

This Limited Warranty does not warrant uninterrupted or error-free operation of the product or cover normal wear and tear of the product or costs related to the removal, installation, or troubleshooting of the customer's electrical systems. This warranty does not apply to and Oztek will not be responsible for any defect in or damage to:

- a) The product if it has been misused, neglected, improperly installed, physically damaged or altered, either internally or externally, or damaged from improper use or use in an unsuitable environment
- b) The product if it has been subjected to fire, water, generalized corrosion, biological infestations, or input voltage that creates operating conditions beyond the maximum or minimum limits listed in the Oztek product specifications including high input voltage from generators and lightning strikes
- c) The product if repairs have been done to it other than by Oztek or its authorized service centers (hereafter "ASCs")
- d) The product if it is used as a component part of a product expressly warranted by another manufacturer
- e) The product if its original identification (trade-mark, serial number) markings have been defaced, altered, or removed
- f) The product if it is located outside of the country where it was purchased
- g) Any consequential losses that are attributable to the product losing power whether by product malfunction, installation error or misuse.

Disclaimer

Product

THIS LIMITED WARRANTY IS THE SOLE AND EXCLUSIVE WARRANTY PROVIDED BY OZTEK IN CONNECTION WITH YOUR OZTEK PRODUCT AND IS, WHERE PERMITTED BY LAW, IN LIEU OF ALL OTHER WARRANTIES, CONDITIONS, GUARANTEES, REPRESENTATIONS, OBLIGATIONS AND LIABILITIES, EXPRESS OR IMPLIED, STATUTORY OR OTHERWISE IN CONNECTION WITH THE PRODUCT, HOWEVER ARISING (WHETHER BY CONTRACT, TORT, NEGLIGENCE, PRINCIPLES OF MANUFACTURER'S LIABILITY, OPERATION OF LAW, CONDUCT, STATEMENT OR OTHERWISE), INCLUDING WITHOUT RESTRICTION ANY IMPLIED WARRANTY OR CONDITION OF QUALITY, MERCHANTABILITY OR FITNESS FOR A PARTICULAR PURPOSE. ANY IMPLIED WARRANTY OF MERCHANTABILITY OR FITNESS FOR A PARTICULAR PURPOSE TO THE EXTENT REQUIRED UNDER APPLICABLE LAW TO APPLY TO THE PRODUCT SHALL BE LIMITED IN DURATION TO THE PERIOD STIPULATED UNDER THIS LIMITED WARRANTY. IN NO EVENT WILL OZTEK BE LIABLE FOR: (a) ANY SPECIAL, INDIRECT, INCIDENTAL OR CONSEQUENTIAL DAMAGES, INCLUDING LOST PROFITS, LOST REVENUES, FAILURE TO REALIZE EXPECTED SAVINGS, OR OTHER COMMERCIAL OR ECONOMIC LOSSES OF ANY KIND, EVEN IF OZTEK HAS BEEN ADVISED, OR HAD REASON TO KNOW, OF THE POSSIBILITY OF SUCH DAMAGE, (b) ANY LIABILITY ARISING IN TORT, WHETHER OR NOT ARISING OUT OF OZTEK'S NEGLIGENCE, AND ALL LOSSES OR DAMAGES TO ANY PROPERTY OR FOR ANY PERSONAL INJURY OR ECONOMIC LOSS OR DAMAGE CAUSED BY THE CONNECTION OF A PRODUCT TO ANY OTHER DEVICE OR SYSTEM, AND (c) ANY DAMAGE OR INJURY ARISING FROM OR AS A RESULT OF MISUSE OR ABUSE, OR THE INCORRECT INSTALLATION, INTEGRATION OR OPERATION OF THE PRODUCT. IF YOU ARE A CONSUMER (RATHER THAN A PURCHASER OF THE PRODUCT IN THE COURSE OF A BUSINESS) AND PURCHASED THE PRODUCT IN A MEMBER STATE OF THE EUROPEAN UNION, THIS LIMITED WARRANTY SHALL BE SUBJECT TO YOUR STATUTORY RIGHTS AS A CONSUMER UNDER THE EUROPEAN UNION PRODUCT WARRANTY DIRECTIVE 1999/44/EC AND AS SUCH DIRECTIVE HAS BEEN IMPLEMENTED IN THE EUROPEAN UNION MEMBER STATE WHERE YOU PURCHASED THE PRODUCT. FURTHER, WHILE THIS LIMITED WARRANTY GIVES YOU SPECIFIC LEGAL RIGHTS, YOU MAY HAVE OTHER RIGHTS WHICH MAY VARY FROM EU MEMBER STATE TO EU MEMBER STATE OR, IF YOU DID NOT PURCHASE THE PRODUCT IN AN EU MEMBER STATE, IN THE COUNTRY YOU PURCHASED THE PRODUCT WHICH MAY VARY FROM COUNTRY TO COUNTRY AND JURISDICTION TO JURISDICTION.

Return Material Authorization Policy

Before returning a product directly to Oztek you must obtain a Return Material Authorization (RMA) number and the correct factory "Ship To" address. Products must also be shipped prepaid. Product shipments will be refused and returned at your expense if they are unauthorized, returned without an RMA number clearly marked on the outside of the shipping box, if they are shipped collect, or if they are shipped to the wrong location.

When you contact Oztek to obtain service, please have your instruction manual ready for reference and be prepared to supply:

- The serial number of your product
- Information about the installation and use of the unit
- Information about the failure and/or reason for the return
- A copy of your dated proof of purchase

Return Procedure

Package the unit safely, preferably using the original box and packing materials. Please ensure that your product is shipped fully insured in the original packaging or equivalent. This warranty will not apply where the product is damaged due to improper packaging. Include the following:

- The RMA number supplied by Oztek clearly marked on the outside of the box.
- A return address where the unit can be shipped. Post office boxes are not acceptable.
- A contact telephone number where you can be reached during work hours.
- A brief description of the problem.

Ship the unit prepaid to the address provided by your Oztek customer service representative.

If you are returning a product from outside of the USA or Canada - In addition to the above, you **MUST** include return freight funds and you are fully responsible for all documents, duties, tariffs, and deposits.

Out of Warranty Service

If the warranty period for your product has expired, if the unit was damaged by misuse or incorrect installation, if other conditions of the warranty have not been met, or if no dated proof of purchase is available, your unit may be serviced or replaced for a flat fee. If a unit cannot be serviced due to damage beyond salvation or because the repair is not economically feasible, a labor fee may still be incurred for the time spent making this determination.

To return your product for out of warranty service, contact Oztek Customer Service for a Return Material Authorization (RMA) number and follow the other steps outlined in "Return Procedure".

Payment options such as credit card or money order will be explained by the Customer Service Representative. In cases where the minimum flat fee does not apply, as with incomplete units or units with excessive damage, an additional fee will be charged. If applicable, you will be contacted by Customer Service once your unit has been received.