

460 VAC  
3 PHASE  
60 HZ

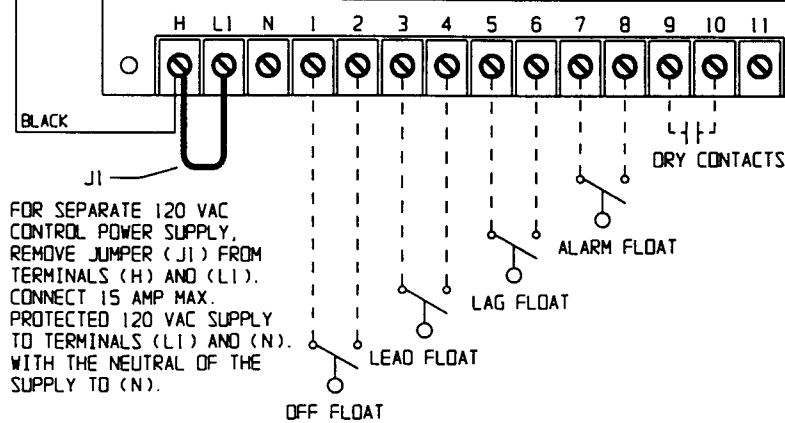
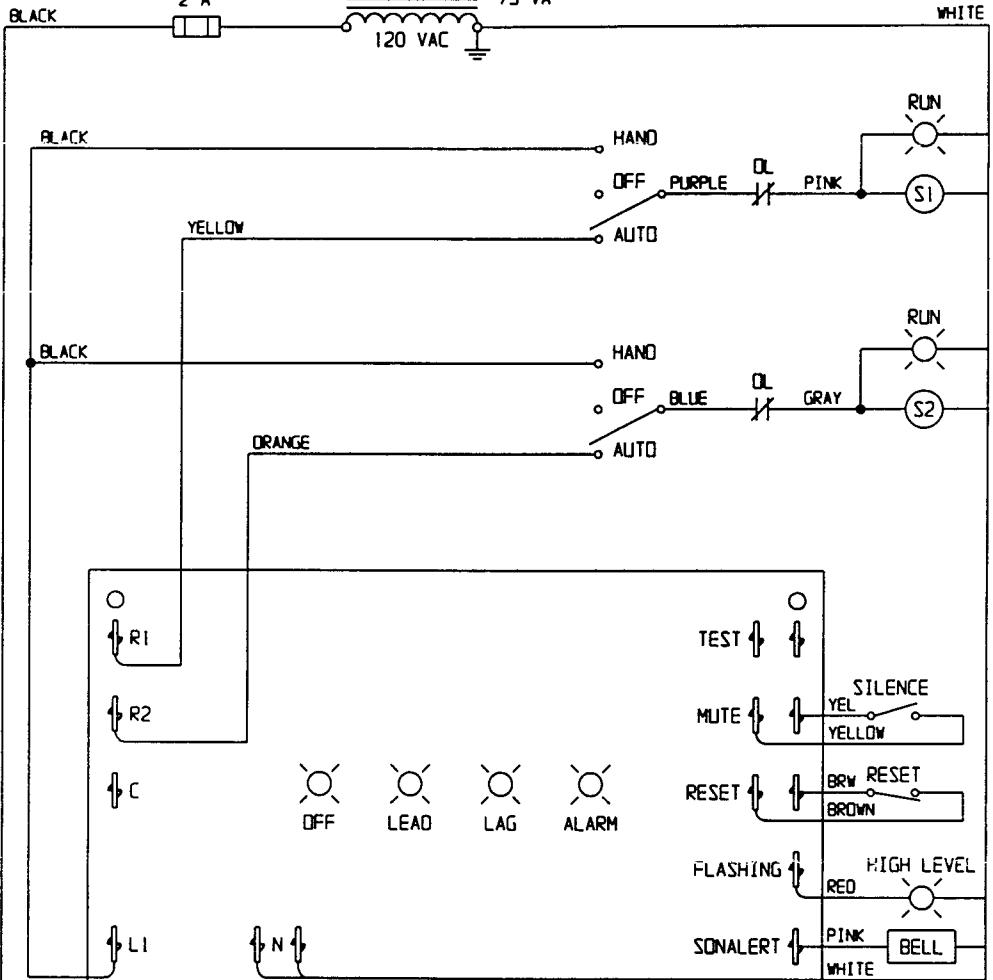
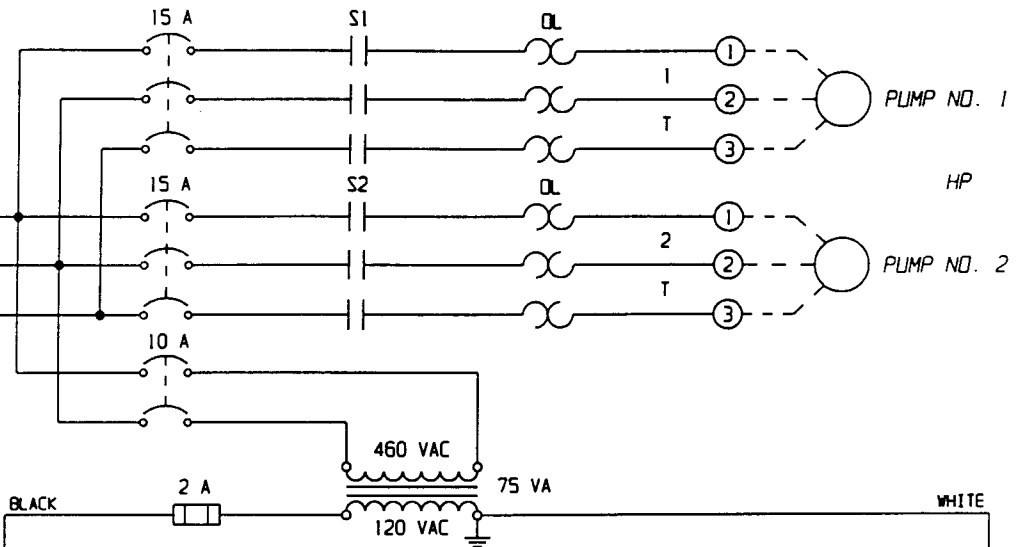

FOR SEPARATE 120 VAC CONTROL POWER SUPPLY, REMOVE JUMPER (J1) FROM TERMINALS (H) AND (L1). CONNECT 15 AMP MAX. PROTECTED 120 VAC SUPPLY TO TERMINALS (L1) AND (N). WITH THE NEUTRAL OF THE SUPPLY TO (N).

THIS DRAWING IS THE PROPERTY OF BOLLAY FABRICATION, INC. DRAWING TO BE RETURNED UPON REQUEST.

REVISION	DATE	APPROVED	DATE

MODEL NUMBER: BF-404

ORDER

**BOLLAY FABRICATION, INC.**  
 P.O. Box 508 Lafayette N.Y. 13084 Phone 315-677-5247  
 UL/CSA Approved Electrical Control Panels Fax 315-677-5325

PREPARED FOR: HUGH J. CULLEN ASSOCIATES

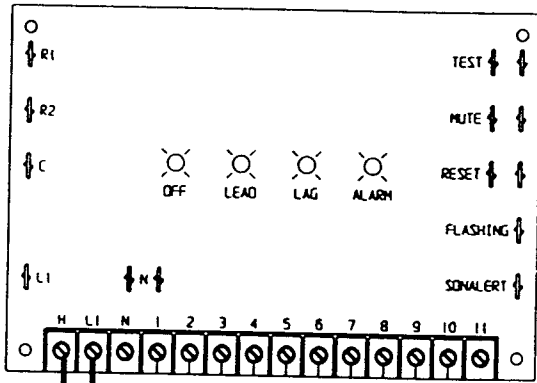
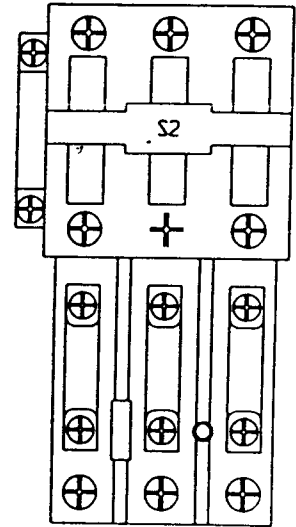
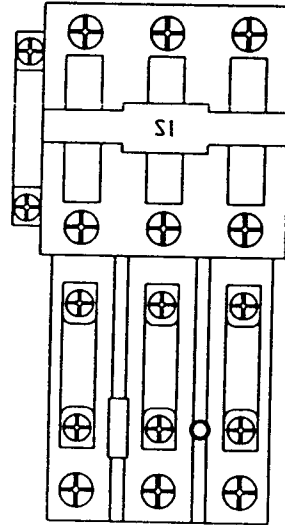
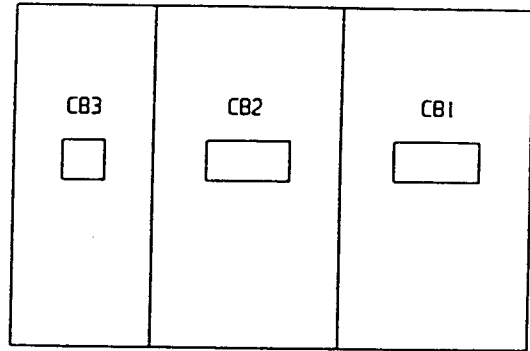
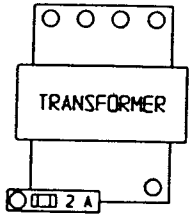

J1      DRY CONTACTS

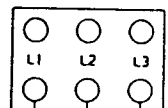
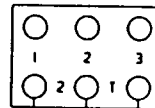
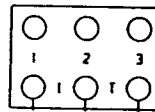

FOR SEPARATE 120 VAC CONTROL POWER SUPPLY, REMOVE JUMPER (J1) FROM TERMINALS (H) AND (L1). CONNECT 15 AMP MAX. PROTECTED 120 VAC SUPPLY TO TERMINALS (L1) AND (N), WITH THE NEUTRAL OF THE SUPPLY TO (N).

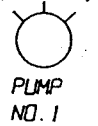
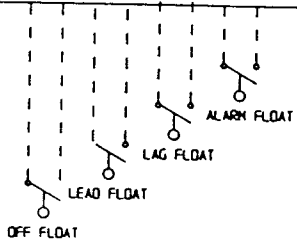

460 VAC  
3 PHASE  
60 HZ

BILL OF MATERIALS

ENCLOSURE LAYOUT

PANEL LAYOUT

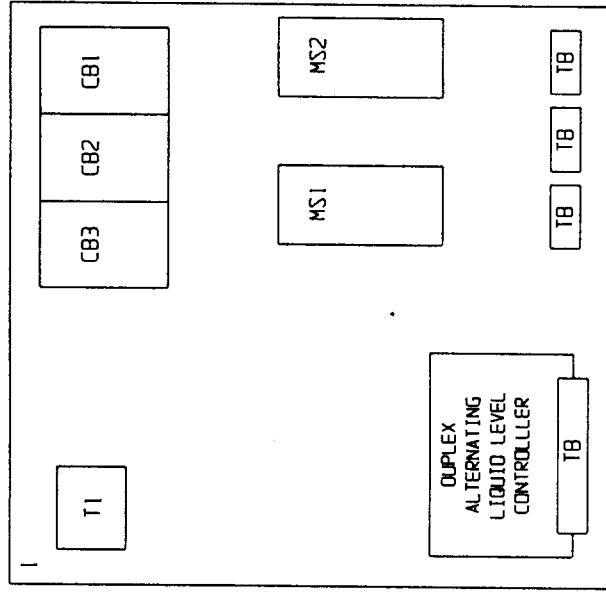
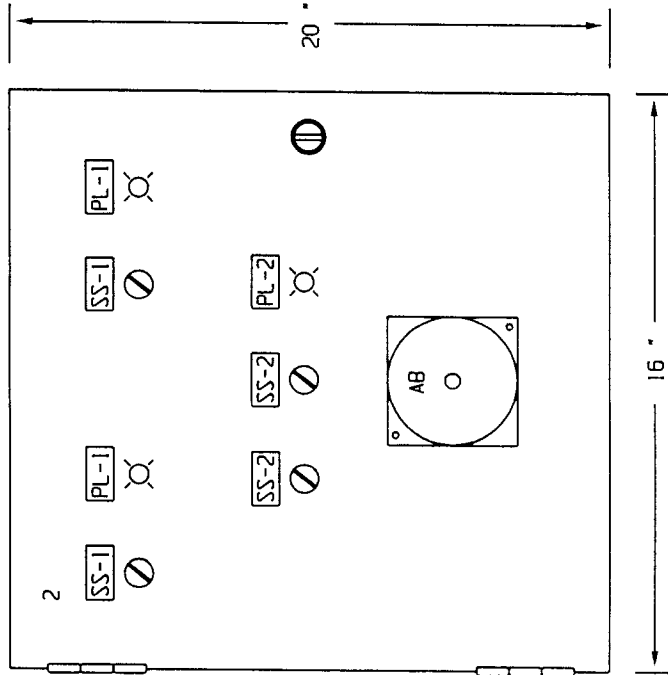

ITEM	QTY.	MFR.	CAT. NUMBER	DESCRIPTION
CB1.2	2	SQUARE 0	00UJ330	CIRCUIT BREAKERS: PUMPS
CB3	1	SQUARE 0	00UJ210	CIRCUIT BREAKER: CONTROL
MS1.2	2	FURNAS	14USD32AF51	MOTOR STARTERS
T1	1	SQUARE 0	S3033-525-50	TRANSFORMER
LLC	1	BOULAY FABRICATION	BFI-LLC-120	DUPLEX ALTERNATING LIQUID LEVEL CONTROL
SS1	2	GC	35-110BJ	SWITCHES: H-O-A
SS2	2	MORRIS	635H/2	SWITCHES: HIGH LEVEL RESET & SILENCE
PL1	2	LITTLE LIGHT	980-670A-96-MCN	PILOT LIGHTS: RUN
PL2	1	LITTLE LIGHT	980-670A-96WRN	PILOT LIGHT: HIGH LEVEL ALARM
AB	1	EDWARDS	434-4N5	BELL: HIGH LEVEL
1	1	McKINSTRY	42-2016	PANEL
2	1	McKINSTRY	30-20166	NEMA 1 ENCLOSURE

THIS DRAWING IS THE PROPERTY OF BOULAY FABRICATION, INC. DRAWING TO BE RETURNED UPON REQUEST.

DRAWING DATE: 12-4-03  
 JJJH  
 APPROVED DATE: \_\_\_\_\_  
 REVISED DATE: \_\_\_\_\_

MODEL NUMBER: ORDER

**BOULAY FABRICATION, INC.**  
 P.O. Box 508 Lafayette N.Y. 13084 Phone 315-677-5247  
 UL/CISA Approved Electrical Control Panels Fax 315-677-5325

PREPARED FOR: HUGH J. CULLEN ASSOCIATES

## Operation

1. FS1 switch closes as the water level rises.
2. FS2 switch closes as the water level rises. The Lead Pump is selected to run. The Lead Pump is the first pump to come on. A green light mounted on cover of the enclosure turns on.
3. FS3 switch closes as the water level rises. The Lag Pump is selected to run. The Lag Pump is the second pump to come on. A second green light mounted on cover of the enclosure turns on.
4. FS2 switch opens when the water level drops below FS2. Lead and Lag Pump will remain on.
5. FS1 switch opens when the water level drops below FS1. Both pumps and green lights turn off.
6. Alternation of Pump 1 and Pump 2 takes place for the next start. Pump 1 or Pump 2 will become the new Lead Pump.

## High Water System

1. FSA switch closes as the water rises signaling the red high water light, audible device and isolated contact relay to pull in.
2. The audible device remains on until:
  - a. The water level falls below the FSA switch, which opens.
  - b. Is shut off using the Test-Auto-Silence Alarm switch mounted on cover of the enclosure.
3. The high water light and the isolated contact relay will remain on until the water level drops causing FSA switch to open.

## Level Control Switches

- ~~8220 - Pressure Diaphragm~~
- 8230 - Tethered

