

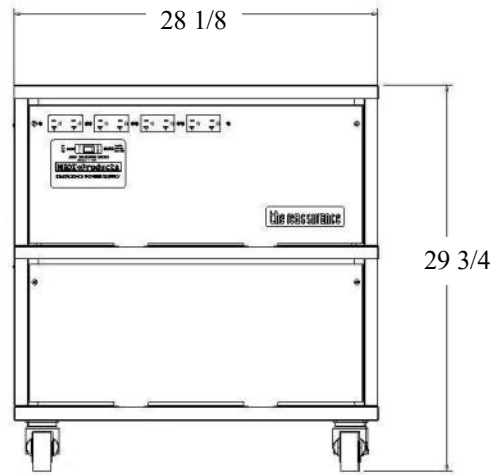

Model Number: MCS1240T



Specifications:

Electrical Input	120 volt 15 Amp male plug
Electrical Output (watts)	1250
Surge Output	2500 watts
Electrical Output (volts)	120 volts
Battery Capacity	400 amp hours
Number of Outlets	8 -15 amp
Waveform	Modified Sine
Physical Size	28.25 x 16.5 x 17.75
Approx. Shipping Weight	350 lbs

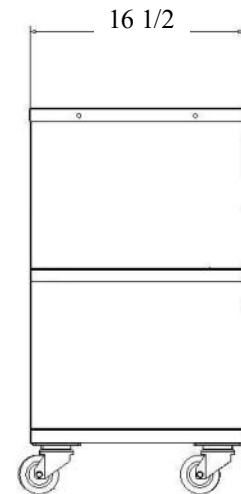

MEDI+PRODUCTS

BACK-UP POWER SYSTEMS

Products by Medicanix

30 Nurney Street
 Stamford, CT 06902
 203-348-2886 ph
 203-487-7423 fax
www.mediproducts.net
sales@mediproducts.net