

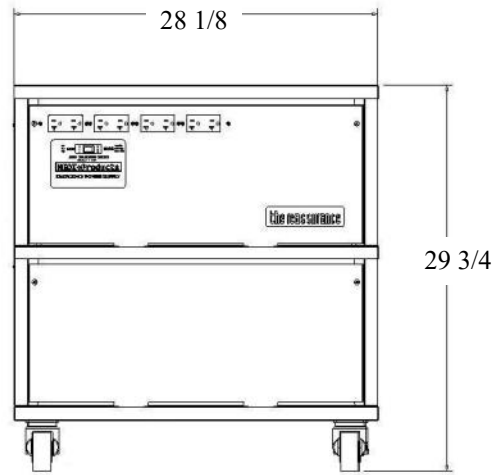

# Model Number: MCS2040T



## Specifications:

Electrical Input	120 volt 15 Amp male plug
Electrical Output (watts)	2000
Surge Output	4000 watts
Electrical Output (volts)	120 volts
Battery Capacity	400 amp hours
Number of Outlets	8 - 15 amp
Waveform	Modified Sine
Physical Size	28.25 x 16.5 x 17.75
Approx. Shipping Weight	440 lbs

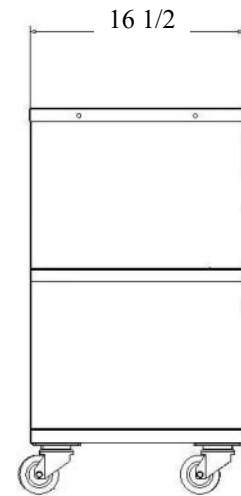

**MEDI+PRODUCTS**

**BACK-UP POWER SYSTEMS**

*Products by Medicanix*

30 Nurney Street  
 Stamford, CT 06902  
 203-348-2886 ph  
 203-487-7423 fax  
[www.mediproducts.net](http://www.mediproducts.net)  
[sales@mediproducts.net](mailto:sales@mediproducts.net)