

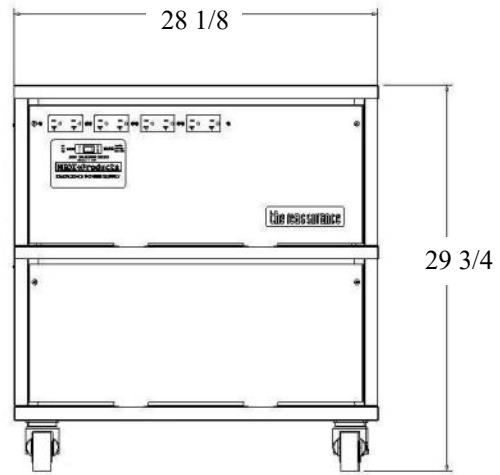

Model Number: MCS3140M



Specifications:

Electrical Input	120 volt 15 Amp male plug
Electrical Output (watts)	3100
Surge Output	6000 watts
Electrical Output (volts)	120 volts
Battery Capacity	400 amp hours
Number of Outlets	8 – 15 amp
Waveform	Modified Sine
Physical Size	28.25 x 16.5 x 17.75
Approx. Shipping Weight	440 lbs

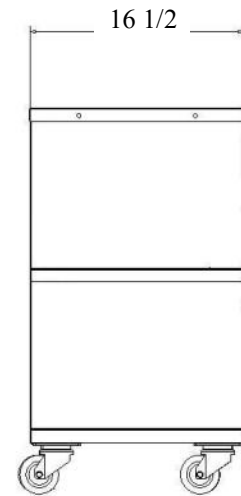

MEDI+PRODUCTS

BACK-UP POWER SYSTEMS

Products by Medicanix

30 Nurney Street
 Stamford, CT 06902
 203-348-2886 ph
 203-487-7423 fax
www.mediproducts.net
sales@mediproducts.net