



PDI-P26/P32/P40LCDE

P-Series Modular Healthcare-grade LCD Televisions



Document Number: PD196-190R2

	MODEL NUMBER: PDI-P26/P32/P40LCDE	Document Number: PD196-190R2
	Quick Start Guide	Page 1 of 10



 This symbol is intended to alert the user of the presence of un-insulated 'dangerous voltage' within the product's enclosure that may be of sufficient magnitude to constitute a risk of electric shock to persons.

 This symbol is intended to alert the user of the presence of important operating and maintenance (servicing) instructions in the literature accompanying the appliance.

NOTE TO CABLE TV INSTALLER

This reminder is provided to call the cable TV systems installer's attention to Article 820-40 of the National Electrical Code. The code provides guidelines for proper grounding and, in particular, specifies that the cable ground shall be connected to the grounding system of the building, as close to the point of the cable entry as practical.

FCC

This equipment has been tested and found to comply with the limits for a Class B digital device, pursuant to part 15 of the FCC Rules. These limits are designed to provide reasonable protection against harmful interference when the equipment is operated in a residential or commercial installation. If this equipment does cause harmful interference to radio or TV reception, which can be determined by turning the equipment off and on, the user is encouraged to try to correct the interference by one of more of the following measures:

- Reorient or relocate the receiving antenna.
- Increase the separation between the equipment and receiver.
- Connect the equipment into an outlet on a circuit different from that to which the receiver is connected.
- Consult the dealer or an experienced radio/TV technician for help.

Copyright, Disclaimer, & Trademarks

COPYRIGHT

PDi Communication Systems, Inc. claims proprietary right to the material disclosed in this user guide. This guide is issued for user information only and may not be used to manufacture anything shown herein. Copyright 2011 by PDi Communication Systems, Inc. All rights reserved.

DISCLAIMER

The author and publisher have used their best efforts in preparing this guide. PDi Communication Systems, Inc. makes no representation or warranties with respect to the accuracy or completeness of the content of this guide and specifically disclaims any implied warranties or merchantability or fitness for any particular purpose and shall in no event be liable for any loss of profit or any other

damages. The information contained herein is believed to be accurate, but is not warranted, and is subject to change without notice or obligation.

TRADEMARKS

Manufactured under license from Dolby Laboratories. Dolby and the double-D symbol are trademarks of Dolby Laboratories. All other brand names and product names used in this guide are trademarks, registered trademarks, or trade names of their respective holders. PDi and Better Solutions Are Within Reach are registered trademarks of PDi Communication Systems, Inc., Springboro, Ohio.

LOCATION GUIDELINES

The model PDI-P26/P32/P40LCDE Hospital Grade LCD TV is a specialized LCD TV. It is intended for entertainment and educational purposes in a hospital, a nursing home, medical-care center, or similar health-care facility in which installation is limited to a non-hazardous area in accordance with the National Electrical Code, ANSI/NFPA 70. The PDI-P26/P32/P40LCDE is designed for mounting to PDi manufactured mounts. Installation of the TV on any other mount is not recommended.

WARNING





The TV's VESA mounting holes are designed for M4 and/or M6 metric screws only. Use of a non-PDi approved mount or SAE hardware could result in a condition where the TV could unexpectedly fall and cause injury or death.

The PDI-P26/P32/P40LCDE TV mounts on the wall at the foot of a patient's bed. Select a location that is near an AC wall outlet and that does not expose the TV to bright room lights or sunlight, if possible. The LCD TV also requires connection of both CATV cable signal and across-room wiring for the pillow speaker.

CABLE SYSTEM GROUNDING

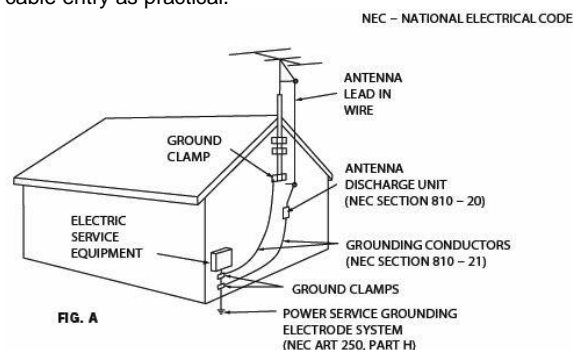
The coax cable system connected to the PDI-P26/P32/P40LCDE TV should be grounded in accordance with the National Electrical Code, ANSI/NFPA 70. The code provides guidelines for proper grounding and, in particular, specifies that the cable ground shall be connected to the grounding system of the building, as close to the point of the cable entry as practical.



	MODEL NUMBER: PDI-P26/P32/P40LCDE	Document Number: PD196-190R2
	Quick Start Guide	Page 2 of 10

SAFETY INSTRUCTIONS

INSTRUCTIONS

Be sure to read, follow, and keep these instructions. Heed all the warnings.

OTHER EQUIPMENT

Use only with the cart, stand, tripod, bracket or table specified by the manufacturer or sold with the apparatus. Use caution when moving the cart / apparatus combination to avoid injury from tip-over.



OVERHEAD FALLING HAZARD



WARNING: To prevent injury, this apparatus must be securely attached to the wall in accordance with the installation instructions. TVs can pose a striking hazard when mounted at an elevated position.



MAINTENANCE AND SERVICING

Servicing is required when the apparatus has been damaged in any way, the power cord or plug is damaged, liquid has been spilled, objects have fallen into the apparatus, the apparatus has been exposed to rain or moisture, it does not operate normally, or it has been dropped. **NEVER** remove the back cover of the TV; this can expose you to high voltage and other hazards. If the TV does not operate properly, unplug it and call an authorized service center or PDi.



POWER CORD

Protect the power cord from being walked on or pinched, particularly at the plugs, convenience receptacles, and the point where it exits from the apparatus.

CAUTION: DO NOT defeat the safety purpose of the polarized or grounding-type plug. A polarized plug has two blades with one wider than the other. A grounding type plug has two

plates and a third grounding prong. The wide blade or the third prong is provided for your safety. If the provided plug does not fit into your outlet, consult an electrician for replacement of the obsolete outlet.



RAIN AND MOISTURE

WARNING: To avoid the hazards of fire or electrical shock, DO NOT expose this TV to rain or moisture.



WET LOCATION

The apparatus SHOULD NOT be exposed to dripping or splashing. Objects filled with liquids, such as vases, SHOULD NOT be placed on the apparatus.



OXYGEN ENVIRONMENT

WARNING: DO NOT use in an oxygen tent or an oxygen chamber. Such use may cause a fire hazard.



CLEANING AND DISINFECTION

Clean the exterior of this TV by removing dust with a lint-free cloth. **CAUTION:** To avoid damage to the surface of the TV, DO NOT use abrasive or chemical cleaning agents. Clean only with a dry cloth.

DISCONNECTING DEVICE FROM MAINS

The main plug is the disconnecting device. **CAUTION:** Unplug this apparatus during lightning storms or when unused for long periods of time.

PRODUCT MODIFICATION

DO NOT attempt to modify this product in any way without written authorization. Unauthorized modification could void the user's authority to operate this product.

Wall Mounting with Standard Wall Bracket for PDI-P26LCDE TV

The PDI-P26LCD TV is mounted to the wall with a PD168-103 mount (Not supplied with TV) or a PD168-203 mount (Not supplied with TV). The PD168-203 mount is a heavy duty mount and is to be used if a DVD or an IPT module is going to be mounted on the P26. A PD181-674 wall mount connects to a PD181-596 LCD mount. A PD181-697 wall mount connects to a PD181-596 LCD mount.

Mounting Pieces		
Wall Mount	LCD Mount	Purpose
PD181-697	PD181-596	For mounting PDI-P26LCD TV to wall without DVD and/or IPT Modules (1)
PD181-674	PD181-596	For mounting PDI-P26LCD TV to wall with DVD and/or IPT Modules (1)
Screws		
Part #	Part	
PDIPPBHSCS103250	10-32 X 1/2 Pilfer Proof PIH Button Head (2)	
PDIPPHMSM4X76	M4-7 X 6MM PPHMS (4)	
Numbers in parenthesis represent quantity		

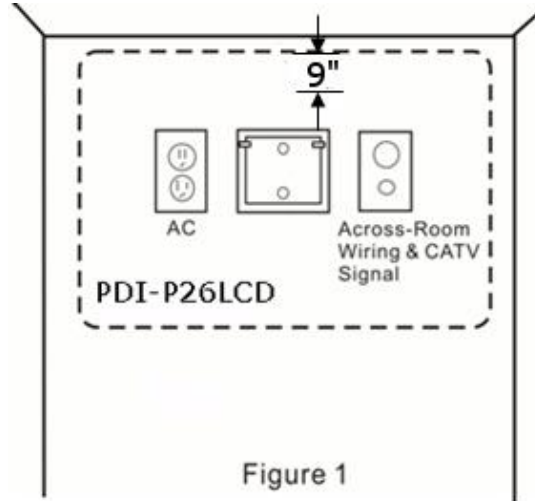

1. Refer to Figure 1. Select a location on the wall approximately 9 inches below the ceiling.

NOTE: DO NOT locate AC, Across-Room Wiring, and CATV Signal outlets below the Wall Bracket's location as it will cause clearance issues and interfere with the TV's cabinet when mounted to the bracket.

2. Position the wall mount and locate the two mounting holes. Secure the bracket to the wall (mounting hardware is not included).

Attach with the four M4 screws (PDIPPHMSM4X76) that are provided.

4. Mate the LCD mount to the wall mount, making sure the pivot pins are retained in the slots.

5. Secure with two 10x32 Pilfer screws (PDIPPBHSCS103250).

6. The TV's tilt can be adjusted by loosening both Pilfer screws, adjusting tilt, and then tightening the screws.

Mounting Connections

Figure 2

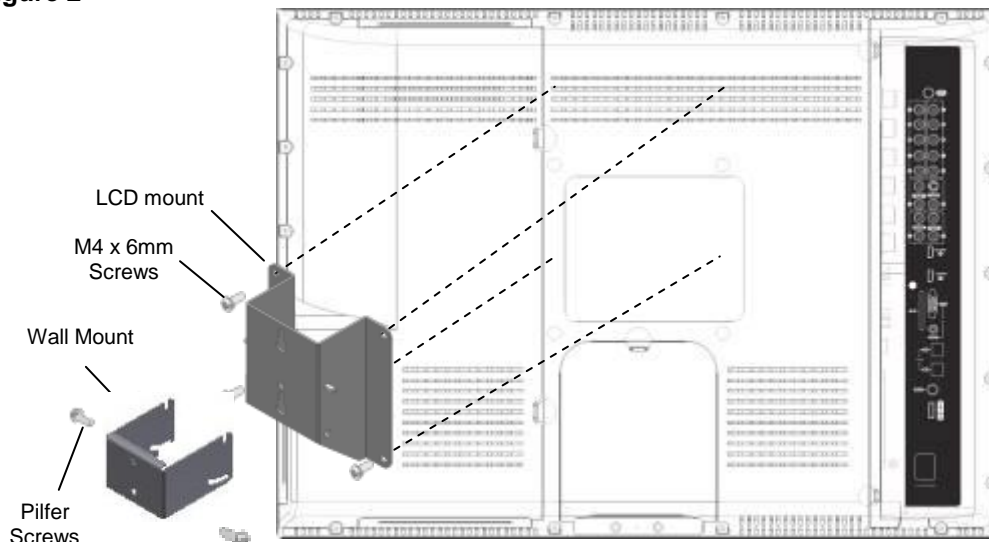

Wall Mounting for PDI-P32LCDE TV and PDI-P40LCDE TV

The PDI-P32LCDE and PDI-P40LCDE televisions require a PD168-033 kit (Not supplied with TV) to be mounted to the wall.

1. **Refer to Figure 1.** For the PDI-P32LCD find a location on the wall 10.5 inches below the ceiling to mount the HD Extended LCD Tilt Clevis (wall mount). For the PDI-P40LCD, the location will be 10 inches below the ceiling.

NOTE: DO NOT locate AC, Across-Room Wiring, and CATV Signal outlets below the Wall Bracket's location as it will cause clearance issues and interfere with the TV's cabinet when mounted to the bracket.

2. Position the HD Extended LCD Tilt Clevis and locate two mounting holes. Place one of the supplied 1/4" flat washers (PDIFW25) and the 1/4" lock washer (PDISLW25) on a 1/4" screw (not included) and insert it into the top mounting hole of the clevis. Secure the clevis to the wall. Place the other supplied 1/4" flat washer on another 1/4" screw and insert it in the bottom mounting hole. Secure it to the wall and tighten both screws.
3. **Refer to Figure 2.** Attach the LCD mount to adapter plate using the four M4 screws (PDIPPHMSM4X76) and four #10 Internal Tooth Lock washers (PDIITLW10).

NOTE: The side with the four hex sides will go toward the back of the set.

4. Position the mounting bracket and adapter plate on the LCD TV cabinet. Attach with the four M6 screws (PDIPPHMSM6X110) that are provided.

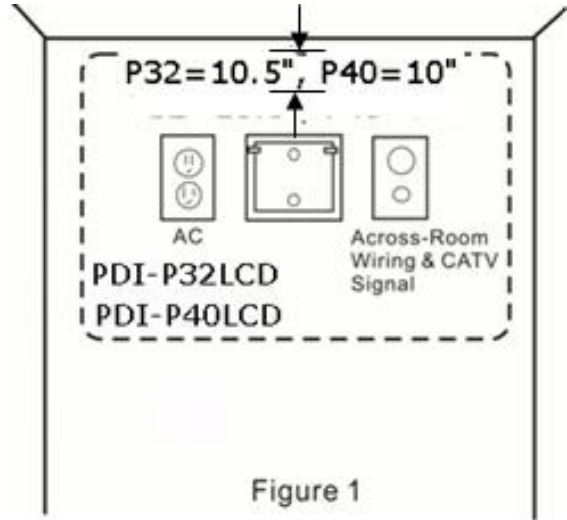
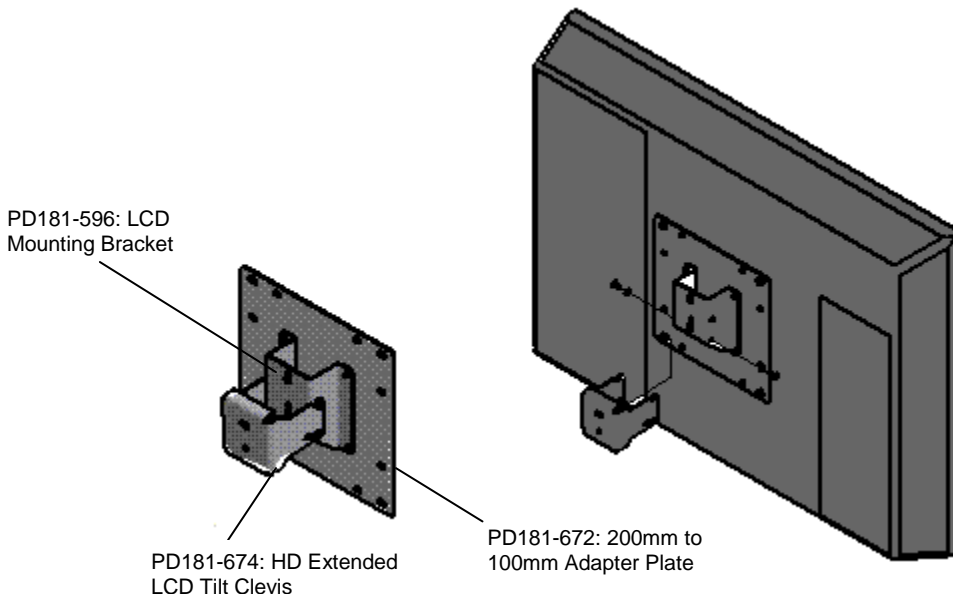

Figure 1

5. Mate the mounting bracket to the clevis making sure the resting pins are inserted in the two notches at the front of the clevis. Secure with the two 10x32 screws (PDIPPHMS103238) and the two remaining Internal Tooth Lock washers.
6. The TV's tilt can be adjusted by loosening both Pilfer Screws, adjusting tilt, and then tightening the screws.

Mounting Connections

Figure 2



Mounting Pieces	
Part #	Part
PD181-672	200mm to 100mm Adapter Plate (1)
PD181-596	LCD Mounting Bracket (1)
PD181-674	HD Extended LCD Tilt Clevis (1)
Screws and Washers	
PDIPPHMS103238	10-32X3/8 PPHMS (2)
PDIITLW10	#10 Internal Tooth Lock Washer (6)
PDIPPHMSM4X76	M4-.7X6mm PPHMS (4)
PDIPPHMSM6X110	M6-1X10mm PPHMS (4)
PDIFW25	1/4" flat washer (2)
PDISLW25	1/4" lock washer (1)
Numbers in parenthesis represent quantity	

	MODEL NUMBER: PDI-P26/P32/P40LCDE	Document Number: PD196-190R2
	Quick Start Guide	Page 5 of 10

Pillow speaker

A 1/4" stereo-style pillow speaker (pendant control) jack is located on the TV's connector panel on the backside. This TV is designed to work with either a digital pillow speaker that generates digital-style control codes or a single-button analog (switch-style) pillow speaker. A rear panel mounted switch allows use of different brands of pillow speakers and supports the major brands: Zenith, Philips, and RCA.

	<p>CAUTION: Confirm the pillow speaker type and set the side switch appropriately BEFORE connecting the pillow speaker to the TV. Failure to follow this procedure could result in damage to the pillow speaker and/or TV.</p>
--	---

Pillow Speaker and Antenna Connection

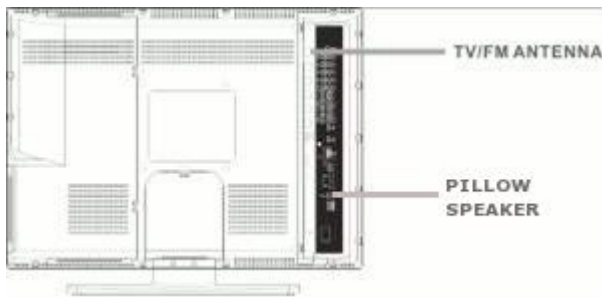

CAUTION: Some hospital cable systems provide power voltage on the coaxial cable. This TV is NOT designed to be powered via a coaxial cable. DO NOT connect to a powered coaxial cable. Damage will result to the TV.

Across-Room Wiring

NOTE: A Jumper Cable is NOT supplied with the TV and must be ordered separately.

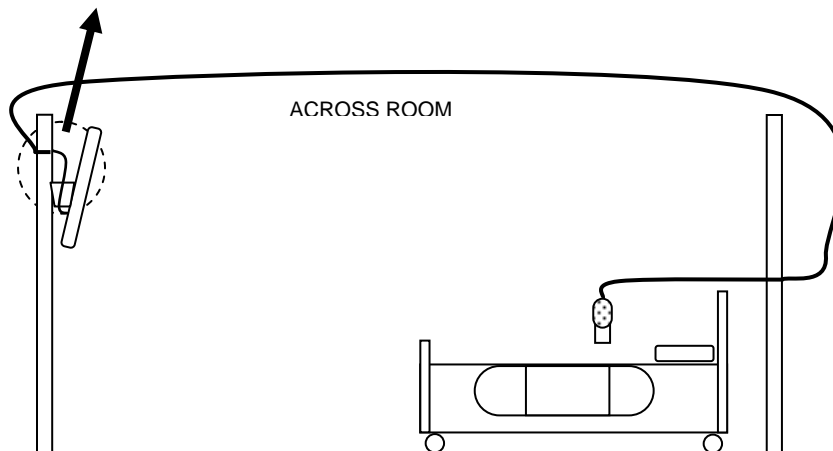
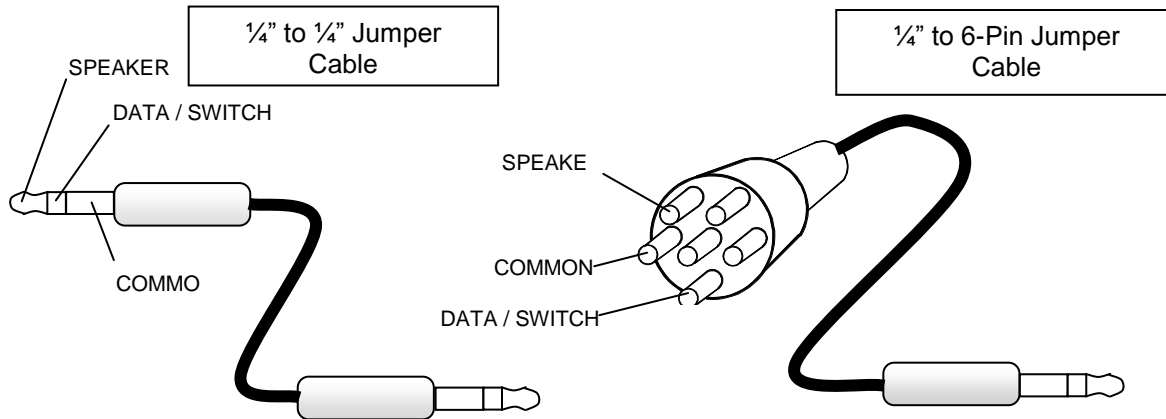

WARNING: DO NOT connect the pillow speaker circuit Common to earth ground. Grounding of the Common will defeat the isolation circuitry of the TV and possibly expose the patient to harmful shock currents should a wiring fault occur.

Programming

A programming remote control (PD108-420) is used to perform all setup operations for the TV.

NOTE: The following instructions assume you have correctly mounted the TV, wired an external pillow speaker, and connected an RF coax cable signal, and AC power cord to the TV.

Service Levels Setup

The PDI-P26/P32/P40LCDE TV contains four separate service levels, allowing the hospital to offer basic and enhanced viewing. The current service level can be quickly determined by accessing the SETUP menu using the remote control. Service Level can be changed to any of the 4 levels at any time by entering the SETUP menu and changing the Service Level setting.



DISABLED – This is like a mechanical key lock. The TV can be turned OFF and ON, but cannot be used for viewing programs. A standard message appears on a black screen.

FREE – This lets patients watch hospital education and information channels without renting the TV. The channels containing programming for no charge are typically programmed into this level of service. This is the factory default setting for Service Level.

BASIC – This service typically allows additional channels beyond those offered in the FREE level.

PREMIUM – This is the highest service level with typically the most channels available for viewing.

Signal

Four different tuning types are available depending upon the healthcare facility's signal style. Selection of the correct signal type is required for the TV to recognize all possible channels and before any channel programming can begin.

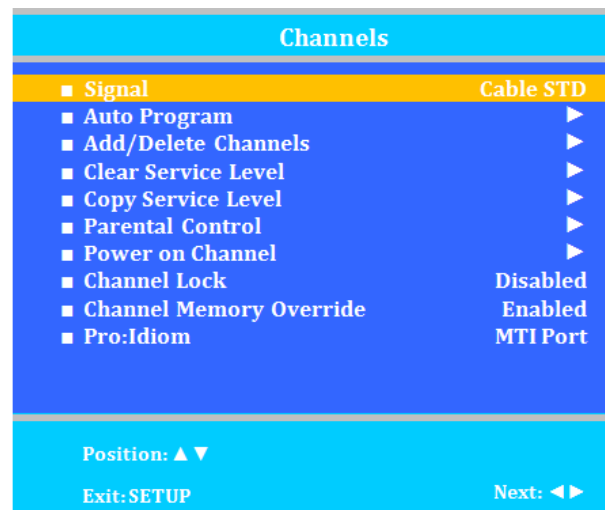
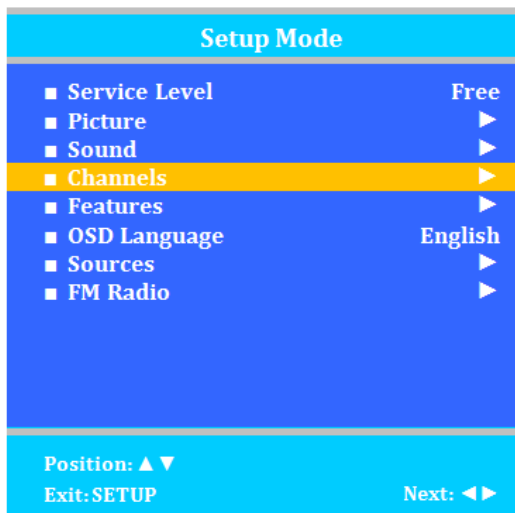

1. Press SETUP on the remote control.
2. Press CH▲ or CH▼ to highlight Channels.
3. Press VOL▶ to enter the Channels menu.
4. Press CH▲ or CH▼ to highlight Signal.
5. Press VOL◀ or VOL▶ to select Air, Cable STD, Cable IRC, or Cable HRC.
NOTE: Most hospitals use the Cable STD signal style.
6. Now perform Auto Program or Add/Delete Channels to adjust the channels.

 PDi <small>Communication Systems, Inc.</small> <i>Better Solutions Are Within Reach™</i>	MODEL NUMBER: PDI-P26/P32/P40LCDE	Document Number: PD196-190R2
	Quick Start Guide	Page 7 of 10

Auto Program

The TV automatically scans each available channel for activity. Channels that display activity are memorized into the selected Service Level.

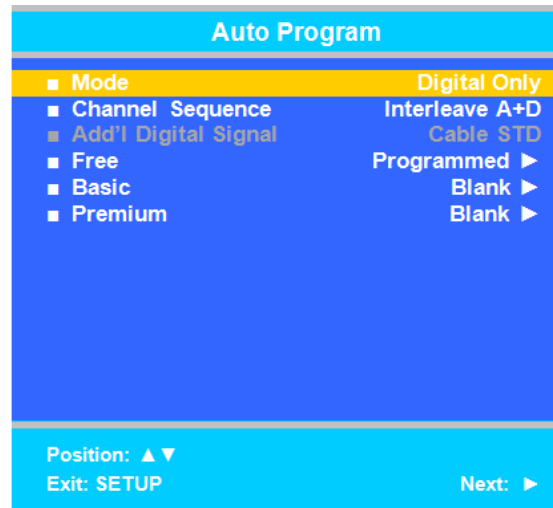
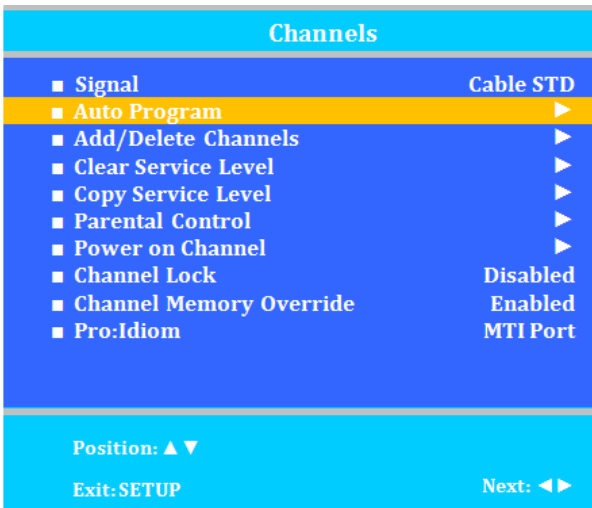

- After setting Signal, press CH▲ or CH▼ to highlight Auto Program.
- Press VOL▶ to select it.
- On Mode, press VOL◀ or VOL▶ to select the scope of channel scanning.
 - Analog Only: TV searches for analog channels only.
 - Digital Only: TV searches for digital channels only.
 - Analog and Digital: TV searches for both analog and digital channels.
- Press CH▲ or CH▼ to highlight Channel Sequence.
- Press VOL◀ or VOL▶ to select the channel sequence in which the channels are displayed.
 - Interleave A+D: Channels are displayed in the order of channel number.
 - All A then D: All digital channels are displayed after all analog channels.
- If you want to allow the TV to program additional digital channels, press CH▲ or CH▼ to highlight Add. Digital Signal. Press VOL◀ or VOL▶ to select Air.

NOTE: This feature is only available if Mode is set to Digital Only or Analog and Digital.
- Press CH▲ or CH▼ to highlight the Service Level (Free, Basic, or Premium) you wish to program. The menu displays the current programming status of each level as either Programmed or Blank.

NOTE: A programmed service level can also be reprogrammed if desired.
- Press VOL▶ to start auto programming.
- A confirmation menu will appear before proceeding. Press CH▲ to start auto programming. Press CH▼ to cancel the operation. The TV now will search all available channels. Auto programming requires several minutes to complete.

NOTE: Digital channel auto programming may take longer than 10 minutes to complete.
- Press SETUP to return to the previous menu. To exit, press SETUP until the programming menus disappear.

Internal Speaker Enabled

The speakers inside the TV's cabinet normally are enabled. Sound is also routed externally to an attached pillow speaker.

1. Enter the Sound menu
2. Press CH▲ or CH▼ to highlight the component you want to change
3. Press VOL◀ or VOL▶ to select Enabled or Disabled.
4. Press SETUP to return to the previous menu.



Minimum Volume

This sets the minimum volume level the TV can reach. For pillow speakers with an adjustment thumbwheel volume control, ALWAYS set a minimum volume level for the TV. A minimum volume setting is usually not required for pillow speakers with dedicated Volume Up and Down buttons.

NOTE: Setting this level to any value other than 0 guarantees that some level of sound will always be heard when the TV is operating.

1. In the Sound menu, press CH▲ or CH▼ to highlight Minimum Volume.
2. Press VOL◀ or VOL▶ to select the preferred minimum volume.
3. Press the SETUP button to return to the preceding menu.

Power on Volume

This sets the initial volume the TV starts at upon powering on. Once the TV is on, the volume can be set to any allowable level.

In Sound menu, press CH▲ or CH▼ to highlight Power on Volume.

1. Press VOL◀ or VOL▶ to select the preferred volume when the TV turns on.

NOTE: Setting the level to LAST causes the TV to remember the last volume level used by the TV prior to turning off.

2. Press the SETUP button to return to the preceding menu.

Cloning

Cloning allows quick programming of a TV using a USB Flash Drive. First a specimen TV is hand-programmed using a programming remote control (PD108-420) with channels, sound, and other settings. While the TV is On a USB Flash Disk is inserted into that TV's Clone port, the specimen TV's setup written to the Flash Disk, and then the Flash Disk is removed to program other televisions. One Flash Disk can be used to program an entire hospital of televisions.

Save Setting to USB Disk

1. Turn the TV On.
2. Insert a blank USB thumb Drive (user provided) into the USB Clone Port located adjacent the Cable TV Jack.
3. When the Cloning Main Menu appears, Press CH▲ or CH▼ to highlight Save Setting to USB Disk.
4. Press VOL▶ to enter the save settings to USB menu.

	MODEL NUMBER: PDI-P26/P32/P40LCDE	Document Number: PD196-190R2
	Quick Start Guide	Page 9 of 10

5. If you want to rename the file, press the CH▲ or CH▼ to highlight the file name, otherwise go to step 6.
 - a. Press ◀ or ▶ to highlight each character
 - b. Press ▲ or ▼ to change each character.
 - c. Repeat this process until you have the desired file name. Up to 8 characters may be used.
 - d. When done, press ◀ until the characters are no longer highlighted.
6. Press CH▲ or CH▼ to highlight Save.
7. Press VOL▶ to initiate.
8. Wait for the Cloning Main Menu to say “setting saved to USB”, then press ◀ to go back to main menu.
9. Remove the USB Disk from the TV.

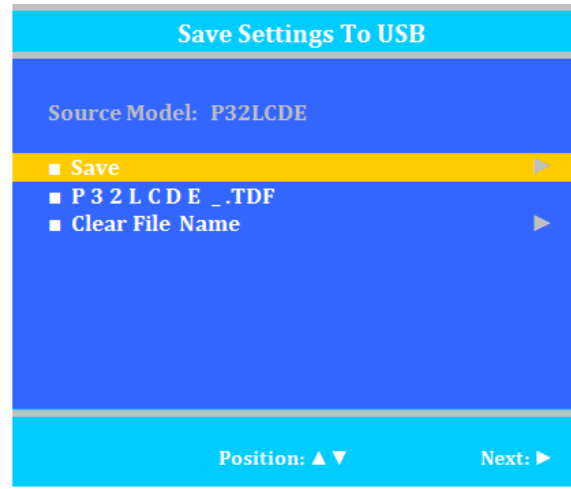
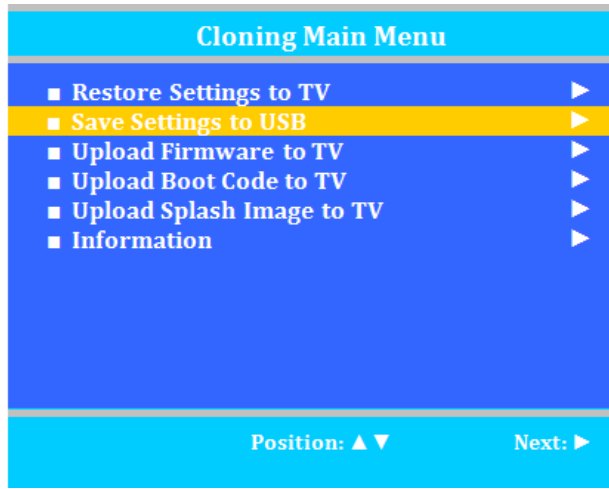

Restore Setting to TV

1. Turn the TV On.
2. Insert a Flash Drive (user provided) into the USB Clone Port located adjacent the Cable TV Jack.
3. When the Cloning Main Menu appears, press CH▲ or CH▼ to highlight Restore Setting to TV.
4. Press VOL▶ to initiate.
5. When the Restore Settings to TV menu appears, press CH▲ or CH▼ to highlight the appropriate model.
6. Press VOL▶ to initiate.
7. Wait for the Cloning Main Menu to reappear. You will get a confirmation screen. Press ▲ to continue or ◀ to go back.
8. The TV will restart after settings are restored.
9. Remove the USB Disk from the TV.
10. Verify correct setup of the TV.

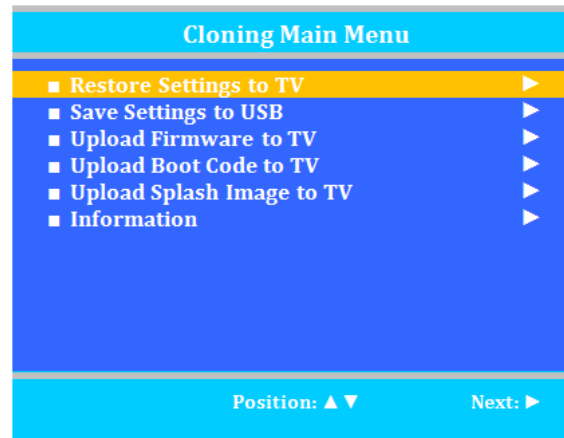

*To exit cloning menu, you must remove the thumb drive.

You are cautioned that changes or modifications not expressly approved by the party responsible for compliance could void the use's authority to operate the equipment.

	MODEL NUMBER: PDI-P26/P32/P40LCDE	Document Number: PD196-190R2
	Quick Start Guide	Page 10 of 10

Wireless Control

The PDI-P26/P32/P40LCDE model televisions include wireless connectivity for use with the optional PDI-TR100 Table Radio.

Both wireless audio and control of the TV are possible using the Table Radio.

Please refer to the Table Radio manual for setup instructions.

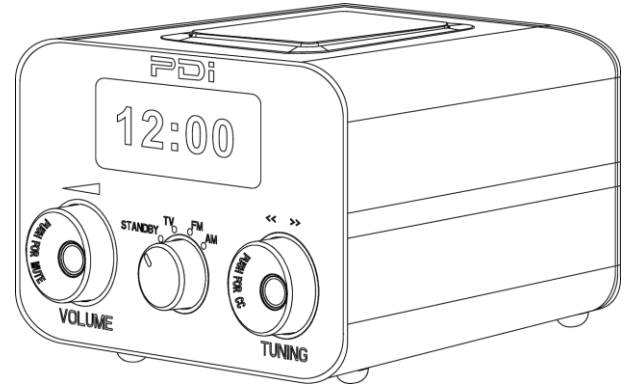

Additional Assistance

PDi Communication Systems, Inc.
40 Greenwood Lane
Springboro, Ohio 45066 USA

WEB: <http://www.pdiarm.com>

PH: 800-628-9870