







Persona[®] P14W
Arm-Mounted, Healthcare-grade
LED Backlit, LCD HDTV
Model: PDI-P14W

Document Number: PD196-214R5

	This symbol indicates that dangerous voltage constituting a risk of electric shock is present within this unit.
	This symbol indicates that there are important operating and maintenance instructions in the literature accompanying this unit.

	CAUTION RISK OF ELECTRIC SHOCK, DO NOT OPEN!	
CAUTION: TO REDUCE THE RISK OF ELECTRIC SHOCK, DO NOT REMOVE COVER. NO USER SERVICEABLE PARTS INSIDE. REFER SERVICING TO QUALIFIED SERVICE PERSONNEL		

 **Overhead Falling Hazard**
 TV can pose a striking hazard when mounted at an elevated position. Use only PDi mounting brackets, support arms, and appropriate hardware to assure TV will not fall from the mounted position. Failure to do so may cause injury or death.

 **Rain and Moisture**
 WARNING: To avoid the hazards of fire or electrical shock, DO NOT expose this television to rain or moisture.

 **Oxygen Environment**
 WARNING: Do not use in any oxygen tent or oxygen chamber. Such use may cause a fire hazard.

 **Wet Location**
 Do not use this television near water. Television shall not be exposed to dripping or splashing and no objects filled with liquids, such as vases, shall be placed on the television.

Note to Cable TV Installer

This reminder is provided to call the cable TV systems installer's attention to Article 820-40 of the National Electrical Code. The code provides guidelines for proper grounding and, in particular, specifies that the cable ground shall be connected to the grounding system of the building, as close to the point of the cable entry as practical. Canadian installations shall be properly grounded in accordance with the Canadian Electrical Code, Part 1.

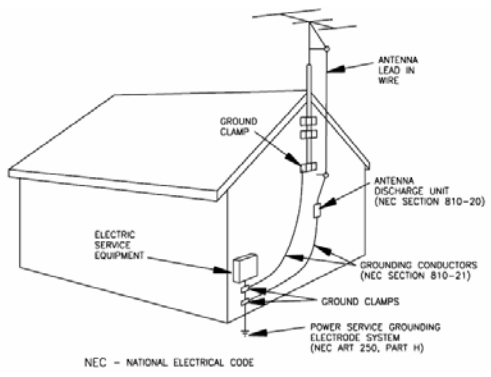

FCC

This equipment has been tested and found to comply with the limits for a Class A digital device, pursuant to part 15 of the FCC Rules. These limits are designed to provide reasonable protection against harmful interference when the equipment is operated in a commercial environment. This equipment generates, uses, and can radiate radio frequency energy and, if not installed and used in accordance with the instruction manual, may cause harmful interference to radio communications. Operation of this equipment in a residential area is likely to cause harmful interference in which case the user will be required to correct the interference at his own expense.

Maintenance and Servicing

The TV does not require periodic maintenance other than cleaning. Never remove the back cover of the TV; this can expose you to high voltage and other hazards. If the TV does not operate properly, unplug it and call an authorized service center or PDi.

Cleaning and Disinfection

Clean the exterior of this television by removing dust with a lint-free cloth. CAUTION: To avoid damage to the surface of the television, do not use abrasive or chemical cleaning agents. Spot test a new disinfectant by test cleaning a non-obvious small spot on the TV's back cabinet, keypad, and LCD panel. Allow the disinfectant to soak per its instructions and then wipe clean. Do not use the disinfectant if the TV's surfaces show any sign of discoloration or softening.

Product Modification

Do not attempt to modify this product in any way without written authorization. Unauthorized modification could void the user's authority to operate this product.

Trademarks

Manufactured under license from Dolby Laboratories, Dolby and the double-D symbol are trademarks of Dolby Laboratories. All other brand names and product names used in this manual are trademarks, registered trademarks, or trade names of their respective holder. "PDi" is a registered trademark of PDi Communication Systems, Inc. All rights reserved.

 Your Source for Healthcare and Wellness Infotainment™	MODEL NUMBER: Persona® P14W LCD HDTV	Document Number: PD196-214R5
	Quick Start Guide	Page 3 of 8

IMPORTANT SAFETY INSTRUCTIONS

THIS INSTALLATION SHOULD BE MADE BY A QUALIFIED SERVICE PERSON AND SHOULD CONFORM TO ALL LOCAL CODES. READ AND FOLLOW THE SAFETY INSTRUCTIONS BEFORE ATTEMPTING THIS INSTALLATION.

1. Read Instructions – All the safety and operating instructions should be read before the product is operated.
2. Keep these Instructions – The safety and operating instructions should be retained for future reference.
3. Heed Warnings – All warnings on the product and in the operating instructions should be adhered to.
4. Follow All Instructions – All warnings on the product and in the operating instructions should be followed.
5. Water and Moisture – Do not expose this product to rain or moisture. Do not use this product near water – for example, near a bath tub, wash bowl, kitchen sink, or laundry tub; in a wet basement; or near a swimming pool; and the like.
6. Cleaning – Unplug this product from the wall outlet before cleaning. Do not use liquid cleaners or aerosol cleaners. Use a damp cloth for cleaning.
7. Do not block any ventilation openings. Install in accordance with the manufacturer's instructions. The openings should never be blocked by placing the product on a bed, sofa, rug, or other similar surface.
8. Heat – The product should be situated away from heat sources such as radiators, heat registers, stoves, or other products (including amplifiers) that produce heat.
9. Grounding or Polarization – DO NOT defeat the safety purpose of the polarized or grounding-type plug. This product is equipped with a three-wire grounding-type plug, a plug having a third (grounding) pin. This plug will only fit into a grounding-type power outlet. This is a safety feature. If you are unable to insert the plug into the outlet, contact your electrician to replace your obsolete outlet.
10. Power-Cord Protection – Power-supply cords should be routed so that they are not likely to be walked on or pinched by items placed upon or against them, paying particular attention to cords at plugs, convenience receptacles, and the point where they exit from the product.
11. Attachments – Only use attachments/accessories specified by the manufacturer.
12. Use only with the cart, stand, tripod, bracket, or table specified by the manufacturer, or sold with the apparatus. When a cart is used, use caution when moving the cart/apparatus combination to avoid injury from tip-over. 
13. Unplug this apparatus during lightning storms or when unused for long periods of time.
14. Servicing – Do not attempt to service this product yourself as opening or removing covers may expose you to dangerous voltage or other hazards. Refer all servicing to qualified service personnel.
15. Oxygen Environment – Do not use in an oxygen tent or oxygen chamber. Such use may cause a fire hazard.
16. Power Sources – This product should be operated only from the type of power source indicated on the marking label. If you are not sure of the type of power supply to your facility, consult your product dealer or local power company.

CONSIGNES DE SÉCURITÉ IMPORTANTES

CETTE INSTALLATION DOIT ÊTRE EFFECTUÉE PAR UN TECHNICIEN QUALIFIÉ ET DOIT ÊTRE CONFORME À TOUS LES CODES LOCAUX. LIRE ET SUIVRE LES CONSIGNES DE SÉCURITÉ AVANT DE PROCÉDER À L'INSTALLATION.

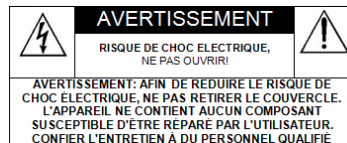
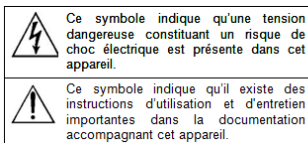

1. Lire ces instructions.
2. Conserver ces instructions.
3. Respecter tous les avertissements.
4. Suivre toutes les instructions.
5. Ne pas utiliser cet appareil près de l'eau - par exemple près d'une baignoire, d'un lavabo, dans un sous-sol humide, ou près d'une piscine ou similaire.
6. Nettoyer avec un chiffon sec. Ne pas utiliser de nettoyeurs liquides ou en aérosol.
7. Ne pas obstruer les ouvertures de ventilation. Installer conformément aux instructions du fabricant. Les ouvertures ne doivent jamais être obstruées en plaçant le produit sur un lit, un canapé, un tapis ou toute autre surface similaire.
8. NE PAS installer près de sources de chaleur telles que radiateurs, registres de chaleur, poêles ou tout autre appareil (y compris les amplificateurs) qui produit de la chaleur.
9. NE PAS neutraliser le dispositif de sécurité de la fiche polarisée ou de terre. Ce produit est équipé d'une prise de terre à trois fils, une fiche ayant une troisième broche (mise à la terre). Cette fiche ne peut s'insérer que dans une prise de courant avec mise à la terre. Il s'agit d'une caractéristique de sécurité. Si vous êtes incapable d'insérer la fiche dans la prise, contacter votre électricien pour remplacer votre prise obsolète.
10. Protéger le cordon d'alimentation pour qu'il ne soit pas piétiné ni pincé, en particulier au niveau des fiches, des prises de courant et au point de sortie de l'appareil.
11. Accessoires - Utiliser uniquement les attaches/accessoires recommandés par le fabricant.
12. Utiliser uniquement avec un chariot, stand, trépied, support ou table recommandé par le fabricant ou vendu avec l'appareil. Lorsqu'un chariot est utilisé, faire attention lors du déplacement de l'ensemble chariot/appareil afin d'éviter des blessures en cas de basculement.
13. Débrancher cet appareil en cas d'orages ou lorsqu'il reste inutilisé pendant de longues périodes.
14. Confier toute réparation à un personnel de service qualifié. Des réparations sont nécessaires si l'appareil est endommagé d'une façon quelconque, par exemple : cordon ou prise d'alimentation endommagé, liquide renversé ou des objets sont tombés dans l'appareil, l'appareil a été exposé à la pluie ou à l'humidité, ne fonctionne pas normalement ou s'il est tombé.
15. Sources d'alimentation - Ce produit doit être utilisé uniquement à partir du type de source d'alimentation indiqué sur l'étiquette. Si vous n'êtes pas sûr sur le type d'alimentation de votre domicile, consultez le détaillant de votre produit ou la compagnie d'électricité locale. Pour les produits proposés de fonctionner par piles, ou autres sources d'alimentation, reportez-vous aux consignes d'utilisation.
16. Environnement d'oxygène - Ne pas utiliser sous une tente à oxygène ou chambre à oxygène. Une telle utilisation peut causer un risque d'incendie.

ARM MOUNTING

This television is designed to attach to a wall mounted suspension arm adjusted to support a television weighing seven pounds.

The single coaxial cable on top of the TV is used to supply low voltage AC or DC power (28VAC or 24VDC) and the RF signal to the television.

Note: Contact PDi for additional information on arm compatibility and cable requirements.

DANGER: ARM RECOIL HAZARD

The safety brake pin must remain in the SAFETY BRAKE PIN HOLE whenever the television is removed from the arm or when the arm is removed from the wall bracket to prevent the arm from springing open.



1. Slide the TV assembly onto the nose of the arm as shown in Fig. 1.
2. Secure PDISHCS252075 bolt with a 5/32" allen wrench and make coax cable connections as shown in Fig. 2

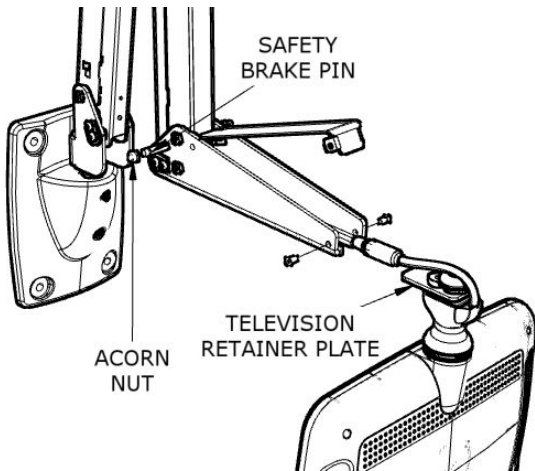

Fig. 1

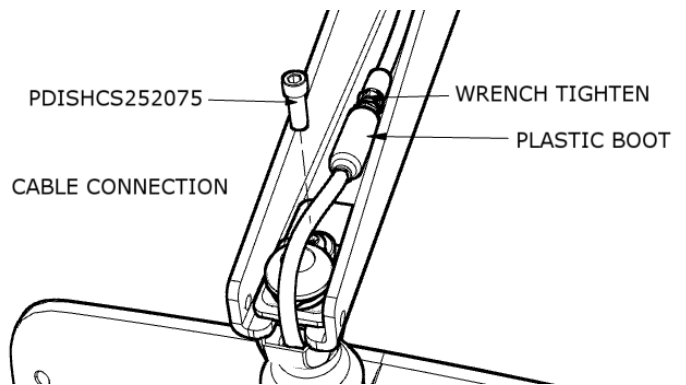
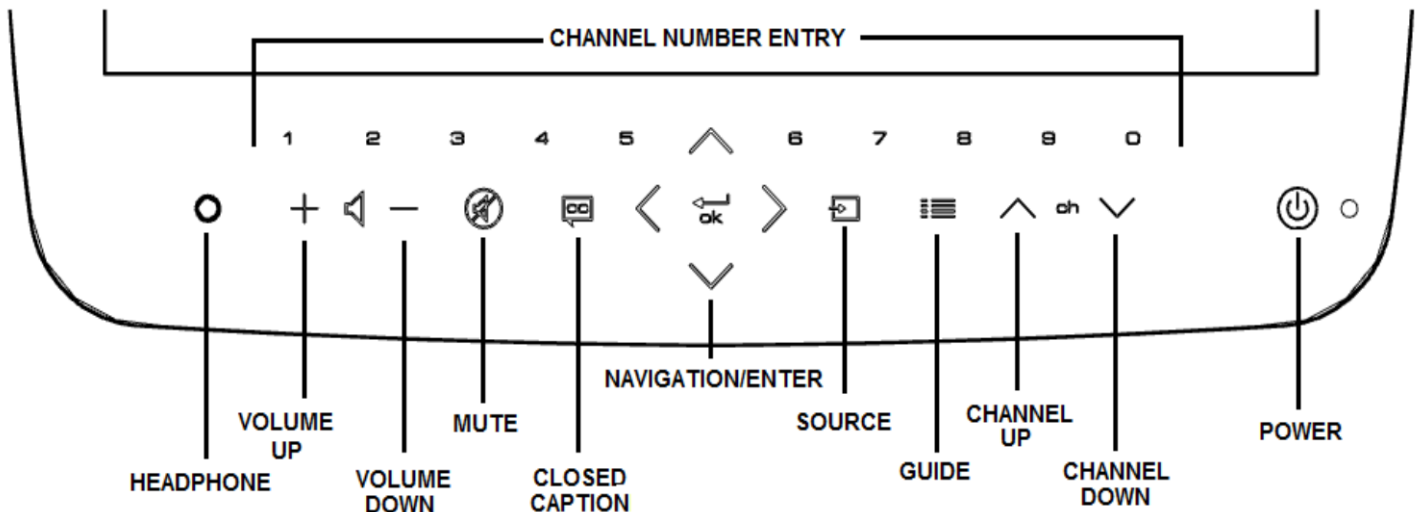

Fig. 2

DIRECT ENTRY KEYPAD

You can use the glass keypad to choose power, source, channel, volume, and guide. The navigational arrows used in EPG mode will guide you to your choices and the "ok" arrow is used as an "Enter" command.



PROGRAMMING

Note: A programming remote control is required to perform all setup operations for the television. The programming remote (Part Number PD108-420) is NOT packaged with the TV and must be ordered separately. The following instructions assume you have a programming remote, have correctly mounted the TV, and connected a coax cable that provides both power and RF signal.

Channel Setup

This TV offers a Disable and three different programmable service levels: Free, Basic, and Premium. Only one Service Level is usable at a time.

Four different tuning types are available depending upon the healthcare facilities' signal style. Selection of the correct signal type is required for the TV to recognize all possible channels and before any channel programming can begin.

1. Press the SETUP button to display the SETUP MODE menu.
2. Press the VOL▶ to select desired service level. (Free, Basic, Premium)



3. Press the CH▲ /CH▼ to highlight CHANNEL menu
4. Press the VOL▶ to select Air, Cable STD, Cable IRC or Cable HRC.

NOTE: Most hospitals use the Cable STD signal style.



Auto Program

The TV automatically scans each available channel for activity. Channels that display activity are memorized into the selected Service Level.

- From the Channels menu, select Auto Program
- In the Auto Program menu, press the VOL▶ button to select Mode.
- Press VOL▶ to set the scope of channel scanning.
 Analog Only: TV searches for analog channels only.
 Digital Only: TV searches for digital channels only.
 Analog and Digital: TV searches for both analog and digital channels.
- Press the CH▼ button to select the Channel Sequence menu item.
- Press ◀VOL▶ to set the Channel Sequence in which the channels are displayed after searching.
 Interleave A+D: In the order of channel number regardless of the system.
 All A then D: Digital channels are displayed after all analog channels.
- Press the CH▲ CH ▼ button to select the Service Level you wish to program. The menu displays the current programming status of each level as either Programmed or Blank. Press the VOL▶ to choose the service level.
NOTE: A Programmed service level can also be reprogrammed if desired.
- A confirmation menu will appear before proceeding. Press Yes▲ to select YES and start auto programming. The TV will now search all available channels with an on-screen progress percentage displayed. Once complete, press the SETUP button to return to normal TV viewing.
NOTE: Any tuning mode that includes Digital channels will require several additional minutes to complete the auto programming.

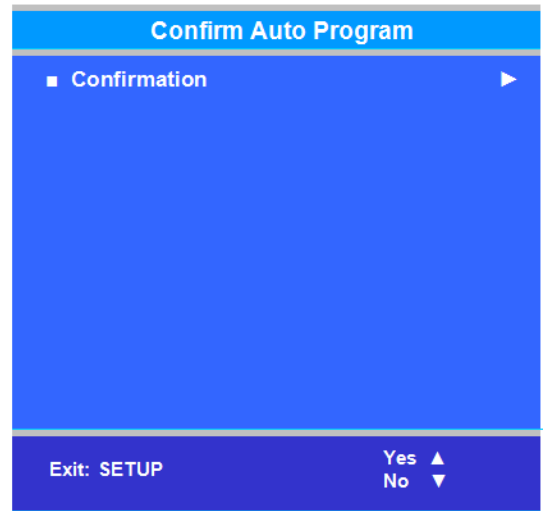

SOUND PROGRAMMING

The TV's internal speakers can be disabled requiring the use of a headphone for private listening. This option is commonly used in dialysis clinics and multiple occupancy rooms.

Internal Speaker Enable

The speakers inside the TV's cabinet can be Enabled (turned ON) or Disabled (turned OFF).

1. In the Sound menu, press CH▲/CH▼ button to select the Internal Speaker Enable menu item.
2. Press VOL◀/VOL▶ to activate the menu item.
3. Press the CH▲/CH▼ button to select the desired Service Level(s) or Sources.
4. Press VOL◀/VOL▶ to alternately select Disabled or Enabled to turn OFF or ON the TV's internal speakers.
5. Press the SETUP button to return to the preceding menu.

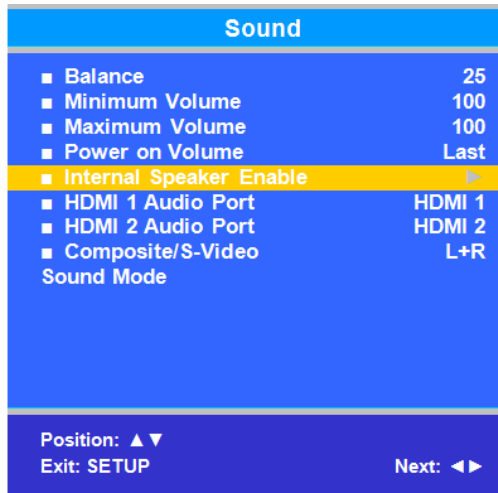

CLONING

Cloning allows quick programming of a TV from a USB memory stick (Thumb Drive). Clone operation involves first downloading setup information from a programmed host TV to a Thumb Drive and then uploading the setup information to another TV. Cloning can also be used to re-program a programmed TV.

Save Settings to USB

1. Turn on the TV
2. Insert a blank USB thumb drive into the cloning port. A Cloning Main Menu will appear on the TV screen.
3. Press CH▲ or CH▼ to highlight Save Settings to USB.
4. Press VOL▶ to display the Save Settings to USB menu.

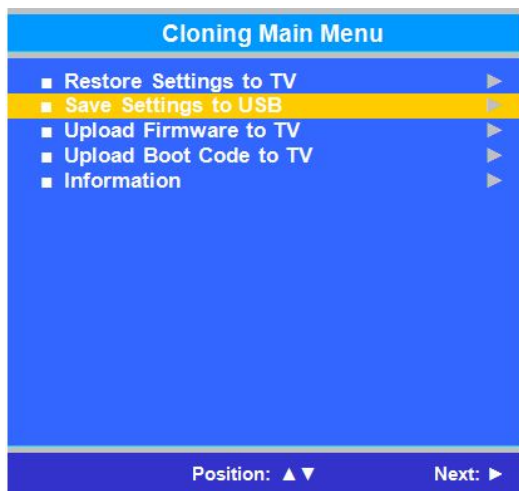

Restore Settings to TV

1. Press CH▲ or CH▼ to highlight Restore Settings to TV.
2. Press VOL▶ to display a list of previously stored TV setups on the USB thumb drive.
3. Press CH▲ or CH▼ to highlight desired setup file.
4. Press VOL▶ to select it.
5. A confirmation screen will appear Press CH▲ to restore the selected setup file or press VOL◀ to return to the previous menu without restoring. A progress screen will appear as the settings are restored.
6. The TV will return to the Cloning Main Menu after restoring is complete.
7. Remove the USB thumb drive.

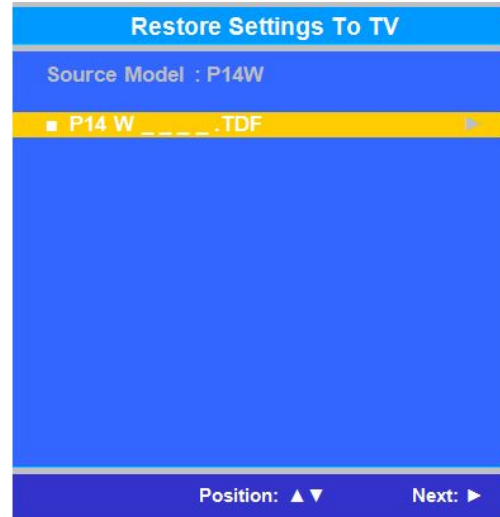
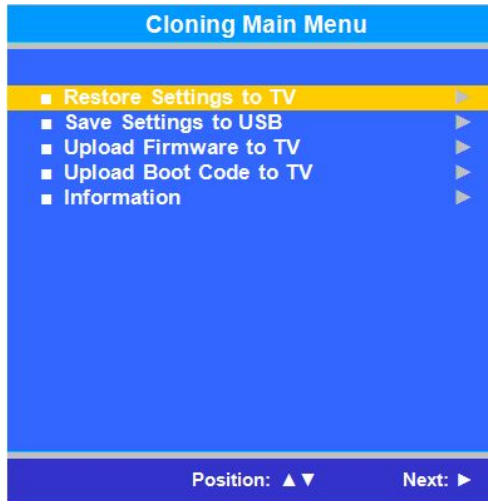

Additional Information

Additional information is available in the user manual. You can access this information online at www.pdiarm.com, document number PD196-220.

Limited Warranty

PDi Communication Systems Inc., ("PDi") warrants, to the original purchaser only, that the PDI-P14W will be free from defects in materials and workmanship, under normal use, for 2 years from the date of original purchase. This warranty does not cover any other equipment that may have been included with PDI's shipment of this product.

After receipt of written notice of a defect or malfunction occurring during the warranty period, PDi will repair or replace goods returned to its Springboro, Ohio location, at its discretion, free of charge to the original purchaser, the whole or any component part of any product manufactured by PDi and found by PDi to be defective.

As a condition to obtaining warranty service, written notification must be received by PDi within at least ten (10) days after defect is first observed. Repair of said product requires it to be shipped to the PDi factory in Springboro, Ohio. All shipments shall be F.O.B. Springboro, Ohio, and all shipping and freight charges to PDi's factory shall be paid by the customer.

This warranty shall not apply to any PDi products subjected to improper use, negligence or accident; nor to tampering, alterations, or repairs by others, without PDi's specific prior written authorization. For information regarding authorized servicing and all other information pertaining to this warranty, please contact PDi Communication Systems, Inc. at 40 Greenwood Lane, Springboro, Ohio 45066 or phone 800-628-9870.

This warranty gives specific legal rights and you may also have other rights which vary from state to state.

PDi's liability under this warranty is limited to repair or replacement of defective products and parts as provided above. PDi shall not be liable for incidental or consequential damages.*

The warranty contained herein is in lieu of all other expressed or implied warranties, including any implied warranty of merchantability or fitness for any particular purpose. PDi neither assumes nor authorizes any person to assume, on its behalf, any other obligation or liability.

*Some states DO NOT allow the exclusion or limitation of incidental or consequential damages or a disclaimer of warranties implied by law, so the above limitation or exclusion may not apply.

The information and technical data in this manual is believed accurate, but is not warranted and is subject to change without notice or obligation.