





P14T2 shown with VerbalCare software system

PDI-P14T2
Arm-Mounted, Healthcare-grade
LCD HDTV with Android

Document Number: PD196-250R5

 Your Source for Healthcare and Wellness Infotainment™	MODEL: PDI-P14T2	Document Number: PD196-250R5
	LCD HDTV with Android Quick Start Guide	Page 2 of 16

 This symbol indicates that dangerous voltage constituting a risk of electric shock is present within this unit.

 This symbol indicates that there are important operating and maintenance instructions in the literature accompanying this unit.

 **CAUTION**
RISK OF ELECTRIC SHOCK, DO NOT OPEN!

CAUTION: TO REDUCE THE RISK OF ELECTRIC SHOCK, DO NOT REMOVE COVER. NO USER SERVICEABLE PARTS INSIDE. REFER SERVICING TO QUALIFIED SERVICE PERSONNEL



Overhead Falling Hazard

WARNING: To prevent injury, this apparatus must be securely attached to the floor/wall in accordance with the installation instructions.

TV can pose a striking hazard when mounted at an elevated position. Use only PDi mounting brackets, support arms, and appropriate hardware to assure TV will not fall from the mounted position



Rain and Moisture

WARNING: To avoid the hazards of fire or electrical shock, DO NOT expose this television to rain or moisture.



Oxygen Environment

WARNING: Do not use in any oxygen tent or oxygen chamber. Such use may cause a fire hazard.

Note to Cable TV Installer

This reminder is provided to call the cable TV systems installer's attention to Article 820-40 of the National Electrical Code. The code provides guidelines for proper grounding and, in particular, specifies that the

cable ground shall be connected to the grounding system of the building, as close to the point of the cable entry as practical. Canadian installations shall be properly grounded in accordance with the Canadian Electrical Code, Part 1.

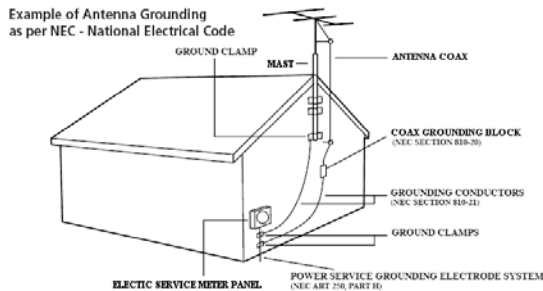

FCC

This equipment has been tested and found to comply with the limits for a Class A digital device, pursuant to part 15 of the FCC Rules. These limits are designed to provide reasonable protection against harmful interference when the equipment is operated in a commercial environment. This equipment generates, uses, and can radiate radio frequency energy and, if not installed and used in accordance with the instruction manual, may cause harmful interference to radio communications. Operation of this equipment in a residential area is likely to cause harmful interference in which case the user will be required to correct the interference at his own expense.

Maintenance and Servicing

The TV does not require periodic maintenance other than cleaning. Never remove the back cover of the TV; this can expose you to high voltage and other hazards. If the TV does not operate properly, unplug it and call an authorized service center or PDi.

Cleaning and Disinfection

Clean the exterior of this television by removing dust with a lint-free cloth. **CAUTION:** To avoid damage to the surface of the television, do not use abrasive or chemical cleaning agents. Spot test a new disinfectant by test cleaning a non-obvious small spot on the TV's back cabinet, keypad, and LCD panel. Allow the disinfectant to soak per its instructions and then wipe clean. Do not use the disinfectant if the TV's surfaces show any sign of discoloration or softening.

Product Modification

Do not attempt to modify this product in any way without written authorization. Unauthorized modification could void the user's authority to operate this product.

Copyright, Trademarks

© 2014 PDi Communication Systems, Inc. All rights reserved. PDi-TAB® is a registered trademark of PDi Communication Systems, Inc. Product logos, brands and other trademarks displayed within PDi's products are the property of their respective trademark holders, who are not affiliated with, endorsing, or sponsoring PDi Communication Systems, Inc. or our products.

Underwriters Laboratories

The model PDI-P14T2 Hospital Grade LCD HDTV is a specialized TV and should be installed to National Electrical Code specifications.

This device is safety tested and listed by the Underwriters Laboratories as a product suitable for use in health-care facilities in both the United States and Canada.



Disclaimer

The author and publisher have used their best efforts in preparing this manual. PDi Communication Systems, Inc. makes no representation or warranties with respect to the accuracy or completeness of the contents of this manual and specifically disclaims any implied warranties or merchantability or fitness for any particular purpose and shall in no event be liable for any loss of profit or any other damages. The information contained herein is believed accurate, but is not warranted, and is subject to change without notice or obligation.



 PDi Communication Systems, Inc. Your Source for Healthcare and Wellness Infotainment™	MODEL:	PDI-P14T2	Document Number: PD196-250R5
	LCD HDTV with Android Quick Start Guide		Page 3 of 16



IMPORTANT SAFETY INSTRUCTIONS

CAUTION: THIS INSTALLATION SHOULD BE MADE BY A QUALIFIED SERVICE PERSON AND SHOULD CONFORM TO ALL LOCAL CODES. READ AND FOLLOW THE SAFETY INSTRUCTIONS BEFORE ATTEMPTING THIS INSTALLATION.

1. Read Instructions – All the safety and operating instructions should be read before the product is operated.
2. Keep these Instructions – The safety and operating instructions should be retained for future reference.
3. Heed all Warnings – All warnings on the product and in the operating instructions should be adhered to.
4. Follow all Instructions – All warnings on the product and in the operating instructions should be followed.
5. Water and Moisture – Do not expose this product to rain or moisture. Do not use this product near water – for example, near a bath tub, wash bowl, kitchen sink, or laundry tub; in a wet basement; or near a swimming pool; and the like.
6. Cleaning – Unplug this product from the wall outlet before cleaning. Do not use liquid cleaners or aerosol cleaners. Clean only with a dry cloth.
7. Ventilation – Slots and openings in the cabinet are provided for ventilation to ensure reliable operation of the product and to protect it from overheating. These openings must not be blocked or covered. The openings should never be blocked by placing the product on a bed, sofa, rug, or other similar surface. This product should not be placed in a built-in installation such as a bookcase or rack unless proper ventilation is provided or the manufacturer's instructions have been adhered to.
8. Heat – The product should be situated away from heat sources such as radiators, heat registers, stoves, or other products (including amplifiers) that produce heat.
9. Power-Cord Protection – Protect the power cord from being walked on or pinched, particularly at plugs, convenience receptacles, and the point where they exit from the product.
10. Attachments – Only use attachments/accessories specified by the manufacturer.
11. Use only with cart, stand, tripod, bracket, or table specified by the manufacturer, or sold with the apparatus. When a cart is used, use caution when moving the cart/apparatus combination to avoid injury from tip-over.
12. Lightning – For added protection for this product during a lightning storm, or when it is left unattended and unused for long periods of time, unplug it from the wall outlet and disconnect the antenna or cable system. This will prevent damage to the product due to lightning and power-line surges.
13. Servicing – Refer all servicing to qualified service personnel. Servicing is required when the apparatus has been damaged in any way, such as power cord or plug is damaged, liquid has been spilled or objects have fallen into the apparatus, the apparatus has been exposed to rain or moisture, does not operate normally, or has been dropped.
14. Oxygen Environment – Do not use in an oxygen tent or oxygen chamber. Such use may cause a fire hazard.
15. To prevent injury, this apparatus must be securely attached to the wall in accordance with the installation instructions. TV's can pose a striking hazard when mounted at an elevated level.
16. Power Sources – This product should be operated only from the type of power source indicated on the marking label. If you are not sure of the type of power supply to your home, consult your product dealer or local power company. For products intended to operate from battery power, or other sources, refer to the operating instructions.



	Ce symbole indique qu'une tension dangereuse constituant un risque de choc électrique est présente dans cet appareil.
	Ce symbole indique qu'il existe des instructions d'utilisation et d'entretien importantes dans la documentation accompagnant cet appareil.

	AVERTISSEMENT	
RISQUE DE CHOC ELECTRIQUE, NE PAS OUVRIR!		
AVERTISSEMENT: AFIN DE REDUIRE LE RISQUE DE CHOC ELECTRIQUE, NE PAS RETIRER LE COUVERCLE. L'APPAREIL NE CONTIENT AUCUN COMPOSANT SUSCEPTIBLE D'ETRE REPARÉ PAR L'UTILISATEUR. CONFIER L'ENTRETIEN A DU PERSONNEL QUALIFIE.		

CONSIGNES DE SÉCURITÉ IMPORTANTES

CETTE INSTALLATION DOIT ÊTRE EFFECTUÉE PAR UN TECHNICIEN QUALIFIÉ ET DOIT ÊTRE CONFORME À TOUS LES CODES LOCAUX. LIRE ET SUIVRE LES CONSIGNES DE SÉCURITÉ AVANT DE PROCÉDER À L'INSTALLATION.

1. Lire ces instructions.
2. Conserver ces instructions.
3. Respecter tous les avertissements.
4. Suivre toutes les instructions.
5. Ne pas utiliser cet appareil près de l'eau - par exemple près d'une baignoire, d'un lavabo, dans un sous-sol humide, ou près d'une piscine ou similaire.
6. Nettoyer avec un chiffon sec. Ne pas utiliser de nettoyeurs liquides ou en aérosol.
7. Ne pas obstruer les ouvertures de ventilation. Installer conformément aux instructions du fabricant. Les ouvertures ne doivent jamais être obstruées en plaçant le produit sur un lit, un canapé, un tapis ou toute autre surface similaire.
8. NE PAS installer près de sources de chaleur telles que radiateurs, registres de chaleur, poêles ou tout autre appareil (y compris les amplificateurs) qui produit de la chaleur.
9. NE PAS neutraliser le dispositif de sécurité de la fiche polarisée ou de terre. Ce produit est équipé d'une prise de terre à trois fils, une fiche ayant une troisième broche (mise à la terre). Cette fiche ne peut s'insérer que dans une prise de courant avec mise à la terre. Il s'agit d'une caractéristique de sécurité. Si vous êtes incapable d'insérer la fiche dans la prise, contacter votre électricien pour remplacer votre prise obsolète.
10. Protéger le cordon d'alimentation pour qu'il ne soit pas piétiné ni pincé, en particulier au niveau des fiches, des prises de courant et au point de sortie de l'appareil.
11. Accessoires - Utiliser uniquement les attaches/accessoires recommandés par le fabricant.
12. Utiliser uniquement avec un chariot, stand, trépied, support ou table recommandé par le fabricant ou vendu avec l'appareil. Lorsqu'un chariot est utilisé, faire attention lors du déplacement de l'ensemble chariot/appareil afin d'éviter des blessures en cas de basculement.
13. Débrancher cet appareil en cas d'orages ou lorsqu'il reste inutilisé pendant de longues périodes.
14. Confier toute réparation à un personnel de service qualifié. Des réparations sont nécessaires si l'appareil est endommagé d'une façon quelconque, par exemple : cordon ou prise d'alimentation endommagé, liquide renversé ou des objets sont tombés dans l'appareil, l'appareil a été exposé à la pluie ou à l'humidité, ne fonctionne pas normalement ou s'il est tombé.
15. Sources d'alimentation - Ce produit doit être utilisé uniquement à partir du type de source d'alimentation indiqué sur l'étiquette. Si vous n'êtes pas sûr sur le type d'alimentation de votre domicile, consultez le détaillant de votre produit ou la compagnie d'électricité locale. Pour les produits proposés de fonctionner par piles, ou autres sources d'alimentation, reportez-vous aux consignes d'utilisation.
16. Environnement d'oxygène - Ne pas utiliser sous une tente à oxygène ou chambre à oxygène. Une telle utilisation peut causer un risque d'incendie.

 PDi Communication Systems, Inc. Your Source for Healthcare and Wellness Infotainment™	MODEL: PDI-P14T2	Document Number: PD196-250R5
	LCD HDTV with Android Quick Start Guide	Page 4 of 16

ARM MOUNTING

This television is designed to attach to a wall mounted suspension arm adjusted to support a television weighing seven pounds (PDAA507 Series).

The single coaxial cable on top of the TV is used to supply low voltage AC or DC power (28VAC or 24VDC) and the RF signal to the television.

Note: Contact PDi for additional information on arm compatibility and cable requirements.

DANGER: ARM RECOIL HAZARD

The safety brake pin must remain in the SAFETY BRAKE PIN HOLE whenever the television is removed from the arm or when the arm is removed from the wall bracket to prevent the arm from springing open.



1. Slide the TV assembly onto the nose of the arm as shown in Fig. 1.
2. Secure PDISHCS252075 bolt with a 5/32" allen wrench and make coax cable connections as shown in Fig. 2

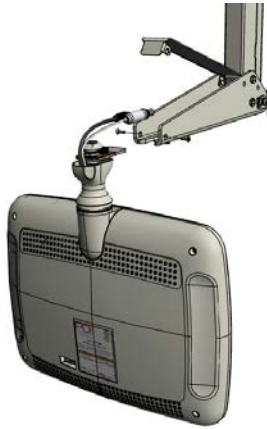

Fig.1

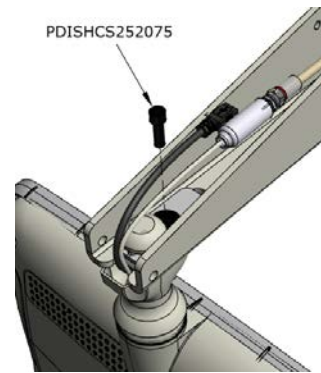

Fig.2

TELEVISION PROGRAMMING

Note: A programming remote control is required to perform all setup operations for the television. The programming remote (Part Number PD108-420) is NOT packaged with the TV and must be ordered separately. The following instructions assume you have a programming remote, have correctly mounted the TV, and connected a coax cable that provides both power and RF signal.

***Note:** The P14TV portion of this is not a touch screen. Android will respond when touching the TV screen.

TELEVISION KEYPAD

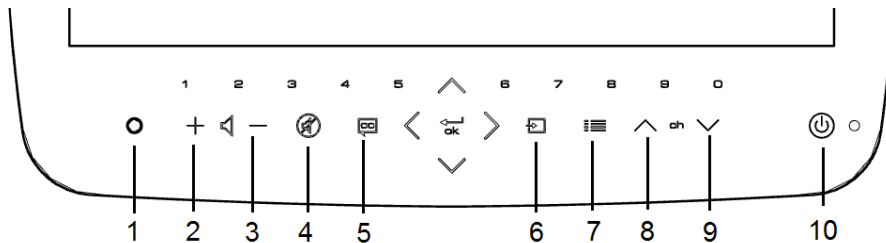

- | | |
|---------------------|------------------|
| 1. Headphone Plug | 6. Source |
| 2. Volume up | 7. Guide |
| 3. Volume down | 8. Channel Up |
| 4. Mute | 9. Channel Down |
| 5. Closed Captioned | 10. Power Button |

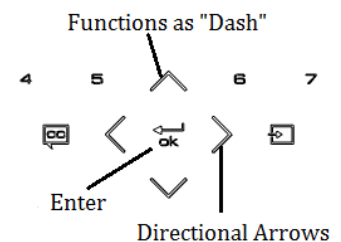

Channel Setup

This TV offers a Disable and three different programmable service levels: Free, Basic, and Premium. Only one Service Level is usable at a time.

Four different tuning types are available depending upon the healthcare facilities' signal style. Selection of the correct signal type is required for the TV to recognize all possible channels and before any channel programming can begin.

1. Press the SETUP button to display the SETUP MODE menu.
2. Press the VOL▶ to select desired service level. (Free, Basic, Premium)
3. Press the CH▲ /CH▼ to highlight CHANNEL menu
4. Press the VOL▶ to select Air, Cable STD, Cable IRC or Cable HRC.

NOTE: Most hospitals use the Cable STD signal style.



Auto Program

The TV automatically scans each available channel for activity. Channels that display activity are memorized into the selected Service Level.

1. From the Channels menu, select Auto Program
2. In the Auto Program menu, press the VOL▶ button to select Mode.
3. Press VOL▶ to set the scope of channel scanning.
 Analog Only: TV searches for analog channels only.
 Digital Only: TV searches for digital channels only.
 Analog and Digital: TV searches for both analog and digital channels.
4. Press the CH▼ button to select the Channel Sequence menu item.
5. Press ◀VOL▶ to set the Channel Sequence in which the channels are displayed after searching.
 Interleave A+D: In the order of channel number regardless of the system.
 All A then D: Digital channels are displayed after all analog channels.
6. Press the CH▲ CH ▼ button to select the Service Level you wish to program. The menu displays the current programming status of each level as either Programmed or Blank. Press the VOL▶ to choose the service level.
Note: A Programmed service level can also be reprogrammed if desired.
7. A confirmation menu will appear before proceeding. Press Yes▲ to select YES and start auto programming. The TV will now search all available channels with an on-screen progress percentage displayed. Once complete, press the SETUP button to return to normal TV viewing.

Note: Any tuning mode that includes Digital channels will require several minutes to complete the auto programming.



SOUND PROGRAMMING

The TV's internal speakers can be disabled requiring the use of a headphone for private listening. This option is commonly used in dialysis clinics and multiple occupancy rooms.

Internal Speaker Enable

The speakers inside the TV's cabinet can be Enabled (turned ON) or Disabled (turned OFF).

1. In the Sound menu, press CH▲/CH▼ button to select the Internal Speaker Enable menu item.
2. Press VOL◀/VOL▶ to activate the menu item.
3. Press the CH▲ /CH▼ button to select the desired Service Level(s) or Sources.
4. Press VOL◀/VOL▶ to alternately select Disabled or Enabled to turn OFF or ON the TV's internal speakers.
5. Press the SETUP button to return to the preceding menu.

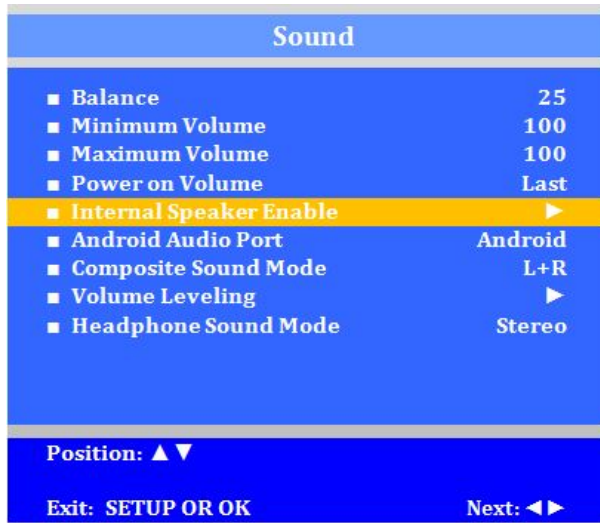

 PDi Communication Systems, Inc. Your Source for Healthcare and Wellness Infotainment™	MODEL: PDI-P14T2	Document Number: PD196-250R5
	LCD HDTV with Android Quick Start Guide	Page 7 of 16

CLONING

Cloning allows quick programming of a TV from a USB memory stick (Thumb Drive). Clone operation involves first downloading setup information from a programmed host TV to a Thumb Drive and then uploading the setup information to another TV. Cloning can also be used to re-program a programmed TV.

Note: Cloning for the TV portion will be from the USB port in the back of the TV.

Save Settings to USB

1. Turn on the TV
2. Insert a blank USB thumb drive into the cloning port. A Cloning Main Menu will appear on the TV screen.
3. Press CH▲ or CH▼ to highlight Save Settings to USB.
4. Press VOL▶ to display the Save Settings to USB menu.

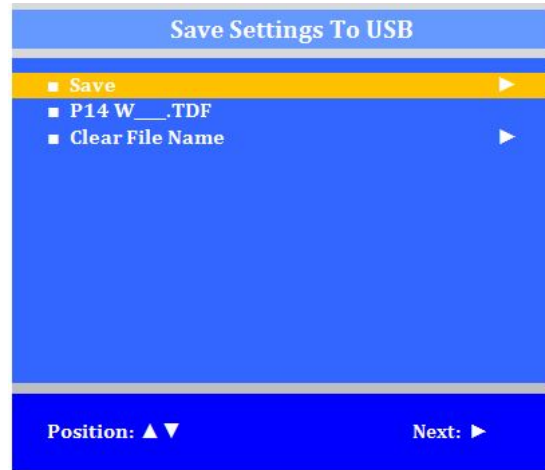
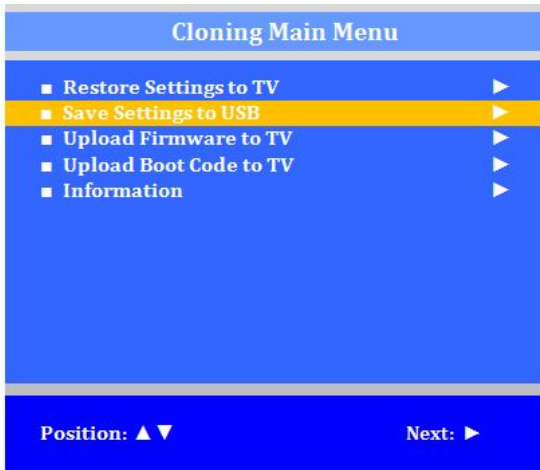

Restore Settings to TV

1. Press CH▲ or CH▼ to highlight Restore Settings to TV.
2. Press VOL▶ to display a list of previously stored TV setups on the USB thumb drive.
3. Press CH▲ or CH▼ to highlight desired setup file.
4. Press VOL▶ to select it.
5. A confirmation screen will appear Press CH▲ to restore the selected setup file or press VOL◀ to return to the previous menu without restoring. A progress screen will appear as the settings are restored.
6. The TV will return to the Cloning Main Menu after restoring is complete
7. Remove the USB thumb drive.

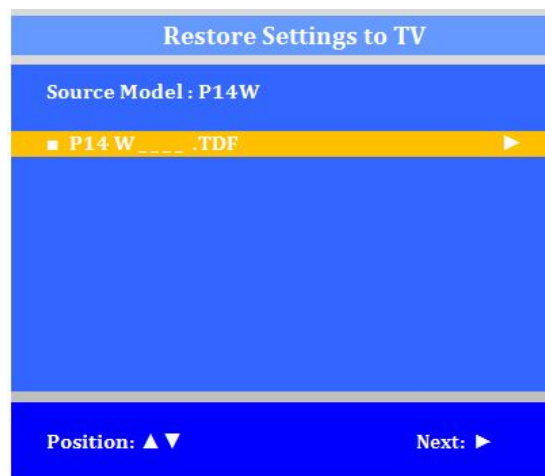

 PDi Communication Systems, Inc. Your Source for Healthcare and Wellness Infotainment™	MODEL: PDI-P14T2	Document Number: PD196-250R5
	LCD HDTV with Android Quick Start Guide	Page 8 of 16

ANDROID PROGRAMMING

With the remote, enter **SETUP MODE/Sources/Source Enable**, make sure TV is set at **Enabled/No APO** and the **Android-Module** is enabled.

*The first time you use the android portion of the P14T2 Television, you will enter the *WELCOME* screen.

1. On remote press *TV/AV* button or on the TV press *Source* icon until you reach *Android-Module*.
2. This will be a *New User Screen* where you will be asked to enter a pin number.
3. Entering the PIN will take you to the desktop.

Note: If your power On Source is set to Android – Module, a short touch of the power button puts the android to sleep (or wakes it up if it was sleeping).

A long touch of the power button reboots the android.

Signing On As a New User (Device Cleanup)

(*Administrative information like Wi-Fi and clone file configuration is retained)

In the initial patient setup, the patient needs to touch the *I am a new user* button.

Enter the new user name (you may use the default name *Patient*) and touch *Done*. Touch *Continue (new user)* and wait for the *WELCOME* Screen.

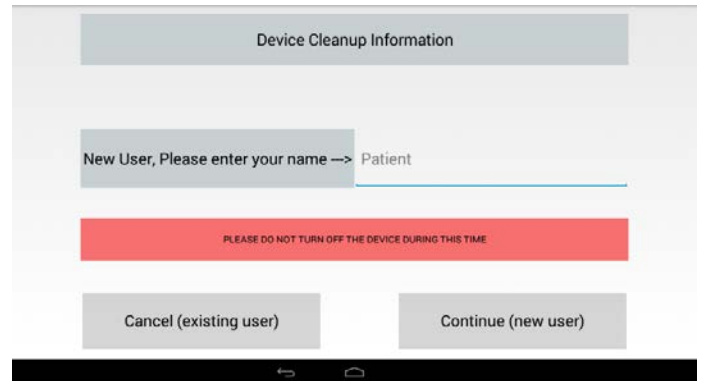

After touching *Continue* on the *WELCOME* screen you need to enter a security code. This code must be at least 6 digits.

Confirm your code and touch *Next* when done.

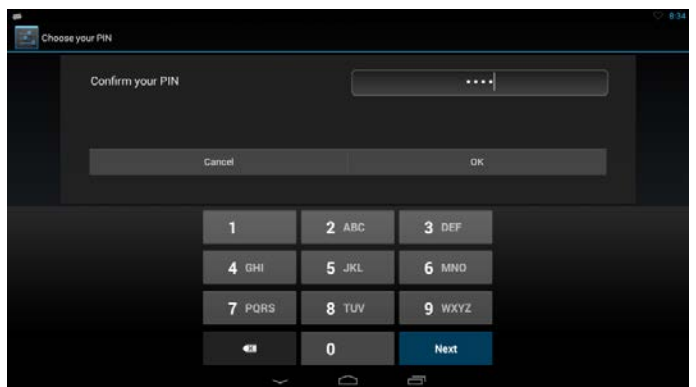
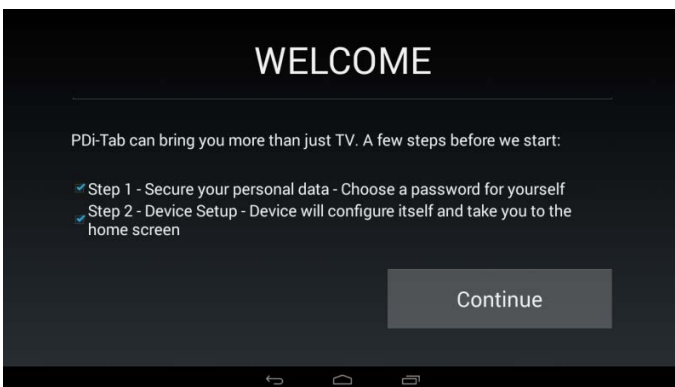

 PDi Communication Systems, Inc. Your Source for Healthcare and Wellness Infotainment™	MODEL: <p style="text-align: center;">PDI-P14T2</p>	Document Number: PD196-250R5
	LCD HDTV with Android Quick Start Guide	Page 9 of 16

SETTINGS – WIRELESS AND NETWORKS

After confirming your security code, you can enter the Settings screen where you can adjust network, sound, and account settings, among many others.

1. From the home screen, touch the *all apps* icon at the bottom of the screen.
2. In the *all apps* screen, select *Settings*.

Note: If you are connected using the Ethernet cable, you will not be taken to the next screen. Instead, you will be taken to the default home screen.

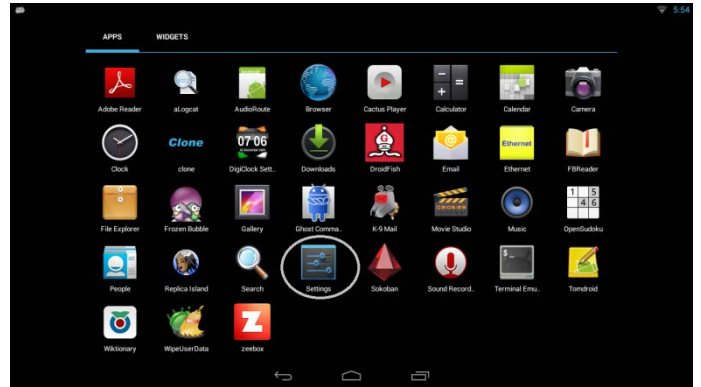



Connect To Wi-Fi Networks

1. Slide the Wi-Fi switch to the *On* position. (If not already set to "on")

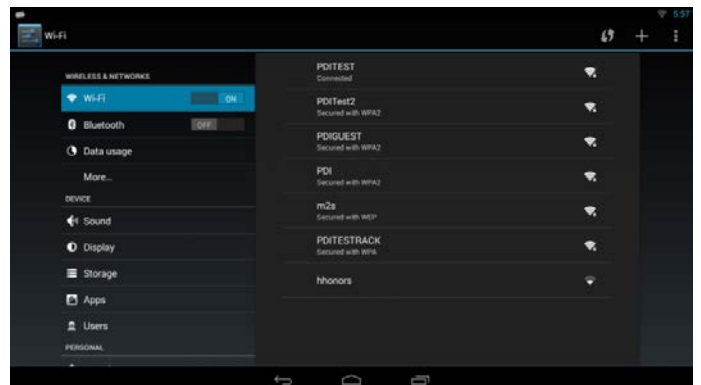

2. The tablet scans for available Wi-Fi networks and displays the names of those it finds. Secured networks are indicated with a .
3. If the tablet finds a network that you connected to previously, it connects to it.



 PDi Communication Systems, Inc. Your Source for Healthcare and Wellness Infotainment™	MODEL: PDI-P14T2	Document Number: PD196-250R5
	LCD HDTV with Android Quick Start Guide	Page 10 of 16

4. Touch a network name to see more details or connect to it, and type a security code if necessary.

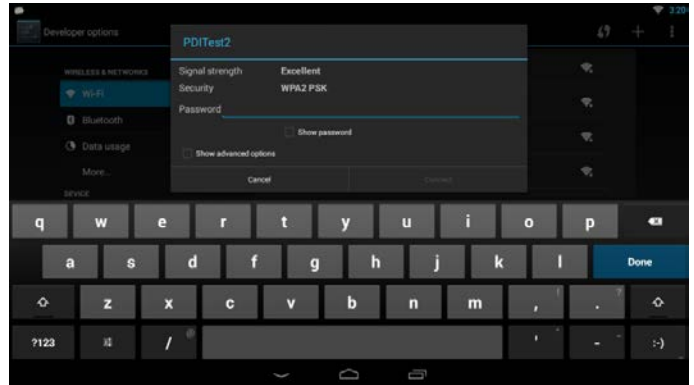

CLONING INFORMATION

Cloning the android portion of the TV must be performed separately. The cloning for the android will be from a cable connection in the swivel portion of the TV.

1. From the android home screen, touch the *All Apps* icon  .

Note: Default home screen is for illustration purposes only and may be different for your device.



2. In the All Apps screen, touch the *Clone* icon.

You may be prompted for a security code by the security application.

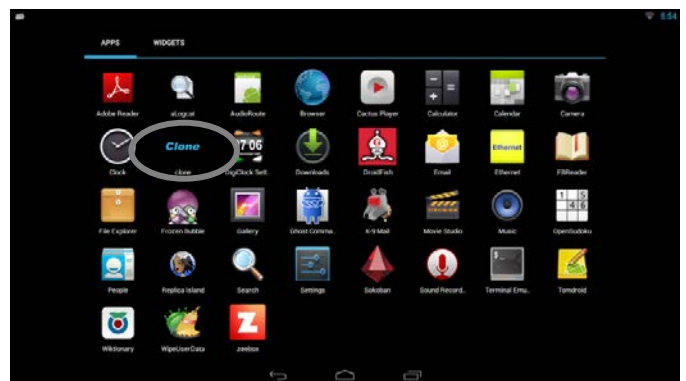

 PDi Communication Systems, Inc. Your Source for Healthcare and Wellness Infotainment™	MODEL: PDI-P14T2	Document Number: PD196-250R5
	LCD HDTV with Android Quick Start Guide	Page 11 of 16

Master Configuration Instructions

Option 1: Set up this device as a server; continue to the next steps.

Option 2: Slave configuration page 14

You will now have the cloning screen

- To use this device to generate clone data, touch Master.
- Follow Master setup information by sliding the screens and entering information.

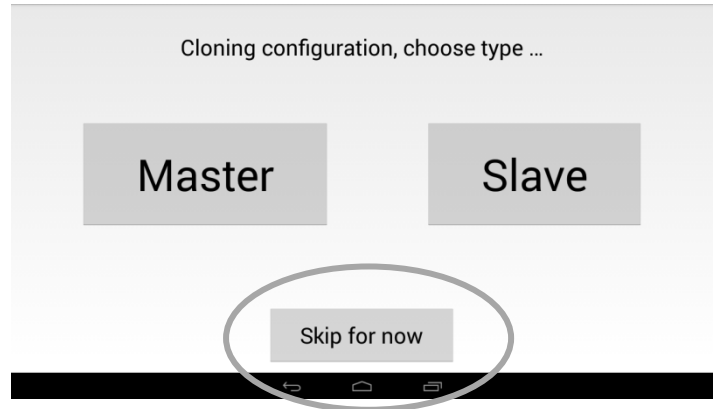

(STEP 1)

Create Master Device

If you are not ready to clone at this time, you can come back to this screen once you are ready to clone your changes.

If you wish to create a master device now, then slide the screen or use tabs at the top of the screen

Note: The checking options are disabled in this screen.

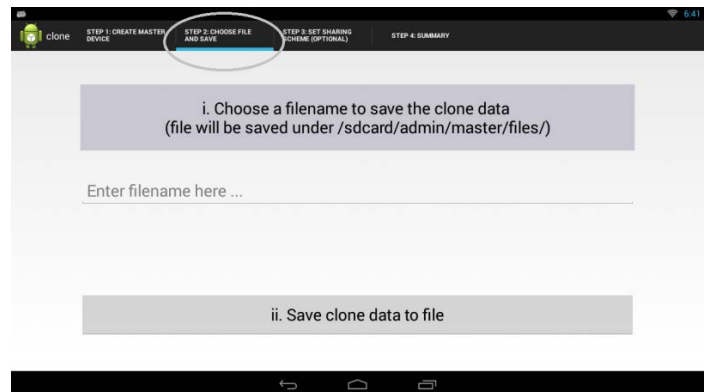
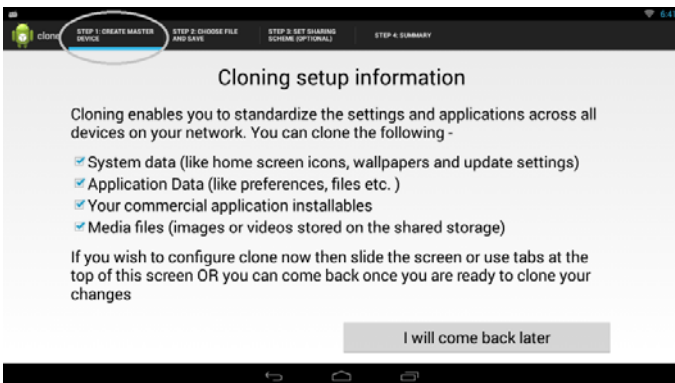

(STEP 2)

Choose file and save

Touch *Enter filename here...* and you will be able to type your desired file name.

Touch *Save clone data to file* to start saving the clone data.

If the file name you have chosen already exists, then you will be presented with the *file already exists* screen.

Touch *OK* if you want to overwrite the existing file or touch *Cancel* to choose a different file name.

Note: The default file name is **clone.ab**

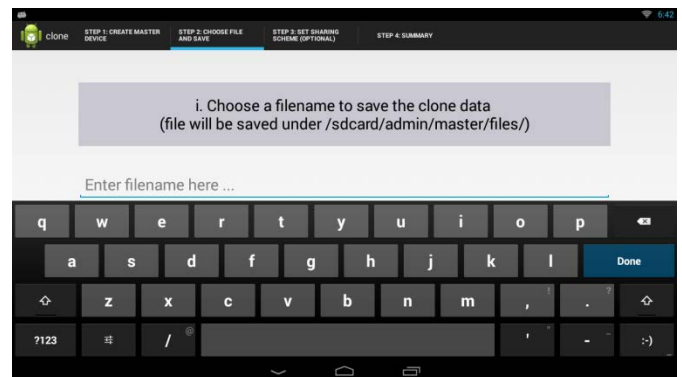

 PDi Communication Systems, Inc. Your Source for Healthcare and Wellness Infotainment™	MODEL: PDI-P14T2	Document Number: PD196-250R5
	LCD HDTV with Android Quick Start Guide	Page 12 of 16

While the device is being cloned, you will see the screen to the right. The time taken will depend on the number of applications and the size of files.

DO NOT TOUCH the screen during this process.

Note: The clone data file will be saved under “/sdcard/admin/master/files/” folder.

(STEP 3)

Set Sharing Scheme (Optional)

See Option 1: to use this device as an ftp server.

See Option 2: to use another device as a clone data server.

Option 1:

If you want to use this device as a clone file server, keep the checked option as shown and follow the next two steps.

Note: The device network name and device ip address are not editable.

1. Touch *Go to file server* to set up the ftp server. If prompted by the app locker, please enter your security code.
2. Confirm and save slave config file (applicable for auto cloning and will be available in future release)

FTP Server configuration

Select the SD card Tab and browse the admin folder.

You should be able to see the clone files you save under **SDcard/admin/master/files**

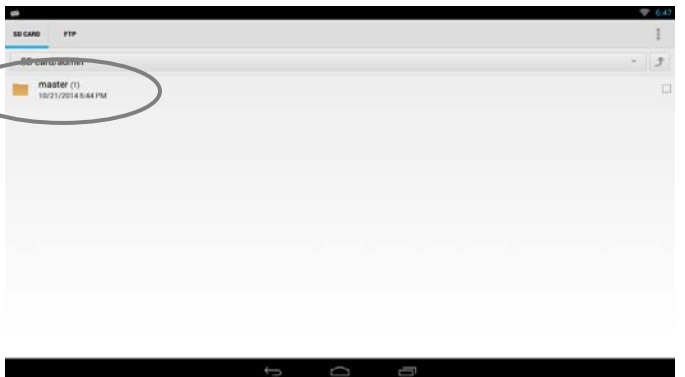
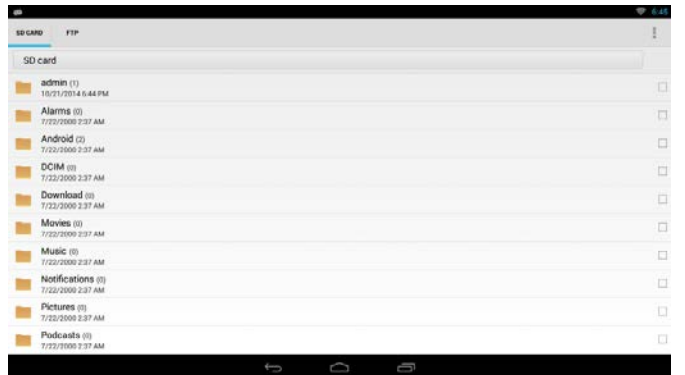
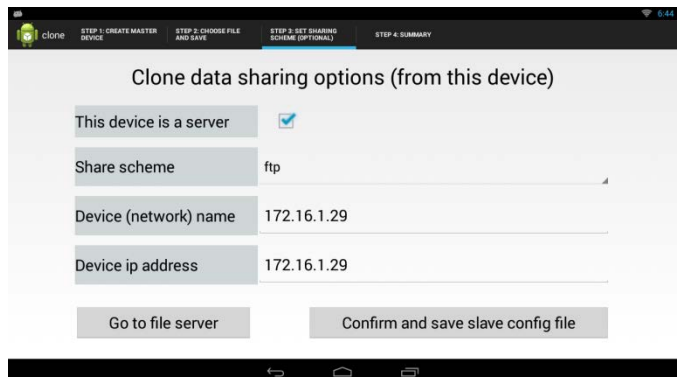
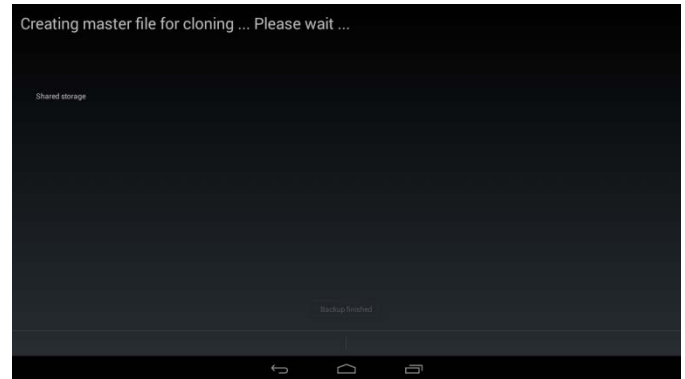

 PDi Communication Systems, Inc. <i>Your Source for Healthcare and Wellness Infotainment™</i>	MODEL: PDI-P14T2	Document Number: PD196-250R5
	LCD HDTV with Android Quick Start Guide	Page 13 of 16

Slide to the ftp server tab.
 You will see your network status and an icon labeled *Start Service*

Touch *Start Service* to start the ftp server on this device.

If you see the icon label *No Wi-Fi-Network* please check your network connection.

Note: The ftp server will work only on a Wi-Fi connection.

Note: The ftp server will have to be manually re-started when the device reboots.

Touch the back arrow  to go back to the cloning application screen.

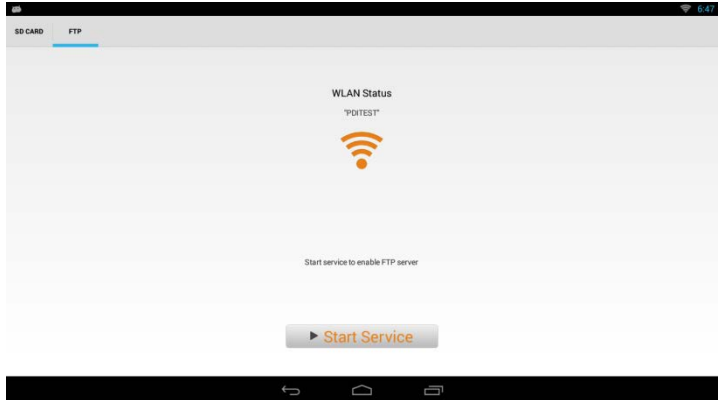

The *Confirm and save slave config file* takes you to the Slave configuration setup.

Make sure the entries are in Green. This means the host is reachable and the file is available.

You may also use this information for manual slave set-up.



Congratulations, your master clone setup is complete!
 Step 4: Summary

Touch *All Done* to exit the cloning application

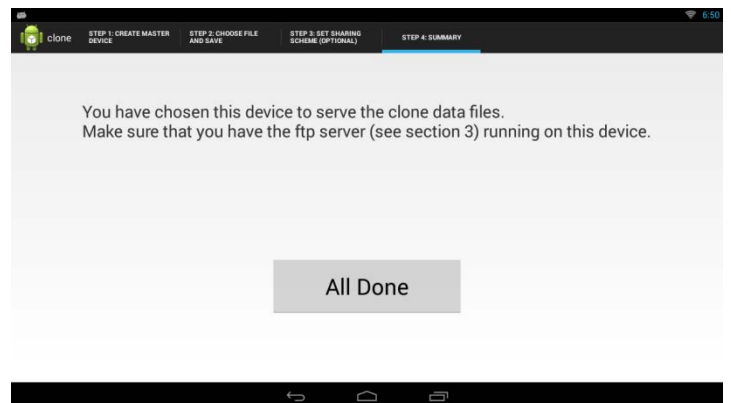

 PDi Communication Systems, Inc. Your Source for Healthcare and Wellness Infotainment™	MODEL: <p style="text-align: center;">PDI-P14T2</p>	Document Number: PD196-250R5
	LCD HDTV with Android Quick Start Guide	Page 14 of 16

Option 2:

If you do not want to use this device as a clone file server, uncheck the check box next to *This device is a server*

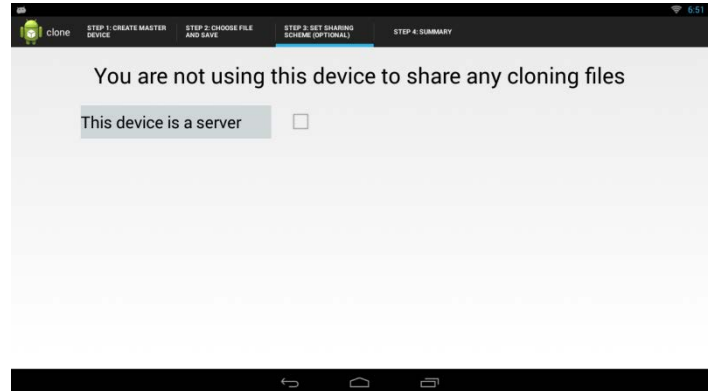

Slide to the next screen.

Congratulations, you have saved your master clone data file!

You have not chosen this device to serve the clone data files.

For dynamic cloning you would need to put the clone data file on a server. You can then use that server information for the slave configuration file - See the section on *Slave Configuration* for details.

Touch *All Done* to exit the cloning application.

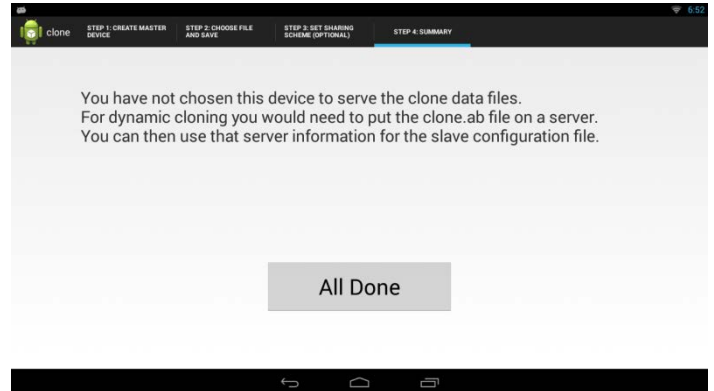



Slave Configuration

To Clone from the clone data (saved in previous section) to another P14T2, follow the steps below.

From the android home screen, tap the  icon.

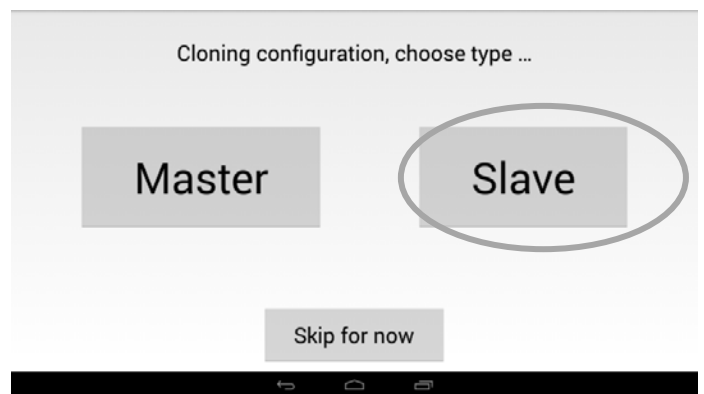
1. In the All Apps screen, press the *Clone* icon.
2. Choose *Slave* to enter configuration setup.



 PDi Communication Systems, Inc. Your Source for Healthcare and Wellness Infotainment™	MODEL: <p style="text-align: center;">PDI-P14T2</p>	Document Number: PD196-250R5
	LCD HDTV with Android Quick Start Guide	Page 15 of 16

Enter the information of the Master Clone file on this screen.

Make sure the entries are in Green. This means the host is reachable and the file is available.

Touch *Done* to save the slave config file. This device will be cloned on next new user.

To clone this device now (and also for future users of this device) touch the *Clone this device* button. (You will see bottom screen)

Note: Check the box next to *Check for updates to the clone file...* if you want the clone device to check for updated file on a new user.

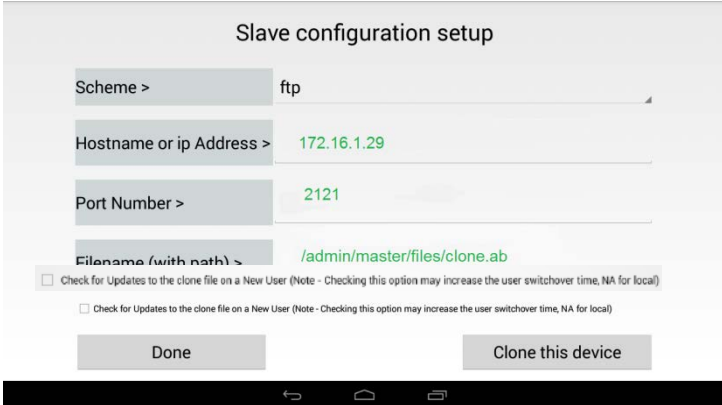

When cloning is complete, the TV will return to the home (cloned) screen.

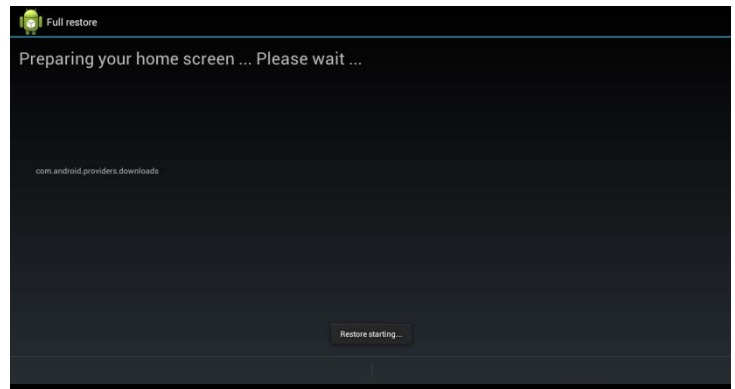

Micro USB Cable

PDi-TAB2 devices have a micro USB cable that is mounted inside the nose cover extending from the neck of the unit. This cable allows service personnel to provide offline updates to the Android firmware. In addition, this cable and the USB port it is attached to, support the USB On-The-Go (OTG) standard, which allows the connection of external devices such as flash drives and keyboards. The devices that attach to this cable along with any other external cabling must also support the USB OTG standard along with being supported by the Android firmware. For instance, if a flash drive is attached, (ex: Sandisk BN140600028 supporting FAT32, NTFS, or EXT file systems) any pictures on the device will appear in the Gallery.

Note: Microsoft's exFAT file systems found on flash drives greater than 32 GB by default and Mac OS file systems are not supported by the PDi-TAB2.

Additional Information

Additional information is available in the user manual. You can access this information online at <http://www.pdiarm.com/>, document number PD196-251.

 Communication Systems, Inc. <i>Your Source for Healthcare and Wellness Infotainment™</i>	MODEL: <p style="text-align: center;">PDI-P14T2</p>	Document Number: PD196-250R5
	LCD HDTV with Android Quick Start Guide	Page 16 of 16

Limited Warranty

PDi Communication Systems Inc., ("PDi") warrants, to the original purchaser only, that the product will be free from defects in materials and workmanship, under normal use, for 2 years from the date of original purchase. This warranty does not cover any other equipment that may have been included with PDi's shipment of this product.

After receipt of written notice of a defect or malfunction occurring during the warranty period, PDi will repair or replace goods returned to its Springboro, Ohio location, at its discretion, the whole or any component part of any product manufactured by PDi and found by PDi to be defective. If the decision is made to replace the product, PDi will exchange the model for the same model or a model similar in form and function.

As a condition to obtaining warranty service, written notification of the defective product must be received by PDi within ten (10) days of noticing the defect. Repair of said product requires it to be shipped to the PDi factory in Springboro, Ohio. All shipments shall be F.O.B. Springboro, Ohio, and all shipping and freight charges to PDi's factory shall be paid by the customer.

For information regarding authorized servicing and all other information pertaining to this warranty, please contact PDI COMMUNICATION SYSTEMS at 40 Greenwood Lane, Springboro, Ohio 45066 or phone 800-628-9870 and ask for Service.

This warranty gives specific legal rights and you may also have other rights which vary from state to state.

Exclusions from Warranty

- Products damaged by any catastrophe, accident, or from neglect, misuse, fault, improper assembly, improper maintenance, inadequate return packaging, or negligence by the customer or any third party. They will be treated as out of warranty for external cause to the Products, such as, but not limited to, failure of or faulty electric power, air conditioning, operator error, failure or malfunction of any data communications system. Such conditions will be determined by PDi at its sole unfettered discretion.
- Service and repair of accessories, apparatus, attachments or any other devices which are not PDi products or options.
- Defacing of product, revision control and PDi labeling (label alterations, serial number missing, serial number no longer discernible and serial number invalid). All serial numbers are recorded and tracked for warranty purposes.
- Unauthorized changes, modifications or alterations in or to the Products not installed by PDi.
- Damage to or loss of any programs, data, or removable storage media.
- Damage incurred during installation, relocation or removal of the Products or any accessories, apparatus, attachments or other devices.
- Normal wear.
- The furnishing of accessories or supplies.
- Damage by shipping carrier.
- Incompatibility issues.
- Damages of any kind including, but not limited to, direct or indirect damages, lost profits, lost saving, or other special incidental, exemplary or consequential damages whether for breach of contract, tort or otherwise, or whether arising out of the use of or inability to use the product, even if PDi or any distributor, dealer, or authorized service provider has been advised of the possibility of such damages, or any claim by any other party
- Damage caused by any software or application not installed at the factory.

PDi's liability under this warranty is limited to repair or replacement of defective products and parts as provided above. PDi shall not be liable for incidental or consequential damages.*

The warranty contained herein is in lieu of all other expressed or implied warranties, including any implied warranty of merchantability or fitness for any particular purpose. PDi neither assumes nor authorizes any person to assume, on its behalf, any other obligation or liability.

*Some states do not allow the exclusion or limitation of incidental or consequential damages or a disclaimer of warranties implied by law, so the above limitation or exclusion may not apply.

The information and technical data in this manual is believed accurate, but is not warranted and is subject to change without notice or obligation. PDi reserves the right to change this policy without advance notice.