

Service Manual

P E R S O N A ^{1 0}

Hospital-Grade LCD Television



PDI
Communication
Systems, Inc.
40 Greenwood Lane
Springboro, Ohio
45066

PH: 937-743-6010
FX: 937-743-5664

<http://www.pdiarm.com>

For Serial Numbers xxxx-xxxxxx-Bx

Model P10LCD Color Television

Better Solutions Are Within Reach[®]

Graphical Symbols



This lightning flash with arrowhead symbol, within an equilateral is intended to alert the user of the presence of uninsulated “dangerous voltage” within the product’s enclosure that may be of sufficient magnitude to constitute a risk of electric shock to persons.



The exclamation point within an equilateral triangle is intended to alert the user of the presence of important operating and maintenance (servicing) instructions in the literature accompanying the appliance.

This service manual contains various CAUTIONS and WARNINGS indicated by triangular warning symbols, which should be read and understood in order to minimize the risk of personal injury to service personnel and customers. The possibility exists that improper service methods may damage the equipment or result in property damage or user injury. It also is important to understand that these CAUTIONS and WARNINGS are not exhaustive. PDI could not possibly know, evaluate and advise the service industry of all conceivable methods in which service might be done or of the possible hazardous consequences of each method. Accordingly, a servicer who uses a service procedure or tool which is not recommended by PDI must first satisfy themselves thoroughly that neither their safety nor the safe operation of the equipment will be compromised by the service method selected.

Product Safety Servicing Precautions

1. **MODIFICATIONS** Do not attempt to modify this product in any way without written authorization from PDI. Unauthorized modifications will not only void the warranty, but may lead to your being liable for any resulting property damage or user injury.
2. **POWER SOURCE** Use only a power source from a CSA Certified / UL Approved Class 2 Power Supply suitable for use in a Health Care Facility. This TV will operate on either DC or AC voltage.
3. **X-RAYS** X-Ray Radiation is not a concern since this TV does not incorporate a CRT.
4. **REPLACEMENT PARTS** Parts critical to the safe operation of this television are marked with a  on schematics or drawings. Replace only with the part number specified.
5. **SAFETY CHECKS** This hospital grade television requires special safety checks before returning to service. Observe and follow the “Safety Check” section in this service manual.

Voltage	Range
AC	18-32 Volts
DC	18-32 Volts

Table of Contents

Graphical Symbols	2
Product Safety Servicing Precautions	2
Table of Contents	3
Copyright, Disclaimer, and Trademarks	4
Regulatory Information	4
Product Identification	5
Remote Control.....	6
General Specification	7
Disinfecting and Cleaning.....	12
Hidden Factory Menu	13
Picture and Power Supply Adjustments	14
Pan Adjustment	15
Tilt Adjustment.....	16
Main Circuit Board Interconnections.....	17
IR / Speaker Board Interconnections	18
Safety Checks.....	19
Schematic & Troubleshooting.....	22

Copyright, Disclaimer, and Trademarks

Copyright

PDI Communication Systems, Inc. claims proprietary right to the material disclosed in this service manual. This manual is issued in confidence for servicing information only and may not be used to manufacture anything shown herein. Copyright 2004 by PDI Communication Systems, Inc. All rights reserved.

Disclaimer

The author and publisher have used their best efforts in preparing this manual. PDI Communication Systems, Inc. makes no representation or warranties with respect to the accuracy or completeness of the contents of this manual and specifically disclaim any implied warranties of merchantability or fitness for any particular purpose and shall in no event be liable for any loss of profit or any other damages, including but not limited to special, incidental, consequential or other damages. The information contained herein is believed accurate, but is not warranted, and is subject to change without notice or obligation.

Trademarks

All brand names and product names used in this manual are trademarks, registered trademarks, or trade names of their respective holders.

PDI and Better Solutions Are Within Reach are registered trademarks of PDI Communication Systems, Inc., Springboro, Ohio.

Regulatory Information

FCC

This equipment has been tested and found to comply with the limits for a Class B digital device, pursuant to part 15 of the FCC Rules. These limits are designed to provide reasonable protection against harmful interference when the equipment is operated in a residential or commercial installation. If this equipment does cause harmful interference to radio or television reception, which can be determined by turning the equipment off and on, the user is encouraged to try to correct the interference by one of more of the following measures:

- Reorient or relocate the receiving antenna.
- Increase the separation between the equipment and receiver.
- Connect the equipment into an outlet on a circuit different from that to which the receiver is connected.
- Consult the dealer or an experienced radio/TV technician for help.

Underwriters Laboratories



The model PDI-P10LCD Hospital Grade LCD TV is a specialized LCD television and should be installed to National Electrical Code specifications.

This device is safety tested and listed by the Underwriters Laboratories as a product suitable for use in health care facilities in both the United States and Canada.

Product Identification

PRODUCT LABEL

The P10LCD is easily identified using the product label located in the center of the back cabinet..

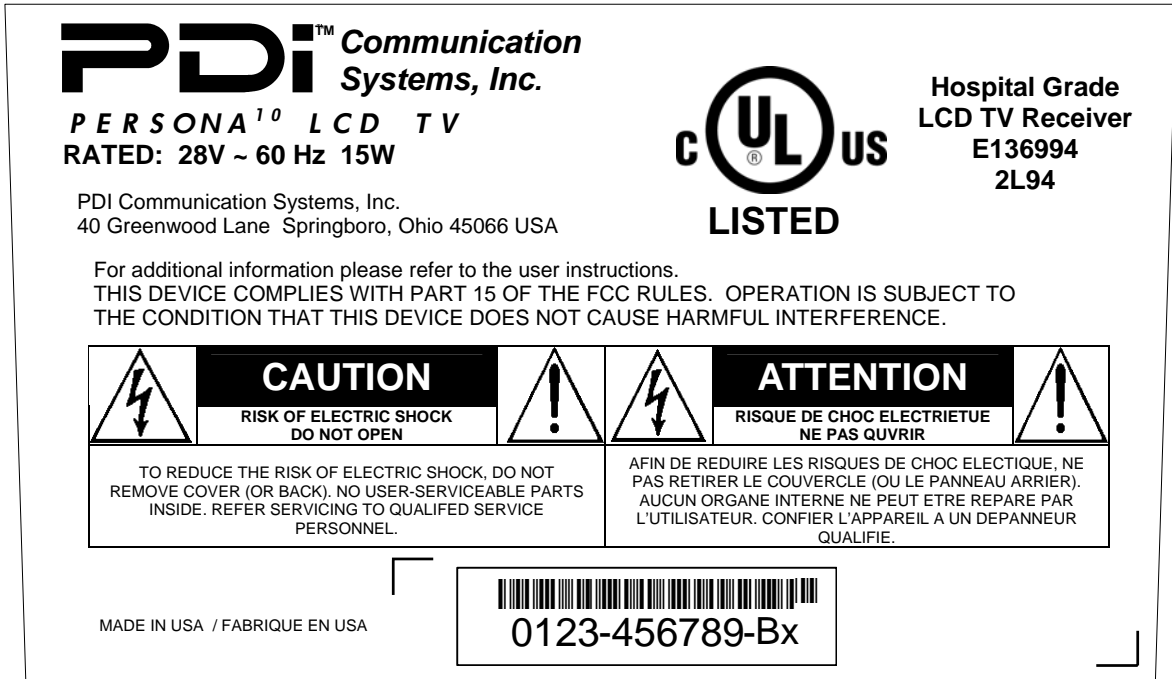

SERIAL NUMBER

The serial number is located at the lower right corner of the product label.



Serial Number Format Explanation

- Digits **01** are year of manufacture. Example year 2003 would be 03.
- Digits **23** are week of manufacture. Example 13 would be week 13.
- Digits **456789** is the TV unit serial number. Example 000001 is the first unit manufactured.
- Letter **B** is single letter denoting the TV model revision level. For example, A would be the initial model. First model revision would be B. The second model revision would be C and so on.
- Letter **x** is a single letter denoting the TV model option.

Remote Control

The P10LCD requires a remote control (part number PD108-412) to program the set. You will NOT find a remote control packed with the television. The remote control is shipped separate from the television. The remote control has a limited range to prevent dual programming of an adjacent room TV. Stand within 3 feet or closer from the front of the TV to use the remote.

PROGRAMMING REMOTE (PD108-412)

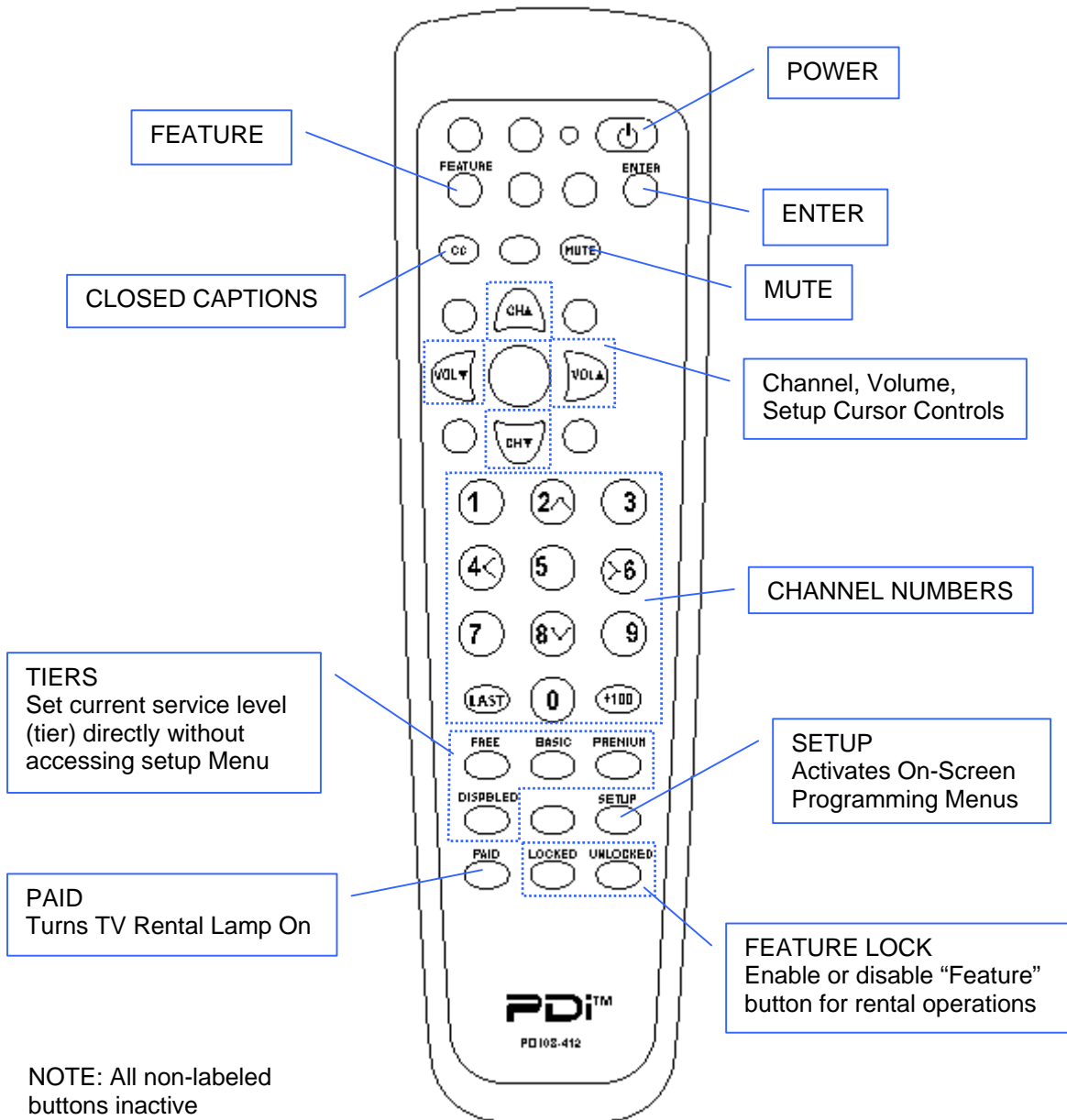

General Specification

1. SYSTEM		
	LCD	
	Size	10.4" Diagonal
	Type	Amorphous Silicon TFT (Thin Film Transistor)
	Format	640 x 480 Pixel (RGB)
	Brightness	330 NITS
	Viewing Angle	55° Vertical, 110° Horizontal
	Contrast Ratio	180:1
	Surface Treatment	Antiglare Hard Coating
	Back-Lights	
	Quantity	2
	Type	CCFL
	Color System	
	Type	NTSC 3.58
	Color Depth	262,144
	Speaker	
	Quantity	1
	Location	Front Mounted
	Size	28.5 x 40 mm
	Impedance	8 ohms
	Output	1 Watt Max.
	Distortion	10% at 0.8W
	Earphone	
	Location	Side Mounted
	Size	3.5mm
	Monaural	Yes
	Stereo	No
	Internal Speaker	Disabled during Earphone Use
	Computer Monitor Capable	No
	Internal DVD	No
	Keylock	None, TV Disable Available Via IR Remote
2. TUNING		
	Type	North American NTSC Type M
	System	Frequency Synthesized
	Input Impedance	75 ohms
	Channel Range	VHF: 2 – 13, UHF: 14 – 69, CABLE 2 –125
	Stereo Sound	No
3. POWER		
	Multi-Voltage	Yes
	Externally Powered	Yes, External Power Source Required
	DC Voltage	18-32 Volts DC
	AC Voltage	18-32 Volts AC
	Power Consumption	15 Watts
	Standby Power	5 Watts
	Protection	7A, 125V Fuse, Internal
	Coax Powered	Yes, Power and RF Dplexed
4. REGULATION		
	Safety	
	Testing Laboratory	Underwriters Laboratories

	Testing Type	UL and cUL
	Healthcare Certified	Yes, UL6500 and cUL6500
	Interference	FCC, CFR 47 Part 15 Class B, DOC Class B
	X-Radiation	N/A
	Manufacturing Origin	United States
5. ON SCREEN DISPLAY		
	Menu Type	Character
	Menu Entrance	IR Remote Control Only
	Format	15 Rows by 30 Columns
	Colors	15 Foreground, 7 Background
	Menus	
	Picture	
	Brightness	Yes
	Contrast	Yes
	Color	Yes
	Tint	Yes
	Channel Setup	
	Signal	Air, CATV, CATV-IRC, CATV-HRC
	Autoprogram	
	Free	Programmable Tier
	Basic	Programmable Tier
	Premium	Programmable Tier
	Clear Service Level	
	Free	Erasable Tier
	Basic	Erasable Tier
	Premium	Erasable Tier
	Add/Delete Channels	
	Free	Individual Channels
	Basic	Individual Channels
	Premium	Individual Channels
	Copy Service Levels	Yes, Tier to Tier Copy
	Features	
	Power ON Channel & Spkr	Selectable by Tier
	Free	Start Channel, Speaker On/OFF
	Basic	Start Channel, Speaker On/OFF
	Premium	Start Channel, Speaker On/OFF
	Volume Limiter	Yes
	Caption Text Mode	Enabled, Disabled
	Language	English, French, Spanish
	Service Levels	Disabled, Free, Basic, Premium
	Paid	Yes, No
	Self Rent	Locked, Unlocked
	Channel Number	Yes
	Channel Labels	No
	Sleep Timer	No
	Sound Mute	Yes
	V-Chip Rating	No
5. FEATURES		
	Sleep Timer	No
	On/Off Timer	No
	Auto Shut OFF	Yes - Disable Mode, Empty (Blank) Tier

	Auto Degauss	N/A
	Anti-Theft Alarm	No
	Rental	Yes
	Service Levels	3
	Rental Lamps	3, Red, Green, Amber
	Patient Self Rent	Yes – Programmable
	Payment Lamp	Yes
	Non-Volatile Memory	Yes
	Last Channel	Yes
	Last Volume	Yes
	Power On Channel	Yes, Selectable per Tier
	Direct Channel Entry	Yes, Active Tier Channels Only
	Channel Numbers	Yes
	Hospital Welcome Channel	Yes, Selectable on per Tier Basis
	Comb Filter	Yes
	Auto Channel Memory	Yes
	Closed Captions	Yes, CC1, CC2, TEXT1, TEXT2
	Text Mode Disable	Yes
	Speaker Mute	Yes
6. KEYPAD CONTROLS		
	Switch	
	Type	Domed Membrane
	Tactile Feedback	Yes
	Actuation Force	12 Ounces
	Life	1,000,000 Cycle Minimum
	Front	
	Power	Yes
	Volume Up	Yes
	Volume Down	Yes
	Channel Up	Yes
	Channel Down	Yes
	Mute	Yes
	CC	Yes
	Feature	Yes
	Enter	Yes
	1	Yes
	2	Yes
	3	Yes
	4	Yes
	5	Yes
	6	Yes
	7	Yes
	8	Yes
	9	Yes
	0	Yes
	Last	Yes
	+100	Yes
	Cursor Up	Yes
	Cursor Down	Yes
	Cursor Left	Yes
	Cursor Right	Yes
	Rear Controls	None

	Indicator	
	Power	Yes, Green LED
	Stand-By	No
	Terminals	
	Video Input	No
	Audio Input	No
	Video Input	No
	Video Output	No
	S-Video Input	No
	S-Video Output	No
	Earphone	Yes, Side Mounted, 3.5MM
	External Speaker	No
	Power/RF Input	F-Type
7. REMOTE		
	IR Format	Custom
	IR Range	Range Limited to 1 Meter
	Power Source	"AAA" x 2
	Total Keys	29
	Keys	
	Power	Yes
	1	Yes
	2	Yes
	3	Yes
	4	Yes
	5	Yes
	6	Yes
	7	Yes
	8	Yes
	9	Yes
	0	Yes
	+100	Yes
	Last	Yes
	CH Up	Yes
	CH Down	Yes
	Vol Up	Yes
	Vol Down	Yes
	Setup	Yes
	Mute	Yes
	Feature	Yes
	Enter	Yes
	CC (Closed Caption)	Yes
	Paid	Yes
	Locked	Yes
	Unlocked	Yes
	Disabled	Yes
	Free	Yes
	Basic	Yes
	Premium	Yes
	Blank(s)	Yes – Non Functional
8. PHYSICAL		
	Cabinet	

	Size	12 x 3 x 15.5 (W x D x H) inches
	Finish	Smooth
	Ventilation	Bottom and Sides Only, Top None
	LCD Screen Protector	Yes, Supplemental Non-Scratch
	Weight (Approx.)	7 lbs.
	Ambient Temperature	
	Operating	+15°C to +30°C
	Storage	-20°C to +60°C
	Relative Humidity	5 to 80% Operational
9. SERVICE		
	Reliability	
	MTBF	50,000 Hours Minimum
	Service Information & Parts	
	Service Manual	Yes
	Parts List	Yes
	Transportation Standard	Meets ISTA Test Procedure 1G

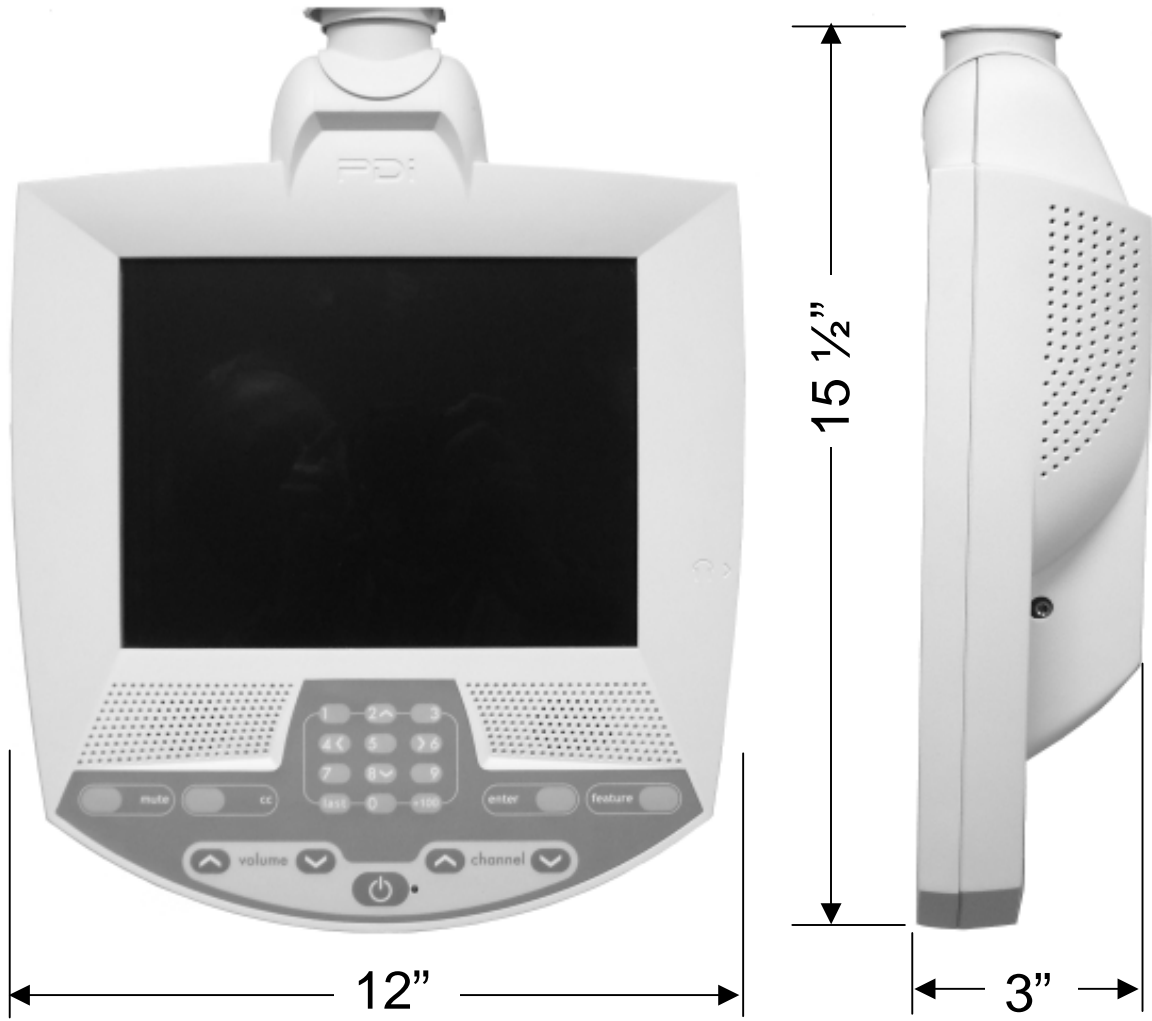

Disinfecting and Cleaning

The P10LCD should be disinfected before performing any service. The following procedure is only a recommendation. Your hospital or company may have a different procedure to follow.



CAUTION – Before using any cleaning or disinfecting agent on the P10LCD, perform a spot check by wetting a small area of the cabinet. Verify the agent does not discolor or deteriorate the cabinet.

Disinfecting

1. The P10LCD has been designed to withstand up to a 5% chlorine based disinfectant. Many alcohol and ammonia based disinfectants have also been tested with success. However, before using any cleaner or disinfectant, spot check a small area on the cabinet.
2. Apply the cleaner or disinfectant per its recommended instructions. Note – most disinfectants require a waiting time following application and prior to wipe-down.

Cleaning

Stubborn ink and other scratch type marks may prove difficult to remove. A dilute solution of Isopropyl alcohol will generally work when all else fails. However, full strength Isopropyl will remove the cabinet's paint. Use with caution!

Hidden Factory Menu

A hidden factory service menu is available to the knowledgeable service man using the following procedure. To access the menu use the PDI remote control (part number PD108-412).

1. With the TV turned OFF, activate the hidden factory menu by pressing the following IR remote key sequence:

SETUP + SETUP + 4 + 0

2. The TV will turn ON automatically. The factory screen is displayed..

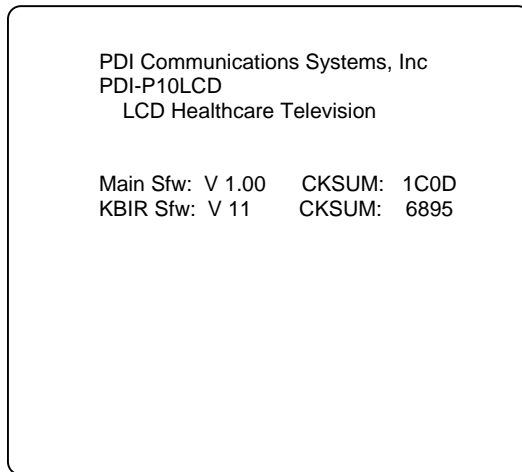

3. The service menu consists of one read-only menu screen which provides firmware checksum values indicating which revision is currently programmed into each of the TV's two microprocessors.
4. Exit the service menu by turning the TV OFF. Or after 30 seconds the TV will automatically turn itself OFF.

Picture and Power Supply Adjustments

Picture

The LCD display does not use magnetic deflection (like a CRT tube display) and does not require any internal adjustments. Dynamic picture adjustments to Brightness, Contrast, Color, and Tint are available using the IR Remote Control part number PD108-412 using the Setup / Picture Menu.

Power Supply Alignment

The P10LCD television utilizes a fixed-voltage switch mode power supply. Internal power supply adjustment is not necessary.

Pan Adjustment

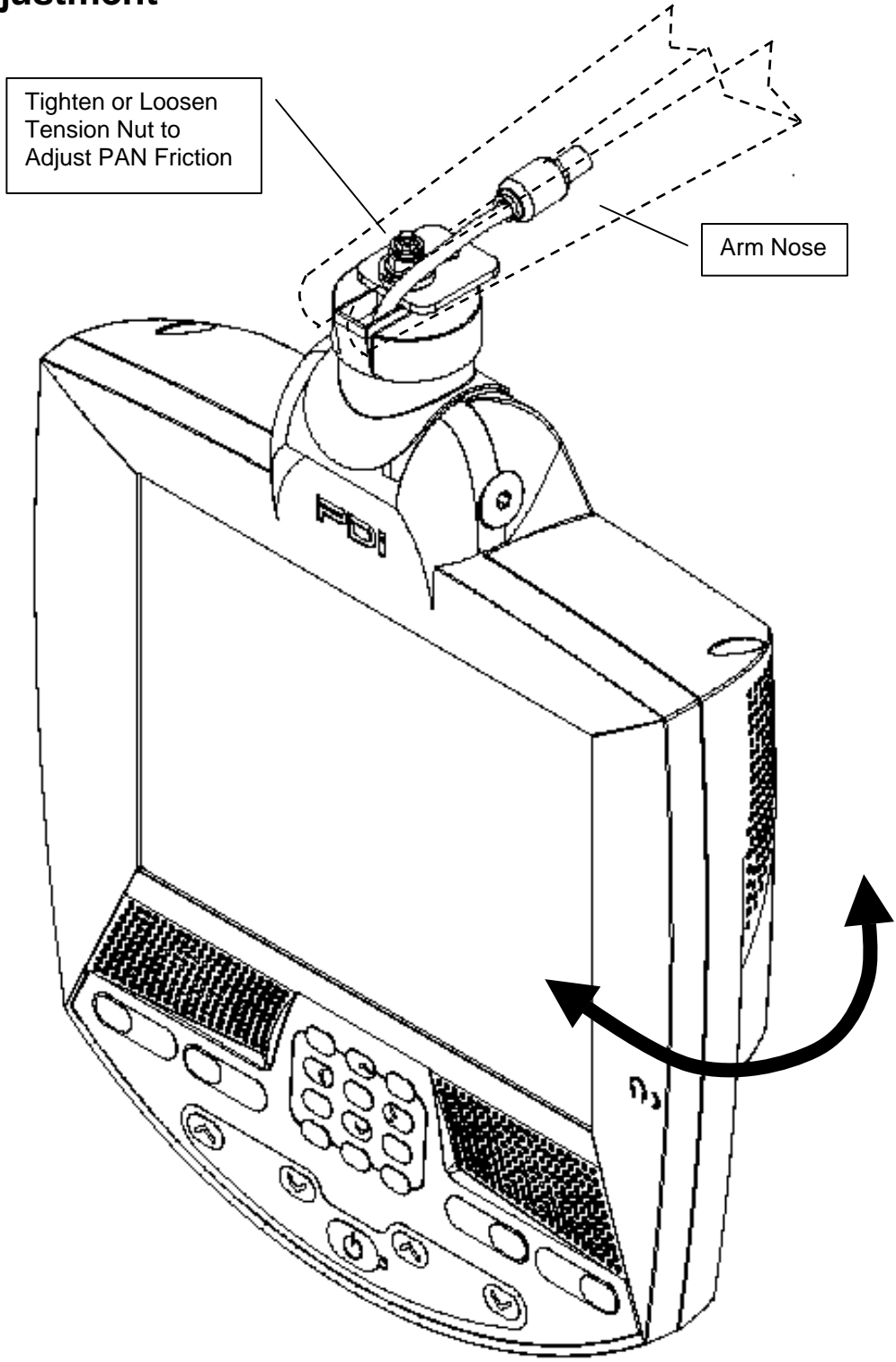

Tilt Adjustment

1. Remove Access Cover.
2. Adjust Tension Nut to Hold Tilt Position.
3. Replace Cover.

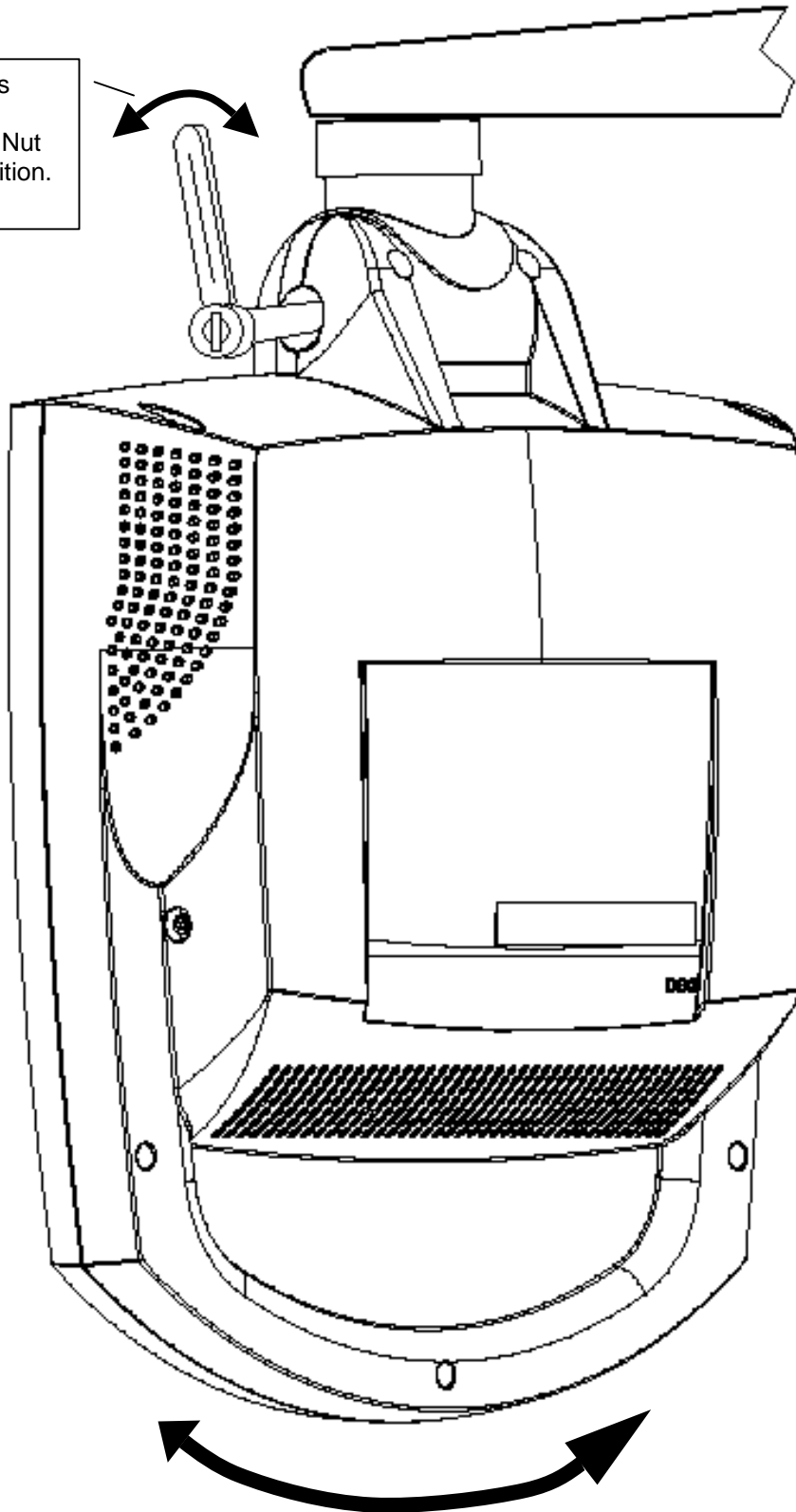

Main Circuit Board Interconnections

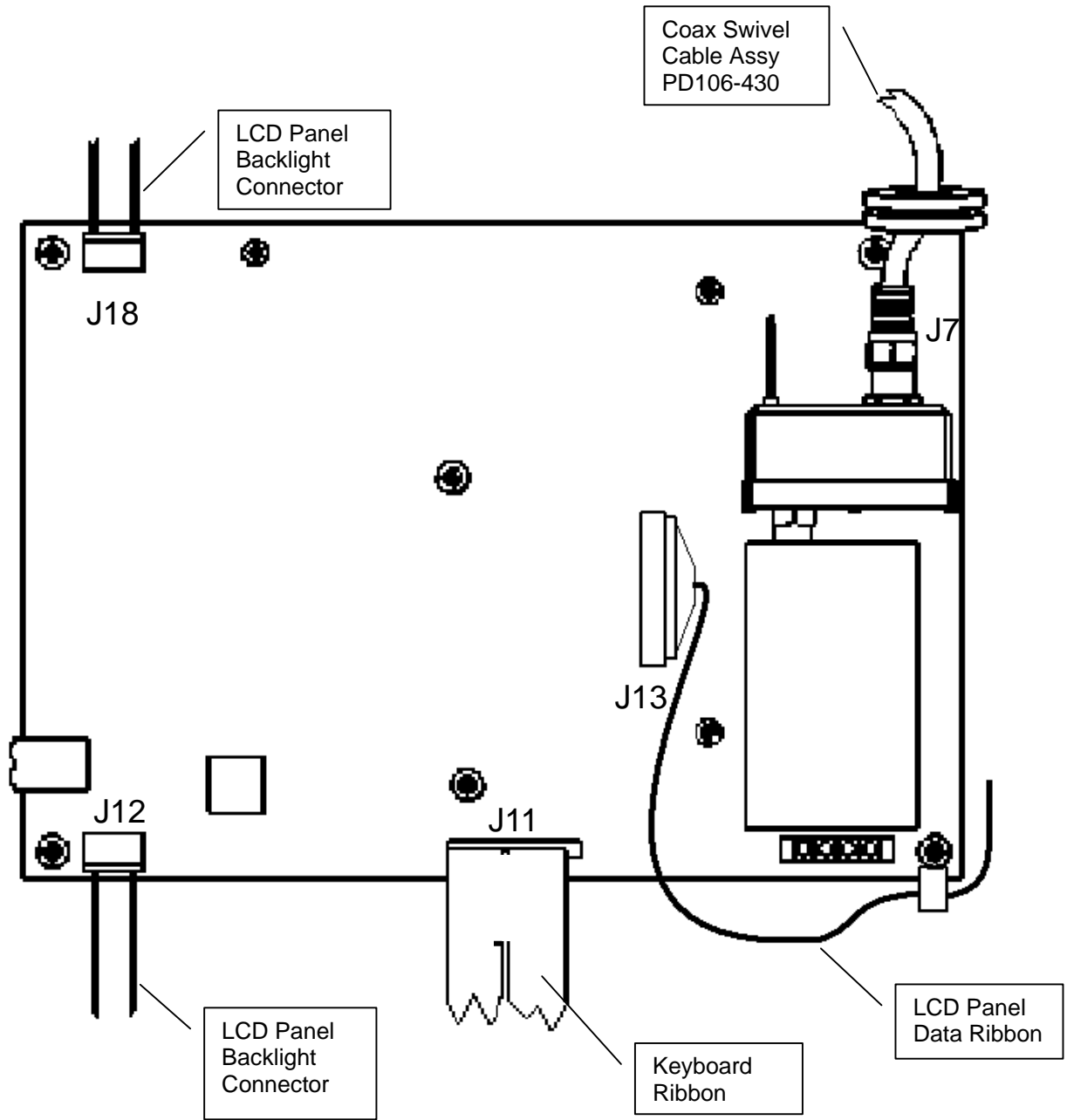

IR / Speaker Board Interconnections

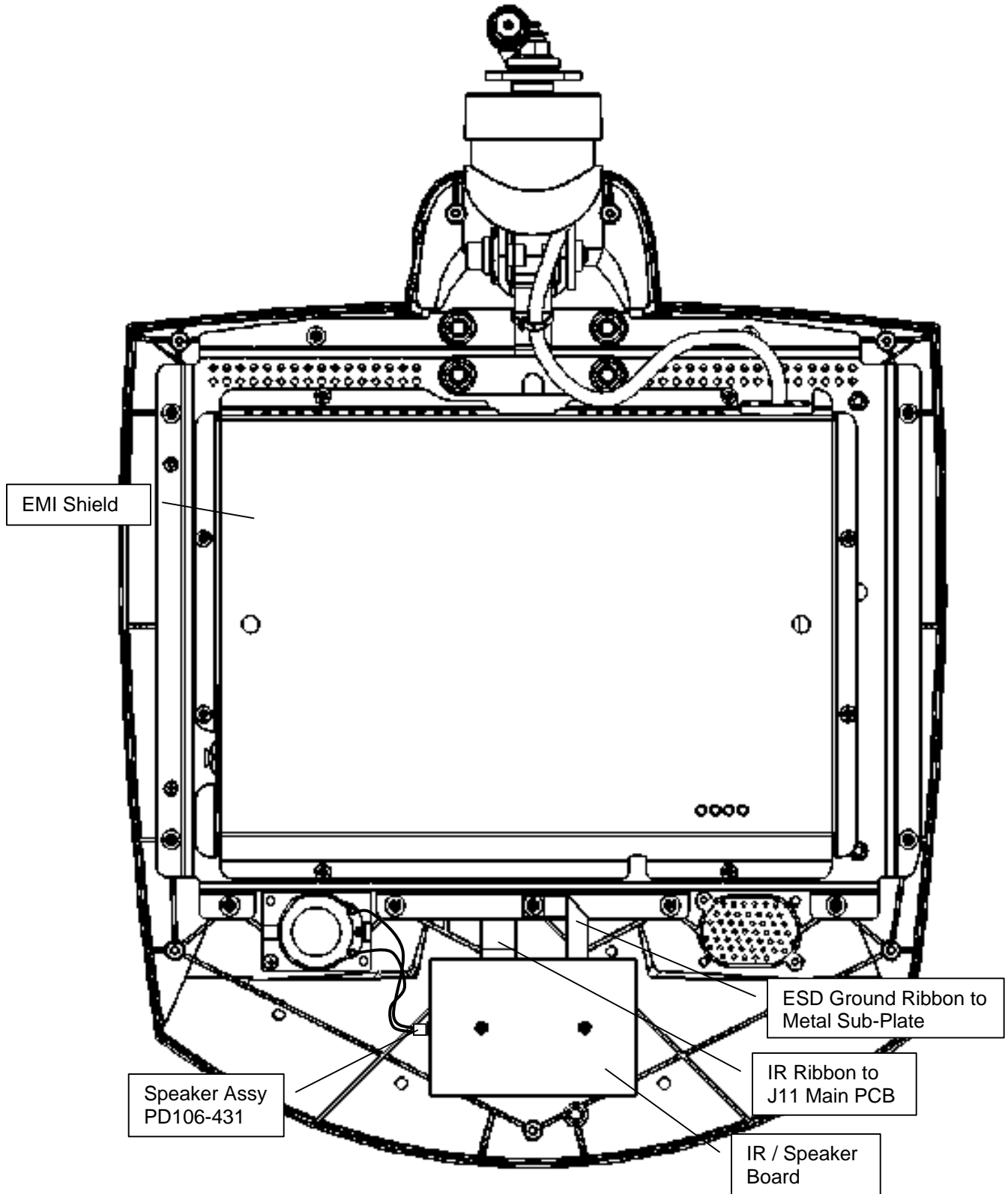

Safety Checks

Before returning the P10LCD to service, the following safety checks should be performed.

1. PARTS PLACEMENT

Confirm that the screws, parts, and wiring which were removed to allow servicing are put back in the original positions.

2. SWIVEL RESISTANCE TEST

1. Expose the mounting swivel.
2. Measure the DC resistance between the input coax shield and swivel as shown. The resistance value should read greater than 4 Meg. A lesser reading indicates a possible insulation breakdown or short between the internal metal U-Bracket and chassis ground which could increase leakage currents touchable by the patient.
3. It is recommended that the reading of the swivel resistance be recorded as part of the service record.

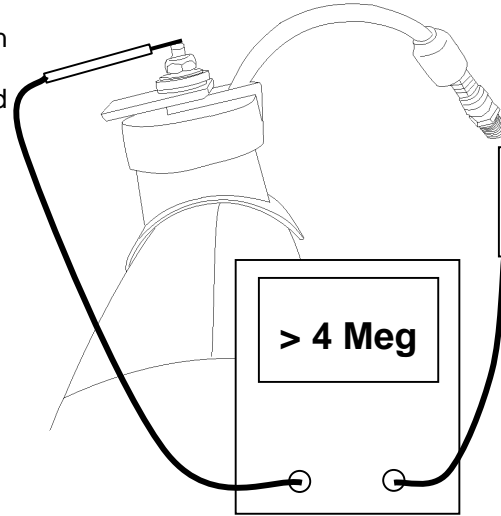

3. AC LEAKAGE CURRENT TEST

Following re-assembly of the P10LCD always perform an AC Leakage Current Test. Use either an approved hospital leakage meter or the R-C network shown. *SWIVEL LEAKAGE*

- a. Power the TV using an approved external 28 VAC power supply. **DO NOT USE A LINE ISOLATION TRANSFORMER DURING THIS TEST.**
- b. Connect one side of the R-C network to a good earth ground such as a water pipe, conduit, etc. Touch the other side of the R-C network to the top of the metal swivel.
- c. Measure the AC voltage drop across the R-C network. The measured voltage must not exceed 0.10 volts RMS (100 millivolts RMS). This corresponds to 100 microamperes of AC current. Any value exceeding this limit constitutes a potential shock hazard and must be correct immediately.
- d. Record the reading as part of the service record.

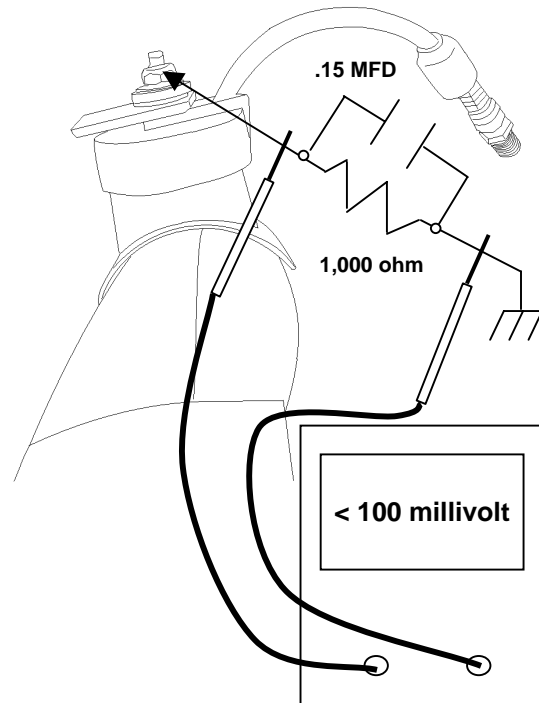

EARPHONE JACK LEAKAGE

- e. Now, connect one side of the R-C network to a good earth ground such as a water pipe, conduit, etc. Touch the other side of the R-C network to the metal ring on the earphone jack.
- f. Measure the AC voltage drop across the R-C network. The measured voltage must not exceed 0.10 volts RMS (100 millivolts RMS). This corresponds to 100 microamperes of AC current. Any value exceeding this limit constitutes a potential shock hazard and must be corrected immediately.
- g. Record the reading as part of the service record.

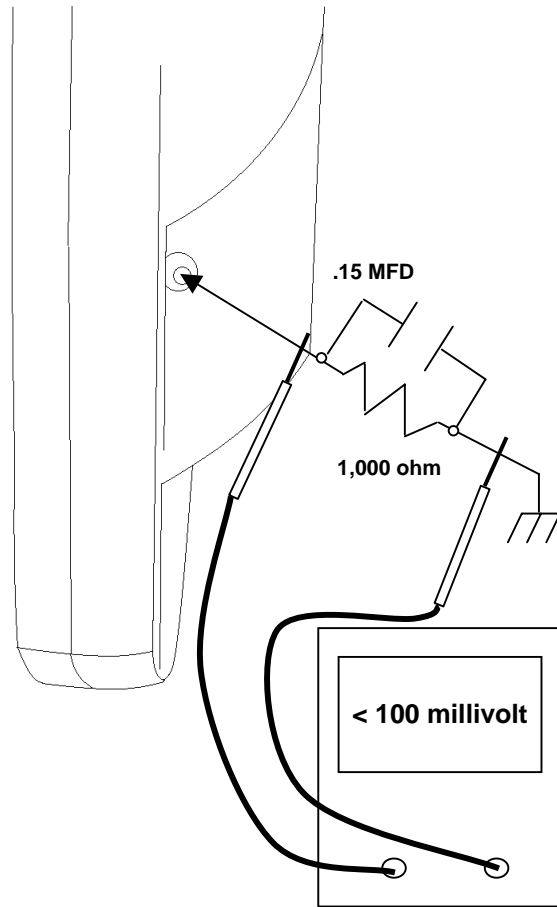

Exploded Assembly View

Mounting Screws Not Shown for Clarity

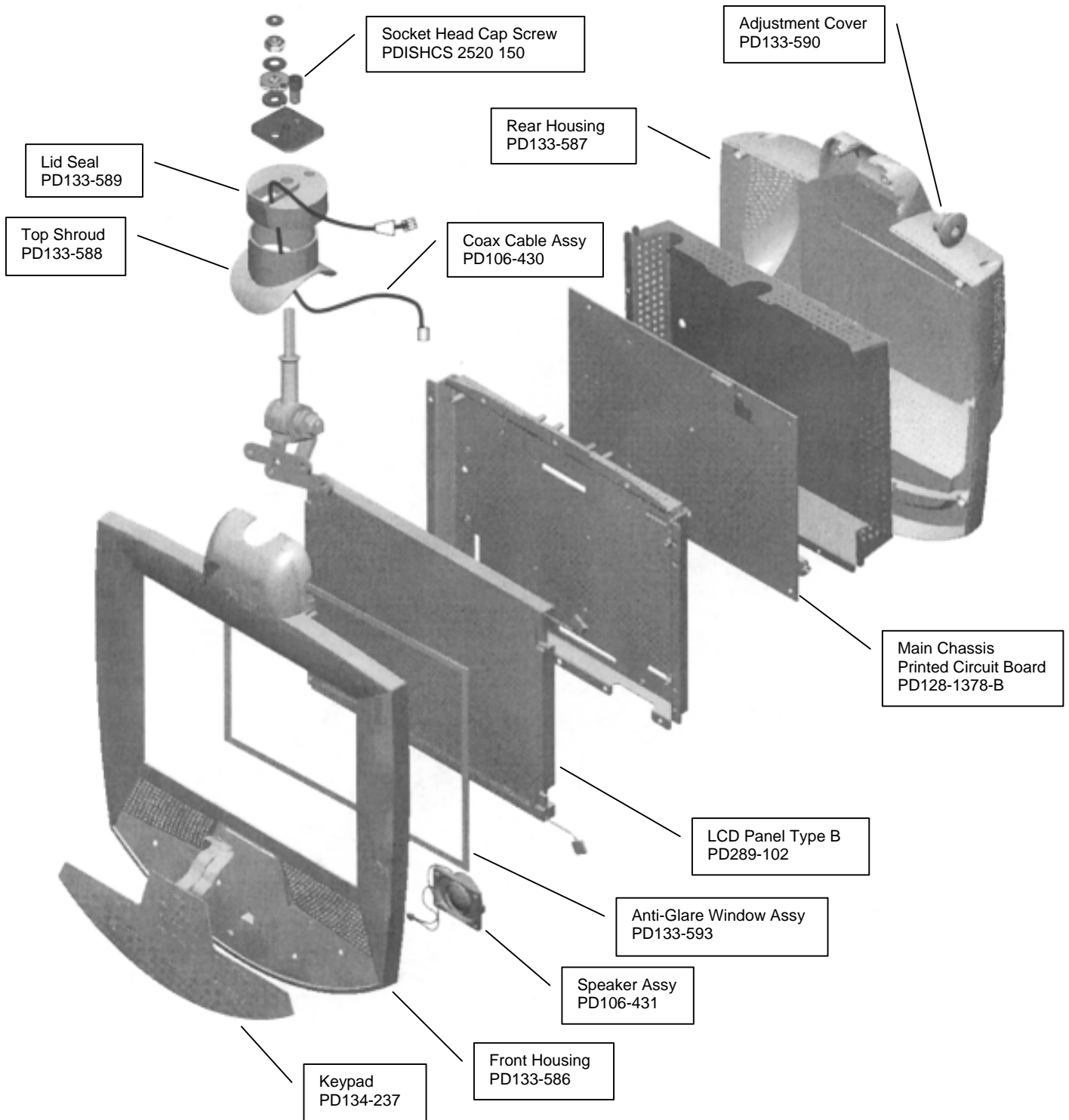

Schematic & Troubleshooting

The P10LCD is manufactured with the intention for board level replacement only. Component level trouble shooting is not supported. A detailed schematic is not provided. The only board level component available for field replacement is the earphone jack.

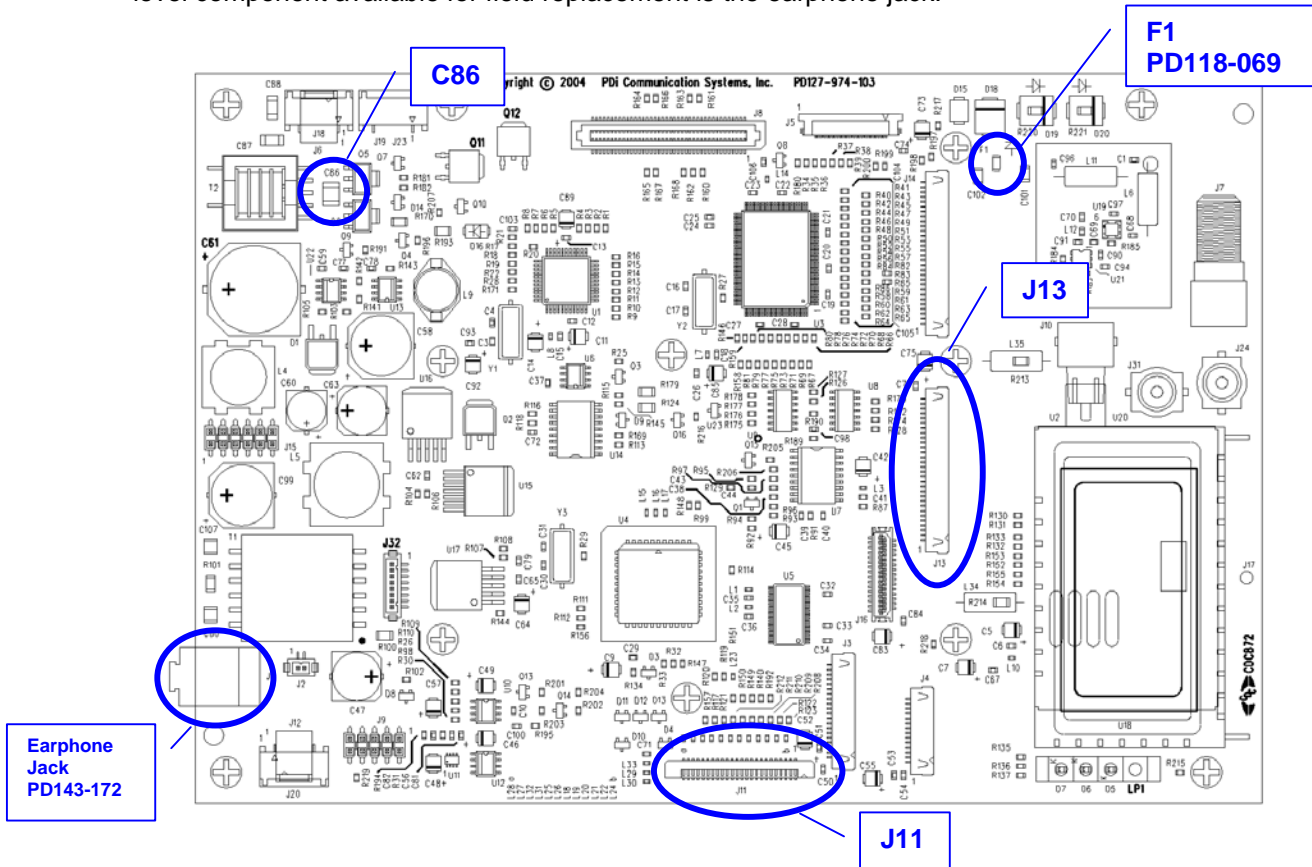

SYMPTOM	CHECK
TV DEAD	<ol style="list-style-type: none"> 1. Verify TV is connected to a coaxial powered cable. 2. Check F1 (7A, 125V). 3. Verify J11 ribbon connector is seated. 4. Verify J13 ribbon connector is seated. 5. Replace main chassis.
BLACK PICTURE, SOUND OK	<ol style="list-style-type: none"> 1. Check for on-screen menu and adjust for maximum brightness and contrast. 2. Verify J13 ribbon connector is seated. 3. Verify 12V peak, 62 Khz switching voltage waveform is present on both terminals of C86. 4. If switching voltage missing, replace main chassis. 5. If switching voltage present, replace LCD Panel.
PICTURE OK, NO SPEAKER SOUND	<ol style="list-style-type: none"> 1. Verify TV is not muted. Verify cable is seated into J11 on Main Chassis and into J2 of IR Board. 2. Verify Earphone is not being used. 3. Verify TV speaker has not been disabled for the current Tier in the "Feature" / "Power-on Channel and Speaker" menu. 4. Replace speaker. 5. Check sound. If sound missing, replace main chassis.

SYMPTOM	CHECK
PICTURE OK, NO EARPHONE SOUND	<ol style="list-style-type: none"> 1. Verify earphone is fully inserted into TV's earphone jack. 2. Try a different earphone. 3. Verify TV is not muted. Adjust for maximum volume. 4. Replace Earphone Jack .
NO COLOR	<ol style="list-style-type: none"> 1. Tune TV to another channel. Check for color. 2. Increase color in "Setup" / "Picture" menu. 3. Verify correct voltage is used to power TV. 4. Verify correct Signal type is set in "Setup" / "Channel Setup" menu. 5. Replace main chassis.
CAN NOT TUNE A DESIRED CHANNEL	<ol style="list-style-type: none"> 1. Verify channel is programmed into current tier. 2. Tune to channel with remote. 3. Tune to channel with TV keypad. 4. Verify correct Signal type is set in "Setup" / "Channel Setup" menu. 5. Replace main chassis.
TV KEYPAD INOPERATIVE	<ol style="list-style-type: none"> 1. Verify TV is correctly powered. 2. Check TV operation with remote control. 3. Verify J11 Ribbon connector is seated. 4. If inoperative, replace keypad. 5. If still inoperative, replace main chassis.
KEY ON TV KEYPAD INOPERATIVE	<ol style="list-style-type: none"> 1. Verify key is active in current TV tier and mode. 2. Press key and check for audible "click". 3. If Key will not click, replace Keypad. 4. If Key inoperative, replace Keypad.
SNOWY PICTURE	<ol style="list-style-type: none"> 1. Verify TV RF signal level is +10dbmv \pm2dbmv. 2. Tune to another channel. 3. Verify correct Signal type is set in "Setup" / "Channel Setup" menu. 4. Replace main chassis.
NOISY PICTURE	<ol style="list-style-type: none"> 1. Verify TV RF signal level is +10dbmv \pm2dbmv. 2. Tune to another channel. 3. Turn off nearby equipment if possible and isolate noise source. 4. Move TV and cables to minimize or eliminate noise. 5. Replace main chassis.

PDi[®]
Communication Systems, Inc.
40 Greenwood Lane
Springboro, Ohio 45066 USA

Internet: <http://www.pdiarm.com>
email: pdi@pdiarm.com

PH: 937-743-6010
FX: 937-743-5664