



Persona[®] P14W
Arm-Mounted, Healthcare-Grade LCD HDTV

Document Number: PD196-239R3

	MODEL NUMBER: PDI-P14W	Document Number: PD196-239R3
	Service Manual	Page 1 of 13

 <p>This symbol indicates that dangerous voltage constituting a risk of electric shock is present within this unit.</p>	 <div style="background-color: black; color: white; padding: 5px; text-align: center;"> CAUTION RISK OF ELECTRIC SHOCK, DO NOT OPEN! </div>	
 <p>This symbol indicates that there are important operating and maintenance instructions in the literature accompanying this unit.</p>	CAUTION: TO REDUCE THE RISK OF ELECTRIC SHOCK, DO NOT REMOVE COVER. NO USER SERVICEABLE PARTS INSIDE. REFER SERVICING TO QUALIFIED SERVICE PERSONNEL	

This Service Manual is intended for use by qualified service persons possessing an adequate background in electrical equipment, electronic devices, and mechanical systems. In any attempt to repair a major product, personal injury and property damage can result. The manufacturer or seller maintains no liability for the interpretation of this information, nor can it assume any liability in conjunction with its use. When servicing this product, under no circumstances should the original design be modified or altered without permission from PDi. Unauthorized modifications will not only void the warranty, but may also lead to property damage or user injury.

Copyright, Disclaimer, and Trademarks

Copyright

PDi Communication Systems, Inc. claims proprietary right to the material disclosed in this service manual. This manual is issued in confidence for servicing information only and may not be used to manufacture anything shown herein. Copyright by PDi Communication Systems, Inc. All rights reserved.

Disclaimer

The author and publisher have used their best efforts in preparing this manual. PDi Communication Systems, Inc. makes no representation or warranties with respect to the accuracy or completeness of the contents of this manual and specifically disclaim any implied warranties of merchantability or fitness for any particular purpose and shall in no event be liable for any loss of profit or any other damages, including but not limited to special, incidental, consequential or other damages. The information contained herein is believed accurate, but is not warranted, and is subject to change without notice or obligation.

Trademarks

All brand names and product names used in this manual are trademarks, registered trademarks, or trade names of their respective holders.

PDi is a registered trademark of PDi Communication Systems, Inc., Springboro, Ohio.

Dolby Digital Manufactured under license from Dolby Laboratories. "Dolby" and the double-D symbol are trademarks of Dolby Laboratories.

Regulatory Information

FCC

This equipment has been tested and found to comply with the limits for a Class A digital device, pursuant to part 15 of the FCC Rules. These limits are designed to provide reasonable protection against harmful interference when the equipment is operated in a commercial environment. This equipment generates, uses, and can radiate radio frequency energy and, if not installed and used in accordance with the instruction manual, may cause harmful interference to radio communications. Operation of this equipment in a residential area is likely to cause harmful interference in which case the user will be required to correct the interference at his own expense.

	MODEL NUMBER: PDI-P14W	Document Number: PD196-239R3
	Service Manual	Page 2 of 13

Underwriters Laboratories



The model PDI-P14W TV Hospital Grade TV Receiver is a specialized television. This TV is intended for entertainment and educational purposes for use in a hospital, a nursing home, a medical-care center, or a similar health-care facility in which installation is limited to a non-hazardous area in accordance with the National Electrical Code.

This device is safety tested and listed by the Underwriters Laboratories as a product suitable for use in health care facilities in both the United States and Canada.

ESD Notice (Electrostatic Discharge)

Today's electronics are electrostatic discharge (ESD) sensitive. ESD can weaken or damage the electronics in a manner that renders them inoperative or reduces the time until their next failure. Connect an ESD wrist strap to a ground connection point or unpainted metal in the product. Alternatively, you can touch your finger repeatedly to a ground connection point or unpainted metal in the product. Before removing a replacement part from its package, touch the anti-static bag to a ground connection point or unpainted metal in the product. Handle the electronic control assembly by its edges only. When repackaging a failed electronic control assembly in an anti-static bag, observe these same precautions.

Product Safety Servicing Precautions

1. **POWER SOURCE** Use only a power source indicated for use with this product. This TV will operate on either DC or AC voltage. To avoid personal injury, disconnect the power before servicing this product. If electrical power is required for diagnosis or test purposes, disconnect the power immediately after performing the necessary checks.
2. **REPLACEMENT** Replace only with the part number specified.
3. **VOLTAGE CHECKS** Exercise care when making voltage and waveform checks to prevent costly short circuits from damaging the unit.
4. **METAL OBJECTS** Be cautious of lost screws and other metal objects to prevent a possible short in the circuitry.
5. **SAFETY CHECKS** This hospital grade television requires special safety checks before returning to service. Observe and follow the "Safety Check" section in this service manual.
6. **DANGER: ARM RECOIL HAZARD** The safety brake pin must remain in the SAFETY BRAKE PIN HOLE whenever the television set is removed from the arm or when the arm is removed from the wall bracket to prevent the arm from springing open.



 <small>Communication Systems, Inc</small> <i>Your Source for Healthcare and Wellness Infotainment™</i>	MODEL NUMBER: PDI-P14W	Document Number: PD196-239R3
	Service Manual	Page 3 of 13

Copyright, Disclaimer, and Trademarks.....	1
Regulatory Information.....	1
Product Safety Servicing Precautions.....	2
PDI-P14W Specifications.....	4
Disinfecting and Cleaning.....	5
Checking Points to Consider.....	5
Product Identification.....	5
Disassembly.....	6
Swivel.....	6
Back Cover.....	7
Speakers.....	7
Board Removal.....	8
Parts List.....	8
Test Points.....	9
Power Board.....	9
LED Backlight Board.....	10
Headphone Board.....	10
Basic Troubleshooting Steps.....	11
Reassembly.....	12
Safety Checks.....	13

 PDi Communication Systems, Inc. <i>Your Source for Healthcare and Wellness Infotainment™</i>	MODEL NUMBER: PDI-P14W	Document Number: PD196-239R3
	Service Manual	Page 4 of 13

PDI-P14W Specifications

PANEL	
Diagonal Size	14.0"
HDTV compatible	Yes
Backlight Type	LED
Display Resolution	1366 x 788
Luminance	300 nits
Contrast Ratio	500:1
Viewing Angle	45°H, 15°V-up, 35°V-down
Response Time	8 ms
Panel Lamp Life	50K Hours (modified LED Rails)
Color Range	262k
TV FEATURES	
Parental Control (V-CHIP)	Yes
Auto Power On	Yes
Bed A/B	Yes
Guide Menu Selection of Sources	Yes
Channel Enable/Disable	Yes
Clone Programmable (By USB)	Yes
Prodiom/MPEG4	Yes
FM Tuner	Yes
2D digital Comb Filter	Yes
3:2 Pull Down Compensation	Yes
Channel	All channels for ATSC and NTSC
Menu OSD	English/French/Spanish
Progressive Scan	Yes
Antenna Input-Coax	1(75ohm Unbalanced Female F)
Factory Reset	Yes
Selectable Pillow Speaker	No
Universal Pillow Speaker Recognition	No
Programmable Source Selection by Naming	No
Sleep Timer	Yes, using remote
Aspect Ratio Control	16:9, 14:9, 4:3, 16:9 Panoramic
Keypad	Capacitive Touch
Keypad Backlight	Yes, with adjustable brightness
Hand Grip	Yes
Protective Panel	Yes, Chemically strengthened
VIDEO	
NTSC Tuner (Silicon Type)	Air VHF/UHF, CATV,IRC,HRC
ATSC Tuner (Silicon Type)	Air VHF/UHF, CATV,IRC,HRC
QAM in the clear	Air VHF/UHF, CATV,IRC,HRC
Supported Formats	1080p/1080i/720p/480p/480i
AUDIO	
Speakers	2@1-Watt RMS
Analog	Mono/Stereo/SAP
Digital	Multilingual
Front Headphone	Yes, 1/8" jack

HEALTHCARE SPECIFIC AUDIO FEAT.	
Audio Volume Limiter (AVL)	Yes
Internal Speaker Disable	Yes
Min/Max Volume Limiter	Yes
Start/Power-on Volume	Yes
INPUT/OUTPUT CONNECTORS	
RF Input	Yes
HDMI with HDCP	Yes,2
VGA Input	Yes
PC Audio Input	Yes
Component Video Input	Yes
Audio L/R Input	Yes
Digital Audio Output	No
Analog Audio Output	No
S-Video Input	No
Composite Input	Yes
Composite Output	No
Pillow Speaker Jack	No
SD Memory Card	No
USB Port	Yes, Cloning and Firmware Updates
CCI/MTI	Yes
POWER	
Source	Power over Coax
Voltage Input	18-34VAC, 18-32VDC
Consumption	15W
ACCESSORIES	
User's Manual	Yes
Warranty	Yes, online warranty registration
REGULATORY	
UL/cUL	Yes
Healthcare Grade UL60065	Yes
FCC	Yes
DIMENSIONS	
Weight (Net/Gross) Lbs. (Kg)	7 lbs. (3.175 kg)
Unit Dimension(W/H/D) Inches (cm)	14.5" x 11" x 1.94" (36,9cm x 27.9cm x 4.8cm)
WARRANTY	
Standard	2 years
GVS – Gold Vision Service (Optional)	4 years

 PDi Communication Systems, Inc. Your Source for Healthcare and Wellness Infotainment™	MODEL NUMBER: PDI-P14W	Document Number: PD196-239R3
	Service Manual	Page 5 of 13

Disinfecting and Cleaning

The P14W should be disinfected before performing any service. The following procedure is only a recommendation. Your hospital or company may have a different procedure to follow.

 **Caution:** Before using any cleaning or disinfecting agent on the P14W, perform a spot check by wetting a small area of the cabinet. Verify the agent does not discolor or deteriorate the cabinet.

1. The P14W has been designed to withstand up to a 5% chlorine based disinfectant. Many alcohol and ammonia based disinfectants have also been tested with success. Apply the cleaner or disinfectant per its recommended instructions.

Note: Most disinfectants require a waiting time following application and prior to wipe-down.

2. The manufacturer recommends isopropyl alcohol for the cleaning of the LCD screen.

Checking Points to Consider

Dynamic picture adjustments to Brightness, Contrast, Color, and Tint are available using the IR Remote Control, Part number PD108-420, using the SETUP/Picture menu.

1. Check the appearance of the replacement panel and circuit boards for both physical damage and part number accuracy.
2. Check the model label. Verify model names and board model matches.
3. Check details of defective condition and history. Contact PDi with serial number for details.

Product Identification

Product Label

The P14W is easily identified using the product label located on the back cabinet housing.

Serial Number Format Explanation

1. The first two digits compose the year of manufacture. 2012 would be 12.
2. The second two digits compose the week of manufacture. 38 would be week 38.
3. The single alphabetic character represents the place of manufacturing.
4. The next three alphanumeric characters compose the unique model ID.
5. The next five digits compose the serial number starting with the first unit produced in the current year.
6. The last character is the revision level.

 PDi
 Communication Systems, Inc.
 40 Greenwood Lane
 Springboro, Ohio 45066 USA

 LISTED
 Hospital Grade
 LCD TV Receiver
 E136994
 2L94

Persona™ P14W

RATED: 24V ~ 60Hz 15W

THIS DEVICE COMPLIES WITH PART 15 OF THE FCC RULES. OPERATION IS SUBJECT TO THE CONDITION THAT THIS DEVICE DOES NOT CAUSE HARMFUL INTERFERENCE.

WARNING

RISK OF ELECTRIC SHOCK
DO NOT OPEN
QUALIFIED PERSONNEL ONLY

AVERTISSEMENT

RISQUE DE CHOC ÉLECTRIQUE
NE PAS OUVRIR
PERSONNEL QUALIFIÉ SEULEMENT

SN: **MODEL: PDI-P14W**

1238-A012-04675-G **Manufactured: September 12**

 **DOLBY** Manufactured under License
DIGITAL from Dolby Laboratories.
"Dolby" and the double-D symbol are
trademarks of Dolby Laboratories



ASSEMBLED IN USA
FABRIQUE EN USA

	MODEL NUMBER: PDI-P14W	Document Number: PD196-239R3
	Service Manual	Page 6 of 13

Disassembly

Some part numbers are given in the disassembly instructions for ordering purposes.

- The TV must be removed from the arm and the swivel must be disassembled before working on the TV.
- Disconnect coax cable in arm and remove the swivel bolt securing the TV to the arm.
- Place TV on flat surface and be careful to follow ESD precautions.

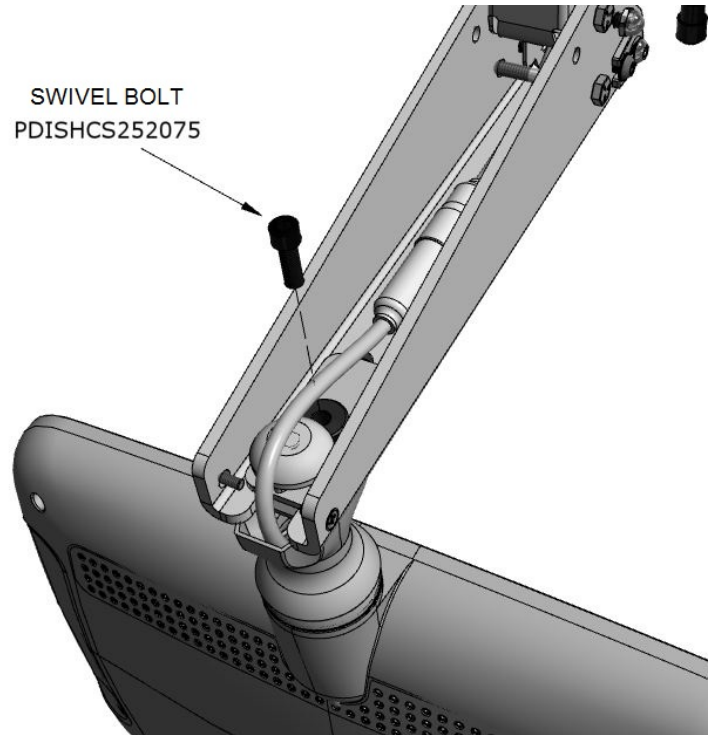

Swivel

1. Remove the cap by prying it off the washer with a flat head screwdriver.
2. Remove and dispose of the nyloc nut PDINILN3124. Replace the nyloc nut with a new part when reassembling.
3. Remove remaining parts as shown.

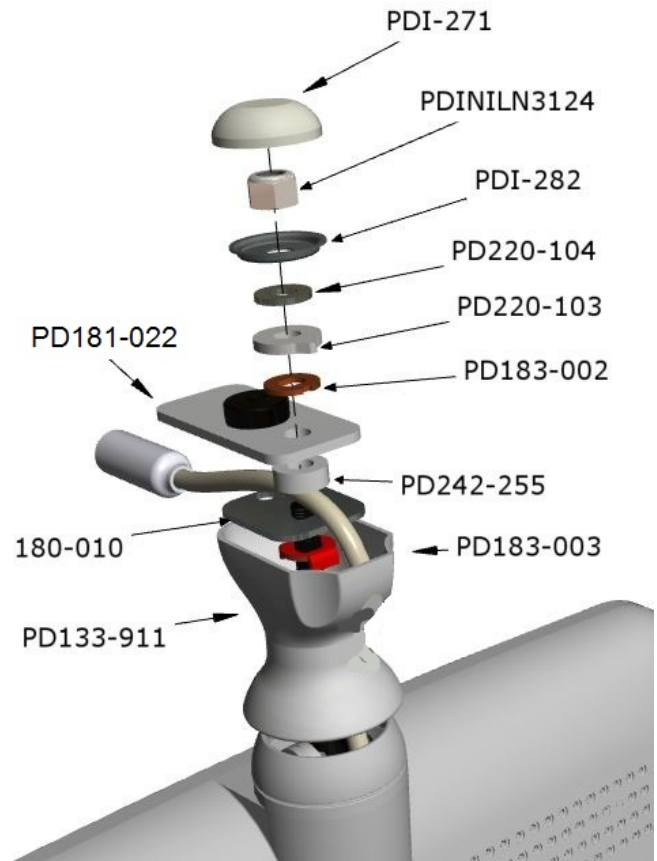

 Communication Systems, Inc. <i>Your Source for Healthcare and Wellness Infotainment™</i>	MODEL NUMBER: PDI-P14W	Document Number: PD196-239R3
	Service Manual	Page 7 of 13

Back Cover



Caution: When removing the back cover, use a pry tool (such as one sold for cell phone and tablet repair) to pop out two upper corners and avoid damage to the touch screen connector.

1. Remove (4) screws from the back cover.
2. Starting at the top of the TV, use pry tool to separate the glass from the cabinet.

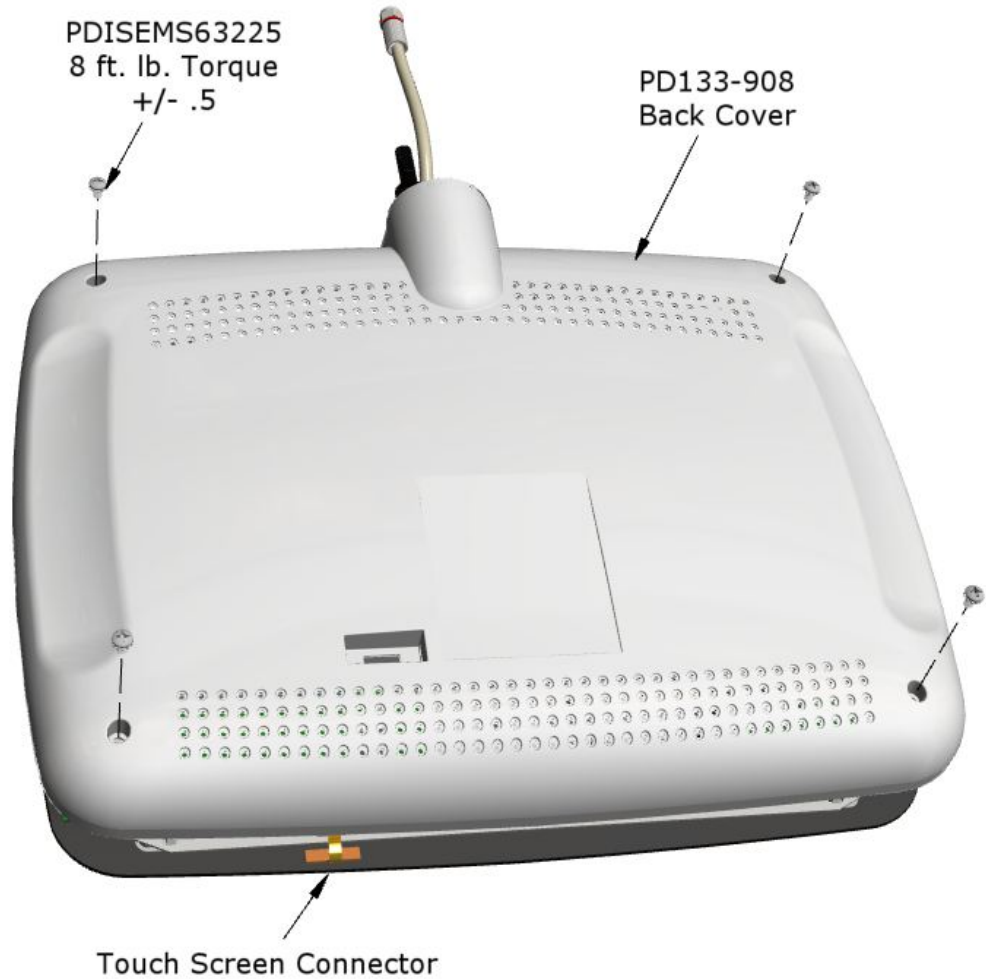

Speakers

The speakers **PD106-748** are held in place with brackets **PD185-160** and screws **PDIPPTL61925**.
 (Speaker wires are not shown)

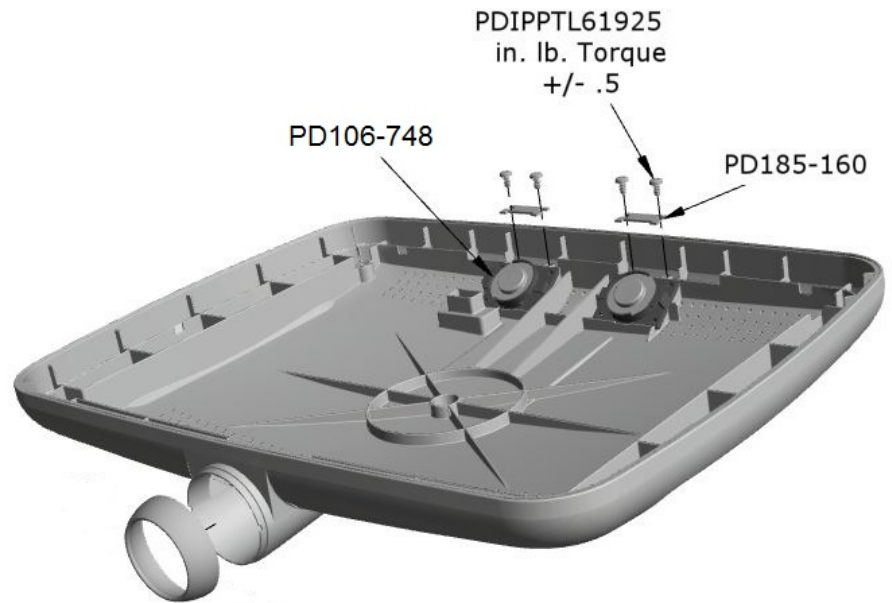

Board Removal

The main board **PD128-1725** is secured with (5) **PDISEMS44025** screws

The power board **PD128-1728** is secured with (4) **PDISEMS44025** screws

The headphone board **PD128-1716** is secured with (2) **PDISEMS44025** screws.

The LED driver board **PD128-1721** is secured with (2) **PDISEMS44025** screws.

Parts List

1. PD106-736 cable, LED panel drive
2. Backlight cable (from panel)
3. PD106-524, cable, main board to power board
4. PD106-739, cable, coax, internal
5. PD106-738, cable, headphone
6. PD106-740, cable, coax, external
7. PD106-741, cable, data
8. Optional touch screen cable (from window PD128-1727)
9. PD106-737, cable, IR/LED
10. PD128-1721, board, LED driver
11. PD128-1725, board, main
12. PD128-1728, board, power, isolated DC-DC
13. PD128-1716, board, headphone

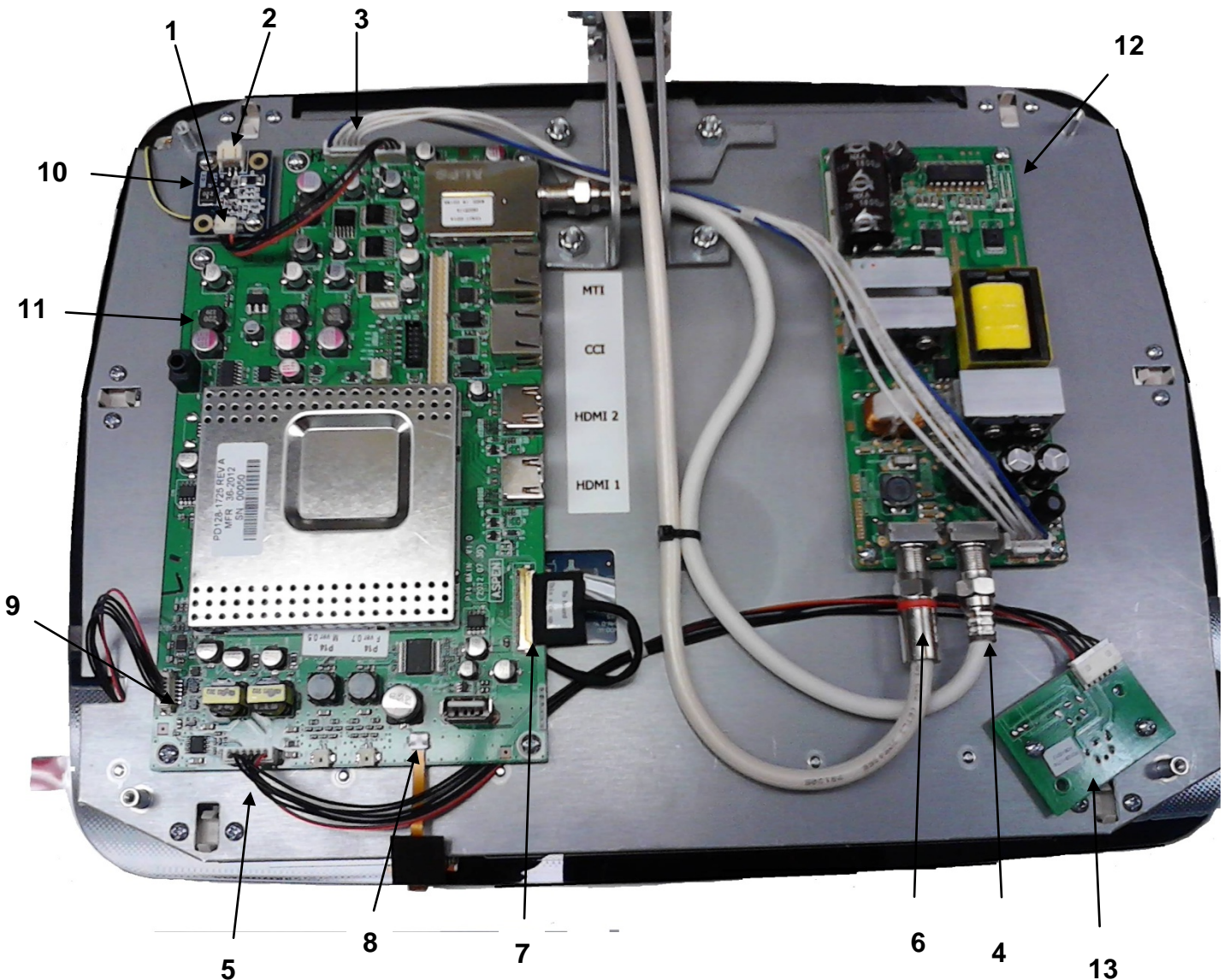

 PDi Communication Systems, Inc. Your Source for Healthcare and Wellness Infotainment™	MODEL NUMBER: PDI-P14W	Document Number: PD196-239R3
	Service Manual	Page 9 of 13

Test Points

Use the PDi coaxial AC volt/ammeter PD108-433 coaxially connected between the power supply and the unit under test.

If you have no power indicator check:

- The power at the AC source, ≈ 120 VAC
- The power out from the PDi power supply, Off ≈ 30 V @ ≈ 100 - 200 mA, On ≈ 30 V @ ≈ 600 mA
- The power out of the P14W power supply, ≈ 12.6 VDC

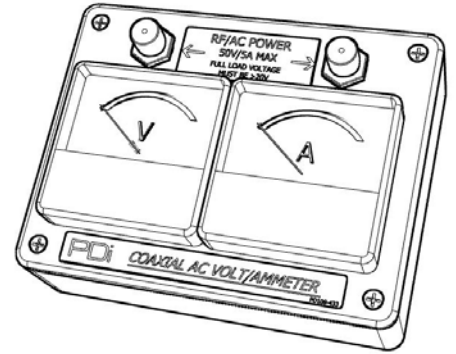

Power Board

At the power supply output, you should measure ≈ 12.6 VDC.

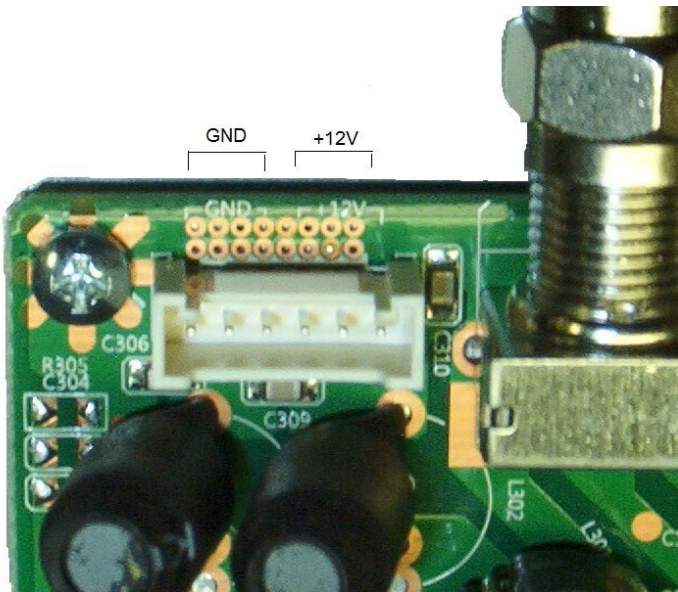

At the power supply input, measure ≈ 30 VAC between the ground leg of the RF/Power Input RF connector J102 and the test point located between capacitors C106 and C107.

LED Backlight Board

At the LED Backlight Board output (J2), you should measure $\approx 18.86\text{VDC}$.

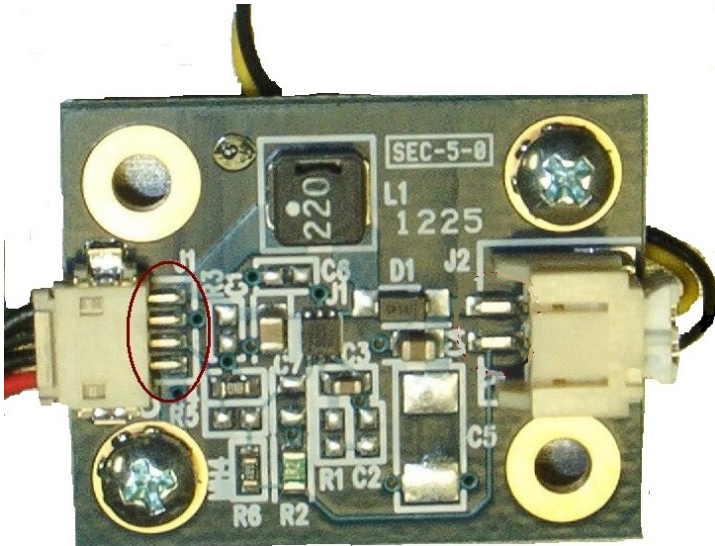

J1	PIN 1 (RED)	PIN 2	PIN 3	PIN 4
DC	TEST POINT	-3.24	0	-9.27
DC		TEST POINT	3.24	-6.04
DC			TEST POINT	-9.22

Headphone Board

At the Headphone board output (with volume at 100%) you should measure:

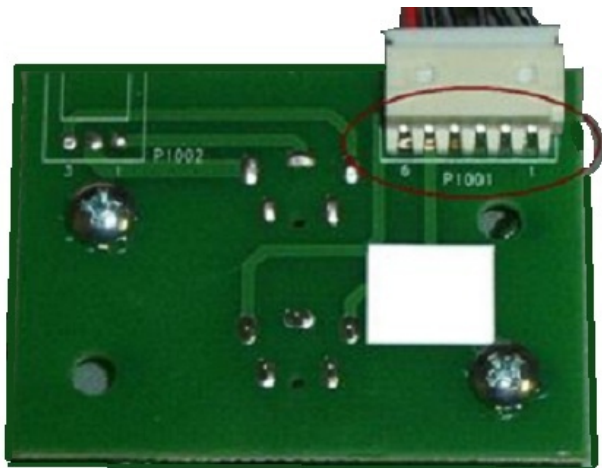

P1001

	PIN 1	PIN 2	PIN 3	PIN 4	PIN 5	PIN 6
ACV	TEST POINT	0	$\approx .9$	0	0	0
ACV		TEST POINT	$\approx .6$	0	0	0
ACV			TEST POINT	≈ 1.2	≈ 1.3	0
ACV				TEST POINT	0	0
ACV					TEST POINT	0

Note: If the power board is functional and the LED and Headphone board are not, change the main board.

 <small>Communication Systems, Inc.</small> <i>Your Source for Healthcare and Wellness Infotainment™</i>	MODEL NUMBER: PDI-P14W	Document Number: PD196-239R3
	Service Manual	Page 11 of 13

Basic Troubleshooting Steps

Many times issues can be resolved by performing a factory reset on the TV. Press and hold down “CC” button on TV and press and hold down “Last” on the remote. Hold both down simultaneously until TV displays a reset message on screen.

Symptom	Check
TV DEAD (No Power)	<ul style="list-style-type: none"> • Verify TV is connected to a coaxial powered cable • Verify coaxial cable is securely connected to F-connector • Check Power cable for voltage. • Replace power supply board (PD128-1728) • Replace main board (PD128-1725) if red LDC is lit.
NO COLOR	<ul style="list-style-type: none"> • Tune TV to another channel. Check for color • Adjust color settings in Setup/Picture menu • Verify correct voltage is used to power TV • Verify correct signal type is set in Setup/Channels menu • Perform Auto Program • Replace DATA cable (PD106-741) • Replace main board (PD128-1725) • Replace panel (PD289-126)
CANNOT TUNE TO A DESIRED CHANNEL	<ul style="list-style-type: none"> • Verify TV is connected to a coax cable that has RF signal • Verify channel is programmed into current service level • Tune to channel with remote • Tune to channel with TV keypad • Verify correct Signal type is set in Setup/Channels menu • Verify Channel Memory Override is enabled in Setup/Channels. • Verify Channel Lock is disabled • Replace main board (PD128-1725)
TV KEYPAD INOPERATIVE	<ul style="list-style-type: none"> • Verify TV is powered • Check TV operation with remote control • Verify that DATA cable is seated correctly to main chassis connector • Replace glass/keypad (PD128-1727) • Replace main board (PD128-1725)
SNOWY PICTURE	<ul style="list-style-type: none"> • Verify TV RF signal level is (0 to+10dbmv at the TV) • Tune to another channel • Verify correct Signal type is set in Setup/Channels Manual • Replace DATA cable (PD106-741) • Replace main board (PD128-1725)
NOISY PICTURE	<ul style="list-style-type: none"> • Verify TV RF signal level is (0 to+10dbmv at the TV) • Tune to another channel • Turn off nearby equipment if possible and isolate noise source • Move TV and cables to minimize or eliminate noise. • Replace main board (PD128-1725)

 <small>Communication Systems, Inc.</small> <i>Your Source for Healthcare and Wellness Infotainment™</i>	MODEL NUMBER: PDI-P14W	Document Number: PD196-239R3
	Service Manual	Page 12 of 13

PICTURE OK, NO EARPHONE SOUND	<ul style="list-style-type: none"> • Verify earphone is fully inserted into TV's earphone jack • Try a different earphone • Verify TV is not muted. Adjust for maximum volume • Replace head phone jack board (PD128-1716) • Replace main board (PD128-1725)
BLACK OR DIM PICTURE, SOUND OK	<ul style="list-style-type: none"> • Check for on-screen menu and adjust for maximum brightness • Verify DATA connector is seated on main board • Verify Backlight connectors are plugged in and secure • Replace board, LED driver (PD128-1721) • Replace DATA cable (PD106-741) • Replace main board (PD128-1725) • Replace panel (PD289-126)
PICTURE OK, NO SPEAKER SOUND	<ul style="list-style-type: none"> • Verify TV is not muted. Verify cable is seated into main chassis and into IR board • Verify earphone is not being used • Verify TV speaker has not been disabled for the current Service Level in the Sound/Internal Speaker Enable menu • Replace speaker (PD106-748) • Replace headphone jack board (PD128-1716) • Check sound. If there is still no sound, replace the main board
LOW VOLUME OR VIBRATION IN SPEAKER	<ul style="list-style-type: none"> • Check for missing or loose screw in speaker

Reassembly

Reassemble the unit in reverse manner as the disassembly paying special attention to:

- All parts removed in the repair of the TV are reassembled in original manner.
- All circuit boards should be mounted to the chassis with PDISEMS44025 screws (DO NOT over torque).
- All cables should be connected and should be routed as shown in the picture on page 8.
- When reassembling swivel, use a new 5/16-24 nyloc insert lock nut. Reusing the original nut could cause the swivel assembly to loosen over time.

Safety Checks

After re-assembly of the unit, always perform a leakage test on all exposed conductive parts such as metal connectors, chassis, and mount.

With the unit powered, the following circuit should be connected from earth ground to each exposed conductive part on the repaired unit. A DMM is placed in parallel with this circuit to measure AC rms or DC voltage. If leakage currents are greater than the maximum allowed, inspect the TV for insulation or component breakdowns.

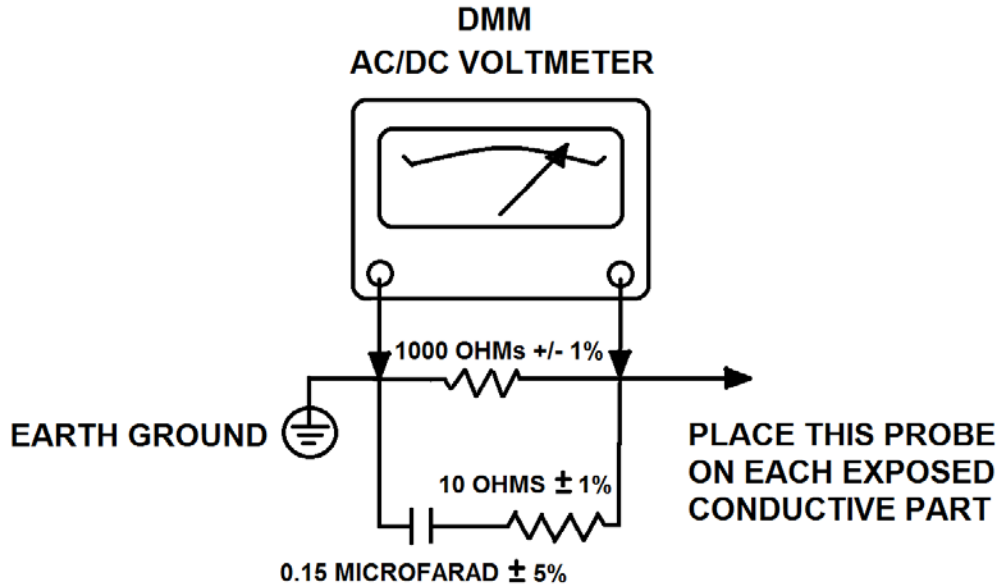

The maximum allowed leakage current depends on the type of power the unit receives and whether the unit is within reach of the patient bed/chair.

TV Type	Max Leakage Current	Max DMM Voltage Reading
Footwall TV (120VAC grounded wall outlet)	500µA AC rms	500mV AC rms
12VDC Arm Mount TV (PDI-750XL power supply)	100µA DC	100mV DC
28VAC Arm Mount TV (PDI-750A 750B or 772HE power supply)	50µA AC rms	50mV AC rms

Contact Information

For any questions with servicing PDi televisions contact our Service Department at:

PDi Communication Systems, Inc.
 40 Greenwood Ln.
 Springboro, OH 45066 USA

800-628-9870