

Atlas Copco



Industrial tools  
and solutions



# CONTENTS

 <b>PNEUMATIC ASSEMBLY TOOLS</b>	<b>3</b>	 <b>GRINDERS</b>	<b>202</b>
Pneumatic screwdrivers	6	Turbine grinders and sanders	206
Impact wrenches	17	Die grinders	209
Hydraulic impulse nutrunners – ErgoPulse	21	Straight grinders	211
Pneumatic nutrunners	31	Vertical grinders	214
		Vertical sanders	216
 <b>BOLT TIGHTENING SOLUTIONS</b>	<b>60</b>	Angle grinders	218
Tentec Airbac bolt tensioners and		Angle sanders	220
RT Advance hydraulic torque wrench system	62	Belt sanders	222
		Orbital and random orbital sanders	223
 <b>BATTERY ASSEMBLY TOOLS</b>	<b>63</b>	Dust extraction	225
BCP screwdriver, clutch type	65	Router	228
BCV nutrunner, clutch type	65	Circular cutters	229
Tensor SB nutrunners transducerized type	67		
Tensor STB nutrunners transducerized type	68	 <b>PERCUSSIVE TOOLS</b>	<b>230</b>
Tensor SRB nutrunners transducerized type	73	Chipping hammers	233
TBP nutrunners transducerized type	73	Scalers	235
		Chisels	237
 <b>ELECTRIC ASSEMBLY TOOLS</b>	<b>75</b>	Riveting systems	240
Electric screwdrivers	78	Riveting hammers	241
EBL	79	Bucking bars	243
MicroTorque	81		
Tensor ES	88	 <b>DRILLS</b>	<b>245</b>
Tensor SL	90	Pistol grip drills	247
Tensor SR	91	Straight drills	251
Electric nutrunners	95	Angle drills	253
Tensor ES	96	Modular drills	257
Tensor ST	100	Micro stop drills	260
Tensor STR	104	Tappers	262
Tensor SR	109	Positive feed drills	264
 <b>CONTROLLER AND SYSTEMS</b>	<b>120</b>	 <b>AIR LINE INFRASTRUCTURE</b>	<b>267</b>
Power Focus 6000	122	Air preparation units	270
Power Focus 600	124	Optimizer air tool oil	275
Software ToolsTalk	125	Direct lubrication units	276
Quality Integrated Fastening	126	Quick couplings	278
Station hardware	128	Claw couplings	296
Station software	129	Ball valves	297
Error proofing solutions	131	Swivel connectors	298
		Fittings	299
 <b>ASSEMBLY WORKPLACE SOLUTIONS</b>	<b>135</b>	Hoses	302
TPS Controller	137	Spiral hoses	307
Torque arms	139	Productivity kits	308
Balancers	152	Pre-mounted hose kits	309
		Hose reels	311
 <b>FIXTURED APPLICATIONS</b>	<b>155</b>	Blow guns	316
Fixture nutrunners QST	157	Test equipment	316
Fixture presses PST	161		
Controllers and software	164	 <b>AIR MOTORS</b>	<b>317</b>
Power MACS	165	Vane air motors	318
MSB, DB	166	LZB vane air motors	319
Power Focus	169	LZL vane air motors	319
Software ToolsTalk	170	Air motor support	320
 <b>QUALITY ASSURANCE AND MANUAL TIGHTENING</b>	<b>171</b>	 <b>SERVICE</b>	<b>321</b>
STpad	173	Service solutions	322
STa 6000 analyser	174	Service packages	323
Transducers	177		
Test benches	184	<b>TOOL DESIGNATIONS</b>	<b>328</b>
QA Torque Supervisor	185		
STwrench	186		
Mechanical wrenches	192		
Mechatronic system/wrenches	194		
End fittings for CWR / BWR / MWR	197		



# Your guide to the catalogue

## ACCESSORIES INCLUDED

Under this heading a specification is given for each type of tool and of the parts (nipples, keys, guards, etc.) supplied with the tool. Instructions and a list of spare parts are always included in the package.

## OPTIONAL ACCESSORIES

Here you will find the specifications for most of the accessories. They are dependent on the job the tool is to be used for and have to be ordered separately.

## AIR CONSUMPTION

The air consumption of the tools is stated in liters per second, l/s, and relates to free air, i.e., the compressed air expanded to atmospheric pressure. Unless otherwise stated, the figures are valid at a working pressure of 6.3 bar and indicate the maximum air consumption.

Maximum air consumption is valid for the tool without a speed governor when idling, i.e., when the tool is running at no load. A tool with a speed governor, has the maximum air consumption at the maximum power output.

## SPEED

The tool speeds are indicated in revolutions per minute, r/min, and indicate the idling speed, i.e., the speed at which the tool runs at no load and at a working pressure of 6.3 bar, if not otherwise specified. The speed at max. output is 50% of the idling speed for tools without a speed governor and 80 – 90% of the idling speed for tools with a speed governor.

## SELECTED SERVICE KITS TO ORDER

Under this heading, service kits for the most frequent service jobs done on the tool in question are listed.

## VIBRATION AND NOISE EMISSION

Vibration values referring to the ISO 28927 are always given as a measured vibration value and an uncertainty. The uncertainty is an indication of the spread in the vibration when measured. The spread in the in-use vibration emitted in a real work situation is at least of the same magnitude, often considerably bigger.

Vibration values referring to ISO 28927 can in many cases also be used as rough estimates of the in-use vibration values when tools are used in typical applications.

In-use vibration is influenced by factors beyond our control such as poor maintenance, pirate parts, unbalanced grinding wheels, etc.

When measuring noise, Atlas Copco uses the standard ISO 15744. The figure given in this catalogue is the measured sound pressure level. If the measured value exceeds 80 dB(A), the sound power level is

also given. The standards describe how to calculate this figure. The uncertainty in the figures from variations in the test method and production is 3 dB(A). In-use noise values close to the operator's ear may differ considerably from the given values particularly since in many applications the sound from the process is higher than the unloaded tool noise.

We, Atlas Copco Tools AB, cannot be held liable for the consequences of using the declared values, instead of values reflecting the actual exposure, in an individual risk assessment in a workplace situation over which we have no control. We recommend a program of health surveillance to detect early symptoms which may relate to noise or vibration exposure, so that management procedures can be modified to help prevent future impairment.

**For vibration and noise emission values to our products go to:**

[servaid.atlascopco.com](http://servaid.atlascopco.com)

## More catalogues

**You can find these and other publications at:**

<http://www.podshop.se/atlascopco/>

### **Bolt tightening solutions**

Article number 9833 2101 01

### **Air motors**

Article number 9833 8998 01

### **Industrial tools for fabrication and maintenance**

Article number 9833 2001 01

### **Aerospace industrial solutions**

Article number 9833 1860 01

### **Sockets and bits for industrial power tools**

Article number 9833 2018 01





# *Pneumatic assembly tools*

## **Contents**

Introduction .....	4
Screwdrivers	6
Pistol grip models .....	8
Straight models.....	12
Angle models.....	14
Impact wrenches	17
Pistol grip models .....	19
Straight models.....	20
Hydraulic impulse nutrunners	21
ErgoPulse	
Pistol grip models .....	23
Straight models.....	27
Nutrunners	31
Angle models.....	32
Straight models.....	48
Pistol grip models .....	53



## Fast, accurate and operator friendly

*Atlas Copco supplies a broad range of pneumatic assembly tools designed to give you highest possible productivity on your assembly line. The result of decades of development, the tools include ergonomically designed screwdrivers, pulse tools, nutrunners and impact wrenches, that offer superior productivity. High productive tools means less air consumption that translates into big energy savings since energy consumption and CO<sub>2</sub> emissions are reduced. Vibration and noise levels are minimized, power-to-weight ratios are high. It all adds up to maximum operator comfort and highest individual productivity.*

### **IMPACT WRENCHES (LMS)**

Impact wrenches have unmatched speed and power-to-weight characteristics, which makes them ideal e.g. for loosening applications. They productify raw power and cover a wide torque range including both non shut-off and shut-off models. They are also reaction free.

### **IMPULSE TOOLS (ERGOPULSE PTI, XS, PTS, PTX)**

Impulse tools are the ideal choice for fast and reaction-free one-hand tightenings. They have the same advantages as impact wrenches but with higher accuracy. In addition you will get a tool with good ergonomics, which means lower sound levels and less vibrations. Pulse tools also have a longer service life. They come in non shut-off and shut-off version.

### **SCREWDRIVERS**

We offer a wide range of extremely accurate, ergonomically designed screwdrivers for all kinds of jobs involving smaller screw sizes, up to M6. All models are lubrication-free.

- **Direct drive (LUD, LUF, HRD)**  
The low cost alternative for wood and self-drilling screws.
- **Slip clutch (TWIST, LUF)**  
Best for sheet metal screws, wood screws or self-tapping screws.
- **Shut-off control (LUM)**  
Best practice in most cases, especially for machine screws and screws in plastic. Very good accuracy and lowest bit consumption.



### **NUTRUNNERS**

Suitable for all kinds of tightening tasks from 0.5 Nm, nutrunners in Atlas Copco's extensive range are extremely accurate. Due to their ergonomic designs they are also very comfortable to operate. All models are lubrication-free.

- **Angle and straight type (LTV, LTD)**  
Accurate workhorses for limited spaces suitable for high volume serial production. Very good accuracy, small angle head and possible to attach special heads. Low noise and vibration levels.
- **Pistol grip type (LMP, LTP)**  
High torque tools for super fast, accurate tightenings. Low noise, and low vibration tools for operator comfort.

### **RTP NUTRUNNERS**

Whatever your industry, if your operations include loosening or tightening heavy duty bolts, Atlas Copco's slim, lightweight RTP pneumatic nutrunner can help increase your productivity.

Among the smallest on the market, the RTP's slim gearpack gives you effortless access to bolts in cramped spaces. Tightening accuracy and repeatability are high. Noise and vibration levels are lower than in traditional impact wrenches.



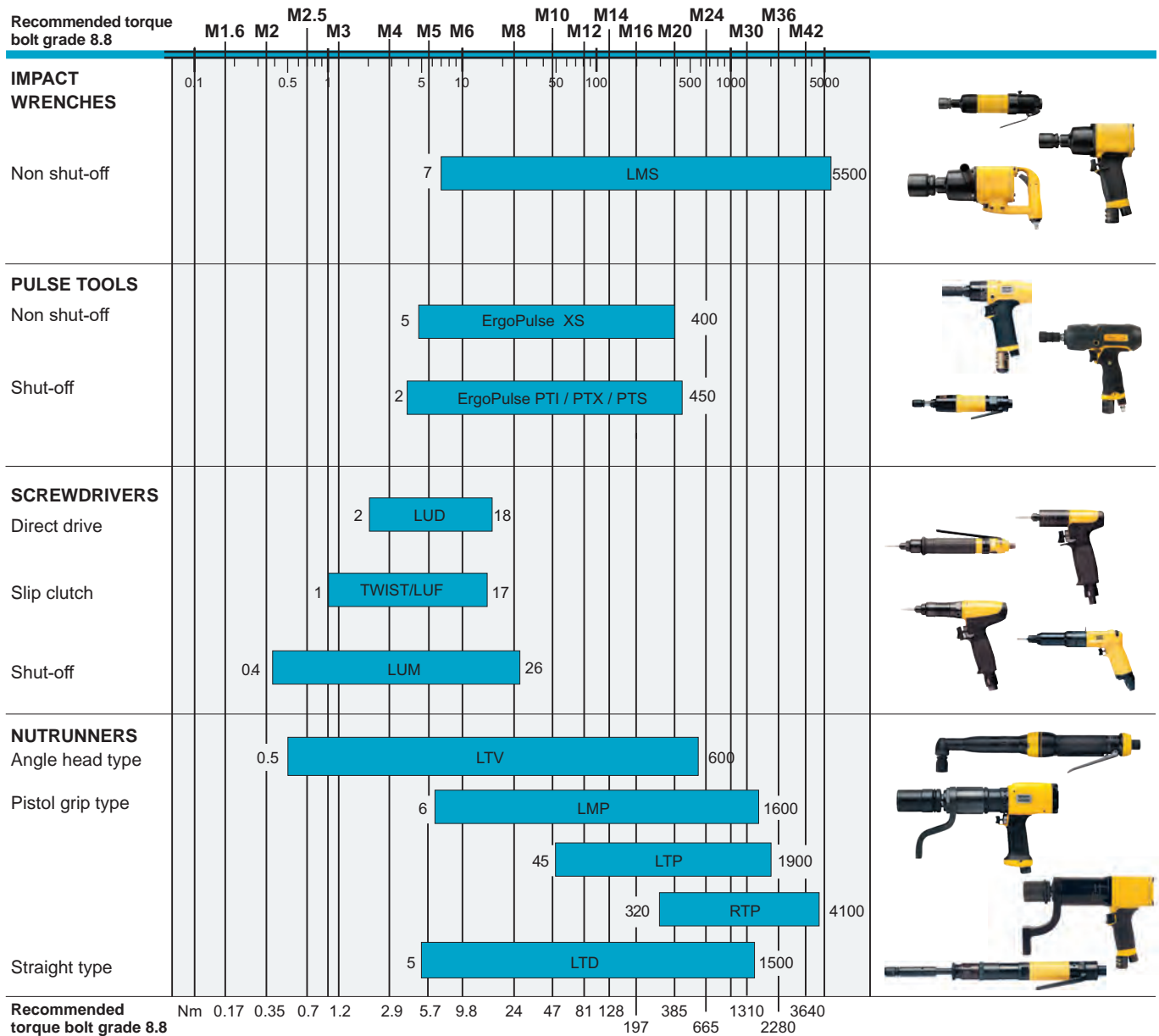

## TORQUE RECOMMENDATIONS

The torque is important to ensure the required clamping force. The table shows the recommended max tightening torque for the most common types of screws and bolts: untreated, oil-smearred screws (friction coefficient = 0.125) with metric coarse thread. The torque corresponds to approximately 62% of tensile stress.

### M-threaded screws/bolts Tightening torque Nm, according to ISO 898/1

Thread	Bolt grade							Thread	Bolt grade					
	3.6	4.6	4.8	5.8	8.8	10.9	12.9		4.6	4.8	5.8	8.8	10.9	12.9
M1.6	0.05	0.065	0.086	0.11	0.17	0.24	0.29	M14	48	58	80	128	181	217
M2	0.10	0.13	0.17	0.22	0.35	0.49	0.58	M16	74	88	123	197	277	333
M2.2	0.13	0.17	0.23	0.29	0.46	0.64	0.77	M18	103	121	172	275	386	463
M2.5	0.20	0.26	0.35	0.44	0.70	0.98	1.20	M20	144	170	240	385	541	649
M3	0.35	0.46	0.61	0.77	1.20	1.70	2.10	M22	194	230	324	518	728	874
M3.5	0.55	0.73	0.97	1.20	1.90	2.70	3.30	M24	249	295	416	665	935	1120
M4	0.81	1.10	1.40	1.80	2.90	4.00	4.90	M27	360	435	600	961	1350	1620
M5	0.60	2.20	2.95	3.60	5.70	8.10	9.70	M30	492	590	819	1310	1840	2210
M6	2.80	3.70	4.90	6.10	9.80	14.0	17.0	M36	855	1030	1420	2280	3210	3850
M8		8.90	10.50	15.0	24.0	33.0	40.0	M42	1360		2270	3640	5110	6140
M10		17.0	21.0	29.0	47.0	65.0	79.0	M45	1690		2820	4510	6340	7610
M12		30.0	36.0	51.0	81.0	114.0	136.0	M48	2040		3400	5450	7660	9190

## High accuracy, good ergonomics

*Atlas Copco pneumatic screwdrivers bring accuracy and good ergonomics into the production process, while offering robust, reliable designs. The range includes models to fit any low torque application. The tools are available in pistol grip, angle and straight configurations with drive types spanning a wide range of speeds and torques.*

In this range of pneumatic screwdrivers, the proven and patented Atlas Copco clutch design gives high torque accuracy and repeatable results over time. All screwdrivers are lightweight, with optimum non-slip grip and handle design for operator comfort. A fast shut-off clutch give minimum reaction impulse, thus reducing operator strain. All Atlas Copco screwdrivers can be used as lubrication-free.

### **A COMPLETE RANGE**

Our pneumatic screwdrivers are available in pistol grip, angle and straight configurations. The LUM, TWIST, LUF and LUD models are pistol grip and straight tools, and the LTV is an angle tool.

### **SHUT-OFF TYPE SCREWDRIVERS**

LUM and LTV models have a fast and accurate shut-off clutch for smooth performance and high quality tightening. They are suitable for joints with demands on torque accuracy, providing accurate tightening time-after-time, independent of variations in joint stiffness. Electro Static Discharge (ESD) approved models and RE models are available in this range. RE models enable a signal to be received from the tool, in order to control batch count. All RE models need to be combined with an external RE control system. Shut-off tools are the best choice for machine screws, thread-rolling screws and thread-forming screws for plastic.

### **SLIP CLUTCH TYPE SCREWDRIVERS**





TWIST and LUF HR screwdrivers have a slip clutch that applies a pulsating force when the torque level is reached. These tools are suitable where the torque level may temporarily rise during the rundown phase, for instance when using sheet metal screws, wood screws or self-tapping screws.

### **DIRECT DRIVE TYPE SCREWDRIVERS**

LUD and LUF HRD are direct drive screwdrivers that stall when final torque is reached. The torque level is adjusted by regulating the air pressure. LUD and LUF HRD are mainly used for self-drilling and wood screws.

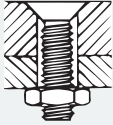
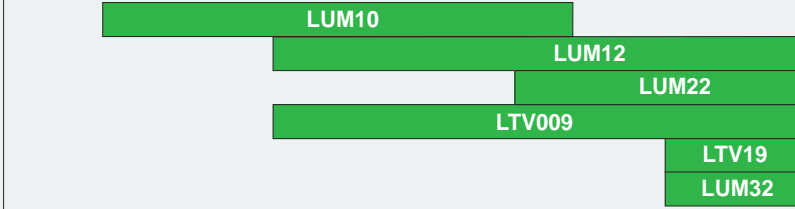
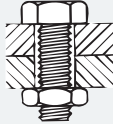
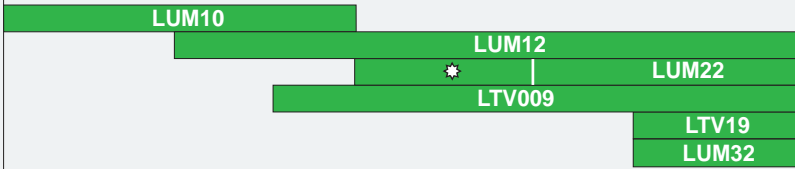
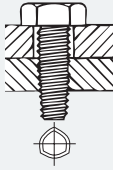
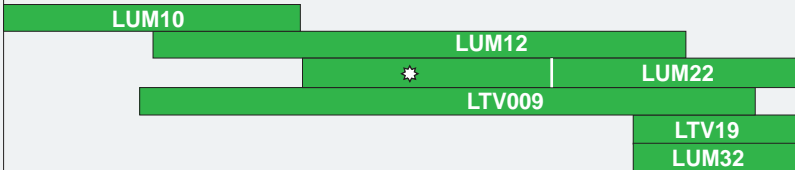
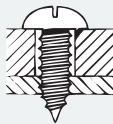

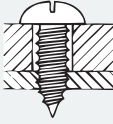
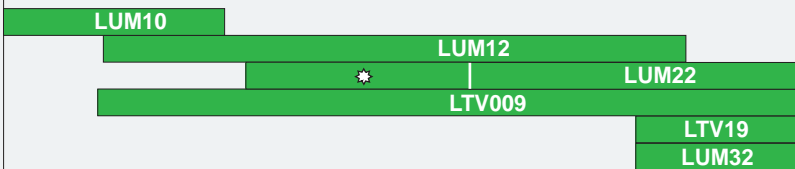
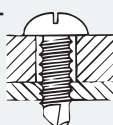

SCREW TYPE	SCREWDRIVER									
<b>Machine screw 4.8</b> Property class 4.8 normal for cross recessed and slotted screws 	Ø Screw size	M1.6	M2	M2.5	M3	M3.5	M4	M5	M6	
	Torque Nm/in lb	0.09/0.8	0.2/1.8	0.4/3.5	0.6/5.3	1.0/8.8	1.4/12.4	2.9/25.7	4.9/43.4	
	Recommended tool									
<b>Machine screw 8.8</b> Property class 8.8 normal for hexagon, Allen head and Torx®. Locking nut with plastic insert, increase torque 10%, mechanical-lock nut, increase torque 20% 	Ø Screw size	M1.6	M2	M2.5	M3	M3.5	M4	M4.5	M5	M6
	Torque Nm/in lb	0.2/1.8	0.4/3.5	0.7/6.2	1.2/10.6	1.9/16.8	2.9/25.7	4.3/38.1	5.7/50.4	9.8/86.7
	Recommended tool									
<b>Thread rolling screw-M</b> Property class between 8.8 and 10.9 due to case hardening. Taptite® and Swageform are examples 	Ø Screw size		M2		M3		M4	M5	M6	
	Torque Nm/in lb		0.5/4.4		1.4/12.4		3.2/28.3	6.5/57.5	11.0/97.3	
	Recommended tool									
<b>Thread forming screw-ST</b> for plastic 	Ø Screw size	ST2.2	ST2.9	ST3.5	ST4.2	ST4.8	ST5.5	ST6.3		
	Torque Nm/in lb	0.3/2.7	1.0/8.8	1.8/15.9	2.9/25.7	4.2/37.2	6.7/59.3	9.1/80.5		
	Recommended tool									
<b>Self drilling screw-ST</b> 	Ø Screw size	ST2.2	ST2.9	ST3.5	ST4.2	ST4.8	ST5.5	ST6.3		
	Torque Nm/in lb	0.3/2.7	1.0/8.8	1.8/15.9	2.9/25.7	4.2/37.2	6.7/59.3	9.1/80.5		
	Recommended tool									
<b>Wood screw</b> 	Torque Nm/in lb		1.5/13.3	3/26.5	5/44.2	7.5/66.4		12/106.2		
	Recommended tool									

 Shut-off clutch

 Slip clutch

 Direct drive

✳ With optional coupling-ring.

Ordering No. 4210 2316 01

✳ With optional spring.

Ordering No. 4210 1831 00

The LUM pistol grip range comes in several different configurations:

- HR: Model with traditional-grip can be used with high grip when feed force is needed or with low grip for minimal reaction force.
- HRX: Model with balanced grip perfectly balanced for standard pistol grip applications.
- HRF: Balanced grip with multiple air inlets for flexible connection.
- The LUM32 model has the highest force to weight ratio amongst the pneumatic screwdrivers. It is also a tool with low reaction force and fast shut-off because of the position of the clutch.

RE reporting models are available, designated with suffix –RE.



LUM22 HR



LUM12 HRX



LUM12 HRF



LUM32 HR

Model	Torque range soft joint		Free speed r/min	Weight		Length mm	CS distance mm	Air consumption at free speed		Rec. hose size mm	Air inlet thread in	Ordering No.
	Nm	in lb		kg	lb			l/s	cfm			
<b>With trigger start</b>												
LUM22 HR3	0.6-3	5.3-26.5	2200	0.85	1.9	186	18	7.5	16	8	1/4	8431 0269 00
LUM22 HR4	0.6-4	5.3-35.4	1650	0.85	1.9	186	18	7.5	16	8	1/4	8431 0269 02
LUM22 HR4-RE	0.6-4	5.3-35.4	1650	0.85	1.9	186	18	7.5	16	8	1/4	8431 0278 65
LUM22 HR6	1.5-6.5	13.3-57.5	1150	0.85	1.9	186	18	7.5	16	8	1/4	8431 0269 01
LUM22 HR6-RE	1.5-6.5	13.3-57.5	1150	0.85	1.9	186	18	7.5	16	8	1/4	8431 0278 64
LUM22 HR10	3.5-10	31-88.5	750	1	2.2	218	18	7.5	16	10	1/4	8431 0269 03
LUM22 HR10-RE	3.5-10	31-88.5	750	1	2.2	218	18	7.5	16	10	1/4	8431 0278 66
LUM22 HR12	3.5-12.5	31-110.6	500	1	2.2	210	18	7.5	16	10	1/4	8431 0269 04
LUM22 HR12-RE	3.5-12.5	31-110.6	500	1	2.2	210	18	7.5	16	10	1/4	8431 0278 67
LUM22 HR12-370	3.5-12.5	31-110.6	370	1	2.2	210	18	7.5	16	10	1/4	8431 0269 05
LUM32 HR10	5-10	44.2-88.5	750	0.72	1.6	183	18.5	7.5	16	10	1/4	8431 0269 90
LUM32 HR15	7.5-15.5	66-137.2	450	0.72	1.6	183	18.5	7.5	16	10	1/4	8431 0269 91
<b>With trigger and push start</b>												
LUM22 HR3-P	0.6-3	5.3-26.5	2200	0.85	1.9	186	21	7.5	16	8	1/4	8431 0269 06
LUM22 HR4-P	0.6-4	5.3-35.4	1650	0.85	1.9	186	21	7.5	16	8	1/4	8431 0269 08
LUM22 HR6-P	1.5-6.5	13.3-57.5	1150	0.85	1.9	186	21	7.5	16	8	1/4	8431 0269 07
LUM22 HR10-P	3.5-10	31-88.5	750	1	2.2	218	21	7.5	16	10	1/4	8431 0269 09
LUM22 HR12-P	3.5-12.5	31-110.6	500	1	2.2	210	21	7.5	16	10	1/4	8431 0269 10
LUM22 HR12-370-P	3.5-12.5	31-110.6	370	1	2.2	210	21	7.5	16	10	1/4	8431 0269 11

Continued...



Model	Torque range soft joint		Free speed r/min	Weight		Length mm	CS distance mm	Air consumption at free speed		Rec. hose size mm	Air inlet thread in	Ordering No.
	Nm	in lb		kg	lb			l/s	cfm			
<b>Balanced grip models with trigger start</b>												
LUM12 HRX1	0.6-1.8	5.3-15.9	2300	0.65	1.4	176	15	6	13	6	1/8	8431 0278 58
LUM12 HRX2	0.6-2.5	5.3-22.1	1650	0.65	1.4	176	16	6	13	6	1/8	8431 0278 56
LUM12 HRX3	0.4-3.5	5.3-31.9	1150	0.7	1.5	186	16	6	13	6	1/8	8431 0278 54
LUM12 HRX3-RE	0.4-3.5	3.5-31.9	1150	0.7	1.5	186	16	6	13	6	1/8	8431 0278 55
LUM12 HRX5	0.4-5	3.5-44.2	850	0.7	1.5	186	16	6	13	6	1/8	8431 0278 51
LUM12 HRX5-RE	0.4-5	3.5-44.2	850	0.7	1.5	186	16	6	13	6	1/8	8431 0278 53
LUM12 HRX5-350	0.4-5	3.5-44.2	350	0.7	1.5	186	16	6	13	6	1/8	8431 0278 48
LUM12 HRX5-350-RE	0.4-5	3.5-44.2	350	0.7	1.5	186	16	6	13	6	1/8	8431 0278 49
LUM12 HRX8	1.5-8	13.3-70.8	500	0.7	1.5	186	16	6	13	6	1/8	8431 0278 60
LUM12 HRX8-110	1.5-8	13.3-70.8	110	0.7	1.5	196	16	6	13	6	1/8	8431 0280 27
LUM12 HRX8-250	1.5-8	13.3-70.8	250	0.7	1.5	186	16	6	13	6	1/8	8431 0278 69
LUM12 HRX8-RE	1.5-8	13.3-70.8	500	0.7	1.5	186	16	6	13	6	1/8	8431 0278 61
LUM22 HRX2	1.2-2	10.6-17.7	4500	0.9	2	187	18	9	19	8	1/4	8431 0269 29
LUM22 HRX2-3200	1.1-2.6	9.7-23	3200	0.9	2	187	18	9	19	8	1/4	8431 0278 85
LUM22 HRX3	0.6-3	5.3-26.5	2250	0.9	2	187	18	9	19	8	1/4	8431 0269 22
LUM22 HRX3.5	0.6-3.5	5.3-29.2	2250	0.9	2	187	18	9	19	8	1/4	8431 0269 99
LUM22 HRX4	0.6-4	5.3-35.4	1650	0.9	2	187	18	9	19	8	1/4	8431 0269 20
LUM22 HRX6	1.5-6.5	13.3-57.5	1100	0.95	2.1	197	18	9	19	8	1/4	8431 0269 21
LUM22 HRX6-RE	1.5-6.5	13.3-57.5	1100	0.95	2.1	197	18	9	19	8	1/4	8431 0278 71
LUM22 HRX10	3.5-10	31-88.5	800	1.1	2.4	219	18	9	19	10	1/4	8431 0269 23
LUM22 HRX10-RE	3.5-10	31-88.5	800	1.1	2.4	219	18	9	19	10	1/4	8431 0278 73
LUM22 HRX11-220	3.5-12.5	31-110.6	220	1.15	2.5	229	18	9	19	10	1/4	8431 0282 20
LUM22 HRX12	3.5-12.5	31-110.6	500	1.1	2.4	211	18	9	19	10	1/4	8431 0269 24
LUM22 HRX12-RE	3.5-12.5	31-110.6	500	1.1	2.4	211	18	9	19	10	1/4	8431 0278 74
LUM22 HRX12-50	3.5-12.5	31-110.6	50	1.15	2.5	229	18	9	19	10	1/4	8431 0280 26
LUM22 HRX12-120	3.5-12.5	31-110.6	120	1.15	2.5	229	18	9	19	10	1/4	8431 0280 28
LUM22 HRX12-370	3.5-12.5	31-110.6	370	1.1	2.4	211	18	9	19	10	1/4	8431 0269 25
LUM22 HRX12-370-RE	3.5-12.5	31-110.6	370	1.1	2.4	211	18	9	19	10	1/4	8431 0278 75
LUM22 HRX26 <sup>a</sup>	3-26	26.6-230	220	1.2	2.6	233	18	9	19	10	1/4	8431 0269 39
<b>Multiple air inlet models with trigger start</b>												
LUM12 HRF2	0.6-2.5	5.3-22.1	1650	0.65	1.4	190	16	6	13	6	1/8	8431 0269 31
LUM12 HRF3	0.4-3.6	3.5-31.9	1150	0.7	1.5	200	16	6	13	6	1/8	8431 0269 32
LUM12 HRF5	0.4-5	3.5-44.2	850	0.7	1.5	200	16	6	13	6	1/8	8431 0269 33
LUM12 HRF8	1.5-8	13.3-70.8	500	0.7	1.5	200	16	6	13	6	1/8	8431 0269 34

<sup>a</sup> 1/4" square drive.

**All models:** Are reversible and have quick change chuck.

All data at an air pressure of 6.3 bar.

For operator comfort a support handle is recommended for high torque, see Optional Accessories.

The LUD and LUF pistol grip range comes in several different configurations:

- HR/HRD: Model with traditional-grip can be used with high grip when feed force is needed or with low grip for minimal reaction force.
- HRX: Models with balanced grip are perfectly balanced for standard pistol grip applications.



Model	Torque range soft joint		Free speed r/min	Weight		Length mm	CS distance mm	Air consumption at free speed		Rec. hose size mm	Air inlet thread in	Ordering No.
	Nm	in lb		kg	lb			l/s	cfm			
<b>With trigger start</b>												
LUD12 HRX2	1-2.5	8.8-22.1	1600	0.5	1.1	115	16	6.5	14	8	1/8	8431 0278 77
LUD12 HRX5	2-5	17.7-44.2	850	0.5	1.1	125	16	6.5	14	8	1/8	8431 0278 78
LUD12 HRX8	3.5-8	31.0-70.8	500	0.5	1.1	125	16	6.5	14	8	1/8	8431 0278 79
LUD22 HR3	1.5-2.8	13.3-24.8	3600	0.65	1.4	125	18	8	17	8	1/4	8431 0269 17
LUD22 HR5	2.8-5.5	24.8-48.7	1650	0.65	1.4	125	18	8	17	8	1/4	8431 0269 18
LUD22 HR12	5-12	44.2-106.2	750	0.75	1.7	143	18	8	17	8	1/4	8431 0269 19
LUF34 HRD04	8.0-18.0	71-160	440	1.2	2.6	212	20	9	19	10	1/4	8431 0311 22
LUF34 HRD08	8.0-11.0	71-97	750	1.2	2.6	212	20	9	19	10	1/4	8431 0311 24
LUF34 HRD16	4.0-8.0	35-71	1600	0.9	2.0	179	20	9	19	10	1/4	8431 0311 26
<b>Reversible drill, tapper and screwdriver</b>												
COMBI22 HR2	2.0-2.7	18-24	3600	0.9	2.0	205	20	7	15	8	1/4	8431 0255 89
COMBI22 HR5	2.7-5.7	24-50	1600	0.9	2.0	205	20	7	15	8	1/4	8431 0255 80
COMBI22 HR10	5.0-10.0	44-89	800	1.1	2.4	240	20	7	15	8	1/4	8431 0255 62
COMBI34 HR04	8.0-18.0	71-160	400	1.5	3.3	228	20	9	19	10	1/4	8431 0311 32
COMBI34 HR08	8.0-11.0	71-97	750	1.3	2.9	218	20	9	19	10	1/4	8431 0311 34
COMBI34 HR16	4.0-8.0	35-71	1600	1.0	2.2	179	20	9	19	10	1/4	8431 0311 36

**All models:** Are reversible.  
 Are equipped with a 1/4" female hexagon drive for bits.  
 Combi-tools are delivered with drill chuck and 1/4" female hex drive for bits.  
 Torque range is reached by adjusting the air pressure between minimum 3 bar and maximum 6 bar.



The TWIST and LUF pistol grip range comes in several different configurations:

- HR: Model with traditional-grip can be used with high grip when feed force is needed or with low grip for minimal reaction force.
- HRX: models with balanced grip are perfectly balanced for standard pistol grip applications.
- HRF: Balanced grip with multiple air inlets for flexible connection.



Model	Torque range soft joint		Free speed r/min	Weight		Length mm	CS distance mm	Air consumption at free speed		Rec. hose size mm	Air inlet thread in	Ordering No.
	Nm	in lb		kg	lb			l/s	cfm			
<b>With trigger and push start</b>												
TWIST12 HRX2	0.6-2.4	5.3-21.2	1650	0.65	1.4	176	15	6.5	14	6	1/8	8431 0278 40
TWIST12 HRX3	0.6-3.5	5.3-31.0	1150	0.65	1.4	186	15	6.5	14	6	1/8	8431 0278 39
TWIST12 HRX4	0.5-4.4	4.4-38.9	800	0.65	1.4	186	15	6.5	14	6	1/8	8431 0278 38
TWIST22 HRX7	1.5-7.5	13.3-66.4	1100	1.05	2.3	205	15	9	19	8	1/4	8431 0269 26
TWIST22 HRX10	1.5-10	13.3-88.5	750	1.1	2.4	205	15	9	19	8	1/4	8431 0269 27
TWIST22 HRX12	5-12	44.2-106.2	500	1.05	2.3	205	15	9	19	8	1/4	8431 0269 28
TWIST22 HR3	1.0-3.5	8.9-31	2100	0.95	2.1	195	15	8	17	8	1/4	8431 0278 86
TWIST22 HR6	2.2-6.5	19.5-57.5	1600	0.95	2.1	195	15	8	17	8	1/4	8431 0269 70
TWIST22 HR7	1.5-7.5	13.3-66.4	1150	0.95	2.1	195	15	8	17	8	1/4	8431 0269 14
TWIST22 HR10	1.5-10.0	13.3-88.5	750	1	2.2	205	15	8	17	8	1/4	8431 0269 15
TWIST22 HR12	5.0-12.0	44.2-106.2	500	1	2.2	195	15	8	17	8	1/4	8431 0269 16
LUF34 HR04	3.0-17.0	27.0-150.0	440	1.4	3.1	265	21	9.5	19	8	1/4	8431 0311 05
LUF34 HR08	2.0-15.0	18.0-133.0	750	1.4	3.1	265	21	9.5	19	8	1/4	8431 0311 09
LUF34 HR16	3.0-12.0	27.0-107.0	1600	1.4	3.1	265	21	9.5	19	8	1/4	8431 0311 17
<b>Multiple air inlet models and air-on-top models with trigger start and push start</b>												
TWIST12 HRF4	0.5-4.4	4.4-38.9	850	0.7	1.5	200	15	6.5	14	6	1/8	8431 0269 40

**All models:** Are reversible.  
Are equipped with a 1/4" female hexagon drive for bits.  
Have quick change chuck.  
All data at an air pressure of 6.3 bar.

Straight screwdrivers should be used with a torque arm for best ergonomics.

LUM straight screwdrivers come in two different configurations:

- PR: Model with push-to-start function and reverse button.
- SR: Model with lever start function and reverse ring.

RE reporting conversion kits are available for SR models, see accessory page.

Soft stop options are available, designated with the suffix -SS.



LUM12 PR



LUM12 SR

Model	Torque range soft joint		Free speed r/min	Weight		Length mm	CS distance mm	Air consumption at free speed		Rec. hose size mm	Air inlet thread in	Ordering No.
	Nm	in lb		kg	lb			l/s	cfm			
<b>With push start and button reverse</b>												
LUM10 PR03	0.1-1.5	0.8-13	300	0.4	0.9	206	15	3	6	6	1/8	8431 0146 05
LUM10 PR05	0.1-1.5	0.8-13	460	0.4	0.9	206	15	3	6	6	1/8	8431 0146 09
LUM10 PR12	0.1-1.1	0.8-10	1200	0.4	0.9	196	15	3	6	6	1/8	8431 0146 17
LUM10 PR21	0.1-0.7	0.8-6	2000	0.4	0.9	196	15	3	6	6	1/8	8431 0146 25
LUM12 PR1	0.6-1.6	5.3-14.2	1900	0.55	1.2	195	17	4.5	10	6	1/8	8431 0278 29
LUM12 PR2	0.4-2.3	3.5-20.4	1450	0.55	1.2	195	17	4.5	10	6	1/8	8431 0278 27
LUM12 PR3	0.4-3.2	3.5-28.3	1000	0.55	1.2	195	17	4.5	10	6	1/8	8431 0278 26
LUM12 PR4	0.4-4.2	3.5-37.2	750	0.55	1.2	195	17	4.5	10	6	1/8	8431 0278 25
LUM12 PR5	0.4-5	3.5-44.2	450	0.55	1.2	195	20	4.5	10	6	1/8	8431 0278 30
LUM22 PR2-3500	1.1-2.5	9.7-22.1	3500	0.75	1.7	211	20	7	15	8	1/4	8431 0278 89
LUM22 PR3	0.6-3.2	5.3-28.3	2100	0.75	1.7	211	20	7	15	8	1/4	8431 0269 61
LUM22 PR4	0.5-4.0	4.4-35.4	1600	0.75	1.7	211	20	7	15	8	1/4	8431 0269 55
LUM22 PR4-2300	0.7-4.5	5.9-38.2	2300	0.75	1.7	211	20	7	15	8	1/4	8431 0278 81
LUM22 PR5-260	0.4-5.0	3.5-44.2	260	0.75	1.7	211	20	7	15	8	1/4	8431 0269 62
LUM22 PR5-350	0.4-5.0	3.5-44.2	350	0.75	1.7	211	20	7	15	8	1/4	8431 0269 60
LUM22 PR6	1.5-6.0	13.3-53.1	1000	0.75	1.7	211	20	7	15	8	1/4	8431 0269 56
LUM22 PR8-1100	1.5-8.0	13.3-70.8	1100	0.9	2.0	224	20	7	15	8	1/4	8431 0278 88
LUM22 PR10	3.5-10.0	31-88.5	700	0.95	2.1	232	22	7	15	8	1/4	8431 0269 58
LUM22 PR12	3.5-12.5	31-110.6	450	0.9	2.0	224	22	7	15	8	1/4	8431 0269 57
LUM22 PR12-350	3.5-12.5	31-110.6	350	0.95	2.1	224	22	7	15	8	1/4	8431 0269 59
LUM22 PR12-850	3.5-12.0	31-106.2	850	1	2.2	246	22	8.5	15	8	1/4	8431 0278 80
<b>With lever start and reverse ring</b>												
LUM12 SR1	0.6-1.8	5.3-15.9	2200	0.6	1.3	217	17	6	13	6	1/8	8431 0278 35
LUM12 SR2	0.5-2.5	4.4-22.1	1700	0.6	1.3	217	17	6	13	6	1/8	8431 0278 34
LUM12 SR3	0.4-3.5	3.5-31	1200	0.6	1.3	217	17	6	13	6	1/8	8431 0278 33
LUM12 SR4	0.4-4.5	3.5-39.8	850	0.6	1.3	217	17	6	13	6	1/8	8431 0278 32
LUM22 SR3	0.6-3.2	5.3-28.3	1950	0.8	1.8	239	20	7	15	8	1/4	8431 0269 44
LUM22 SR4	0.6-4	5.3-35.4	1500	0.8	1.8	239	20	7	15	8	1/4	8431 0269 46
LUM22 SR5-300	0.4-5	3.5-44.2	300	0.8	1.8	239	20	7	15	8	1/4	8431 0269 51
LUM22 SR6	1.5-6	13.3-53.1	1000	0.85	1.9	239	20	7	15	8	1/4	8431 0269 47
LUM22 SR10	3.5-10	31-88.5	700	1	2.2	260	22	7	15	8	1/4	8431 0269 49
LUM22 SR12	3.5-12.5	31-110.6	430	0.95	2.1	252	22	7	15	8	1/4	8431 0269 48
LUM22 SR12-300	3.5-12.5	31-110.6	300	1	2.2	252	22	7	15	8	1/4	8431 0269 50

All LUM10/12/22 SR/PR: ESD approved  
All data at an air pressure of 6.3 bar.

Straight screwdrivers should be used with a torque arm for best ergonomics

The TWIST straight screwdrivers come in two different configurations:

- PR: Model with push to start function and reverse button
- SR: Model with lever start function and reverse ring.



**TWIST12 SR**

Model	Torque range soft joint		Free speed r/min	Weight		Length mm	CS distance mm	Air consumption at free speed		Rec. hose size mm	Air inlet thread in	Ordering No.
	Nm	in lb		kg	lb			l/s	cfm			
<b>With lever start and reverse ring</b>												
TWIST12 SR4	0.5-4.2	4.4-37.2	1100	0.65	1.4	225	15	6	13	6	1/8	8431 0278 43
TWIST22 SR6	1.5-6.0	13.3-53.1	1500	0.85	1.9	239	15	7	15	8	1/8	8431 0269 52
TWIST22 SR10	1.5-10.0	13.3-88.5	700	0.9	2.0	246	15	7	15	8	1/8	8431 0269 53
<b>With push start and reverse button</b>												
TWIST22 PR4-2300	1.0-4.0	8.9-35.4	2300	0.75	1.7	242	15	7	15	8	1/4	8431 0278 92
TWIST22 PR6	2.2-6.5	19.5-57.5	1600	0.75	1.7	211	15	7	15	8	1/4	8431 0278 91
TWIST22 PR7	1.5-7.5	13.3-66.4	1100	0.75	1.7	211	15	7	15	8	1/4	8431 0278 90

All data at an air pressure of 6.3 bar.



LTV angle screwdriver models have a fast, accurate shut-off clutch and are designed for durability.

- Slim design of the angle head allows good access in limited spaces and awkward positions.
- Spiral cut gears give high accuracy.

RE reporting conversion kits are available for LTV screwdriver models. For kit, see accessory page.



LTV009

Model	Torque range soft joint		Free speed r/min	Weight		Length mm	Angle head height mm	Angle head center to side mm	Air consumption at free speed		Rec. hose size mm	Air inlet thread in	Ordering No.
	Nm	in lb		kg	lb				l/s	cfm			
<b>1/4" female hexagon drive for bits</b>													
LTV009 R05-42	0.4-5	3.5-44.2	850	0.7	1.5	266	25	9	6	13	6	1/8	8431 0278 07
LTV009 R07-42	1.1-7	9.7-61.9	500	0.7	1.5	266	25	9	6	13	6	1/8	8431 0278 10
LTV009 R07-42-SH	1.1-7	9.7-61.9	500	0.7	1.5	243	25	9	6	13	6	1/8	8431 0279 29
LTV009 R09-42	1.3-9	11.5-79.6	430	0.7	1.5	266	28.5	11	6	13	6	1/8	8431 0278 15
LTV009 R11-42	1.3-11	11.5-97.3	320	0.8	1.8	266	28.5	11	6	13	6	1/8	8431 0278 21
LTV009 R035-42	0.4-3.5	3.5-31	1100	0.7	1.5	266	25	9	6	13	6	1/8	8431 0278 04
LTV19 R15-42	6-15	54-133	360	1.1	2.4	309	36	11	7	15	8	1/4	8431 0279 35
<b>1/4" square drive for sockets</b>													
LTV009 R05-6	0.4-5	3.5-44.2	850	0.7	1.5	266	25	9	6	13	6	1/8	8431 0278 08
LTV009 R07-6	1.1-7	9.7-61.9	500	0.7	1.5	266	25	9	6	13	6	1/8	8431 0278 11
LTV009 R07-6-SH	1.1-7	9.7-61.9	500	0.7	1.5	243	25	9	6	13	6	1/8	8431 0279 28
LTV009 R07-6-230	0.3-7	2.6-61.9	230	0.8	1.8	266	25	9	6	13	6	1/8	8431 0279 18
LTV009 R09-6	1.3-9	11.5-79.6	430	0.7	1.5	266	28.5	11	6	13	6	1/8	8431 0278 17
LTV009 R11-6-200	1.3-11	11.5-97.3	200	0.7	1.5	266	28.5	11	6	13	6	1/8	8431 0279 32
LTV009 R11-6-200-B	1.3-11	11.5-97.3	200	0.8	1.8	266	27.6	11	6	13	6	1/8	8431 0278 31
LTV009 R11-6	1.3-11	11.5-97.3	320	0.8	1.8	266	28.5	11	6	13	6	1/8	8431 0278 22
LTV009 R035-6	0.4-3.5	3.5-31	1100	0.7	1.5	266	25	9	6	13	6	1/8	8431 0278 05
LTV19 R15-6	6-15	54-133	360	1.1	2.4	309	31	11	7	15	8	1/4	8431 0279 34
<b>3/8" square drive for sockets</b>													
LTV009 R03-10	0.7-3	6.2-26.5	1400	0.7	1.5	266	25	9	6	13	6	1/8	8431 0278 23
LTV009 R09-10	1.3-9	11.5-79.6	430	0.7	1.5	266	28.5	11	6	13	6	1/8	8431 0278 13
LTV009 R11-10	1.3-11	11.5-97.3	320	0.8	1.8	266	28.5	11	6	13	6	1/8	8431 0278 20
LTV19 R15-10	6-15	54-133	360	1.1	2.4	309	31	11	7	15	8	1/4	8431 0279 36
<b>1/4" quick change chuck</b>													
LTV009 R05-Q	0.4-5	3.5-44.2	850	0.7	1.5	266	25	9	6	13	6	1/8	8431 0278 06
LTV009 R07-Q	1.1-7	9.7-61.9	500	0.7	1.5	266	25	9	6	13	6	1/8	8431 0278 09
LTV009 R07-Q-SH	1.1-7	9.7-61.9	500	0.7	1.5	243	25	9	6	13	6	1/8	8431 0279 30
LTV009 R09-Q	1.3-9	11.5-79.6	430	0.7	1.5	266	28.5	11	6	13	6	1/8	8431 0278 12
LTV009 R11-Q	1.3-11	11.5-97.3	320	0.8	1.8	266	28.5	11	6	13	6	1/8	8431 0278 19
LTV009 R025-Q	0.6-2.5	5.3-22.1	1650	0.7	1.5	266	25	9	6	13	6	1/8	8431 0278 00
LTV009 R035-Q	0.4-3.5	3.5-31	1100	0.7	1.5	266	25	9	6	13	6	1/8	8431 0278 03
LTV19 R15-Q	6-15	54-133	360	1.1	2.4	309	45	11	7	15	8	1/4	8431 0279 37
<b>Flush socket</b>													
LTV009 R12-FS-10	1.5-8	13.3-70.8	340	1.1	2.4	261	23.5	13.5	6	13	6	1/8	8431 0632 11

- All models:**
- Are reversible.
  - All data at an air pressure of 6.3 bar.
  - Are ESD approved

## Accessories Included

### EXHAUST HOSE

Included with straight and air-on-top models

### CLUTCH ADJUSTMENT KEY

Included with all shut-off and slip clutch tools



Clutch adjustment key

## Optional Accessories



Designation	Exhaust hose	Support handle	ESD hose	Torque arms adapters	Installation proposal	ESD approved pistol handle
LUM12 HRX/HRF	4210 2052 00	4110 1355 92	8202 0501 06	–	8202 1180 67	4210 3616 04
LUM22 HR 3, 4, 6	4210 2052 00	4110 1355 92	8202 0501 10	–	8202 1180 77	4210 4337 04
LUM22 HR 10, 12	4210 2052 00	4110 1355 93	8202 0501 10	–	8202 1180 77	4210 4337 04
LUM22 HRX 3, 4, 6	4210 2052 00	4110 1355 92	8202 0501 10	–	8202 1180 77	4210 3616 04
LUM12 SR	4210 2052 00	–	8202 0501 06	4390 1735 52	8202 1180 67	–
LUM12 PR	4210 2052 00	–	8202 0501 06	4390 1735 53	8202 1180 67	–
LUM22 SR	4210 2053 00	–	8202 0501 10	4390 1735 51	8202 1180 77	–
LUM22 PR	4210 2053 00	–	8202 0501 10	4390 1735 54	8202 1180 77	–
LTV009	4210 2052 00	–	8202 0501 06	–	8202 1180 67	–
LUM32 HR	4210 2052 00	4110 1355 94	8202 0501 10	–	8202 1180 77	4210 4337 04
LUF34	4210 2053 00	4110 1355 82	8202 0501 10	–	8202 1180 77	–

Model	Ordering No.
<b>Threaded clutch houses</b>	
LUM12 PR/SR 1, 2, 3, 4	4210 4386 04
LUM12 HRX/HRF 1, 3, 5, 8	4210 4386 04
LUM22 HRX/HR 2, 3, 4, 6	4210 4386 04
LUM22 HRX/HR 10, 12	4210 4392 03
LUM22 SR/PR 3, 4, 5, 6, 8	4210 4383 04
LUM22 SR/PR 10, 12	4210 4383 03
<b>Angle head covers</b>	
LTV009 R025-R07	4210 4115 00
LTV009 R08-R11	4210 4116 00
<b>Protective covers</b>	
LUM22/32 HR	4210 3150 00
LUM22 HRX	4210 3151 00
LUM12 HRX	4210 4642 00
<b>Threaded fronts</b>	
LUM 32 HR10, 15	4210 4252 90
<b>Suspension yoke for LTV009</b>	4210 4461 80
<b>Quick change chuck kit, extra wide diameter for easy handling</b>	4210 2326 91
<b>Angle-head for LTV009 R03/08/09/11, 90° hex drive magnetic bit holder<sup>a</sup></b>	4210 3857 91



Suspension yoke



Quick change chuck kit



Angle-head for LTV009

<sup>a</sup> Substitute for 4210 3857 XX angle heads.

### RE-CONVERSION KITS

Model	Ordering No.
LUM12 HRF	4210 3624 99
LUM12 SR	4210 4137 90
LUM22 SR	4210 2057 80
LTV009	4210 4137 90

## Productivity Kits

Model	Max air flow	Hose, 5 m	Coupling	Lubrication	Ordering No.
<b>For small screwdrivers with 1/8" BSP air inlet</b>					
MIDI Optimizer F/RD EQ08-C06-1/8	6 l/s	Cablaire 6 mm	ErgoQIC 08	Yes	8202 0850 10
MIDI Optimizer F/R EQ08-C06-1/8	6 l/s	Cablaire 6 mm	ErgoQIC 08	No	8202 0850 19
<b>For screwdrivers with 1/4" BSP air inlet</b>					
MIDI Optimizer F/RD EQ08-C08	9 l/s	Cablaire 8 mm	ErgoQIC 08	Yes	8202 0850 00
MIDI Optimizer F/R EQ08-C08	9 l/s	Cablaire 8 mm	ErgoQIC 08	No	8202 0850 01



## Service Kits

The spare parts included in the service kits cover a normal overhaul of your tool. Always have them available for a fast and economical repair.

Main parts included:

- Vane kit
- Motor bearings
- Gaskets
- O-rings
- Circlips
- Pins etc.

Model	Ordering No.
LUM10 PR	4081 0070 90
LUM12 HRX, HRF	4081 0247 90
LUM12 SR	4081 0254 90
LUM12 PR	4081 0250 90
LUM22 HR/HRX 3, 4, 6, 12	4081 0281 90
LUM22 HR/HRX 10	4081 0282 90
LUM22 PR/SR 3, 4, 6, 12	4081 0284 90
LUM22 PR/SR 10	4081 0285 90
LUM25 HRF	4081 0075 90
LUM32 HR	4081 0316 90
LUF34 HR	4081 0086 90
TWIST HRF	4081 0079 90
TWIST VR	4081 0078 90
TWIST HR 3, 7, 12	4081 0291 90
TWIST HR 6	4081 0281 90
TWIST HR 10	4081 0292 90
TWIST12 HRX 2, 3, 4	4081 0247 90
TWIST22 HRX 2-3200, 7, 12	4081 0296 90
TWIST22 HRX 10	4081 0295 90
LTV009	4081 0248 90
LTV18	4081 0085 90
LTV19	4081 0288 90



## Power you can depend on

*Atlas Copco impact wrenches are designed to provide dependability and a long, trouble-free service life in the toughest conditions. Few other tools can match the Atlas Copco impact wrench when it comes to flexibility, capacity-to-weight ratio and simplicity in use and maintenance.*

Atlas Copco's powerful, high-speed impact wrenches are designed to cut production times by providing rapid run-down and fast tightening. Impact wrenches build up torque in joints through a series of rotary impacts, where air pressure and tightening time affect the torque obtained. As a general rule, if a wrench impacts longer than 5 seconds on a fastener, a larger wrench should be used in order to achieve better durability.

The LMS models are non shut-off, which means they will shut off once the operator releases the trigger.

### **LMS**

The LMS is a non shut-off impact wrench with extraordinary power to weight qualities and virtually no reaction force during tightening. The torque is applied to the joint, not to your wrist.

These tools are typically used where fast tightening or disassembly is needed and the range covers recommended torque levels between 7-5500 Nm.

### **LMS 8-SERIES**

The LMS 8-series impact wrenches deliver true raw power and enables extremely fast tightening and loosening.







The innovative and unique Grease Retaining System ensures maximum tool performance with long service intervals.

### **MINIMUM WEAR AND LOW VIBRATIONS**

Each part of the durable LMS8-Series impact mechanism is produced with a very precise accuracy. This allows the maximum amount of energy to be generated in each impact. It also minimizes wear, vibration and strain on the operator.



# Selection Guide

	M6	M8	M10	M12	M14	M16	M18	M20	M22	M24	M27	M30	M36	M42	M45	M48
Nm	9.8	24	47	81	128	197	275	385	518	665	961	1310	2280	3640	4510	5450
<b>LMS</b>	LMS08	LMS18	LMS18	LMS28	LMS38	LMS38	LMS48	LMS58	LMS58	LMS58	LMS58	LMS68	LMS88	LMS88	LMS88	LMS88
	LMS08	LMS18	LMS28	LMS38	LMS38	LMS48	LMS58	LMS58	LMS58	LMS68	LMS68	LMS68	LMS88			
		M6	M8	M10	M12	M14	M16	M18	M20	M22	M24	M27	M30	M36	M42	M45
Nm	14	33	65	114	181	277	386	541	728	935	1350	1840	3210	5110	6340	
<b>LMS</b>	LMS08	LMS18	LMS28	LMS28	LMS38	LMS38	LMS48	LMS58	LMS58	LMS58	LMS68	LMS88	LMS88	LMS88	LMS88	
	LMS18	LMS18	LMS28	LMS38	LMS48	LMS48	LMS58	LMS68	LMS68	LMS68	LMS88					
	M6	M8	M10	M12	M14	M16	M18	M20	M22	M24	M27	M30	M36	M42		
Nm	17	40	79	136	217	333	463	649	874	1120	1620	2210	3850	6140		
<b>LMS</b>	LMS08	LMS18	LMS28	LMS28	LMS38	LMS48	LMS58	LMS58	LMS58	LMS68	LMS88	LMS88	LMS88	LMS88		
	LMS18	LMS18	LMS28	LMS38	LMS48	LMS58	LMS68	LMS68	LMS68	LMS88						

■ = **HEAVY DUTY**

■ = **EXTRA HEAVY DUTY**

The torque figures are normal tightening torque for untreated oil-smearred and rust-protected bolts and nuts in the most common strength grades. The torque figures correspond to approximately 63% of tensile stress.

## LMS MODELS

- Recommended operating range 7-1800 Nm.
- Fast tightening and disassembly.
- Negligible reaction force.
- Low weight.
- High power-to-weight ratio.
- Tightening time should not exceed 5 seconds, to avoid excess wear on the tool.
- Soft-start throttle.
- Long service intervals.
- Durable high performance with Grease Retaining System.



LMS18 HR13



LMS58 HR25

Model	Bolt size mm	Square drive in	Torque range		Max torque		Impacts per min	Free speed r/min	Weight		Length excl. anvil mm	CS dist- ance mm	Air con- sumption under load		Rec. hose size mm	Air inlet thread in	Ordering No.
			Nm	ft lb	Nm	ft lb			kg	lb			l/s	cfm			
LMS18 HR13	10	1/2 <sup>a</sup>	10-110	7-81	150	110	1500	8100	1.45	3.2	144	26	8.5	18	10	1/4	8434 1180 00
LMS18 HR10	10	3/8 <sup>a</sup>	10-90	7-66	120	88	1650	8100	1.45	3.2	148	26	6.5	14	10	1/4	8434 1180 01
LMS18 HR13/F	10	1/2 <sup>c</sup>	10-110	7-81	150	110	1500	8100	1.45	3.2	144	26	8.5	18	10	1/4	8434 1180 02
LMS18 HR10/F	10	3/8 <sup>c</sup>	10-90	7-66	120	88	1650	8100	1.45	3.2	148	26	6.5	14	10	1/4	8434 1180 03
LMS28 HR13	12	1/2 <sup>a</sup>	30-210	22-155	390	287	1500	9500	1.85	4.1	146	29	8.5	18	10	3/8	8434 1280 00
LMS28 HR13/F	12	1/2 <sup>c</sup>	30-210	22-155	390	287	1500	9500	1.85	4.1	146	29	8.5	18	10	3/8	8434 1280 01
LMS38 HR13	14-16	1/2 <sup>a</sup>	40-375	29-276	850	627	1350	8000	2.6	5.7	167	29	10	21	10	3/8	8434 1380 00
LMS38 HR13/F	14-16	1/2 <sup>c</sup>	40-375	29-276	850	627	1350	8000	2.6	5.7	167	29	10	21	10	3/8	8434 1380 01
LMS48 HR20	16-18	3/4 <sup>b</sup>	100-550	74-405	1375	1014	1100	6500	3.3	7.3	173	38	12	25.2	12.5	3/8	8434 1480 00
LMS58 HR25	20-22	1 <sup>b</sup>	300-800	221-590	1900	1401	900	5500	4.8	10.6	210	42	14.5	30.5	12.5	3/8	8434 1580 00
LMS58 HR20	18-20	3/4 <sup>b</sup>	300-800	221-590	1900	1401	900	5500	4.8	10.6	210	42	14.5	30.5	12.5	3/8	8434 1580 01
LMS68 HR25	22-30	1 <sup>b</sup>	600-1800	442-1400	4450	3282	780	5000	9.8	21.5	252	55	28	58.9	16	1/2	8434 1680 01

<sup>a</sup> Pin retainer

<sup>b</sup> Through hole

<sup>c</sup> Friction ring



## LMS MODELS

- Recommended operating range 7-5500 Nm.
- Fast tightening and disassembly.
- Negligible reaction force.
- Low weight.
- High power-to-weight ratio.
- Soft-start throttle.
- Tightening time should not exceed 5 seconds, to avoid excess wear on the tool.
- Long service intervals.
- Durable high performance with grease retaining system.



LMS08 SR10



LMS68 GIR25



LMS88 GIR38

Model	Bolt size mm	Square drive in	Torque range		Max torque		Impacts per min	Free speed r/min	Weight		Length excl. anvil mm	CS dist- ance mm	Air consumption under load		Rec. hose size mm	Air inlet thread in	Ordering No.
			Nm	ft lb	Nm	ft lb			kg	lb			l/s	cfm			
LMS08 SR42	6-8	1/4 <sup>a</sup>	7-35	5-26	60	44	1650	12500	0.85	1.9	185	20	5.5	9.1	6.3	1/4	8434 1081 06
LMS08 SR10	6-8	3/8 <sup>b</sup>	7-45	5-33	65	48	1650	12500	0.85	1.9	184	20	5.5	9.1	6.3	1/4	8434 1081 11
LMS68 GIR25	22-30	1 <sup>c</sup>	600-1800	442-1400	4450	3282	780	5000	9.6	21.1	339	55	28	58.9	16	1/2	8434 1680 00
LMS68 GOR25	22-30	1 <sup>c</sup>	600-1800	442-1400	4450	3282	780	5000	9.6	21.1	339	55	28	58.9	16	1/2	8434 1680 02
LMS88 GIR38	30-42	1 1/2 <sup>c</sup>	1000-5500	737-4054	10000	7370	540	3800	15.0	33.0	381	63.5	33	69.4	16	1/2	8434 1880 00
LMS88 GOR38	30-42	1 1/2 <sup>c</sup>	1000-5500	737-4054	10000	7370	540	3800	15.0	33.0	381	63.5	33	69.4	16	1/2	8434 1880 01

<sup>a</sup> Female hex. quick change chuck.

GOR = Outside trigger.

<sup>b</sup> Pin retainer

GIR = Inside trigger.

<sup>c</sup> Through hole

## Optional Accessories

### SUSPENSION YOKE

Model	Ordering No.
LMS18-58	4250 0872 90
LMS68 GIR25/GOR25/HR25	4250 0677 81
LMS88 GIR38/GOR38	0371 1102 00



## Service Kits

The spare parts included in the service kits cover a normal overhaul of your tool. Always have them available for a fast and economical repair.

Main parts included:

- Gaskets
- O-rings
- Circlips
- Pins etc.

Model	Service kit
LMS08	4081 0465 90
LMS18	4081 0466 90
LMS28	4081 0467 90
LMS38	4081 0468 90
LMS48	4081 0461 90
LMS58	4081 0445 90
LMS68	4081 0442 90
LMS88	4081 0443 90

## ErgoPulse impulse tools – fast, reliable and operator friendly

*The speed, reliability, and accuracy of ErgoPulse hydraulic impulse nutrunners, combined with the fact that they are comfortable to operate, make them suitable for continuous heavy production. Since there is no metal-to-metal impact in a pulse tool, it provides a softer, more controlled pulse with considerably less vibration and noise than an impact wrench.*

### A COMPLETE RANGE

ErgoPulse impulse tools are available in straight and pistol grip, shut-off and non shut-off, as well as high- and low pressure versions. The range covers torque from 2–450 Nm.

The ErgoPulse principle – The heart of a pulse tool is the hydraulic pulse unit. Since the pulses are very short, there is almost no reaction force in the handle, only the much lower motor torque is transferred to the operator's hand. In addition, there are less vibrations and noise than with an impact wrench. Combined with good balance and low weight the result is a tool that is very comfortable to operate.

Atlas Copco offer both shut-off and non shut-off tools. The shut-off pulse tools shut off the air supply when the pre-set torque is reached. Operator influence is minimized and the result is increased accuracy and faster tightening. The torque is “sensed” by means of a rotatable inertial mass acting against an adjustable spring. The result is a highly accurate and easily adjustable shut-off system. Non shut-off tools are operator dependent and preferred when the goal is to have a process controlled by the operator.

### ERGOPULSE PTI TOOLS

Our newest addition in the ErgoPulse shut-off tool range is the PTI. With the redesigned pulse unit technology DuraPulse® up-time of the tool is increased up to five times. It also offers the highest accuracy of all ErgoPulse tools as it's equipped with a more fine tuned shut-off mechanism. There is no need to choose between Trim and Autotrim function; the Multitrim function enables the use of both in the same tool, thus reducing meanshift on different types of joints.

With growing demands of increased production rate, the new TorqueBoost® technology creates faster torque build

up to reduce time per production unit. As per Atlas Copco standard, this tool is well balanced and created with superior ergonomics for maximum operator comfort in mind. The handle is designed for conventional use, and for use upside down. Available in a torque range from 8–150 Nm (6–110 ft lb) and in both high - and low pressure versions, the ErgoPulse PTI fills the needs of most applications requiring a pulse tool.

### ERGOPULSE PTS AND PTX TOOLS

**Pulse mechanism** – The pulse mechanism of the shut-off tools (including PTI) has pistons for minimum weight and long service life. The design is based on cam-guided pistons and rollers and the pulse cylinder is oil-filled. The moving parts are thus completely immersed in oil, which ensures a long service life.

**Twin chamber vane motor** – This is designed to give high torque at low speed, which gives the best characteristics for fast, accurate tightening.

**TRIM valve** – A patented adjustable valve at the air outlet is used to maximize tool accuracy on one type of joint, which could be hard, medium or soft.

**AUTOTRIM valve** – PTS/PTX-AT tools are equipped with an automatic two-stage trim valve. The tool runs down the screw with reduced free speed. After 1-2 pulses it shifts automatically to full power thus enabling both hard and soft joints to be tightened with excellent results without any adjustments.

The tools are available in both Trim and AutoTrim versions.

### ERGOPULSE XS TOOLS

The XS non shut-off tool is the correct choice when the operator needs to control the process. The tools provide high torque, fast, accurate tightening and long service lifetimes.



**Twin chamber vane motor** – This is designed to give high torque at low speed, which provides the best characteristics for fast, reliable and accurate tightening.

**Double or triple bladed pulse mechanisms** – The tools are equipped with pulse units with two or three blades. They employ the Atlas Copco patented cam-guided design to push out the blades, giving very high reliability. The pulse units have a high power-to-weight ratio, making the tools very powerful for their size. Torque is adjusted by regulating an artificial leak in the hydraulic circuit.

# Selection Guide

## EP PTI/PTS/PTX SHUT-OFF MODELS

The ErgoPulse PTI, PTS and PTX tools can be adjusted within a wide torque range by simply setting the spring force that counteracts the inertia body. Torque should preferably be checked with a hand torque wrench. Electronic monitoring with an in-line transducer is possible but should be verified with a manual hand torque wrench to avoid measuring errors due to the extremely short pulse sequence.

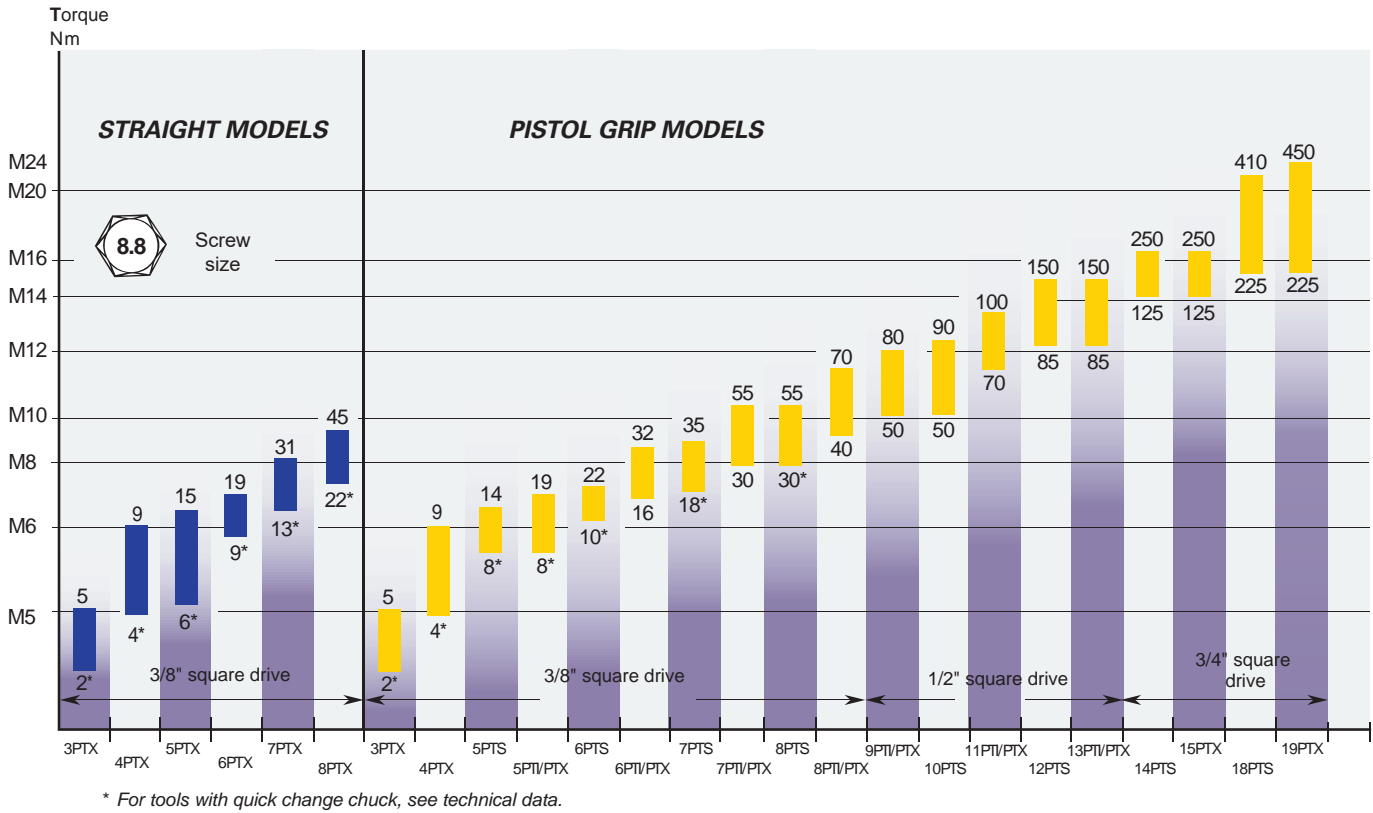

## EP XS/PS NON SHUT-OFF MODELS

The size of tool is determined on the basis of torque and/or bolt dimension. Torque should preferably be checked with a hand torque wrench. Electronic monitoring with an in-line transducer is possible but should be verified with a manual hand torque wrench to avoid measuring errors due to the extremely short pulse sequence.

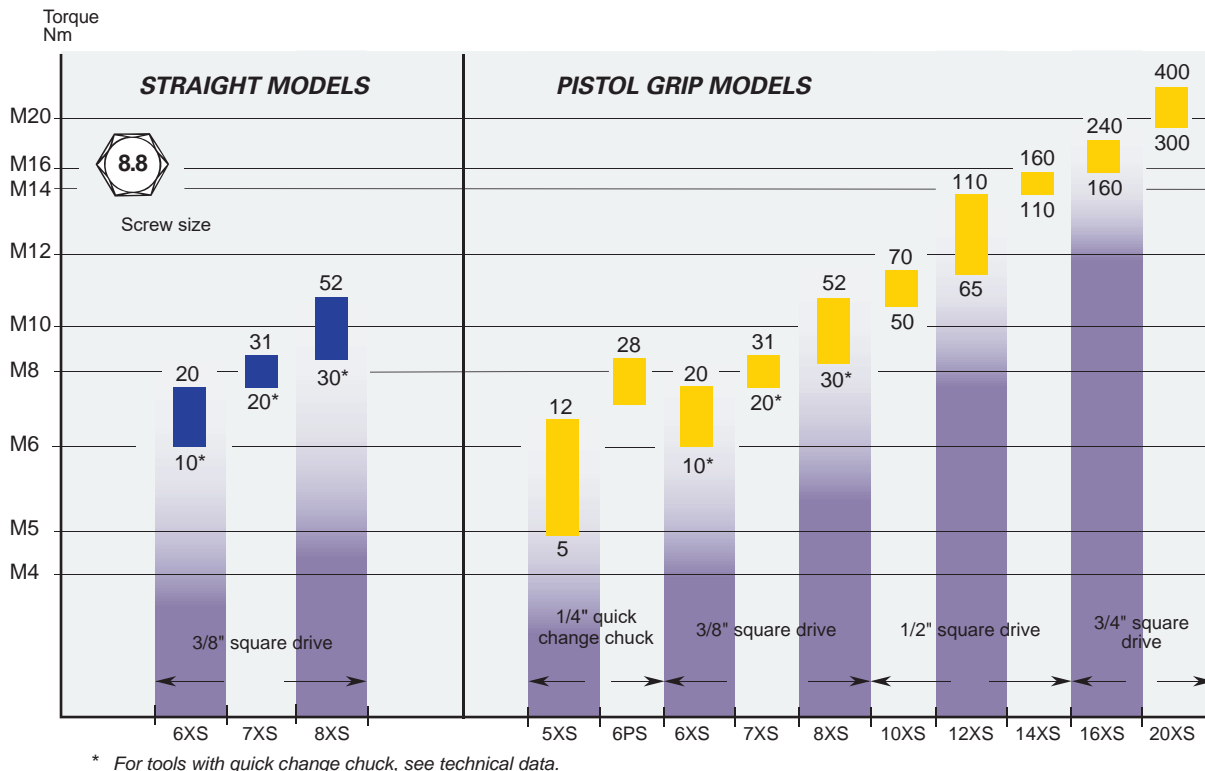



## EP PTI MODELS

The unique design of the ErgoPulse PTI shut-off hydraulic impulse tools brings pulse tool performance up to a level never experienced before.

PTI is our new generation of pulse tools offering superior uptime, ergonomics and productivity.

- TorqueBoost® for faster tightenings.
- MultiTrim® function integrated in tool.
- DuraPulse® technology allows for up to 5 times longer use before maintenance is required.
- Separate RE-port integrated in all tool models.
- High level of durability.
- Well balanced with superior ergonomics.
- New handle shape enabling tool use upside down.
- High speed, short cycle times.
- High power-to-weight ratio.
- No reaction forces.
- Low noise levels.
- Lubrication free.



EP8PTI HR13-MT

Model	Bolt size mm	Square drive in	Torque range <sup>a</sup>		Free speed <sup>b</sup> r/min	Weight		Length mm	CS distance mm	Air consumption under load		Rec. hose size mm	Air inlet thread in	Ordering No.
			Nm	ft lb		kg	lb			l/s	cfm			
<b>High pressure models<sup>c</sup></b>														
EP5PTI19 HR10-MT	M6	3/8	8-19	6-14	7300	0.9	2	168	23	6.5	14	8	1/4	8431 0381 30
EP6PTI32 HR10-MT	M6-M8	3/8	16-32	12-23	8700	0.9	2	168	23	6	13	8	1/4	8431 0381 40
EP7PTI55 HR10-MT	M8-M10	3/8	30-55	22-40	6500	1.2	2.5	179	27	10	21	10	1/4	8431 0381 50
EP8PTI70 HR10-MT	M10	3/8	40-70	29-51	6500	1.3	2.8	179	27	10	21	10	1/4	8431 0381 55
EP9PTI80 HR13-MT	M10	1/2	50-80	37-59	5200	1.5	3.3	191	31	13	28	10	1/4	8431 0381 60
EP11PTI100 HR13-MT	M12	1/2	70-100	52-74	4200	1.7	3.7	201	31	14	30	10	1/4	8431 0381 65
EP13PTI150 HR13-MT	M12-M14	1/2	85-150	63-110	4500	2.3	5	201	36	15	32	13	3/8	8431 0381 70
<b>Low pressure models<sup>d</sup></b>														
EP5PTI15 HR10-MT-L	M5	3/8	7-15	5-11	6900	0.9	2	168	23	6.3	13	8	1/4	8431 0382 30
EP6PTI25 HR10-MT-L	M6	3/8	13-25	9-18	7400	0.9	2	168	23	6	13	8	1/4	8431 0382 40
EP7PTI35 HR10-MT-L	M6	3/8	23-35	17-26	5600	1.2	2.5	179	27	9	19	10	1/4	8431 0382 50
EP8PTI45 HR10-MT-L	M6-M8	3/8	33-45	24-33	5700	1.3	2.8	179	27	8	17	10	1/4	8431 0382 55
EP9PTI65 HR13-MT-L	M10	1/2	43-65	32-48	4500	1.5	3.3	191	31	9.5	20	10	1/4	8431 0382 60
EP11PTI80 HR13-MT-L	M10-M12	1/2	50-80	37-59	3600	1.7	3.7	201	31	13	28	10	1/4	8431 0382 65
EP13PTI110 HR13-MT-L	M12-M14	1/2	63-110	46-81	3600	2.3	5	201	36	16	34	13	3/8	8431 0382 70

<sup>a</sup> To be used as a guide only, final torque depends on type of joint, accessories used and air pressure.

<sup>b</sup> In full speed mode.

<sup>d</sup> Air pressure 4 bar / 58 psi.

<sup>c</sup> Air pressure 6.3 bar / 91 psi.

**NOTE:** Protective cover is included for every tool.

## EP PTX MODELS

In ErgoPulse shut-off tools the air supply is shut off as soon as the pre-set torque has been reached, minimizing operator influence. The result is increased accuracy and faster tightening.

- High reliability.
- Consistent torque over time, low mean-shift.
- High level of durability.
- High speed, short cycle times.
- One-handed operation.
- High power-to-weight ratio.
- No springs to wear out.
- No wear on key parts.
- High precision components.
- No reaction forces.
- Light, well-balanced tools.
- Low noise levels.
- Lubrication free.



Model	Bolt size mm	Square drive in	Torque range <sup>a</sup>		Free speed r/min	Weight		Length mm	CS distance mm	Air consumption under load		Rec. hose size mm	Air inlet thread in	Ordering No.
			Nm	ft lb		kg	lb			l/s	cfm			
<b>TRIM-RE</b>														
EP3PTX5 HR42-RE	M4-M5	1/4 <sup>b</sup>	2-5	1.6-4	5000 <sup>c</sup>	0.8	1.7	154	21	4	9	8	1/4	8431 0375 51
EP4PTX9 HR10-RE	M5	3/8	4-9	3-7	3400 <sup>c</sup>	0.9	1.9	164	22	4	9	8	1/4	8431 0375 54
EP4PTX9 HR42-RE	M5	1/4 <sup>b</sup>	4-9	3-7	3400 <sup>c</sup>	0.9	1.9	164	22	4	9	8	1/4	8431 0375 50
EP5PTX17 HR42-RE	M6	1/4 <sup>b</sup>	7-17	5-13	7000 <sup>c</sup>	0.9	1.9	164	22	7	15	8	1/4	8431 0375 00
EP5PTX19 HR10-RE	M6	3/8	8-19	6-14	7000 <sup>c</sup>	0.9	1.9	164	22	7	15	8	1/4	8431 0375 04
EP6PTX28 HR42-RE	M6-M8	1/4 <sup>b</sup>	15-28	11-18	8500 <sup>c</sup>	0.9	1.9	164	22	7	15	8	1/4	8431 0375 10
EP6PTX32 HR10-RE	M6-M8	3/8	16-32	12-23	8500 <sup>c</sup>	0.9	1.9	164	22	7	15	8	1/4	8431 0375 20
EP7PTX55 HR10-RE	M8-M10	3/8	30-55	22-40	7200 <sup>c</sup>	1.2	2.5	176	25	9	19	10	1/4	8431 0375 30
EP8PTX70 HR10-RE	M10	3/8	40-70	29-51	6900 <sup>c</sup>	1.2	2.5	176	25	9	19	10	1/4	8431 0375 60
EP9PTX80 HR13-RE	M10	1/2	50-80	37-59	5200 <sup>c</sup>	1.5	3.3	188	29	11	23	10	1/4	8431 0375 40
EP11PTX110 HR13-RE	M12	1/2	70-110	51-81	5100 <sup>c</sup>	1.7	3.8	196	29	12	25	10	1/4	8431 0376 50
EP13PTX150 HR13-RE	M12-M14	1/2	85-150	63-110	5300 <sup>c</sup>	2.3	5.1	197	33.5	15	32	13	3/8	8431 0376 60
EP15PTX250 HR20-RE	M12-M16	3/4	125-250	92-184	4300 <sup>c</sup>	3.1	6.8	216	36.5	21	45	13	3/8	8431 0376 70
EP19PTX450 HR20-RE	M16-M20	3/4	225-450	166-332	3300 <sup>c</sup>	4.2	9.2	221	44	23	49	13	3/8	8431 0376 80
<b>Trim-RE Low pressure models<sup>d</sup></b>														
EP5PTX HR10-RE-L	M5	3/8	7-15	5-11	5900	0.9	2.0	164	22	4	9	8	1/4	8431 0379 04
EP5PTX HR42-RE-L	M4-M5	1/4 <sup>b</sup>	6-13	4-10	5900	0.8	1.8	154	21	4	9	8	1/4	8431 0379 00
EP6PTX HR10-RE-L	M6	3/8	13-25	9-18	7900	0.9	2.0	164	22	7	15	8	1/4	8431 0379 20
EP6PTX HR42-RE-L	M5	1/4 <sup>b</sup>	11-22	8-16	7900	0.9	2.0	164	22	4	9	8	1/4	8431 0379 10
EP7PTX HR10-RE-L	M6	3/8	23-35	17-26	6200	0.9	2.0	164	22	7	15	10	1/4	8431 0379 30
EP8PTX HR10-RE-L	M6-M8	3/8	33-45	24-33	6300	0.9	2.0	164	22	7	15	10	1/4	8431 0379 60
<b>AutoTrim</b>														
EP3PTX5 HR42-AT	M4-M5	1/4 <sup>b</sup>	2-5	1.6-4	4500 <sup>c</sup>	0.8	1.8	154	21	4	9	8	1/4	8431 0375 53
EP4PTX9 HR10-AT	M5	3/8	4-9	3-7	3300 <sup>c</sup>	0.9	2.0	164	22	4	9	8	1/4	8431 0375 56
EP4PTX9 HR42-AT	M5	1/4 <sup>b</sup>	4-9	3-7	3300 <sup>c</sup>	0.9	2.0	164	22	4	9	8	1/4	8431 0375 52
EP5PTX17 HR42-AT	M6	1/4 <sup>b</sup>	7-17	5-13	5400 <sup>c</sup>	0.9	2.0	164	22	7	15	8	1/4	8431 0375 02
EP5PTX19 HR10-AT	M6	3/8	8-19	6-14	5400 <sup>c</sup>	0.9	2.0	164	22	7	15	8	1/4	8431 0375 06
EP6PTX28 HR42-AT	M6-M8	1/4 <sup>b</sup>	15-28	11-18	8500 <sup>c</sup>	0.9	2.0	164	22	7	15	8	1/4	8431 0375 12
EP6PTX32 HR10-AT	M6-M8	3/8	16-32	12-23	8500 <sup>c</sup>	0.9	2.0	164	22	7	15	8	1/4	8431 0375 22
EP7PTX55 HR10-AT	M8-M10	3/8	30-55	22-40	6900 <sup>c</sup>	1.2	2.5	176	25	9	19	10	1/4	8431 0375 32
EP8PTX70 HR10-AT	M10	3/8	40-70	29-51	6900 <sup>c</sup>	1.2	2.5	176	25	9	19	10	1/4	8431 0375 62
EP9PTX80 HR13-AT	M10	1/2	50-80	37-59	5100 <sup>c</sup>	1.5	3.4	188	29	11	23	10	1/4	8431 0375 42
EP11PTX110 HR13-AT	M12	1/2	70-110	51-81	5100 <sup>c</sup>	1.7	3.8	196	29	12	25	10	1/4	8431 0376 52
EP13PTX150 HR13-AT	M12-M14	1/2	85-150	63-110	5300 <sup>c</sup>	2.3	5.0	197	33.5	15	32	13	3/8	8431 0376 62
EP15PTX250 HR20-AT	M12-M16	3/4	125-250	92-184	4200 <sup>c</sup>	3.1	6.8	216	36.5	21	45	13	3/8	8431 0376 72
EP19PTX450 HR20-AT	M16-M20	3/4	225-450	166-332	3300 <sup>c</sup>	4.2	9.2	221	44	23	49	13	3/8	8431 0376 82
<b>AutoTrim Low pressure models<sup>d</sup></b>														
EP5PTX HR10-AT-L	M5	3/8	7-15	5-11	5900	0.9	2.0	164	22	4	9	8	1/4	8431 0379 06
EP5PTX HR42-AT-L	M4-M5	1/4 <sup>b</sup>	6-13	4-10	5900	0.8	1.8	154	21	4	9	8	1/4	8431 0379 02
EP6PTX HR10-AT-L	M6	3/8	13-25	9-18	7900	0.9	2.0	164	22	7	15	8	1/4	8431 0379 22
EP6PTX HR42-AT-L	M5	1/4 <sup>b</sup>	11-22	8-16	7900	0.9	2.0	164	22	4	9	8	1/4	8431 0379 12
EP7PTX HR10-AT-L	M6	3/8	23-35	17-26	6200	0.9	2.0	164	22	7	15	10	1/4	8431 0379 32
EP8PTX HR10-AT-L	M6-M8	3/8	33-45	24-33	6300	0.9	2.0	164	22	7	15	10	1/4	8431 0379 62

<sup>a</sup> To be used as a guide only, final torque depends on type of joint, accessories used and air pressure. <sup>b</sup> Female hexagon drive. Quick change chuck. <sup>c</sup> In full speed mode. <sup>d</sup> Air pressure 4 bar / 58 psi.

## EP PTS MODELS

ErgoPulse PTS is the reliable and powerful workhorse and offers the same shut-off mechanism as the peak performer PTI. All PTS models can also be used as lubrication free, just like other ErgoPulse tools.



EP10PTS



EP12PTS

Model	Bolt size mm	Square drive in	Torque range <sup>a</sup>		Free speed r/min	Weight		Length mm	CS distance mm	Air consumption under load		Rec. hose size mm	Air inlet thread in	Ordering No.
			Nm	ft lb		kg	lb			l/s	cfm			
<b>TRIM-RE</b>														
EP5PTS12 HR42-RE	M5-M6	1/4 <sup>b</sup>	6-12	4-9	5400 <sup>c</sup>	1.0	2.2	196	21	6.5	14	8	1/4	8431 0374 05
EP5PTS14 HR10-RE	M5-M6	3/8	8-14	6-10	5400 <sup>c</sup>	1.0	2.2	191	21	6.5	14	8	1/4	8431 0374 00
EP6PTS22 HR10-RE	M6	3/8	10-22	7-16	7300 <sup>c</sup>	1.0	2.2	191	21	7	15	8	1/4	8431 0374 20
EP6PTS20 HR42-RE	M6	1/4 <sup>b</sup>	8-20	6-15	7300 <sup>c</sup>	1.0	2.2	196	21	7	15	8	1/4	8431 0374 15
<b>TRIM-RE with balanced grip</b>														
EP7PTS30 HR42-RE	M8	1/4 <sup>b</sup>	16-31	12-23	5700 <sup>c</sup>	1.4	3.0	175	26	8	17	10	1/4	8431 0374 35
EP7PTS35 HR10-RE	M8	3/8	18-35	13-26	5700 <sup>c</sup>	1.4	3.0	176	26	8	17	10	1/4	8431 0374 40
EP8PTS40 HR42-RE	M8	1/4 <sup>b</sup>	22-40	16-29	7300 <sup>c</sup>	1.4	3.0	175	26	9	19	10	1/4	8431 0374 55
EP8PTS55 HR10-RE	M8-M10	3/8	30-55	22-40	7300 <sup>c</sup>	1.4	3.0	176	26	9	19	10	1/4	8431 0374 60
EP10PTS90 HR13-RE	M10-M12	1/2	50-90	37-66	5200 <sup>c</sup>	1.8	4.0	193	29	11	23	10	1/4	8431 0374 80
EP12PTS150 HR13-RE	M12-M14	1/2	85-150	63-110	4200 <sup>c</sup>	2.5	5.5	201	34	13	27	13	3/8	8431 0374 90
EP14PTS250 HR20-RE	M12-M16	3/4	125-250	92-185	4000 <sup>c</sup>	3.3	7.2	216	37	20	42	13	3/8	8431 0374 95
EP18PTS410 HR20-RE	M16-M20	3/4	225-410	166-302	3000 <sup>c</sup>	4.3	9.5	202	42	22	46	13	3/8	8431 0374 98
<b>AutoTrim</b>														
EP6PTS20 HR42-AT	M6	1/4 <sup>b</sup>	8-20	6-15	6300 <sup>d</sup>	1.0	2.2	196	21	7	15	8	1/4	8431 0374 16
EP6PTS22 HR10-AT	M6	3/8	10-22	7-16	6300 <sup>d</sup>	1.0	2.2	191	21	7	15	8	1/4	8431 0374 21
<b>AutoTrim with balanced grip</b>														
EP7PTS30 HR42-AT	M8	1/4 <sup>b</sup>	16-31	12-23	5400 <sup>d</sup>	1.4	3.0	175	26	8	17	10	1/4	8431 0374 37
EP7PTS35 HR10-AT	M8	3/8	18-35	13-26	5400 <sup>d</sup>	1.4	3.0	176	26	8	17	10	1/4	8431 0374 42
EP8PTS40 HR42-AT	M8	1/4 <sup>b</sup>	22-40	16-29	6900 <sup>d</sup>	1.4	3.0	175	26	9	19	10	1/4	8431 0374 57
EP8PTS55 HR10-AT	M8-10	3/8	30-55	22-40	6900 <sup>d</sup>	1.4	3.0	176	26	9	19	10	1/4	8431 0374 62
EP10PTS90 HR13-AT	M10-12	1/2	50-90	37-66	4900 <sup>d</sup>	1.8	4.0	193	29	11	23	10	1/4	8431 0374 82
EP12PTS150 HR13-AT	M12-14	1/2	85-150	63-110	4100 <sup>d</sup>	2.5	5.5	201	34	13	27	13	3/8	8431 0374 92
EP14PTS250 HR20-AT	M12-16	3/4	125-250	92-185	3900 <sup>d</sup>	3.3	7.2	216	37	20	42	13	3/8	8431 0374 97
EP18PTS410 HR20-AT	M16-20	3/4	225-410	166-332	2900 <sup>d</sup>	4.3	9.5	202	42	22	46	13	3/8	8431 0374 99

<sup>a</sup> To be used as a guide only, final torque depends on type of joint, accessories used and air pressure.

<sup>b</sup> Female hexagon drive. Quick change chuck.

<sup>d</sup> In full speed mode.

<sup>c</sup> With TRIM valve fully open.

## EP XS MODELS

In ErgoPulse non shut-off tools the tool produces pulses until the operator releases the trigger. Preferred in applications where it is an advantage for the operator to be able to control the process by shutting off the tool manually.

- High reliability and durability.
- High speed, short cycle times.
- One-handed operation.
- High power-to-weight ratio.
- No springs to wear out.
- High precision components.
- No reaction forces.
- Light, well-balanced tools.
- Low noise levels.
- Lubrication free.



Model	Bolt size mm	Square drive in	Torque range <sup>a</sup>		Free speed r/min	Weight		Length mm	CS distance mm	Air consumption under load		Rec. hose size mm	Air inlet thread in	Ordering No.
			Nm	ft lb		kg	lb			l/s	cfm			
EP6PS HR10	M8	3/8	~30	~22	8000	0.8	1.8	150	21	9	19	10	1/4	8431 0368 21
EP6PS HR42	M8	1/4 <sup>b</sup>	~28	~21	8000	0.8	1.8	148	21	9	19	10	1/4	8431 0368 22
EP8PS HR10	M8-M10	3/8	~65	~48	8000	1.0	2.2	158	23	9	19	10	1/4	8431 0368 24
EP5XS HR42	M5-M6	1/4 <sup>b</sup>	5-12	4-9	8500	0.8	1.8	165	21	9	19	8	1/4	8431 0372 30
EP6XS HR42	M6	1/4 <sup>b</sup>	9-19	6-14	8000	0.8	1.8	150	22	8	17	8	1/4	8431 0372 23
EP6XS HR10	M6	3/8	10-20	7-15	8000	0.8	1.8	152	22	8	17	8	1/4	8431 0372 20
EP7XS HR42	M8	1/4 <sup>b</sup>	17-28	13-21	9000	0.8	1.8	150	22	8	17	8	1/4	8431 0372 10
EP7XS HR10	M8	3/8	20-31	15-23	9000	0.8	1.8	152	22	8	17	8	1/4	8431 0372 00
EP8XS HRX42	M8	1/4 <sup>b</sup>	22-40	16-29	7000	1.0	2.2	172	23	9	19	10	1/4	8431 0369 16
EP8XS HRX10	M8-M10	3/8	30-52	22-38	7000	1.0	2.2	174	23	9	19	10	1/4	8431 0369 09
EP10XS HR13	M10	1/2	50-70	37-52	6000	1.3	2.9	168	26	11	23	10	1/4	8431 0369 40
EP12XS HR13	M12	1/2	65-110	48-81	4500	1.6	3.5	178	29	12	25	10	1/4	8431 0371 00
EP14XS HR13	M14	1/2	110-160	81-118	3500	2.4	5.3	188	34	14	30	13	3/8	8431 0371 50
EP16XS HR20	M16	3/4	160-240	118-177	2800	3.3	7.3	205	37	15	32	13	3/8	8431 0371 55
EP20XS HR20	M20	3/4	300-400	221-295	3700	5.1	11.2	240	43	16	34	13	3/8	8431 0371 60

<sup>a</sup> To be used as a guide only, final torque depends on type of joint, accessories used and air pressure.

<sup>b</sup> Female hexagon drive. Quick change chuck.

<sup>c</sup> Torque is adjusted by regulating the air pressure.



## EP PTX MODELS

In ErgoPulse shut-off tools the air supply is shut off as soon as the pre-set torque has been reached, minimizing operator influence. The result is increased accuracy and faster tightening.

- High reliability.
- Consistent torque over time.
- High level of durability.
- High speed, short cycle times.
- One-handed operation.
- High power-to-weight ratio.
- No springs to wear out.
- High precision components.
- No reaction forces.
- Low noise levels.
- Lubrication free.



EP4/5/6PTX SR-AT

Model	Bolt size mm	Square drive in	Torque range <sup>a</sup>		Free speed r/min	Weight		Length mm	CS distance mm	Air consumption under load		Rec. hose size mm	Air inlet thread in	Ordering No.
			Nm	ft lb		kg	lb			l/s	cfm			
<b>TRIM</b>														
EP3PTX5 SR42	M4-M5	1/4 <sup>b</sup>	2-5	1.6-4	4500 <sup>d</sup>	0.7	1.6	202	21	4	9	8	1/4	8431 0376 01
EP4PTX9 SR10	M5	3/8	4-9	3-7	3400 <sup>d</sup>	0.9	2.0	207	21	4	9	8	1/4	8431 0376 04
EP4PTX9 SR42	M5	1/4 <sup>b</sup>	4-9	3-7	3400 <sup>d</sup>	0.9	2.0	207	21	4	9	8	1/4	8431 0376 00
EP5PTX14 SR42	M6	1/4 <sup>b</sup>	7-14	5-10	5300 <sup>d</sup>	0.9	2.0	207	21	7	15	8	1/4	8431 0376 10
EP5PTX15 SR10	M6	3/8	9-15	7-11	5300 <sup>d</sup>	0.9	2.0	207	21	7	15	8	1/4	8431 0376 14
EP6PTX18 SR42	M6	1/4 <sup>b</sup>	9-18	7-13	6800 <sup>d</sup>	0.9	2.0	207	21	7	15	8	1/4	8431 0376 20
EP6PTX19 SR10	M6	3/8	10-19	7-14	6800 <sup>d</sup>	0.9	2.0	207	21	7	15	8	1/4	8431 0376 24
EP7PTX28 SR42	M6-M8	1/4 <sup>b</sup>	17-28	13-18	4300 <sup>d</sup>	1.2	2.5	235	25	8	17	10	1/4	8431 0376 30
EP7PTX31 SR10	M6-M8	3/8	18-31	13-23	4300 <sup>d</sup>	1.2	2.5	235	25	8	17	10	1/4	8431 0376 34
EP8PTX45 SR10	M8	3/8	24-45	18-33	5500 <sup>d</sup>	1.2	2.5	235	25	9	19	10	1/4	8431 0376 40
EP8PTX38 SR42	M8	1/4 <sup>b</sup>	22-38	16-28	5500 <sup>d</sup>	1.2	2.5	235	25	9	19	10	1/4	8431 0376 44
<b>AutoTrim</b>														
EP3PTX5 SR42-AT	M4-M5	1/4 <sup>b</sup>	2-5	1.6-4	4500 <sup>c</sup>	0.8	1.7	262	21	4	9	8	1/4	8431 0376 03
EP4PTX9 SR10-AT	M5	3/8	4-9	3-7	3300 <sup>c</sup>	0.9	2.0	267	21	4	9	8	1/4	8431 0376 06
EP4PTX9 SR42-AT	M5	1/4 <sup>b</sup>	4-9	3-7	3300 <sup>c</sup>	0.9	2.0	267	21	4	9	8	1/4	8431 0376 02
EP5PTX15 SR10-AT	M6	3/8	9-15	7-11	4800 <sup>c</sup>	0.9	2.0	267	21	7	15	8	1/4	8431 0376 16
EP5PTX14 SR42-AT	M6	1/4 <sup>b</sup>	7-14	5-10	4800 <sup>c</sup>	0.9	2.0	267	21	7	15	8	1/4	8431 0376 12
EP6PTX18 SR42-AT	M6	1/4 <sup>b</sup>	9-18	7-13	6700 <sup>c</sup>	0.9	2.0	267	21	7	15	8	1/4	8431 0376 22
EP6PTX19 SR10-AT	M6	3/8	10-19	7-14	6700 <sup>c</sup>	0.9	2.0	267	21	7	15	8	1/4	8431 0376 26
EP7PTX28 SR42-AT	M6-M8	1/4 <sup>b</sup>	17-28	13-18	4300 <sup>c</sup>	1.2	2.5	295	25	7	15	10	1/4	8431 0376 32
EP7PTX31 SR10-AT	M6-M8	3/8	18-31	13-23	4300 <sup>c</sup>	1.2	2.5	295	25	7	15	10	1/4	8431 0376 36
EP8PTX38 SR42-AT	M8	1/4 <sup>b</sup>	22-38	16-28	5900 <sup>c</sup>	1.2	2.5	295	25	9	19	10	1/4	8431 0376 46
EP8PTX45 SR10-AT	M8	3/8	24-45	18-33	5900 <sup>c</sup>	1.2	2.5	295	25	9	19	10	1/4	8431 0376 42
<b>AutoTrim Low pressure models<sup>e</sup></b>														
EP5PTX SR10-AT-L	M5	3/8	8-13	6-10	4800	0.9	2.0	267	21	4	9	8	1/4	8431 0368 01
EP5PTX SR42-AT-L	M4-M5	1/4 <sup>b</sup>	7-12	5-9	4800	0.7	1.6	267	21	4	9	8	1/4	8431 0368 03
EP6PTX SR10-AT-L	M6	3/8	10-17	7-13	6300	0.9	2.0	267	21	7	15	8	1/4	8431 0368 09
EP6PTX SR42-AT-L	M5	1/4 <sup>b</sup>	9-16	6-12	6300	0.9	2.0	267	21	4	9	8	1/4	8431 0368 15
EP7PTX SR10-AT-L	M6	3/8	16-22	12-16	4000	0.9	2.0	295	21	7	15	8	1/4	8431 0368 35
EP7PTX SR42-AT-L	M6	1/4 <sup>b</sup>	15-21	11-15	4000	0.9	2.0	295	21	7	15	8	1/4	8431 0368 46
EP8PTX SR10-AT-L	M6-M8	3/8	21-32	15-24	5300	1.2	2.5	295	25	8	17	10	1/4	8431 0367 83

<sup>a</sup> To be used as a guide only, final torque depends on type of joint, accessories used and air pressure.

<sup>d</sup> With TRIM valve fully open.

<sup>e</sup> Air pressure 4 bar / 58 psi.

<sup>b</sup> Female hexagon drive. Quick change chuck.

<sup>c</sup> In full speed mode.

## XS MODELS

In ErgoPulse non shut-off tools the tool produces pulses until the operator releases the trigger. Preferred in applications where it is an advantage for the operator to be able to control the process by shutting off the tool manually.

- High reliability and durability.
- High speed, short cycle times.
- One-handed operation.
- High power-to-weight ratio.
- No springs to wear out.
- No wear on key parts.
- High precision components.
- No reaction forces.
- Light, well-balanced tools.
- Low noise levels.
- Lubrication free.



EP6XS SR

Model	Bolt size mm	Square drive in	Torque range <sup>a</sup>		Free speed r/min	Weight		Length mm	CS distance mm	Air consumption under load		Rec. hose size mm	Air inlet thread in	Ordering No.
			Nm	ft lb		kg	lb			l/s	cfm			
EP6XS SR10	M6	3/8	10-20	7-15	8000	0.7	1.5	221	22	8	17	8	1/4	8431 0372 25
EP6XS SR42	M6	1/4 <sup>b</sup>	9-19	6-14	8000	0.7	1.5	219	22	8	17	8	1/4	8431 0372 27
EP7XS SR10	M8	3/8	20-31	15-23	10000	0.7	1.5	221	22	8	17	8	1/4	8431 0372 05
EP7XS SR42	M8	1/4 <sup>b</sup>	17-28	13-21	10000	0.7	1.5	219	22	8	17	8	1/4	8431 0372 15
EP8XS SR10	M8-M10	3/8	30-52	22-38	8000	0.9	2.0	244	24	9	19	8	1/4	8431 0369 20
EP8XS SR42	M8	1/4 <sup>b</sup>	22-40	16-29	8000	0.9	2.0	242	24	9	19	8	1/4	8431 0369 30

<sup>a</sup> To be used as a guide only, final torque depends on type of joint, accessories used and air pressure.

<sup>b</sup> Female hexagon drive. Quick change chuck.

## Productivity Kits

Model	Max air flow	Hose, 5 m	Coupling	Lubrication	Ordering No.
<b>For small impacts and pulse tools with 1/4" BSP air inlet</b>					
MIDI Optimizer F/RD EP EQ08-C08	9 l/s	Cablair 8 mm	ErgoQIC 08	Yes	8202 0850 35
<b>For 1/2" impact wrenches and pulse tools with 3/8" BSP air inlet</b>					
MIDI Optimizer F/RD EQ08-C10	16 l/s	Cablair 10 mm	ErgoQIC 08	Yes	8202 0850 36
<b>For 1/2" impact wrenches and pulse tools with 1/4" BSP air inlet</b>					
MIDI Optimizer F/RD EQ08-C10	16 l/s	Cablair 10 mm	ErgoQIC 08	Yes	8202 0850 37
MIDI Optimizer F/RD EQ10-R10	16 l/s	Rubber 10 mm	ErgoQIC 10	Yes	8202 0850 38
<b>For impact wrenches and pulse tools with 3/8" BSP air inlet</b>					
MIDI Optimizer F/RD EQ10-C13	23 l/s	Cablair 13 mm	ErgoQIC 10	Yes	8202 0850 39
<b>For impact wrenches and pulse tools with 1/2" BSP air inlet</b>					
MIDI Optimizer F/RD EQ10-T13	35 l/s	Turbo 13 mm	ErgoQIC 10	Yes	8202 0850 41

## Optional Accessories

### GUIDED EXTENSIONS

Available for	Square drive in	Dia. of outgoing spindle mm	Length mm	Marking	Ordering No.
6-8XS,	3/8	13	75	10-13-75	4023 3600 02
4-8PTI/PTS/PTX	3/8	13	100	10-13-100	4023 3600 01
	3/8	13	150	10-13-150	4023 3601 01
	3/8	13	200	10-13-200	4023 3611 01
	3/8	13	250	10-13-250	4023 3612 01
	3/8	13	300	10-13-300	4023 3613 01
10C, 10-12XS	1/2	16	75	13-16-75	4023 3602 02
	1/2	16	100	13-16-100	4023 3602 01
	1/2	16	150	13-16-150	4023 3603 01
	1/2	16	200	13-16-200	4023 3604 01
	1/2	16	250	13-16-250	4023 3614 01
	1/2	16	300	13-16-300	4023 3615 01
14XS, 9-13PTI/PTX, 10-12PT/PTS	1/2	18	75	13-18-75	4023 3605 02
	1/2	18	100	13-18-100	4023 3605 01
	1/2	18	150	13-18-150	4023 3606 01
	1/2	18	200	13-18-200	4023 3607 01
	1/2	18	250	13-18-250	4023 3616 01
	1/2	18	300	13-18-300	4023 3617 01
16XS/20XS, 14PTS/18PTS, 15PTX/19PTX	3/4	25	100	20-25-100	4023 3608 01
	3/4	25	150	20-25-150	4023 3609 01
	3/4	25	200	20-25-200	4023 3610 01
	3/4	25	250	20-25-250	4023 3618 01
	3/4	25	300	20-25-300	4023 3619 01



Guided extensions

### GUIDED SOCKETS

Available for	Square in	Width across mm/in	Diameter of outgoing mm	Marking	Ordering No.
<b>Metric sockets</b>					
6-8XS,	3/8	10	13	10-13	4026 4210 00
4-8PTI/PTS/PTX	3/8	13	13	13-13	4026 4213 00
	3/8	16	13	16-13	4026 4216 00
	3/8	17	13	17-13	4026 4217 00
	3/8	18	13	18-13	4026 4218 00
	3/8	19	13	19-13	4026 4219 00
14XS, 9-13PTI/PTX, 10-12PT/PTS	1/2	13	18	13-18	4026 4313 00
	1/2	16	18	16-18	4026 4316 00
	1/2	17	18	17-18	4026 4317 00
	1/2	18	18	18-18	4026 4318 00
	1/2	19	18	19-18	4026 4319 00
	1/2	24	18	24-18	4026 4324 00
16XS/20XS, 14PTS/18PTS, 15PTX/19PTX	3/4	18	25	18-25	4026 4418 00
	3/4	24	25	24-25	4026 4424 00
	3/4	30	25	30-25	4026 4430 00
<b>UNC/UNF-sockets</b>					
6-8XS,	3/8	1/2	13	1/2-13	4026 4212 00
5-8PTI/PTS/PTX	3/8	9/16	13	9/16-13	4026 4214 00
	3/8	3/4	13	3/4-13	4026 4219 00
14XS, 9-13PTI/PTX, 10-12PT/PTS	1/2	1/2	18	1/2-18	4026 4312 00
	1/2	9/16	18	9/16-18	4026 4314 00
	1/2	3/4	18	3/4-18	4026 4319 00
	1/2	15/16	18	15/16-18	4026 4323 00
16XS/20XS, 14PTS/18PTS, 15PTX/19PTX	3/4	3/4	25	3/4-25	4026 4419 00
	3/4	15/16	25	15/16-25	4026 4423 00
	3/4	11/8	25	11/8-25	4026 4429 00



Guided sockets

### GUIDED QUICK CHANGE CHUCK FOR POWER TOOLS

Available for	Square drive in	Female hex in	Diameter of outgoing spindle mm	Marking	Ordering No.
6-8XS	3/8	1/4	13	3/8-1/4-13	4026 4501 00
5-8PTI/PTS/PTX	3/8	7/16	13	3/8-7/16-13	4026 4502 00
14XS, 9-13PTI/PTX, 10-12PT/PTS	1/2	7/16	18	1/2-7/16-18	4026 4503 00



Guided quick change chuck

## Optional Accessories

### PROTECTIVE COVER AND SUPPORT HANDLE

Pistol grip models	Protective cover	Support handle
EP6/7XS HR	4250 2089 00	
EP8XS HRX	4250 1895 00	
EP12XS HR	4250 2459 00	
EP14XS HR	4250 2160 00	
EP16XS HR	4250 2282 00	4250 2396 91
EP20XS HR	4250 2288 00	Included
EP4/5/6PTX HR	4250 2465 00	
EP7/8PTX HR	4250 2466 00	
EP9PTX HR	4250 2467 00	
EP11PTX HR	4250 2551 00	
EP13PTX HR	4250 2718 00	4250 2396 91
EP15PTX HR	4250 2674 00	4250 2396 93
EP19PTX HR	4250 2719 00	4250 2396 92
EP5/6PT/PTS HR	4250 2393 00	
EP7/8PT/PTS HR	4250 1784 00	
EP10PT/PTS HR	4250 1743 00	
EP12PT/PTS HR	4250 1858 00	
EP14PTS HR	4250 2228 00	4250 2396 91
EP18PTS HR	4250 2319 00	
EP5/6PTI	4250 3209 00	
EP7/8PTI	4250 3206 00	
EP9PTI	4250 3216 00	
EP11PTI	4250 3218 00	
EP13PTI	4250 3214 00	4250 2396 91



Support handle



Protective cover



Protective cover for EP PTI models

For complete information, go to [servaid.atlascopco.com](http://servaid.atlascopco.com)

### OIL FILLING KIT AND OIL KIT

	Ordering No.
Oil filling kit for PTI models	4250 3220 90
Oil kit (150 ml, syringe)	4081 0121 90
Oil kit (1000 ml, syringe)	4081 0513 90

### RE-REPORTING KIT

	Ordering No.
RE-reporting kit for ErgoPulse PTS/PTX models with AutoTrim or Trim-RE valve	4250 1854 91
RE-reporting kit for ErgoPulse PTI models	4250 1854 92



## Service Kits

The spare parts included in the service kits cover a normal overhaul of your tool. Always have them available for a fast and economical repair.

Main parts included:

- Vane kit
- Motor bearings
- Gaskets
- O-rings
- Circlips
- Pins etc.

Model	Pulse unit kit	Service kit	Model	Pulse unit kit	Service kit
EP5XS	4210 2532 93	4081 0264 90	EP7PTX HR	4250 2267 96	4081 0410 90
EP6/7XS HR	4250 2084 90	4081 0188 90	EP8PTX HR	4250 2267 91	4081 0279 90
EP6/7XS SR	4250 2084 90	4081 0189 90	EP9PTX HR	4250 2058 90	4081 0411 90
EP6PS HR	4250 2058 91	4081 0274 90	EP11PTX HR	4250 2267 95	4081 0310 90
EP8PS HR	4250 2059 90	4081 0120 90	EP13PTX HR	4250 2267 92	4081 0226 90
EP8XS HR	4250 2085 90	4081 0119 90	EP15PTX HR	4250 2267 93	4081 0242 90
EP8XS SR	4250 2085 90	4081 0190 90	EP19PTX HR	4250 2267 94	4081 0256 90
EP10XS HR	4250 2086 90	4081 0191 90	EP5/6PTS HR	4250 2058 90	4081 0413 90
EP12XS HR	4250 2087 90	4081 0192 90	EP7/8PTS HR	4250 2267 91	4081 0225 90
EP14XS HR	4250 2170 90	4081 0200 90	EP10PTS HR	4250 2267 90	4081 0222 90
EP16XS HR	4250 2281 90	4081 0223 90	EP12PTS HR	4250 2267 92	4081 0226 90
EP20XS HR	4250 2281 91	4081 0245 90	EP14PTS HR	4250 2267 93	4081 0242 90
EP4PTX HR	4250 2058 96	4081 0122 90	EP18PTS HR	4250 2267 94	4081 0256 90
EP5/6PTX HR	4250 2058 90	4081 0122 90			

For complete information, go to [servaid.atlascopco.com](http://servaid.atlascopco.com)



### User-friendly tools offering power, speed and accuracy

*The tools in Atlas Copco's broad range of pneumatic nutrunners offer a superior combination of power, speed and accuracy. With their advanced ergonomic designs, they are also extremely user-friendly and will contribute to raising productivity in a wide range of applications in your assembly plant.*

Tools in Atlas Copco's range of pneumatic nutrunners are divided into three main categories: Angle, straight and pistol grip versions. These are also available in optional models, such as crowfoot, hold-and-drive, and flush socket.

#### **THE POWER TO RAISE PRODUCTIVITY**

The high power output provided by Atlas Copco nutrunners is decisive for productivity, i.e., the combined performance of operator and tool. The tools are set at the optimal speed for every torque capacity rating. The balance between speed and clutch response gives high accuracy, ensuring torque repeatability, regardless of joint characteristics.

#### **COMFORTABLE TO WORK WITH**

Our pneumatic nutrunners live up to Atlas Copco's reputation for developing tools with good ergonomics. Low tool weights, thermally insulated grips and low noise and vibration levels all help to reduce operator fatigue and raise individual productivity in your plant.

Simplicity in selection and installation allow you to set the torque once and that is the torque you will get, joint after joint, without complicated analyses.

#### **CHOOSING THE RIGHT TOOL IS EASY**

No joint is too complicated for a nutrunner. To set the torque, just adjust it to the required level, regardless of joint conditions.



### A new angle on productivity

*The LTV 9-2 and LTV 8 angle nutrunner range from Atlas Copco successfully combines two key performance factors – speed and accuracy. Consistently accurate, high-speed tightening is complemented by advanced ergonomic design, ensuring an unmatched level of productivity. All this is presented in a tool that is very easy to handle.*

Angle nutrunners from Atlas Copco are certified for accuracy and durability by major car manufacturers. They are easy to choose, easy to set, and easy to operate.

#### **ACCURATE EVERY TIME**

Hard or soft joint? You don't need to think about it. The tool gives the torque you install, independent of joint variations and variations in air pressure and lubrication. The clutch shuts off at the same torque, tightening after tightening.

#### **HIGHEST PRODUCTIVITY**

Instant disengagement of the clutch keeps torque over-shoot to a minimum even on the fastest tools. Our new models were developed to meet the most extreme requirements on operational speeds.

As always, we kept operator comfort in mind. The tools are well balanced, slim and comfortable to handle. Reaction forces are extremely low.

#### **JOB VERIFICATION**

For remote indication of clutch release function the tools can be equipped with air signal outlet – RE. This is often used for counting the number of fasteners in a tightening cycle.



## LTV29-2 SERIES

- Designed for high speed and small dimensions.
- Slim lightweight design.
- Soft, comfortable grip.
- Easy to reverse.
- Low reaction force.
- Spiral cut angle gears.



LTV29-2

## LTV39-2 SERIES

- The fastest nutrunners of this type.
- Powerful motor.
- Consistently high accuracy.
- Many operator-friendly features.
- Spiral cut angle gears.



LTV39-2

## LTV FS FLUSH SOCKET TOOLS

- Minimum angle head size gives good access.
- High torque accuracy.
- Integrated sockets give reduced angle head height.
- Spiral cut angle gears.

Model	Bolt size mm	Square drive in	Torque range soft joint		Free speed r/min	Weight		Length mm	Angle head height mm	Angle head center to side mm	Air consumption at free speed		Rec. hose size mm	Air inlet thread in	Ordering No.
			Nm	ft lb		kg	lb				l/s	cfm			
<b>Reversible</b>															
LTV29-2 R12-6	M6	1/4	6-12	4.5-9	850	1.3	2.9	351	27	11	10	21	10	1/4	8431 0631 15
LTV29-2 R12-10	M6	3/8	6-12	4.5-9	850	1.3	2.9	351	27	11	10	21	10	1/4	8431 0631 16
LTV29-2 R12-Q	M6	1/4 <sup>a</sup>	6-12	4.5-9	850	1.3	2.9	351	44	11	10	21	10	1/4	8431 0631 17
LTV29-2 R12-42	M6	1/4 <sup>b</sup>	6-12	4.5-9	850	1.3	2.9	351	34	11	10	21	10	1/4	8431 0631 18
LTV29-2 R12-B6	M6	1/4	6-12	4.5-9	850	1.3	2.9	351	27	11	10	21	10	1/4	8431 0631 00
LTV29-2 R12-B10	M6	3/8	6-12	4.5-9	850	1.3	2.9	351	27	11	10	21	10	1/4	8431 0631 01
LTV29-2 R16-6	M6	1/4	9-16	7-12	850	1.3	2.9	351	27	11	10	21	10	1/4	8431 0631 22
LTV29-2 R16-10	M6	3/8	9-16	7-12	850	1.3	2.9	351	27	11	10	21	10	1/4	8431 0631 21
LTV29-2 R16-Q	M6	1/4 <sup>a</sup>	9-16	7-12	850	1.3	2.9	351	44	11	10	21	10	1/4	8431 0631 24
LTV29-2 R16-42	M6	1/4 <sup>b</sup>	9-16	7-12	850	1.3	2.9	351	34	11	10	21	10	1/4	8431 0631 23
LTV29-2 R16-B6	M6	1/4	9-16	7-12	850	1.3	2.9	351	27	11	10	21	10	1/4	8431 0631 02
LTV29-2 R24-10	M8	3/8	12-24	9-18	640	1.4	3.1	374	30	14	10	21	10	1/4	8431 0631 29
LTV29-2 R30-10	M8	3/8	15-30	11-22	500	1.4	3.1	374	30	14	10	21	10	1/4	8431 0631 37
LTV39-2 R16-10	M6	3/8	7-16	5-12	1200	1.5	3.3	375	27	11	16	34	10	1/4	8431 0633 09
LTV39-2 R30-10	M8	3/8	15-30	11-22	870	1.6	3.5	385	35	14	16	34	10	1/4	8431 0633 19
LTV39-2 R37-10	M8	3/8	22-37	16-27	708	1.7	3.7	405	35	18	16	34	10	1/4	8431 0633 24
LTV39-2 R48-10	M8	3/8	24-48	18-35	560	1.7	3.7	405	35	18	16	34	10	1/4	8431 0633 27
LTV39-2 R48-13	M8	1/2	24-48	18-35	560	2.0	4.4	425	41	20	16	34	10	1/4	8431 0633 43
LTV39-2 R48-B13	M8	1/2	24-48	18-35	560	2.0	4.4	425	41	20	16	34	10	1/4	8431 0631 10
LTV39-2 R56-10	M10	3/8	28-56	21-41	460	1.7	3.7	405	35	18	16	34	10	1/4	8431 0633 35
LTV39-2 R56-13	M10	1/2	28-56	21-41	460	2.0	4.4	425	41	20	16	34	10	1/4	8431 0633 51
LTV39-2 R56-B13	M10	1/2	28-56	21-41	460	2.0	4.4	425	41	20	16	34	10	1/4	8431 0631 12
LTV39-2 R70-13	M10	1/2	35-70	26-51	350	2.1	4.6	425	41	20	16	34	10	1/4	8431 0633 59
LTV39-2 R70-B13	M10	1/2	35-70	26-51	350	2.1	4.6	425	41	20	16	34	10	1/4	8431 0631 13
LTV39-2 R85-13	M10-12	1/2	43-85	32-63	305	2.5	5.5	500	52	25	16	34	10	1/4	8431 0633 67
LTV39-2 R85-B13	M10-12	1/2	43-85	32-63	305	2.5	5.5	500	52	25	16	34	10	1/4	8431 0631 14
LTV39-2 R120-13	M12	1/2	60-120	44-88	220	2.5	5.5	500	52	25	16	34	10	1/4	8431 0633 69
<b>Flush socket</b>															
LTV29-2 R24 FS	M8	–	12-24	9-18	640	1.4	3.7	357	32	15	10	21	10	1/4	8431 0634 51
LTV29-2 R30 FS	M8	–	15-30	11-22	500	1.3	3.1	357	32	15	10	21	10	1/4	8431 0634 52
LTV39-2 R37 FS	M8	–	22-37	16-27	708	1.7	3.7	406	38	19	16	34	10	1/4	8431 0634 53
LTV39-2 R48 FS	M8	–	24-48	18-35	560	1.7	3.7	406	38	19	16	34	10	1/4	8431 0634 54
LTV39-2 R56 FS	M8	–	28-56	21-41	460	1.7	3.7	406	38	19	16	34	10	1/4	8431 0634 55
LTV39-2 R70 FS	M10	–	35-70	26-51	350	2.1	4.6	425	50	20	16	34	10	1/4	8431 0634 56
LTV39-2 R85 FS	M10-12	–	43-85	32-63	305	2.5	5.5	500	58	26	16	34	10	1/4	8431 0634 57
LTV39-2 R120 FS	M12	–	60-120	44-88	220	2.5	5.5	500	58	26	16	34	10	1/4	8431 0634 58

<sup>a</sup> Quick change chuck. <sup>b</sup> Female hex drive. B - Ball retainer

**NOTE:** All LTV29/39 with -10 (3/8) square drives can be used as either pin or ball retainer.



## LTV28 AND 38 SERIES

- Highest reliability when tightening M5-M12 screws.
- Small, durable gears.
- Precise clutch.
- Reliable motor.
- Spiral cut angle gears.



LTV28

## LTV48 SERIES

- Robust, reliable tools.
- Reversible for torques up to 200 Nm.
- Comfortable to operate due to low weight and smooth handles.
- Reaction bars and other accessories available.
- Spiral cut angle gears.



LTV38



LTV48

## LTV FS FLUSH SOCKET TOOLS

- Minimum angle head size gives good access.
- High torque accuracy.
- Integrated sockets give reduced angle head height.
- Spiral cut angle gears.

Model	Bolt size mm	Square drive in	Torque range soft joint		Free speed r/min	Weight		Length mm	Angle head height mm	Angle head center to side mm	Air consumption at free speed		Rec. hose size mm	Air inlet thread in	Ordering No.
			Nm	ft lb		kg	lb				l/s	cfm			
<b>Reversible</b>															
LTV28 R07-6	M5	1/4	2.5-7	1.8-5	1100	1.3	2.9	334	28.5	10	8	17	8	1/4	8431 0601 65
LTV28 R07-42	M5	1/4 <sup>a</sup>	2.5-7	1.8-5	1100	1.3	2.9	334	28.5	10	8	17	8	1/4	8431 0601 73
LTV28 R07-Q	M6	1/4 <sup>b</sup>	2.5-7	1.8-5	1100	1.3	2.9	334	28.5	10	8	17	8	1/4	8431 0601 68
LTV28 R15-6	M6	1/4	7-15	5-11	560	1.4	3.1	349	28	11	10	21	10	1/4	8431 0601 52
LTV28 R15-10	M6	3/8	7-15	5-11	560	1.4	3.1	349	28	11	10	21	10	1/4	8431 0601 55
LTV28 R15-Q	M6	1/4 <sup>b</sup>	7-15	5-11	560	1.4	3.1	349	28	11	10	21	10	1/4	8431 0601 53
LTV28 R20-10	M6	3/8	10-19	7-15	530	1.4	3.1	355	34.5	13.5	10	21	10	1/4	8431 0601 50
LTV28 R20-42	M6	1/4 <sup>a</sup>	10-20	7-15	420	1.4	3.1	350	34	13.5	10	21	10	1/4	8431 0601 48
LTV28 R28-10	M8	3/8	14-28	10-21	340	1.4	3.1	350	29.5	13.5	10	21	10	1/4	8431 0601 40
LTV28 R28-42	M8	1/4 <sup>a</sup>	14-28	10-21	340	1.4	3.1	350	29.5	13.5	10	21	10	1/4	8431 0601 44
LTV28 RL28-10	M8	3/8	14-28	10-21	80	1.4	3.1	350	29.5	13.5	10	21	10	1/4	8431 0601 33
LTV38 R42-10	M8	3/8	20-42	15-31	400	2.0	4.4	436	34.5	18	16	34	10	1/4	8431 0603 55
LTV38 R42-13	M8	1/2	20-42	15-31	400	2.2	4.8	453	41	20	16	34	10	1/4	8431 0603 69
LTV38 R50-10	M10	3/8	25-50	18-36	330	2.0	4.4	436	34.5	18	16	34	10	1/4	8431 0603 63
LTV38 R50-13	M10	1/2	25-50	18-36	330	2.2	4.8	453	41	20	16	34	10	1/4	8431 0603 71
LTV38 R57-13	M10	1/2	30-57	22-41	280	2.2	4.8	453	41	20	16	34	10	1/4	8431 0603 51
LTV38 R70-13	M10	1/2	34-70	24-50	225	2.4	5.3	487	41	20	16	34	10	1/4	8431 0603 46
LTV38 R85-13	M10-12	1/2	40-85	29-61	190	2.8	6.1	530	52	25	16	34	10	1/4	8431 0603 38
LTV48 R120-L13	M12	1/2	70-120	51-88	215	3.5	7.6	590	52	25	28	59	12.5	1/2	8431 0534 88
LTV48 R150-L13	M12	1/2	70-150	51-111	170	3.5	7.6	590	52	25	28	59	12.5	1/2	8431 0534 93
LTV48 R200-L13	M14	1/2	115-200	85-148	100	3.8	8.3	610	52	25	28	59	12.5	1/2	8431 0534 98
<b>Flush socket</b>															
LTV48 R150 FS	M12	–	70-150	44-111	180	3.5	7.6	590	70	25	28	59	12.7	1/2	8431 0610 17
LTV48 R200 FS	M14	–	115-200	85-148	100	3.8	8.3	610	70	25	28	59	12.8	1/2	8431 0610 21

<sup>a</sup> Female hex drive.

<sup>b</sup> Quick change chuck.



## LTV69 SERIES

- New twin motor – higher rundown speed, accurate tightening.
- High torques.
- Good access in cramped spaces.
- Spiral cut angle gears.



LTV69

Model	Bolt size mm	Square drive in	Min torque at 3 bar soft joint		Min torque at 6.3 bar soft joint		Max torque at 6.3 bar soft joint		Free speed r/min	Weight		Length mm	Angle head height mm	Angle head center to side mm	Air con- sumption at free speed		Rec. hose size mm	Air inlet thread in	Ordering No.
			Nm	ft lb	Nm	ft lb	Nm	ft lb		kg	lb				l/s	cfm			
<b>Reversible</b>																			
LTV69 R180-13 <sup>a</sup>	M16	1/2	70	52	100	74	170	125	840	5.1	11.1	592	50	25.3	20	42	13	1/2	8431 0830 04
LTV69 R370-20 <sup>a</sup>	M18	3/4	140	103	190	140	370	273	480	7.6	16.6	634	62	32.9	20	42	13	1/2	8431 0830 15
LTV69 R600-25 <sup>a</sup>	M22	1	230	170	400	295	600	443	280	10.2	22.6	676	77	54.0	20	42	13	1/2	8431 0830 21
<b>Non-reversible</b>																			
LTV69 N180-13	M16	1/2	70	52	100	74	170	125	840	4.6	10.1	577	50	25.3	20	42	13	1/2	8431 0830 35
LTV69 N370-20	M18	3/4	140	103	190	140	370	273	480	7.1	15.6	619	62	32.9	20	42	13	1/2	8431 0830 46
LTV69 N600-25	M22	1	230	170	400	295	600	443	280	9.7	21.3	661	77	54.0	20	42	13	1/2	8431 0830 52

<sup>a</sup> Fixed reverse.

## IN-LINE CROWFOOT TOOLS

### Dimensions

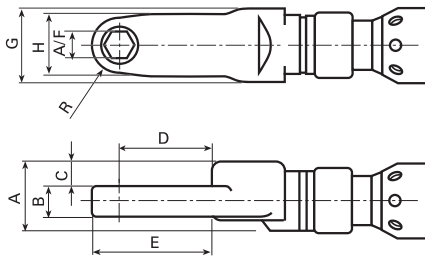

LTC

Model*	Torque		Speed r/min	Weight		Length mm	A/F mm	A mm	B mm	C mm	D mm	E mm	G mm	H mm	R mm	Ordering No.
	Nm	ft lb		kg	lb											
LTC009 R08-10-LI3	4-8	2.9-6	210	1.3	2.9	312	10	34	10	13.5	37	41	35	22	10	8431 0613 72
LTC009 R13-10-LI3	6-13	4-9	127	1.8	4	312	10	34	15	12.5	46.7	59.2	35	22	10	8431 0616 01
LTC009 R14-12-LI3	6-14	4-10	127	1.8	4	319	12	34	15	12.5	45.5	71	35	30	13	8431 0616 07
LTC28 R18-10-LI3	10-18	7-13	386	1.8	4	421	10	34	15	12.5	36.7	59.2	35	22	10	8431 0616 02
LTC38 R28-12-LI3	14-28	10-20	470	1.8	4	493	12	34	15	12.5	45.5	71	35	30	13	8431 0616 09
LTC38 R34-21-LI3	16-34	12-25	390	3.7	8.2	578	21	46	20	16	74.5	44	64	40	20	8431 0616 10
LTC48 R80-21-LI3	50-80	37-59	250	4	8.9	578	21	46	20	16	74.5	84	64	40	20	8431 0616 12
LTC48 R135-22-LI3	105-135	77-99	90	4.6	10.2	651	22	46	33	14	77.5	84	64	40	20	8431 0616 15

\* Available on demand.

## OFFSET CROWFOOT TOOLS

### Dimensions

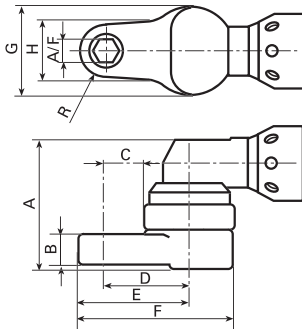

LTC

Model*	Torque		Speed r/min	Weight		Length mm	A/F mm	A mm	B mm	C mm	D mm	E mm	F mm	G mm	H mm	R mm	Ordering No.
	Nm	ft lb		kg	lb												
LTC009 R07-10-LO3	3-7	2.2-5	250	1.6	3.6	304	10	59.5	10	14.55	32.8	42.8	61.1	36.5	22	10	8431 0614 94
LTC29-2R19-10-LO3	10-19	7.3-14	640	2	4.4	384	10	60.3	15	14.55	32.8	42.8	61.1	36.5	22	10	8431 0615 02
LTC29-2R21-13-LO5	11-21	8-15	500	2	4.4	457	13	58.5	10	71.6	93.6	108.1	130.1	44	31	14.5	8431 0615 04
LTC39-2R28-12-LO5	17-28	13-21	560	2.5	5.6	488	12	69.5	15	62	84	97	119	44	30	13	8431 0615 08
LTC39-2R40-14-LO3	22-40	16-29	460	2.4	5.3	452	14	77.8	18	24.8	46.8	61.3	83.3	44	31	14.5	8431 0615 11
LTC39-2R60-16-LO3	34-60	25-44	305	3	6.7	541	16	91	24	27	51	66	91.5	48	30	15	8431 0615 14
LTC48 R80-17-LO3	56-80	41-59	215	4	8.9	641	17	69.5	27	30.3	55.8	72.3	97.8	48	33	16.5	8431 0615 17
LTC48 R96-18-LO3	56-96	41-71	210	4.7	10.4	651	18	99	32	32	63.2	82.2	113.5	62.5	38	19	8431 0615 21
<b>Extra heavy duty attachments</b>																	
LTC38 R33-13-A-O-3	16-33	11.8-24	430	2.6	5.8	487	13	60	19	32.8	52.8	68.8	88.8	40	34	16	8431 0611 01
LTC48 R56-17-A-O-3	24-56	18-41	400	3.9	8.7	619	17	66	19	45.1	67.6	87.2	109.7	45	39.2	19.5	8431 0611 06
LTC38 R40-17-A-O-3	23-40	17-29	360	3	6.7	519	17	66	19	45.1	67.6	87.2	109.7	45	39.2	19.5	8431 0611 08
LTC48 R120-19-A-O-3	48-120	36-89	180	4.3	9.6	656	19	87	25	42.3	67.6	87.4	112.7	54	39.5	19.75	8431 0611 15

\* Available on demand.

## IN-LINE TUBE NUT TOOLS

### Dimensions

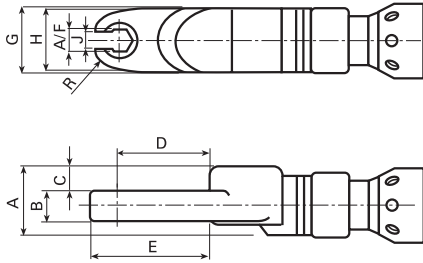

LTO

Model*	Torque		Speed r/min	Weight		Length mm	A/F mm	A mm	B mm	C mm	D mm	E mm	G mm	H mm	J mm	R mm	Ordering No.
	Nm	ft lb		kg	lb												
LTO28 R06-8-LI3	2.1-6	1.5-4	833	1.8	4	369	8	32	10	13	27.3	25.4	33.5	31	7	9.8	8431 0617 02
LTO28 R12-8-LI3	6-12	4-8	420	2	4.4	388	8	32	10	13	27.3	25.4	33.5	31	7	9.8	8431 0617 03
LTO28 R12-10-LI3	6-12	4-8	420	2	4.4	396	10	32	10	13	27.3	25.4	33.5	31	7	9.8	8431 0612 44
LTO28 R15-10-LI3	6-15	4-11	400	2	4.4	397	10	32	12	11	27.9	26.1	33.5	32	8	10.3	8431 0612 46
LTO28 R17-13-LI3	8-17	6-13	350	1.9	4.2	415	13	34	11	14.5	36.3	32.3	35	38	8.5	12.4	8431 0612 48
LTO28 R19-10-LI3	8-19	6-14	350	1.9	4.2	402	10	34	14	13	31.9	29.7	35	38	8	11.2	8431 0617 07
LTO38 R26-13-LI3	14-35	10-25	220	3	6.7	536	13	46	11	20.8	52	47.3	45	55	12.5	17.2	8431 0612 50
LTO38 R26-17-LI3	15-43	11-31	200	3.2	7.1	547	17	46	12	20	60.3	38.8	45	59	16	20.1	8431 0612 54
LTO38 R35-12-LI3	14-35	10-25	220	2.9	6.4	519	12	43	11	17.5	43.7	29.3	40	50	10.4	15	8431 0617 09
LTO38 R43-14-LI3	14-43	10-31	220	3.2	7.1	522	14	46	18	17	41	38.5	45	50	12	15	8431 0617 10

\* Available on demand.

## OFFSET TUBE NUT TOOLS

### Dimensions

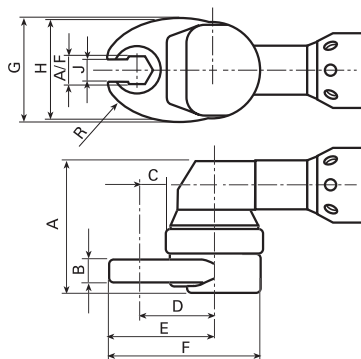

LTO

Model*	Torque		Speed r/min	Weight		Length mm	A/F mm	A mm	B mm	C mm	D mm	E mm	F mm	G mm	J mm	R mm	Ordering No.
	Nm	ft lb		kg	lb												
LTO28 R12-12-LO5	6-12	4.4-9	470	2	4.4	402	12	66.5	11	51	73	84.9	106.9	44	8	11.9	8431 0618 05
LTO38 R28-13-LO5	11-28	8.0-20	250	2.3	5.1	506	13	71	18	53.3	75.3	87.7	109.7	44	10.4	12.4	8431 0618 12

\* Available on demand.

## HOLD AND DRIVE

Hold and drive bolts are being used increasingly by, for example, truck manufacturers on the frame assembly line, making what used to be a two-man operation, a one-man task. The distinguishing feature of a hold and drive bolt is that one part is held and the other is tightened from the same side.

## LTV HAD

- Especially suitable for shock absorber assembly.
- Special tools based on the standard LTV series are available for use on hold and drive bolts.
- HAD sockets are available in three different lengths.
- Special sockets available upon request.
- Also suitable for break-away bolts, Hi Lok/Hi Shear.



LTV48 R200 HAD

**NOTE:** To reduce the reaction force in the holder, the use of a reaction bar is recommended.

Model	Bolt size mm	Torque range soft joint <sup>a</sup>		Free speed r/min	Weight		Length mm	Angle head height mm	Angle head center to side mm	Air con- sumption at free speed		Rec. hose size mm	Air inlet thread in	Ordering No.
		Nm	ft lb		kg	lb				l/s	cfm			
LTV38 R40 LT HAD <sup>b</sup>	M8-10	15-40	11-30	210	3.0	6.5	530	75	26	10	16	10	1/4	8431 0609 52
LTV38 R42 HAD	M8	20-42	15-31	430	2.2	4.8	453	62	18.5	10	16	10	1/4	8431 0603 75
LTV38 R50 HAD	M10	25-50	18-36	360	2.2	4.8	453	62	18.5	10	16	10	1/4	8431 0603 82
LTV38 R85 HAD	M10-12	40-85	30-67	210	3.0	6.5	530	75	26	10	16	10	1/4	8431 0609 58
LTV48 R120 HAD	M12-14	70-120	52-89	220	3.3	7.3	590	75	26	28	59	12.5	1/2	8431 0610 26
LTV48 R150 HAD	M14	70-150	52-111	180	3.3	7.3	590	75	26	28	59	12.5	1/2	8431 0610 30
LTV48 R200 HAD	M14	115-200	85-150	100	3.3	7.3	610	75	28	28	59	12.5	1/2	8431 0610 32
LTV69 R370 HAD	M18	190-370	140-273	480	7.6	16.6	634	104	33	20	42	12.5	1/2	8431 0831 65

<sup>a</sup> At min 5 bar.

<sup>b</sup> For low torque applications.

**NOTE:** For sockets and holders see accessory pages.

Other types of Hold and Drive equipped tools are available on special request.



## STALL TYPE

- Low inertia design gives accurate torque independent of joint stiffness – in other words, low mean shift.
- Easy torque setting by adjusting the inlet air pressure.
- Reliable, well-proven design.
- Good accessibility due to small dimensioned angle head.

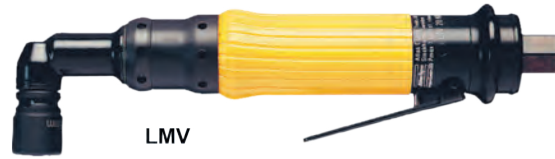

LMV

Model	Bolt size mm	Square drive in	Torque range soft joint		Free speed r/min	Weight		Length mm	Angle head height mm	Angle head center to side mm	Air consumption at free speed		Rec. hose size mm	Air inlet thread in	Ordering No.		
			at 6.3 bar Nm	at 3 bar ft lb		kg	lb				l/s	cfm					
<b>Reversible</b>																	
LMV28 R11-10	M6	3/8	11	8	5	4	1200	1.1	2.4	264	28	11	10	21	10	1/4	8431 0591 07
LMV28 R14-10	M6	3/8	14	10	7	5	1000	1.1	2.4	264	29.5	13.5	10	21	10	1/4	8431 0591 09
<b>Non reversible</b>																	
LMV28 N16-10	M6	3/8	16	12	8	6	1000	1.0	2.2	239	29.5	13.5	11	23	10	1/4	8431 0590 17

## RATCHET WRENCHES

- Unique accessibility, the ratchet wrench is a superior tool for limited space applications.
- To loosen, turn the tool upside down.



LBR

Model	Bolt size mm	Square drive in	Torque range soft joint		Free speed r/min	Weight		Length mm	Angle head height mm	Angle head center to side mm	Air consumption at free speed		Rec. hose size mm	Air inlet thread in	Ordering No.		
			at 6.3 bar Nm	at 3 bar ft lb		kg	lb				l/s	cfm					
LBR33 S26/114-13	M8	13 <sup>a</sup>	22	16	11	8	185	1.4	3.1	290	15	13	9.5	20	10	1/4	8431 0345 71
LBR33 S26/118-16	M8-10	16 <sup>a</sup>	30	22	15	11	135	1.4	3.1	300	15	18	9.5	20	10	1/4	8431 0346 70
LBR33 S26/118-17	M8-10	17 <sup>a</sup>	30	22	15	11	135	1.4	3.1	300	15	18	9.5	20	10	1/4	8431 0346 62

<sup>a</sup> Female hex drive.

## WORM-DRIVE NUTRUNNERS

- Teasing throttle characteristics give significantly reduced free speed.
- Suitable for:
  - Nutrunning
  - Light reaming
  - Tapping
  - Tube-rolling
- Can also be incorporated in rigs as air motors for intermittent operation.



LMK

Model	Bolt size mm	Square drive in	Torque range soft joint		Free speed r/min	Weight		Length mm	Angle head height mm	Angle head center to side mm	Air consumption at free speed		Rec. hose size mm	Air inlet thread in	Ordering No.		
			at 6.3 bar Nm	at 3 bar ft lb		kg	lb				l/s	cfm					
LMK33 S001	M10-12	7/16 <sup>a</sup>	55	41	27	20	130	2.2	4.9	385	39	41	9.5	20	10	1/4	8431 0343 08
LMK33 S002	M10-12	7/16 <sup>a</sup>	32	24	16	12	235	1.9	4.2	291	39	41	9.5	20	10	1/4	8431 0343 16
LMK33 S005	M10	7/16 <sup>a</sup>	29	21	14	10	480	1.7	3.7	263	39	41	9.5	20	10	1/4	8431 0343 24

<sup>a</sup> Female hex drive.

## Accessories Included

### FOR LTV MODELS

Clutch adjustment key

### FOR LBR, LMV AND LMK MODELS

Socket adapter, 3/8" square drive LMK22,  
1/2" square drive LMK33

## Optional Accessories

### EXTENSIONS FOR LTV

Suitable for tool	Length of extension – "L"		Ordering No.
	mm	in	
LTV28	75	3	4210 3491 93
LTV28	150	6	4210 3491 95
LTV38 (not R70/R85)	75	3	4210 4301 80
LTV38 (not R70/R85)	150	6	4210 4302 80
LTV38 R70/R85/LTV48	75	3	4210 4303 80
LTV38 R70/R85/LTV48	150	6	4210 4304 80
LTV39-2 R48-10	75	3	4210 4472 81
LTV39-2 R48-10	150	6	4210 4472 83
LTV39-2 R48/56/70-13	75	3	4210 4472 80
LTV39-2 R48/56/70-13	150	6	4210 4473 80
LTV39-2 R56-10	75	3	4210 4472 82
LTV39-2 R56-10	150	6	4210 4472 84
LTV39-2 R85	75	3	4210 4474 80
LTV39-2 R85	150	6	4210 4475 80

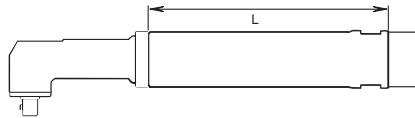

Reaction bar kit



Protective cover (a)



Protective cover (b)



Signal connection kit (RE)

### FOR LTV AND LTC MODELS

Model	Exhaust hose	Suspension yoke		Protective cover (see picture)	Reaction bar kit	Signal connection kit (-RE)
		Fixed	Swivelling			
LTV28 R07	4210 2053 00	4210 1631 82	4210 3931 80	4210 3990 00 <sup>a</sup>		4210 4019 90
LTV28, all models except R07	4210 2053 00	4210 1631 82	4210 3931 80	4210 3990 00 <sup>a</sup>		4210 4018 90
LTV29-2/39-2	4210 2053 00	4210 1631 82	4210 4408 80			4210 4017 90
LTV29-2/39-2 R12/R16				4220 2744 05 <sup>b</sup>		
LTV29-2/39-2 R24/R30				4220 2744 03 <sup>b</sup>		
LTV38 R42/R50/R57	4210 2053 00	4210 1631 82	4210 3931 81	4210 3992 90 <sup>a</sup> (not LTC)		4210 4017 90
LTC38, LTV38 FS						
LTV38 R70	4210 2053 00	4210 1631 82	4210 3931 81	4210 4003 90 <sup>a</sup>		4210 4017 90
LTV38 R85, LTV38 HAD	4210 2053 00	4210 1631 82	4210 3931 81	4210 4004 90 <sup>a</sup>	4210 4020 80	4210 4017 90
LTV39-2 R48-10/R50-10				4220 2744 02 <sup>b</sup>		
LTV39-2 R48-13/R50-13/R70				4220 2744 04 <sup>b</sup>		
LTV48 R65	4210 4011 00		4210 4021 80	4210 4058 90 <sup>a</sup>	4210 4020 80	4210 4057 90
LTV48 R120/R150/R200, LTC48, LTV48 FS, LTV48 HAD	4210 4011 00		4210 4021 80	4210 4059 90 <sup>a</sup>	4210 4020 80	4210 4057 90
LTV69 N/R180	4210 4011 00		4210 3088 87	4210 4059 90 <sup>a</sup>	4220 1128 80	
LTV69 N/R370	4210 4011 00		4210 3088 87		4220 1201 80	
LTV69 N/R600	4210 4011 00		4210 3088 87		4220 1746 80	

## Optional Accessories for Flush socket tools

### INTEGRATED SOCKETS

Model	Hexagon socket size		Socket extension mm	Ordering No.
	AF mm / in	mm		
LTV29-2 R24/R30 FS, ETV ST61-30-FS	8	1.5	4220 4188 88	
	10	1.5	4220 4188 90	
	12	1.5	4220 4188 92	
	13	1.5	4220 4188 93	
	1/4"	1.5	4220 4188 96	
	5/16"	1.5	4220 4188 98	
LTV39-2 R37/R48/R56 FS, ETV ST61-40-FS, ETV ST61-50-FS	10	2.5	4220 3987 90	
	12	2.5	4220 3987 92	
	13	2.5	4220 3987 93	
	13	7	4220 4012 93	
	13	15	4220 4013 93	
	14	2.5	4220 3987 94	
	14	15	4220 4013 94	
	15	2.5	4220 3987 95	
	16	2.5	4220 3987 96	
	17	2.5	4220 3987 97	
	18	2.5	4220 3987 98	
	9/16"	2.5	4220 3987 99	
	LTV39-2 R70 FS, ETV ST61-70-FS	10	3.5	4220 1621 04
12		3.5	4210 2749 03	
13		3.5	4210 2749 01	
14		3.5	4210 2749 04	
15		1.5	4220 1621 01	
15		3.5	4210 2749 02	
15		16.5	4220 1621 00	
16		0.5	4220 1251 00	
16		11.5	4220 1621 03	
16		14.5	4220 1621 10	
16		16.5	4220 1621 08	
17		11.5	4220 1621 12	
17.5		6.5	4220 1621 06	
18		6.5	4220 1621 02	
18		10.5	4220 1621 09	
19		8.5	4220 1621 07	
19		10	4220 1621 11	
20		8.5	4220 1621 05	
7/16"		3.5	4210 2749 06	
9/16"		3.5	4210 2749 05	
LTV39-2 R85/R120 FS, LTV48 R150/R200 FS, ETV ST61 100/150/180/200 FS	18	4.5	4220 1595 02	
	18	14.5	4220 1595 04	
	14	5.5	4220 1595 07	
	14.3	9	4220 1595 08	
	17.5	7.5	4220 1595 09	
	18	2	4210 3534 68	
	18	8.5	4210 3534 18	
	19	9.5	4210 3534 19	
	21	10.5	4210 3534 21	
	21	13.5	4220 1595 05	
	21	24	4220 1595 06	
	22	10.5	4210 3534 22	
	24	10.5	4210 3534 24	
	24	12.5	4220 1595 01	
	25.4	13.5	4220 1595 03	
	27	13.8	4210 3534 27	

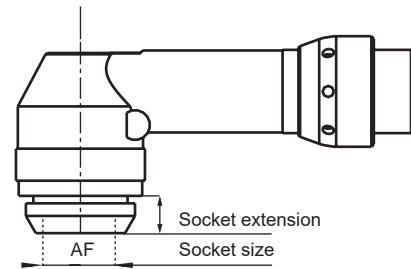

Model	Hexagon socket size		Socket extension mm	Ordering No.
	AF mm / in	mm		
LTV69 N270-FS, LTV69 N370-FS	17	9	4220 1794 32	
	18	5.5	4220 1994 03	
	19	5.5	4220 1794 08	
	21	4	4220 3117 01	
	21	11	4220 3117 05	
	22	9	4220 1794 07	
	22	4	4220 3117 00	
	24	17	4220 1794 02	
	24	9	4220 1794 04	
	27	9	4220 1794 09	
	28	9	4220 1794 06	
	28	19	4220 1794 05	
	30	11	4220 1794 01	
	13/16	4	4220 3117 03	
	13/16	11	4220 3117 04	
LTV69 N450-FS, LTV69 N600-FS	7/8	11	4220 1794 30	
	15/16	4	4220 3117 06	
	1 1/8	9	4220 1794 10	
	24		4220 1987 24	
	30		4220 1987 02	
	36		4220 1987 01	
	38		4220 1987 04	
	41		4220 1987 03	
	1 1/8		4220 1987 15	
	1 1/8		4220 1987 30	

## Optional Accessories for Crowfoot tools

### HEX SOCKETS

Width across flats		Ordering No.
mm	in	
<b>For LTC38 R33/N41-13-A-O-3<sup>a</sup></b>		
	7/16	4210 2625 03
12		4210 2625 04
	1/2	4210 2625 01
13		4210 2625 00
14		4210 2625 02
15		4210 2625 06
<b>For LTC38 R40/N48-17-A-O-3<sup>b</sup>, LTC48 R56-17-A-O-3<sup>b</sup></b>		
13		4210 2626 06
14		4210 2626 04
15		4210 2626 03
	1/2	4210 2626 05
	5/8	4210 2626 02
16		4210 2626 00
17		4210 2626 01
18		4210 2626 10
19		4210 2626 08
<b>For LTC48 R96/R120-19-A-O-3<sup>c</sup></b>		
13		4210 2624 06
14		4210 2624 05
15		4210 2624 04
16		4210 2624 03
17		4210 2624 02
18		4210 2624 01
19	3/4	4210 2624 00

Model	H mm	B mm	C mm
LTC38 R33-13-A-O-3	19	32	16
LTC38 R40-17-A-O-3	19	39	20
LTC48 R56-17-A-O-3	19	39	20
LTC48 R96-19-A-O-3	25	39	20
LTC48 R120-19-A-O-3	25	39	20
LTC38 N41-13-A-O-3	19	32	16

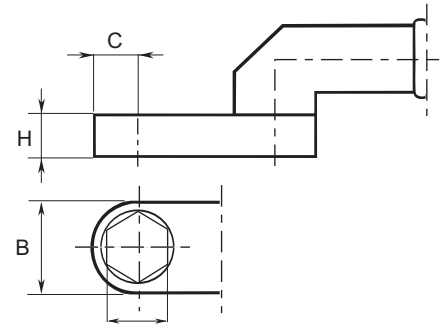

<sup>a</sup> 13 mm socket mounted on tool.

<sup>b</sup> 17 mm socket mounted on tool.

<sup>c</sup> 19 mm socket mounted on tool.

## Optional Accessories for Open End Type

### SOCKETS

A Socket size mm	B Open end mm	Ordering No.
<b>LTO28 R12-10-L-I-3</b>		
5/16"	7	4210 4288 54
8 mm	7	4210 4288 55
3/8"	7	4210 4288 53
9 mm	7	4210 4288 52
10 mm	7	4210 4288 51
<b>LTO28 R15-10-L-I-3</b>		
8 mm	8	4210 4289 56
9 mm	8	4210 4289 55
3/8"	8	4210 4289 54
10 mm	8	4210 4289 51
11 mm	8	4210 4289 57
7/16"	8	4210 4289 58
12 mm	8	4210 4289 53
<b>LTO28 R17-13-L-I-3</b>		
3/8"	8.5	4210 4290 52
10 mm	8.5	4210 4290 53
11 mm	8.5	4210 4290 59
7/16"	8.5	4210 4290 54
12 mm	8.5	4210 4290 57
1/2"	8.5	4210 4290 55
13 mm	8.5	4210 4290 51
14 mm	8.5	4210 4290 58
9/16"	8.5	4210 4290 56

A Socket size mm	B Open end mm	Ordering No.
<b>LTO38 R26-13-L-I-3</b>		
11 mm	12.5	4210 4291 63
13 mm	12.5	4210 4291 51
14 mm	12.5	4210 4291 58
9/16"	12.5	4210 4291 53
15 mm	12.5	4210 4291 55
5/8"	12.5	4210 4291 54
16 mm	12.5	4210 4291 52
17 mm	12.5	4210 4291 60
11/16"	12.5	4210 4291 56
18 mm	12.5	4210 4291 61
19 mm	12.5	4210 4291 62
3/4"	12.5	4210 4291 57
<b>LTO38 R26-17-L-I-3</b>		
14 mm	14	4210 4292 55
5/8"	14.6	4210 4292 54
17 mm	16	4210 4292 51
18 mm	16	4210 4292 53
19 mm	16	4210 4292 57
3/4"	16	4210 4292 52
20 mm	16	4210 4292 61
13/16"	16	4210 4292 63
21 mm	16	4210 4292 62
22 mm	16	4210 4292 56
7/8"	16	4210 4292 58
15/16"	16	4210 4292 60
24 mm	17.2	4210 4292 59

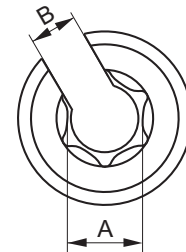



## Optional Accessories for Stall type

### FEMALE HEX SOCKETS

Dimensions in	Ordering No. LBR33 S26/114	Ordering No. LBR33 S26/118	Dimensions mm	Ordering No. LBR33 S26/114	Ordering No. LBR33 S26/118
1/4	4210 0360 05	–	10	4210 0414 10	–
5/16	4210 0360 02	–	12	4210 0414 12	4210 0418 12
3/8	4210 0360 03	4210 0389 02	13	4210 0414 13	4210 0418 13
7/16	4210 0360 04	4210 0389 03	14	4210 0414 14	4210 0418 14
1/2	4210 0360 01	4210 0389 04	15	4210 0414 15	4210 0418 15
9/16	–	4210 0389 06	16	–	4210 0418 16
5/8	–	4210 0389 01	17	–	4210 0418 17
3/4	–	4210 0389 05	18	–	4210 0418 18
			19	–	4210 0389 05

NOTE: That 1/2" female hex sockets must be used together with socket adapters.

### SOCKET ADAPTERS

Dimensions	Ordering No. LBR33 S26/114	Ordering No. LBR33 S26/118
1/2" hex 3/8" square drive	4090 0163 00	4090 0163 00
1/2" hex 1/2" square drive	4090 0164 00	4090 0164 00

## Optional Accessories for Hold and Drive tools

### NUT SOCKET, SCREW HOLDER AND BIT HOLDER FOR LTV38 R42-HAD/LTV38 R50-HAD AND ETV ST61-28/50 HAD

#### Nut socket (Fig. 1)

Width across flats W mm	Socket Ø D mm	A	Ordering No. B	C
10	22	4220 1769 16	4220 1769 31	4220 1769 51
11	22	4220 1769 15	4220 1769 32	4220 1769 52
12	22	4220 1769 13	4220 1769 33	4220 1769 53
13	22	4220 1769 09	4220 1769 12	4220 1769 54
14	22	4220 1769 05	4220 1769 35	4220 1769 08
15	22	4220 1769 14	4220 1769 36	4220 1769 56
16	25	4220 1888 71	4220 1888 81	4220 1888 91
17	25	4220 1888 72	4220 1888 82	4220 1888 92
18	26	4220 1888 73	4220 1888 83	4220 1888 93
19	27	4220 1888 74	4220 1888 84	4220 1888 94
20	31	4220 1888 75	4220 1888 85	4220 1888 95
21	31	4220 1888 76	4220 1888 86	4220 1888 96

Measurements in mm

Figure 1

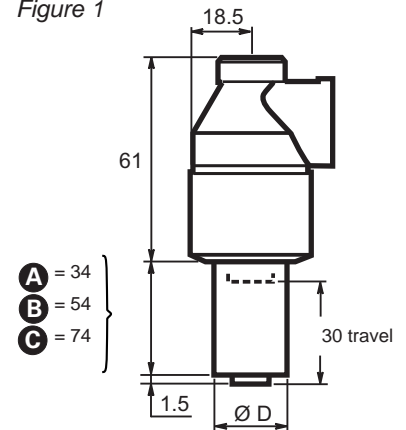

#### Screw holder

Dimension X x Y mm	Suitable socket size mm	A	Ordering No. B	C
6.6 x 5	10-21	4220 1770 19	–	–
7 x 5	10-21	–	4220 1770 17	–
8.2 x 5.1	10-21	4220 1770 01	–	4220 1770 16
8 x 6	10-21	4220 1770 02	–	–

Two flats

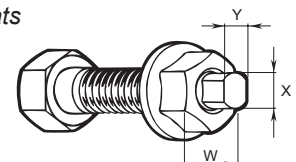

#### Bit holder

Bit holder 1/4"				
A	B	C	Width N, mm	Bits
4220 1959 01	4220 1959 04	4220 1959 03	10-21	1/4"

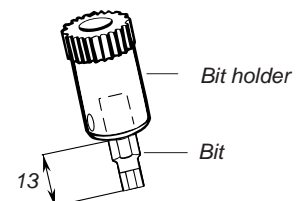

## Optional Accessories for Hold and Drive tools

### NUT SOCKET, SCREW HOLDER AND BIT HOLDER FOR LTV48 R100-HAD AND ETV ST61/81-100-HAD

#### Nut socket (Fig. 2)

Width across flats W mm	Socket Ø D mm	Ordering No.		
		<b>A</b>	<b>B</b>	<b>C</b>
13	21	4220 4477 13	4220 4477 33	4220 4477 53
14	22	4220 4477 14	4220 4477 34	4220 4477 54
15	23	4220 4477 15	4220 4477 35	4220 4477 55
16	24	4220 4477 16	4220 4477 36	4220 4477 56
17	27	4220 4477 17	4220 4477 37	4220 4477 57
18	27	4220 4477 18	4220 4477 38	4220 4477 58
19	29	4220 4477 19	4220 4477 39	4220 4477 59
21	30	4220 4477 21	4220 4477 41	4220 4477 61
22	32	4220 4477 22	4220 4477 42	4220 4477 62
24	34	4220 4477 24	4220 4477 44	4220 4477 64

Measurements in mm

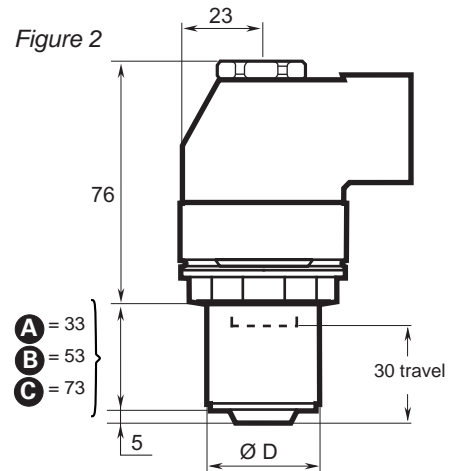

#### Screw holder – Two flats

Dimension X x Y mm	Suitable socket size mm	Ordering No.		
		<b>A</b> 33 mm	<b>B</b> 53 mm	<b>C</b> 73 mm
7x5	13-24	4220 4524 05	4220 4524 15	4220 4524 25
8x6	13-24	4220 4524 06	4220 4524 16	4220 4524 26
8x6.3	13-24	4220 4524 07	4220 4524 17	4220 4524 27
9.55x7.6	14-24	4220 4524 08	4220 4524 18	4220 4524 28
11.20x8.9	16-24	4220 4524 09	4220 4524 19	4220 4524 29
13x9.8	16-24	4220 4524 10	4220 4524 20	4220 4524 30

Two flats

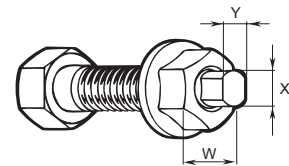

#### Screw holder – Male hexagon

Dimension N mm	Suitable socket size mm	Ordering No.		
		<b>A</b> 33 mm	<b>B</b> 53 mm	<b>C</b> 73 mm
5	13-24	4220 4478 15	4220 4478 25	4220 4478 45
6	13-24	4220 4478 16	4220 4478 26	4220 4478 46
7	13-24	4220 4478 07	4220 4478 27	4220 4478 47
8	13-24	4220 4478 08	4220 4478 28	4220 4478 48
9	14-24	4220 4478 09	4220 4478 29	4220 4478 49
10	16-24	4220 4478 10	4220 4478 30	4220 4478 50
11	16-24	4220 4478 11	4220 4478 31	4220 4478 51

Male hexagon

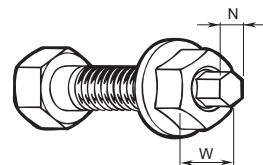

#### Bit holder 1/4" – Female hexagon

Suitable socket size mm	Ordering No.		
	<b>A</b> 33 mm	<b>B</b> 53 mm	<b>C</b> 73 mm
13-24	4220 4524 60	4220 4524 61	4220 4524 62

Female hexagon

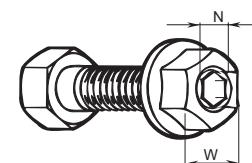

## Optional Accessories for Hold and Drive tools

**NUT SOCKET, SCREW HOLDER AND BIT HOLDER FOR LTV38 R40 LT/R 85 HAD, LTV48 HAD AND ETV ST61/81-100-HAD-HD/120/150/180/200 HAD**

### Nut socket (Fig. 3)

Width across flats W mm	Socket Ø D mm	A	Ordering No. B	C
13	30	4210 3513 13	4210 3513 33	4210 3513 53
14	30	4210 3513 14	4210 3513 34	4210 3513 54
15	30	4210 3513 15	4210 3513 35	4210 3513 55
16	30	4210 3513 16	4210 3513 36	4210 3513 56
17	30	4210 3513 17	4210 3513 37	4210 3513 57
18	31	4210 3513 18	4210 3513 38	4210 3513 58
19	32	4210 3513 19	4210 3513 39	4210 3513 59
21	35	4210 3513 21	4210 3513 41	4210 3513 61
22	35	4210 3513 22	4210 3513 42	4210 3513 62
24	35	4210 3513 24	4210 3513 44	4210 3513 64

Measurements in mm

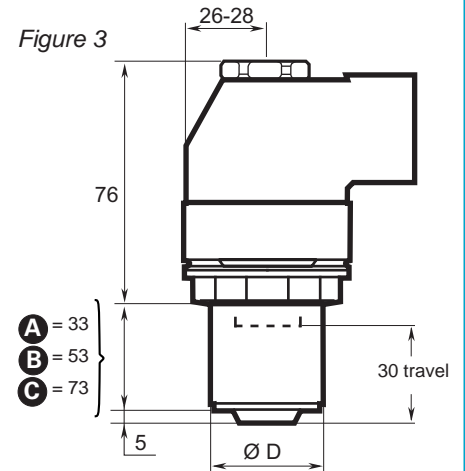

### Screw holder – Two flats

Dimension X x Y mm	Suitable socket size mm	A	Ordering No. B	C
8 x 6.3	15-24	4210 2694 17	4210 2694 18	4210 2694 19
8 x 6	15-24	4210 2694 05	4210 2694 10	4210 2694 15
9.55 x 7.6	18-24	4210 2694 01	4210 2694 06	4210 2694 11
11.20 x 8.9	19-24	4210 2694 02	4210 2694 07	4210 2694 12
13 x 9.8	19-24	4210 2694 03	4210 2694 08	4210 2694 13
13.20 x 10.5	19-24	4210 2694 04	4210 2694 09	4210 2694 14

Two flats

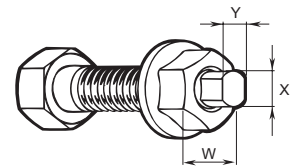

### Screw holder – Male hexagon

Dimension N mm	Suitable socket size mm	A	Ordering No. B	C
7	14-24	4210 2825 41	4210 2825 42	4210 2825 43
8	14-24	4210 2825 01	4210 2825 05	4210 2825 09
9	15-24	4210 2825 02	4210 2825 06	4210 2825 10
10	18-24	4210 2825 03	4210 2825 07	4210 2825 11
11	19-24	4210 2825 04	4210 2825 08	4210 2825 12
12	19-24	4210 2825 13	4210 2825 14	4210 2825 15

Male hexagon

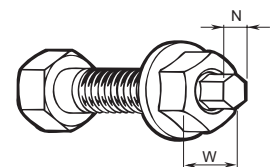

### Bit holder – Female hexagon

Bit holder 5/16"			5/16" Bits	
A	B	C	Width N, mm	Ordering No.
4210 2991 91	4210 2991 92	4210 2991 93	5	4023 1215 00
			6	4023 1216 00
			7	4023 1219 00
			8	4023 1217 00
			10	4023 1218 00

Female hexagon

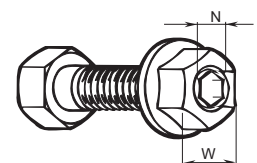

## Optional Accessories for Hold and Drive tools

### NUT SOCKET, SCREW HOLDER AND BIT HOLDER FOR LTV69 R370-HAD AND ETV ST101-370-HAD

#### Nut socket (Fig. 4)

Width across flats W mm	Socket Ø D mm	Ordering No.		
		A	B	C
18	41	4220 1778 04	4220 1778 14	4220 1778 24
19	41	4220 1778 05	4220 1778 15	4220 1778 25
20	41	4220 1778 06	4220 1778 16	4220 1778 26
21	41	4220 1778 07	4220 1778 17	4220 1778 27
22	41	4220 1778 08	4220 1778 18	4220 1778 28
23	41	4220 1778 09	4220 1778 19	4220 1778 29
24	41	4220 1778 01	4220 1778 11	4220 1778 21
25	41	4220 1778 02	4220 1778 12	4220 1778 22
25.4=1"	41	4220 1778 10	4220 1778 20	4220 1778 30
26	41	4220 1778 03	4220 1778 13	4220 1778 23
27	46	—	4220 2139 84	4220 2139 94
28	46	—	4220 2139 83	4220 2139 93
29	46	—	4220 2139 82	4220 2139 92
30	46	—	4220 2139 81	4220 2139 91
31	54	—	4220 2297 81	4220 2297 91
32	54	—	4220 2297 82	4220 2297 92
33	54	—	4220 2297 83	4220 2297 93
34	54	—	4220 2297 84	4220 2297 94
35	54	—	4220 2297 85	4220 2297 95
36	54	—	4220 2297 86	4220 2297 96

Measurements in mm

Figure 4

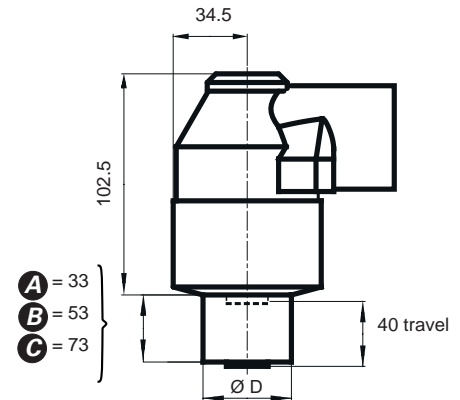

#### Screw holder – Two flats for LTV69 R370-HAD

Dimension X x Y N mm	Suitable socket size mm	Ordering No.		
		A	B	C
13 x 9.8	18-36	4220 1777 80	4220 1777 83	4220 1777 85
13.20 x 10.5	18-36	4220 1777 81	4220 1777 84	4220 1777 86

#### Screw holder – Male hexagon for LTV69 R370-HAD

Dimension N mm	Suitable socket size mm	Ordering No.		
		A	B	C
10	18-36	4220 1777 52	4220 1777 54	4220 1777 72
11	18-36	4220 1777 51	4220 1777 50	4220 1777 73
12	20-36	4220 1777 53	4220 1777 55	4220 1777 74
14	20-36	4220 1777 57	4220 1777 56	4220 1777 75
16	24-36	4220 1777 58	4220 1777 70	4220 1777 76
18	24-36	4220 1777 59	4220 1777 71	4220 1777 77

#### Bit holder

Bit holder	Socket size mm	Ordering No.		
		A	B	C
7	14-24	4210 2825 41	4210 2825 42	4210 2825 43
5/16"	18-20	4220 1777 88	4220 1777 89	4220 1777 90
5/16"	21-36	4220 1777 82	4220 1777 85	4220 1777 87

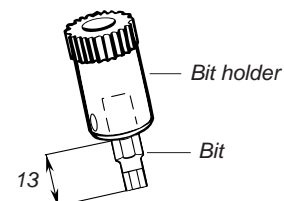

NOTE: 8 mm bit is included in the bit holders.



## Productivity Kits

Model	Max air flow	Hose, 5 m	Coupling	Lubrication	Ordering No.
<b>For small nutrunners with 3/8" BSP air inlet</b>					
MIDI Optimizer F/RD EQ08-C10	16 l/s	Cabclair 10 mm	ErgoQIC 08	Yes	8202 0850 07
<b>For small nutrunners with 1/4" BSP air inlet</b>					
MIDI Optimizer F/RD EQ08-C10	16 l/s	Cabclair 10 mm	ErgoQIC 08	Yes	8202 0850 03
MIDI Optimizer F/RD EQ10-R10	16 l/s	Rubair 10 mm	ErgoQIC 10	Yes	8202 0850 16
<b>For nutrunners with 3/8" BSP air inlet</b>					
MIDI Optimizer F/RD EQ10-C13	23 l/s	Cabclair 13 mm	ErgoQIC 10	Yes	8202 0850 02
<b>For nutrunners with 1/4" BSP air inlet</b>					
MIDI Optimizer F/RD EQ10-C13-1/4	23 l/s	Cabclair 13 mm	ErgoQIC 10	Yes	8202 0850 11
<b>For nutrunners with 3/8" BSP air inlet</b>					
MIDI Optimizer F/RD EQ10-T13	35 l/s	Turbo 13 mm	ErgoQIC 10	Yes	8202 0850 17
<b>For nutrunners with 1/2" BSP air inlet</b>					
MIDI Optimizer F/R EQ10-T13	35 l/s	Turbo 13 mm	ErgoQIC 10	No	8202 0850 04
MIDI Optimizer F/RD EQ10-T13	35 l/s	Turbo 13 mm	ErgoQIC 10	Yes	8202 0850 13



## Service Kits

The spare parts included in the service kits cover a normal overhaul of your tool. Always have them available for a fast and economical repair.

Main parts included:

- Vane kit
- Motor bearings
- Gaskets
- O-rings
- Circlips
- Pins etc.

Model	Service kit
LTV28	4081 0102 90
LTV29-2	4081 0299 90
LTV38	4081 0103 90
LTV39-2	4081 0298 90
LTV48	4081 0236 90
LTV69	4081 0397 90

## Fast, flexible and user-friendly

The LTD system offers a flexible, low-cost solution to many advanced tightening requirements. With fixtured tools the operator influence is minimized and very high torque accuracy is achieved.

### ARTICULATING ARMS

Where a fixed support on the workpiece for a reaction bar is not available, a telescopic or articulated arm mounted LTD nutrunner can be an efficient solution.

- **Reaction bar blanks** – For single spindle hand-held applications.
- **Mounting plates** – The LTD straight nutrunners have a splined reaction bar connection which can also be used for fixed assembly of the nutrunner. A number of standard mounting plates are available to order.
- **Floating square drive** – For two or more spindles the units must usually have floating spindles to compensate for run-down variations. Models with floating square drive or telescopic front parts are available.
- **Fixture punches** – For mounting of the nutrunner to locally made base plates a punch for the splines connection is available as optional equipment.
- **Air signal outlets** – All LTD models are equipped with air signal outlets for completed operation.

### THE LTD SYSTEM

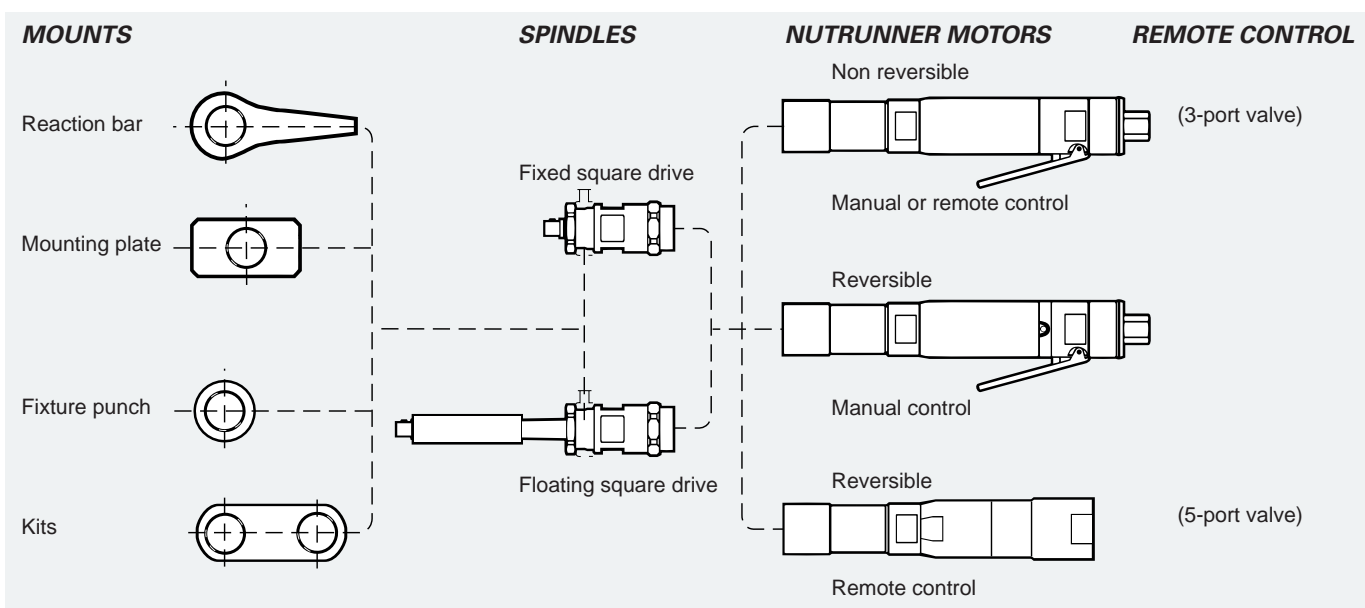

LTD28, 38 and 48 straight nutrunners are based on the power package and clutch from the LTV angle nutrunners.

LTD nutrunners are based on the unique LTP range of twin motor pistol grip nutrunners. With fast run-down and accurate final tightening they offer high productivity and unmatched torque accuracy as well as joint independence.

- Remote control back head – A remote valve is connected to the back head of the LTD-RR tools allowing a better multiple.
- Accessibility – Slim design allows the building of smooth, simple multiples or paired spindle designs. The absence of a clutch makes these tools shorter.
- Flexibility – The range of LTD tools provides you with the options you need to meet your requirements.
- Reversibility – Reversible LTD tools are available.



LTD28



LTD61

Model	Bolt size mm	Square drive in	Torque range soft joint		Free speed r/min	Weight		Length mm	CS distance mm	Air consumption at free speed		Rec. hose size mm	Air inlet thread in	Ordering No.
			Nm	ft lb		kg	lb			l/s	cfm			
<b>Non reversible, lever start</b>														
LTD28 N18-RE	M6	3/8	8-18	6-13	780	1.2	2.6	358	20	9	19	10	1/4	8431 0534 08
LTD28 N22-RE	M6	3/8	10-22	7-16	140	1.2	2.6	358	20	9	19	10	1/4	8431 0534 18
<b>Reversible, lever start</b>														
LTD28 R8-RE	M5-6	3/8	3-8	2-6	1100	1.2	2.6	363	20	8	17	10	1/4	8431 0534 61
LTD28 R16-RE	M6	3/8	7-16	6-12	610	1.3	2.9	383	20	8	17	10	1/4	8431 0534 65
LTD28 R20-RE	M6-8	3/8	10-20	7-15	520	1.3	2.9	383	20	8	17	10	1/4	8431 0534 51
LTD28 R22-RE	M6-8	3/8	10-22	7-16	125	1.3	2.9	383	20	8	17	10	1/4	8431 0534 54
<b>Reversible, remote control back head</b>														
LTD13 R05-RR	M3-5	1/4 <sup>b</sup>	1.5-5	1.1-3.7	850	0.7	1.6	197	16	7	15	8	1/8	8431 0533 05
LTD13 R08-RR	M3-5	1/4 <sup>b</sup>	1.5-8	1.1-6	500	0.8	1.7	197	16	7	15	8	1/8	8431 0533 06
LTD28 R16-RR	M6	3/8	7-16	6-12	610	1.3	2.9	313	20	8	17	10/13	<sup>a</sup>	8431 0703 82
LTD28 R20-RR	M6-8	3/8	10-20	7-15	520	1.3	2.9	313	20	8	17	10/13	<sup>a</sup>	8431 0703 83
<b>Non reversible, lever start, telescopic front part, travel 25 mm</b>														
LTD28 N18F-RE	M6	3/8	8-18	6-13	780	1.6	3.5	466	20	9	19	10	1/4	8431 0534 27
LTD28 N21F-RE	M6	3/8	10-21	7-15	570	1.6	3.5	466	20	9	19	10	1/4	8431 0534 39
<b>Reversible, lever start, telescopic front part, travel 25 mm</b>														
LTD28 R16F-RE	M6	3/8	7-16	6-12	620	1.7	3.7	491	20	8	17	10	1/4	8431 0534 85
LTD28 R20F-RE	M6-8	3/8	10-20	7-15	570	1.7	3.7	491	20	8	17	10	1/4	8431 0534 37
LTD28 R22F-RE	M6-8	3/8	10-22	7-16	125	1.7	3.7	491	20	8	17	10	1/4	8431 0534 89
<b>Reversible, remote control back head, telescopic front part, travel 25 mm</b>														
LTD28 R8F-RR	M5-6	3/8	3-8	2-6	1100	1.6	3.5	401	20	8	17	10/13	<sup>a</sup>	8431 0703 84
LTD28 R16F-RR	M6	3/8	7-16	6-12	620	1.7	3.7	421	20	8	17	10/13	<sup>a</sup>	8431 0703 86
LTD28 R20F-RR	M6-8	3/8	10-20	7-15	570	1.7	3.7	421	20	8	17	10/13	<sup>a</sup>	8431 0703 88
<b>Non-reversible, lever start</b>														
LTD38 N30-RE	M8	1/2	14-30	10-21	820	2.2	4.8	414	20	16	34	10	1/4	8431 0535 04
LTD38 N55-RE	M10	1/2	27-55	20-40	470	2.2	4.8	487	20	20	42	10	1/4	8431 0535 20
<b>Reversible, lever start</b>														
LTD38 R27-RE	M8	1/2	13-27	10-20	670	2.1	4.6	441	20	16	34	10	1/4	8431 0534 53
LTD38 R32-RE	M8	1/2	18-32	13-24	560	2.1	4.6	441	20	16	34	10	1/4	8431 0534 52
LTD38 R38-RE	M8-10	1/2	19-38	14-28	480	2.1	4.6	441	20	16	34	10	1/4	8431 0535 78
LTD38 R47-RE	M8-10	1/2	22-47	16-35	380	2.3	5.1	513	20	20	42	10	1/4	8431 0535 83
<b>Reversible, remote control back head</b>														
LTD38 R27-RR	M8	1/2	13-27	10-20	670	2.1	4.6	377	21	16	34	10/16	<sup>a</sup>	8431 0704 22
LTD38 R32-RR	M8	1/2	18-32	13-24	560	2.1	4.6	377	21	16	34	10/16	<sup>a</sup>	8431 0704 24
LTD38 R38-RR	M8-10	1/2	19-38	14-28	480	2.1	4.6	377	21	16	34	10/16	<sup>a</sup>	8431 0704 26
LTD38 R47-RR	M8-10	1/2	22-47	16-35	380	2.3	5.1	448	21	16	34	10/16	<sup>a</sup>	8431 0704 28

<sup>a</sup> Air inlet thread = 2 x 1/4" + 1 x 3/8".

<sup>c</sup> Air inlet thread = 2 x 1/2" + 1 x 3/4".

<sup>b</sup> 1/4" quick change chuck.

Continued...

Model	Bolt size mm	Square drive in	Torque range soft joint		Free speed r/min	Weight		Length mm	CS distance mm	Air consumption at free speed		Rec. hose size mm	Air inlet thread in	Ordering No.
			Nm	ft lb		kg	lb			l/s	cfm			
<b>Non-reversible, lever start, telescopic front part, travel 25 mm</b>														
LTD38 N30F-RE	M8	1/2	14-30	10-21	820	2.3	5.0	521	20	20	42	10	1/4	8431 0535 38
LTD38 N44F-RE	M8-10	1/2	18-44	13-32	580	2.3	5.0	521	20	20	42	10	1/4	8431 0535 31
<b>Reversible, lever start, telescopic front part, travel 25 mm</b>														
LTD38 R27F-RE	M8	1/2	13-27	10-20	670	2.5	5.5	546	20	16	34	10	1/4	8431 0535 65
LTD38 R32F-RE	M8	1/2	18-32	13-24	560	2.5	5.5	546	20	16	34	10	1/4	8431 0535 91
LTD38 R47F-RE	M8-10	1/2	22-47	16-35	380	2.7	5.9	625	23	16	34	10	1/4	8431 0535 99
<b>Reversible, remote control back head, telescopic front part, travel 25 mm</b>														
LTD38 R27F-RR	M8	1/2	13-27	10-20	670	2.5	5.5	482	21	16	34	10/16	<sup>a</sup>	8431 0704 30
LTD38 R32F-RR	M8	1/2	18-32	13-24	560	2.5	5.5	482	21	16	34	10/16	<sup>a</sup>	8431 0704 32
LTD38 R38F-RR	M8-10	1/2	19-38	14-28	480	2.5	5.5	482	21	16	34	10/16	<sup>a</sup>	8431 0704 34
LTD38 R47F-RR	M8-10	1/2	22-47	16-35	380	2.7	5.9	566	23	16	34	10/16	<sup>a</sup>	8431 0704 36
<b>Reversible, lever start</b>														
LTD48 R65-RE	M10	1/2	27-65	20-48	400	3.1	6.8	582	30	28	59	12.5	1/2	8431 0637 07
LTD48 R81-RE	M12	1/2	32-81	24-60	320	3.1	6.8	582	30	28	59	12.5	1/2	8431 0637 12
<b>Reversible, remote control back head</b>														
LTD48 R65-RR	M10	1/2	27-65	20-48	400	3.5	7.7	410	28	30	63	12.5/16	<sup>c</sup>	8431 0704 46
LTD48 R81-RR	M12	1/2	32-81	24-60	330	3.5	7.7	410	28	30	63	12.5/16	<sup>c</sup>	8431 0704 48
<b>Reversible, lever start, telescopic front part, travel 25 mm</b>														
LTD48 R65F-RE	M10	1/2	27-65	20-48	400	3.5	7.7	700	30	28	59	12.5	1/2	8431 0637 17
LTD48 R81F-RE	M12	1/2	32-81	24-60	320	3.5	7.7	700	30	28	59	12.5	1/2	8431 0637 23
<b>Reversible, remote control back head</b>														
LTD48 R65F-RR	M10	1/2	27-65	20-48	400	3.7	8.2	522	28	30	63	12.5/16	<sup>c</sup>	8431 0704 50
LTD48 R81F-RR	M12	1/2	32-81	24-60	330	3.7	8.2	522	28	30	63	12.5/16	<sup>c</sup>	8431 0704 52

<sup>a</sup> Air inlet thread = 2 x 1/4" + 1 x 3/8".

<sup>c</sup> Air inlet thread = 2 x 1/2" + 1 x 3/4".

<sup>b</sup> 1/4" quick change chuck.

Model	Bolt size mm	Square drive in	Torque range at 6.3 bar		Min torque at 3 bar		Free speed r/min	Weight		Length mm	CS distance mm	Air consumption at free speed		Air inlet thread in	Spline type	Ordering No.
			Nm	ft lb	Nm	ft lb		kg	lb			l/s	cfm			
<b>Torque control models with fixed square drive</b>																
LTD61 H100-13-RE	M12	1/2	55-100	40-75	45	35	1800	3.0	6.6	223	29	20	42	3/8	3	8431 0808 06
LTD61 H170-13-RE	M14	1/2	95-170	70-125	70	50	1100	3.0	6.6	223	29	20	42	3/8	3	8431 0808 15
LTD61 H230-19-RE	M16	3/4	125-230	90-170	85	60	820	3.0	6.6	223	29	20	42	3/8	3	8431 0808 23
LTD61 H350-20-RE	M18	3/4	190-350	140-255	145	105	520	3.9	8.6	260	31	20	42	3/8	4	8431 0808 27
LTD61 H500-20-RE	M20	3/4	275-500	200-370	220	160	360	3.9	8.6	260	31	20	42	3/8	4	8431 0808 36
LTD61 H700-25-RE	M22	1	360-650	265-480	280	207	280	4.5	9.9	305	34	20	42	3/8	5	8431 0808 43
LTD61 H900-25-RE	M24	1	480-870	350-640	300	220	210	4.5	9.9	282	32	20	42	3/8	5	8431 0808 45

**NOTE:** Change over torque is around 4% of maximum torque on a given pressure.



## Dimensions

### TELESCOPIC FRONT PART LTD61

Model	Dimensions						Ordering No.
	N in	D mm	F mm	L mm	M mm	t mm	
LTD61 H100, H170	1/2	34	25	101	127	12	4210 3864 80
LTD61 H230	3/4	41	25	117	148	12	4210 3789 80
LTD61 H350, H500	3/4	50	40	160	201	15	4210 3781 81
LTD61 H700, H900	1	67	50	226	278	15	4210 3788 80

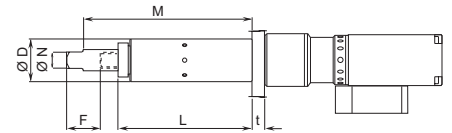

## Accessories Included

### FOR ALL MODELS

Torque adjustment key

## Productivity Kits

Model	Max air flow	Hose, 5 m	Coupling	Lubrication	Ordering No.
<b>For small nutrunners with 3/8" BSP air inlet</b>					
MIDI Optimizer F/RD EQ08-C10	16 l/s	Cablair 10 mm	ErgoQIC 08	Yes	8202 0850 07
<b>For small nutrunners with 1/4" BSP air inlet</b>					
MIDI Optimizer F/RD EQ08-C10	16 l/s	Cablair 10 mm	ErgoQIC 08	Yes	8202 0850 03
MIDI Optimizer F/RD EQ10-R10	16 l/s	Rubair 10 mm	ErgoQIC 10	Yes	8202 0850 16
<b>For nutrunners with 3/8" BSP air inlet</b>					
MIDI Optimizer F/RD EQ10-C13	23 l/s	Cablair 13 mm	ErgoQIC 10	Yes	8202 0850 02
<b>For nutrunners with 1/4" BSP air inlet</b>					
MIDI Optimizer F/RD EQ10-C13-1/4	23 l/s	Cablair 13 mm	ErgoQIC 10	Yes	8202 0850 11
<b>For nutrunners with 3/8" BSP air inlet</b>					
MIDI Optimizer F/RD EQ10-T13	35 l/s	Turbo 13 mm	ErgoQIC 10	Yes	8202 0850 17
<b>For nutrunners with 1/2" BSP air inlet</b>					
MIDI Optimizer F/R EQ10-T13	35 l/s	Turbo 13 mm	ErgoQIC 10	No	8202 0850 04
MIDI Optimizer F/RD EQ10-T13	35 l/s	Turbo 13 mm	ErgoQIC 10	Yes	8202 0850 13



## Service Kits



Model	General service kit
LTD61	4081 0397 90

Optional Accessories

REACTION BAR

	Dimensions mm	LTD38 N55/R47 LTD48 LMD/LTD61 -13, -19      LMD/LTD61 -20      LMD/LTD61 -25				
		LTD28	LTD38	LMD/LTD61 -13, -19	LMD/LTD61 -20	LMD/LTD61 -25
Bar blank (steel)	<b>L</b> 250 200 500	4210 1798 00	4210 2134 00	4210 2219 82	4210 2183 80	4210 2726 80
Bar blank (aluminum)	400			4210 2219 81		

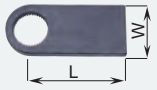
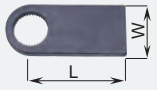
MOUNTING PLATE

		Dimensions mm	LTD38 N55/R47 LTD48 LMD/LTD61 -13,-19      LMD/LTD61 -20      LMD/LTD61 -25			
			LTD28	LTD38	LMD/LTD61 -13,-19	LMD/LTD61 -20
Side mount		<b>L x W</b> 90 x 40 120 x 70	4210 1798 01	4210 2134 01		4210 2809 80      4210 2808 80
Center mount		<b>L x W</b> 70 x 40 100 x 50 125 x 65	4210 1798 02	4210 2134 02	4210 2219 03	4210 2183 01      4210 2726 01
Flange mount		<b>D 55</b>			4210 2219 10	

# An optimum combination of torque, speed and weight

*With the range of pistol grip nutrunners from Atlas Copco you get the highest possible torque and speed in relation to the weight of the tool. Fast, accurate and highly operator friendly, the tools are available in reversible versions for maximum flexibility.*

### **FAST AND ACCURATE**

In LTP/LMP61 tools the twin motor concept provides extremely fast rundown with good torque accuracy, even on soft joints.

### **OPERATOR FRIENDLY**

Our pistol grip nutrunners are comfortable to operate. The reaction bar eliminates reaction forces and the exhaust through the handle arrangement keeps noise levels low.

Single-handed operation combined with the low weight and perfectly balanced pistol grip design make LMP24/61 and LTP61 nutrunners safe and comfortable to use.

### **REVERSIBLE FOR MAXIMUM FLEXIBILITY**

Being able to loosen fasteners without changing tools saves time and effort and raises productivity.



The twin motor in the 61 series gives faster production and increased accuracy with a minimum of air consumption. Torque level on LMP models depends on the pressure of the air fed to the tool, higher pressure creates higher torque.

- High torque accuracy.
- Swiveling function makes tool positioning easy on the 61 series.
- Fast rundown motor saves time.
- Extremely good torque output to weight ratio compared to single motor pistol grip nutrunners.
- Available as both reversible and non-reversible models.



Model	Bolt size mm	Square drive in	Max torque at 6.3 bar		Min torque at 3 bar		Free speed r/min	Weight <sup>a</sup>		Length mm	CS distance mm	Air consumption at free speed		Air inlet thread in	Spline type	Ordering No.
			Nm	ft lb	Nm	ft lb		kg	lb			l/s	cfm			
<b>Non-reversible</b>																
LMP61 H500-20	M20	3/4	500	370	300	220	450	3.9	8.6	260	31	20	42	3/8	4	8431 0803 33
LMP61 H900-25	M24	1	900	665	500	365	260	4.5	9.9	282	34	20	42	3/8	5	8431 0803 47
<b>Reversible</b>																
LMP61 HR170-13	M14	1/2	170	125	100	75	1400	3.0	6.6	238	30	20	42	3/8	3	8431 0804 11
LMP61 HR230-19	M16	3/4	230	170	130	95	1000	3.0	6.6	275	34	20	42	3/8	3	8431 0804 18
LMP61 HR350-20	M18	3/4	350	260	200	145	650	3.9	8.6	275	34	20	42	3/8	4	8431 0804 25
LMP61 HR500-20	M20	3/4	500	370	300	220	450	3.9	8.6	320	35	21	42	3/8	4	8431 0804 32
LMP61 HR700-25	M22	1	700	520	400	295	350	4.5	9.9	305	34	20	42	3/8	5	8431 0804 39
LMP61 HR900-25	M24	1	900	665	500	365	260	4.5	9.9	305	34	20	42	3/8	5	8431 0804 46
LMP61 HR1500-25	M30	1	1600	1180	900	660	140	6.8	14.9	345	42	20	42	3/8	9	8431 0804 53

<sup>a</sup> Weight excluding reaction bar.

**NOTE:** Change over torque is around 4% of maximum torque on a given air pressure.

Recommended hose (61 series) size 13 mm for hose length up to 5 m and 16 mm hose size for length 5-10 m.



- LTP61 models are equipped with twin motors and a shut-off valve to ensure that the tool shuts off when the preset torque level is reached.
- Rundown is twice as fast as the LTP51.
- High torque accuracy.
- Extremely high torque output to weight ratio.
- A reversible tool with fixed positions for both forward and reverse.



LTP61 H900-25

Model	Bolt size mm	Square drive in	Torque range at 6.3 bar		Min torque at 3 bar		Free speed r/min	Weight <sup>a</sup>		Length mm	CS distance mm	Air consumption at free speed		Air inlet thread in	Spline type	Ordering No.
			Nm	ft lb	Nm	ft lb		kg	lb			l/s	cfm			
<b>Non reversible</b>																
LTP61 H100-13	M12	1/2	55-100	40-75	45	35	1800	3.0	6.6	223	29	20	42	3/8	3	8431 0800 07
LTP61 H170-13	M14	1/2	95-170	70-125	70	50	1100	3.0	6.6	223	29	20	42	3/8	3	8431 0800 14
LTP61 H230-19	M16	3/4	125-230	90-170	85	60	820	3.0	6.6	223	29	20	42	3/8	3	8431 0800 21
LTP61 H350-20	M18	3/4	190-350	140-255	145	105	520	3.9	8.6	260	31	20	42	3/8	4	8431 0800 28
LTP61 H500-20	M20	3/4	275-500	200-370	220	160	360	3.9	8.6	260	31	20	42	3/8	4	8431 0800 35
LTP61 H700-25	M22	1	360-650	265-480	280	207	280	4.5	9.9	305	34	20	42	3/8	5	8431 0800 42
LTP61 H900-25	M24	1	480-870	350-640	300	220	210	4.5	9.9	282	32	20	42	3/8	5	8431 0800 49
LTP61 H1500-25	M30	1	850-1500	625-1100	700	516	115	6.8	14.5	323	42	20	42	3/8	9	8431 0800 56
<b>Reversible</b>																
LTP61 HR100-13	M12	1/2	55-100	40-75	45	35	1800	3.0	6.6	235	30	20	42	3/8	3	8431 0801 08
LTP61 HR170-13	M14	1/2	95-170	70-125	70	50	1100	3.0	6.6	238	30	20	42	3/8	3	8431 0801 15
LTP61 HR230-19	M16	3/4	125-230	90-170	85	60	820	3.0	6.6	275	34	20	42	3/8	3	8431 0801 22
LTP61 HR350-20	M18	3/4	190-350	140-255	145	105	520	3.9	8.6	275	34	20	42	3/8	4	8431 0801 29
LTP61 HR500-20	M20	3/4	275-500	200-370	220	160	360	3.9	8.6	275	34	20	42	3/8	4	8431 0801 36
LTP61 HR700-25	M22	1	360-650	265-480	280	207	280	4.5	9.9	305	34	20	42	3/8	5	8431 0801 43
LTP61 HR900-25	M24	1	480-870	350-640	300	220	210	4.5	9.9	305	34	20	42	3/8	5	8431 0801 50
LTP61 HR1500-25	M30	1	850-1500	625-1100	700	516	115	6.8	14.5	345	42	20	42	3/8	9	8431 0801 57
LTP61 HR1900-38	M30	1 1/2	1050-1900	770-1400	800	590	90	14.1	31.0	380	68	20	42	3/8	8	8431 0801 64

<sup>a</sup> Without reaction bar.

Recommended hose size 13 mm for hose length up to 5 m and 16 mm hose size for length 5-10 m.

**NOTE:** Change over torque is around 4% of maximum torque on a given air pressure.

## FOR PREVAILING APPLICATIONS

- LTP61X PH is specially designed to handle prevailing applications, such as locking nuts.
- Special gear gives a higher change-over torque.
- Fast rundown motor handles most of the rundown before the slower but stronger tightening motor is used.



LTP61X PH900-25

Model	Bolt size mm	Square drive in	Torque range at 6.3 bar		Min torque at 3 bar		Free speed r/min	Weight <sup>a</sup>		Length mm	CS distance mm	Air con- sumption at free speed		Air inlet thread in	Spline type	Ordering No.
			Nm	ft lb	Nm	ft lb		kg	lb			l/s	cfm			
<b>Non-reversible</b>																
LTP61X PH100-13	M12	1/2	60-110	45-80	45	33	700	3.0	6.6	223	34	20	42	3/8	3	8431 0908 05
LTP61X PH170-13	M14	1/2	100-180	75-135	70	52	440	3.0	6.6	223	34	20	42	3/8	3	8431 0908 13
LTP61X PH230-19	M16	3/4	130-240	95-180	90	66	320	3.0	6.6	223	34	20	42	3/8	3	8431 0908 18
LTP61X PH350-20	M18	3/4	210-370	155-275	150	110	200	3.9	8.6	260	34	20	42	3/8	4	8431 0908 25
LTP61X PH500-20	M20	3/4	300-520	220-380	200	150	140	3.9	8.6	260	34	20	42	3/8	4	8431 0908 32
LTP61X PH700-25	M22	1	400-680	295-500	280	205	100	4.5	9.9	305	34	20	42	3/8	5	8431 0908 39
LTP61X PH900-25	M24	1	500-900	370-665	350	260	80	4.5	9.9	282	34	20	42	3/8	5	8431 0908 42
LTP61X PH1500-25	M30	1	900-1600	665-1180	650	480	45	6.8	14.9	323	42	20	42	3/8	9	8431 0908 53
<b>Reversible</b>																
LTP61X PHR700-25	M22	1	400-680	295-500	280	205	100	4.5	9.9	305	34	20	42	3/8	5	8431 0908 58
LTP61X PHR900-25	M24	1	500-900	370-665	350	260	80	4.5	9.9	305	34	20	42	3/8	5	8431 0908 62
LTP61X PHR1500-25	M30	1	900-1600	665-1180	650	480	45	6.8	14.9	345	42	20	42	3/8	9	8431 0908 69

<sup>a</sup>Without reaction bar.

Recommended hose size 13 mm for hose length up to 5 m and 16 mm hose size for length 5-10 m.

**NOTE:** Change over torque is around 15% of maximum torque on a given air pressure.

## Productivity Kits

Model	Max air flow	Hose, 5 m	Coupling	Lubrication	Ordering No.
<b>For small nutrunners with 3/8" BSP air inlet</b>					
MIDI Optimizer F/RD EQ08-C10	16 l/s	Cabclair 10 mm	ErgoQIC 08	Yes	8202 0850 07
<b>For small nutrunners with 1/4" BSP air inlet</b>					
MIDI Optimizer F/RD EQ08-C10	16 l/s	Cabclair 10 mm	ErgoQIC 08	Yes	8202 0850 03
MIDI Optimizer F/RD EQ10-R10	16 l/s	Rubair 10 mm	ErgoQIC 10	Yes	8202 0850 16
<b>For nutrunners with 3/8" BSP air inlet</b>					
MIDI Optimizer F/RD EQ10-C13	23 l/s	Cabclair 13 mm	ErgoQIC 10	Yes	8202 0850 02
<b>For nutrunners with 1/4" BSP air inlet</b>					
MIDI Optimizer F/RD EQ10-C13-1/4	23 l/s	Cabclair 13 mm	ErgoQIC 10	Yes	8202 0850 11
<b>For nutrunners with 3/8" BSP air inlet</b>					
MIDI Optimizer F/RD EQ10-T13	35 l/s	Turbo 13 mm	ErgoQIC 10	Yes	8202 0850 17
<b>For nutrunners with 1/2" BSP air inlet</b>					
MIDI Optimizer F/R EQ10-T13	35 l/s	Turbo 13 mm	ErgoQIC 10	No	8202 0850 04
MIDI Optimizer F/RD EQ10-T13	35 l/s	Turbo 13 mm	ErgoQIC 10	Yes	8202 0850 13

## Accessories Included

### FOR LMP/LTP61

Suspension yoke  
 Protective cover  
 For LTP61 HR1900, 2800, 3800 reaction arm

## Optional Accessories

### FOR LMP24

Model	Ordering No.
Hose nipple	9000 0247 00
Swivel attachment	4210 2249 80
Exhaust hose	4210 2053 00
Support handle (for H/HR002 only)	4110 1355 82
Spindle extension 115 mm x 1/2" (for H/HR002 only)	4210 2154 80
50 mm x 3/8" (for H/HR011/005 only)	4210 2158 80
1/4" hex bit holder (for H/HR011/005 only)	4021 0443 00
1/2" square adapter (for H/HR011/005 only)	4210 2157 80

### FOR LMP/LTP61

Model	Ordering No.
Hose nipple	9000 0242 00
Exhaust hose	4210 2201 00
Protective cover Standard LTP61 LTP 61 with MT unit	4210 4672 00 4210 4672 01
Multi torque selector LTP61	4210 4636 95
Quick change retainer – 1/2" square models – 3/4" square models – 1" square models	4250 1190 00 4210 3476 80 4210 3524 80
Shut-off override for LTP61	4210 3545 80
Swivelling type MultiFlex connector 3/8" (BSP)	8202 1350 22
Swivelling type MultiFlex connector 3/8" (NPT)	8202 1350 28



Multi torque selector LTP61



Protective cover

### SWIVELLING SUSPENSION YOKE LMP/LTP61

Model	Ordering No.
<b>Mounting dia Ø 54 mm</b>	4210 3088 80
PH/H 100-13	
PH/H 170-13	
PH/H 230-19	
PH/H 350-20	
PH/H 500-20	
PH/H 700-25	
PH/H 900-25	
<b>Mounting dia Ø 60 mm</b>	4210 3088 84
HR 100-13	
HR 170-13	
HR 230-19	

Model	Ordering No.
<b>Mounting dia Ø 63.5 mm</b>	4210 3088 83
H 1900-38	
H 2800-38	
H 3800-38	
<b>Mounting dia Ø 67 mm</b>	4210 3088 82
HR 350-20	
HR 500-20	
PHR/HR 700-25	
PHR/HR 900-25	
HR 1900-38	4210 3088 85
HR 2800-38	
HR 3800-38	

Model	Ordering No.
<b>Mounting dia Ø 83.5 mm</b>	4210 3088 81
PH/H 1500-25	
PHR/HR 1500-25	

## REACTION BARS LMP/LTP 61

Spline dia mm	Square drive size mm/in	CC distance mm	Ordering No.
<b>Steel bar</b>			
Spline 1	268/36/18		4210 1798 01
Spline 2	270/35/10		4220 1903 00
Spline 3	400/56/12		4210 2219 80
Spline 4	500/62/15		4210 2183 80
Spline 5	500/62/15		4210 2726 80
Spline 6	560/80/15		4220 1200 01
Spline 8	500/150/20		4210 3899 03
Spline 9	500/85/20		4210 3899 80
<b>Square steel bracket</b>			
Spline 3	100/50/12		4210 2219 03
Spline 4	125/65/16		4210 2183 01
Spline 5	125/65/16		4210 2726 01
Spline 6	200/100/15		4220 1200 00
Spline 7	250/150/20		4220 1445 00
Spline 8	250/160/20		4220 1972 91
Spline 9	150/85/20		4210 3899 01
<b>Triangular steel bracket</b>			
Spline 2	73/72/14		4220 2137 02
Spline 3	82/80/15		4220 2137 03
Spline 6	112/109/15		4220 2137 06
Spline 6	150/145/20		4220 2137 16
<b>Sliding drive reaction bar</b>			
Spline 3	1/2	70-120	4210 4481 83
Spline 3	3/4	70-120	4210 4481 63
Spline 3	1/2	82-218	4210 4616 83
Spline 3	3/4	82-218	4210 4616 63
Spline 4	3/4	76-126	4210 4481 84
Spline 4	3/4	82-218	4210 4616 84
Spline 5	1	80-125	4210 4481 85
Spline 5	1	82-218	4210 4616 85
Spline 9	1	80-130	4210 4481 89
Spline 9	1	80-280	4210 4616 89
<b>S-Type reaction bar</b>			
Spline 3	110/18/12		4210 4480 03
Spline 4	120/22/15		4210 4480 04
Spline 5	130/25/15		4210 4480 05
Spline 6	125/25/15		4210 4480 06
Spline 8	200/65/20		4210 4480 08
Spline 9	160/40/20		4210 4480 09
<b>L-Type aluminum bar</b>			
Spline 3	266x300/29/15		4210 2219 08
Spline 4	144x150/42/15		4210 2183 08
<b>Straight aluminum bar</b>			
Spline 3	L = 400		4210 2219 01
<b>Extended sliding drive reaction bar</b>			
Spline 5	1	68-112	4210 4498 80
<b>Extended sliding tube reaction bar</b>			
Spline 5	1	68-112	4210 4498 82
<b>Bracket stepped</b>			
Spline 1	70/36/13		4210 1798 02
Spline 2	70/41/14		4210 2134 02

Steel bar



Square steel bracket



Triangular steel bracket



Sliding drive reaction bar



S-Type reaction bar



L-Type aluminum bar



Straight aluminum bar



Extended sliding drive reaction bar



Extended sliding tube reaction bar

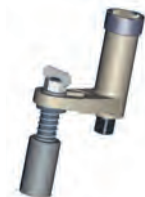

Bracket stepped



## Service Kits

Model	Trigger kit	General service kit
LMP24	4210 1934 91	4081 0105 90
LMP/LTP61	4210 2190 91	4081 0397 90

## RTP NUTRUNNERS FOR HEAVY DUTY BOLTING

- RTP's slim gearpack gives you effortless access to bolts in cramped spaces.
- The torque output of the RTP is adjusted with an Atlas Copco FRL air pressure unit, helping to prolong the lifetime and torque accuracy of the tool.
- The tool's 1" exchangeable drive simplifies maintenance and cuts repair costs.



Model	Bolt size mm	Square drive in	Min torque at 1.5 bar		Max torque at 6.3 bar		Free speed r/min	Weight <sup>a</sup>		Length mm	CS distance mm	Air consumption at free speed		Rec. hose size mm	Air inlet thread in	Ordering No.
			Nm	ft lb	Nm	ft lb		kg	lb			l/s	cfm			
RTP1300-HR20	20-27	3/4	320	235	1300	960	20	3.7	8.15	248	32	23	48	13	3/8	8431 1013 10
RTP2600-HR25	20-36	1	700	520	2600	1900	10	5	11	300	34	23	48	13	3/8	8431 1026 10
RTP4100-HR25	30-45	1	1000	740	4100	3000	10	8.7	19.18	335	41	31	65.5	13	3/8	8431 1040 10
RTP8100-GIR38	33-52	1 1/2	2200	1600	8100	6000	10	13.5	30	444	51	50	105	13	1/2	8431 1081 10

<sup>a</sup>Weight excluding reaction bar.

## Accessories Included

Model	Description	Ordering No.
RTP1300	Reaction bar, S-type	4210 4480 90
RTP2600	Reaction bar, S-type	4210 4480 94
RTP4100	Reaction bar, S-type	4210 4480 93
RTP8100	Reaction bar, S-type	4210 4480 92
RTP1300 / 2600 / 4100	Hose kit, Turbo M10, BSP	8202 1182 07
RTP8100	Hose kit, Turbo 13 M15, BSP	8202 1181 81
RTP1300 / 2600 / 4100	Productivity kit FRL stand, BSP <sup>b</sup>	9090 3030 06
RTP8100	Productivity kit FRL stand, BSP <sup>b</sup>	9090 3030 04

<sup>b</sup>Hose not included.

## Optional Accessories

Model	Description	Ordering No.
RTP1300 / 2600 / 4100	MultiFlex swivel 3/8 BSP	8202 1350 22
RTP8100	MultiFlex swivel 1/2 BSP	8202 1350 24
RTP1300 / 2600 / 4100	Trigger guard	4210 4759 90
RTP1300	Suspension yoke	4210 3088 83
RTP2600	Suspension yoke	4210 3088 82
RTP4100	Suspension yoke	4210 3088 81
RTP8100	Suspension yoke	4210 4780 90
RTP1300	Reaction bar, sliding-drive	4210 4752 90
	Reaction bar, steel bar	4210 4757 90
	Reaction bar, square bracket	4210 4758 90
RTP2600	Reaction bar, sliding-drive	4210 4752 93
	Reaction bar, steel bar	4210 4757 93
	Reaction bar, square bracket	4210 4758 93
RTP4100	Reaction bar, sliding-drive	4210 4752 91
	Reaction bar, steel bar	4210 4757 91
	Reaction bar, square bracket	4210 4758 91
RTP8100	Reaction bar, sliding-drive	4210 4752 92
	Reaction bar, steel bar	4210 4757 92
	Reaction bar, square bracket	4210 4758 92

**NOTE:** All reaction bars includes a snap ring



## Service Kits

Model	Description	Ordering No.
RTP1300	Small parts kit	4082 0125 90
RTP2600	Small parts kit	4082 0148 90
RTP4100	Small parts kit	4082 0116 91
RTP8100	Small parts kit	4082 0126 90
RTP1300	Service kit	4081 0510 90
RTP2600	Service kit	4081 0510 90
RTP4100	Service kit	4081 0504 90
RTP8100	Service kit	4081 0511 90





# ***Bolt tightening solutions***

A worker wearing a white hard hat with safety glasses, a high-visibility green vest over a dark blue long-sleeved shirt, and blue work gloves is operating a hydraulic bolt tightening system. The worker is smiling and looking towards the camera. The system consists of a large black hydraulic torque wrench connected to a large metal flange via blue hydraulic hoses. The background is a blurred industrial setting with various metal structures.

## **Contents**

Introduction .....	61
Tentec Airbac bolt tensioners and RT Advance hydraulic torque wrench system .....	62

## A dynamic range of bolting tools

Frequently chosen by customers in the oil and gas, power generation, wind energy, and other sectors, Atlas Copco world-class bolting tools and software help you maximize process security, minimize human and operational risk and reduce your overall investment costs. Our custom-designed hydraulic bolt tensioners, “smart” hydraulic torque wrench systems, and industry leading electric and pneumatic nutrunners are supported by Atlas Copco's extensive application expertise and worldwide presence.

### IT PAYS TO CHOOSE THE BEST

Atlas Copco's core bolting techniques are hydraulic torque, tensioning, and continuous rotation. Our complete portfolio of advanced bolting tools includes:

- Hydraulic torque wrenches
- Hydraulic bolt tensioning systems
- Electric transducerized nutrunners and pneumatic nutrunners
- Mechatronic and transducerized manual wrenches
- Smart Systems
- Accessories, pumps

We have the best products in all bolting technologies, and all our products are designed and produced inhouse by our own plants in the UK and Sweden.



HYDRAULIC TORQUE



TENSIONING



CONTINUOUS ROTATION



MANUAL TIGHTENING



PUMPS



ACCESSORIES



SMART SOFTWARE



# Bolt Tightening Solutions

## Tentec Airbac bolt tensioners

### ABOUT TENSION

With tensioners, the action is not directly on the nut, instead tension is applied directly to the stud in order to produce stretch. Once the prestretch is achieved, the nut can be tightened. Once the pressure is released the nut holds the load on the bolt. This produces the clamp force. Multiple tensioners can be used together to provide even load when tightening.

### SETTING A NEW STANDARD

- Innovative, market leading technology.
- Minimum operational downtime.
- At least 3 times faster piston retract than spring assisted tensioners.
- Around 20 percent lighter.
- Nickel plated to enhance corrosion resistance.



## RT Advance hydraulic torque wrench system

### ABOUT TORQUE

Using torque tools, such as nutrunners or hydraulic torque wrenches, you turn the nut. As the nut turns, it stretches the stud. The torque setting for the tool translates into load on the connection. When the tools are used following the appropriate specifications for lubrication, coating and other factors, a desired clamp force can be produced.

### OUR FIRST 'SMART' BOLTING SYSTEM

- Torque, angle and time based tightening strategies.
- Tightening feedback with traces.
- Full function remote control.
- 16GB inbuilt memory.
- ToolsNet enabled.
- WiFi: Remote access system support.



The products shown above are just two of our latest innovations. To see our full range of bolting products and solutions, please access our Bolt Tightening Solutions catalog:



# Battery assembly tools



## Contents

Introduction.....	64
BCP screwdriver.....	65
BCV nutrunner.....	65
Tensor SB nutrunner.....	67
Tensor STB nutrunner .....	68
Tensor SRB nutrunner.....	73
TBP nutrunner .....	73



## True cordless freedom

Atlas Copco's range of industrial battery assembly tools includes all kind of technologies: shut-off, transducerized, and low reaction tools (LRT). They allow maximum freedom of movement along the line and inside narrow or closed compartments.

### **BCP – BCV BATTERY TOOLS - EXPERIENCE CORDLESS FREEDOM**

The brushless BCP – BCV tools are ideal for quality critical applications where flexibility is essential. Final assembly of cars, offroad vehicles, buses, trucks, aircraft, motorcycles, engines, and white goods are just some examples of applications which can benefit from the performance and accessibility provided by the BCP - BCV tools. The slim, well-balanced design and ergonomic handle make it a pleasure to hold. Its compact size and Lithium-Ion batteries put it among the lightest battery tools on the market. BCP – BCV tools also offer variable speed and plenty of power, with torque levels ranging from 0.8 up to 60 Nm.

All these ergonomic features make the BCP - BCV the kind of tool you can work with all day long.

### **TENSOR SB NUTRUNNERS – TRANSDUCERIZED BATTERY TOOLS**

The Tensor SB are the tools for quality and critical applications, allows adjustable torque settings and has a transducer to ensure superior joint quality.

A robust metal housing ensures that the Tensor SB will stand up to tough industrial environments. Also the battery is powerful, reliable and has no memory effect, which means increased uptime for your production.

### **TENSOR STB NUTRUNNERS – FAST, LIGHT, TRANSDUCERIZED BATTERY TOOLS**

Ergonomically designed Tensor STB pistol-grip (up to 12 Nm) and angle nutrunners (up to 150 Nm) are ideal for safety critical applications in cramped areas. No other battery powered tool can match Tensor STB's unique fastening performance and advanced process control.

Atlas Copco Industrial Radio Communication (IRC) enables the Tensor STB to be partnered with a Power Focus controller for accurate torque monitoring and full joint traceability. At a typical workstation, one Tensor STB tool can be used for several applications within the same torque range.

### **TENSOR SRB AND TBP – LOW REACTION TOOLS**

Tensor SRB, is the evolution to the Tensor STB, designed to support all kinds of tightening strategies, from the traditional direct drive to the most advance Low Reaction Strategies as a TurboTight or Tensor Pulse.

TBP, is redefining what a pulse tool can do. The TBP will change everything you thought you knew about pulse tools. TBP is a cordless tool for one-handed operations, enabling error-proof productions. And our DuraPulse® technology will ensure the robustness of the TBP, making it your new favorite workhorse.





BCP screwdrivers offer true cordless freedom and superior ergonomics for the operator, thus contributing to outstanding performance.

- Ergonomic, lightweight pistol-grip design.
- 7 brushless models offering variable speed with a speed setting unit.
- Torque range: 0.8-12 Nm.
- Low speed models available.
- Two 18 V batteries: 2.1 Ah flat pack or 4.2 Ah regular pack.



BCP

Model	Square drive in	Torque range		Speed range r/min	Weight (excl. battery)		Length mm	Height mm	Ordering No.
		Nm	ft lb		kg	lb			
BCP BL-2-I06	1/4	0.8-2.5	0.6-1.8	500-1550	0.86	1.89	200	188	8431 1273 00
BCP BL-6-I06	1/4	2.0-6.0	1.5-4.4	300-1000	0.86	1.89	200	188	8431 1273 10
BCP BL-8-I06	1/4	3.0-8.0	2.2-5.9	300-800	0.86	1.89	200	188	8431 1273 20
BCP BL-12-I06	1/4	5.0-12.0	3.7-8.8	250-600	0.86	1.89	200	188	8431 1273 30
BCP BL-2L-I06	1/4	0.8-2.5	0.6-1.8	150-440	0.86	1.89	200	188	8431 1273 50
BCP BL-6L-I06	1/4	2.0-6.0	1.5-4.4	150-440	0.86	1.89	200	188	8431 1273 60
BCP BL-12L-I06	1/4	5.0-12.0	3.7-8.8	150-440	0.86	1.89	200	188	8431 1273 40

-L stands for low speed models.

**NOTE:** The tools are set at maximum speed at delivery.

All pistol grip models have 1/4" female hexagon drive for bits with quick change chuck.

# Nutrunners – Clutch Type

# BCV

BCV nutrunners are durable and reliable and offer flexible assembly. A lightweight and handy tool for maximum operator comfort.

- Robust yet ergonomic angle tool.
- Torque range 1.5-60 Nm.
- There are 3 Li-Ion batteries, 18 V (2.1 and 4.2 Ah) and 36 V (2.1 Ah).



BCV

Model	Square drive in	Torque range		Free speed r/min	Weight (excl. battery)		Power W	Battery V	Ordering No.
		Nm	ft lb		kg	lb			
BCV BL-07L-06	1/4	1.5-7	1.1-5.16	120-360	1.15	2.6	340	18	8431 1275 07
BCV BL-07-I06-QC	Hex 1/4	1.5-7	1.1-5.16	400-880	1.15	2.6	830	18	8431 1276 07
BCV BL-15-06	1/4	5-15	3.68-11	200-480	1.15	2.6	970	18	8431 1275 15
BCV BL-15-10	3/8	5-15	3.68-11	200-480	1.15	2.6	970	18	8431 1276 15
BCV BL-30-10	3/8	10-30	7.37-22.12	100-300	1.55	3.4	1720	36	8431 1275 30
BCV BL-45-10	3/8	20-45	14.7-33.2	50-180	1.65	3.6	1490	36	8431 1275 45
BCV BL-60-13	1/2	25-60	18.4-44.3	40-160	1.95	4.3	1750	36	8431 1275 60

## Optional Accessories

### BATTERIES

Model	Voltage V	Electric charge Ah	Weight		Charge time min	Ordering No.
			kg	lb		
Li-Ion Flat pack	18	2.1	0.47	1.04	35	4211 5500 10
Li-Ion Big pack	18	4.2	0.77	1.70	70	4211 5500 20
Li-Ion (BCV 30/45/60 Nm only)	36	2.1	0.77	1.70	70	4211 5500 40



Battery 36V  
for BCV only

### MULTICHARGER FOR BCV, BCP AND STB

Model	Ordering No.
Multicharger 18V - 36V, all regions	4211 5424 85



Battery 18V  
Flat pack

### COVER PROTECTIONS

Model	Ordering No.
Battery cover protection, 18V, Flat pack	4211 5690 00
Battery cover protection, 18V / 36V, Big pack	4211 5690 20
BCV BL-30-10 protective cover	4211 5603 30
BCV BL-45-10 protective cover	4211 5603 45
BCV BL-07/15 protective cover	4211 5603 00
BCP protective cover	4211 5415 00



Battery 18V  
Big pack

### MISCELLANEOUS

Model	Ordering No.
Speed setting unit V2 (BCV and BCP)	4211 5462 81
Battery analyzer	4211 5424 90
Support handle	4211 5421 80
Suspension yoke	4211 5600 00
Modular tool holder	4220 4335 80

### COLOUR RINGS

Model	Ordering No.
Red	4211 5461 02
Orange	4211 5461 03
Green	4211 5461 04
Blue	4211 5461 05
White	4211 5461 06
Purple	4211 5461 07
Grey	4211 5461 08



Colour rings



Battery Multicharger 18V - 36V



Tool holder



Suspension bail



Battery cover  
Flat pack



Battery cover  
Big pack



Support handle



Speed setting unit V2



BCP protective cover

## TENSOR SB-B

Tensor SB is Atlas Copco's response to customers who demand a truly superior industrial battery nutrunner. This user-friendly tool is characterized by a combination of quality in every tightening, operator mobility and long-lasting durability. Together these advantages give Tensor SB a unique position on the market.

- Low weight and high spindle speed increases productivity.
- Durable metal housing.
- Freedom of working freely in any position.
- Torque range ETV: 2-140 Nm.
- Torque range ETP: 4-12 Nm.



ETV SB



ETP SB

Model	Square drive in	Torque range		Battery	Free speed r/min	Weight		Weight incl. battery		Length mm	CS distance	Height mm	Ordering No.
		Nm	ft lb			kg	lb	kg	lb				
<b>Bluetooth angle models</b>													
ETV SB33-10-06-B	1/4	2-10	1.5-7.5	18 V	975	1.3	2.9	1.9	4.2	455	14	42	8433 3031 85
ETV SB33-10-10-B-SEL	3/8	2-10	2-7.5	18 V	975	1.45	3.2	2.1	4.65	455	14	72	8433 3031 25
ETV SB33-10-10-IRC-B	3/8	2-10	2-7.5	18 V	975	1.3	2.9	1.9	4.2	455	14	42	8433 3031 20
ETV SB33-15-10-IRC-B	3/8	4-15	3-11	18 V	720	1.3	2.9	1.9	4.2	455	14	42	8433 3031 82
ETV SB33-15-B06-IRC-B	1/4	4-15	3-11	18 V	720	1.3	2.9	1.9	4.2	455	14	39	8433 3031 84
ETV SB33-30-10-IRC-B	3/8	6-30	4.5-22	18 V	380	1.6	3.55	2.2	4.85	471	15.5	42	8433 3031 66
ETV SB63-40-10-IRC-B	3/8	12-40	9-29	30 V	450	1.85	4.1	2.8	6.15	508	18	47.5	8433 3031 23
ETV SB63-50-10-IRC-B	3/8	15-50	10-37	30 V	360	1.85	4.1	2.8	6.15	508	18	47.5	8433 3031 67
ETV SB63-70-13-IRC-B	1/2	15-70	10-50.7	30 V	265	2.9	6.4	3.85	8.45	533	20	58	8433 3031 05
ETV SB63-100-13-IRC-B	1/2	20-100	15-72.5	30 V	170	3	6.6	3.95	8.7	557	22.5	60.5	8433 3031 10
ETV SB63-140-13-IRC-B	1/2	20-140	15-101.5	30 V	120	3.4	7.5	4.4	9.7	593	25	65	8433 3031 15
<b>Bluetooth pistol grip models</b>													
ETP SB33-06-I06-B	1/4	2-6	2-4	18 V	1500	0.95	2.1	1.55	3.4	216	–	208	8433 3031 51
ETP SB33-12-10-B-SEL	3/8	4-12	3-9	18 V	750	1.1	2.45	1.7	3.75	216	–	235	8433 3031 52
ETP SB33-12-I06-IRC-B	1/4	4-12	3-9	18 V	750	0.95	2.1	1.6	3.55	216	–	208	8433 3031 49
<b>W-LAN angle models</b>													
ETV SB33-10-10-W	3/8	2-10	2-7.5	18 V	975	1.3	2.9	1.9	4.2	455	14	42	8433 3032 10
ETV SB33-15-10-W	3/8	4-15	3-11	18 V	720	1.3	2.9	1.9	4.2	455	14	42	8433 3032 15
ETV SB33-15-B06-W	1/4	4-15	3-11	18 V	720	1.3	2.9	1.9	4.2	455	14	39	8433 3032 16
ETV SB33-30-10-W	3/8	6-30	4.5-22	18 V	380	1.6	3.55	2.2	4.85	471	15.5	42	8433 3032 30
ETV SB63-40-10-W	3/8	12-40	9-29	30 V	450	1.85	4.1	2.8	6.15	508	18	47.5	8433 3032 40
ETV SB63-50-10-W	3/8	15-50	10-37	30 V	360	1.85	4.1	2.8	6.15	508	18	47.5	8433 3032 50
ETV SB63-70-13-W	1/2	15-70	10-50.7	30 V	265	2.9	6.4	3.85	8.45	533	20	58	8433 3032 70
ETV SB63-100-13-W	1/2	20-100	15-72.5	30 V	170	3	6.6	3.95	8.7	557	22.5	60.5	8433 3032 00
ETV SB63-140-13-W	1/2	20-140	15-101.5	30 V	120	3.4	7.5	4.4	9.7	593	25	65	8433 3032 14
<b>W-LAN pistol grip models</b>													
ETP SB33-06-I06-W	1/4	2-6	2-4	18 V	1500	0.95	2.1	1.55	3.4	216	–	208	8433 3032 06
ETP SB33-12-I06-W	1/4	4-12	3-9	18 V	750	0.95	2.1	1.6	3.55	216	–	208	8433 3032 12

– IRC-B or -B stands for Bluetooth.

– SEL stands for models with premounted Pset selector.

## ETV STB-X4

- State-of-the-art HMI with extensive functionality.
- Ergonomically designed tool, compact, lightweight, comfortable to work with.
- Durable housing for long service life-time.
- Excellent accessibility in cramped spaces.
- External antenna gives superior communication reliability.
- Embedded buffer battery.
- Communication during battery recycling.
- Torque range: 2-150 Nm.



ETV STB

Model	Square drive in	Torque range		Battery	Speed r/min	Weight		Weight incl. battery		Length mm	Height mm	Ordering No.
		Nm	ft lb			kg	lb	kg	lb			
<b>ETV Bluetooth without display and scanner</b>												
ETV STB34-15-10-B	3/8	4-15	3-11	18 V	720	1.3	2.8	1.95	4.3	435	41	8433 3020 15
ETV STB34-30-10-B	3/8	6-30	4.5-22	18 V	380	1.5	3.3	2.15	4.75	470	41	8433 3020 34
ETV STB64-50-10-B	3/8	15-50	10-37	30 V	365	2.15	4.7	3.09	6.8	507	47	8433 3020 65
ETV STB64-70-13-B	1/2	15-70	10-50.7	30 V	265	2.45	5.4	3.39	7.5	519	58	8433 3020 55
ETV STB64-100-13-B	1/2	20-100	15-72.5	30 V	170	3.1	6.8	4.04	8.9	556	60	8433 3020 85
<b>ETV Bluetooth with display and scanner<sup>a</sup></b>												
ETV STB34-10-10-BD-B	3/8	2-10	2-7.5	18 V	943	1.5	3.3	2.15	4.75	435	41	8433 3025 01
ETV STB34-15-10-BD-B	3/8	4-15	3-11	18 V	720	1.5	3.3	2.15	4.75	435	41	8433 3025 15
ETV STB34-15-106-BD-B	1/4	4-15	3-11	18 V	720	1.5	3.3	2.15	4.75	435	41	8433 3025 17
ETV STB34-30-10-BD-B	3/8	6-30	4.5-22	18 V	345	1.7	3.7	2.35	5.2	470	41	8433 3025 35
ETV STB64-30-10-BD-B	3/8	6-30	4.5-22	30 V	610	2.2	4.4	3.14	6.9	496	41	8433 3025 43
ETV STB64-50-10-BD-B	3/8	15-50	10-37	30 V	365	2.35	5.2	3.29	7.3	507	66	8433 3025 65
ETV STB64-70-13-BD-B	1/2	15-70	10-50.7	30 V	265	2.65	5.8	3.59	7.9	519	58	8433 3025 55
ETV STB64-100-13-BD-B	1/2	20-100	15-72.5	30 V	170	3.3	7.3	4.24	9.3	556	60	8433 3025 85
ETV STB64-150-13-BD-B	1/2	30-150	22-109	30 V	72	3.6	7.9	4.54	10	523	98	8433 3025 05
<b>ETV W-LAN without display and scanner</b>												
ETV STB34-15-10-W	3/8	4-15	3-11	18 V	720	1.3	2.8	1.95	4.3	435	41	8433 3018 15
ETV STB34-30-10-W	3/8	6-30	4.5-22	18 V	380	1.5	3.3	2.15	4.75	470	41	8433 3018 35
ETV STB64-50-10-W	3/8	15-50	10-37	30 V	365	2.15	4.7	3.09	6.8	507	47	8433 3018 65
ETV STB64-70-13-W	1/2	15-70	10-50.7	30 V	265	2.45	5.85	3.39	7.5	519	58	8433 3018 55
ETV STB64-100-13-W	1/2	20-100	15-72.5	30 V	170	3.1	6.8	4.04	8.9	556	60	8433 3018 85
<b>ETV W-LAN with display and scanner<sup>a</sup></b>												
ETV STB34-10-10-BD-W	3/8	2-10	2-7.5	18 V	943	1.5	3.3	2.15	4.75	435	41	8433 3019 01
ETV STB34-15-10-BD-W	3/8	4-15	3-11	18 V	720	1.5	3.3	2.15	4.75	435	41	8433 3019 15
ETV STB34-15-106-BD-W	1/4	4-15	3-11	18 V	720	1.5	3.3	2.15	4.75	435	41	8433 3019 17
ETV STB34-30-10-BD-W	3/8	6-30	4.5-22	18 V	345	1.7	3.7	2.35	5.2	470	41	8433 3019 35
ETV STB64-30-10-BD-W	3/8	6-30	4.5-22	30 V	610	2.0	4.4	3.14	6.9	496	41	8433 3019 43
ETV STB64-50-10-BD-W	3/8	15-50	10-37	30 V	365	2.35	5.2	3.29	7.3	507	66	8433 3019 65
ETV STB64-70-13-BD-W	1/2	15-70	10-50.7	30 V	265	2.65	5.8	3.59	7.9	519	58	8433 3019 55
ETV STB64-100-13-BD-W	1/2	20-100	15-72.5	30 V	170	3.3	7.3	4.24	9.3	556	60	8433 3019 85
ETV STB64-150-13-BD-W	1/2	30-150	22-109	30 V	72	3.6	7.9	4.54	10	523	98	8433 3019 05

<sup>a</sup>Only compatible with Power Focus 6000, for more information about Power Focus see chapter "Controllers and Systems".

## ETP STB-X4

- State-of-the-art HMI with extensive functionality.
- Ergonomically designed tool, compact, lightweight, comfortable to work with.
- Durable housing for long service life-time.
- Excellent accessibility in cramped spaces.
- External antenna gives superior communication reliability.
- Embedded buffer battery.
- Communication during battery recycling.
- Torque range: 2-800 Nm.



ETP STB

Model	Square drive in	Torque range		Battery	Speed r/min	Weight		Weight incl. battery		Length mm	Height mm	Ordering No.
		Nm	ft lb			kg	lb	kg	lb			
<b>ETP Bluetooth without display and scanner</b>												
ETP STB34-06-106-B	1/4	2-6	2-4	18 V	1500	0.95	2.1	1.55	3.4	216	208	8433 3020 75
ETP STB34-12-10-B	3/8	4-12	3-9	18 V	750	0.95	2.1	1.55	3.4	216	208	8433 3020 97
ETP STB34-12-106-B	1/4	4-12	3-9	18 V	750	0.95	2.1	1.55	3.4	216	208	8433 3020 95
<b>ETP Bluetooth with display and scanner<sup>a</sup></b>												
ETP STB34-06-10-BD-B	3/8	2-6	2-4	18 V	1500	1.15	2.5	1.75	3.86	216	240	8433 3025 25
ETP STB34-06-106-BD-B	1/4	2-6	2-4	18 V	1500	1.15	2.5	1.75	3.86	216	240	8433 3025 75
ETP STB34-12-10-BD-B	3/8	4-12	3-9	18 V	750	1.15	2.5	1.75	3.86	216	240	8433 3025 97
ETP STB34-12-106-BD-B	1/4	4-12	3-9	18 V	750	1.15	2.5	1.75	3.86	216	240	8433 3025 95
<b>ETP Bluetooth, high torque</b>												
ETP STB33-120-13-SEL-B	1/2	36-120	26-88	18 V	45	1.32	2.90	2.10	4.60	258	234	8433 3019 61
ETP STB33-325-20-SEL-B	3/4	100-325	74-240	18 V	20	2.30	5.10	3.10	6.80	299	234	8433 3019 67
ETP STB33-800-20-SEL-B	3/4	240-800	178-590	18 V	9	3.30	7.30	4.10	9.00	335	234	8433 3019 59
<b>ETP W-LAN without display and scanner</b>												
ETP STB34-06-106-W	3/8	2-6	2-4	18 V	1500	0.95	2.1	1.55	3.4	216	208	8433 3018 75
ETP STB34-12-10-W	3/8	4-12	3-9	18 V	750	0.95	2.1	1.55	3.4	216	208	8433 3018 97
ETP STB34-12-106-W	1/4	4-12	3-9	18 V	750	0.95	2.1	1.55	3.4	216	208	8433 3018 95
<b>ETP W-LAN with display and scanner<sup>a</sup></b>												
ETP STB34-06-10-BD-W	3/8	2-6	2-4	18 V	1500	1.15	2.5	1.75	3.86	216	240	8433 3019 25
ETP STB34-06-106-BD-W	1/4	2-6	2-4	18 V	1500	1.15	2.5	1.75	3.86	216	240	8433 3019 75
ETP STB34-12-10-BD-W	3/8	4-12	3-9	18 V	750	1.15	2.5	1.75	3.86	216	240	8433 3019 97
ETP STB34-12-106-BD-W	1/4	4-12	3-9	18 V	750	1.15	2.5	1.75	3.86	216	240	8433 3019 95
<b>ETP W-LAN, high torque</b>												
ETP STB33-120-13-SEL-WXM	1/2	36-120	26-88	18 V	45	1.32	2.90	2.10	4.62	258	234	8433 3019 47
ETP STB33-325-20-SEL-WXM	3/4	100-325	74-240	18 V	20	2.30	5.10	3.10	6.80	299	234	8433 3019 63
ETP STB33-800-20-SEL-WXM	3/4	240-800	178-590	18 V	9	3.30	7.30	4.10	9.00	335	234	8433 3019 59

<sup>a</sup> Only compatible with Power Focus 6000, for more information about Power Focus see chapter "Controllers and Systems".



## IN-LINE CROWFOOT TOOLS

### Dimensions

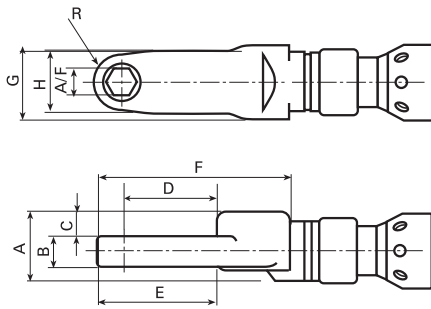

ETC STB

Model*	Torque range		Speed r/min	Weight		Length mm	A/F mm	A mm	B mm	C mm	D mm	E mm	F mm	G mm	H mm	R mm	Ordering No.
	Nm	ft lb		kg	lb												
ETC STB63-18-10-LI3	4-18	3-13	470	2.7	5.9	646	10	34	15	12.5	36.7	59.2	82	35	22	10	8433 2316 04
ETC STB63-20-12-LI3	6-23	4-17	226	2.7	5.9	676	12	34	10	15	51.9	54.3	102	35	31	14.5	8433 2316 10
ETC STB63-28-12-LI3	7-28	5-20	226	2.7	5.9	647	12	34	15	12.5	45.5	71	94	35	30	13	8433 2316 07

\* Available on demand.

## OFFSET CROWFOOT TOOLS

### Dimensions

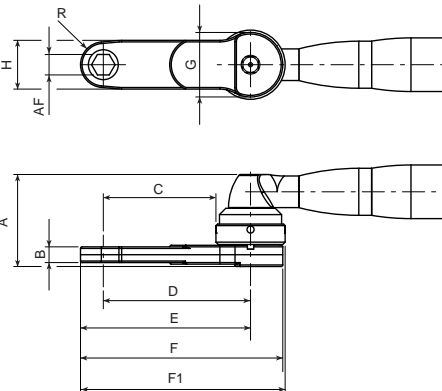

ETC STB

Model*	Torque range		Speed r/min	Weight		Length mm	A/F mm	A mm	B mm	C mm	D mm	E mm	F mm	G mm	H mm	R mm	F1 mm	Ordering No.
	Nm	ft lb		kg	lb													
ETC STB63-18-10-LO3	5-18	4-13	610	2.3	5.1	564	10	60.3	15	14.6	32.8	42.8	57.8	36.5	22	10	61.1	8433 2315 02
ETC STB63-20-13-LO5	5-23	4-17	610	2.6	5.7	657	13	58.5	10	71.6	93.6	108.1	128.6	44	31	14.5	130.1	8433 2315 08
ETC STB63-28-12-LO5	6-28	5-20	465	2.9	6.4	656	12	69.5	15	62	84	97	117.5	44	30	13	119	8433 2315 05
ETC STB63-40-14-LO3	8-44	6-32	375	2.8	6.2	620	14	69.5	18	24.8	46.8	61.3	81.8	44	31	14.5	83.3	8433 2315 11
ETC STB63-40-3/8-LO3	8-40	6-29	375	3	6.6	609	3/8	90.3	36	18.2	40.2	50.5	71	44	29	10.3	72.5	8433 2315 17
ETC STB63-50-16-LO3	12-64	8-47	265	3.4	7.5	635	16	78.3	24	27	51	66	88.5	48	30	15	90	8433 2315 20

\* Available on demand.

## IN-LINE TUBE NUT TOOLS

### Dimensions

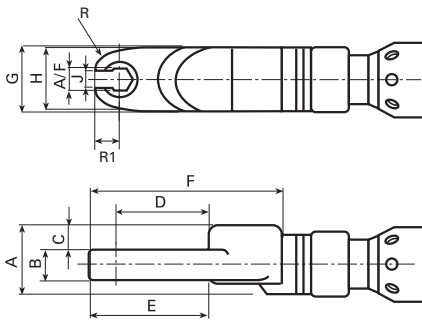

ETO STB

Model*	Torque range		Speed r/min	Weight		Length mm	A/F mm	A mm	B mm	C mm	D mm	E mm	F mm	G mm	H mm	J mm	R1 mm	R mm	Ordering No.
	Nm	ft lb		kg	lb														
ETO STB63-8-8-LI3	3-8	2-6	945	2.6	5.7	622	8	32	11	12.3	22.7	21.6	60	33.5	29	6	7.8	10	8433 2316 46
ETO STB63-12-8-LI3	4-12	3-9	723	2.6	5.7	628	8	32	10	13	27.3	25.4	66	33.5	31	7	9.8	11.5	8433 2316 49
ETO STB63-15-10-LI3	4-15	3-11	589	2.6	5.7	629	10	32	12	11	27.9	26.1	68	33.5	32	8	10.3	14	8433 2316 55

\* Available on demand.

## OFFSET TUBE NUT TOOLS

### Dimensions

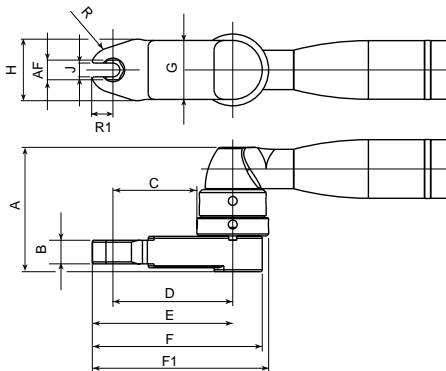

ETO STB

Model*	Torque range		Speed r/min	Weight		Length mm	A/F mm	A mm	B mm	C mm	D mm	E mm	F mm	G mm	H mm	J mm	R1 mm	R mm	F1 mm	Ordering No.
	Nm	ft lb		kg	lb															
<b>ETO STB33</b>																				
ETO STB33-12-10-LO5	3-12	2-9	480	2.3	5.1	596	10	62	10	42.7	60.9	70.7	85.7	36.5	31	7	9.8	11.5	89	8433 2315 59
ETO STB33-15-10-LO3	4-14	3-10	480	2.3	5.1	560	10	63.3	12	7	25.1	34.9	49.9	36.5	31	7	9.8	11.5	53.2	8433 2315 56
<b>ETO STB63</b>																				
ETO STB63-18-12-LO5	4-18	3-13	610	2.6	5.7	634	12	62	11	51	73	84.9	105.4	44	38	8	11.9	15	107	8433 2315 68
ETO STB63-20-12-LO3	5-20	3-15	610	2.4	5.3	589	12	64	14	7	29	40.2	60.7	44	38	8	11.2	14	62.2	8433 2315 65
ETO STB63-30-13-LO5	10-33	7-24	265	3.8	8.4	647	13	72.5	18	53.3	75.3	87.7	108.2	44	40	10.4	12.4	25	109.7	8433 2315 74
ETO STB63-28-13-LO3	6-28	4-21	465	2.8	6.2	611	13	65	11	12.8	36.8	51.8	74.3	48	50	10.4	15	31	75.8	8433 2315 77
ETO STB63-40-17-LO5	10-50	7-37	265	3.6	7.9	675	17	80.5	18	66.8	90.8	105.8	128.3	48	50	12	15	31	129.8	8433 2315 80
ETO STB63-50-17-LO3	11-60	8-44	265	3.6	7.9	628	17	77.8	18	11.1	42.4	59.6	85.6	62.5	59	14	17.2	32	90.9	8433 2315 83
ETO STB63-50-21-LO3	11-55	8-40	265	3.6	7.9	638	21	73.8	12	18	49.2	69.3	96.8	62.5	59	16	20.1	32	100.6	8433 2315 86

\* Available on demand.

## Optional Accessories

### CONTROLLER HARDWARE

Model	Ordering No.
<b>Drive unit</b>	
Power Focus 6000	8436 1800 02
Power Focus 6000 LV	8436 1800 11
<b>Software features, electronic delivery</b>	
Virtual Station, 1 pcs	8436 1900 01
TurboTight, 1 pcs	8436 1910 02
TrueAngle, 1 pcs	8436 1910 03
SoftPLC, 1 pcs	8436 1910 04
Yield, 1 pcs	8436 1910 06
Gradient, 1 pcs	8436 1910 07
<b>Software features, physical goods delivery</b>	
Virtual Station, 1 pcs	8436 1900 11
TurboTight, 1 pcs	8436 1910 21
TrueAngle, 1 pcs	8436 1910 31
SoftPLC, 1 pcs	8436 1910 41
Yield, 1 pcs	8436 1910 61
Gradient, 1 pcs	8436 1910 71
<b>Fieldbus modules</b>	
DeviceNet	8436 0940 10
Ethernet/IP 2 port	8436 0940 15
ProfiNet I/O 2 port	8436 0940 20
ProfiBus	8436 0940 05

### CONTROLLER SOFTWARE

Controller software	Ordering No.
<b>IAMs</b>	
Critical control	8436 0910 10
Process control	8436 0910 40

### ACCESSORIES FOR IRC AND POWER FOCUS 6000 CONTROLLER

	Ordering No.
FMS Portable	8436 1910 99
Operator panel advanced	8433 0565 00
Stacklight ESL04	8433 0570 13

### COVER PROTECTIONS

Model	Ordering No.
Battery cover protection, 18V Flat pack	4211 5690 00
Battery cover protection, 18V / 36V Big pack	4211 5690 20

### TOOLSTALK 2

Model	Delivery	Ordering No.
<b>ToolsTalk 2 – Station Set Up, computer installation</b>		
1- computer installation license	Electronic delivery	8092 1714 00
1- computer installation license	Physical delivery	8092 1714 01
<b>ToolsTalk 2 – Line configurator, virtual station</b>		
1-Virtual Station license	Electronic delivery	8092 1714 02
1-Virtual Station license	Physical delivery	8092 1714 03
5-Virtual Station license	Physical delivery	8092 1714 04
10-Virtual Station license	Physical delivery	8092 1714 05
<b>ToolsTalk 2 – Line Manager, virtual station</b>		
1-Virtual Station license	Electronic delivery	8092 1714 06
1-Virtual Station license	Physical delivery	8092 1714 07
5-Virtual Station license	Physical delivery	8092 1714 08
10-Virtual Station license	Physical delivery	8092 1714 09

### TOOL ACCESSORIES

	Ordering No.
<b>Selector 6 M (Mobile)</b>	
Selector 6 with 4 slots	8433 0613 04
8 slots	8433 0613 08
bit slots	8433 0613 09
<b>ETV STB33/34 (10/15/20/30 Nm models)</b>	
<b>ETV STB63/64 (30/40/50 Nm models)</b>	
Barcode scanner	8433 0615 10
Parameter set selector	8433 0616 05
I/O Device module	8433 0617 12
Adjustable headlights	4220 3292 94
Lever trigger 135	4220 3311 90
Lever trigger on top	4220 3186 90
Front button	4220 3184 90
Scanner protective cover	4220 2917 06
<b>ETV STB63/64 (70/100 Nm models)</b>	
Barcode scanner	8433 0615 20
Parameter set selector	8433 0616 15
I/O Device module	8433 0617 22
Adjustable headlights	4220 3292 95
Lever trigger 135	4220 3311 91
Lever trigger on top	4220 3186 91
Front button	4220 3184 91
<b>ETP STB33/34 (06/12 Nm models)</b>	
Barcode scanner	4220 3507 90
Parameter set selector	4220 3507 81
Scanner protective cover	4220 2917 06

### MULTICHARGER

Model	Ordering No.
Multicharger 18V - 36V, all regions	4211 5424 85

### BATTERY – LI-IO

Voltage	Capacity	Weight		Ordering No.
		kg	lb	
18 V	4.2 Ah	0.77	1.70	4211 5500 20
30 V	4.2 Ah	1.14	2.51	4211 5500 30



Stacklight ESL-04



Operator panel advanced



Selector 6, bit slots with carry handle

The SRB reports wirelessly to the Power Focus 6000 system and takes full advantage of Virtual Stations, able to perform low reaction strategies as TurboTight and Tensor Pulse, and traditional strategies as the two steps.

- Operator feedback and battery status via LED indicator.
- A buffer battery makes battery swaps trouble free.
- Integrated indicator on the battery shows battery and health status.
- Dual antenna.
- Rapid Backup Unit (RBU) functionality.



SRB

Model	Square drive in	Torque range		Battery	Speed r/min	Weight		Weight incl. battery		Length mm	Height mm	Ordering No.
		Nm	ft lb			kg	lb	kg	lb			
ETP SRB31-20-10	3/8	5-20	3.7-14.7	18/36 V	1500	1.15	2.535	1.65	3.638	212	211	8433 3270 30
ETP SRB31-20-106	3/8	5-20	3.7-14.7	18/36 V	1500	1.15	2.535	1.65	3.638	212	211	8433 3270 31
ETP SRB31-25-10	3/8	6-25	4.4-18.4	18/36 V	1500	1.15	2.535	1.65	3.638	223	211	8433 3260 30
ETP SRB31-25-106	3/8	6-25	4.4-18.4	18/36 V	1500	1.15	2.535	1.65	3.638	223	211	8433 3260 31

# Transducerized Type

# TBP

TBP is a low reaction tool with maximum flexibility and high torque. Thanks to the DuraPulse technology the tool uptime is increased and keeps it on the line instead of the tool crib. With TorqueBoost, active cooling and advanced motor steering, the torque build up is fast with reduced hours per production unit and the tool has high productivity.

- DuraPulse technology with new sealing and air separator.
- High torque.
- Excellent ergonomics with low vibrations and reaction force.
- Cooling system to prevent the tool from over-heating.
- Buffer battery.
- Dual antenna.
- Rapid Backup Unit (RBU) functionality.
- LED indicators to provide operator feedback.



TBP

Model	Square drive in	Torque range		Battery	Speed r/min	Weight		Weight incl. battery		Length mm	Height mm	Ordering No.
		Nm	ft lb			kg	lb	kg	lb			
ETP TBP61-32-10	3/8	12-35	8.9-25.8	18 V	6000	1.330	2.93	1.835	4.05	195	231	8433 3230 20
ETP TBP61-32-10-BD	3/8	12-35	8.9-25.8	18 V	6000	1.510	3.33	2.015	4.45	195	261	8433 3230 21
ETP TBP61-32-42	1/4	12-35	8.9-25.8	18 V	6000	1.330	2.93	1.835	4.05	195	231	8433 3230 22
ETP TBP61-32-42-BD	1/4	12-35	8.9-25.8	18 V	6000	1.510	3.33	2.015	4.45	195	261	8433 3230 23
ETP TBP81-55-10	3/8	20-55	14.8-40.6	18 V	6000	1.5	3.3	2.0	4.4	200	231	8433 3230 30
ETP TBP81-55-10-BD	3/8	20-55	14.8-40.6	18 V	6000	1.68	3.7	2.18	4.8	200	261	8433 3230 31
ETP TBP91-80-13	1/2	40-80	29.5-59.0	18/36 V	6000	1.8	3.9	2.6	5.6	210	231	8433 3230 40
ETP TBP91-80-13-BD	1/2	40-80	29.5-59.0	18/36 V	6000	1.98	4.36	2.78	6.13	209	261	8433 3230 41
ETP TBP131-150-13	1/2	55-150	41-111	36 V	3600	2.80	6.20	3.50	7.90	227	255	8433 3230 60
ETP TBP131-150-13-BD	1/2	55-150	41-111	36 V	3600	2.98	6.60	3.68	8.30	227	285	8433 3230 61

## Accessories

### CONTROLLER HARDWARE

Model	Ordering No.
<b>Drive unit</b>	
Power Focus 6000	8436 1800 02
Power Focus 6000 LV	8436 1800 11
<b>Software features, electronic delivery</b>	
Virtual Station, 1 pcs	8436 1900 01
TurboTight, 1 pcs	8436 1910 02
TrueAngle, 1 pcs	8436 1910 03
SoftPLC, 1 pcs	8436 1910 04
Yield, 1 pcs	8436 1910 06
Gradient, 1 pcs	8436 1910 07
<b>Software features, physical goods delivery</b>	
Virtual Station, 1 pcs	8436 1900 11
TurboTight, 1 pcs	8436 1910 21
TrueAngle, 1 pcs	8436 1910 31
SoftPLC, 1 pcs	8436 1910 41
Yield, 1 pcs	8436 1910 61
Gradient, 1 pcs	8436 1910 71
<b>Fieldbus modules</b>	
DeviceNet	8436 0940 10
Ethernet/IP 2 port	8436 0940 15
ProfiNet I/O 2 port	8436 0940 20
ProfiBus	8436 0940 05

### CONTROLLER SOFTWARE

Controller software	Ordering No.
<b>IAMs</b>	
Critical control	8436 0910 10
Process control	8436 0910 40

### ACCESSORIES FOR IRC AND POWER FOCUS 6000 CONTROLLER

	Ordering No.
FMS Portable	8436 1910 99
Operator panel advanced	8433 0565 00
Stacklight ESL04	8433 0570 13

### TOOLSTALK 2

Model	Delivery	Ordering No.
<b>ToolsTalk 2 – Station Set Up, computer installation</b>		
1- computer installation license	Electronic delivery	8092 1714 00
1- computer installation license	Physical delivery	8092 1714 01
<b>ToolsTalk 2 – Line configurator, virtual station</b>		
1-Virtual Station license	Electronic delivery	8092 1714 02
1-Virtual Station license	Physical delivery	8092 1714 03
5-Virtual Station license	Physical delivery	8092 1714 04
10-Virtual Station license	Physical delivery	8092 1714 05
<b>ToolsTalk 2 – Line Manager, virtual station</b>		
1-Virtual Station license	Electronic delivery	8092 1714 06
1-Virtual Station license	Physical delivery	8092 1714 07
5-Virtual Station license	Physical delivery	8092 1714 08
10-Virtual Station license	Physical delivery	8092 1714 09

### ACCESSORIES FOR SRB AND TBP

Model	Ordering No.
<b>Selector 6 M (Mobile)</b>	
Selector 6 with 4 slots	8433 0613 04
8 slots	8433 0613 08
bit slots	8433 0613 09
Protective cover TBP 6/8	4250 3135 60
Protective cover TBP 9	4250 3135 62
Protective cover TBP 13	4250 3135 63
Protective cover SRB	4220 2744 07
SRB/TBP tool holder	4220 3584 86
Foot protective cover	4211 6089 00

### BATTERIES AND COVERS

Model	Ordering No.
Battery Li-Ion 18V 2.6 Ah	4211 6030 85
Battery Li-Ion 36V 2.6 Ah	4211 6030 86
Protective cover 18V	4211 6090 18
Protective cover 36V	4211 6090 36
Multicharger 18-36V	4211 6083 84
Daisy chain cable	4211 6083 60



Tool holder



Selector 6



Battery Li-Ion 18V 2.6 Ah



Battery Li-Ion 36V 2.6 Ah





# *Electric assembly tools*

## **Contents**

Introduction.....	76	Nutrunners.....	95
Product safety.....	77	Tensor ES.....	96
Screwdrivers.....	78	Tensor ST.....	100
EBL.....	79	Tensor STR.....	104
MicroTorque.....	81	Tensor SR.....	109
Tensor ES.....	88		
Tensor SL.....	90		
Tensor SR.....	91		

# Highest productivity with lowest life-cycle cost

*Atlas Copco supplies a comprehensive range of high productivity assembly tools with intelligent controllers and a sharp focus on ergonomics. Our many product lines were developed to meet all your tightening needs and give you lowest life cycle cost. Products range from low torque MicroTorque tools providing 0.01 Nm of torque, to high torque Tensor ST tools, offering up to 4,000 Nm.*

### **EBL SCREWDRIVER**

Low voltage, brushless screwdriver for demanding applications, with shut-off clutch for high fastening precision, time after time.

### **MICROTORQUE SCREWDRIVERS**

The most innovative and reliable low torque screwdrivers on the market to ensure high productivity and quality in all joints. The new groundbreaking controller, MTF6000, is designed for Industry 4.0. With the fixtured QMC series, or the handheld ETD M ABL V2 series, it is the ultimate solution to improve the competitiveness of any manufacturing process.

### **TENSOR TOOLS**

The Tensor tool range covers all assembly requirements for safety critical and quality critical applications.

Tensor ES: Quality critical applications with high demands on productivity, ergonomics and error proofing.

Tensor SL: Safety-critical low torque tools for small screw applications. It offers compact screwdriver ergonomics with traceability and error proofing capability.

Tensor ST: The second generation of Tensor tools was developed with the focus on reducing tool weight and increasing productivity. Tensor ST has an internal bus connection for intelligent accessories such as a barcode reader and P-selector switch.

Tensor STR, SR: The latest generation of Tensor tools where ergonomics and productivity are taken to a new level.

Tensor STB: The battery version of Tensor ST for safety critical applications.

### **POWER FOCUS 6000 CONTROLLER**

Power Focus 6000 is the market-leading controller for handheld battery and electric tools. Power Focus is a controller with full flexibility and connectivity to fit your production infrastructure. The Power Focus 6000 is compatible with STR, ST, SR and ES.

### **POWER FOCUS 600 CONTROLLER**

The Power Focus 600 is compatible with the Tensor ES tools and is the perfect choice for quality critical assembly. It comes in one single hardware version regardless of which tool model or functionality level is used.





## SAFETY GUIDELINES

At Atlas Copco we want you to operate our tools safely. Always read and follow all operating and safety instructions, and comply with local safety regulations. There is a range of accessories for Atlas Copco tools. They are intended to reduce the risk of injury during certain assembly processes.

### HOW TO MAKE TOOL OPERATION SAFER

#### 1 Entanglement hazard

- Hands and other objects (long hair, necklaces etc.) can get entangled with the rotating drive, causing severed or broken fingers.
- Do not use gloves.
- Never hold the drive, socket or extension with your hands.

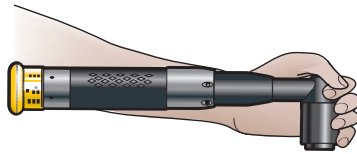

#### 5 Reaction bar

- When a reaction bar is used, keep hands away from the reaction bar while tightening a joint, otherwise hands may get squeezed.



#### 2 Hold the tool correctly

- Keep hands and other objects (long hair, necklace, etc.) away from the rotating drive, socket or extension.
- Hold the tool correctly with one hand on the handle of the tool and the other hand on the top of the angle head.

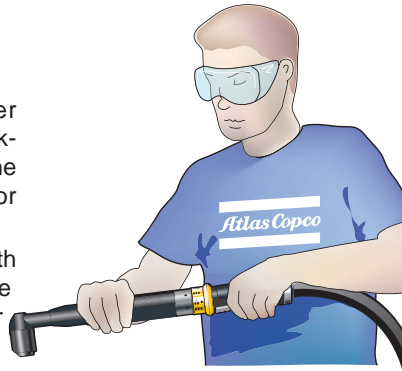

#### 6 Open end tools

- Never put your finger into the open end of a tool, even if a dual action trigger is used.
- To avoid accidents, to activate the tool, both triggers must be pressed within 500 ms.

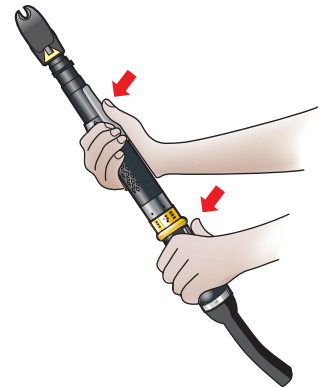

#### 3 Supported extensions

- If you use an extension, never hold the extension with your hand while it is rotating. If you need to guide the extension, in order to locate the socket quickly and accurately, use an accessory to reduce the risk of entanglement.

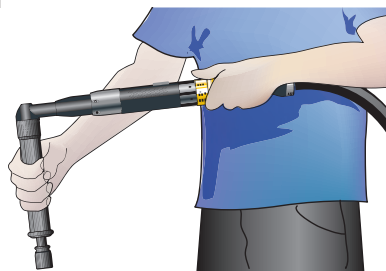

Other advantages are:

- Longer life for angle gear.
- More uniform tightening results.

#### 7 Angle nutrunners with reaction bar

- Use reaction bar at high torque. For soft joints, a reaction bar should be used at >60 Nm.

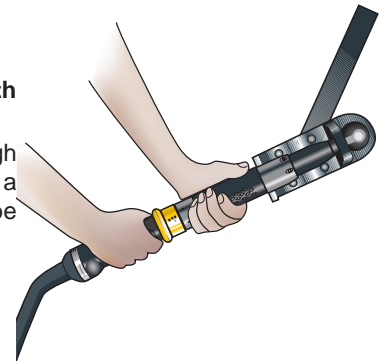

#### 4 Use goggles

- Always use approved safety goggles to protect your eyes from objects that might accidentally fly into your face.

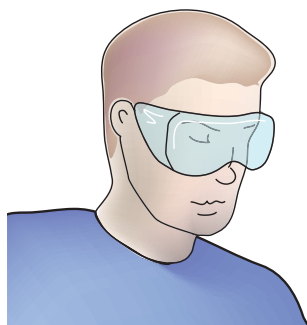

#### 8 Screwdrivers

- Consider using a support handle or support arms, particularly for straight versions and for torques of 6 Nm and upwards.



# If you're looking for quality, you've found it

*Atlas Copco supplies a complete range of advanced electric screwdrivers to match your needs. If it's cutting-edge ergonomics you want, true reliability, or long-life, low maintenance motors, we have tools to match your needs. With models such as MicroTorque QMC, ETD MT, ETD M ABL V2 or Tensor we cover the range from 0,01 Nm up to 200 Nm. They all have one thing in common – high quality.*

### **EBL SCREWDRIVERS**

EBL screwdrivers are the best in class clutch electric screwdriver for low torque applications, its brushless motor combined with the high accuracy, delivers the best clutch tool solution for any assembly process.

### **MICROTORQUE**

MicroTorque screwdriver range is the most advanced and intelligent tightening solution for any low torque application: extremely ergonomic, very compact and full of functionalities. It is the right tool to boost productivity and quality, resulting in high efficiency and cost reduction.

### **TENSOR SR TOOLS**

ESD certified, Tensor SR angle tools are fast, compact and easy to operate. They feature an easy-to-configure function button and front LED's for clear operator feedback.

With a push-to-start mechanism and an integrated front guide light, SR straight tools are suitable for both hand-held and fixtured applications.

### **TENSOR SL**

Tensor SL transducerized screwdrivers are available in straight, right angle and pistol grip versions, with a straight model for fixtured applications that is very light and compact. All the tools offer high power-to-weight ratios, good ergonomic designs and clear operator feedback via LED's lights and buzzers (depending on the model).

### **TENSOR ES**

Tensor ES transducerized screwdrivers for quality critical applications are available in straight, right angle and pistol grip versions. All models have a sealed design for robustness and offer high productivity with improved ergonomics.



### **ESD CERTIFIED SCREWDRIVERS**

Atlas Copco offers ESD certified tools in the standard range of screwdriver models most frequently used in the electronics industries. ESD certification means a guarantee against damage of electronic components by an uncontrolled electrostatic discharge (ESD) from the tools.

Conformity to the requirements of IEC 61340-5-1 standard proposal is approved by SP, the Swedish National Testing and Research Institute. In practice it certifies that at no point will the material of the equipment hold an electrostatic potential above 100 V for more than 2 seconds.



## DESIGNED FOR LOW-TORQUE ASSEMBLY OPERATIONS

Featuring superior ergonomics and the latest technology, Atlas Copco's EBL screwdriver is setting new standards for electric low-torque screwdrivers.

- Brushless motor provides long working life, extended service intervals and low maintenance requirements.
- Good ergonomics mean maximum operator comfort: comfortable grip, low tool weight and lower noise level due to the brushless motor.
- Reporting tool models have a batch count feature that ensures that all screws have been tightened.
- Soft-stop feature on certain models prevents damage to sensitive electronics and plastic assembly components.



EBL35



EBL12



EBL03

Model	Screw capacity	Torque range soft joint		Free speed r/min	Weight		Length mm	Bit drive	Ordering No.
		Nm	in lb		kg	lb			
<b>Standard models</b>									
EBL03	M1-2	0.05-0.3	0.4-2.7	870	0.3	0.7	185	Wing type 4 mm	8431 0170 02
EBL03-Q	M1-2	0.05-0.3	0.4-2.7	870	0.3	0.7	185	1/4" Hex	8431 0170 04
EBL12	M2-3	0.2-1.2	1.8-10.6	910	0.5	1.1	215	1/4" Hex	8431 0170 11
EBL12-1500	M2-3	0.2-1.2	1.8-10.6	1500	0.5	1.1	215	1/4" Hex	8431 0170 41
EBL20	M2-3	0.5-2.0	4.5-18	750	0.5	1.1	215	1/4" Hex	8431 0170 16
EBL21-1500	M2-3	0.5-2.1	4.5-19	1500	0.8	1.8	235	1/4" Hex	8431 0170 43
EBL25	M2.5-4	1.0-2.5	8.8-22.1	930	0.8	1.8	235	1/4" Hex	8431 0170 23
EBL25-1500 <sup>a</sup>	M2.5-4	1.0-2.5	8.8-22.1	1500	0.8	1.8	235	1/4" Hex	8431 0170 25
EBL35	M2.5-4	1.0-3.5	8.8-31	700	0.8	1.8	235	1/4" Hex	8431 0170 33
EBL45 <sup>c</sup>	M2.5-5	1.0-4.5	8.8-40	700	0.8	1.8	235	1/4" Hex	8431 0170 40
EBL55 <sup>c</sup>	M2.5-5	1.0-5.5	8.8-48	600	0.8	1.8	235	1/4" Hex	8431 0170 44
<b>Soft-stop models</b>									
EBL03-SS	M1-2	0.05-0.3	0.4-2.7	870	0.3	0.7	185	Wing type 4 mm	8431 0170 07
EBL12-SS	M2-3	0.2-1.2	1.8-10.6	910	0.5	1.1	215	1/4" Hex	8431 0170 15
EBL20-SS	M2-3	0.5-2.0	4.5-18	750	0.5	1.1	215	1/4" Hex	8431 0170 20
EBL25-SS	M2.5-4	1.0-2.5	8.8-22.1	930	0.8	1.8	235	1/4" Hex	8431 0170 28
EBL35-SS	M2.5-4	1.0-3.5	8.8-31	700	0.8	1.8	235	1/4" Hex	8431 0170 38
<b>Reporting models</b>									
EBL03-RE	M1-2	0.05-0.3	0.4-2.7	870	0.3	0.7	185	Wing type 4 mm	8431 0170 55
EBL03-Q-RE	M1-2	0.05-0.3	0.4-2.7	870	0.3	0.7	185	1/4" Hex	8431 0170 06
EBL12-RE	M2-3	0.2-1.2	1.8-10.6	910	0.5	1.1	215	1/4" Hex	8431 0170 13
EBL12-1500-RE	M2-3	0.2-1.2	1.8-10.6	1500	0.5	1.1	215	1/4" Hex	8431 0170 18
EBL20-RE	M2-3	0.5-2.0	4.5-18	750	0.5	1.1	215	1/4" Hex	8431 0170 19
EBL21-1500-RE	M2-3	0.5-2.1	4.5-19	1500	0.8	1.8	235	1/4" Hex	8431 0170 47
EBL25-RE	M2.5-4	1.0-2.5	8.8-22.1	930	0.8	1.8	235	1/4" Hex	8431 0170 26
EBL25-1500-RE <sup>b</sup>	M2.5-4	1.0-2.5	8.8-22.1	1500	0.8	1.8	235	1/4" Hex	8431 0170 22
EBL35-RE	M2.5-4	1.0-3.5	8.8-31	700	0.8	1.8	235	1/4" Hex	8431 0170 36
EBL45-RE <sup>d</sup>	M2.5-5	1.0-4.5	8.8-40	700	0.8	1.8	235	1/4" Hex	8431 0170 42
EBL55-RE <sup>d</sup>	M2.5-5	1.0-5.5	8.8-48	600	0.8	1.8	235	1/4" Hex	8431 0170 45
<b>Soft-stop Reporting models</b>									
EBL03-SS-RE	M1-2	0.05-0.3	0.4-2.7	870	0.3	0.7	185	Wing type 4 mm	8431 0170 08
EBL12-SS-RE	M2-3	0.2-1.2	1.8-10.6	910	0.5	1.1	215	1/4" Hex	8431 0170 17
EBL20-SS-RE	M2-3	0.5-2.0	4.5-18	750	0.5	1.1	215	1/4" Hex	8431 0170 21
EBL25-SS-RE	M2.5-4	1.0-2.5	8.8-22.1	930	0.8	1.8	235	1/4" Hex	8431 0170 29
EBL35-SS-RE	M2.5-4	1.0-3.5	8.8-31	700	0.8	1.8	235	1/4" Hex	8431 0170 39

<sup>a</sup> EBL 25-1500 to be used with EBL Drive Plus.

<sup>b</sup> EBL 25-1500-RE to be used with EBL Drive Plus and EBL RE Module.

<sup>c</sup> EBL 45, 55 to be used with EBL Drive Plus.

**NOTE:** Max torque reduced to 80% when run on slow speed and soft joints.

<sup>d</sup> EBL 45-RE and EBL 55-RE to be used with EBL Drive Plus and EBL RE module.

**NOTE:** Max torque reduced to 80% when run on slow speed and soft joints.

All tools models, drives and cables are ESD and UL certified.

Tool box include cable for drive connection (standard models with 5 pins cable and reporting models with 6 pins cable)

All the models are push-to-start or lever start configurable.



## Optional Accessories

### DRIVES

Model		Ordering No.
EBL Drive	For standard models and soft-stop models	8431 0170 70
EBL RE-Drive	For reporting models and soft-stop + reporting models	8431 0170 75
EBL Drive Plus	For all standard models and soft-stop models	8431 0170 85
EBL Drive Plus is required for EBL25-1500, EBL25-1500-RE, EBL45, EBL45-RE, EBL55 and EBL55-RE		



EBL Drive

### EBL REPORTING MODULE

Model	Ordering No.
EBL RE module	8431 0170 76
RE module to be connected between EBL Drive or EBL Drive Plus and RE tool.	



EBL RE-Drive

### VACUUM PICK-UP ACCESSORIES

Accessories (not ESD approved)	Ordering No.
Vacuum pump – 220V	4220 0062 00
Vacuum pump – 115V	4220 0062 05
Nozzle blank Ø 8 mm for EBL 03	4220 0067 03
Nozzle blank Ø 8 mm for EBL 12, 20, 21, 25, 35	4220 0070 03
Nozzle blank Ø 14 mm for EBL 12, 20, 21, 25, 35	4220 0072 03
Vacuum pick-up adapter for EBL 03	4220 0080 30
Vacuum pick-up adapter for EBL 12, 20	4220 0080 31
Vacuum pick-up adapter for EBL 21, 25, 35	4220 0080 33



EBL Drive Plus

### CABLES

Model	Ordering No.
<b>Cable (not ESD approved)</b>	
Spiral cable, 1.3 m (5 pin)	4220 0347 00
Spiral cable, 1.3 m (6 pin)	4220 0349 00
Heavy duty, cable 2.0 m (5 pin)	4216 0132 00
Heavy duty, cable 2.0 m (6 pin)	4216 0133 00
<b>Cable (ESD approved)</b>	
Extension cable <sup>b</sup> 3.0 m (5 pin)	4220 0138 01
Extension cable <sup>b</sup> 3.0 m (6 pin)	4216 0115 00

<sup>b</sup> Maximum total length 8 m.



EBL RE module

### SCREW DISPENSER

Model	Ordering No.
SDS Screw dispenser	8432 0830 00



Pistol grip

### PISTOL GRIP

Model	Ordering No.
EBL 12, 20	4220 0051 04
EBL 21, 25, 35, 45, 55 (ESD approved)	4220 0051 05



Vacuum pick-up system

### ANGLE HEAD

Model	Ordering No.
<b>Angle head</b>	
Front part square drive 1/4" (06)	4210 4033 90
Hex bit drive 1/4" (42)	4210 4033 81
Hex quick change 1/4" (Q)	4210 4033 82
<b>Adapter</b>	
Adapter EBL 12, 20	4210 4609 85
Adapter EBL 21/25/35/45/55	4210 4609 81



Angle head, EBL



Screw dispenser

Both angle head and adapter needs to be ordered for mounting on EBL.

## CURRENT CONTROLLED TOOLS – ETD M ABL V2

MicroTorque handheld screwdrivers are designed to deliver outstanding quality with superior productivity in all assembly processes.

- High accuracy current controlled tools.
- Torque and angle monitoring for error proofing customized to any process.
- Advanced seating control tightening strategy that eliminates floating screws.
- Advanced torque seating monitoring to ensure final torque and monitor the clamping torque (unique for MTF 6000).
- Ergonomic design: comfortable grip and low weight to maximize operator satisfaction.
- Controllers and tools are ordered separately.



ETD M27



ETD M50



ETD M250

Model	Torque range		Speed r/min	Length mm	Overall width mm	Weight		Bit drive	Ordering No.
	cNm	in lb				kg	lb		
<b>Hand-held current controlled, without push-to-start</b>									
ETD M 08 ABL V2	2-8	0.18-0.7	1350	185	29	0.30	0.66	HM 4 mm	8432 0815 18
ETD M 20 ABL V2	5-20	0.44-1.77	900	185	29	0.30	0.66	HM 4 mm	8432 0815 21
ETD M 27 ABL V2	7.5-27	0.66-2.4	900	185	29	0.30	0.66	HM 4 mm	8432 0815 27
<b>Hand-held current controlled, push-start configurable</b>									
ETD M 50 ABL V2	15-50	1.33-4.4	1000	238	36	0.61	1.37	HM 4 mm	8432 0815 50
ETD M 80 ABL V2	20-80	1.77-7.1	1100	238	36	0.61	1.37	HM 4 mm	8432 0815 80
ETD M 120 ABL V2	30-120	2.7-10.6	900	240	43	0.65	1.43	1/4" Hex	8432 0815 82
ETD M 200 ABL V2	50-200	4.42-17.7	700	240	43	0.65	1.43	1/4" Hex	8432 0815 84
ETD M 250 ABL V2	75-250	6.64-22.13	700	240	43	0.65	1.43	1/4" Hex	8432 0815 86

**NOTE.** Ordering number for screwdriver only. Tool cable, controller and PSU need to be ordered separately.

## CURRENT CONTROLLED TOOLS – QMC

MicroTorque fixtured screwdrivers are designed to deliver outstanding quality with superior productivity in all assembly processes.

- Lightweight to maximize productivity in any automation process.
- High accuracy current controlled tools.
- Multistep tightening to maximize productivity and quality.
- Torque and angle monitoring to ensure quality.
- Advanced torque seating monitoring to ensure final torque and monitor the clamping torque (unique for MTF6000).



Model	Torque range		Speed r/min	Length mm	Overall width mm	Weight		Bit drive	Ordering No.
	cNm	in lb				kg	lb		
<b>Fixtured current controlled</b>									
QMC21-05-HM4 <sup>a</sup>	1.2-5	0.11-0.44	2000	123	57	0.2	0.44	HM 4 mm	8432 0844 05
QMC21-10-HM4	3-10	0.27-0.89	2000	178	57	0.3	0.66	HM 4 mm	8432 0844 10
QMC21-25-HM4	5.5-25	0.49-2.2	1000	178	57	0.3	0.65	HM 4 mm	8432 0844 25
QMC41-50-HM4	12.5-50	1.1-4.4	2000	200	66	0.6	1.32	HM4	8432 0844 52
QMC41-100-HM4	25-100	2.2-8.9	2000	200	66	0.6	1.32	HM4	8432 0844 53
QMC41-50-I06	12.5-50	1.1-4.4	2000	205	66	0.61	1.36	1/4" Hex	8432 0844 61
QMC41-100-I06	25-100	2.2-8.9	2000	205	66	0.61	1.36	1/4" Hex	8432 0844 62
QMC41-150-I06	37.5-150	3.3-13.3	1000	213	66	0.625	1.38	1/4" Hex	8432 0844 63
QMC41-250-I06	62.5-250	5.5-22.1	750	224	66	0.650	1.43	1/4" Hex	8432 0844 64

<sup>a</sup> Only compatible with MTF6000. **NOTE.** Ordering number for screwdriver only. Tool cable, controller and PSU need to be ordered separately.

## TRANSDUCERIZED TOOLS – ETF MT AND G4 SYSTEMS

MicroTorque transducerized systems are designed to bring outstanding precision, time after time.

- High accuracy transducerized tools.
- Complete system with one ordering number that includes screwdriver, controller, tool cable, PSU and ToolsTalk MT.
- Torque and angle control and monitoring.
- Multistep tightening.
- Advanced programming via PC software, ToolsTalk MT.
- Multiple I/Os for integration with assembly line, automation stations or error proofing accessories.



ETF MT 5/10/20/50/80/100/200/500

Model	Torque range		Speed r/min	Length mm	Overall width mm	Weight		Bit drive	Ordering No.
	cNm	in lb				kg	lb		
<b>Fixtured transducerized systems</b>									
ETF MT 5	0.5-5	0.04-0.4	1300	183	20	0.4	0.9	HM 4 mm	8432 0800 10
ETF MT 10	1-10	0.09-0.9	900	183	20	0.4	0.9	HM 4 mm	8432 0800 11
ETF MT 20	2-20	0.18-1.8	900	183	20	0.4	0.9	HM 4 mm	8432 0800 12
ETF MT 50	5-50	0.44-4.4	1300	269	30	1.1	2.42	HM 4 mm	8432 0800 13
ETF MT 80	8-80	0.71-7.1	1300	269	30	1.2	2.65	HM 4 mm	8432 0800 14
ETF MT 100	10-100	0.88-8.8	1300	272	30	1.2	2.65	1/4" HEX	8432 0800 15
ETF MT 100 HM4	10-100	0.88-8.8	1300	269	30	1.2	2.65	HM 4 mm	8432 0800 21
ETF MT 200	20-200	1.77-17.7	800	272	30	1.2	2.65	1/4" HEX	8432 0800 16
ETF MT 500	50-500	4.42-44.2	500	258	40	1.8	4.05	1/4" HEX	8432 0800 17

## TRANSDUCERIZED TOOLS – ETD MT

MicroTorque transducerized handheld screwdrivers ETD MT are smart, interactive and precise with improved ergonomic design and functionalities, helps to enhance production efficiency, minimize product quality cost and further increase productivity.

- High accuracy transducerized tools.
- Internal transducer helps measure real calibrated torque to further enhance reliability of the torque data and traceability of tightening errors.
- Guiding light and gentle vibration give operators feedback when there are NOK tightening results.



ETD MT 41



ETD MT 21

Model	Torque range		Speed r/min	Length mm	Overall width mm	Weight		Bit drive	Ordering No.
	cNm	in lb				kg	lb		
ETD MT 21-25-HM4	5-25	0.44-2.21	1000	226	32	0.35	0.77	HM 4 mm	8432 0845 25
ETD MT 41-50-HM4	10-50	0.9-4.4	2000	248	34	0.60	1.32	HM 4 mm	8432 0845 50
ETD MT 41-100-HM4	20-100	1.8-8.9	2000	248	34	0.60	1.32	HM 4 mm	8432 0845 60
ETD MT 41-50-I06	10-50	0.9-4.4	2000	254	34	0.65	1.43	1/4" Hex	8432 0845 51
ETD MT 41-100-I06	20-100	1.8-8.9	2000	254	34	0.65	1.43	1/4" Hex	8432 0845 61
ETD MT 41-150-I06	30-150	2.7-13.3	1000	254	34	0.65	1.43	1/4" Hex	8432 0845 70
ETD MT 41-250-I06	50-250	4.4-22.1	750	254	34	0.65	1.43	1/4" Hex	8432 0845 80

### MTF 400

MT Focus 400 is an extremely compact and advanced controller designed to attend the most demanding assembly processes. It offers the advanced seating control strategy, multiple Psets, multi-steps tightening and ensures high quality and productivity. It is compatible with the latest MicroTorque tools including ETD M ABL V2 and QMC (excluding QMC21-05).

- 20 P-sets.
- Multistep tightening.
- Simple programing directly at the controller.
- Advanced programing via PC software, ToolsTalk MT.
- Batch count.
- Different display lights for operator feedback.
- Multiple I/Os for integration with assembly line, automation stations or error proofing accessories.
- ToolsTalk MT included, with Graph Analysis and Net functionality for detailed information.

### MTF 6000

MT Focus 6000 is the latest and most innovative controller from MicroTorque including all features of MTF 400 and much more. It elevates the Atlas Copco's low torque tightening and is designed for Industry 4.0.

MT Focus 6000 is smart with new advanced tightening strategies such as Torque Seating Monitoring. With Batch Sequence it is easy to setup simple workflow instructions to ensure efficiency, and the multi communication ports ensures connectivity with external equipment and software.

With two different levels of functionality, the IAM models gives a good offering for every customer. IAM Workstation is designed for a workstation setup with no or low need for advanced tightening strategies and communication. For processes, with a need of communication, data and advanced tightening strategies, IAM Process is the right choice.



MTF 6000



MTF 400A

Model	Ordering No.
MTF 6000	8432 0851 00
MTF 400A	8432 0850 00

**NOTE:** Ordering number for controller only. PSU and IAM Module (for MTF6000) has to be ordered separately.

### IAM FOR MTF 6000

Model	Ordering No.
IAM MT Workstation	8432 0852 10
IAM MT Process	8432 0852 20



	MTF6000	
	IAM Workstation 8432 0852 10	IAM Process 8432 0852 20
<b>Tightening</b>		
Number of Psets	50	150
Multi step tightening	●	●
Number of tightening steps	5	10
Number of batch sequence	20	50
Batch sequence - Batch count	250	250
Batch sequence - Steps	30	30
Number of identifiers	20	50
Torque and angle control	●	●
Thread engagement step	●	●
Angle step	●	●
Torque step	●	●
Seating control strategy (SCS)		●
Torque seating monitoring (TSM)		●
Bit slip detection		●
<b>Data Storage and Analysis</b>		
Detailed data results stored in the controller	●	●
Results - Data storage	100000	100000
Graphs - Data storage		1000
Download results data via USB memory	●	●
Download graphs data via USB memory		●
Realtime trace analysis - ToolsTalk (USB only)	●	●
Save graphs via ToolsTalk Analysis (USB)		●
Auto save graph via ToolsTak Analysis (USB Only)	●	●
ToolsNet 8 data reporting		●
<b>Communication</b>		
Configurable Digital I/Os	●	●
Number of digital I/Os (in/out)	(12/8)	(12/8)
Open Protocol (MicroTorque Legacy)		
Open Protocol (Atlas Cocpo V2)		RS232, Ethernet
Direct communication with ToolsNet 8		●
<b>Others</b>		
Transducerized tools		●
Barcode reader	●	●
Quick programming	●	●
Password protection	●	●
Customized 3 levels of password protection	●	●
Remote configuration via Ethernet		●
<b>Ports (Hardware Only - Not Functionality)</b>		
RS232	1	1
Fieldbus	1	1
USB device	1	1
USB host	1	1
I/O Bus	1	1
Ethernet	1	1
Digital I/Os	(12/8)	(12/8)

## Optional Accessories

### POWER SUPPLY UNIT, PSU

Model	Battery / Power	Ordering No.
<b>MTF 6000</b> ETD M ABL V2 and QMC, all tools	36V / 180W	8432 0840 02
<b>MTF 400</b> ETF S08 V2 and ETD M08/20/27 ABL V2	24V / 72W	8432 0840 00
ETD M50/80/100/120/200/250 ABL V2 and QMC, all tools	36V / 180W	8432 0840 02



Power supply unit

### CONTROLLER AND TOOL ACCESSORIES

Model	Ordering No.
Controller wall fixture for MTF 400 and MTF 6000	8432 0833 83
Y cable for I/O connector <sup>a</sup>	8432 0831 99
I/O extension cable 1 m	4216 1933 80
I/O adapter cable <sup>b</sup>	4216 2665 80
Bit magnet 1/4 for Hex bits, 5 pieces	8432 0861 02
Bit magnet 4 mm for HM4 bit, 5 pieces	8432 0861 05



Digital program selector

<sup>a</sup> Y cable for MTF6000 and G4, suitable when two I/O accessories are required.

<sup>b</sup> Used when MTF6000 shall be connected to a MTF400 I/O system.

### TOOL CABLE

Model	Length	Ordering No.
QMC, ETD M ABL V2, ETF S	2 m	8432 0835 20
QMC, ETD M ABL V2, ETF S	3.5 m	8432 0835 35
QMC, ETD M ABL V2, ETF S	5 m	8432 0835 50
ETF M, MT	2 m	8432 0836 20
ETF M, MT	3.5 m	8432 0836 35
ETF M, MT 90 deg angle cable	2 m	8432 0831 15



Tool cable, 90 deg

### CABLE ACCESSORIES

Model	Ordering No.
Cable, USB	4222 1238 02
Cable RS232	4216 2174 80
Transducer cable	8432 0830 35
Cable bracket	8432 0830 91



Tool cable

## Optional Accessories

### VACUUM PUMP

Model	Ordering No.
Vacuum pump MT	8432 0854 00



Vacuum pump MT

### VACUUM ADAPTER

Model	Nozzle Ø mm	Tool Bit Drive	Tool model	Ordering No.
QC Vacuum adapter Small	8	HM4	ETD M, ETF S, ETF M, ETF MT and QMC	8432 0770 58
QC Vacuum adapter Large	12	1/4" HEX	ETD M and QMC	8432 0770 57
QC Vacuum adapter Large	12	1/4" HEX	ETF M100, ETF MT100, ETF M200 and ETF MT200	8432 0770 59
QC Vacuum adapter	5.8	HM4	ETD MT	8432 0770 60
QC Vacuum adapter	9.8	1/4" HEX	ETD MT	8432 0770 61



Vacuum adapter

### VACUUM NOZZLES

Model	Nozzle Ø mm	Tool Bit Drive	Ordering No.
<b>Plastic nozzle</b>	8	HM4	4216 1190 16
	12	1/4" HEX	4216 1190 20
	5.8	HM4	4216 2912 00
	9.8	1/4" HEX	4216 2936 00
<b>Metallic nozzle</b>	8	HM4	4216 1190 17
	12	1/4" HEX	4216 1190 21
	5.8	HM4	4216 4257 00
	9.8	1/4" HEX	4216 4257 01



Vacuum adapters for ETD MT



Vacuum nozzles

### SCREW DISPENSER

Model	Screw size	Ordering No.
<b>Screw dispenser for magnetized bit</b>		
SDS screw dispenser	M1.0 - 5.0	8432 0830 00
<b>Screw dispenser for vacuum pick up</b>		
SDS SR 10	M1.0	8432 0870 30
SDS SR 12	M1.2	8432 0870 32
SDS SR 14	M1.4	8432 0870 34
SDS SR 17	M1.7	8432 0870 31
SDS SR 20	M2.0	8432 0870 33
SDS SR 23	M2.3	8432 0870 35
SDS SR 26	M2.6	8432 0870 36
SDS SR 30	M3.0	8432 0870 37



Screw dispenser for magnetic bit



Screw dispenser for vacuum pick up

## ETV ES

- Torque transducer with an accuracy of  $\pm 7.5\%$  over six sigma.
- Robust, sealed design.
- New durable motor with higher speeds.
- Engineered in modules with component commonality.
- Clear LEDs visible through 360°.
- Hot swap.



ETV ES

Model	Square drive in	Torque range		Speed r/min	Weight		Length mm	CS distance mm	Ordering No.
		Nm	ft lb		kg	lb			
<b>Angle models</b>									
ETV ES21-04-06	1/4	1.6-4.5	1.2-3.3	1909	0.85	1.9	284	9.5	8436 0120 04
ETV ES21-07-06	1/4	2.8-7	2.1-5.2	1147	0.85	1.9	284	9.5	8436 0120 07
ETV ES21-12-06	1/4	4.8-12	3.5-8.9	718	0.95	2.1	304	11	8436 0120 12
ETV ES21-20-10	3/8	8-20	5.9-14.8	430	1.05	2.3	303	14	8436 0120 20
ETV ES61-25-10	3/8	10-25	7.4-18.4	1378	1.8	4.0	419	14	8436 0160 25
ETV ES61-30-10	3/8	12-30	8.9-22.1	1160	1.8	4.0	421	15.5	8436 0160 30
ETV ES61-40-10	3/8	16-40	11.8-29.5	1153	1.9	4.2	441	18	8436 0160 40
ETV ES61-50-10	3/8	20-50	14.8-36.9	692	1.9	4.2	441	18	8436 0160 50
ETV ES61-70-13	1/2	28-70	20.7-51.6	439	3.1	6.8	499	20	8436 0160 70
ETV ES61-100-13	1/2	40-100	29.5-73.8	370	3.15	6.9	505	22.5	8436 0160 10
ETV ES61-150-13	1/2	60-150	44.3-110.6	296	3.2	7.1	541	26	8436 0160 15
ETV ES61-180-13	1/2	72-180	53-133	232	3.2	7.1	541	26	8436 0160 18
ETV ES61-200-20	3/4	80-200	59-147.5	203	3.4	7.5	543	27	8436 0160 20
<b>Quick chuck</b>									
ETV ES21-12-I06-QC	–	4.8-12	3.5-8.9	718	0.95	2.1	304	11	8436 0121 12
<b>Flush socket</b>									
ETV ES61-30-FS	–	12-30	8.9-22.1	1160	1.8	4.0	421	16	8436 0160 51
ETV ES61-40-FS	–	16-40	11.8-29.5	1145	1.9	4.2	441	18	8436 0160 52
ETV ES61-50-FS	–	20-50	14.8-36.9	687	1.9	4.2	441	18	8436 0160 53
ETV ES61-70-FS	–	28-70	20.7-51.6	439	3.1	6.8	499	20	8436 0160 54
ETV ES61-100-FS	–	40-100	29.5-73.8	370	3.15	6.9	505	23	8436 0160 55
ETV ES61-150-FS	–	60-150	44.3-110.6	296	3.2	7.1	541	26	8436 0160 57
ETV ES61-180-FS	–	72-180	53-133	232	3.2	7.1	541	26	8436 0160 58
ETV ES61-200-FS	–	80-200	59-147.5	203	3.4	7.5	543	28	8436 0160 59
<b>Hold &amp; Drive</b>									
ETV ES61-30-HAD	–	6-30	4-21	1160	2.4	5.3	442	18.3	8436 0160 61
ETV ES61-50-HAD	–	20-50	14.8-36.9	692	2.2	4.9	441	18	8436 0160 62
ETV ES61-150-HAD	–	60-150	44.3-110.6	296	3.4	7.5	541	26	8436 0160 64
ETV ES61-180-HAD	–	72-180	53-133	232	3.4	7.5	540.4	26	8436 0160 65
ETV ES61-200-HAD	–	80-200	59-147.5	203	3.8	8.4	543	28	8436 0160 66

## ETD/ETF ES

- Torque transducer with an accuracy of  $\pm 7.5\%$  over six sigma.
- Robust, sealed design.
- New durable motor with higher speeds.
- Engineered in modules with component commonality.
- Clear LEDs visible through 360°.
- Hot swap.

ETD ES



ETF ES



Model	Square drive in	Torque range		Speed r/min	Weight		Length mm	CS distance mm	Spline/ Mounting	Ordering No.
		Nm	ft lb		kg	lb				
<b>Straight models</b>										
ETD ES21-02-I06-PS	–	0.8-2	0.6-1.5	4471	0.75	1.7	267	19.5	–	8436 0220 02
ETD ES21-04-I06-PS	–	1.6-4	1.2-3	1909	0.8	1.8	267	19.5	–	8436 0220 04
ETD ES21-07-I06-PS	–	2.8-7	2.1-5.2	1147	0.8	1.8	267	19.5	–	8436 0220 07
ETD ES21-12-I06-PS	–	4.8-12	3.5-8.9	745	0.8	1.8	267	19.5	–	8436 0220 12
ETD ES61-18-10	3/8	7.2-18	5.3-13.3	2129	1.7	3.75	418	23	-/1	8436 0265 18
ETD ES61-18-10-T25	3/8	7.2-18	5.3-13.3	2129	1.85	4.1	456	23	2/2	8436 0260 18
ETD ES61-25-10	3/8	10-25	7.4-18.4	1793	1.7	3.8	418	23	-/1	8436 0265 25
ETD ES61-25-10-T25	3/8	10-25	7.4-18.4	1793	1.85	4.1	456	23	2/2	8436 0260 25
ETD ES61-30-10	3/8	12-30	8.9-22.1	1077	1.7	3.8	418	23	-/1	8436 0265 30
ETD ES61-30-10-T25	3/8	12-30	8.9-22.1	1077	1.85	4.1	456	23	2/2	8436 0260 30
ETD ES61-50-13	1/2	20-50	14.8-36.9	679	2.95	6.5	493	29	2/2	8436 0265 50
ETD ES61-50-13-T25	1/2	20-50	14.8-36.9	679	3.05	6.7	521	29	3/5	8436 0260 50
ETD ES61-70-13	1/2	28-70	20.7-51.6	608	2.95	6.5	493	29	2/2	8436 0265 70
ETD ES61-70-13-T25	1/2	28-70	20.7-51.6	608	3.1	6.8	521	29	3/5	8436 0260 70
ETD ES61-90-13	1/2	36-90	26.6-66.4	467	2.95	6.5	493	29	2/2	8436 0265 90
ETD ES61-90-13-T25	1/2	36-90	26.6-66.4	467	3.1	6.8	521	29	3/5	8436 0260 90
ETD ES61-120-13	1/2	48-120	35.4-88.5	365	2.95	6.5	493	29	2/2	8436 0265 12
ETD ES61-120-13-T25	1/2	48-120	35.4-88.5	365	3.1	6.8	521	29	3/5	8436 0260 12
<b>Straight models with lever start</b>										
ETD ES21-02-I06	–	0.8-2	0.6-1.5	4471	0.78	1.76	267	19.5	–	8436 0221 02
ETD ES21-04-I06	–	1.6-4.5	1.2-3.3	1909	0.83	1.86	267	19.5	–	8436 0221 04
ETD ES21-07-I06	–	2.8-7	2.1-5.2	1147	0.83	1.86	267	19.5	–	8436 0221 07
ETD ES21-12-I06	–	4.8-12	3.5-8.9	745	0.83	1.86	267	19.5	–	8436 0221 12
<b>Fixtured models</b>										
ETF ES21-04-I06-T25	–	1.6-4	1.2-3	1909	0.96	2.1	338	22.5	– <sup>a</sup>	8436 0224 04
ETF ES21-07-I06-T25	–	2.8-7	2.1-5.2	1147	0.96	2.1	338	22.5	– <sup>a</sup>	8436 0224 07
ETF ES21-12-I06-T25	–	4.8-12	3.5-8.9	745	0.96	2.1	338	22.5	– <sup>a</sup>	8436 0224 12

<sup>a</sup> Mounting bracket fixed.

# Pistol Grip Models

## ETP ES

- Torque transducer with an accuracy of  $\pm 7.5\%$  over six sigma.
- Robust, sealed design.
- New durable motor with higher speeds.
- Engineered in modules with component commonality.
- Clear LEDs visible through 360°.
- Hot swap.

ETP ES



Model	Square drive in	Torque range		Speed r/min	Weight		Length mm	CS distance mm	Spline/ Mounting	Ordering No.
		Nm	ft lb		kg	lb				
<b>Pistol grip models</b>										
ETP ES21-02-I06-PS	–	0.8-2	0.6-1.5	4471	0.85	1.87	225	19.5	–	8436 0320 02
ETP ES21-04-I06-PS	–	1.6-4	1.2-3	1909	0.85	1.87	225	19.5	–	8436 0320 04
ETP ES21-07-I06-PS	–	2.8-7	2.1-5.2	1147	0.85	1.87	225	19.5	–	8436 0320 07
ETP ES21-12-I06-PS	–	4.8-12	3.5-8.9	745	0.85	1.87	225	19.5	–	8436 0320 12



# Tensor SL

## ETD SL

- ETD SL is a very compact screwdriver with excellent power to weight ratio.
- Torque range from 0.3 to 10 Nm.
- Push-to-start function and front lights.
- Small center-to-side distance.
- Ergonomic design.
- Buzzer and additional blue LED for better operator support.



ETD SL



ETP SL

## ETV SL

- ETV SL is the most compact transducerised angle screwdriver in the Tensor range.
- Torque range from 0.8 to 20 Nm.
- High durability with spiral angle gears.
- Ergonomic design.
- Buzzer and additional blue LED for better operator support.



ETV SL

## ETP SL

- ETP SL is our first push-to-start pistol tool.
- Torque range from 0.3 to 10 Nm.
- Ergonomic, balanced pistol tool.
- Front lights for dark applications.
- Blue light and buzzer.



ETF SL

## ETF SL

- ETF SL is the smallest and lightest fixed tool.
- Torque range from 0.3 to 10 Nm.
- Stroke with 25 mm suspension.
- Small center-to-side distance.

Model	Torque range		Speed r/min	Weight		Length mm	CS distance <sup>a</sup> mm	Stroke mm	Ordering No.
	Nm	in lb		kg	lb				
<b>Straight tools, push-to-start and front lights</b>									
ETD SL21-01-I06-PS	0.3-1.2	2.7-10	2950	0.7	1.6	246	18/19.5	—	8433 2102 92
ETD SL21-04-I06-PS	0.8-4	7-35	1600	0.7	1.6	246	18/19.5	—	8433 2104 91
ETD SL21-07-I06-PS	1.5-7.5	13-66	970	0.7	1.6	246	18/19.5	—	8433 2107 69
ETD SL21-10-I06-PS	2.0-10	18-89	720	0.7	1.6	246	18/19.5	—	8433 2108 25
<b>Right angle tools, lever start</b>									
ETV SL21-04-I06	0.8-4	7-35	1600	0.75	1.7	279	9	—	8433 2004 47
ETV SL21-04-I06-QC	0.8-4	8-35	1600	0.75	1.7	279	9	—	8433 2004 73
ETV SL21-04-06	0.8-4	9-35	1600	0.75	1.7	279	9	—	8433 2004 91
ETV SL21-07-I06	1.5-7.5	13-66	970	0.75	1.7	279	9	—	8433 2007 66
ETV SL21-07-I06-QC	1.5-7.5	14-66	970	0.75	1.7	279	9	—	8433 2007 79
ETV SL21-07-06	1.5-7.5	15-66	970	0.75	1.7	279	9	—	8433 2007 94
ETV SL21-12-I06	2.5-12	22-106	610	0.8	1.8	282	11	—	8433 2008 34
ETV SL21-12-I06-QC	2.5-12	23-106	610	0.8	1.8	282	11	—	8433 2008 61
ETV SL21-12-06	2.5-12	24-106	610	0.8	1.8	282	11	—	8433 2008 77
ETV SL21-20-10	4-20	36-180	465	0.95	2.1	285	14	—	8433 2009 55
ETV SL21-20-B10	4-20	36-180	465	0.95	2.1	285	14	—	8433 2009 60
<b>Pistol grip, push-to-start</b>									
ETP SL21-01-I06-PS	0.3-1.2	2.7-10	3000	0.85	1.9	246	20.5	—	8433 2201 16
ETP SL21-04-PS	0.8-4	7-35	1600	0.85	1.9	246	20.5	—	8433 2204 66
ETP SL21-07-PS	1.5-7.5	13-66	970	0.85	1.9	246	20.5	—	8433 2207 53
ETP SL21-10-PS	2-10	18-89	720	0.85	1.9	246	20.5	—	8433 2208 28
<b>Fixed tools, lever start or remote start</b>									
ETF SL21-01-I06-T25	0.3-1.2	2.7-10	3000	0.95	2.1	322	18	25	8433 2404 13
ETF SL21-04-I06-T25	0.8-4	7-35	1600	0.95	2.1	322	18	25	8433 2404 19
ETF SL21-07-I06-T25	1.5-7.5	13-66	970	0.95	2.1	322	18	25	8433 2407 26
ETF SL21-10-I06-T25	2-10	18-89	720	0.95	2.1	322	18	25	8433 2408 13

<sup>a</sup> For ETV, CS distance over angle head.

## ETP SR31

The ETP SR is a pistol type electric nut-runner that delivers accurate, fast and error proof tightening with low reaction force. With TurboTight™ the ETP SR31 can handle one hand operations up to 25 Nm.

Delivers fully traceable results, has a low energy consumption and is simple to set up.

- Perfectly balanced and ergonomically designed handle.
- High free run speed (up to 2000 rpm's) and short tightening cycle (Up to 10 tightenings/min).
- Direct and robust gear box.
- The LED ring provides instant input to the operator and the incorporated speaker improve the operator feedback.
- Integrated function button, customized for your needs.



ETP SR



ETV SR



ETD SR

## ETV SR

- SR angle tools are extremely fast, compact and easy to operate.
- ESD certified.
- Easy to configure the function button.
- Front LED's gives better operator feedback.
- Torque range from 2.5 to 30 Nm.

## ETD SR

- SR straight tools are ideal for handheld applications and fixture applications.
- Torque range from 1.5 to 16 Nm.
- Front light guide is integrated.
- Push-to-start mechanism.
- ESD certified.

Model	Torque range		Speed r/min	Weight		Length mm	CS distance mm	Ordering No.
	Nm	ft lb		kg	lb			
<b>Angle models</b>								
ETV SR21-12-10	2.5-12	1.9-8.9	1350	1.1	2.4	297	14	8436 4120 12
ETV SR21-25-10	5-25	3.7-18.5	1000	1.2	2.6	297	14	8436 4120 25
ETV SR21-30-10	6-30	4.4-22.1	663	1.2	2.6	299	15.5	8436 4120 30
<b>Straight models</b>								
ETD SR21-07-I06-PS	1.5-7	1.0-5.2	2090	0.9	1.9	259	24	8436 4220 07
ETD SR21-16-I06-PS	3.5-16	2.6-11.8	1460	1.0	2.2	276	24	8436 4220 16
ETD SR21-07-I06-T25	1.5-7	1.0-5.2	2090	0.9	1.9	353	24	8436 4224 07
ETD SR21-16-10-T25	3.5-16	2.6-11.8	1460	1.0	2.2	353	24	8436 4224 17
<b>Pistol grip models<sup>a</sup></b>								
ETP SR31-25-I06	5-25	3.7-18.4	2010	0.85	1.8	210	19.5	8436 4300 21
ETP SR31-25-10	5-25	3.7-18.4	2010	0.85	1.8	210	19.5	8436 4300 20

<sup>a</sup> Pistol grip models works only with Power Focus 6000.

## Optional Accessories

### COVERS FOR STANDARD SOCKETS

Model	Ordering No.
ETD ES61-18/ 25/ 30	4220 3251 02
ETD ES61-50	4220 3251 03
ETV ES61-30	4220 3154 04
ETV ES61-100	4220 3154 05
ETV ES61-40/50	4220 1995 05
ETV ES61-70	4220 1993 03
ETV SL21, ETV ES61-25	4220 3154 03



Cover for standard sockets

### SUPPORTED EXTENSIONS (~154 MM)

Model	Ordering No.
SR21, ETV SL21	4220 3868 90



Supported extensions

### SUSPENSION YOKES SL/SR

Model	Type	Assembly	Ordering No.
ETD/ETV SL	Horizontal	Motor	4220 0987 81
SR21	For rear		4220 4410 80
SR21	For front		4220 4409 80

### PISTOL GRIP TENSOR SL

Model	Ordering No.
Tensor SL	4220 3516 80



Pistol grip  
Tensor SL

### SUPPORT HANDLE

Model	Ordering No.
ETV/ETD ES21	4220 2725 83
ETD SR21	4220 4347 80



Support handle

### LEVER

Model	Ordering No.
Lever SL	4220 2540 81
Extended lever SL	4220 2540 89
Spoon lever SR21	4220 4338 83
Short lever ETV/ETD ES21	4220 4366 86
Long lever ETV/ETD ES21	4220 4366 85



### TOOL HOLDER SL

Model	Ordering No.
ETP / ETD	4220 3584 80

Tool holder

## Optional Accessories

### CABLES TENSOR ES

Model	Ordering No.
<b>Round cables for ES21</b>	
2 m	4220 4204 02
3 m	4220 4204 03
5 m	4220 4204 05
7 m	4220 4204 07
10 m	4220 4204 10
15 m	4220 4204 15
<b>Flat cables for ES61</b>	
3 m	4220 4339 03
5 m	4220 4339 05
7 m	4220 4339 07
10 m	4220 4339 10
15 m	4220 4339 15
<b>Extension cables for all cables</b>	
3 m	4220 4393 03
5 m	4220 4393 05
10 m	4220 4393 10
15 m	4220 4393 15
25 m	4220 4393 25

### CABLES TENSOR SL

Model	Ordering No.
<b>Tool cable</b>	
3 m	4220 3319 03
5 m	4220 3319 05
10 m	4220 3319 10
15 m	4220 3319 15
<b>Heavy duty cable</b>	
3 m	4220 3378 03
5 m	4220 3378 05
10 m	4220 3378 10
15 m	4220 3378 15
<b>Cables with 90 degrees connector</b>	
3 m	4220 3607 03
5 m	4220 3607 05
10 m	4220 3607 10
20 m	4220 3607 20
<b>Spiral cable straight</b>	
5 m	4220 3746 05
<b>Spiral cable with 90 degrees connector</b>	
5 m	4220 3617 05
<b>Extension cable</b>	
3 m	4220 2795 03
5 m	4220 2795 05
10 m	4220 2795 10



SL Cable



SL Cable with 90 degrees connector



SL Spiral cable

## Optional Accessories

### CABLES TENSOR SR

Model	Power Focus 4000 Ordering No.	Power Focus 6000 Ordering No.
<b>Tool cable</b>		
2 m	4220 2636 02	4220 4375 02
3 m	4220 2636 03	4220 4375 03
5 m	4220 2636 05	4220 4375 05
7 m	4220 2636 07	4220 4375 07
10 m	4220 2636 10	4220 4375 10
15 m	4220 2636 15	4220 4375 15
<b>Cables with 90 degrees connector</b>		
2 m	4220 3891 02	4220 5199 02
3 m	4220 3891 03	4220 5199 03
5 m	4220 3891 05	4220 5199 05
7 m	4220 3891 07	4220 5199 07
10 m	4220 3891 10	4220 5199 10
15 m	4220 3891 15	4220 5199 15
<b>Spiral cable (length/stretched length)</b>		
3 m / 4 m	4220 2757 03	4220 4365 03
7 m / 8 m	4220 2757 07	4220 4365 07
10 m / 12 m	4220 2757 10	4220 4365 10
<b>Cable protection 2 m</b>	4220 2977 90	
<b>Extension cable</b>		
3 m		4220 4393 03
5 m	4220 1007 05	4220 4393 05
10 m	4220 1007 10	4220 4393 10
15 m	4220 1007 15	4220 4393 15
<b>Flat extension cables</b>		
5 m	4220 1563 05	
10 m	4220 1563 10	
15 m	4220 1563 15	



SR Cable



SR Cable with 90 degrees connector



SR Spiral cable



SR Cable protection



## Tensor – the operators' choice

*The Tensor range of electric assembly tools covers all station and assembly line requirements for safety critical and quality critical fastening applications. At Atlas Copco we have a proud legacy of putting the operator first and we continuously improve the ergonomic features on each new generation of Tensor tools. Tensor is also one of the most advanced tool ranges on the market in terms of high power-to-weight ratios and operator guidance in the form of clear result feedback via LED's or audio signals.*

### **PRODUCTIVITY GAINS**

Atlas Copco's unique Tensor motors give the Tensor range outstanding spindle speeds and, thus, help you achieve lower cycle times in your operation. Exceptional ergonomics in terms of balance, grip and low weight make the tools a favorite of the operators and increase individual productivity.

### **OPERATOR FEEDBACK**

All Tensor tools are equipped with LED's that will indicate the tightening result, green light for tightening OK and red light for NOK. Tensor ST and STR have configurable LED's and an integrated speaker for indicating results via audio signals.

### **LOWEST COST OF OPERATION**

At Atlas Copco we believe that quality is the road to lowest cost of operation over time. A maintained Tensor tool produces the same performance year after year at minimum and predictable costs while ensuring highest possible uptime.

### **TENSORTOOLS**

**Tensor SL:** low torque safety critical, configurable tool functions

The Tensor SL range is optimized for safety critical small screw assembly. It offers compact screwdriver ergonomics, combined with traceability and error proofing capabilities.

**Tensor ST:** safety critical, configurable tool functions

The second generation of Tensor tools was developed with low weight and productivity in mind. Tensor ST has an internal bus connection for intelligent accessories such as a barcode reader and torque selector switch.

**Tensor STR, SR:** safety critical, configurable tool functions

The latest generation of Tensor tools where ergonomics and productivity are taken to a new level.

**Tensor ES:** quality critical

Tensor ES transducerized nutrunners for quality critical applications are available in straight and right angle versions. All models have a sealed design for robustness and offer high productivity with improved ergonomics.



## ETV ES

- Torque transducer with an accuracy of  $\pm 7.5\%$  over six sigma.
- Robust, sealed design.
- New durable motor with higher speeds.
- Engineered in modules with component commonality.
- Clear LEDs visible through 360°.
- Hot swap.



ETV ES

Model	Square drive in	Torque range		Speed r/min	Weight		Length mm	CS distance mm	Ordering No.
		Nm	ft lb		kg	lb			
<b>Angle models</b>									
ETV ES21-04-06	1/4	1.6-4.5	1.2-3.3	1909	0.85	1.9	284	9.5	8436 0120 04
ETV ES21-07-06	1/4	2.8-7	2.1-5.2	1147	0.85	1.9	284	9.5	8436 0120 07
ETV ES21-12-06	1/4	4.8-12	3.5-8.9	718	0.95	2.1	304	11	8436 0120 12
ETV ES21-20-10	3/8	8-20	5.9-14.8	430	1.05	2.3	303	14	8436 0120 20
ETV ES61-25-10	3/8	10-25	7.4-18.4	1378	1.8	4.0	419	14	8436 0160 25
ETV ES61-30-10	3/8	12-30	8.9-22.1	1160	1.8	4.0	421	15.5	8436 0160 30
ETV ES61-40-10	3/8	16-40	11.8-29.5	1153	1.9	4.2	441	18	8436 0160 40
ETV ES61-50-10	3/8	20-50	14.8-36.9	692	1.9	4.2	441	18	8436 0160 50
ETV ES61-70-13	1/2	28-70	20.7-51.6	439	3.1	6.8	499	20	8436 0160 70
ETV ES61-100-13	1/2	40-100	29.5-73.8	370	3.15	6.9	505	22.5	8436 0160 10
ETV ES61-150-13	1/2	60-150	44.3-110.6	296	3.2	7.1	541	26	8436 0160 15
ETV ES61-180-13	1/2	72-180	53-133	232	3.2	7.1	541	26	8436 0160 18
ETV ES61-200-20	3/4	80-200	59-147.5	203	3.4	7.5	543	27	8436 0160 20
<b>Quick chuck</b>									
ETV ES21-12-I06-QC	–	4.8-12	3.5-8.9	718	0.95	2.1	304	11	8436 0121 12
<b>Flush socket</b>									
ETV ES61-30-FS	–	12-30	8.9-22.1	1160	1.8	4.0	421	16	8436 0160 51
ETV ES61-40-FS	–	16-40	11.8-29.5	1145	1.9	4.2	441	18	8436 0160 52
ETV ES61-50-FS	–	20-50	14.8-36.9	687	1.9	4.2	441	18	8436 0160 53
ETV ES61-70-FS	–	28-70	20.7-51.6	439	3.1	6.8	499	20	8436 0160 54
ETV ES61-100-FS	–	40-100	29.5-73.8	370	3.15	6.9	505	23	8436 0160 55
ETV ES61-150-FS	–	60-150	44.3-110.6	296	3.2	7.1	541	26	8436 0160 57
ETV ES61-180-FS	–	72-180	53-133	232	3.2	7.1	541	26	8436 0160 58
ETV ES61-200-FS	–	80-200	59-147.5	203	3.4	7.5	543	28	8436 0160 59
<b>Hold &amp; Drive</b>									
ETV ES61-30-HAD	–	6-30	4-21	1160	2.4	5.3	442	18.3	8436 0160 61
ETV ES61-50-HAD	–	20-50	14.8-36.9	692	2.2	4.9	441	18	8436 0160 62
ETV ES61-150-HAD	–	60-150	44.3-110.6	296	3.4	7.5	541	26	8436 0160 64
ETV ES61-180-HAD	–	72-180	53-133	232	3.4	7.5	540.4	26	8436 0160 65
ETV ES61-200-HAD	–	80-200	59-147.5	203	3.8	8.4	543	28	8436 0160 66

## ETD/ETF ES

- Torque transducer with an accuracy of  $\pm 7.5\%$  over six sigma.
- Robust, sealed design.
- New durable motor with higher speeds.
- Engineered in modules with component commonality.
- Clear LEDs visible through 360°.
- Hot swap.

ETD ES



ETF ES



Model	Square drive in	Torque range		Speed r/min	Weight		Length mm	CS distance mm	Spline/ Mounting	Ordering No.
		Nm	ft lb		kg	lb				
<b>Straight models</b>										
ETD ES21-02-I06-PS	–	0.8-2	0.6-1.5	4471	0.75	1.7	267	19.5	–	8436 0220 02
ETD ES21-04-I06-PS	–	1.6-4	1.2-3	1909	0.8	1.8	267	19.5	–	8436 0220 04
ETD ES21-07-I06-PS	–	2.8-7	2.1-5.2	1147	0.8	1.8	267	19.5	–	8436 0220 07
ETD ES21-12-I06-PS	–	4.8-12	3.5-8.9	745	0.8	1.8	267	19.5	–	8436 0220 12
ETD ES61-18-10	3/8	7.2-18	5.3-13.3	2129	1.7	3.75	418	23	-/1	8436 0265 18
ETD ES61-18-10-T25	3/8	7.2-18	5.3-13.3	2129	1.85	4.1	456	23	2/2	8436 0260 18
ETD ES61-25-10	3/8	10-25	7.4-18.4	1793	1.7	3.8	418	23	-/1	8436 0265 25
ETD ES61-25-10-T25	3/8	10-25	7.4-18.4	1793	1.85	4.1	456	23	2/2	8436 0260 25
ETD ES61-30-10	3/8	12-30	8.9-22.1	1077	1.7	3.8	418	23	-/1	8436 0265 30
ETD ES61-30-10-T25	3/8	12-30	8.9-22.1	1077	1.85	4.1	456	23	2/2	8436 0260 30
ETD ES61-50-13	1/2	20-50	14.8-36.9	679	2.95	6.5	493	29	2/2	8436 0265 50
ETD ES61-50-13-T25	1/2	20-50	14.8-36.9	679	3.05	6.7	521	29	3/5	8436 0260 50
ETD ES61-70-13	1/2	28-70	20.7-51.6	608	2.95	6.5	493	29	2/2	8436 0265 70
ETD ES61-70-13-T25	1/2	28-70	20.7-51.6	608	3.1	6.8	521	29	3/5	8436 0260 70
ETD ES61-90-13	1/2	36-90	26.6-66.4	467	2.95	6.5	493	29	2/2	8436 0265 90
ETD ES61-90-13-T25	1/2	36-90	26.6-66.4	467	3.1	6.8	521	29	3/5	8436 0260 90
ETD ES61-120-13	1/2	48-120	35.4-88.5	365	2.95	6.5	493	29	2/2	8436 0265 12
ETD ES61-120-13-T25	1/2	48-120	35.4-88.5	365	3.1	6.8	521	29	3/5	8436 0260 12
<b>Straight models with lever start</b>										
ETD ES21-02-I06	–	0.8-2	0.6-1.5	4471	0.78	1.76	267	19.5	–	8436 0221 02
ETD ES21-04-I06	–	1.6-4.5	1.2-3.3	1909	0.83	1.86	267	19.5	–	8436 0221 04
ETD ES21-07-I06	–	2.8-7	2.1-5.2	1147	0.83	1.86	267	19.5	–	8436 0221 07
ETD ES21-12-I06	–	4.8-12	3.5-8.9	745	0.83	1.86	267	19.5	–	8436 0221 12
<b>Fixtured models</b>										
ETF ES21-04-I06-T25	–	1.6-4	1.2-3	1909	0.96	2.1	338	22.5	– <sup>a</sup>	8436 0224 04
ETF ES21-07-I06-T25	–	2.8-7	2.1-5.2	1147	0.96	2.1	338	22.5	– <sup>a</sup>	8436 0224 07
ETF ES21-12-I06-T25	–	4.8-12	3.5-8.9	745	0.96	2.1	338	22.5	– <sup>a</sup>	8436 0224 12

<sup>a</sup> Mounting bracket fixed.

# Pistol Grip Models

## ETP ES

- Torque transducer with an accuracy of  $\pm 7.5\%$  over six sigma.
- Robust, sealed design.
- New durable motor with higher speeds.
- Engineered in modules with component commonality.
- Clear LEDs visible through 360°.
- Hot swap.

ETP ES



Model	Square drive in	Torque range		Speed r/min	Weight		Length mm	CS distance mm	Spline/ Mounting	Ordering No.
		Nm	ft lb		kg	lb				
<b>Pistol grip models</b>										
ETP ES21-02-I06-PS	–	0.8-2	0.6-1.5	4471	0.85	1.87	225	19.5	–	8436 0320 02
ETP ES21-04-I06-PS	–	1.6-4	1.2-3	1909	0.85	1.87	225	19.5	–	8436 0320 04
ETP ES21-07-I06-PS	–	2.8-7	2.1-5.2	1147	0.85	1.87	225	19.5	–	8436 0320 07
ETP ES21-12-I06-PS	–	4.8-12	3.5-8.9	745	0.85	1.87	225	19.5	–	8436 0320 12

# Tensor ES Crowfoot

## IN-LINE CROWFOOT TOOLS

### Dimensions

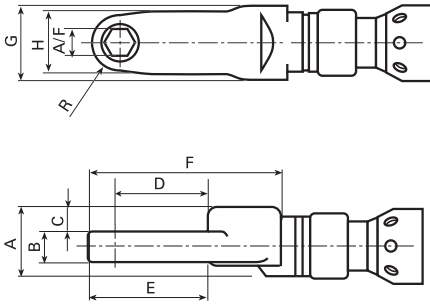

ETC ES

Model	Torque range		Speed r/min	Weight		Length mm	A/F mm	A mm	B mm	C mm	D mm	E mm	F mm	G mm	H mm	R mm	Ordering No.
	Nm	ft lb		kg	lb												
<b>ETC ES61</b>																	
ETC ES61-18-10-LI3	7.2-18	5.4-13	1789	2.2	4.9	503	10	34	15	12.5	36.7	59.2	82.2	35	22	10	8436 0160 31
ETC ES61-28-12-LI3	11.2-28	8.3-20.6	810	2.2	4.9	515	12	34	15	12.5	45.5	71	94	35	30	13	8436 0160 33

**NOTE:** Tensor ES models of crowfoot and open end are not compatible with Power Focus 600.

## OFFSET CROWFOOT TOOLS

### Dimensions

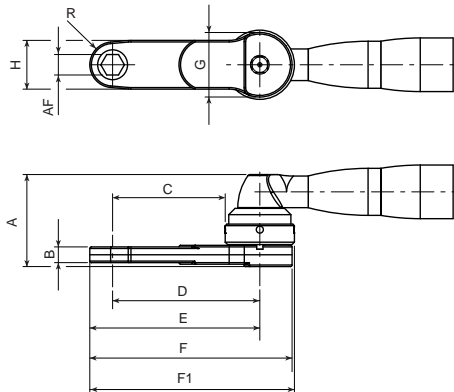

ETC ES

Model	Torque range		Speed r/min	Weight		Length mm	A/F mm	A mm	B mm	C mm	D mm	E mm	F mm	G mm	H mm	R mm	F1 mm	Ordering No.
	Nm	ft lb		kg	lb													
<b>ETC ES61</b>																		
ETC ES61-18-10-LO5	7.2-18	5.4-13.2	1160	2.1	4.7	485	10	61.8	15	47.4	65.6	75.6	90.6	36.5	22	10	94	8436 0160 32
ETC ES61-28-12-LO5	11.2-28	8.3-20	1153	2.4	5.3	520	12	69.5	15	62	84	97	117.5	44	30	13	119	8436 0160 34
ETC ES61-40-13-LO3	16-40	12-29.5	692	2.5	5.6	485	13	68	18	25	47	62	82	44	31	14.5	83.3	8436 0160 35
ETC ES61-50-13-LO3	20-50	15-37	439	3.7	8.2	545	13	86	24	27	51	66	89	48	30	15	90	8436 0160 36
ETC ES61-70-17-LO3	28-70	21-52	370	3.75	8.3	537	17	81	27	31.8	55.8	72.3	94.8	48	33	16.5	96.3	8436 0160 37

**NOTE:** Tensor ES models of crowfoot and open end are not compatible with Power Focus 600.

## IN-LINE TUBE NUT TOOLS

### Dimensions

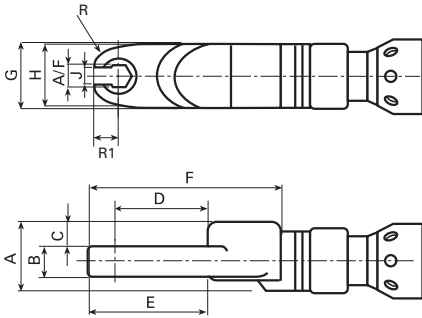

ETO ES

Model	Torque range		Speed r/min	Weight		Length mm	A/F mm	A mm	B mm	C mm	D mm	E mm	F mm	G mm	H mm	J mm	R mm	R1 mm	Ordering No.
	Nm	ft lb		kg	lb														
<b>ETO ES61</b>																			
ETO ES61-18-10-LI3	7.2-18	5.3-13.3	1597	2.1	4.6	502	10	34	11	14.5	34.1	31.1	81.5	35	38	8	15	11.9	8436 0160 41
ETO ES61-20-10-LI3	8-20	5.9-14.7	1596	2.2	4.85	499	10	34	14	13	31.9	29.7	78.6	35	38	8	14	11.2	8436 0160 42
ETO ES61-28-12-LI3	11.2-28	8.24-20.6	807	2.6	5.8	547	12	43	11	17.5	43.7	29.3	96.5	40	50	10.4	31	15	8436 0160 43
ETO ES61-30-12-LI3	12-30	8.9-22.1	816	2.6	5.75	530	12	43	18	14	34.3	31.4	83	40	40	10.4	25	12.4	8436 0160 45
ETO ES61-30-13-LI3	12-30	8.9-22.1	815	2.6	5.7	533	13	43	18	14	34.3	31.4	83	40	40	10.4	25	12.4	8436 0160 47
ETO ES61-70-19-LI3	28-70	21-52	321	4.8	10.6	664	19	46	18	17	53.8	38.8	137.2	64	59	17	32	20.1	8436 0160 49

**NOTE:** Tensor ES models of crowfoot and open end are not compatible with Power Focus 600.

## OFFSET TUBE NUT TOOLS

### Dimensions

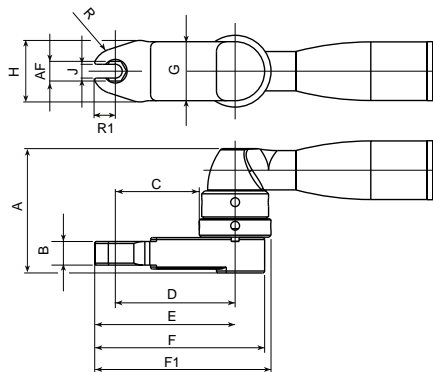

ETO ES

Model	Torque range		Speed r/min	Weight		Length mm	A/F mm	A mm	B mm	C mm	D mm	E mm	F mm	G mm	H mm	J mm	R1 mm	R mm	F1 mm	Ordering No.
	Nm	ft lb		kg	lb															
<b>ETO ES61</b>																				
ETO ES61-28-13-LO3	11.2-28	8.24-20.6	1153	2.3	5.1	475	13	65	11	12.8	36.8	51.8	74.3	48	50	10.4	15	31	75.8	8436 0160 44
ETO ES61-30-13-LO5	12-30	8.9-22.1	692	2.5	5.5	511	13	72.5	18	53.3	75.3	87.7	108.2	44	40	10.4	12.4	25	109.7	8436 0160 46
ETO ES61-50-17-LO5	20-50	14.8-37	439	3.9	8.6	585	17	80	18	66.8	90.8	105.8	128.3	48	50	12	15	31	129.8	8436 0160 48

**NOTE:** Tensor ES models of crowfoot and open end are not compatible with Power Focus 600.



## ETV ST

- ETV ST right angle tools are ideal for hand-held and fixtured applications.
- Torque range from 1 to 4000 Nm.
- Tensor ST offers:
  - Extremely high productivity.
  - More ergonomic benefits.
  - Better operator feedback.
- The ETV ST ATEX tools are certified to be used in environments with hazardous gases and liquids.



ETV ST

Model	Square drive in	Torque range		Speed r/min	Weight		Length mm	CS distance mm	Height mm	Ordering No.
		Nm	ft lb		kg	lb				
<b>ETV ST81</b>										
ETV ST81-50-10	3/8	16-55	12-40	1090	1.8	3.9	473	18	48	8433 2051 55
ETV ST81-70-13	1/2	20-80	15-58	790	2.3	5.0	485	20	58	8433 2053 48
ETV ST81-100-13	1/2	20-100	15-80	540	2.7	5.9	522	22.5	60	8433 2056 82
ETV ST81-150-13	1/2	30-160	22-117	380	3.2	7.0	555	26	65	8433 2060 12
ETV ST81-180-13	1/2	35-180	26-133	310	3.2	7.0	555	26	65	8433 2062 31
ETV ST81-200-20	3/4	40-200	30-154	300	3.2	7.0	556	27	70	8433 2063 42
<b>ETV ST81 Flush Socket</b>										
ETV ST81-100-FS	-	20-100	15-80	540	2.7	5.9	522	23	51	8433 2058 68
ETV ST81-180-FS	-	35-180	26-133	310	3.2	7.0	555	26	58	8433 2062 50
ETV ST81-200-FS	-	40-200	30-154	300	3.2	7.0	557	28	58	8433 2064 59
<b>ETV ST81 Hold &amp; Drive</b>										
ETV ST81-50-HAD	-	16-55	12-40	1090	2.3	5.0	473	18.5	62	8433 2052 80
ETV ST81-100-HAD	-	20-100	15-80	665	2.6	5.7	542	23	71	8433 2056 36
ETV ST81-100-HAD-HD	-	20-100	15-80	665	2.7	5.9	542	26	80	8433 2056 35
ETV ST81-120-HAD	-	30-130	22-100	540	2.8	6.0	560	26	80	8433 2058 65
ETV ST81-150-HAD	-	30-160	22-117	365	3.3	7.0	560	26	80	8433 2061 81
ETV ST81-180-HAD	-	35-180	26-133	310	3.3	7.0	560	26	80	8433 2062 60
ETV ST81-200-HAD	-	40-200	30-154	300	3.3	7.0	561	28	81	8433 2065 09
<b>ETV ST101</b>										
ETV ST101-100-13	1/2	20-100	15-74	920	4.2	9.3	572	22.5	44	8433 2080 10
ETV ST101-180-13	1/2	50-180	37-133	575	4.2	9.3	600	25.3	47	8433 2080 52
ETV ST101-200-20	3/4	50-200	37-147	485	4.4	9.7	602	27.5	47	8433 2080 92
ETV ST101-270-20	3/4	65-270	48-199	380	7.3	16.1	672	32.9	62	8433 2081 23
ETV ST101-370-20	3/4	90-370	66-273	280	7.3	16.1	672	32.9	62	8433 2082 26
ETV ST101-450-20	3/4	110-450	81-332	230	10.6	23.4	715	54.0	76	8433 2082 81
ETV ST101-600-25	1	150-600	111-443	151	10.6	23.4	715	54.0	76	8433 2083 56
<b>ETV ST101 Fan</b>										
ETV ST101-100-13-F	1/2	20-100	15-74	920	4.2	9.3	572	23	44	8433 2080 30
ETV ST101-180-13-F	1/2	50-180	37-133	575	4.2	9.3	600	25	47	8433 2080 63
ETV ST101-200-20-F	3/4	50-200	37-147	485	4.4	9.7	602	28	47	8433 2080 93
ETV ST101-270-20-F	3/4	65-270	48-199	380	7.3	16.1	672	33	62	8433 2081 45
ETV ST101-370-20-F	3/4	90-370	66-273	280	7.3	16.1	672	33	62	8433 2082 48
ETV ST101-450-20-F	3/4	110-450	81-332	230	10.6	23.4	715	54	76	8433 2082 90
ETV ST101-600-25-F	1	150-600	111-443	150	10.6	23.4	715	54	76	8433 2083 69
<b>ETV ST101 Torque Multiplier</b>										
ETV ST101-600-TM	3/4	150-600	111-443	132	7.6	16.8	613	34	143	8433 2083 62
ETV ST101-1000-TM	1	250-1000	184-734	77	11.3	24.3	679	40	191	8433 2084 05
ETV ST101-1500-25-TM	1	325-1500	240-1100	23	12	26	625	43	257	8433 2084 65
ETV ST101-1500-38-TM	1 1/2	325-1500	240-1100	48	19	42	719	71	233	8433 2084 70
ETV ST101-2000-38-TM	1 1/2	500-2000	370-1475	35	19	42	719	71	231	8433 2084 80
ETV ST101-4000-38-TM	1 1/2	1000-4000	734-2950	21.8	21.5	47	710	71	350	8433 2084 90
<b>ETV ST101 Torque Multiplier/Fan</b>										
ETV ST101-600-TM-F	3/4	150-600	111-443	132	7.6	16.8	613	34	143	8433 2083 96
ETV ST101-1000-TM-F	1	250-1000	184-734	77	11.3	24.3	679	40	191	8433 2084 10

## ETD ST

- ETD ST inline tools.
- Torque range from 1 to 4000 Nm.
- Tensor ST offers:
  - Extremely high productivity.
  - Ergonomic design.
  - Excellent operator feedback.



ETD ST

Model	Square drive in	Torque range		Speed r/min	Weight		Length mm	CS distance mm	Splines/ Mounting	Ordering No.
		Nm	ft lb		kg	lb				
<b>ETD ST81</b>										
ETD ST81-30-10	3/8	10-30	7-22	1700	1.8	4.0	450	24	- / 1	8433 2151 93
ETD ST81-50-13	1/2	16-50	12-37	1230	2.1	4.6	493	24	2 / 2	8433 2153 34
ETD ST81-70-13	1/2	15-70	12-51	880	2.5	5.5	510	26.5	2 / 2	8433 2156 03
ETD ST81-90-13	1/2	20-95	15-70	675	2.5	5.5	510	26.5	2 / 2	8433 2158 14
ETD ST81-120-13	1/2	25-125	19-91	505	2.5	5.5	510	26.5	2 / 2	8433 2160 25
<b>ETD ST81 Telescopic</b>										
ETD ST81-70-13-T25	1/2	15-70	12-51	880	2.6	5.8	538	26.5	3 / 5	8433 2154 98
ETD ST81-90-13-T25	1/2	20-95	15-70	675	2.6	5.8	538	26.5	3 / 5	8433 2157 25
ETD ST81-120-13-T25	1/2	25-125	19-91	505	2.6	5.8	538	26.5	3 / 5	8433 2159 53
<b>ETD ST101</b>										
ETD ST101-100-13	1/2	25-100	18-73	1043	3.2	7.0	631	30.5	-	8433 2179 00
ETD ST101-120-13	1/2	30-120	22-88	875	3.2	7.0	631	30.5	-	8433 2180 22
ETD ST101-150-20	3/4	30-150	22-109	685	4.3	9.3	706	33	-	8433 2181 36
ETD ST101-200-20	3/4	50-200	36-146	500	7.4	16.3	706	33	-	8433 2182 05
ETD ST101-300-20	3/4	70-300	51-221	345	7.4	16.3	706	33	-	8433 2182 70
ETD ST101-500-20	3/4	120-500	88-368	204	8.3	18.5	717	33	-	8433 2183 28
ETD ST101-750-25	1	150-750	109-553	143	9.1	20.3	681	45	-	8433 2184 40
ETD ST101-1000-25	1	250-1000	184-737	100	9.7	21.6	708	45	-	8433 2185 60
ETD ST101-1200-25-S	1	300-1200	220-885	81	12	26	787	47	7	8433 2196 10
<b>ETD ST101 Fan</b>										
ETD ST101-100-13-F	1/2	25-100	18-73	1043	3.2	7.0	631	30.5	-	8433 2179 05
ETD ST101-150-20-F	3/4	30-150	22-109	685	4.3	9.3	706	33	-	8433 2181 40
ETD ST101-200-20-F	3/4	50-200	36-146	500	7.4	16.3	706	33	-	8433 2182 10
ETD ST101-300-20-F	3/4	70-300	51-221	345	7.4	16.3	706	33	-	8433 2182 72
ETD ST101-500-20-F	3/4	120-500	88-368	204	8.3	18.5	717	33	-	8433 2183 30
ETD ST101-750-25-F	1	150-750	109-553	143	9.1	20.3	681	45	-	8433 2184 50
ETD ST101-1200-25-F	1	300-1200	220-885	81	12	26	787	47	-	8433 2186 10
ETD ST101-2000-38-F	1 1/2	500-2000	370-1475	48	17	37	742	68	-	8433 2187 22
ETD ST101-2000-38-S-F	1 1/2	500-2000	370-1475	48	17	37	742	68	8	8433 2197 22
ETD ST101-4000-38-F	1 1/2	1000-4000	735-2950	25	22	48	823	68	-	8433 2187 40
ETD ST101-4000-38-S-F	1 1/2	1000-4000	735-2950	25	22	48	823	68	8	8433 2197 40
<b>ETD ST101 Telescopic</b>										
ETD ST101-100-13-T25	1/2	25-100	18-73	1043	3.3	7.3	656	30.5	-	8433 2179 10
ETD ST101-120-13-T25	1/2	30-120	22-88	873	3.3	7.3	656	30.5	-	8433 2180 32
ETD ST101-150-20-T40	3/4	30-150	22-109	685	4.4	9.7	656	30.5	-	8433 2181 46
ETD ST101-200-20-T40	3/4	50-200	36-146	500	7.5	16.5	756	33	-	8433 2182 23
ETD ST101-300-20-T40	3/4	70-300	51-221	345	7.5	16.5	756	33	-	8433 2182 82
ETD ST101-500-20-T40	3/4	120-500	88-368	204	8.4	18.5	768	37	-	8433 2183 38
ETD ST101-750-25-T50	1	150-750	109-553	143	9.2	20.3	727	45	-	8433 2184 56
ETD ST101-1000-25-T50	1	250-1000	184-737	100	9.8	21.6	754	45	-	8433 2185 78
<b>ETD ST101 Telescopic Fan</b>										
ETD ST101-100-13-T25-F	1/2	25-100	18-73	1043	3.3	7.3	656	30.5	-	8433 2179 15
ETD ST101-120-13-T25-F	1/2	30-120	22-88	873	3.3	7.3	656	30.5	-	8433 2180 48
ETD ST101-150-20-T40-F	3/4	30-150	22-109	685	4.4	9.7	656	30.5	-	8433 2181 59
ETD ST101-200-20-T40-F	3/4	50-200	36-146	500	7.5	16.5	756	33	-	8433 2182 45
ETD ST101-300-20-T40-F	3/4	70-300	51-221	345	7.5	16.5	756	33	-	8433 2182 91
ETD ST101-500-20-T40-F	3/4	120-500	88-368	204	8.4	18.5	769	37	-	8433 2183 49
ETD ST101-750-25-T50-F	1	150-750	109-553	143	9.2	20.3	769	45	-	8433 2184 69
ETD ST101-1000-25-T50-F	1	250-1000	184-737	100	9.8	21.6	755	45	-	8433 2185 89
ETD ST101-1200-25-T50-F	1	300-1200	220-885	81	12	26	844	47	-	8433 2186 12
ETD ST101-1200-25-T50-S-F	1	300-1200	220-885	81	12	26	844	47	7	8433 2196 12
ETD ST101-2000-38-T50-F	1 1/2	500-2000	370-1475	48	17	37	840	68	-	8433 2187 20
ETD ST101-2000-38-T50-S-F	1 1/2	500-2000	370-1475	48	17	37	840	68	8	8433 2197 20
ETD ST101-4000-38-T50-F	1 1/2	1000-4000	735-2950	25	22	48	921	68	-	8433 2187 42
ETD ST101-4000-38-T50-S-F	1 1/2	1000-4000	735-2950	25	22	48	921	68	8	8433 2197 42

# Tensor ST

# Pistol Grip Models

## ETP ST

- ETP ST is a pistol grip model for hand-held applications.
- Torque range from 1 to 20 Nm.
- Female hex drive for bits.
- Low weight and ergonomic grip.
- Easy to access, reverse button.
- Operator friendly, feedback signals with sound and lights.



ETP ST

Model	Square drive in	Torque range		Speed r/min	Weight		Length mm	Height mm	Ordering No.
		Nm	ft lb		kg	lb			
<b>ETP ST32</b>									
ETP ST32-05-10	3/8	1-5	0.7-3.6	2820	0.75	1.7	197	179	8433 2211 03
ETP ST32-05-I06	-	1-5	0.7-3.6	2820	0.75	1.7	197	179	8433 2212 19
ETP ST32-10-10	3/8	3-11	2.2-8.0	1210	0.8	1.8	197	179	8433 2213 48
ETP ST32-10-I06	-	3-11	2.2-8.0	1210	0.8	1.8	197	179	8433 2214 63
ETP ST32-20-10	3/8	5-20	3.6-15.0	677	0.91	2	235	179	8433 2216 95
ETP ST32-20-I06	-	5-20	3.6-15.0	677	0.91	2	235	179	8433 2217 11
<b>ETP ST32 with Barcode Scanner</b>									
ETP ST32-05-I06BCR	-	1-5	0.7-3.7	2820	0.87	2	197	205	8433 2212 29
ETP ST32-10-I06BCR	-	3-11	2.2-8.0	1210	0.92	2.1	197	205	8433 2214 73
ETP ST32-20-I06BCR	-	5-20	3.6-15.0	677	1.03	2.3	237	205	8433 2217 26

# Tensor ST Revo

# Pistol Grip Models

## ST REVO

- Unique and patented 360° swivel with transducer.
- Ultra-compact size improves access.
- Reduced weight means less need for fixtures.
- Display on tool gives direct feedback of tightening result.
- Program selection is made directly on tool.
- Ideal for handheld application or fixtures with reduced space.
- Torque range from 60-8000 Nm.



ETP ST Revo

Model	Square drive in	Torque range		Speed r/min	Weight		Length mm	CS distance mm	Spline	Ordering No.
		Nm	ft lb		kg	lb				
<b>Model with fan</b>										
ETP ST101-200-20-F	3/4	60-200	45-145	396	5.2	11.5	303	32.5	3	8433 2302 02
ETP ST101-300-20-F	3/4	90-300	66-221	293	5.2	11.5	303	32.5	3	8433 2303 02
ETP ST101-500-20-F	3/4	150-500	110-365	186	5.9	13	334	33.5	4	8433 2305 02
ETP ST101-750-25-F	1	220-750	160-550	132	6.2	13.7	353	33.5	5	8433 2307 52
ETP ST101-1000-25-F	1	300-1000	220-735	99	6.4	14.1	364	33.5	5	8433 2310 02
ETP ST101-1500-25-F	1	450-1500	332-1106	47	8.8	19.4	402	43.5	9	8433 2321 52
ETP ST101-2000-38-F	1 1/2	600-2000	442-1475	38	11.5	25.4	454	48	7	8433 2322 02
ETP ST101-3000-38-F	1 1/2	900-3000	664-2212	24	14.8	33	476	59	8	8433 2323 02
ETP ST101-4000-38-F	1 1/2	1200-4000	885-2950	20	15	33	481	59	8	8433 2324 02
ETP ST101-1300-20-F-HA	3/4	390-1300	288-1000	65	6.4	14.1	348	32	-	8433 2313 03
ETP ST101-2400-25-F-HA	1	720-2400	532-1770	31	7.5	16.5	400	35.5	-	8433 2326 03
ETP ST101-4000-25-F-HA	1	1200-4000	885-2950	16	11	24.2	461	50.5	-	8433 2324 03
ETP ST101-5500-38-F-HA	1 1/2	1650-5500	1217-4056	17	13.2	29.1	452	53	-	8433 2325 03
ETP ST101-6500-38-F-HA	1 1/2	1950-6500	1440-4800	12	13.2	29.1	452	53	-	8433 2327 03
ETP ST101-8000-38-F-HA	1 1/2	2400-8000	1770-5900	10	13.2	29.1	452	53	-	8433 2328 03

Reaction bar not included for ETP ST101. See accessory pages.

## OFFSET CROWFOOT TOOLS

### Dimensions

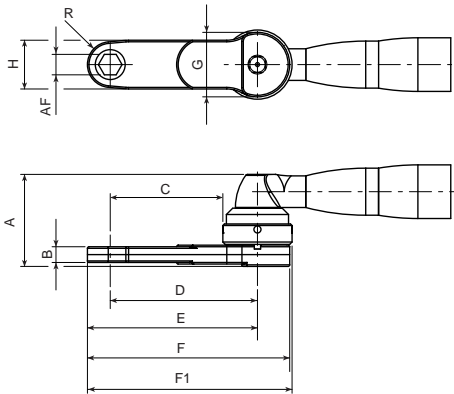

ETC ST

Model	Torque range		Speed r/min	Weight		Length mm	A/F mm	A mm	B mm	C mm	D mm	E mm	F mm	G mm	H mm	R mm	F1 mm	Ordering No.
	Nm	ft lb		kg	lb													
<b>ETC ST101</b>																		
ETC ST101-200-21-LO3	52-215	38-158	380	9.3	20.5	731	21	148.8	40	32.75	70.4	91.4	125.4	75.3	42	21	128.2	8433 2310 51
ETC ST101-200-22-LO3	52-200	38-147	380	9.3	20.5	738	22	139.8	37	38.55	76.2	98.7	132.7	75.3	45	22.5	135.5	8433 2310 57

# Tensor ST Tube Nut

## IN-LINE TUBE NUT TOOLS

### Dimensions

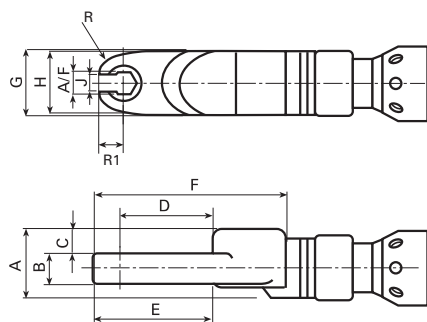

ETO ST

Model	Torque range		Speed r/min	Weight		Length mm	A/F mm	A mm	B mm	C mm	D mm	E mm	F mm	G mm	H mm	J mm	R mm	R1 mm	Ordering No.
	Nm	ft lb		kg	lb														
<b>ETO ST81</b>																			
ETO ST81-100-24-LI3	39-110	28-81	240	4.6	10.1	706	24	46	20	16	71.3	50.6	160.4	64	77	20.5	24.6	33	8433 2311 98

## ETV STR

- Protected against intrusion of dust and water to withstand the toughest environments. IP class 54.
- Built in gyroscope to detect operators influence on tightening.
- Modular STR design for parts commonality between models and sizes.
- Dual accessories support for customizable functionality such as QR code scanning, EHMI display or headlights.
- High cycle rate capability due to improved heat dissipation.
- Operator feed back through built in loudspeaker, vibrator and high visibility LEDs.



ETV STR

Model	Square drive in	Torque range		Speed r/min	Weight		Length mm	CS distance mm	Ordering No.
		Nm	ft lb		kg	lb			
<b>ETV STR31</b>									
ETV STR31-05-10	3/8	1-5	0.7-3.6	3070	1.1	2.4	381	11	8436 6130 05
ETV STR31-10-06	1/4	3-12	2.2-8.8	1310	1.1	2.4	381	11	8436 6130 12
ETV STR31-10-10	3/8	3-12	2.2-8.8	1310	1.1	2.4	381	11	8436 6130 10
ETV STR31-15-10	3/8	5-15	3.6-10	975	1.1	2.4	381	11	8436 6130 15
ETV STR31-20-10	3/8	5-22	3.6-16	705	1.3	2.9	415	14	8436 6130 20
<b>ETV STR31 Female Hex</b>									
ETV STR31-05-I06-QC	1/4	1-5	0.7-3.6	3070	1.1	2.4	381	11	8436 6130 06
ETV STR31-10-I06-QC	1/4	3-12	2.2-8.8	1310	1.1	2.4	381	11	8436 6130 11
<b>ETV STR61</b>									
ETV STR61-25-10	3/8	6-28	4-20	1620	1.4	3.1	439	14	8436 6160 25
ETV STR61-30-10	3/8	7-35	5-25	1220	1.4	3.1	441	15.5	8436 6160 30
ETV STR61-40-10	3/8	8-40	6-29	1220	1.6	3.5	452	18	8436 6160 40
ETV STR61-50-10	3/8	10-55	7-40	735	1.6	3.5	452	18	8436 6160 50
ETV STR61-70-13	1/2	15-80	10-58	530	2.1	4.6	464	20	8436 6160 70
ETV STR61-100-13	1/2	20-100	15-80	390	2.6	5.7	501	22.5	8436 6160 10
ETV STR61-150-13	1/2	30-160	22-117	245	3.0	6.6	537	25.5	8436 6160 15
ETV STR61-180-13	1/2	35-180	26-133	215	3.0	6.6	543	25.5	8436 6160 18
ETV STR61-200-20	3/4	40-200	30-154	215	3.1	6.8	539	27	8436 6160 20
<b>ETV STR61 Barcode scanner and Lamp</b>									
ETV STR61-30-10-BL	3/8	7-35	5-25	1220	1.5	3.3	441	15.5	8436 6169 31
ETV STR61-40-10-BL	3/8	8-40	6-29	1220	1.7	3.7	452	18	8436 6169 41
ETV STR61-50-10-BL	3/8	10-55	7-40	735	1.7	3.7	452	18	8436 6169 51
ETV STR61-70-13-BL	1/2	15-80	10-58	530	2.2	4.8	464	20	8436 6169 71
<b>ETV STR61 Flush Socket</b>									
ETV STR61-30-FS	–	7-35	5-25	1220	1.4	3.1	441	16	8436 6161 43
ETV STR61-40-FS	–	8-40	6-29	1220	1.6	3.5	452	18	8436 6161 50
ETV STR61-50-FS	–	10-55	7-40	735	1.6	3.5	452	18	8436 6161 57
ETV STR61-70-FS	–	15-80	10-58	530	2.1	4.6	464	20	8436 6161 64
ETV STR61-100-FS	–	20-110	15-80	390	2.6	5.7	501	23	8436 6161 08
ETV STR61-150-FS	–	30-160	22-117	237	3	6.6	540	26	8436 6161 15
ETV STR61-180-FS	–	35-180	26-133	190	3.0	6.6	546	26	8436 6161 22
ETV STR61-200-FS	–	40-200	30-154	215	3.1	6.8	543	27	8436 6161 29
<b>ETV STR61 Hold And Drive</b>									
ETV STR61-30-HAD	–	7-35	5-25	1220	2	4.4	464	18.3	8436 6161 42
ETV STR61-50-HAD	–	10-50	7-40	735	2.1	4.6	438	18.3	8436 6161 56
ETV STR61-100-HAD	–	20-100	15-80	390	2.7	5.9	503	23	8436 6161 07
ETV STR61-150-HAD	–	30-160	22-117	237	3.1	6.6	541	26	8436 6161 14
ETV STR61-180-HAD	–	35-180	26-133	215	3.1	6.6	539	26	8436 6161 21
ETV STR61-200-HAD	–	40-200	30-154	215	3.2	7.0	543	26	8436 6161 28



## ETD STR

- Protected against intrusion of dust and water to withstand the toughest environments. IP class 54.
- Built in gyroscope to detect operators influence on tightening.
- Modular STR design for parts commonality between models and sizes.
- Dual accessories support for customizable functionality such as QR code scanning, EHMI display or headlights.
- High cycle rate capability due to improved heat dissipation.
- Operator feed back through built in loudspeaker, vibrator and high visibility LEDs.



ETD STR

Model	Square drive in	Torque range		Speed r/min	Weight		Length mm	CS distance mm	Ordering No.
		Nm	ft lb		kg	lb			
<b>ETD STR31</b>									
ETD STR31-05-10	3/8	1-5	0.7-3.6	3645	1.0	2.2	388	24	8436 6230 05
ETD STR31-10-10	3/8	2-10	1.4-7.3	1555	1.2	2.6	388	24	8436 6230 10
<b>ETD STR31 Female Hex</b>									
ETD STR31-05-106-QC	1/4	1-5	0.7-3.6	3645	1.0	2.2	350	24	8436 6230 07
<b>ETD STR31 Telescopic</b>									
ETD STR31-05-10-T25	3/8	1.5-5	1.1-3.7	1310	1.1	2.4	437	11	8436 6230 06
ETD STR31-10-10-T25	3/8	2-10	1.4-7.3	1555	1.3	2.9	436.5	24	8436 6230 11
<b>ETD STR61</b>									
ETD STR61-15-10	3/8	4-16	3-12	2500	1.4	3.1	438	24	8436 6260 15
ETD STR61-20-10	3/8	5-22	3.6-16	1890	1.4	3.1	438	24	8436 6260 20
ETD STR61-30-10	3/8	6-35	4.4-25	1130	1.4	3.1	429	24	8436 6260 30
ETD STR61-50-13	1/2	10-55	7.3-40	819	2.0	4.4	474	24	8436 6260 50
ETD STR61-70-13	1/2	15-80	12-58	560	2.3	5.1	491	26.5	8436 6260 70
ETD STR61-90-13	1/2	20-95	15-70	440	2.3	5.1	491	26.5	8436 6260 90
<b>ETD STR61 Female Hex</b>									
ETD STR61-15-106-QC	1/4	4-16	3-12	2500	1.3	2.9	429	24	8436 6260 18
<b>ETD STR61 Telescopic</b>									
ETD STR61-15-10-T25	3/8	4-16	3-12	2500	1.5	3.3	477	24	8436 6260 16
ETD STR61-15-10-T50	3/8	4-16	3-12	2500	1.6	3.5	527	24	8436 6260 17
ETD STR61-20-10-T25	3/8	5-22	3.6-16	1890	1.5	3.3	477	24	8436 6260 21
ETD STR61-30-10-T25	3/8	6-35	4.4-25	1130	1.5	3.3	468	24	8436 6260 31
ETD STR61-30-10-T50	3/8	6-35	4.4-25	1130	1.5	3.3	518	24	8436 6260 32
ETD STR61-50-13-T25	1/2	10-55	7.3-40	819	2.2	4.8	501	24	8436 6260 51
ETD STR61-50-13-T50	1/2	10-55	7.3-40	819	2.1	4.6	557	24	8436 6260 52
ETD STR61-70-13-T25	1/2	15-60	12-58	560	2.4	5.4	518	24	8436 6260 71
ETD-STR61-90-13-T25	1/2	20-95	15-70	440	2.4	5.4	518	24	8436 6260 91
ETD STR61-120-13-T50	1/2	36-120	26-88	495	2.5	5.5	574	26.5	8436 6260 62

## ETP STR

- Outstanding power to weight ratio.
- D-handle shape for increased robustness and safety.
- Easy mounting of additional accessories or optional support handle.
- High cycle rate capability due to improved heat dissipation.
- Operator feed back through built in loudspeaker, vibrator and high visibility LEDs.



ETP STR

Model	Square drive in	Torque range		Speed r/min	Weight		Length mm	CS distance mm	Ordering No.
		Nm	ft lb		kg	lb			
<b>ETP STR61</b>									
ETP STR61-20-10	3/8	5-22	3.7-16.2	2100	1.3	2.87	244	24	8436 6360 20
ETP STR61-30-10	3/8	6-32	4.4-23.5	1530	1.3	2.87	244	24	8436 6360 30
ETP STR61-50-13	1/2	10-55	7.4-40.6	820	1.7	3.75	282	24	8436 6360 50
ETP STR61-70-13	1/2	14-80	10.3-59	560	2.0	4.41	298	26.5	8436 6360 70
ETP STR61-90-13	1/2	20-95	14.7-70.4	450	2.0	4.41	298	26.5	8436 6360 90
ETP STR61-120-13	1/2	24-125	17.7-89.4	380	2.0	4.41	298	26.5	8436 6360 12
<b>ETP STR61 Cable On Top</b>									
ETP STR61-20-10 COT	3/8	5-22	3.7-16.2	2100	1.7	3.75	296	24	8436 6368 20
ETP STR61-30-10 COT	3/8	6-32	4.4-23.5	1530	1.7	3.75	296	24	8436 6368 30
ETP STR61-50-13 COT	1/2	10-55	7.4-40.6	820	2.1	4.63	334	24	8436 6368 50
ETP STR61-70-13 COT	1/2	14-80	10.3-59	560	2.4	5.29	350	26.5	8436 6368 70
ETP STR61-90-13 COT	1/2	20-95	14.7-70.4	450	2.4	5.29	350	26.5	8436 6368 90
ETP STR61-120-13 COT	1/2	24-125	17.7-89.4	380	2.4	5.29	350	26.5	8436 6368 12

## ETT STR

- Transducer in front for outstanding accuracy and reliability. +/- 2,5% over 6 sigma.
- Built in gyroscope to detect operators influence on tightening.
- Modular STR design for parts commonality between models and sizes.
- Additional front trigger makes the tool ideal for a combined pre tightening and final tightening combination, two tools in one. front trigger can also be used a safety trigger
- High cycle rate capability due to improved heat dissipation.
- Operator feed back through built in loudspeaker, vibrator and high visibility LEDs.



ETT STR

Model	Square drive in	Torque range		Speed r/min	Weight		Length mm	CS distance mm	Ordering No.
		Nm	ft lb		kg	lb			
<b>ETT STR61</b>									
ETT STR61-20-10	3/8	4-20	3-15	1690	1.6	3.6	384	24	8436 6660 20
ETT STR61-30-10	3/8	6-30	4-22	1300	1.6	3.6	384	24	8436 6660 30
ETT STR61-40-10	3/8	8-40	6-30	1015	1.7	3.7	384	24	8436 6660 40
ETT STR61-50-10	3/8	10-50	7-37	780	1.7	3.7	384	24	8436 6660 50

## IN-LINE CROWFOOT TOOLS

### Dimensions

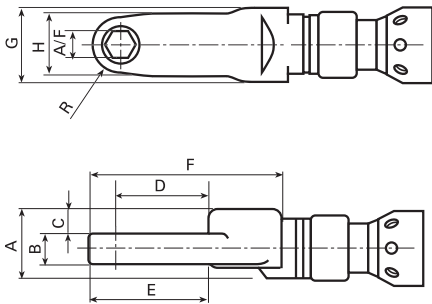

ETC STR

Model	Torque range		Speed r/min	Weight		Length mm	A/F mm	A mm	B mm	C mm	D mm	E mm	F mm	G mm	H mm	R mm	Ordering No.
	Nm	ft lb		kg	lb												
<b>ETC STR61</b>																	
ETC STR61-18-10-LI3	5-18	4-13	1588	1.9	4.2	523	10	34	15	12.5	36.7	59.2	82.2	35	22	10	8436 6730 31
ETC STR61-28-12-LI3	6-28	4-20	850	1.9	4.2	526	12	34	15	12.5	45.5	71	94	35	30	13	8436 6730 33

## OFFSET CROWFOOT TOOLS

### Dimensions

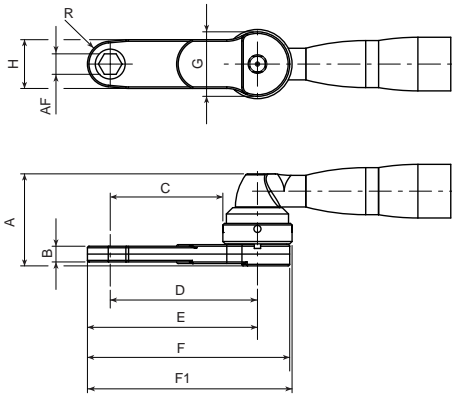

ETC STR

Model	Torque range		Speed r/min	Weight		Length mm	A/F mm	A mm	B mm	C mm	D mm	E mm	F mm	G mm	H mm	R mm	F1 mm	Ordering No.
	Nm	ft lb		kg	lb													
<b>ETC STR61</b>																		
ETC STR61-18-10-LO5	5-18	4-13	1130	1.7	3.8	500	10	61.8	15	47.4	65.6	75.6	90.6	36.5	22	10	94	8436 6730 32
ETC STR61-28-12-LO5	6-28	4-20	1220	2	4.4	533	12	69.5	15	62	84	97	117.5	44	30	13	119	8436 6730 34
ETC STR61-40-13-LO3	8-40	5.9-29.5	735	2.25	5	498	13	68	18	25	47	62	82	44	31	14.5	83.3	8436 6730 35
ETC STR61-50-13-LO3	13-64	10-47	530	2.6	5.7	511.5	13	86	24	27	51	66	89	48	30	15	90	8436 6730 36
ETC STR61-80-17-LO3	16-80	12-59	350	3.1	6.8	534	17	81	27	31.8	55.8	72.3	94.8	48	33	16.5	96.3	8436 6730 37

# Tensor STR Tube Nut

## IN-LINE TUBE NUT TOOLS

### Dimensions

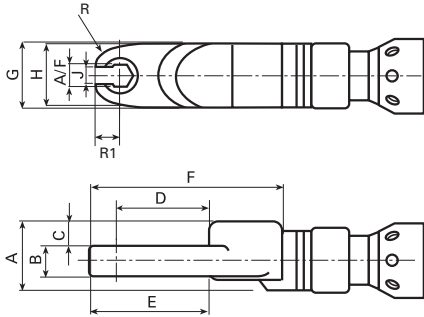

ETO STR

Model	Torque range		Speed r/min	Weight		Length mm	A/F mm	A mm	B mm	C mm	D mm	E mm	F mm	G mm	H mm	J mm	R mm	R1 mm	Ordering No.
	Nm	ft lb		kg	lb														
<b>ETO STR61</b>																			
ETO STR61-18-10-LI3	5-18	3.6-13	1421	1.8	4	522	10	34	11	14.5	34.1	31.1	81.5	35	38	8	15	11.9	8436 6730 41
ETO STR61-20-10-LI3	5-20	3.7-14.7	1421	1.9	4.2	519	10	34	14	13	31.9	29.7	78.6	35	38	8	14	11.2	8436 6730 42
ETO STR61-28-12-LI3	6-28	4.4-20.6	850	2.3	5.1	556	12	43	11	17.5	43.7	29.3	96.5	40	50	10.4	31	15	8436 6730 43
ETO STR61-30-12-LI3	6-33	4.4-24.3	856	2.3	5.1	542	12	43	18	14	34.3	31.4	83	40	40	10.4	25	12.4	8436 6730 45
ETO STR61-30-13-LI3	6-33	4.4-24.3	850	2.3	5.1	542	13	43	18	14	34.3	31.4	83	40	40	10.4	25	12.4	8436 6730 47
ETO STR61-80-19-LI3	21-80	15-59	296	4.1	9	639	19	46	18	17	53.8	38.8	137.2	64	59	17	32	20.1	8436 6730 49

## OFFSET TUBE NUT TOOLS

### Dimensions

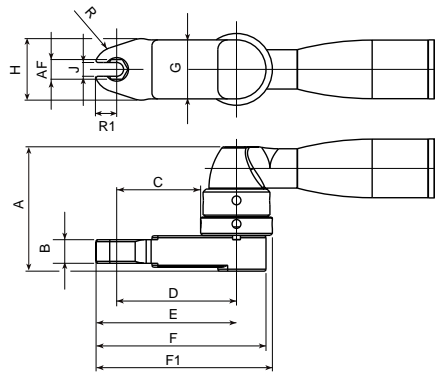

ETO STR

Model	Torque range		Speed r/min	Weight		Length mm	A/F mm	A mm	B mm	C mm	D mm	E mm	F mm	G mm	H mm	J mm	R1 mm	R mm	F1 mm	Ordering No.
	Nm	ft lb		kg	lb															
<b>ETO STR61</b>																				
ETO STR61-28-13-LO3	6-28	4.4-20.6	1220	1.9	4.2	488	13	65	11	12.8	36.8	51.8	74.3	48	50	10.4	15	31	75.8	8436 6730 44
ETO STR61-30-13-LO5	7-33	5.2-24.3	478	2.1	4.6	524	13	72.5	18	53.3	75.3	87.7	108.2	44	40	10.4	12.4	25	109.7	8436 6730 46
ETO STR61-50-17-LO5	10-50	7.3-37	345	2.8	6.2	552	17	80	18	66.8	90.8	105.8	128.3	48	50	12	15	31	129.8	8436 6730 48

## ETP SR31

The ETP SR is a pistol type electric nutrunner that delivers accurate, fast and error proof tightening with low reaction force. With TurboTight™ the ETP SR31 can handle one hand operations up to 25 Nm.

Delivers fully traceable results, has a low energy consumption and is simple to set up.

- Perfectly balanced and ergonomically designed handle.
- High free run speed (up to 2000 rpm's) and short tightening cycle (Up to 10 tightenings/min).
- Direct and robust gear box.
- The LED ring provides instant input to the operator and the incorporated speaker improve the operator feedback.
- Integrated function button, customized for your needs.



ETP SR



ETV SR



ETD SR

## ETV SR

- SR angle tools are extremely fast, compact and easy to operate.
- ESD certified.
- Easy to configure the function button.
- Front LED's gives better operator feedback.
- Torque range from 2.5 to 30 Nm.

## ETD SR

- SR straight tools are ideal for handheld applications and fixture applications.
- Torque range from 1.5 to 16 Nm.
- Front light guide is integrated.
- Push-to-start mechanism.
- ESD certified.

Model	Torque range		Speed r/min	Weight		Length mm	CS distance mm	Ordering No.
	Nm	ft lb		kg	lb			
<b>Angle models</b>								
ETV SR21-12-10	2.5-12	1.9-8.9	1350	1.1	2.4	297	14	8436 4120 12
ETV SR21-25-10	5-25	3.7-18.5	1000	1.2	2.6	297	14	8436 4120 25
ETV SR21-30-10	6-30	4.4-22.1	663	1.2	2.6	299	15.5	8436 4120 30
<b>Straight models</b>								
ETD SR21-07-I06-PS	1.5-7	1.0-5.2	2090	0.9	1.9	259	24	8436 4220 07
ETD SR21-16-I06-PS	3.5-16	2.6-11.8	1460	1.0	2.2	276	24	8436 4220 16
ETD SR21-07-I06-T25	1.5-7	1.0-5.2	2090	0.9	1.9	353	24	8436 4224 07
ETD SR21-16-10-T25	3.5-16	2.6-11.8	1460	1.0	2.2	353	24	8436 4224 17
<b>Pistol grip models<sup>a</sup></b>								
ETP SR31-25-I06	5-25	3.7-18.4	2010	0.85	1.8	210	19.5	8436 4300 21
ETP SR31-25-10	5-25	3.7-18.4	2010	0.85	1.8	210	19.5	8436 4300 20

<sup>a</sup> Pistol grip models works only with Power Focus 6000.



## Optional Accessories

### TENSOR ST/SR/STR

Model	Power Focus 4000 Ordering No.	Power Focus 6000 Ordering No.
<b>Tool cable</b>		
2 m	4220 2636 02	4220 4375 02
3 m	4220 2636 03	4220 4375 03
5 m	4220 2636 05	4220 4375 05
7 m	4220 2636 07	4220 4375 07
10 m	4220 2636 10	4220 4375 10
15 m	4220 2636 15	4220 4375 15
<b>Cables with 90 degrees connector</b>		
2 m	4220 3891 02	4220 5199 02
3 m	4220 3891 03	4220 5199 03
5 m	4220 3891 05	4220 5199 05
7 m	4220 3891 07	4220 5199 07
10 m	4220 3891 10	4220 5199 10
15 m	4220 3891 15	4220 5199 15
<b>Spiral cable (length/stretched length)</b>		
3 m / 4 m	4220 2757 03	4220 4365 03
7 m / 8 m	4220 2757 07	4220 4365 07
10 m / 12 m	4220 2757 10	4220 4365 10
<b>Cable protection 2 m</b>	4220 2977 90	
<b>Extension cable</b>		
3 m		4220 4393 03
5 m	4220 1007 05	4220 4393 05
10 m	4220 1007 10	4220 4393 10
15 m	4220 1007 15	4220 4393 15
<b>Flat extension cables</b>		
5 m	4220 1563 05	
10 m	4220 1563 10	
15 m	4220 1563 15	



ST/SR/STR Cable



ST/SR/STR Cable with 90 degrees connector



ST/SR/STR Spiral cable



ST/SR/STR Cable protection

### TENSOR ES

Model	Ordering No.
<b>Round cables for ES21</b>	
2 m	4220 4204 02
3 m	4220 4204 03
5 m	4220 4204 05
7 m	4220 4204 07
10 m	4220 4204 10
15 m	4220 4204 15
<b>Flat cables for ES61</b>	
3 m	4220 4339 03
5 m	4220 4339 05
7 m	4220 4339 07
10 m	4220 4339 10
15 m	4220 4339 15
<b>Extension cables for all cables</b>	
3 m	4220 4393 03
5 m	4220 4393 05
10 m	4220 4393 10
15 m	4220 4393 15
<b>Suspension yoke cable for ES21</b>	
Suspension yoke cable	4210 1810 00

## Optional Accessories



### TOOL EXTENSIONS

Model	Length	Ordering No.
ES61 ETV 70/100/150/180/200, ES61 ETD 50/70/90/120	150	4220 1132 80
ES61 ETV 25/30/40/50, ES61 ETD 18/25/30	150	4220 1131 80
ST61 ETV 20-30	150	4220 2903 96
ST61 ETV 40-50	150	4220 2903 95
ST61 ETV 70	150	4220 2903 97
ST61/ST81/ST101 ETV 100-200	150	4220 2903 91
ST101 270-1000	150	4220 1585 80
ST101 600	150	4220 1585 85
STR61 ETV 25	150	4220 2903 80
STR61 ETV 30	150	4220 2903 96
STR61 ETV 40-50	150	4220 2903 95
STR61 ETV 70	150	4220 2903 97
STR61 ETV 100-200	150	4220 2903 91

**NOTE:** All ETV ST tool extensions can also be used with equivalent ETV STB tools.



### SUPPORTED EXTENSIONS (~154 MM)

Tensor ES	Tensor ST/SR	Tensor STR	Ordering No.
ES61 ETV 25/30	SR21, ST31 ETV 20, ST61 28-30	STR61 ETV 30	4220 3869 90
ES61 ETV 40/50	ST61/ST81 ETV 40-50	STR31 ETV 20, STR61 ETV 25	4220 3868 90
ES61 ETV 70	ST61/ST81 ETV 70	STR61 ETV 40-50	4220 2209 91
	ST61/81/101 ETV 150-180	STR61 ETV 70	4220 2596 91
	ST61 ETV 200	STR61 ETV 150-180	4220 4125 90
ES61 ETV 100	ST81/101 ETV 200	STR61 ETV 200	4220 4125 92



### COVERS FOR STANDARD SOCKETS

Tensor ES	Tensor ST	Tensor SR	Tensor STR	Ordering No.
ES61 ETD 18/ 25/ 30	ST31 ETV 20	SR21	STR31 ETV 20	4220 3154 03
ES61 ETD 50/70/90/120				4220 3251 02
ES61 ETV 25	ST61 ETV 28		STR61 ETV 25	4220 3154 03
ES61 ETV 30	ST61 ETV 30		STR61 ETV 30	4220 3154 04
ES61 ETV 100	ST ETV 100		STR61 ETV 100	4220 3154 05
ES61 ETV 150/180	ST ETV 150-180		STR61 ETV 150-180	4220 3154 06
ES61 ETV 40/50	ST ETV 40-50		STR61 ETV 40-50	4220 1995 05
ES61 ETV 70	ST ETV 70		STR61 ETV 70	4220 1993 03
ES61 ETV 200	ST ETV 61/81/101 200		STR61 ETV 200	4220 3154 07
	ST101 ETV 270-370			4220 3154 08
	ST61/81 ETD 50-120			4220 3251 00
	ST61 ETD 15/20/30			4220 3251 02

## Optional Accessories

### REACTION PLATE FOR FIXTURING

Model	Ordering No.
ES61 ETV-40/50	4220 1677 92
ES61 ETV-70/100	4220 1678 94
ES61 ETV-150/180	4220 1677 98
ES61 ETV-200	Included
ST10 ETV 180	4220 1677 99
ST10 ETV 200-600	Included
ST61 ETV 30, ST61/81 ETV 200	4220 1677 91
ST61 ETV 40-50	4220 1677 93
ST61/81 ETV 70	4220 1677 95
ST61/81 ETV 100	4220 1677 97
ST61/81 ETV 150-180	4220 1678 90
ST32 ETP 20 106BCR	4220 3491 00
STR31 ETV 5-20	4220 1678 91
STR61 ETV 30	4220 1677 91
STR61 ETV 40-50	4220 1677 93
STR61 ETV 70	4220 1679 84
STR61 ETV 100	4220 1677 97
STR61 ETV 150-180	4220 1678 90



Reaction plate

### LEVER TENSOR ST / SR

Model	Ordering No.
Lever, ST	4220 3511 81
Spoon lever, SR21	4220 4338 83
Extended lever, ST	4220 3511 85
Lock-off lever, STR	4220 5221 85
Lock-off lever, ST	4220 3511 83



Lock-off lever

### REACTION BARS AND MOUNTING BRACKETS

Number	Spline type	Type	L / W / H	Ordering No.
1	-	Bracket	100/60/8	4220 1029 00
2	Spline type 2	Bracket	70/41/14	4210 2134 02
3	-	Triangular	73/72/14	4220 2137 02
4	-	Bar	270/35/14	4220 1903 00
5	Spline type 3	Bracket	100/50/12	4210 2219 03
6	-	Triangular	82/80/12	4220 2137 03
7	-	Bar	400/29/12	4210 2219 80
8	Spline type 6	Bracket	200/100/15	4220 1200 00
9	-	Triangular	112/109/15	4220 2137 06
10	-	Bar	560/80/15	4220 1200 01
11	Spline type 7	Bracket	250/150/20	4220 1445 00
12	Spline type 8	Bracket	250/160/20	4220 1972 00
13	-	Bracket	100/60/8	4220 1029 01
14	-	Bracket	100/60/8	4220 1029 02

#### For model

ST10 ETD 120	Bracket	150/100/16	4220 3677 00
ST10 ETD 200/300/500	Bracket	200/150/16	4220 3677 01
ST10 ETD 750/1000	Bracket	200/150/20	4220 3677 02
STR61 ETP 20/30	Bar	250/15/8	4220 4495 00
STR61 ETP 50/70/90/120,	Bar	270/35/14	4220 1903 00
ES61 ETD 18/25/30	-	-	-
ES61 ETD 50/70/90/120	Bar	-	4210 2219 80
ST101 ETP 1300 HA	Square bracket	-	4210 4758 90
ST101 ETP 2600 HA	Square bracket	-	4210 4758 93
ST101 ETP 4100 HA	Square bracket	-	4210 4758 91
ST101 ETP 5800/8100 HA	Square bracket	-	4210 4758 92
ST101 ETP 1300 HA	Sliding drive	-	4210 4752 90
ST101 ETP 2600 HA	Sliding drive	-	4210 4752 93
ST101 ETP 4100 HA	Sliding drive	-	4210 4752 91
ST101 ETP 5800/8100 HA	Sliding drive	-	4210 4752 92
ST101 ETP 1300 HA	Reaction bar, S-type	-	4210 4480 90
ST101 ETP 2600 HA	Reaction bar, S-type	-	4210 4480 94
ST101 ETP 4100 HA	Reaction bar, S-type	-	4210 4480 93
ST101 ETP 5800/8100 HA	Reaction bar, S-type	-	4210 4480 92
ST101 ETP 1300 HA	Reaction bar, steel bar	-	4210 4757 90
ST101 ETP 2600 HA	Reaction bar, steel bar	-	4210 4757 93
ST101 ETP 4100 HA	Reaction bar, steel bar	-	4210 4757 91
ST101 ETP 5800/8100 HA	Reaction bar, steel bar	-	4210 4757 92

Mounting bracket is included for some tool models.

Please match the number from the table with the tool tables.



Reaction bar



Mounting bracket



Triangular



Reaction bar, S-type



Reaction bar, sliding-drive



Reaction bar, steel bar



Reaction bar, square bracket

**Optional Accessories**

**SUSPENSION YOKES**

Model	Type	Assembly	Ordering No.
ES21 ETV/ETD	Horizontal	Motor	4220 0987 82
ES61 ETV/ETD	Horizontal	Motor	4220 4586 90
ST10 ETD 120-300, ST10 ETV 270-600	Vertical	Planetary gear	4220 1418 91
ST10 ETD 500-1000	Vertical	Planetary gear	4220 1418 90
ST10 ETV 100-200	Vertical	Planetary gear	4220 1418 92
ST31/61 ETV/ETD	Horizontal	Motor	4220 2657 90
ST31/61 ETV/ETD	Fixed	Motor	4220 2843 92
ST31/61 ETV/ETD	Vertical	Handle	4220 1417 95
ST81 ETV/ETD	Horizontal	Motor	4220 0987 90
ST81 ETV/ETD	Fixed	Motor	4220 2843 91
ST101 <sup>a</sup> ETV	Horizontal	Motor	4220 3930 90
ST101 ETP 200-1000	Adjustable	Motor	4220 4075 90
ST101 ETP BCR 200-1000 <sup>b</sup>	Adjustable	Motor	4220 4075 91
ST101 ETP 750-2000	Swivelling	Gear	4210 3088 87
ST101 ETP 3000-4000/4100 HA	Swivelling	Gear	4210 3088 81
ST101 ETP 1300 HA	Swivelling	Gear	4210 3088 83
ST101 ETP 2600 HA	Swivelling	Gear	4210 3088 82
ST101 ETP 5800/8100 HA	Swivelling	Gear	4210 4780 90
STR ETV/ETD 31/61	Swivelling		4220 5070 80
STR ETV/ETD 31/61	Fixed		4220 5105 80
STR61 ETP	Tool upside down		4220 3037 00
STR61 ETP	Fixed, one side		4220 4334 00
STR61 ETP	Fixed, both sides		4220 4399 80
STR61 ETP 20/30/50	Swivelling		4220 4381 80
STR61 ETP 70/90/120	Swivelling		4220 4394 80
SR21	For rear		4220 4410 80
SR21	For front		4220 4409 80

<sup>a</sup> Not telescopic. <sup>b</sup> To be used if barcode scanner is mounted.



Suspension yokes

**FIXTURED EXTENSIONS**

Model	For ext + nut Ordering No.	For nut only Ordering No.
ES61 ETV 25/30/40/50, ES61 ETD 18/25/30		4220 2579 90
ES61 ETV 70/100/150/180/200, ES61 ETD 50/70/90/120		4220 2469 90
ST10 ETV 100/150/180, ST10 ETD 120	4220 3571 90	Included
ST10 ETD 150, 200, 300	4220 3572 90	
ST10 ETD 500	4220 3573 90	Included



Fixture extension

**PROTECTIVE COVERS**

Model	Ordering No.
ST31 ETV 5-15	4220 2744 05
ST31/ST61 ETV 20-30	4220 2744 03
ST61 ETV 40-50, ST81 ETV 50	4220 2744 02
ST61 ETV 70, ST81 ETV 70	4220 2744 04
ST31 ETP 05	4220 2744 06
ST31 ETP 10	4220 2744 07
ST81/ST10 ETV 150-180	4220 2744 10
ST81/ST10 ETV 100	4220 2744 09
ST101 ETP (included)	4220 4299 00
STR31 ETV 05-15	4220 2744 05
STR31 ETV 20, STR61 ETV 20-30	4220 2744 03
STR61 ETV 40-50	4220 2744 02
STR61 ETV 70	4220 2744 04
STR61 ETV 100	4220 2744 09
STR61 ETV 150-180	4220 2744 10



Protective cover Tensor ST

**TELESCOPIC FRONT PART**

Model	mm	Ordering No.
ST101 ETP 200	25	4220 4592 80
ST101 ETP 500	40	4210 3781 81
ST101 ETP 750/1000	50	4210 3788 80
ST101 ETP 1500	50	4210 3788 81

## Optional Accessories

### OPERATOR HANDLE

Model	Ordering No.
STR61 ETP	4220 4487 80
ST101 ETP	4220 4522 82



Operator handle

### SUPPORT HANDLE

Model	Ordering No.
ES21 ETV/ETD	4220 2725 83
SR21 ETD	4220 4347 80
ST31/32 ETP 5-10	4220 3517 80
ST101 ETP 200/500 (included)	4220 4001 84
ST101 ETP 750/1000 (included)	4220 4001 83
STR61 ETP	4220 4343 80



Support handle

### TORQUE MULTIPLIER (REACTION BAR INCLUDED)

Model	Max. torque Nm	Gear ratio	Square in	Square out	Ordering No.
T-Mult 120	30	4.54	3/8	1/2	8431 0453 53
T-Mult 200	50	4.62	3/8	3/4	8433 0310 07
T-Mult 400	100	4.10	1/2	3/4	8431 0493 65
T-Mult 500	30	16.11	3/8	3/4	8433 0310 28
T-Mult 800	45	18.50	1/2	1	8433 0311 81
T-Mult 1000	250	4.00	3/4	1	8433 0312 16
T-Mult 1500	72	21.10	1/2	1	8433 0312 20



Tool holder

### TOOL HOLDER

Model	Ordering No.
ST32 ETP	4220 3584 80

### OPTIONAL ACCESSORIES FOR TENSOR ST

Model	ETV	ETD	Ordering No.
<b>Dual trigger for open end</b>			
ST61-S	ST31, ST61 05-50	ST31, ST61 15-30	4220 3186 90
ST61-L	ST61 70-200	ST61 50-120	4220 3186 91
ST81-S	ST81 50	ST81 30	4220 3186 92
ST81-L	ST81 70-180	ST81 50-120	4220 3186 93
ST101	ST10 100-1000	ST10 100-1000	4220 3186 96
<b>Dual trigger for open end 135 deg.</b>			
ST61-S	ST31, ST61 28-50	ST31, ST61 15-30	4220 3311 90
ST61-L	ST61 70-200	ST61 50-120	4220 3311 91
ST81-S	ST81 50	ST81 30	4220 3311 92
ST81-L	ST81 70-200	ST81 50-120	4220 3311 93
ST101	ST10 100-1000	ST10 100-1000	4220 3311 94
<b>Front button</b>			
ST61-S	ST31, ST61 28-50	ST31, ST61 15-30	4220 3184 90
ST61-L	ST61 70-200	ST61 50-120	4220 3184 91
ST81-S	ST81 50	ST81 30	4220 3184 92
ST81-L	ST81 70-200	ST81 50-120	4220 3184 93
ST101	ST10	ST10	4220 3184 94
<b>Adjustable headlights</b>			
ST61-S	ST31, ST61 28-50	ST31, ST61 15-30	4220 3292 94
ST61-L	ST61 70-200	ST61 50-120	4220 3292 95
ST81-S	ST81 50	ST81 30	4220 3292 96
ST81-L	ST81 70-100	ST81 50-120	4220 3292 97
ST101	ST10	-	4220 3292 98



Front button



Adjustable headlights



Lever trigger top



Lever trigger 135 deg.



## Optional Accessories

### ***EHMI FOR TENSOR STR***

Model	Ordering No.
Fits all STR ETV and ETD	8436 6199 70



*EHMI*

### ***OPTIONAL ACCESSORIES FOR TENSOR STR***

**Small (S)** ETV STR <50 Nm, ETD STR <30 Nm. **Large (L)** ETV STR >70 Nm, ETD STR >50 Nm.

Accessory	Position/Size	Ordering No.
Dual trigger for open end	Top	
	S	8436 6199 10
	L	8436 6199 12
Dual trigger for open end 135°	Lower	
	S	8436 6199 20
	L	8436 6199 22
Front button	Top	
	S	8436 6199 30
	L	8436 6199 32
Adjustable headlights	Lower	
	S	8436 6199 40
	L	8436 6199 42
Barcode scanner	Top	
	S	8436 6199 00
	L	8436 6199 02
Scanner 2D and tag U D4, 2-in-1	Top	
	S	8433 5050 10
	L	8433 5050 11
Mounting rings	Top	
	S	8436 6199 50
	L	8436 6199 52
Mounting rings	Lower	
	S	8436 6199 60
	L	8436 6199 62



*Dual trigger for open end*



*Dual trigger for open end 135°*



*Front button, top*



*Adjustable headlights*



*Barcode scanner, top*



*Scanner 2D and tag U D4, 2-in-1*



*Mounting rings, top*



*Mounting rings, lower*

### *Examples of configurations*



## Optional Accessories

### BARCODE SCANNER



**CAUTION:** This device emits CDRH/IEC Class 2 laser radiation. Do not stare into beam.

Model	ETV	ETD	Ordering No.
ST61-S	ST31, ST61 28-50	ST31, ST61 15-30	8433 0615 10
ST61-L	ST61 70-200	ST61 50-120	8433 0615 20
ST81-S	ST81 50	ST81 30	8433 0615 30
ST81-L	ST81 70-200	ST81 50-120	8433 0615 40
STR61 ETP			8436 0999 90
ST101 ETP			8433 0615 50
STR-S	STR 31 /61	STR 31 /61	8436 6199 00
STR-L	STR61	STR61	8436 6199 02

L= 70 Nm and up, S= up to 50 Nm



Barcode scanner

### PARAMETER SET SELECTOR

Model	ETV	ETD	Ordering No.
ST61-S	ST31, ST61 28-50	ST31, ST61 15-30	8433 0616 05
ST61-L	ST61 70-200	ST61 50-120	8433 0616 15
ST81-S	ST81 50	ST81 30	8433 0616 25
ST81-L	ST81 70-200	ST81 50-120	8433 0616 35
ST101	ST10	ST10	8433 0616 45
STR61 ETP			8436 0999 91



Parameter set selector

### I/O DEVICE MODULE

Model	ETV	ETD	Ordering No.
ST61-S	ST31, ST61 28-50	ST31, ST61 15-30	8433 0617 12
ST61-L	ST61 70-200	ST61 50-120	8433 0617 22
ST81-S	ST81 50	ST81 30	8433 0617 32
ST81-L	ST81 70-200	ST81 50-120	8433 0617 42
ST101	ST10	ST10	8433 0617 52



I/O device module

### PROTECTION

Model	Ordering No.
Scanner protection ST61-S >50, ST31/ST32	4220 2762 10
Selector protection	4220 2917 06
I/O device protection	4220 2917 06
TLS ST tag protection	4220 2917 06



Scanner and TLS ST tag protection

Optional Accessories

REACTION BARS

Spline dia mm	Center to tip length / Tip width / Bar thickness mm		Ordering No.
<b>Steel bar</b>			
Spline 1	268/36/18		4210 1798 01
Spline 2	270/35/10		4220 1903 00
Spline 3	400/56/12		4210 2219 80
Spline 4	500/62/15		4210 2183 80
Spline 5	500/62/15		4210 2726 80
Spline 6	560/80/15		4220 1200 01
Spline 7	500/100/20		4210 3899 02
Spline 8	500/150/20		4210 3899 03
Spline 9	500/85/20		4210 3899 80
Ø 26 mm	270/34/8		4220 3491 00
<b>Square steel bracket</b>			
Spline 3	100/50/12		4210 2219 03
Spline 4	125/65/16		4210 2183 01
Spline 5	125/65/16		4210 2726 01
Spline 6	200/100/15		4220 1200 00
Spline 7	250/150/20		4220 1445 00
Spline 8	250/160/20		4220 1972 91
Spline 9	150/85/20		4210 3899 01
Ø 24 mm	100/60/8		4220 1029 00
Ø 26 mm	100/60/8		4220 1029 02
Ø 28 mm	100/60/8		4220 1029 01
<b>Triangular steel bracket</b>			
Spline 2	73/72/14		4220 2137 02
Spline 3	82/80/15		4220 2137 03
Spline 6	112/109/15		4220 2137 06
Spline 6	150/145/20		4220 2137 16
<b>S-Type reaction bar</b>			
Spline 2	104/13.5/15		4220 1903 02
Spline 3	110/18/12		4210 4480 03
Spline 4	120/22/15		4210 4480 04
Spline 5	130/25/15		4210 4480 05
Spline 6	125/25/15		4210 4480 06
Spline 7	170/40/20		4210 4480 07
Spline 8	200/65/20		4210 4480 08
Spline 9	160/40/20		4210 4480 09
<b>L-Type aluminum bar</b>			
Spline 3	266x300/29/15		4210 2219 08
Spline 4	144x150/42/15		4210 2183 08
<b>Bracket stepped</b>			
Spline 1	70/36/13		4210 1798 02
Spline 2	70/41/14		4210 2134 02
<b>Straight aluminum bar</b>			
Spline 3	L = 400		4210 2219 01
Spline dia mm	Square drive in	CC distance mm	Ordering No.
<b>Sliding drive reaction bar</b>			
Spline 2	1/2	93-148	4210 4481 82
Spline 3	1/2	70-120	4210 4481 83
Spline 3	3/4	70-120	4210 4481 63
Spline 3	1/2	82-218	4210 4616 83
Spline 3	3/4	82-218	4210 4616 63
Spline 4	3/4	76-126	4210 4481 84
Spline 4	3/4	82-218	4210 4616 84
Spline 5	1	80-125	4210 4481 85
Spline 5	1	82-218	4210 4616 85
Spline 6	3/4	120-170	4210 4481 86
Spline 9	1	80-130	4210 4481 89
Spline 9	1	80-280	4210 4616 89
<b>Extended sliding drive reaction bar</b>			
Spline 5	1	68-112	4210 4498 80
<b>Sliding tube reaction bar</b>			
Spline 2	1/2	93-148	4211 4481 82
<b>Extended sliding tube reaction bar</b>			
Spline 5	1	68-112	4210 4498 82

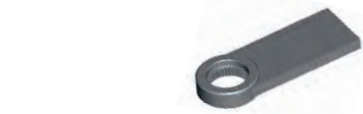

Steel bar

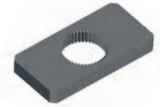

Square steel bracket



Triangular steel bracket



S-Type reaction bar



L-Type aluminum bar



Bracket stepped



Straight aluminum bar



Sliding drive reaction bar



Extended sliding drive reaction bar



Extended sliding tube reaction bar

Optional Accessories for Hold and Drive tools

NUT SOCKET, SCREW HOLDER AND BIT HOLDER FOR ETV ST61/81-100-HAD

Nut socket (Fig. 2)

Width across flats W mm	Socket Ø D mm	A	Ordering No. B	C
13	21	4220 4477 13	4220 4477 33	4220 4477 53
14	22	4220 4477 14	4220 4477 34	4220 4477 54
15	23	4220 4477 15	4220 4477 35	4220 4477 55
16	24	4220 4477 16	4220 4477 36	4220 4477 56
17	27	4220 4477 17	4220 4477 37	4220 4477 57
18	27	4220 4477 18	4220 4477 38	4220 4477 58
19	29	4220 4477 19	4220 4477 39	4220 4477 59
21	30	4220 4477 21	4220 4477 41	4220 4477 61
22	32	4220 4477 22	4220 4477 42	4220 4477 62
24	34	4220 4477 24	4220 4477 44	4220 4477 64

Measurements in mm

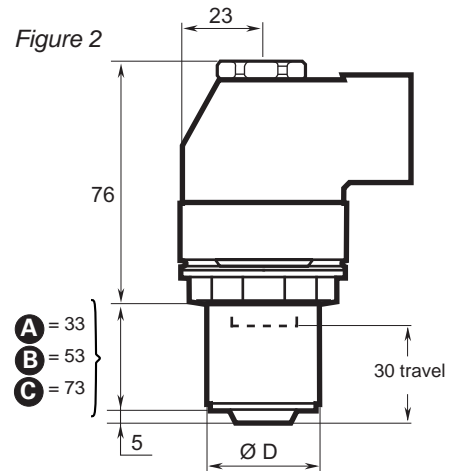

Screw holder – Two flats

Dimension X x Y mm	Suitable socket size mm	A 33 mm	Ordering No. B 53 mm	C 73 mm
7x5	13-24	4220 4524 05	4220 4524 15	4220 4524 25
8x6	13-24	4220 4524 06	4220 4524 16	4220 4524 26
8x6.3	13-24	4220 4524 07	4220 4524 17	4220 4524 27
9.55x7.6	14-24	4220 4524 08	4220 4524 18	4220 4524 28
11.20x8.9	16-24	4220 4524 09	4220 4524 19	4220 4524 29
13x9.8	16-24	4220 4524 10	4220 4524 20	4220 4524 30

Two flats

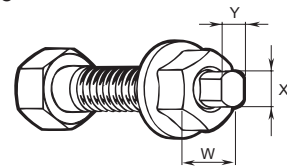

Screw holder – Male hexagon

Dimension N mm	Suitable socket size mm	A 33 mm	Ordering No. B 53 mm	C 73 mm
5	13-24	4220 4478 15	4220 4478 25	4220 4478 45
6	13-24	4220 4478 16	4220 4478 26	4220 4478 46
7	13-24	4220 4478 07	4220 4478 27	4220 4478 47
8	13-24	4220 4478 08	4220 4478 28	4220 4478 48
9	14-24	4220 4478 09	4220 4478 29	4220 4478 49
10	16-24	4220 4478 10	4220 4478 30	4220 4478 50
11	16-24	4220 4478 11	4220 4478 31	4220 4478 51

Male hexagon

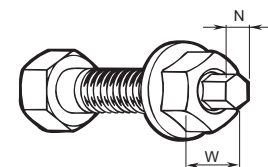

Bit holder 1/4" – Female hexagon

Suitable socket size mm	A 33 mm	Ordering No. B 53 mm	C 73 mm
13-24	4220 4524 60	4220 4524 61	4220 4524 62

Female hexagon

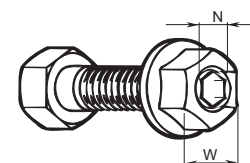

**Optional Accessories for Flush socket tools**

**INTEGRATED SOCKETS**

Model	Hexagon socket size AF mm / in	Socket extension mm	Ordering No.
<b>ETV ES/ST/STR 61-30-FS</b>			
	8	1.5	4220 4188 88
	10	1.5	4220 4188 90
	12	1.5	4220 4188 92
	13	1.5	4220 4188 93
	1/4	1.5	4220 4188 96
	5/16	1.5	4220 4188 98
<b>ETV ES/ST/STR 61-40-FS, ETV ES/ST/STR 61-50-FS</b>			
	10	2.5	4220 3987 90
	12	2.5	4220 3987 92
	13	2.5	4220 3987 93
	13	7	4220 4012 93
	13	15	4220 4013 93
	14	2.5	4220 3987 94
	14	15	4220 4013 94
	15	2.5	4220 3987 95
	16	2.5	4220 3987 96
	17	2.5	4220 3987 97
	18	2.5	4220 3987 98
	9/16	2.5	4220 3987 99
<b>ETV ES/ST/STR 61-70-FS</b>			
	10	3.5	4220 1621 04
	12	3.5	4210 2749 03
	13	3.5	4210 2749 01
	14	3.5	4210 2749 04
	15	1.5	4220 1621 01
	15	3.5	4210 2749 02
	15	16.5	4220 1621 00
	16	0.5	4220 1251 00
	16	11.5	4220 1621 03
	16	14.5	4220 1621 10
	16	16.5	4220 1621 08
	17	11.5	4220 1621 12
	17.5	6.5	4220 1621 06
	18	6.5	4220 1621 02
	18	10.5	4220 1621 09
	19	8.5	4220 1621 07
	19	10	4220 1621 11
	20	8.5	4220 1621 05
	7/16	3.5	4210 2749 06
	9/16	3.5	4210 2749 05
<b>ETV ES/ST/STR 61 100/150/180/200 FS</b>			
	18	4.5	4220 1595 02
	18	14.5	4220 1595 04
	14	5.5	4220 1595 07
	14.3	9	4220 1595 08
	17.5	7.5	4220 1595 09
	18	2	4210 3534 68
	18	8.5	4210 3534 18
	19	9.5	4210 3534 19
	21	10.5	4210 3534 21
	21	13.5	4220 1595 05
	21	24	4220 1595 06
	22	10.5	4210 3534 22
	24	10.5	4210 3534 24
	24	12.5	4220 1595 01
	25.4	13.5	4220 1595 03
	27	13.8	4210 3534 27

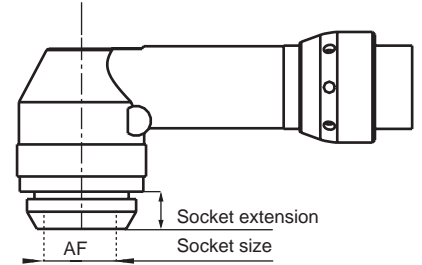



# Controllers and systems

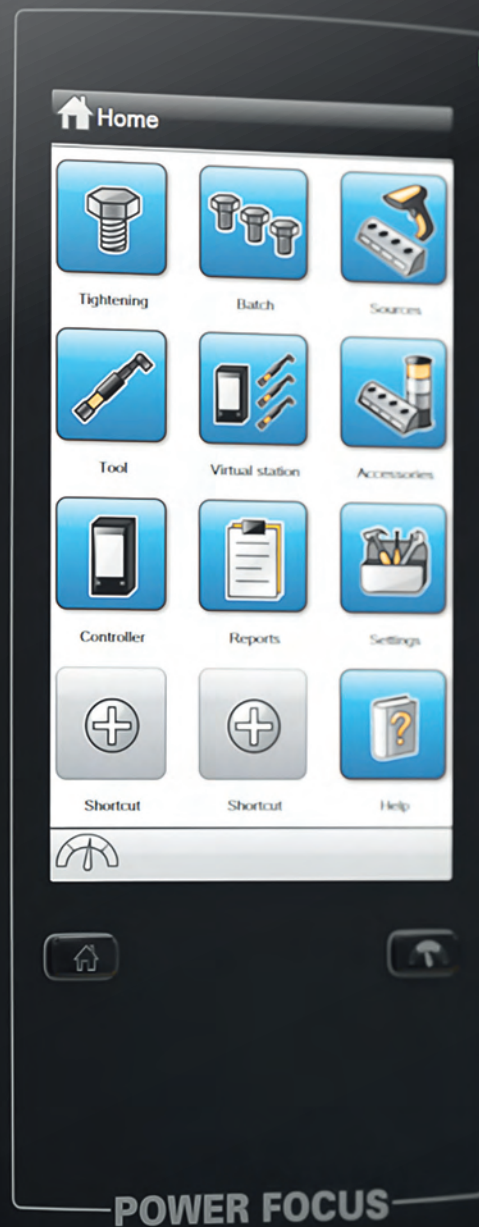

## Contents

Introduction.....	121	Quality Integrated Fastening ....	126
Controllers and systems		Station hardware .....	128
Power Focus 6000 .....	122	Station software .....	129
Power Focus 600 .....	124	Error proofing solutions .....	131
Software ToolsTalk .....	125		

# Error-proofing through intuitive control of the assembly process

*Atlas Copco advanced controllers and software provide intuitive monitoring and control of tightening operations performed using Atlas Copco electric assembly tools. Assembly process control and quality assurance is made easy by advanced control functions. The system guides the operator through the assembly process, avoiding mistakes that can result in costly quality problems.*

### **POWER FOCUS 6000**

The Power Focus 6000 comes in two hardware versions: Power Focus 6000 and Power Focus 6000 LV.

The Power Focus 6000 is easy to use due to its 7 inch touch screen and intuitive software. The web HMI enables you to configure and monitor the controller from any device with a web browser. Smart software management will guarantee highest possible uptime. Upgrade your controller in a few seconds using only a USB stick.

The Power Focus is based on standard hardware and software components which, when combined, will fulfill all demands, from the most basic stand-alone installation to full integration into the factory network. The modules fit together using the “plug-and-play” concept.

Assembly process control and quality assurance is made easy by advanced control functions. On receipt of assembly information, the Power Focus automatically selects the correct tightening sequence and parameters. The operator is guided through the process, avoiding mistakes that can result in costly quality problems.

### **PROGRAMMING SOFTWARE TOOLS-TALK 2**

ToolsTalk 2 is the user-friendly tool that enables you to communicate with your Power Focus tool controller. It makes programming and process analysis of a tightening station simple.

### **POWER FOCUS 600**

The Power Focus 600 is compatible with the Tensor ES tools and is the perfect choice for quality critical assembly. It comes in one single hardware version regardless of which tool model or functionality level is used. Its powerful industrial design gives a reliable process that will speed up your tightening operations.

Thanks to the intuitive interface and the fact that it's so easy to use you can set up and run a new system from the box in minutes. External computer software is no longer required since you can browse in using a web HMI. The intuitive interface and color screen provide clear operator feedback.

Smart software management will guarantee highest possible uptime. Upgrade your controller in a few seconds using only a USB stick.

### **MT FOCUS**

The new ground-breaking controller MT Focus 6000 is designed for Industry 4.0 and is Atlas Copco's most innovative controller for MicroTorque. The MT Focus 6000 elevates Atlas Copco's low torque tightening offer with advanced tightening strategies, a wide range of communication possibilities and smart solutions for high efficiency in any tightening process. For more information about MicroTorque controllers see chapter Electric Assembly Tools.



## POWER FOCUS 6000

This all new fastening solution from Atlas Copco takes productivity, ergonomics, quality and environmental impact to entirely new levels. And all this with the most user-friendly experience ever.

Enjoy the benefits of a system providing a unique operator experience, with superior quality control and the most flexible integration.

## ONE PLATFORM

One platform for handheld and fixtured tools. The Power Focus 6000 reduces your inventory costs and training requirements.

Easy to connect and configure back up tools, using the same programming interface. More compatible solutions will continuously be deployed. And the Power Focus 6000 will be your common controller for all tools and needs.

## MULTITOOL CONTROLLER

The Power Focus 6000 increases your flexibility in rebalancing assembly lines. Atlas Copco's virtual stations concept allows you to connect up to 6 tools to the same controller. Giving you a simpler installation with less cables, hardware components and network drops. Add to that the lower power consumption, less floor space utilization and a much lower environmental footprint, the benefits are obvious.

- Compatible with: Tensor STR, ST, STB, SR, ES, STwrench and QST.
- Connect up to 6 tools to the same controller with Virtual Stations
- Simpler installation with less cables, hardware components and network drops.
- Lower power consumption.
- Less floor space utilization.

## IAM

Virtual stations, software, tightening data and configuration – all in one place. In the IAM two software areas allow for smart software management. Allowing a much safer upgrade process, always giving the possibility to switch between two software versions.



Power Focus 6000

Model	Ordering No.
<b>Drive unit</b>	
Power Focus 6000	8436 1800 02
Power Focus 6000 LV	8436 1800 11
<b>IAMs</b>	
Critical control	8436 0910 10
Process control	8436 0910 40
<b>Software Features Electronic Delivery</b>	
Virtual Station, 1 pcs	8436 1900 01
TurboTight, 1 pcs	8436 1910 02
TrueAngle, 1 pcs	8436 1910 03
SoftPLC, 1 pcs	8436 1910 04
Yield, 1 pcs	8436 1910 06
Gradient, 1 pcs	8436 1910 07
<b>Software Features Physical Goods Delivery</b>	
Virtual Station, 1 pcs	8436 1900 11
TurboTight, 1 pcs	8436 1910 21
TrueAngle, 1 pcs	8436 1910 31
SoftPLC, 1 pcs	8436 1910 41
Yield, 1 pcs	8436 1910 61
Gradient, 1 pcs	8436 1910 71
<b>Fieldbus modules</b>	
DeviceNet	8436 0940 10
Ethernet/IP 2 port	8436 0940 15
ProfiNet I/O 2 port	8436 0940 20
ProfiBus	8436 0940 05
<b>Controller accessories</b>	
FMS Portable	8436 1910 99
Power Focus 6000 Adapter plate	4222 1783 80
Power Focus 6000 Security seal	4222 1736 03



## REVOLUTIONARY TIGHTENING STRATEGIES

TurboTight® and TrueAngle® are Atlas Copco's cutting-edge tightening strategies for the Power Focus 6000.

### TURBOTIGHT®

TurboTight® lets the tool absorb the reaction force and significantly improves ergonomics for the operator. Shorten cycle times and at the same time improving flexibility. Less hardware means less maintenance.

### TRUEANGLE®

TrueAngle® uses a gyro signal to read operator movement, increasing the accuracy of your angle reading. Enabling handheld angle controlled tightening's while removing operator influence. This allows you to narrow down your angle window, and detect the most common assembly problems such as wrong or missing components and damaged threads. Avoid premature shut-offs and detect re-hits.

### VIRTUAL STATIONS - THE ENABLER

Virtual Station is the Power Focus 6000 concept that offers the possibility to connect multiple tools and accessories into the system. With the Virtual Station concept, each tool can have its own separate result view on the Power Focus 6000 controller HMI.

The Virtual Station keeps all information about the assembly process, giving an instant overview of what is going on in the production.

TurboTight®



TrueAngle®

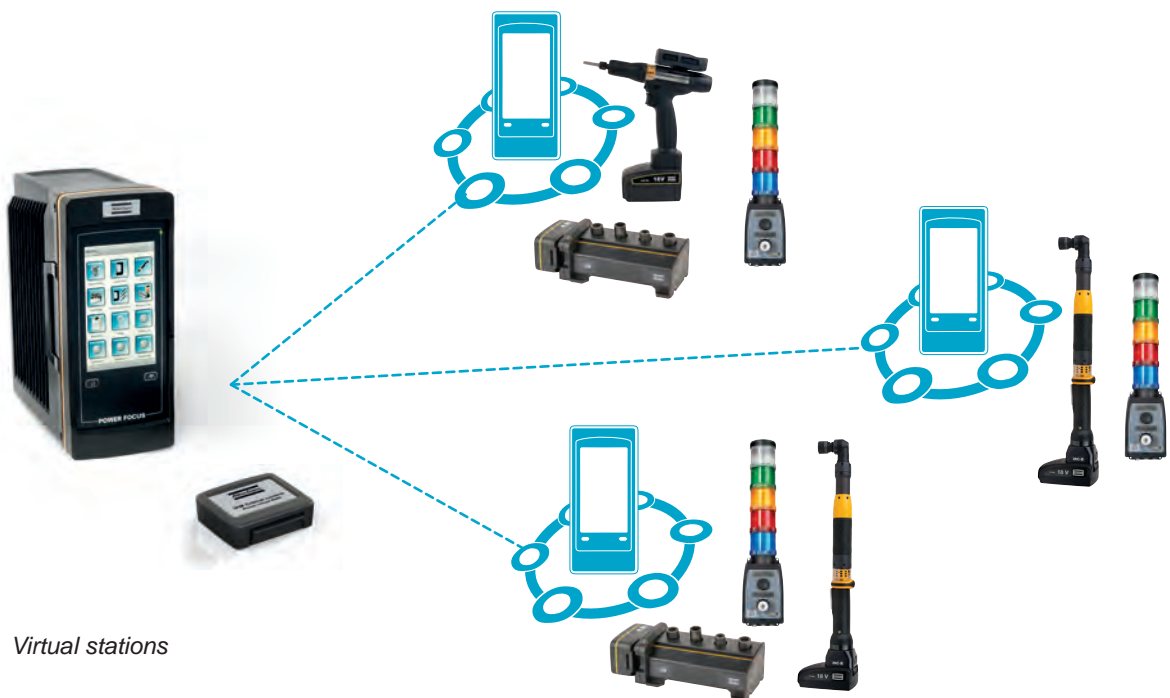

Virtual stations

## POWER FOCUS 600

The Power Focus 600 controller takes quality critical assembly to the next level. Setting up and using an electric system has never been easier. And, by switching from pneumatic tools, you can reduce your energy consumption by up to 85%. Unbelievable but true – we call it easy transformation!

### EASY

Set up and run a new system from the box in minutes. Computer software is no longer required. Intuitive interfaces enable real-time analysis and fast reaction if needed.

### EFFICIENT

Same controller hardware regardless of tool model. Powerful industrial design gives a reliable process to maximize uptime and speed up your tightening operations.

### ERGONOMIC

Both hardware and software is intuitive, giving clear operator feedback on the screen.



Power Focus 600

Model	Ordering No.
<b>Drive unit</b>	
Power Focus 600 with remote start	8436 3700 01
<b>IAM</b>	
IAM Joint Control	8436 0900 01
IAM Station Control	8436 0900 05

## FUNCTIONALITY OVERVIEW

	IAM Joint Control	IAM Station Control
<b>Functionality</b>		
Number of Psets	1	16
Batch sequence	1	16
Lock on reject	x	x
<b>Strategies and options</b>		
Torque control	x	x
Torque control and angle monitoring	x	x
Configurable limits for torque and angle	x	x
Rotate spindle forward/reverse	x	x
TurboTight	-	x
Two Step	x	x
Quick Step	x	x
Three Step	x	x
CW / CCW operation	x	x
Complete re-hit detection	x	x
Self tap	x	x
<b>Process information and service</b>		
Tightening data storage (Torque, Status OK/NOK, NOK reason)	30	1000
Torque-time trace	x	x
Event log	1000	1000
<b>Hardware and connectivity</b>		
Web-browser client programming	x	x
Read and write programming via remote Ethernet	-	x
Tightening data via local USB	x	x
Tightening data via remote Ethernet	-	x
Controller SW upgrade via local USB	x	x
Controller SW upgrade via remote Ethernet	-	x
1D/2D Barcode reader for selection	-	x
Remote start	x	x
Configurable I/O	x	x
Stacklight	x	x
Socket selector	x	x
Operator panel	x	x



## TOOLSTALK 2

ToolsTalk 2, the new generation software in controller programming, is ready to take your line management to the next level. The client-server based software solution is geared to provide quick and easy configuration, as well as complete visibility and traceability to your entire line structure.

Built on a state-of-the-art user experience and with an extended amount of unique features it is tailored to fit your needs and optimized to get the job done. It allows you to delegate additional features at any time to respective stations, through the embedded simple Functionality Management System (FMS). With 100% customizable user rights, you maintain quality control in complex production systems and increase uptime in production critical operations.



## TOOLSTALK 2

Model	Delivery	Ordering No.
<b>ToolsTalk 2 – Station Set Up, computer installation</b>		
1- computer installation license	Electronic delivery	8092 1714 00
1- computer installation license	Physical delivery	8092 1714 01
<b>ToolsTalk 2 – Line configurator, virtual station</b>		
1-Virtual Station license	Electronic delivery	8092 1714 02
1-Virtual Station license	Physical delivery	8092 1714 03
5-Virtual Station license	Physical delivery	8092 1714 04
10-Virtual Station license	Physical delivery	8092 1714 05
<b>ToolsTalk 2 – Line Manager, virtual station</b>		
1-Virtual Station license	Electronic delivery	8092 1714 06
1-Virtual Station license	Physical delivery	8092 1714 07
5-Virtual Station license	Physical delivery	8092 1714 08
10-Virtual Station license	Physical delivery	8092 1714 09

## Atlas Copco's Station Solutions reduce cost and ensure quality

*As part of Atlas Copco's Quality Integrated Fastening (QIF) concept we offer complete error proofing stations. These are created by combining our advanced tightening equipment with standard Atlas Copco hardware and software components. Integrated error-proofing assembly stations help you avoid costly reworking, raise productivity and ensure quality on your production line.*

Atlas Copco is one of the few suppliers able to offer a range of products comprehensive enough to build a fully integrated assembly station. QIF error-proofing stations offer the following benefits:

- Increased product quality.
- Standard modules reduce project and set-up time.
- Fast line re-balancing with standard interfaces.
- Higher productivity due to improved operator guidance.
- Full after sales support from Atlas Copco.

### **FAST, EASY SET-UP**

Most QIF products can easily be connected to Power Focus and Pulsor Focus using one I/O Bus cable, and to PowerMACS using one MACS I/O cable. They can be configured using standard Atlas Copco software ToolsTalk. This user-friendly PC software makes programming very simple.

A key factor that makes QIF products so well accepted by users is their logical and intuitive set-up. By combining QIF products with ToolsTalk Logic Configurator, it is possible to make logical diagrams with inputs and outputs that further enhance the flexibility of the products.

### **SELECTOR 6 SERIES**

Improve your productivity and achieve reduction in defects and energy use with superior flexibility and error proofing of your tightening process. Selector 6 Series is designed to give you a perfect Error Proofing solution with outstanding mobility and connectivity. It will improve your productivity and operator ergonomics with increased uptime, make product introduction easier as well as ease of installation.





### FEEDBACK

Higher quality can be achieved by giving audio and/or visual feedback about the assembly process to the operators. Time and costs can be saved by reducing reworking and avoiding faulty products leaving the production line. For feedback use Atlas Copco's Stacklights.



### REDUCTION IN DEFECTS AND NEW PRODUCT INTRODUCTION

The value of guiding the operator is key when introducing new models or having a big product mix. Selector 6 Series provides visual feedback to the operator, decreasing costs related to scrapping and rework.

Selector 6 Series and wireless connectivity greatly supports variance support by bringing the selector closer to application unnecessary operator movement is reduced.



### OPERATOR GUIDANCE

Flexible assembly lines demand different products to be assembled at the same station. Providing direct instructions on a screen with images and text of the assembly process reduces the risk of operator errors. For operator guidance use the Atlas Copco's Scalable Quality Solution 3 and HMIs.



### PROCESS MONITORING

Storing production data for documentation and further analysis is a key factor for traceability. Process improvements can be made by analyzing data. This contributes to increasing quality and boosting productivity by minimizing the number of recalls. For process monitoring use Atlas Copco's ToolsNet 8.



Model	Ordering No.
<b>Socket selector</b>	
Selector 4	8433 0610 04
Selector 8	8433 0610 08
Selector for large sockets	8433 0610 44
Rotary selector	8433 0606 15
Bit selector 8	8433 0612 08
double <sup>a</sup>	4222 0933 92
single <sup>b</sup>	4222 0933 91
<sup>a</sup> Only compatible with Bit selector.	
<sup>b</sup> Only compatible with Socket selector 4 and 8.	
<b>I/O Expanders</b>	
Open	8433 0564 39
Sealed	8433 0564 45
<b>Stacklights</b>	
ESL-04 Standard	8433 0570 13
Rotating red	8433 0570 30
Rotating yellow	8433 0570 35
Siren	8433 0570 40
Compact	8433 0570 16
DSL-03 with push button	8433 0570 10
with blanking plugs	8433 0570 11
<b>Operator panel</b>	
Advanced	8433 0565 00
Basic	8433 0565 10
<b>Remote Start</b>	
Operator handle (ball joint/handle)	
- front/plastic	8435 3030 00
- front/rubber	8435 3030 01
- rear/plastic	8435 3030 02
- rear/rubber	8435 3030 03
Start handle	4220 1391 91
<b>Cables</b>	
<b>Accessory cables</b>	
I/O bus cable 0.5 m	4222 0917 00
1 m	4222 0917 01
3 m	4222 0917 03
5 m	4222 0917 05
10 m	4222 0917 10
15 m	4222 0917 15
I/O Termination plug	4222 0443 00
<b>M12-4 pin</b>	
Female - Open end 5 m	4243 0166 05
Male - Female 5 m	4243 0167 05
10 m	4243 0167 10
15 m	4243 0167 15

## TLS

Model	Ordering No.
<b>Tool Tags</b>	
TLS ST Tag 32 U1	8433 1030 10
TLS ST Tag 61-S U1	8433 1030 20
TLS ST Tag 61-L U1	8433 1030 30
TLS ST Tag 81-S U1	8433 1030 40
TLS ST Tag 81-L U1	8433 1030 50
TLS ST Tag 101 U1	8433 1030 60
<b>Product Tags (package of 5 units)</b>	
TLS Compact Tag U1-63	8433 1026 05
TLS Power Tag U1-65	8433 1025 05
TLS GPS TAG U1-65	8433 1024 05

## SELECTOR 6 SERIES

Model	Ordering No.
<b>Selector 6 M (Mobile)</b>	
Selector 6 with 4 slots	8433 0613 04
8 slots	8433 0613 08
bit slots	8433 0613 09
Power battery 18V	4211 6030 85
Power battery 36V	4211 6030 86
Multi Charger 18-36V	4211 6083 84
Protective cover 18V battery	4211 6090 18
External power supply 24V	8432 0840 00
Carry handle	4222 3142 80
Daisy chain cable 4 to 4	4222 3155 80
4 to 8	4222 3155 81
8 to 8	4222 3155 82
PF6000 adapter cable	4222 3073 00
Socket holder 25 mm	4222 3114 20
50 mm	4222 3114 21
DIN rail adapter	4222 3145 80
<b>Selector 6 S (Stationary)</b>	
Selector 6 with 4 slots	8433 0611 04
8 slots	8433 0611 08
bit slots	8433 0611 09
External power supply 24V	8432 0840 00
Daisy chain cable 4 to 4	4222 3155 80
4 to 8	4222 3155 81
8 to 8	4222 3155 82
PF6000 adapter cable	4222 3073 00
Socket holder 25 mm	4222 3114 20
50 mm	4222 3114 21
DIN rail adapter	4222 3145 80

**NOTE:** Selector 6 Series is only available for Power Focus 6000



Rotary selector



Operator handle



Start handle



Selector 6 S8



Selector 6 S8 with carry handle



Multi Charger



Operator panel Advanced



Stacklight DSL-03



I/O expander sealed



## **TOOLSNET 8**

ToolsNet 8 is a data collection and process improvement software application for use with Power Focus, Pulsor Focus, PowerMACS and STWrench with support for other controllers over ToolsNet open protocol. Combined, these products provide total control of the assembly process, providing a platform for quality improvements. Historical data, statistics and capability indexes can be accessed at any time via a standard web browser such as Microsoft Internet Explorer. ToolsNet is the complete assembly process improvement tool.

## **TRACEABILITY MINIMIZES RECALL COSTS**

The production can be followed in real-time through the dashboard or monitored through different reports such as the Result List report or Product List report which provides information of every tightening related to a specified period or product. In the event of warranty recalls, the result database provides access to critical information which can easily minimize the extent of any recall leading to an overnight payback on your investment.



## **THE RIGHT SOLUTION FOR YOUR NEEDS**

ToolsNet 8 is divided in three different packages to cover different needs.

### **REPORTS**

Take the first step in traceability by collecting all tightening results and storing them in a secure database system. Legal documentation and process improvements can be handled by running several pre-formatted reports specially designed to save user time and effort.

### **ALERT**

Extend the usage of available information by collecting all production events as they occur on the assembly line, in real time. Generate reports to identify events that are happening often and trigger emails to the right personnel based on event distribution rules you create. Be always on the alert for quality variation and workstations that require preventative or corrective tool maintenance.

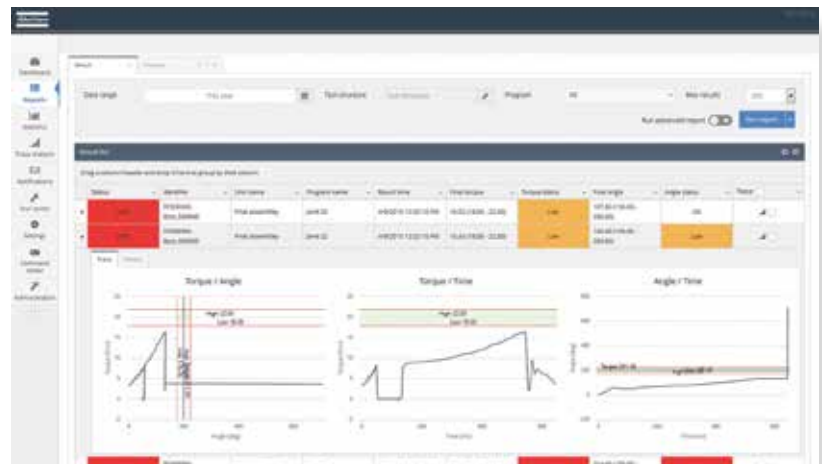

### **ANALYSIS**

The analysis package adds advanced statistical capabilities making it possible to search for variations when it comes to large amounts of production data. Another feature that is added with the analy-

sis package is tool center which makes it possible to track detailed information about the tools that are used in production ensuring that they are serviced and calibrated on time.



Software		Ordering No.	Upgrade Ordering No.
<b>ToolsNet 8 - Reports</b>			
5	Spindle license	8092 1710 05	8092 1810 05
10	Spindle license	8092 1710 10	8092 1810 10
25	Spindle license	8092 1710 25	8092 1810 25
50	Spindle license	8092 1710 50	8092 1810 50
75	Spindle license	8092 1710 75	8092 1810 75
125	Spindle license	8092 1710 80	8092 1810 80
225	Spindle license	8092 1710 85	8092 1810 85
350	Spindle license	8092 1710 90	8092 1810 90
500	Spindle license	8092 1710 95	8092 1810 95
Plant	Spindle license	8092 1710 00	8092 1810 00
<b>ToolsNet 8 - Alerts</b>			
5	Spindle license	8092 1711 05	8092 1811 05
10	Spindle license	8092 1711 10	8092 1811 10
25	Spindle license	8092 1711 25	8092 1811 25
50	Spindle license	8092 1711 50	8092 1811 50
75	Spindle license	8092 1711 75	8092 1811 75
125	Spindle license	8092 1711 80	8092 1811 80
225	Spindle license	8092 1711 85	8092 1811 85
350	Spindle license	8092 1711 90	8092 1811 90
500	Spindle license	8092 1711 95	8092 1811 95
Plant	Spindle license	8092 1711 00	8092 1811 00
<b>ToolsNet 8 - Analysis</b>			
5	Spindle license	8092 1712 05	8092 1812 05
10	Spindle license	8092 1712 10	8092 1812 10
25	Spindle license	8092 1712 25	8092 1812 25
50	Spindle license	8092 1712 50	8092 1812 50
75	Spindle license	8092 1712 75	8092 1812 75
125	Spindle license	8092 1712 80	8092 1812 80
225	Spindle license	8092 1712 85	8092 1812 85
350	Spindle license	8092 1712 90	8092 1812 90
500	Spindle license	8092 1712 95	8092 1812 95
Plant	Spindle license	8092 1712 00	8092 1812 00
<b>ToolsNet 8 - Archiving</b>			
5	Spindle license	8092 1713 05	
10	Spindle license	8092 1713 10	
25	Spindle license	8092 1713 25	
50	Spindle license	8092 1713 50	
75	Spindle license	8092 1713 75	
125	Spindle license	8092 1713 80	
225	Spindle license	8092 1713 85	
350	Spindle license	8092 1713 90	
500	Spindle license	8092 1713 95	
Plant	Spindle license	8092 1713 00	
<b>Operator guidance</b>			
1	User license	8092 1185 01	



<sup>1</sup> ToolsNet 4000 Reports is required.

<sup>2</sup> ToolsNet 4000 Alerts is required.

<sup>3</sup> ToolsNet 4000 History is required.

**NOTE:** Check for availability on your market.

## HLTQ - INDUSTRIAL PC

With their robust design and high-performance components the HLTQ (Hard Line Terminal) series are state-of-the-art devices for your industrial purposes.

You can choose between 6 standard models that are pre-configured and available off-the-shelf, or a customized version which can be configured individually based on available options.



Model	Ordering No.
<b>Standard</b>	
HLT15Q	8434 2300 00
HLT15Q-W (3)	8434 2300 10
HLT19Q	8434 2300 20
HLT19Q-W (3)	8434 2300 30
HLT24Q	8434 2300 40
HLT24Q-W (3)	8434 2300 50
<b>Configurable</b>	
HLT15Q	*
HLT19Q	*
HLT24Q	*

\* Please contact your local Atlas Copco sales representative who will be pleased to help you configure your requested industrial PC.

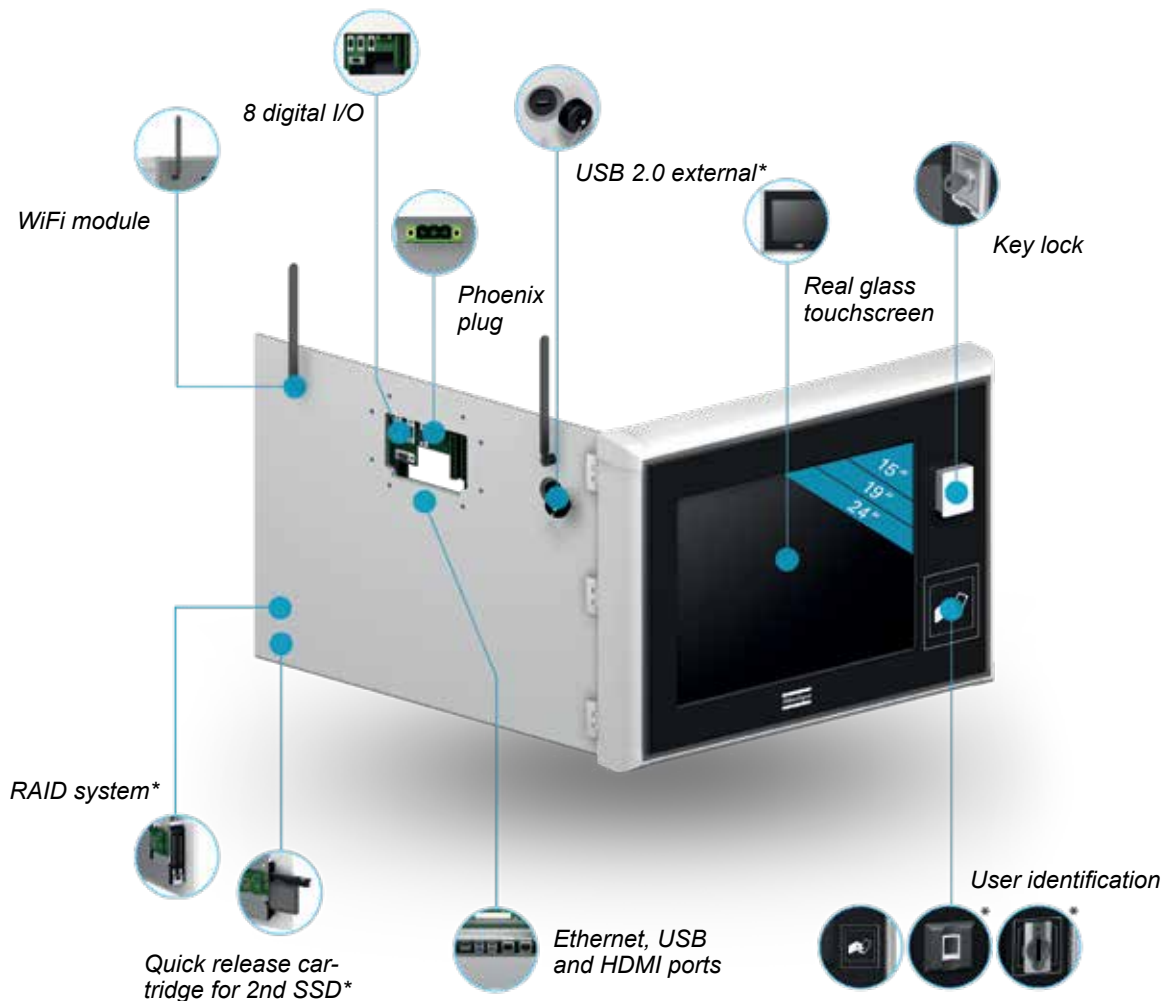

## Technical data

		Standard (15"   19"   24")	Configurable (15"   19"   24")
<b>CPU Type</b>	AMD® G-Series GX-424CA (Quad-Core 2.4 GHz), L2 2 MB, 25 W	•	•
<b>Motherboard</b>	NANO-KBN-i1-4241-R10	•	•
<b>RAM</b>	4 GB, DDR3, FSB 1600/1333 MHz 8 GB, DDR3, FSB 1600/1333 MHz	– •	• Optional
<b>Mass storage</b>	64 GB SSD, 2.5", SATA 3 interface, quick release cartridge 128 GB SSD, 2.5", SATA 3 interface, quick release cartridge 256 GB SSD, 2.5", SATA 3 interface, quick release cartridge	– • –	• Optional Optional
<b>Ports</b>	1 x LAN Gigabit Intel i210-AT, with NCSI support 1 x LAN Gigabit Intel i211-AT 2 x USB 3.0, 2x USB 2.0 (internal accessible) 5 x COM RS232, each with 5V configurable 1 x RS232 / RS422 / RS485, each with 5V configurable Digital Input: 8 x 24VDC Digital Output: 8 x 24VDC, 100mA (single) or 400mA (complete) loadable 1 x extension connector (RJ45) - 7 extension modules connectable 1 x miniPCI express slot 1 x USB 2.0 (external accessible)	• –	• Optional
<b>Ext. Monitor port</b>	1 x HDMI 1.4a	•	•
<b>Display</b>	15": LED TFT, 4:3, 1024 x 768 pixel, brightness ≤ 400 cd/m² 19": LED TFT, 5:4, 1280 x 1024 pixel, brightness ≥ 350 cd/m² 24": LED TFT, 16:9, 1920 x 1080 pixel, brightness ≤ 300 cd/m²	• • •	• • •
<b>Touch</b>	Glass, resistive	•	•
<b>RAID system</b>	RAID1 configuration (mirrored system, quick release cartridge for two SSD's and second 2.5" SSD, min. 64 GB necessary, needs miniPCI express slot)	– <sup>(1)</sup>	Optional <sup>(2)</sup>
<b>WiFi</b>	WLAN Client Interface (802.11 a/b/g/n)	– / •	Optional
<b>User identification</b>	RFID reader 13,56 MHz and 125 kHz LEGIC reader with ID badge holder Fingerprint reader Mifare reader Euchner reader Euchner electronic key system EKS (available on demand)	• • • • • •	• Optional Optional Optional Optional Optional
<b>Lock</b>	Rittal standard	•	•
<b>Power supply</b>	100 – 240 VAC (Phoenix plug) <b>NOTE:</b> No powercable is included in delivery.	•	•
<b>Power rating</b>	Max. 70W	•	•
<b>Current rating</b>	Max. 1A	•	•
<b>Mounting</b>	Adapter console Rittal CP 60 (holder for mounting bracket included)	•	•
<b>Housing</b>	Aluminum	•	•
<b>Protection class</b>	HLT15Q & HLT19Q -> IP44; HLT24Q -> IP42 (regarding EN 60529)	•	•
<b>Operating system</b>	Windows Embedded Standard 7: 64 Bit Windows 7 Pro: 32 Bit / 64 Bit Windows Embedded Standard 7: 32 Bit / 64 Bit	• – –	Optional Optional Optional
<b>Size / Weight</b>	15": 484 x 368 x 70 mm / 12 kg / 26.5 lb (without options, weight of configured options to be added) 19": 583 x 434 x 70 mm / 15 kg / 33.0 lb (without options, weight of configured options to be added) 24": 732 x 434 x 70 mm / 21 kg / 46.3 lb (without options, weight of configured options to be added)	• • •	• • •

(1) Standard RAID upgrade kit is with 128 GB SSD size only

(2) RAID upgrade kit is with the customer specified SSD size

(3) Available with WiFi

**NOTE:** For individual configurations please contact your local sales representative.

### SCALABLE QUALITY SOLUTION 3

The Scalable Quality Solution 3 (SQS3) is an error proofing software that helps achieving zero defects and reducing cost of rework, scrap or warranty claims.

In combination with the industrial PC HLTQ it guides operators step by step through the assembly process.

The software ensures that all fasteners are torqued with the appropriate tool, the correct program, and the right socket to improve product quality and eliminate waste of material.

The data collection feature records the results of all assembly tasks for traceability purposes.

The integrated configurator has a user-friendly interface that does not require programming skills to set up and configure new products and processes.

### TOOLSNET REWORK

ToolsNet Rework, as a module of the SQS3 error proofing software, helps achieving zero defects in rework or repair processes improving productivity and trust of your customers.

Main functions of ToolsNet Rework:

- Queries ToolsNet for OK and NOK tightening data of products.
- Computes consolidated status (OK or NOK) of products based on tightening data.
- Guides operators through the repair process of NOK products.
- Selects the right tool and correct tool parameters required for the repair process.
- User access control ensures only qualified operators are working at the repair station.
- Returns tightening data of repair process to ToolsNet for full traceability.



Software	Ordering No.
SQS3 Standard Software package, single license (Carton box with USB stick and quick-info)	8434 2380 01
SQS3 Standard Software package, single license	8434 2380 02
SQS3 Standard edition, single license (without software installation package)	8434 2380 03
SQS3 Standard edition, 2 licences (without software installation package, packed in a small box)	8434 2380 04
SQS3 Tool (electronic delivery)	8434 2380 09
SQS3 Tool, single license	8434 2380 10
SQS3 Tool, 2 licences	8434 2380 11
SQS3 PLC (electronic delivery)	8434 2380 12
SQS3 PLC, single license	8434 2380 13
SQS3 PLC, 2 licences	8434 2380 14
SQS3 Connect (electronic delivery)	8434 2380 15
SQS3 Connect, single license	8434 2380 16
SQS3 Connect, 2 licences	8434 2380 17
SQS3 Rework (electronic delivery)	8434 2380 18
SQS3 Rework, single license	8434 2380 19
SQS3 Upgrade (electronic delivery)	8434 2380 20
SQS3 Upgrade, single license	8434 2380 21
<b>SQS3 ToolsNet Rework</b>	
SQS3 ToolsNet Rework, single license (Packed in a small box)	8434 2380 23
SQS3 ToolsNet Rework, single license (Electronic delivery)	8434 2380 22
<b>Service offering</b>	
EasyStart SQS, service product	9900 4106 15
TechCover Protect, software support contract	9900 4164 57



## CONNECTIVITY

In combination with the Atlas Copco Scalable Quality Solution 3 software the HLTQ series visualizes and controls your entire assembly process on the shop floor.



HLTQ with Scalable Quality Solution installed

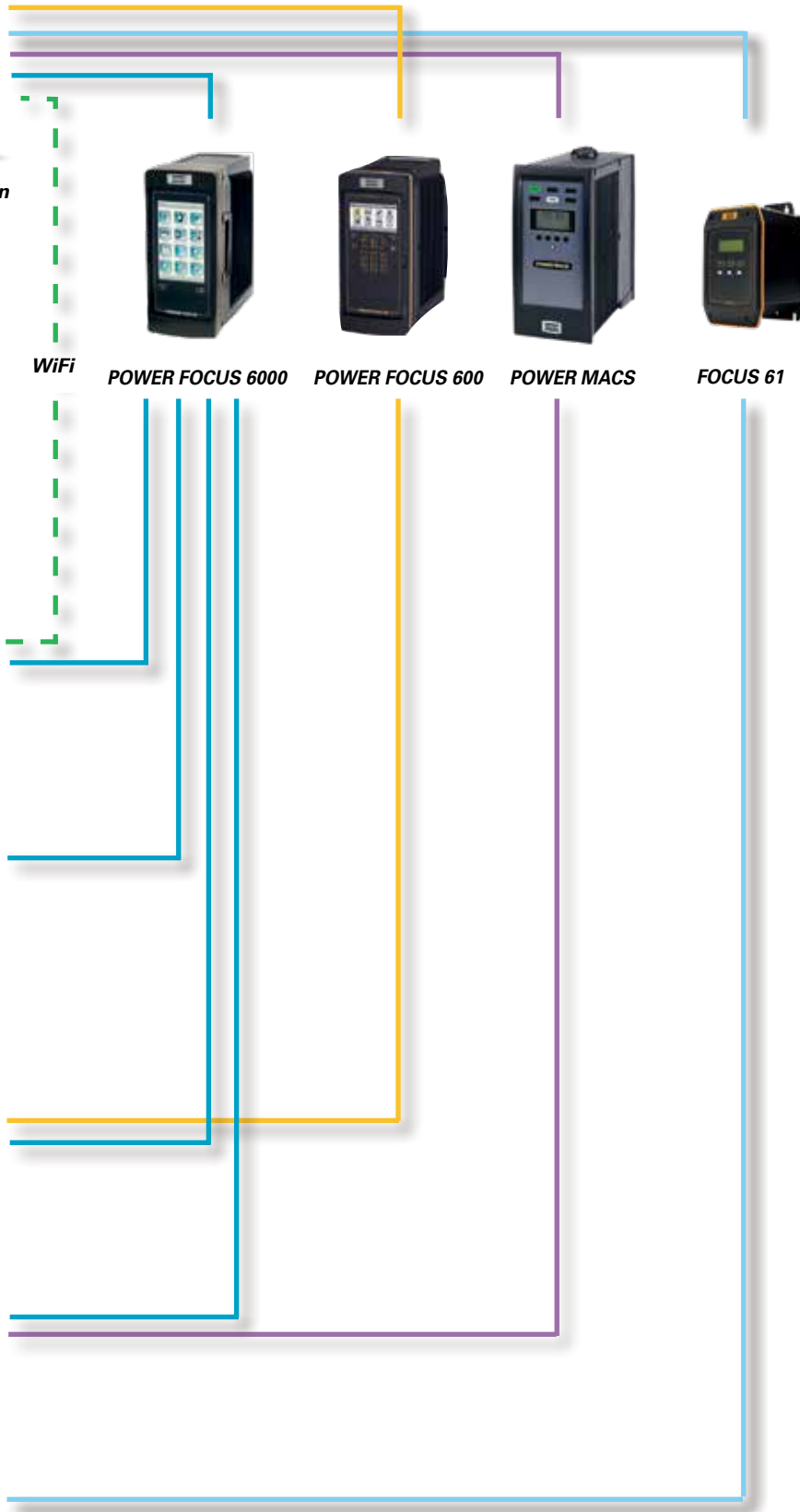





# *Assembly workplace solutions*

## **Contents**

Introduction.....	136
TPS Controller.....	137
TPS Positioning Torque Arms.....	139
Torque arm SML T.....	140
Torque arm SMS T.....	141
Carbon arm SMC.....	142
Carbon arm SMC-TT.....	143
Linear arm SML MK II.....	144
Torque arm SMF.....	145
MicroTorque GHP.....	146
Torque arm accessories.....	147
Balancers.....	152



## Protect your most valuable resource

*Operator health is important. If your operators work with hand-held electric or pneumatic tools, the last thing you want is for their health to suffer. However light the tool, when an operator performs repetitive tasks daily, often with incorrect posture, the tool seems to grow heavier by the hour. Add torque reaction from the tightening process, and the result can be hand-arm-shoulder disorders that may lead to injury and even premature retirement.*

Give your operators an extra arm! Atlas Copco torque arms are labour-saving extensions of Atlas Copco hand-held tools that ensure accurate tightening, and raise individual productivity in your plant. Available for torques of up to 1000 Nm, these ingenious constructions are the perfect way to lighten the load when performing repetitive tasks on lines or benches.

### **EASE THE STRAIN**

Atlas Copco torque arms take the strain off your operators, and allow maximum freedom of movement and flexibility. Wide fields of reach mean that the operator has a large working area without stretching.

### **FAST PAYBACK**

Investing in torque arms is not such a major decision. With their benefits in terms of increased productivity and improved employee health, payback time is short.

### **TO CONSIDER**

- However light or low torque, daily use of tools for repetitive tasks can result in hand/arm/shoulder disorders.
- On average a female operator can take 2/3 of the same force as her male colleague.
- Is there enough space for a torque arm at the workplace?
- Finished product quality improvement.
- With the use of a torque arm the arm will absorb all the reaction force from the tool and prevent the tool from spinning around its axis. To ensure highest possible accuracy of the clamp force a torque arm should be used to prevent movement of the tool.



### **BASIC GUIDELINES FOR TORQUE ARMS**

Tools used full days with a torque capacity shown in the table should always be used together with a torque arm in order to prevent work related injuries.

	Straight	Pistol	Angle
Ergonomical optimized*	> 4 Nm	> 7 Nm	> 30 Nm
Conventional tools	> 3 Nm	> 5 Nm	> 20 Nm

\* Ergonomically optimized tools is electric tools with two step softstop, turbotight or fast clutch pneumatic tool on a hard joint.

## TPS – Tool Positioning System

### **CONTROL THE SEQUENCE AND THE POSITION**

With a TPS controller you are always sure that the operators tighten the joints in the correct sequence and the correct position. The TPS controller works together with the SML/SMS T-series positioning torque arms or the SMC POSI L/LA torque arms and tool controller. The torque arms are equipped with encoders, SMS T-series have 2 angle encoders and SML T-series have 1 linear encoder and 1 angle encoder. The SMC POSI L is equipped with 1 linear encoder to measure the distance the arm travels. SMC POSI LA is equipped with 2 encoders, to measure the distance the arm travel and the angle. The TPS works with digital I/Os for OK or NOK signals to the tool controller to determine the sequence and position of the tool, if the tool is out of position the tool will not start and when the tool is in position it will be able to start. After a correct tightening with OK signal from tool/controller the operator will receive an OK signal from the TPS and is able to start in the next position.

### **EASY PROGRAMMING**

The TPS can use self learning programming, position the tool in the arm over the selected joint and confirm position, go to next joint with the tool/arm and do the same procedure. When all joints are selected validate the job sequence and the TPS is ready for its new job.

### **50 JOBS – 500 POSITIONS**

The TPS can have up to 50 jobs and up to 500 positions (sequences). The TPS can send information to the tool controller to change Pset in the same job which means that it can be different torque settings in the same job and that the same joint can be tightened several times in the same job. When programming the TPS it can also be with different Psets for different jobs so that the operator always has the correct Pset from tool controller when the TPS job is selected.

### **FAST AND SMOOTH TO START TO INCREASE PRODUCTIVITY**

A job can be started by the operator by pressing the start button on the TPS



control and if the TPS is set to Level in job start the operator only needs to push the start button once, when the job is finished with Level setting the same job starts automatically again. Jobs can also be started by a switch button, from tool controller or on timer from previous job.

### **STAND ALONE SYSTEM**

The TPS is a stand alone system that works together with Power Focus, Micro Torque controllers and EBL RE driver. A pneumatic license and air tool package is available to make the TPS work with RE controlled air tools.

### **OPTIONS**

All options are activated by a license code. The license code is ordered separately.

### **BARCODE READER LICENSE OPTION**

Use a barcode reader to start a job and/or identify a job for the TPS to select the correct Pset.

### **RESULT REPORT FUNCTION OPTION**

Save the results to a PC. The results can be saved in two ways, report on job or report on sequence and job.

### **PNEUMATIC TOOL LICENSE OPTION**

The pneumatic tool license also includes the necessary valves and hoses for a correct set up of RE controlled air tools.

# TPS Controller

## TPS CONTROLLER – CONTROL THE SEQUENCE AND THE POSITION

With a TPS controller you are always sure that the operator tightens the joints in the correct sequence and in the correct position.

- Up to 50 jobs and up to 500 positions.
- OK/NOK signal on position.
- The tool will not start when it is out of position.
- Batch count together with OK/NOK on position.
- Works together with Atlas Copco electric tools and RE controlled pneumatic tools.
- Possibility to save and upload set up through a PC.
- Easy and fast set up and programming.
- Error proofing solution.
- ESD approved.



## HOW TO ORDER

1. TPS Controller
2. Select positioning torque arm by style (T-series linear or swivel, or SMC telescopic) and torque arm capacity
3. Cable TPS to tool controller
4. Power supply - optional (needed for MTF 6000)  
**NOTE:** Order power cord separately.
5. Select other options if applicable

## TPS CONTROLLER

Model	Ordering No.
TPS Controller	8202 9004 10

## CONTROLLER ACCESSORY

Model	Ordering No.
I/O Extension TPS	4390 2049 00

## POWER SUPPLY/CORD

Model	Ordering No.
<b>Power supply</b>	
24VDC 30W	4222 1728 50
<b>Power cord</b>	
EU	4222 1801 13
US	4222 1802 13
UK	4222 1803 13
India	4222 1804 13
Switzerland	4222 1805 13
Italy	4222 1806 13
Australia	4222 1807 13
China	4222 1809 13

## OPTIONS

Model	Ordering No.
Barcode license	4390 2045 00
Pneumatic license	4390 2046 00
Reporting license	4390 2047 00

## CABLES

Model	Ordering No.
<b>Cable TPS to controller Power Focus/Tensor</b>	
3 m	4222 1715 03
10 m	4222 1715 10
<b>Cable TPS to controller Power Focus 600</b>	
3 m	4222 1852 03
10 m	4222 1852 10
<b>Cable TPS to EBL RE driver</b>	
1.5 m	4222 1733 01
3 m	4222 1733 03
<b>Cable TPS to controller MTF6000 and G4</b>	
1.5 m	4222 1734 01
3 m	4222 1734 03
<b>Cable TPS to controller MTF400</b>	
1.5 m	4222 1735 01
3 m	4222 1735 03
<b>TPS Open End cable</b>	
3 m	4222 1743 03
10 m	4222 1743 10

## SMC POSI L

SMC carbon arms with 1 encoder to measure the distance the arm travels. With this arm and encoder it is possible to verify the position due to the distance the arm travels. The encoder is mounted inside the arm to safe guard that nothing can interfere with the distance measurements. The SMC POSI L arm can work in both horizontal and vertical position and thus be roof or wall mounted. The accuracy of the encoder is 0.32 mm and the arm together with a TPS controller control the sequence and position.

- Carbon arm with position control up to 200 Nm.
- Encoder measures the distance the arm travels.
- Verify position due to distance.
- Can be mounted both in horizontal and vertical position for maximum flexibility.
- Accuracy of encoder 0.32 mm.
- Control the sequence and position together with TPS controller.

## SMC POSI LA

SMC carbon arms with 2 encoders to measure the length the arm travels and the angle of the arm to determine the position of the arm/tool. With this SMC carbon arm it is possible to verify the position due to the length the arm travels together with an encoder that measures the angle of the arm. The length encoder is mounted inside the arm to safe guard that nothing can interfere with the length measurement and the angle encoder is mounted at the top of the arm. The SMC POSI LA can work in both horizontal and vertical position and thus be roof or wall mounted. The accuracy of the encoders is 0.32 mm and the arm together with a TPS controller will control the sequence and position.

- Carbon arm with 2 encoders to control position.
- Encoders measure the arm travel length and the angle of the arm to determine the position.
- Can be mounted both in horizontal and vertical position for maximum flexibility.
- Accuracy of encoder is 0.32 mm.
- Control the sequence and position together with the TPS controller.
- Arms available up to 200 Nm.

## SML/SMS T-SERIES POSITIONING ARMS

The Atlas Copco T-series of arms are built to handle the most demanding industrial situation when you need to control the sequence and the position. The T-series arms are equipped with two encoders, SMS T-series have 2 angle encoders to determine the position and



SML T-series have 1 linear encoder and 1 angle encoder to determine the position. The arms are delivered with balancer, encoders and encoder cables ready to be plugged into the TPS controller.

- Control the sequence and position together with TPS controller.
- Excellent working area for work bench assembly stations.
- Available up to 100 Nm.

### SMC CARBON ARMS WITH 1 ENCODER

Model	Ordering No.
SMC 12 1150 POSI L	4390 1510 77
SMC 12 1600 POSI L	4390 1511 87
SMC 12 2100 POSI L	4390 1512 87
SMC 25 1150 POSI L	4390 1514 77
SMC 25 1600 POSI L	4390 1515 87
SMC 25 2100 POSI L	4390 1516 87
SMC 25 2600 POSI L	4390 1517 87
SMC 50 1600 POSI L	4390 1518 77
SMC 50 2100 POSI L	4390 1519 87
SMC 50 2600 POSI L	4390 1520 87
SMC 100 1600 POSI L	4390 1522 87
SMC 100 2100 POSI L	4390 1523 77
SMC 100 2600 POSI L	4390 1524 87
SMC 200 1600 POSI L	4390 1526 87
SMC 200 2100 POSI L	4390 1527 87
SMC 200 2600 POSI L	4390 1528 87

### SMC CARBON ARMS WITH 2 ENCODERS

Model	Ordering No.
SMC 12 1150 POSI LA	4390 1510 79
SMC 12 1600 POSI LA	4390 1511 79
SMC 12 2100 POSI LA	4390 1512 79
SMC 25 1150 POSI LA	4390 1514 79
SMC 25 1600 POSI LA	4390 1515 79
SMC 25 2100 POSI LA	4390 1516 79
SMC 25 2600 POSI LA	4390 1517 79
SMC 50 1600 POSI LA	4390 1518 79
SMC 50 2100 POSI LA	4390 1519 79
SMC 50 2600 POSI LA	4390 1520 79
SMC 100 1600 POSI LA	4390 1522 79
SMC 100 2100 POSI LA	4390 1523 79
SMC 100 2600 POSI LA	4390 1524 79
SMC 200 1600 POSI LA	4390 1526 79
SMC 200 2100 POSI LA	4390 1527 79
SMC 200 2600 POSI LA	4390 1528 79

### SML / SMS T ARMS WITH 2 ENCODERS

Model	Ordering No.
SML T-5 Position	4390 2030 00
SML T-12 Position	4390 2031 00
SML T-25 Position	4390 2032 00
SML T-50 Position	4390 2034 00
SML T-100 Position	4390 2035 00
SMS T-5 Position	4390 2036 00
SMS T-12 Position	4390 2037 00
SMS T-25 Position	4390 2038 00
SMS T-50 Position	4390 2039 00
SMS T-100 Position	4390 2040 00

**NOTE:** Tool holder needs to be ordered separately. SML/SMS T-series are equipped with balancer.

Choose the appropriate balancer for SMC arms depending on tool weight and order the balancer kit for easy and fast assembly if the arm is roof mounted.



## SMLT – SERIES TORQUE ARMS

The Atlas Copco linear arms are built to handle the most demanding industrial situations. The robust design offers unmatched user friendliness. The linear arms are equipped with ball bearings for smooth operation, and an adjustable plate for maximum adjustment of minimum and maximum working area. The linear arms have balancer included that will absorb the weight of the arm and tool combination to reduce the weight for the operator. The arms minimize the reaction force of the tool to prevent hand-arm-shoulder disorders. With minimized reaction force of the tool, finished product quality is also higher since there is no movement of the tool and all torque is absorbed in the joint.

- Robust construction for long life and no force transferred to operator.
- Balancer included to remove the tool and arm weight from the operator.
- Available from 5 Nm up to 100 Nm.
- Minimizes reaction force to prevent hand-arm-shoulder disorders.
- Improves finished product quality with all torque absorbed in the joint and no movement of tool.



Model	Max tool weight		Max torque		Min width without tool holder mm	A Max reach without tool holder mm	B Horizontal stroke		C Height mm	Tool holder interface type	Ordering No.
	kg	lb	Nm	ft lb			mm	mm			
SML T-5	0.8	1.7	5	3.7	158	530	205	310	732	A	4390 2000 00
SML T-12	1.5	3.3	12	8.8	198	648	255	465	888	A	4390 2001 00
SML T-25	2.2	4.8	25	18.4	167	732	290	615	1100	A	4390 2002 00
SML T-50	5	11	50	36.9	267	887	355	515	1116	B	4390 2004 00
SML T-100	6	13.2	100	73.8	255	914	395	515	1116	B	4390 2005 00

Tool holder is ordered separately.

## Dimensions

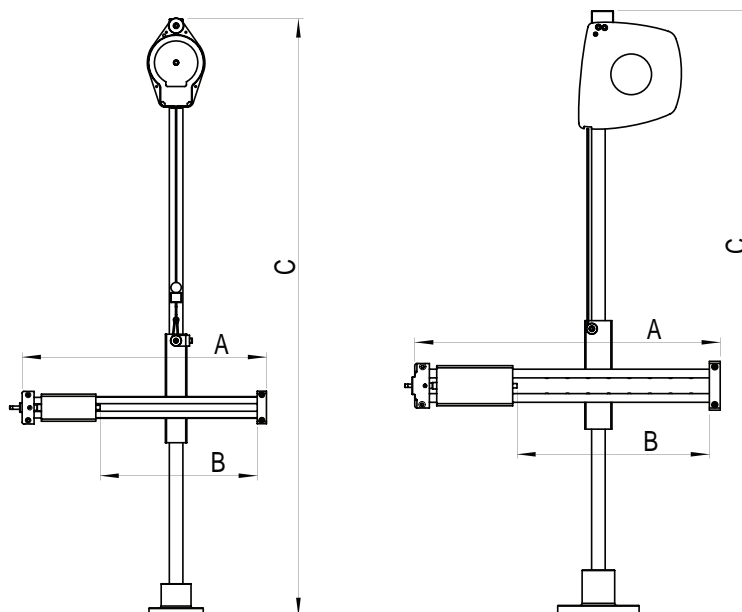

## SMST – SERIES TORQUE ARMS

The Atlas Copco linear arms are built to handle the most demanding industrial situations. The robust design offers unmatched user friendliness and, due to the swivel function, a wide working area is covered with the SMS T-series. The swivel arms are equipped with ball bearings for smooth operation, and an adjustable plate for maximum adjustment of minimum and maximum working area. The swivel arms have a balancer included that will absorb the weight of the arm and tool combination to reduce the weight for the operator. The arms minimize reaction force of the tool to prevent hand-arm-shoulder disorders. With minimized reaction force of the tool, finished product quality is also higher since there is no movement of the tool and all torque is absorbed in the joint.

- Robust construction for long life and no force transferred to operator.
- Balancer included to remove the tool and arm weight from the operator.
- Available from 5 Nm up to 100 Nm.
- Minimizes reaction force to prevent hand-arm-shoulder disorders.
- Improves finished product quality with all torque absorbed in the joint and no movement of the tool.



Model	Max tool weight		Max torque		D	B+D	C	A	B	Tool holder interface type	Ordering No.
	kg	lb	Nm	ft lb	Swivel rods width without tool holder mm	Max reach without tool holder mm	Vertical stroke mm	Height mm	Width mm		
SMS T-5	0.8	1.7	5	3.7	292	582	270	732	248	A	4390 2006 00
SMS T-12	1.5	3.3	12	8.8	342	682	425	888	298	A	4390 2007 00
SMS T-25	2.5	5.5	25	18.4	392	732	580	1132	296	A	4390 2008 00
SMS T-50	5	11	50	36.9	437	825	520	1147	336	B	4390 2009 00
SMS T-100	6	13.2	100	73.8	487	930	500	1147	391	B	4390 2010 00

Tool holder is ordered separately.

## Dimensions

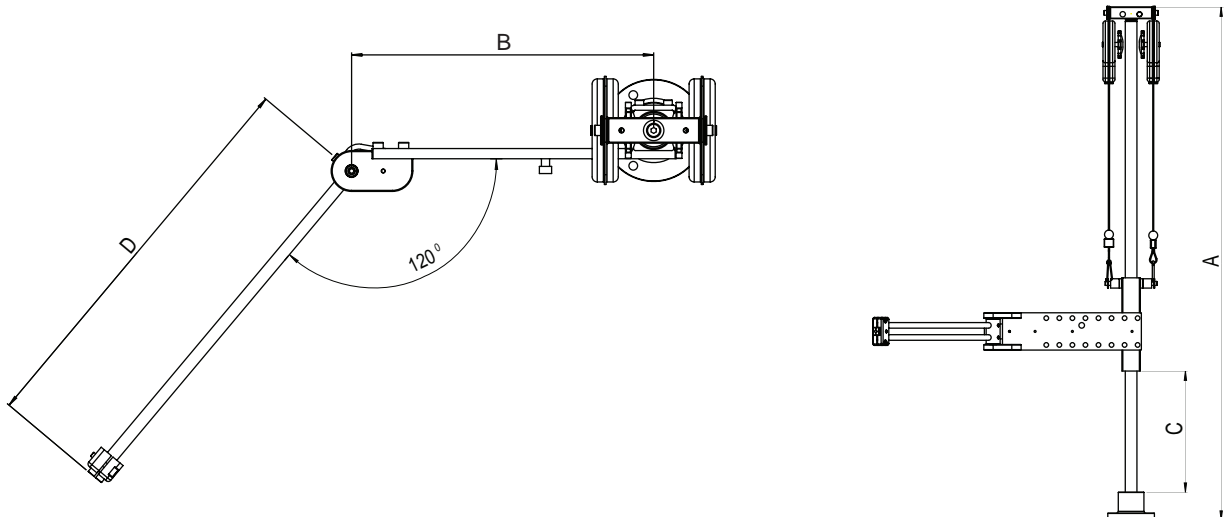

## SMC – CARBON ARMS

The Atlas Copco carbon arms have a telescopic design for maximum flexibility in the workplace. The carbon arms are light weight with smooth movements to reduce the operator force to use the arms. Together with a balancer the carbon arms can either retract up or be used in a weightless position to improve operator comfort. The carbon arms minimize reaction force to prevent hand-arm-shoulder disorders. With minimized reaction force of the tool you will also improve finished product quality because there is no movement of the tool and all torque is absorbed in the joint.

- Telescopic design for maximum flexibility in the workplace.
- Light weight and smooth movements for operator comfort.
- Easy to use together with balancer to create weightless solution to improve ergonomics.



- Minimizes reaction force to prevent hand-arm-shoulder disorders.
- Minimizes pinching and can replace reaction bars.
- Improve finished product quality with all torque absorbed in the joint and no movement of the tool.

Model	Max torque		Min length mm	Max length mm	A Max tool holder swivel angle [deg]	Weight		Tool holder interface type	Ordering No.
	Nm	ft lb				kg	lb		
SMC 12 1150	12	8.9	516	1128	60	0.37	0.816	A	4390 1510 85
SMC 12 1600	12	8.9	666	1578	60	0.42	0.926	A	4390 1511 85
SMC 12 2100	12	8.9	835	2083	60	0.48	1.06	A	4390 1512 85
SMC 25 1150	25	18.4	524	1124	50	0.51	1.12	A	4390 1514 85
SMC 25 1600	25	18.4	674	1574	50	0.61	1.34	A	4390 1515 85
SMC 25 2100	25	18.4	841	2075	50	0.68	1.5	A	4390 1516 85
SMC 25 2600	25	18.4	1007	2573	50	0.77	1.7	A	4390 1517 85
SMC 50 1600	50	36.9	712	1624	40	0.95	2.09	B	4390 1518 85
SMC 50 2100	50	36.9	878	2125	40	1.05	2.31	B	4390 1519 85
SMC 50 2600	50	36.9	1045	2626	40	1.15	2.54	B	4390 1520 85
SMC 100 1600	100	73.8	722	1628	30	1.28	2.82	B	4390 1522 85
SMC 100 2100	100	73.8	889	2129	30	1.41	3.11	B	4390 1523 85
SMC 100 2600	100	73.8	1056	2630	30	1.53	3.37	B	4390 1524 85
SMC 200 1600	200	148	726	1628	20	1.98	4.37	-	4390 1526 85
SMC 200 2100	200	148	893	2129	20	2.18	4.81	-	4390 1527 85
SMC 200 2600	200	148	1060	2630	20	2.39	5.27	-	4390 1528 85
SMC 300 1600	300	221	744	1631	20	2.40	5.29	-	4390 1530 85
SMC 300 2100	300	221	911	2132	20	2.60	5.73	-	4390 1531 85
SMC 300 2600	300	221	1078	2633	20	2.81	6.20	-	4390 1532 85

Tool holder is ordered separately. Choose the appropriate balancer depending on tool weight. Order the balancer kit for easy and fast assembly.  
**NOTE:** A: 17 mm square interface, B: 32 mm square interface. For SMC 200 the tool holders connect directly to the clevis of the arm.

## Dimensions

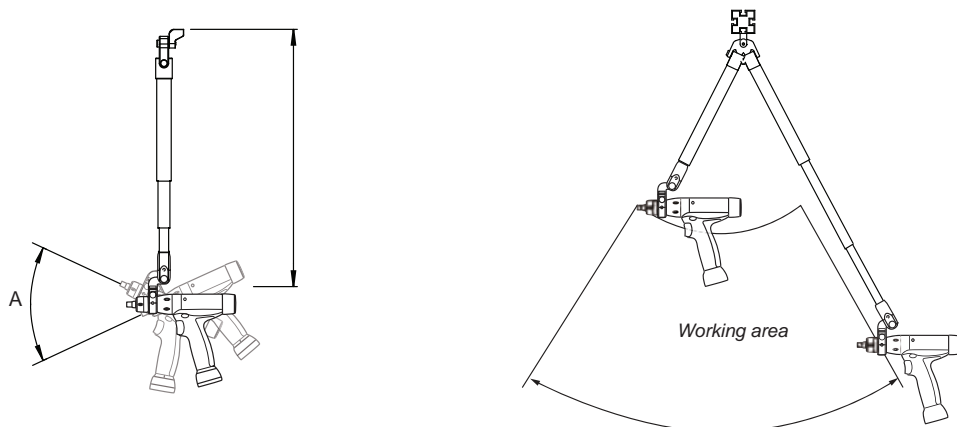

## SMC-TT – CARBON ARMS

The SMC-TT torque arm range from Atlas Copco consists of three models varying from 10 to 25 Nm. The SMC-TT torque arms are designed to be used in combination with handheld straight and angle tools, including both electric and pneumatic. They are suited to be utilized for various rail and roof-mounted applications in all sorts of assembly environments. The product range has a modular setup with several available combinations and accessories to provide the most efficient and ergonomic workstation. The availability of a rigid top fixation allows the SMC-TT arm to be fastened to a roof attachment. The 10 Nm torque arm is available in one length version and the 25 Nm models are available in two length variants to achieve better reach.

- Easy to position and handle torque arms that allow for smooth movements to achieve operator comfort.
- Telescopic design for maximum flexibility with an extensive working range.
- Easy to use together with balancer to create weightless solution leading to improved operator ergonomics.
- Minimized strain to prevent wrist/arm/shoulder injuries due to repetitive use.
- Improved finished product quality with all torque absorbed in the joint and no movement of the tool.



Model	Max torque		Min length mm	Max length mm	A	B	C	Weight		Tool holder interface		Ordering No.
	Nm	ft lb			Max tool holder swivel angle [deg]	Max tool holder swivel angle [deg]	Max tool holder swivel angle [deg]	kg	lb	type		
SMC-TT-10-850	10	7.4	713	1013	60	8	24	1.4	3.1	A	4390 1510 29	
SMC-TT-25-1150	25	18.4	831	1131	60	8	24	3.5	7.8	A	4390 1510 31	
SMC-TT-25-1600	25	18.4	1131	1731	60	8	24	4.0	8.7	A	4390 1510 32	

## Dimensions

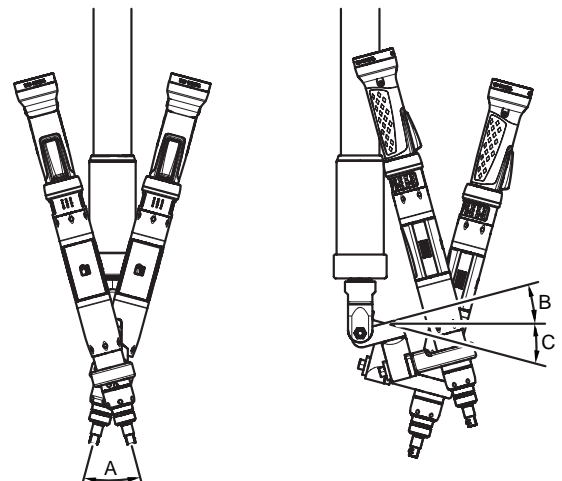
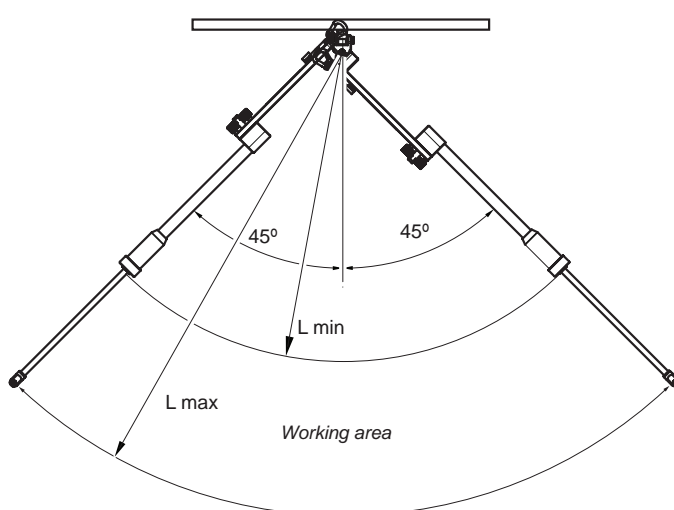

## TORQUE ARM SML MK II

By mounting your assembly tool on a SML MK II torque arm you will immediately increase the productivity and reduce muscular stress from your operators. All arms are delivered with integrated balancer, 3-axis movement and the Atlas Copco interface for tool holders. The 3-axis movement allows the operator to ease the arm effortlessly around the workstation.

- 3-axis movement for maximum flexibility.
- Strong and durable desing.
- Integrated balancer to support tool and arm weight.
- High torque capacity, up to 1000 Nm.
- Same tool holder interface as SML T / SMS T / SMC for arms up to 150 Nm.



Model	Max tool weight		Max torque		D Horizontal stroke mm	C Vertical stroke mm	A Height mm	Tool holder interface type	Ordering No.
	kg	lb	Nm	ft lb					
SML 10 MK II	1	2.2	10	7.4	240	220	680	A	8202 9003 20
SML 40 MK II	2.3	5.1	40	29.5	280	290	834	B	8202 9003 21
SML 80 MK II	5.2	11.5	80	59	320	360	964	B	8202 9003 22
SML 150 MK II	7	15.4	150	110.7	360	430	1049	C	8202 9003 23
SML 300 MK II	14	30.9	300	221.4	400	500	1231	C	8202 9003 24
SML 500 MK II	10	22	500	369	440	570	1361	C	8202 9003 25
SML 1000 MK II	11.3	24.9	1000	738	480	640	1571	C	8202 9003 26

Tool holder is ordered separately.

## Dimensions

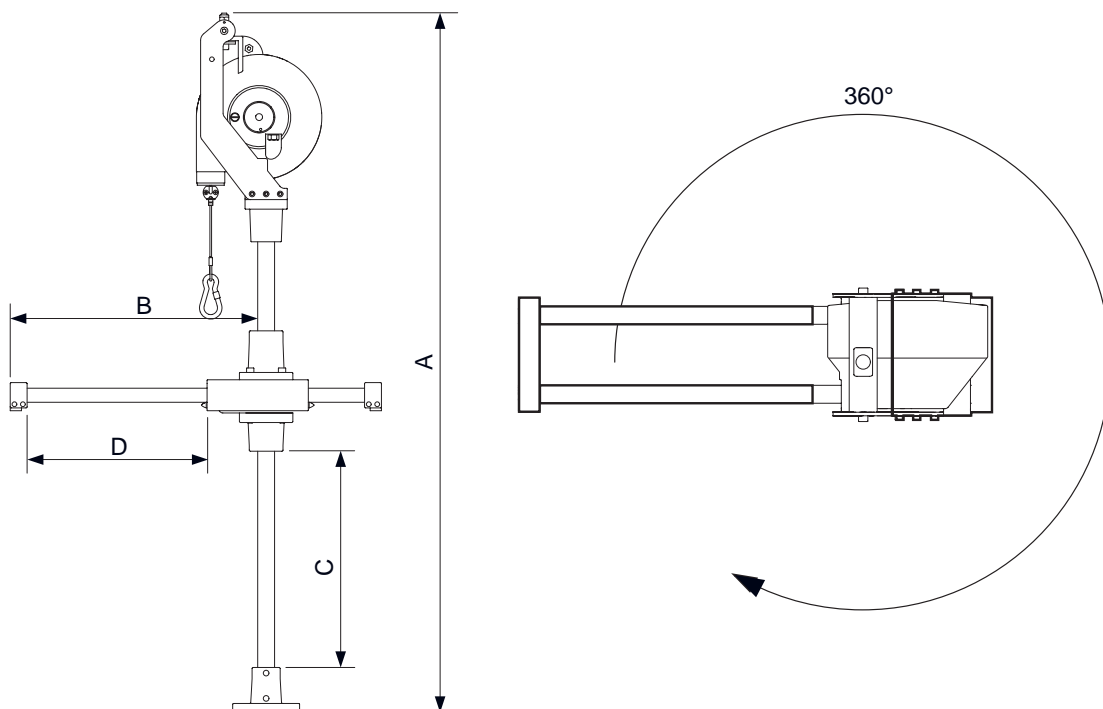



**TORQUE ARM SMF**

The SMF-25 torque arms are labor-saving extensions of the Atlas Copco hand-held tools. They are made of aluminum and are suitable for straight and pistol assembly tools up to 25 Nm. The parallel torque arm has a foldable and space-saving design that eliminates the weight and torque of the tool, thus improving operator ergonomics, providing accurate tightening and contributing to increased productivity.

The SMF-25 arm range has a bench stand with a working area of 710 mm and 870 mm allowing tool setups weighing up to 2 kg (4.4 lb). These arms can also be used with a wall mount, therefore making them suitable for either flat wall surfaces or structural framing systems in assembly environments. All related accessories and tool holders need to be ordered separately.

- Robust construction that diminishes the transferred force to operator and extends product longevity.
- Springs included to eliminate tool and arm weight from the operator.
- Reaction force minimized to prevent hand/arm/shoulder disorders.
- Improved product quality due to torque absorption in the joint and no movement of the tool.



Model	Max tool weight		Max torque		A	B	C	Tool holder interface type	Ordering No.
	kg	lb	Nm	ft lb	Max reach without tool holder mm	Horizontal stroke mm	Vertical stroke mm		
SMF-25-710	2.0	4.4	25	18.4	710	300	300	A	4390 2083 00
SMF-25-870	2.0	4.4	25	18.4	870	400	400	A	4390 2083 30

**Dimensions**

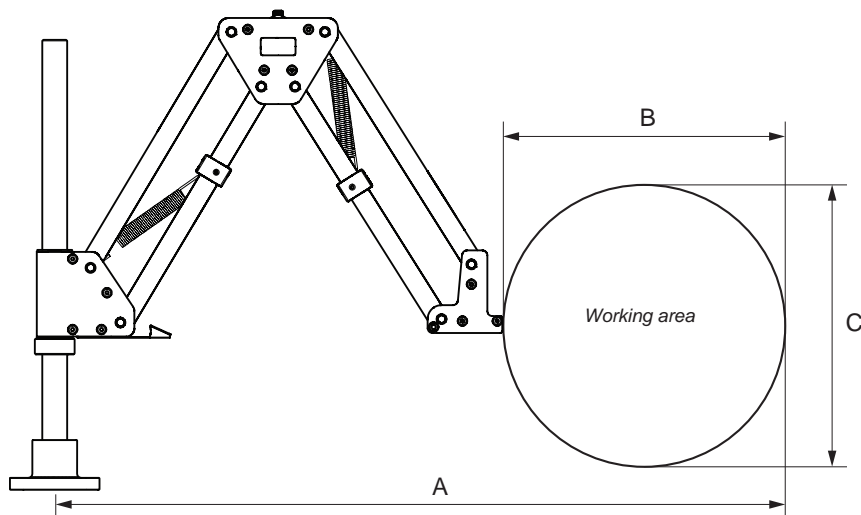

## GHP – TORQUE ARM FOR MICROTORQUE RANGE

Atlas Copco GHP torque arm is an excellent means of assistance when using hand-held or fixtured straight microtorque screwdrivers.

Torque arm GHP Mini is recommended with screwdrivers below 100 Ncm, and GHP Small below 200 Ncm.

The GHP torque arms are exceptionally easy to position and handle. The design is intended for low torque applications and work tasks over a long period of time. Comes with appropriate balancing system to support the weight of the tool.



Model	Stroke mm	alfa	Ordering No.
GHP Mini	200	270°	8432 0830 02
GHP Small	400	270°	8432 0830 03
GHP Large	730	270°	8432 0830 04

Tool holder is ordered separately.

## Dimensions

Model	Working range, mm	
	A	B
GHP Mini	280	150
GHP Small	460	250
GHP Large	500	250

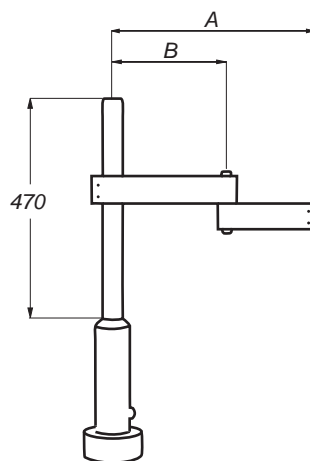

GHP Mini

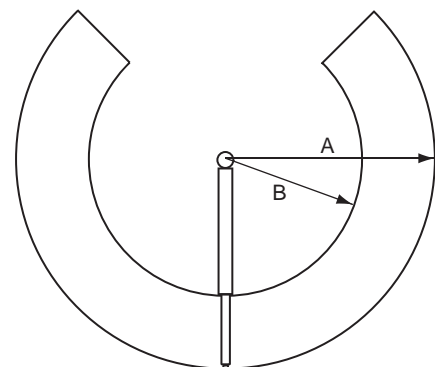

GHP Small/GHP Large

## Optional Accessories

### TOOL HOLDER GUIDE

Atlas Copco tool holders are designed to optimize your workplace solution. Depending on tool, torque arm and application you can choose from a wide range of tool holders; universal holder, specific diameter holders, spline holders, mounting plates with spine or hole, pistol tool holders or angle tool holders. A tool specific tool holder is always better than a universal holder.



Universal tool holder



Tool holder, diameter

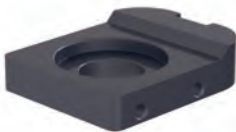

Mounting plate



Tool holder, Spline

### HOW TO BUILD YOUR WORKPLACE SOLUTION

- 1) Tool
- 2) Torque arm
  - Torque range
  - Work area
  - Tool weight
- 3) Tool holder
  - Arm - Tool holder interface type (or mounting on arm clevis, as for SMC angle tool holders)
  - Tool interface: eg. Spline, Diameter or Angle
- 4) Accessories
- 5) For SMC - Balancer

### TOOL HOLDERS FOR TORQUE ARMS WITH TOOL HOLDER INTERFACE TYPE A SMC 12/25 AND SMS/L T 5/12/25 AND SML MK II 10

Model	Tool dia. mm	Spline type	Arm interface type	Description	Ordering No.
Universal holder	26 - 49	-	A	Max tool torque 25 Nm	4390 1510 86
Holder, Spline 1	-	1	A		4390 1513 07
Holder, diameter 30.5	30 - 30.5	-	A		4390 1513 80
Holder, diameter 34	33.5 - 34	-	A		4390 1513 81
Holder diameter 36.5	36 - 36.5	-	A		4390 1513 82
Holder diameter 38	37.5 - 38	-	A		4390 1513 83
Holder diameter 44	43.5 - 44	-	A		4390 1513 84
Holder diameter 46	45.5 - 46	-	A	To be used with adapter	4390 1513 85
Special adapters to be used with dia 46 mm tool holder					
				LUM10 PR	4390 1734 09
				ELI	4390 1734 08
				LUM21 PR-P	4390 1735 44
				LUM12 SR	4390 1735 52
				LUM12 PR	4390 1735 53
				LUM22 PR	4390 1735 54
Holder diameter 56	55.5-56	-	A	To be used with adapter	4390 1513 86
Special adapters to be used with dia 56 mm tool holder					
				LUM21 SR	4390 1735 45
				LUM22 SR	4390 1735 51
Mounting plate, Spline 1	-	1	A		4390 2020 00
Mounting plate, Spline 2	-	2	A		4390 2020 01
Mounting plate, hole 24	24	-	A		4390 2020 02
Mounting plate, hole 26	26	-	A		4390 2020 03
Mounting plate, hole 28	28	-	A		4390 2020 04
Mounting plate, blank	-	-	A		4390 2020 05

### TOOL HOLDERS FOR TORQUE ARMS WITH TOOL HOLDER INTERFACE TYPE B, SMC 50/100 AND SMS/L T 50/100 AND SML MK II 40/80

Model	Tool dia. mm	Spline type	Arm interface type	Description	Ordering No.
Universal holder	30 - 50	-	B	Max tool torque 50 Nm	4390 2064 80
Holder, Spline 1	-	1	B		4390 1513 08
Holder, Spline 2	-	2	B		4390 1513 09
Holder, Spline 3	-	3	B		4390 1513 10
Holder, hole 24	24	-	B		4390 1518 22
Mounting plate, Spline 1	-	1	B		4390 2021 00
Mounting plate, Spline 2	-	2	B		4390 2021 01
Mounting plate, Spline 3	-	3	B		4390 2021 02
Mounting plate, hole 24	24	-	B		4390 2021 03
Mounting plate, hole 26	26	-	B		4390 2021 04
Mounting plate, hole 28	28	-	B		4390 2021 05
Mounting plate, blank	-	-	B		4390 2021 06

# Torque Arm Accessories

## Optional Accessories

### SWIVELING TOOL HOLDERS FOR SMC CARBON ARMS

Model	Tool dia. mm	Ordering No.
<b>For SMC 50</b>		
Swiveling tool holder 50 – A	39	4390 2081 86
50 – B	43	4390 2081 74
50 – C	45	4390 2081 75
50 – D	36.5	4390 2081 76
<b>For SMC 100</b>		
Swiveling tool holder 100 – A	39	4390 2081 56
100 – B	43	4390 2081 57
100 – C	45	4390 2081 58
100 – E	40	4390 2081 55
<b>For SMC 200</b>		
Swiveling tool holder 200 – A	39	4390 2081 85
200 – B	43	4390 2081 77
200 – C	45	4390 2081 78



Tool holder, Swiveling

### MOUNTING PLATES FOR SML MK II 150/300/500/1000 TORQUE ARMS, TOOL HOLDER INTERFACE TYPE C

Model	Tool dia. mm	Spline type	Arm interface type	Ordering No.
Mounting plate, Spline 1	-	1	C	4390 1760 00
Mounting plate, Spline 2	-	2	C	4390 1761 00
Mounting plate, Spline 3	-	3	C	4390 1762 00
Mounting plate, Spline 4	-	4	C	4390 1763 00
Mounting plate, Spline 5	-	5	C	4390 1764 00
Mounting plate, Spline 6	-	6	C	4390 1765 00
Mounting plate, Spline 7	-	7	C	4390 1766 00
Mounting plate, QMX/ETX50	-	-	C	4390 1782 00
Mounting plate, QMX/ETX62	-	-	C	4390 1783 00
Mounting plate, QMX90/ETX90	-	-	C	4390 1785 00
Extension mounting plate	-	-	C	4390 1768 00

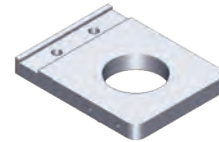

Mounting plate

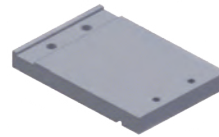

Extension mounting plate

### PISTOL TOOL HOLDERS FOR SMC CARBON ARMS

Model	Tool dia. mm	Spline type	Arm interface type	Description	Ordering No.
Pistol holder, hole 24	24	-	-	For SMC 50	4390 1518 18
Pistol holder, Spline 2	-	2	-	For SMC 100	4390 1522 18
Pistol holder, Spline 2	-	2	-	For SMC 200	4390 1526 18
Pistol holder, Spline 3	-	3	-	For SMC 200	4390 1513 11

Tool holder connects directly to the clevis of the arm.



Pistol holder

### ANGLE TOOL HOLDERS FOR SMC CARBON ARMS, SMC 50

Model	Description	Ordering No.
Angle tool holder for	LTV38-R50-13, LTV38-R42-13	4390 2062 80
	LTV38-R50-HAD, LTV38-R42-HAD	4390 2062 81
	LTV38-R50-10, LTV38-R42-10	4390 2062 82
	LTV39-2 R30-10, LTV39-2 R37-10, LTV39-2 R48-10	4390 2062 83
	ETV ST61-40-10, ETV ST61-40-HAD, ETV STB62-40-10, ETV STB62-50-10	4390 2062 84
	ETV STB32-30-10, ETV ST61-30-10, ETV STB62-30-10	4390 2062 85
	LTV39-2 R48-13	4390 2062 86
	LTV29-2 R30-10	4390 2062 87

Tool holder connects directly to the clevis of the arm.



Angle tool holder

## Optional Accessories



Angle tool holder

### ANGLE TOOL HOLDERS FOR SMC CARBON ARMS, SMC 100

Model	Description	Ordering No.
Angle tool holder	ETV ST81-100-13, ETV ST61-100-13, ETV STB62-100-13	4390 2061 80
	ETV STB62-70-13, ETV ST81-70-13-L150, ETV ST81-70-13, ETV ST61-70-13, ETV ST81-90-HAD, ETV ST61-90-HAD	4390 2061 82
	LTV39-2 R70-13, LTV39-2 R56-13	4390 2061 83
	LTV39-2 R85-13	4390 2061 84
	LTV38-R85-13	4390 2061 85
	LTV38 R85-HAD	4390 2061 86
	ETV ST81-50-10, ETV ST61-50-HAD, ETV ST61-50-10, LTV39-2 R56-10	4390 2061 87
	ETV ST101-100-HAD, ETV ST101-100-13, ETV ST101-100-INTEL	4390 2061 88
	LTV38 R70-13	4390 2061 89
	LTV38 R57-13	4390 2061 90

Tool holder connects directly to the clevis of the arm.

### ANGLE TOOL HOLDERS FOR SMC CARBON ARMS, SMC 200

Model	Description	Ordering No.
Angle tool holder	ETV ST61-200, ETV ST81-200	4390 1513 87
	ETV ST101-180-13 / 13-F / 13-M / 13-M-F, ETV ST101-180-B13 / B13-F,	4390 2060 80
	ETV ST61-150-13 / B13 / 13-ATEX, ETV ST61-180-13 / B13 / 13-ATEX, ETV ST81-150-13 / B13, ETV ST81-180-13 / B13	4390 2060 81
	LTV48 R120-L13 / R150-L13 / R200-L13	4390 2060 84
	LTV69 R180-13, LTV69 N180-13	4390 2060 85
	LTV48 R120-HAD / R150-HAD / R200-HAD	4390 2060 86
	LTV48 R120-FS / R150-FS / R200-FS	
	ETV ST61-150-FS / 180-FS	4390 2060 87
	ETV ST61-120-HAD / 150-HAD / 180-HAD	
	ETV ST81-120-HAD / 150-HAD / 180-HAD	
	ETV ST81-150-FS / 180-FS	
	ETV ST101-180-FS / FS-F, ETV ST101-180-Intel / Intel-F	4390 2060 88
	ETV ST101-180-HAD / HAD-F	

Tool holder connects directly to the clevis of the arm.



Bench stand

### TOOL HOLDERS FOR SMC CARBON ARMS, SMC 300

Model	Description	Ordering No.
Angle tool holder	ETV ST101-270	4390 2081 50
Pistol tool holder	ETP ST101-300-20-F (Tensor Revo)	4390 2081 51

### OPTIONAL ACCESSORIES FOR SMC CARBON ARMS

Model	Description	Ordering No.
Bench stand	Bench stand with height 753 mm. Holder must be ordered separately	4390 1728 00
Holder for bench stand	Stand attachment 12-25 Nm Stand attachment 50-100 Nm SMC 200 should not be used with table stand	4390 1510 88 4390 1518 88
Balancer kit	SMC Balancer adaptor kit for RIL 1C-5C and WP10	4390 2050 00
	SMC Balancer adaptor kit for WP05	4390 2078 80



Holder for bench stand



# Torque Arm Accessories

## Optional Accessories

### OPTIONAL ACCESSORIES FOR SMC-TT CARBON ARMS

Model	Description	Ordering No.
<b>For SMC-TT-10</b>		
Straight tool adapter – A	To attach tool holder for straight tools	4390 2022 04
Balancer adapter – A	To attach balancer RIL4-5C	4390 2022 01
Gravity center adapter – A	To adjust gravity center	4390 2022 02
Rigid top fixation – A		4390 2022 03
<b>For SMC-TT-25</b>		
Straight tool adapter – B	To attach tool holder for straight tools	4390 2022 08
Balancer adapter – B	To attach balancer RIL4-5C	4390 2022 05
Gravity center adapter – B	To adjust gravity center	4390 2022 06
Rigid top fixation – B		4390 2022 07

### OPTIONAL ACCESSORIES FOR SMF ARMS

Model	Description	Ordering No.
Wall mount	For attachment on wall or rail	4390 2081 10

## Installation Proposals for SML

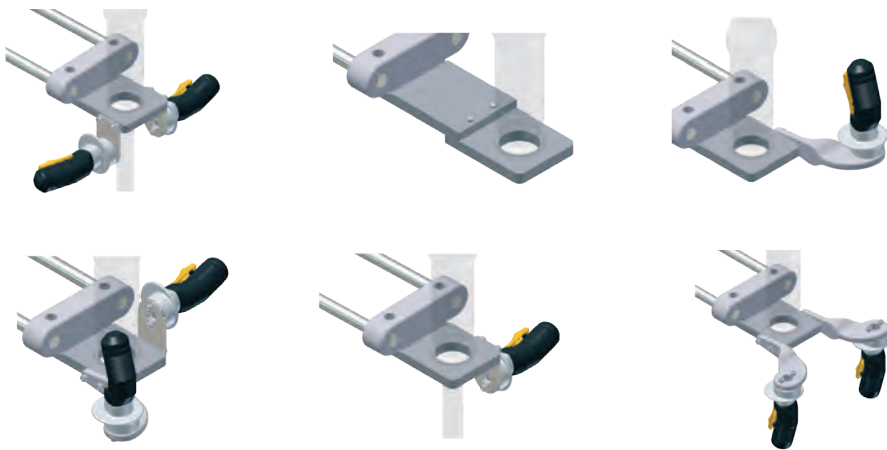

### OPTIONAL ACCESSORIES FOR SML/SMS T-SERIES, SML MK II AND SMF

Model	Description	Ordering No.
Pistol tool adapter – one axis	One axis swiveling adapter for tools up to 25 Nm	4390 2082 10
Pistol tool adapter – two axes	Two axes swiveling adapter for tools up to 25 Nm	4390 2082 30
Horizontal adapter (handle mount)		4390 1770 00
Vertical adapter (handle mount)		4390 1769 00
Start handle	(electric, 1 signal)	4390 1772 00
	(electric, 2 signal)	4390 1773 00
	(pneumatic)	4390 1771 00
Heavy duty start handles	(electric, 1 signal)	4390 1772 01
	(electric, 2 signal)	4390 1773 01
	(pneumatic)	4390 1771 01
Heavy duty handgrip (dead)		4390 1786 01
Handgrip (dead handle)		4390 1786 00
Remote start cable	3 m	4390 1774 00
	5 m	4390 1775 00
	10 m	4390 1776 00
Extension remote start cable	10 m	4390 1778 00
Y– piece connector (for 2 x electric handles)		4390 1777 00



Horizontal adapter



Start handle

**NOTE:** – For forward and reverse tool operation, a 2 signal handle is required (electric tools only).

## Optional Accessories for GHP MicroTorque

Description	Ordering No.
Adapter	
Adapter between GHP Mini and ETF 5, 10, 20	8432 0830 70
Adapter between GHP Mini and ETD M 03/05/10A	8432 0831 81
Adapter between GHP Small and ETF 50-200	8432 0830 72
Adapter between GHP Small and ETD M-40-250 L	8432 0830 73
Adapter between GHP Large and ETF 400, 500, 800	8432 0830 74
Universal adapter for GHP Small (LUM, EBL, DL, SL)	8432 0831 80
Handle	
Handle between GHP Mini and ETF 05, 10, 20	8432 0830 90
Handle between GHP Small and ETF 50, 100, 200	8432 0830 53
Handle between GHP Large and ETF 400, 500, 800	8432 0830 54
Swivling tool holder	
GHP Small and ETD M08-27 ABL V2	8432 0830 61
GHP Small and ETD M50-250 ABL V2	8432 0830 62

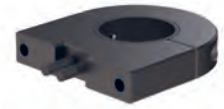

Swivling tool holder

### TOOL HOLSTER FOR PISTOL GRIP AND STRAIGHT TOOLS

Model	Ordering No.
Tool holster small, max tool width 45 mm	4220 3584 82
Tool holster large , max tool width 98 mm	4220 3584 86
Holster assembly	4220 3584 80
Tool holster BCP	4220 4335 80



Tool holster small

### MODULAR TOOL HOLDER FOR PISTOL TOOLS, ANGLE TOOLS AND GRINDERS

Model	Included parts	Ordering No.
Modular tool holder	A	4220 3584 83
Modular tool holder, rail kit	2 x A, B	4220 3584 84
Modular tool holder, stand kit	2 x A, B, C	4220 3584 85



Tool holster large

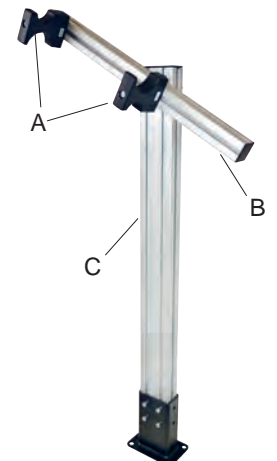

Modular tool holder

## COLIBRI – COL

Balancers in the unique COL range hold the load and keep it weightless throughout the entire cable length.

### PRODUCTIVITY

COL balancers always hold the tool in the correct position

### ERGONOMIC

COL balancers reduce the stress level in the operator's muscles.

### SAFETY

The load is not pulled back when released and the surroundings are protected from accidental hoisting of the load.

The cable locks in the event of spring failure (downward braking power).

In all models the braking function can be activated upwards by using the "bow and arrow" principle if you need to slacken the cable to change the tool.



Model	Capacity range		Cable length m	Weight		Dimensions			Ordering No.
	kg	lb		kg	lb	A mm	B mm	C mm	
COL 1 01	0.7-1.3	1.5-2.9	1.7	0.5	1.1	108	72	245	8202 0750 01
COL 1 02	1.0-2.0	2.2-4.4	1.7	0.5	1.1	108	72	245	8202 0750 19

NOTE: Comes with nylon cable.

## Dimensions

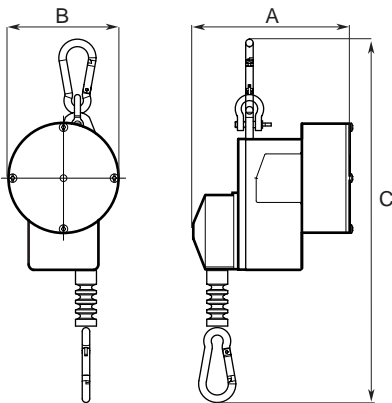

## Optional Accessories

### SAFETY CHAIN

	Ordering No.
COL 1	4391 4045 90

### RIL BALANCER

RIL balancers always keep the tool in place, handy and easily accessible. RIL balancers are available as retractors or weightless positioning balancers.

Safety chain included with all RIL balancers.

### RIL RETRACTORS

- Adjustable wire stop.
- High quality spring and construction.
- Load range 0 to 10 kg.



## Dimensions

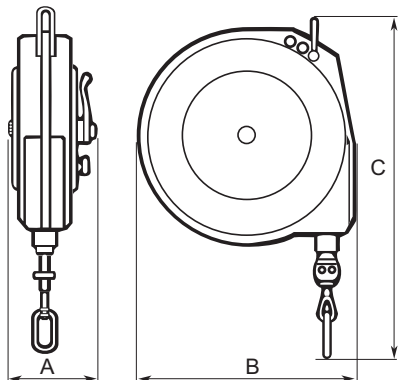

Model	Capacity range		Cable length m	Weight		Dimensions			Ordering No.
	kg	lb		kg	lb	A mm	B mm	C mm	
<b>Retractors</b>									
RIL 1C	0.0-0.5	0.0-1.7	1.5	0.6	1.3	51	106	238	8202 0700 02
RIL 2C	0.4-1.0	0.9-2.2	1.5	0.6	1.3	51	106	238	8202 0701 19
RIL 4C	1.0-2.0	2.2-4.4	1.5	0.6	1.3	51	106	238	8202 0702 18
RIL 5C	1.4-2.3	3.1-5.1	1.5	0.6	1.3	51	106	238	8202 0703 25
RIL 10C	2.0-5.0	4.4-11.0	2.4	2.7	6.0	84	190	369	8202 0704 16
RIL 10CS <sup>a</sup>	2.0-5.0	4.4-11.0	2.4	2.7	6.0	84	190	369	8202 0704 20
RIL 15C	5.0-7.0	11.0-15.4	2.4	3.2	7.1	84	190	369	8202 0705 15
RIL 15CS <sup>a</sup>	5.0-7.0	11.0-15.4	2.4	3.2	7.1	84	190	369	8202 0705 20
RIL 22C	6.0-10.0	13.2-22.0	2.4	3.2	7.1	84	190	369	8202 0706 14
RIL 22CS <sup>a</sup>	6.0-10.0	13.2-22.0	2.4	3.2	7.1	84	190	369	8202 0706 20

<sup>a</sup> Balancer equipped with automatic safety drum lock in case of spring failure.

**NOTE:** RIL 1C, 2C, 4C and 5C comes with nylon cable. All other models are equipped with steel wire.

## Accessories

### SAFETY CHAIN

	Ordering No.
1C, 2C, 4C and 5C	4391 4045 90
10C, 15C and 22C	4391 4156 00

## WP BALANCER

Weightless positioning balancers with a cone-shaped drum hold the load and keep it weightless throughout the entire cable length. The casing for WP 05/10 are in plastic, the WP 20 in aluminium and the WP 30 models are in abrasion resistant aluminium.

All models except for the WP 20 comes with a swiveling safety hook.

## PRODUCTIVITY

WP balancers always hold the tool in the correct position and minimize worker fatigue.

## ERGONOMIC

WP balancers reduce stress level in the operator's muscles.

## SAFETY

The load is not pulled back when released and the environment is protected from accidental hoisting of the load.

- Steel cable with cable stop buffer.
- Safety chain.
- Quick and easy cable replacement.
- Available with extended cable lengths for roof mounting. (A) -models



## Dimensions

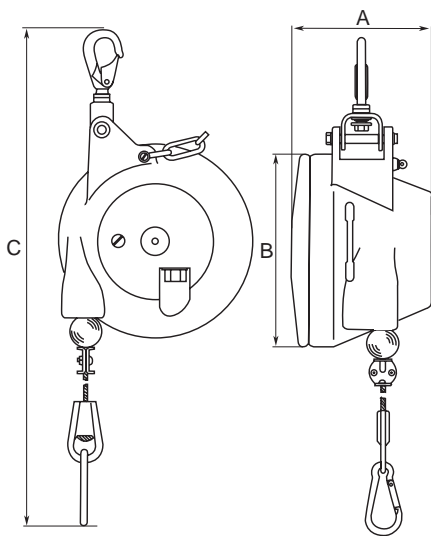

Model	Capacity range		Cable length		Weight		Dimension			Ordering No.
	kg	lb	m	ft	kg	lb	A mm	B mm	C mm	
<b>WP 05 - Standard</b>										
WP 05-1	0.4-1.2	0.9-2.6	2	6.5	1.3	2.9	71	141	460	8202 0778 00
WP 05-3	1.2-2.6	2.6-5.7	2	6.5	1.4	3.1	71	141	460	8202 0778 01
WP 05-4	2.6-3.8	5.7-8.4	2	6.5	1.5	3.3	71	141	460	8202 0778 02
WP 05-5	3.8-5.2	8.4-11.5	2	6.5	1.5	3.3	71	141	460	8202 0778 03
WP 05-6	5.2-6.5	11.5-14.3	2	6.5	1.5	3.3	71	141	460	8202 0778 04
<b>WP 05 - Extended Cable - A</b>										
WP 05-1-A	0.4-1.2	0.9-2.6	5.5	18	1.3	2.9	71	141	460	8202 0778 05
WP 05-3-A	1.2-2.6	2.6-5.7	5.5	18	1.4	3.1	71	141	460	8202 0778 06
WP 05-4-A	2.6-3.8	5.7-8.4	5.5	18	1.5	3.3	71	141	460	8202 0778 07
WP 05-5-A	3.8-5.2	8.4-11.5	5.5	18	1.5	3.3	71	141	460	8202 0778 08
WP 05-6-A	5.2-6.5	11.5-14.3	5.5	18	1.5	3.3	71	141	460	8202 0778 09
<b>WP 10 - Standard</b>										
WP 10-3	3-5	6.6-11	2	6.5	2.9	6.4	130	188	521	8202 0779 00
WP 10-4.5	4.5-7	10-15.4	2	6.5	3.1	6.8	130	188	521	8202 0779 01
WP 10-6	6-10	13-22	2	6.5	3.2	7.0	130	188	521	8202 0779 02
WP 10-9	9-14	20-31	2	6.5	3.4	7.5	130	188	521	8202 0779 03
WP 10-13	13-17	29-37	2	6.5	3.6	8.0	130	188	521	8202 0779 04
WP 10-16	16-21	35-46	2	6.5	3.8	8.4	130	188	521	8202 0779 05
<b>WP 10 - Extended Cable - A</b>										
WP 10-3-A	3-5	6.6-11	5.5	18	2.9	6.4	130	188	521	8202 0779 06
WP 10-4.5-A	4.5-7	10-15.4	5.5	18	3.1	6.8	130	188	521	8202 0779 07
WP 10-6-A	6-10	13-22	5.5	18	3.2	7.0	130	188	521	8202 0779 08
WP 10-9-A	9-14	20-31	5.5	18	3.4	7.5	130	188	521	8202 0779 09
WP 10-13-A	13-17	29-37	5.5	18	3.6	8.0	130	188	521	8202 0779 10
WP 10-16-A	16-21	35-46	5.5	18	3.8	8.4	130	188	521	8202 0779 11
<b>WP 20 - Standard</b>										
WP 20-15	15-25	33-55	2	6.5	7.8	17.2	152	218	521	8202 0780 00
WP 20-25	25-35	55-77	2	6.5	8.9	19.6	152	218	521	8202 0780 01
WP 20-35	35-45	77-99	2	6.5	9.5	21.0	152	218	521	8202 0780 02
WP 20-45	45-55	99-121	2	6.5	9.8	21.5	152	218	521	8202 0780 03
<b>WP 30 - Standard</b>										
WP 30-12	12-20	26-44	2	6.5	14.8	32.6	203	285	749	8202 0781 00
WP 30-20	20-30	44-66	2	6.5	15.2	33.5	203	285	749	8202 0781 01
WP 30-30	30-45	66-99	2	6.5	16.9	37.3	203	285	749	8202 0781 02
WP 30-45	45-60	99-132	2	6.5	17.3	38.1	203	285	749	8202 0781 03
WP 30-60	60-75	132-165	2	6.5	18.7	41.2	203	285	749	8202 0781 04
WP 30-75	75-90	165-198	2	6.5	19.7	43.4	203	285	749	8202 0781 05
WP 30-90	90-100	198-220	2	6.5	19.9	43.4	203	285	749	8202 0781 06
<b>WP 40 - Standard</b>										
WP 40-100	100-115	220-254	3	10	42.0	43.9	348	320	800	8202 0782 00
WP 40-115	115-130	254-287	3	10	44.0	97.0	348	320	800	8202 0782 01
WP 40-130	130-140	287-309	3	10	46.0	101	348	320	800	8202 0782 02
WP 40-140	140-150	309-331	3	10	48.0	106	348	320	800	8202 0782 03



A close-up, monochromatic blue-toned photograph of industrial machinery, specifically a large gear with several teeth visible. The lighting creates strong highlights and shadows, emphasizing the metallic texture and the precision of the gear's design. The background is blurred, showing other parts of the machinery.

# ***Fixtured applications***

## **Contents**

Introduction.....	156
Fixtured nutrunners QST.....	159
Fixtured presses PST.....	161
Power MACS.....	165
MSB, DB.....	166
Power Focus.....	169
ToolsTalk.....	170



# With our vast experience, we are a supplier you can rely on

*Atlas Copco is the world-leading supplier of fixtured solutions with nutrunners and press systems. Our vast experience of designing components for multiple nutrunner systems, combined with knowledge of building, commissioning and maintaining fixtured solutions, makes Atlas Copco a supplier you can rely on.*

For fixtured nutrunner systems, Atlas Copco offers a complete portfolio of products designed to satisfy your needs. These range from individual components to operator controlled Multiples by Express® stations and demanding stitching applications. There are two different systems designed for fixtured applications, as well as user-friendly controller software.

Please contact your local Atlas Copco sales representative who will be pleased to discuss your needs.

### **POWER MACS 4000 AND QST NUTRUNNERS**

A state-of-the-art, stand-alone system offering high reliability, accuracy and capability. The system is designed with user friendliness in mind and is easy to build and integrate into production lines.

### **POWER FOCUS 6000 AND QST NUTRUNNERS**

The newest Atlas Copco controller now can offer the possibility to run QST and battery handheld tools in one single controller, bringing even more flexibility and commonality.

### **POWER MACS 4000 AND PST PRESSES**

Design to be the most compact and efficient press in the market, PST system delivers both high productivity and full commonality with Power MACS 4000 systems.

### **TOOLSTALK SOFTWARE**

ToolsTalk software for Power MACS 4000 has been developed with user-friendliness and customer adaptation in mind. This Window-based program can be installed on a station PC, a laptop or a back office PC.



*Power MACS 4000 stand alone system – small, cost efficient and powerful. No need for bulky cabinets.*

## Nutrunners to match your needs

*The QST nutrunner is a true state-of-the-art product. Partnered with the Power Focus 6000 or the Power MACS 4000 tightening controller, QST offers one of the most advanced and reliable tightening solutions on the market.*

Designed specifically for fixtured systems, these reliable, durable nutrunners have many features.

With QST nutrunners pilot mount or sandwich are possible. Different socket holder lengths (0-200 mm) permit access to applications or parts with tight clearances. For longer bolt lengths, spring travel can be increased from the standard 50 mm to 76 or 100 mm on request.

A built-in memory chip in QST nutrunner stores calibration values and general tool and service data. The tools are ISO certified to +/- 2.5% accuracy and 1 million duty cycles on hard and soft joints.

### **QST NUTRUNNERS – FEATURES**

- Digital communication between nutrunner and controller.
- Hot Swap – replace cable or spindle without turning off the power.
- Increased speed characteristics, up to 3,000 rpm.
- Optional redundant angle encoder and transducer.
- MTBF better than 5 million cycles under normal conditions.

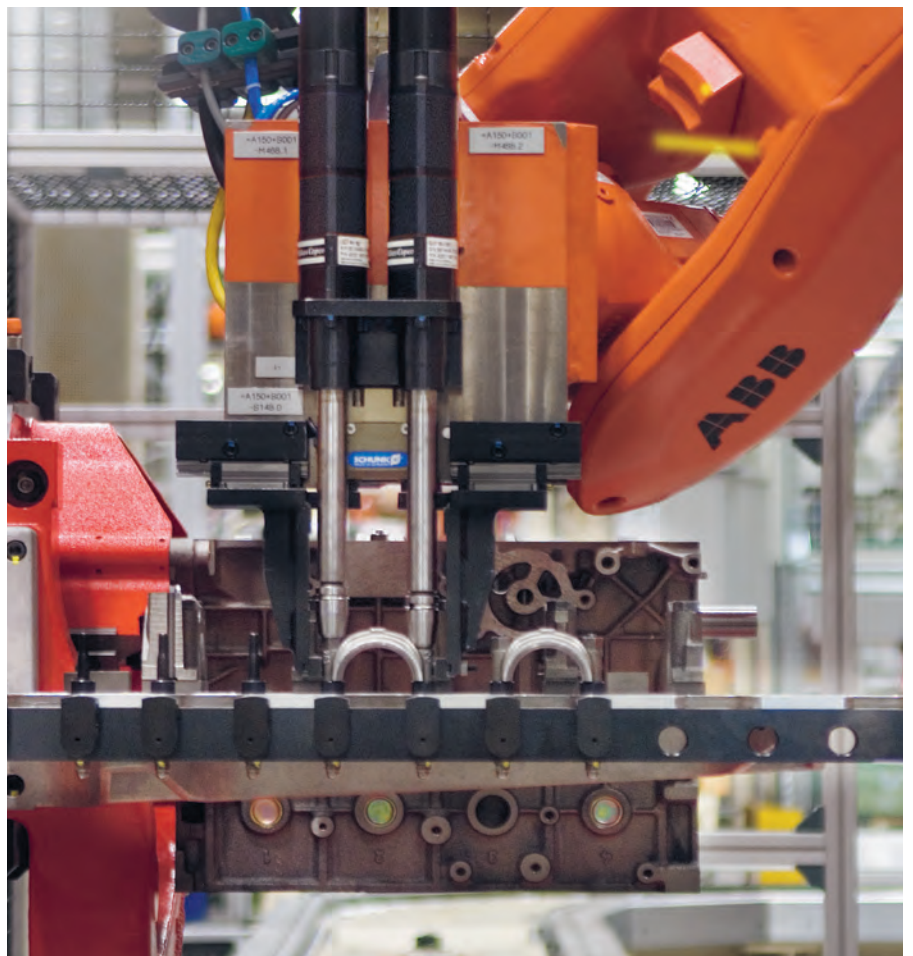

- Inline nutrunner, CT – Equipped with commutation sensor and transducer.
- Off-set nutrunner, COT – Comes with a commutation sensor, off-set gears for narrow bolts and transducer.
- Extended spring travel 76 mm and 100 mm – Nutrunners with extended spring travel for longer bolt lengths.
- Dual transducers, CTT – Nutrunners with dual torque transducer feedback.
- Dual transducers and angle feedback, CATT – Nutrunners with dual angle and torque transducer feedback.
- Angle head nutrunners, CTV – Nutrunners with angle heads. Available with or without travel.



QST COT



QST CT

Model	Travel mm	Torque range		Speed r/min	Min C-C	Weight		Gear ratio	Socket holder size in	Ordering No.
		Nm	ft lb			kg	lb			
QST34-8CT-T50-L150-H6	50	2-8	1.5-6	3000	34	2	4.4	7.428	1/4	8435 6000 10
QST34-20CT-T50-L150-H10	50	4-20	2.9-14.7	1000	34	2	4.4	21.2	3/8	8435 6010 10
QST42-20CT-T50-L134-H10	50	6-20	4-14	2000	43	3.1	6.9	7.50	3/8	8435 6020 10
QST42-20COT-T50-L134-H10	50	6-20	4-14	2000	31	4.2	9.3	7.5	3/8	8435 6020 20
QST42-50CT-T50-L134-H13	50	10-50	7-35	700	43	3.8	8.4	21.33	1/2	8435 6030 10
QST42-50COT-T50-L134-H13	50	10-50	7-35	700	31	4.5	9.9	21.33	1/2	8435 6030 20
QST50-90CT-T50-L137-H13	50	20-90	15-65	650	51	5.8	12.7	18.21	1/2	8435 6040 10
QST50-90COT-T50-L137-H13	50	20-90	15-65	650	37	7.8	17.2	18.21	1/2	8435 6040 20
QST50-150CT-T50-L137-H13	50	30-150	22-110	380	51	5.8	12.8	31.24	1/2	8435 6050 10
QST50-150COT-T50-L137-H13	50	30-150	22-110	380	37	7.8	17.2	31.24	1/2	8435 6050 20
QST62-150CT-T50-L152-H13	50	30-150	22-110	450	63	10.2	22.5	13.94	1/2	8435 6060 10
QST62-150COT-T50-L152-H13	50	30-150	22-110	450	45	12.8	28.2	13.94	1/2	8435 6060 20
QST62-230CT-T50-L152-H19	50	40-230	29-170	330	63	10.2	22.5	19.04	3/4	8435 6065 10
QST62-230COT-T50-L152-H19	50	40-220	29-162	330	45	12.8	28.2	19.04	3/4	8435 6065 20
QST62-350CT-T50-L152-H19	50	50-350	37-258	220	63	10.2	22.5	28.33	3/4	8435 6070 10
QST62-350COT-T50-L152-H19	50	50-330	37-243	220	45	12.8	28.2	28.33	3/4	8435 6070 20
QST80-450CT-T50-L146-H19	50	90-450	66-332	260	81	16.7	37	22.67	3/4	8435 6075 10
QST80-450COT-T50-L146-H19	50	90-450	66-332	260	55	21	46	22.67	3/4	8435 6075 20
QST80-600CT-T50-L146-H19	50	120-600	88-442	200	81	17	37	29.56	3/4	8435 6080 10
QST80-600COT-T50-L146-H19	50	120-600	88-442	200	55	21	46	29.56	3/4	8435 6080 20
QST90-750CT-T50-L152-H25	50	150-750	111-553	150	91	25	55	38.89	1	8435 6085 10
QST90-750COT-T50-L152-H25	50	150-750	111-553	150	63	29	64	38.89	1	8435 6085 20
QST90-1000CT-T50-L152-H25	50	200-1000	147-737	130	91	26	57	46.84	1	8435 6090 10
QST90-1000COT-T50-L152-H25	50	200-1000	147-737	130	63	30	66	46.84	1	8435 6090 20
QST95-1750CT-T50-L149-H38	50	350-1750	258-1291	60	96	28	61.7	98.21	1 1/2	8435 6095 10
QST95-1750COT-T50-L155-H38	50	350-1750	258-1291	60	73	43	94.8	98.21	1 1/2	8435 6095 20
<b>Extended spring travel 76 mm and 100 mm</b>										
QST42-20CT-T76-L189-H10	76	6-20	4-14	2000	43	3.1	6.9	7.5	3/8	8435 6020 11
QST42-50CT-T76-L189-H13	76	10-50	7-35	700	43	3.8	8.4	21.3	1/2	8435 6030 11
QST50-90CT-T76-L200-H13	76	20-90	15-65	650	51	5.8	12.7	18.2	1/2	8435 6040 11
QST50-150CT-T76-L200-H13	76	30-150	22-110	380	51	5.8	12.8	31.2	1/2	8435 6050 11
QST62-230CT-T76-L200-H19	76	40-230	29-170	330	63	10.2	22.5	19	3/4	8435 6065 11
QST62-350CT-T76-L200-H19	76	50-350	37-258	220	63	10.2	22.5	28.3	3/4	8435 6070 11
QST80-450CT-T76-L214-H19	76	90-450	66-332	260	81	17	37	22.67	3/4	8435 6075 11
QST80-600CT-T76-L214-H19	76	120-600	88-442	200	81	17	37	29.6	3/4	8435 6080 11
QST90-750CT-T76-L176-H25	76	150-750	111-553	150	63	29	64	38.89	1	8435 6085 11
QST90-1000CT-T76-L176-H25	76	200-1000	147-737	130	91	26	57	46.8	1	8435 6090 11
QST42-50CT-T100-L191-H13	100	10-50	7-35	700	43	3.8	8.4	21.3	1/2	8435 6030 12
QST50-150CT-T100-L186-H13	100	30-150	22-110	380	51	5.8	12.8	31.2	1/2	8435 6050 12

Continued...

Model	Travel mm	Torque range		Speed r/min	Min C-C	Weight		Gear ratio	Socket holder size in	Ordering No.
		Nm	ft lb			kg	lb			
<b>Dual transducers, CTT</b>										
QST42-20CTT-T50-L134-H10	50	6-20	4-14	2000	43	3.1	6.9	7.5	3/8	8435 6020 50
QST42-20COTT-T50-L134-H10	50	6-20	4-14	2000	31	4.2	9.3	7.5	3/8	8435 6020 60
QST42-50CTT-T50-L134-H13	50	10-50	7-35	700	43	3.8	8.4	21.33	1/2	8435 6030 50
QST42-50COTT-T50-L134-H13	50	10-50	7-35	700	31	4.5	9.9	21.33	1/2	8435 6030 60
QST50-90CTT-T50-L137-H13	50	20-90	15-65	650	51	5.8	12.7	18.21	1/2	8435 6040 50
QST50-90COTT-T50-L137-H13	50	20-90	15-65	650	37	7.8	17.2	18.21	1/2	8435 6040 60
QST50-150CTT-T50-L137-H13	50	30-150	22-110	380	51	5.8	12.8	31.24	1/2	8435 6050 50
QST50-150COTT-T50-L137-H13	50	30-150	22-110	380	37	7.8	17.2	31.24	1/2	8435 6050 60
QST62-150CTT-T50-L152-H13	50	30-150	22-110	450	63	10.2	22.5	13.94	1/2	8435 6060 50
QST62-150COTT-T50-L152-H13	50	30-150	22-110	450	45	12.8	28.2	13.94	1/2	8435 6060 60
QST62-230CTT-T50-L152-H19	50	40-230	29-170	330	63	10.2	22.5	19.04	3/4	8435 6065 50
QST62-230COTT-T50-L152-H19	50	40-220	29-162	330	45	12.8	28.2	19.04	3/4	8435 6065 60
QST62-350CTT-T50-L152-H19	50	50-350	37-258	220	63	10.2	22.5	28.33	3/4	8435 6070 50
QST62-350COTT-T50-L152-H19	50	50-330	37-243	220	45	12.8	28.2	28.33	3/4	8435 6070 60
QST80-450CTT-T50-L146-H19	50	90-450	66-332	260	81	16.7	37	22.67	3/4	8435 6075 50
QST80-450COTT-T50-L146-H19	50	90-450	66-332	260	55	21	46	22.67	3/4	8435 6075 60
QST80-600CTT-T50-L146-H19	50	120-600	88-442	200	81	17	37	29.56	3/4	8435 6080 50
QST80-600COTT-T50-L146-H19	50	120-600	88-442	200	55	21	46	29.56	3/4	8435 6080 60
QST90-750CTT-T50-L152-H25	50	150-750	111-553	150	91	25	55	38.89	1	8435 6085 50
QST90-750COTT-T50-L152-H25	50	150-750	111-553	150	63	29	64	38.89	1	8435 6085 60
QST90-1000CTT-T50-L152-H25	50	200-1000	147-737	130	91	26	57	46.84	1	8435 6090 50
QST90-1000COTT-T50-L152-H25	50	200-1000	147-737	130	63	30	66	46.84	1	8435 6090 60
<b>Dual transducers and angle feedback, CATT</b>										
QST42-20CATT-T50-L134-H10	50	6-20	4-14	2000	43	3.1	6.9	7.5	3/8	8435 6020 70
QST42-50CATT-T50-L134-H13	50	10-50	7-35	700	43	3.8	8.4	21.33	1/2	8435 6030 70
QST50-90CATT-T50-L137-H13	50	20-90	15-65	650	51	5.8	12.7	18.21	1/2	8435 6040 70
QST50-150CATT-T50-L137-H13	50	30-150	22-110	380	51	5.8	12.8	31.24	1/2	8435 6050 70
QST62-150CATT-T50-L152-H13	50	30-150	22-110	450	63	10.2	22.5	13.94	1/2	8435 6060 70
QST62-230CATT-T50-L152-H19	50	40-230	29-170	330	63	10.2	22.5	19.04	3/4	8435 6065 70
QST62-350CATT-T50-L152-H19	50	50-350	37-258	220	63	10.2	22.5	28.33	3/4	8435 6070 70
QST80-450CATT-T50-L146-H19	50	90-450	66-332	260	81	16.7	36.9	22.67	3/4	8435 6075 70
QST80-600CATT-T50-L146-H19	50	120-600	88-442	200	81	17	37	29.56	3/4	8435 6080 70
QST90-750CATT-T50-L152-H25	50	150-750	111-553	150	91	25	55	38.89	1	8435 6085 70
QST90-1000CATT-T50-L152-H25	50	200-1000	147-737	130	91	26	57	46.84	1	8435 6090 70
<b>Angle head, CTV</b>										
QST42-20CTV-P10		6-20	4-14	1200	28	3.5	7	11.6	3/8	9831 4077 27
QST42-20CTV-T25-H10	25	6-20	4-14	1200	28	5	11	11.6	3/8	9831 4077 57
QST42-30CTV-P10		6-30	4.5-22	440	36	3.5	7	11.6	3/8	9831 4077 26
QST42-30CTV-T25-H10	25	6-30	4.5-22	440	36	5.5	12	33	3/8	9831 4077 58
QST42-70CTV-P13		14-70	10-52	440	40	4.5	10	33	1/2	9831 4077 28
QST42-70CTV-T25-H13	25	14-70	10-52	450	40	5.5	12	33	1/2	9831 4077 59
QST50-170CTV-P13		34-170	25-125	210	52	6.8	15	56.2	1/2	9831 4078 38
QST50-170CTV-T50-H13	50	34-170	25-125	210	48	8.6	19	56.2	1/2	9831 4078 44
QST50-200CTV-H19		40-200	29-145	210	54	7	15	56.2	3/4	9831 4078 43
QST50-200CTV-T25-H19	25	40-200	29-145	210	54	9.5	21	56.2	3/4	9831 4078 46
QST50-200CTV-T50-H19	50	40-200	29-145	210	58	10	22	56.2	3/4	9831 4078 47
QST62-350CTV-H19		60-350	44-229	175	66	13.5	30	34.3	3/4	9831 4079 73
QST62-350CTV-T25-H19	25	60-350	44-229	175	67	16.5	36	34.3	3/4	9831 4087 10
QST62-600CTV-H25		120-600	88-440	100	109	16.5	33	93.5	1	9831 4087 02



## Dimensions

Model	A mm	B mm	C mm	D mm	E mm
<b>Standard</b>					
QST34-8CT-T50-L150-H6	150	16	359	10	–
QST34-20CT-T50-L150-H10	150	16	359	10	–
QST42-20CT-T50-L134-H10	134	23	395	15	–
QST42-20COT-T50-L134-H10	134.5	–	–	–	446
QST42-50CT-T50-L134-H13	134	23	422	15	–
QST42-50COT-T50-L134-H13	134.5	–	–	–	472
QST50-90CT-T50-L137-H13	137	23	464	15	–
QST50-90COT-T50-L137-H13	137	–	–	–	521
QST50-150CT-T50-L137-H13	137	23	464	15	–
QST50-150COT-T50-L137-H13	137	–	–	–	521
QST62-150CT-T50-L152-H13	152	25	517	15	–
QST62-150COT-T50-L152-H13	152.5	–	–	–	586
QST62-230CT-T50-L152-H19	152	25	517	15	–
QST62-230COT-T50-L152-H19	152.5	–	–	–	586
QST62-350CT-T50-L152-H19	152	25	517	15	–
QST62-350COT-T50-L152-H19	152	–	–	–	592
QST80-450CT-T50-L146-H19	146	30	595	20	–
QST80-450COT-T50-L146-H19	146	–	–	–	685
QST80-600CT-T50-L146-H19	146	30	595	20	–
QST80-600COT-T50-L146-H19	146	–	–	–	685
QST90-750CT-T50-L152-H25	152	32	600	20	–
QST90-750COT-T50-L152-H25	153	–	–	–	705
QST90-1000CT-T50-L152-H25	152	32	600	20	–
QST90-1000COT-T50-L152-H25	153	–	–	–	710
QST95-1750CT-T50-L149-H38	149	32	651	20	–
QST95-1750COT-T50-L155-H38	155	–	–	–	796

Model	A mm	B mm	C mm	D mm	E mm
<b>Dual transducers and angle feedback, CATT</b>					
QST42-20CATT-T50-L134-H10	134	23	395	15	–
QST42-50CATT-T50-L134-H13	134	23	422	15	–
QST50-90CATT-T50-L137-H13	137	23	464	15	–
QST50-150CATT-T50-L137-H13	137	23	464	15	–
QST62-150CATT-T50-L152-H13	152	25	542	15	–
QST62-230CATT-T50-L152-H19	152	25	542	15	–
QST62-350CATT-T50-L152-H19	152	25	542	15	–
QST80-450CATT-T50-L146-H19	146	30	595	20	–
QST80-600CATT-T50-L146-H19	146	30	595	20	–
QST90-750CATT-T50-L152-H25	152	32	600	20	–
QST90-1000CATT-T50-L152-H25	152	32	600	20	–
<b>Angle head</b>					
QST42-20CTV-P10	65	–	–	8	409
QST42-20CTV-T25-H10	–	–	–	–	–
QST42-30CTV-P10	83	–	–	8	435
QST42-30CTV-T25-H10	–	–	–	–	525
QST42-70CTV-P13	84	–	–	15	432
QST42-70CTV-T25-H13	–	–	–	–	526
QST50-170CTV-P13	135	–	–	15	481
QST50-170CTV-T50-H13	–	–	–	–	–
QST50-200CTV-H19	135	–	–	15	481
QST50-200CTV-T25-H19	135	–	–	15	481
QST50-200CTV-T50-H19	135	–	–	15	481
QST62-350CTV-H19	153	–	–	14	564
QST62-350CTV-T25-H19	153	–	–	14	564
QST62-600CTV-H25	174	–	–	14	564

Model	A mm	B mm	C mm	D mm	E mm
<b>Extended spring travel 76 mm and 100 mm</b>					
QST42-20CT-T76-L189-H10	189	23	421	15	–
QST42-50CT-T76-L189-H13	189	23	447	15	–
QST50-90CT-T76-L200-H13	200	25	493	15	–
QST50-150CT-T76-L200-H13	200	25	493	15	–
QST62-230CT-T76-L200-H19	200	25	543	15	–
QST62-350CT-T76-L200-H19	200	25	543	15	–
QST80-450CT-T76-L214-H19	214	43	595	20	–
QST80-600CT-T76-L214-H19	214	43	595	20	–
QST90-750CT-T76-L176-H25	176	32	600	20	–
QST90-1000CT-T76-L176-H25	176	32	650	20	–
QST42-50CT-T100-L191-H13	191	23	519	15	–
QST50-150CT-T100-L186-H13	186	23	563	15	–
<b>Dual transducers, CTT</b>					
QST42-20CTT-T50-L134-H10	134	23	395	15	–
QST42-20COTT-T50-L134-H10	134	–	–	–	446
QST42-50CTT-T50-L134-H13	134	23	422	15	–
QST42-50COTT-T50-L134-H13	134	–	–	–	472
QST50-90CTT-T50-L137-H13	137	23	464	15	–
QST50-90COTT-T50-L137-H13	137	–	–	–	521
QST50-150CTT-T50-L137-H13	137	23	464	15	–
QST50-150COTT-T50-L137-H13	137	–	–	–	521
QST62-150CTT-T50-L152-H13	152	25	542	15	–
QST62-150COTT-T50-L152-H13	137	–	–	–	521
QST62-230CTT-T50-L152-H19	152	25	542	15	–
QST62-230COTT-T50-L152-H19	152.5	–	–	–	586
QST62-350CTT-T50-L152-H19	152	25	542	15	–
QST62-350COTT-T50-L152-H19	152	–	–	–	592
QST80-450CTT-T50-L146-H19	146	30	595	20	–
QST80-450COTT-T50-L146-H19	146	–	–	–	685
QST80-600CTT-T50-L146-H19	146	30	595	20	–
QST80-600COTT-T50-L146-H19	146	–	–	–	685
QST90-750CTT-T50-L152-H25	146	30	595	20	–
QST90-750COTT-T50-L152-H25	103	–	–	–	706
QST90-1000CTT-T50-L152-H25	152	32	600	20	–
QST90-1000COTT-T50-L152-H25	153	–	–	–	710

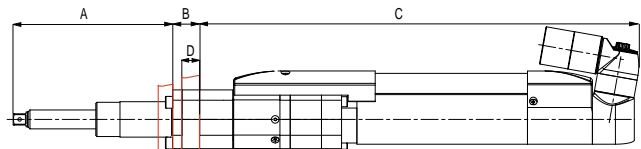

CT – straight version

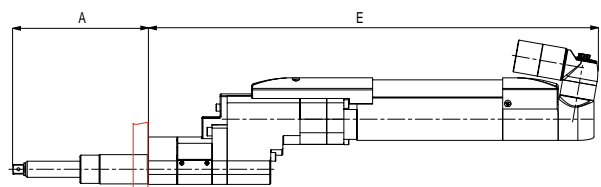

COT – off-set version

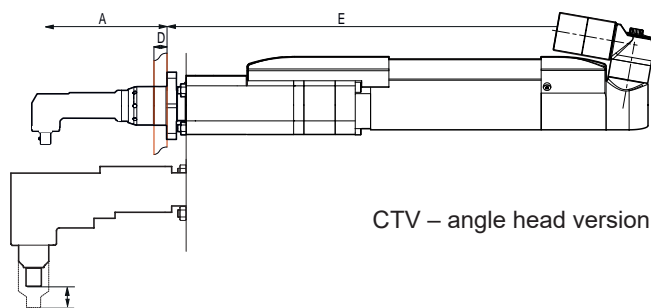

CTV – angle head version

- Lean and compact, PST press is equipped with the latest planetary roller screw capable to handle high speeds, accelerations and decelerations.
- High accuracy and precise load readings thanks to load cell on outgoing shaft.
- Unique and compact mechanical gear unit delivering higher durability level compared to the market belt system.
- PST can be ordered in a brake version. The brake can be used as parking or as holding brake.
- Commonality through the standard and robust QST motor and smart cable connector which can be turned in 2 directions of freedom.



PST

Model	Push force		Pull force		Stroke mm	Speed mm/s	Weight		Min C-C distance mm	Ordering No.
	kN	KLBS	kN	KLBS			kg	lb		
PST5-200CUL	1-5	0.22-1.12	2	0.45	200	500	14.5	31.97	70	9831 4069 31
PST5-200CBUL	1-5	0.22-1.12	2	0.45	200	500	15.5	34.17	70	9831 4069 32
PST5-300CUL	1-5	0.22-1.12	2	0.45	300	500	16.5	36.38	70	9831 4069 33
PST5-300CBUL	1-5	0.22-1.12	2	0.45	300	500	17.5	38.58	70	9831 4069 34
PST5-200CUL -S	1-5	0.22-1.12	4	0.90	200	250	21.0	46.30	77	8435 4069 31
PST5-200CBUL -S	1-5	0.22-1.12	4	0.90	200	250	23.0	50.71	88	8435 4069 32
PST5-400CUL -S	1-5	0.22-1.12	4	0.90	400	250	25.0	55.12	77	8435 4069 33
PST5-400CBUL -S	1-5	0.22-1.12	4	0.90	400	250	27.0	59.52	88	8435 4069 34
PST10-50CUL	2-10	0.45-2.25	2	0.45	50	500	12.0	26.46	71	9831 4069 82
PST10-100CUL	2-10	0.45-2.25	2	0.45	100	500	13.0	28.66	71	9831 4069 81
PST10-200CUL	2-10	0.45-2.25	2	0.45	200	500	14.5	31.97	71	9831 4069 62
PST10-200CBUL	2-10	0.45-2.25	2	0.45	200	500	15.5	34.17	86	9831 4069 78
PST10-300CUL	2-10	0.45-2.25	2	0.45	300	500	16.5	36.38	71	9831 4069 64
PST10-300CBUL	2-10	0.45-2.25	2	0.45	300	500	17.5	38.58	86	9831 4069 67
PST10-200CUL -S	2-10	0.45-2.25	4	0.90	200	250	21.0	46.30	77	8435 4069 62
PST10-200CBUL-S	2-10	0.45-2.25	4	0.90	200	250	23.0	50.71	88	8435 4069 78
PST10-400CUL-S	2-10	0.45-2.25	4	0.90	400	250	25.0	55.12	77	8435 4069 64
PST10-400CBUL-S	2-10	0.45-2.25	4	0.90	400	250	27.0	59.52	88	8435 4069 67
PST20-200CUL-S	4-20	0.90-4.50	4	0.90	200	250	21.0	46.30	77	8435 4069 60
PST20-200CBUL-S	4-20	0.90-4.50	4	0.90	200	250	23.0	50.71	88	8435 4069 77
PST20-400CUL-S	4-20	0.90-4.50	4	0.90	400	250	25.0	55.12	77	8435 4069 63
PST20-400CBUL-S	4-20	0.90-4.50	4	0.90	400	250	27.0	59.52	88	843 54069 66
PST35-200CUL	7-35	1.57-7.87	7	1.57	200	255	44.0	97.00	90	9831 4069 48
PST35-200CBUL	7-35	1.57-7.87	7	1.57	200	255	59.0	130.07	90	9831 4069 42
PST35-400CUL	7-35	1.57-7.87	7	1.57	400	255	48.0	105.82	90	9831 4069 49
PST35-400CBUL	7-35	1.57-7.87	7	1.57	400	255	64.0	141.09	90	9831 4069 45
PST35-200CUL-S	7-35	1.57-7.87	10	2.25	200	170	44.0	97.00	105	8435 4069 48
PST35-200CBUL-S	7-35	1.57-7.87	10	2.25	200	170	59.0	130.07	105	8435 4069 42
PST35-400CUL-S	7-35	1.57-7.87	10	2.25	400	170	48.0	105.82	105	8435 4069 49
PST35-400CBUL-S	7-35	1.57-7.87	10	2.25	400	170	64.0	141.09	105	8435 4069 45
PST50-200CUL-S	10-50	2.25-11.24	10	2.25	200	170	50.0	110.23	105	8435 4069 84
PST50-200CBUL-S	10-50	2.25-11.25	10	2.25	200	170	58.0	127.87	105	8435 4069 43
PST50-400CUL-S	10-50	2.25-11.26	10	2.25	400	170	57.0	125.66	105	8435 4069 44
PST50-400CBUL-S	10-50	2.25-11.27	10	2.25	400	170	65.0	143.30	105	8435 4069 79
PST100-200CUL-S	20-100	4.50-22.50	20	4.50	200	130	180.0	396.83	192	8435 4069 40
PST100-200CBUL-S	20-100	4.50-22.50	20	4.50	200	130	200.0	440.92	192	8435 4069 39
PST100-400CUL-S	20-100	4.50-22.50	20	4.50	400	130	200.0	440.92	192	8435 4069 35
PST100-400CBUL-S	20-100	4.50-22.50	20	4.50	400	130	220.0	485.01	192	8435 4069 36

Dimensions

Model	A mm	B mm	AB mm	C mm	D mm	DB mm	E mm
PST5-200CUL	491	329	(-)	168	70	(-)	27
PST5-200CBUL	491	329	553	168	70	85	27
PST5-300CUL	591	329	(-)	168	70	(-)	27
PST5-300CBUL	591	329	653	168	70	85	27
PST5-200CUL -S	508	390	(-)	198	76	(-)	28.5
PST5-200CBUL -S	508	390	570	198	76	87	28.5
PST5-400CUL -S	708	390	(-)	198	76	(-)	28.5
PST5-400CBUL -S	708	390	770	198	76	87	28.5
PST10-50CUL	341	329	(-)	168	70	(-)	27
PST10-100CUL	391	329	(-)	168	70	(-)	27
PST10-200CUL	491	329	(-)	168	70	(-)	27
PST10-200CBUL	491	329	553	168	70	85	27
PST10-300CUL	591	329	(-)	168	70	(-)	27
PST10-300CBUL	591	329	553	168	70	85	27
PST10-200CUL -S	508	390	(-)	198	76	(-)	28.5
PST10-200CBUL-S	508	390	570	198	76	87	28.5
PST10-400CUL-S	708	390	(-)	198	76	(-)	28.5
PST10-400CBUL-S	708	390	770	198	76	87	28.5
PST20-200CUL-S	508	390	(-)	198	76	(-)	28.5
PST20-200CBUL-S	508	390	570	198	76	87	28.5
PST20-400CUL-S	708	390	(-)	198	76	(-)	28.5
PST20-400CBUL-S	708	390	770	198	76	87	28.5
PST35-200CUL	612.5	498	(-)	244	90	(-)	56
PST35-200CBUL	612.5	498	732	244	90	178	56
PST35-400CUL	812.5	498	(-)	244	90	(-)	56
PST35-400CBUL	812.5	498	932	244	90	178	56
PST35-200CUL-S	612.5	498	(-)	245	105	(-)	56
PST35-200CBUL-S	612.5	498	763	245	105	178	56
PST35-400CUL-S	812.5	498	(-)	245	105	(-)	56
PST35-400CBUL-S	812.5	498	963	245	105	178	56
PST50-200CUL-S	612.5	498	(-)	245	105	(-)	56
PST50-200CBUL-S	612.5	498	763	245	105	178	56
PST50-400CUL-S	812.5	498	(-)	245	105	(-)	56
PST50-400CBUL-S	812.5	498	963	245	105	178	56
PST100-200CUL-S	869	476	(-)	350	192	(-)	85
PST100-200CBUL-S	869	476	953	350	192	192	85
PST100-400CUL-S	1069	476	(-)	350	192	(-)	85
PST100-400CBUL-S	1069	476	1153	350	192	192	85

NAMING CONVENTION

Example: PST 10-200CBUL

- 10 Maximum pushig load kN
- 200 Maximum stroke length in mm
- C Commutation sensor
- B Brake
- U U-shaped gear set
- L Load cell

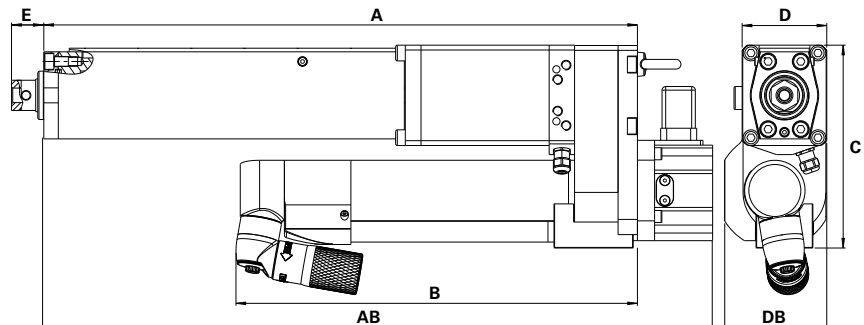

## ADDITIONAL SOCKET HOLDERS FOR QST



A mm	Product No.	Socket holder size in	Socket holder <sup>a</sup> Ordering No.
<b>QST42-20CT</b>			
0 <sup>b</sup>	8435 6020 10	3/8	4230 1818 00
50	8435 4083 08	3/8	4230 2217 00
100	8435 4083 10	3/8	4230 2217 01
150	8435 4083 12	3/8	4230 2217 02
200	8435 4083 14	3/8	4230 2217 03
<b>QST42-50CT</b>			
0 <sup>b</sup>	8435 6030 10	1/2	4230 1819 00
50	8435 4083 19	1/2	4230 2218 00
100	8435 4083 21	1/2	4230 2218 01
150	8435 4083 23	1/2	4230 2218 02
200	8435 4083 25	1/2	4230 2218 03
<b>QST50-90CT</b>			
0 <sup>b</sup>	8435 6040 10	1/2	4230 1820 00
50	8435 4083 28	1/2	4230 2219 00
100	8435 4083 29	1/2	4230 2219 01
150	8435 4083 30	1/2	4230 2219 02
200	8435 4083 31	1/2	4230 2219 03

<sup>a</sup> This socket holder is included when you order the complete spindle.

<sup>b</sup> This socket holder follows when you order the standard nutrunner.

A mm	Product No.	Socket holder size in	Socket holder <sup>a</sup> Ordering No.
<b>QST50-150CT</b>			
0 <sup>b</sup>	8435 6050 10	1/2	4230 1820 00
50	8435 4083 68	1/2	4230 2219 00
100	8435 4083 33	1/2	4230 2219 01
150	8435 4083 34	1/2	4230 2219 02
200	8435 4083 35	1/2	4230 2219 03
<b>QST62-150CT</b>			
0 <sup>b</sup>	8435 6060 10	1/2	4230 1829 00
50	8435 4083 37	1/2	4230 2223 00
100	8435 4083 40	1/2	4230 2223 01
150	8435 4083 43	1/2	4230 2223 02
200	8435 4083 46	1/2	4230 2223 03
0	8435 4083 70	5/8	4230 1821 00
50	8435 4083 38	5/8	4230 2224 00
100	8435 4083 41	5/8	4230 2224 01
150	8435 4083 44	5/8	4230 2224 02
200	8435 4083 47	5/8	4230 2224 03

**NOTE:** The spindle travel is 50 mm for all sockets holders.

A mm	Product No.	Socket holder size in	Socket holder <sup>a</sup> Ordering No.
<b>QST62-230CT</b>			
0	8435 4083 81	5/8	4230 1821 00
50	8435 4083 83	5/8	4230 2224 00
100	8435 4083 98	5/8	4230 2224 01
150	8435 4083 88	5/8	4230 2224 02
200	8435 4083 91	5/8	4230 2224 03
0 <sup>b</sup>	8435 5170 10	3/4	4230 1822 00
50	8435 4083 84	3/4	4230 2226 00
100	8435 4083 86	3/4	4230 2226 01
150	8435 4083 89	3/4	4230 2226 02
200	8435 4083 92	3/4	4230 2226 03
<b>QST62-350CT</b>			
0	8435 4083 72	5/8	4230 1821 00
50	8435 4083 53	5/8	4230 2224 00
100	8435 4083 56	5/8	4230 2224 01
150	8435 4083 59	5/8	4230 2224 02
200	8435 4083 62	5/8	4230 2224 03
0 <sup>b</sup>	8435 6070 10	3/4	4230 1822 00
50	8435 4083 54	3/4	4230 2226 00
100	8435 4083 57	3/4	4230 2226 01
150	8435 4083 60	3/4	4230 2226 02
200	8435 4083 63	3/4	4230 2226 03

## QST CABLES AND EXTENSIONS FOR POWER FOCUS 6000

Length	Ordering No.
2 m	4220 4715 02
3 m	4220 4715 03
5 m	4220 4715 05
7 m	4220 4715 07
10 m	4220 4715 10
15 m	4220 4715 15

## QST AND PST CABLES AND EXTENSIONS FOR POWER MACS 4000

Length	Ordering No.
2 m	4220 3799 02
3 m	4220 3799 03
5 m	4220 3799 05
7 m	4220 3799 07
10 m	4220 3799 10
15 m	4220 3799 15
20 m	4220 3799 20
25 m	4220 3799 25
30 m	4220 3799 30
35 m	4220 3799 35
40 m	4220 3799 40



Cable and extension

## PRESS TOOL ADAPTER FOR PST

Model	Ordering No.
<b>Press tool adapter</b>	
PST 5/10/20	4232 0125 90
PST 35	4232 0125 92
PST 50/100	4232 0125 93

## CALIBRATION LOAD CELL FOR PST

Model	Ordering No.
<b>Force transducer</b>	
10 kN	4232 6390 90
20 kN	4232 6391 90
50 kN	4232 6392 90
100 kN	4232 7401 90
200 kN	4232 7402 90
500 kN	4232 7403 90

## BRAKE CONTROL MODULE

Model	Ordering No.
Brake control module	4232 5952 80

### Advanced process control and monitoring

*State-of-the-art tightening controllers Power MACS 4000 and Power Focus with their advanced process control and monitoring functions, and supported by ToolsTalk software, can put your assembly operation on the path to zero-fault production.*

#### **POWER FOCUS 6000**

The Power Focus 6000 is the perfect choice for safety critical assembly processes. It comes in one single hardware version regardless of which tool model or functionality level is used. Power Focus 6000 offers the possibility to run battery tools and the QST nutrunner, one of the most advanced and reliable tightening solutions on the market, in one single controller.

#### **POWER MACS 4000**

Power MACS 4000 is Atlas Copco's tightening and pressing controller for fixtured tools. It has effective tools for statistical process control to ensure that quality issues are identified long before they cause production problems.

The controller supports a zero-fault production philosophy with its capacity to collect tightening and pressing data for analysis, continuous improvement and traceability. PowerMACS processing power and memory are designed to handle and send large amounts of data without influencing the tightening process.

#### **TOOLSTALK POWER MACS**

The ToolsTalk software for Power MACS 4000 has been developed with user friendliness and customer adaptation in mind and can be installed on a laptop or a back office PC. It is available in two versions: Tightening and Pressing.





## POWER MACS 4000

One primary controller is needed per system. The primary controller takes care of external communication and comes with most field busses used in modern production lines (optional). A primary controller can be run as a secondary controller.

The secondary controller comes in two versions; with or without Ethernet switch in the back plate.

- One servo covers the complete torque range from 2 to 8,000 Nm.
- One servo covers the complete force range from 5 to 100 KN.
- No external PC required, inherent back-up functionality for increased reliability.
- Define your tightening and pressing strategy based on results to make sure valuable time and resources are not wasted.
- Powerful PLC onboard.
- Reject Management enabling you to handle faulty tightening in the most efficient way.
- Extensive library of tested tightening strategies – each joint can be tightened in the best possible way in terms of cycle time and quality.
- Stand alone design (no need for bulky cabinets).
- 24V DC supply, integrated Ethernet switch, E-stop circuit.
- Informative display
- Integrated line filter.



TC-P



TC-S

### POWER MACS 4000 CONTROLLERS

Model	Fieldbus version	Ordering No.
<b>Primary controller</b>		
TC-4000-P-ES	No Fieldbus	8435 6511 00
TC-4000-P-PB-ES	Profibus	8435 6511 10
TC-4000-P-DN-ES	DeviceNet	8435 6511 30
TC-4000-P-EIP-ES (1 port)	Ethernet IP	8435 6511 60
TC-4000-P-EIP-2P-ES (2 port)	Ethernet IP	8435 6511 62
TC-4000-P-MTCP-ES	ModBus TCP	8435 6511 70
TC-4000-P-PN-ES (1 port)	Profi Net	8435 6511 50
TC-4000-P-PN-2P-ES (2 port)	Profi Net	8435 6511 52
TC-4000-P-CC-ES	CC link	8435 6511 80
<b>Secondary controller</b>		
TC-4000-S	No fieldbus, No Ethernet switch	8435 6500 00
TC-4000-S-ES	No fieldbus, Ethernet switch	8435 6501 00

## MAIN SWITCH BOX – MSB

The MSB is used for power distribution and makes power management easy. It is designed be fed with 380-480 V AC 3-phase without requiring an external transformer. The MSB leaves room for customer adaptations and the E-stop functionality can be upgraded from class 3 to class 4. Each MSB supplies up to 6 controllers with power.

## DISTRIBUTION BOX – DB

The DB provides the same functionality as the MSB except for the main switch and is used as a complement to the MSB for systems with more than 6 channels.

## GENERAL BOX – GB

An empty DB, suitable for external system devices.



MSB

DB

Model	Ordering No.
<b>MSB</b>	
Main switch box (Max 6 channels)	8435 5660 00
<b>DB</b>	
Distribution box (Max 6 channels) + Power cable 1800 mm	8435 6560 50
<b>GB</b>	
General box	4222 1249 85

## EASY-TO-BUILD SYSTEM

<span style="display:inline-block; width:10px; height:10px; background-color:black;"></span> Power cables	4222 1248 xx	Ethernet cable	4222 1246 xx
<span style="display:inline-block; width:10px; height:10px; background-color:orange;"></span> E-Stop cable	4222 1247 xx	Motor cable	4220 3799 xx

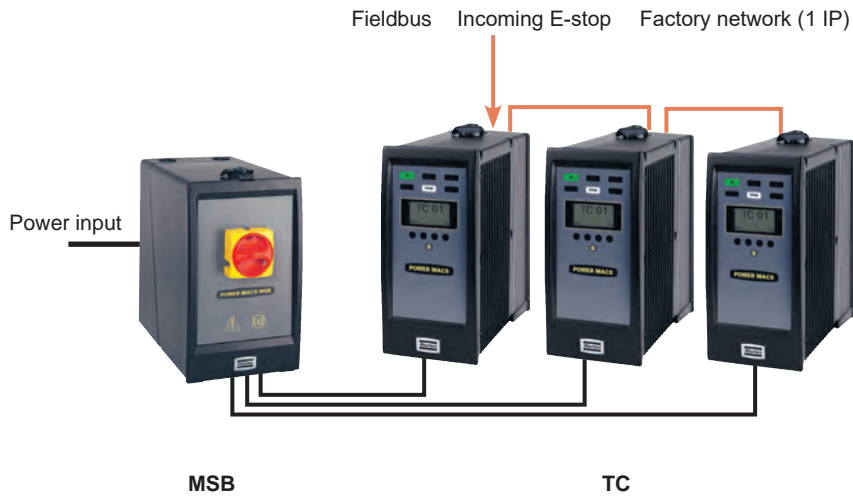

With the Power MACS 4000 controller, multiple-spindle systems are easy to configure. Simply refer to the system ordering table to see which components you need.

## SYSTEM ORDERING TABLE FOR A SYSTEM WITH ONE STATION

No. of spindles	Number of					tool cables	System cable kit <sup>a</sup>	No. of spindles	Number of					tool cables	System cable kit <sup>a</sup>
	TC-P	TC-S	MSB	DB					TC-P	TC-S	MSB	DB			
1	1	0	1	0		1	1	10	1	9	1	1	10	1	
2	1	1	1	0		2	1	11	1	10	1	1	11	1	
3	1	2	1	0		3	1	12	1	11	1	1	12	1	
4	1	3	1	0		4	1	13	1	12	1	2	13	1	
5	1	4	1	0		5	1	14	1	13	1	2	14	1	
6	1	5	1	0		6	1	15	1	14	1	2	15	1	
7	1	6	1	1		7	1	16	1	15	1	2	16	1	
8	1	7	1	1		8	1	17	1	16	1	2	17	1	
9	1	8	1	1		9	1	18	1	17	1	2	18	1	

<sup>a</sup> See system cable kits below.

## SYSTEM CABLE KIT

No. of spindles	Power cable			Ethernet cable			E-stop cable		Ethernet switch incl. Backplate 4222 0982 90	Ordering No. <sup>b</sup>
	1350 mm 4222 1248 13	1650 mm 4222 1248 16	1950 mm 4222 1248 19	1 m 4222 1246 01	2 m 4222 1246 02	3 m 4222 1246 03	1200 mm 4222 1247 12	3000 mm 4222 1247 30		
1	1	-	-	-	-	-	-	-	-	8435 6560 01
2	2	-	-	1	-	-	1	-	-	8435 6560 02
3	2	1	-	1	1	-	1	1	-	8435 6560 03
4	2	2	-	1	2	-	2	1	-	8435 6560 04
5	2	2	1	1	3	-	3	1	-	8435 6560 05
6	2	2	2	4	1	-	4	1	1	8435 6560 06
7	4	3	-	5	1	-	5	1	1	8435 6560 07
8	4	4	-	6	1	-	6	1	1	8435 6560 08
9	4	3	2	4	1	3	7	1	1	8435 6560 09
10	4	4	2	5	1	3	8	1	2	8435 6560 10
11	4	4	3	6	1	3	9	1	2	8435 6560 11
12	4	4	4	7	1	3	10	1	2	8435 6560 12
13	5	4	4	7	1	4	10	2	2	8435 6560 13
14	6	4	4	8	1	4	11	2	3	8435 6560 14
15	6	5	4	9	1	4	12	2	3	8435 6560 15
16	6	6	4	10	1	4	13	2	3	8435 6560 16
17	6	6	5	10	2	4	14	2	3	8435 6560 17
18	6	6	6	11	2	4	15	2	4	8435 6560 18

<sup>b</sup> Based on Atlas Copco suggested set-up.

## Optional Accessories

### ETHERNET CABLES

Length	Ordering No.
0.5 m	4222 1246 00
1 m	4222 1246 01
2 m	4222 1246 02
3 m	4222 1246 03
5 m	4222 1246 05
10 m	4222 1246 10
15 m	4222 1246 15



Ethernet cable

### E-STOP CABLES AND TERMINATION

Components	Length	Ordering No.
E-stop cable	1200 mm	4222 1247 12
E-stop cable	3000 mm	4222 1247 30
E-stop termination		4222 0755 00



E-stop cable

### POWER CABLES BETWEEN MSB AND TC

Suitable for	Length	Ordering No.
TC1-TC2, TC7-TC8, TC13-TC14	1350 mm	4222 1248 13
TC3-TC4, TC9-TC10, TC15-TC16	1650 mm	4222 1248 16
TC5-TC6, TC11-TC12, TC17-TC18	1950 mm	4222 1248 19
For longer distances	5 m	4222 1248 50
	10 m	4222 1370 10
	15 m	4222 1370 15
	20 m	4222 1370 20



Power cable between MSB and TC

### INDICATOR BOX AND CABLE

Model	Ordering No.	
Indicator box	8435 3010 04	
Indicator box cable to PM4K, 1 m	4243 0278 80	
Open end cable 5 m	4243 0281 05	
Extension cable	3 m	4243 0282 03
	5 m	4243 0282 05
	10 m	4243 0282 10
	15 m	4243 0282 15
	20 m	4243 0282 20
25 m	4243 0282 25	



Indicator box

### OPERATOR HANDLE

Model	Ordering No.	
Operator handle (ball joint/handle)	- front/plastic	8435 3030 00
	- front/rubber	8435 3030 01
	- rear/plastic	8435 3030 02
	- rear/rubber	8435 3030 03



Operator handle

## POWER FOCUS 6000

This all new fastening solution from Atlas Copco takes productivity, ergonomics, quality and environmental impact to entirely new levels. And all this with the most user-friendly experience ever.

Enjoy the benefits of a system providing a unique operator experience, with superior quality control and the most flexible integration.

## ONE PLATFORM

One platform for handheld and fixtured tools. The Power Focus 6000 reduces your inventory costs and training requirements.

Easy to connect and configure back up tools, using the same programming interface. More compatible solutions will continuously be deployed. And the Power Focus 6000 will be your common controller for all tools and needs.

## MULTITOOL CONTROLLER

The Power Focus 6000 increases your flexibility in rebalancing assembly lines. Atlas Copco's virtual stations concept allows you to connect up to 6 tools to the same controller. Giving you a simpler installation with less cables, hardware components and network drops. Add to that the lower power consumption, less floor space utilization and a much lower environmental footprint, the benefits are obvious.

- Power Focus 6000 is compatible with: Tensor STR, ST, STB, SR, ES, TBP, SRB, STwrench and QST.
- Connect up to 6 tools to the same controller with Virtual Stations
- Simpler installation with less cables, hardware components and network drops.
- Lower power consumption.
- Less floor space utilization.

## IAM

Virtual stations, software, tightening data and configuration – all in one place. In the IAM two software areas allow for smart software management. Allowing a much safer upgrade process, always giving the possibility to switch between two software versions.



Power Focus 6000

Model	Ordering No.
<b>Drive unit</b>	
Power Focus 6000	8436 1800 02
Power Focus 6000 LV	8436 1800 11
<b>IAMs</b>	
Critical control	8436 0910 10
Process control	8436 0910 40
<b>Software Features Electronic Delivery</b>	
Virtual Station, 1 pcs	8436 1900 01
TurboTight, 1 pcs	8436 1910 02
TrueAngle, 1 pcs	8436 1910 03
SoftPLC, 1 pcs	8436 1910 04
Yield, 1 pcs	8436 1910 06
Gradient, 1 pcs	8436 1910 07
<b>Software Features Physical Goods Delivery</b>	
Virtual Station, 1 pcs	8436 1900 11
TurboTight, 1 pcs	8436 1910 21
TrueAngle, 1 pcs	8436 1910 31
SoftPLC, 1 pcs	8436 1910 41
Yield, 1 pcs	8436 1910 61
Gradient, 1 pcs	8436 1910 71
<b>Fieldbus modules</b>	
DeviceNet	8436 0940 10
Ethernet/IP 2 port	8436 0940 15
ProfiNet I/O 2 port	8436 0940 20
ProfiBus	8436 0940 05
<b>Controller accessories</b>	
FMS Portable	8436 1910 99
Power Focus 6000 Adapter plate	4222 1783 80
Power Focus 6000 Security seal	4222 1736 03



**TOOLSTALK POWERMACS**

The ToolsTalk software for PowerMACS 4000 has been developed with user friendliness and customer adaptation in mind. This Window-based program can be installed on a station PC, a laptop or a back office PC. ToolsTalk supports off-line programming; to edit or upload programs, simply connect the PC to the PowerMACS 4000 controller using an Ethernet cable.

- User friendly Windows programming interface with “drag-and-drop” and “copy-paste” functionalities.
- 10 levels of read and write security.
- Trace reporting on torque, angle, current, current as torque and time.
- Improved read-at-a-glance graphics with actual pictures of customer parts.
- Possible to view up to 20 tightening traces simultaneously.
- Graphical system map of hardware and software.
- Configurable cycle data menu for station reporting.
- Real time SPC and TDA reporting.
- Event logging of security access, parameter changes, errors, faults, alarms and warnings.
- Maintenance menus to verify hardware and software changes without machine intervention.
- Run the program in Basic or Advanced mode depending on needs.
- Quick-set functionality for trimming a process in seconds.
- Optimize each tightening by means of the tightening path for each bolt, including start times, stop times, and execution times for the steps.

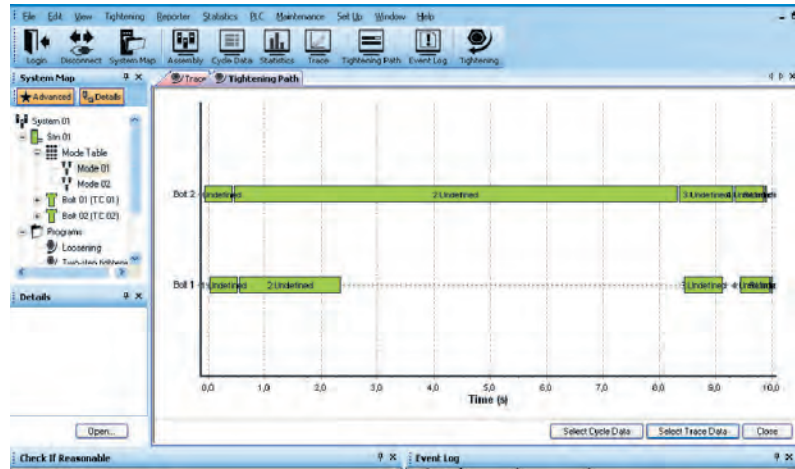

**TOOLSTALK POWER MACS WORLD RELEASE 10**

	Designation	Ordering No.
1 user	English	8092 1308 01
5 user	English	8092 1308 05
10 user	English	8092 1308 10
Plant license	English	8092 1308 97
1 user	German	8092 1308 11
5 user	German	8092 1308 15
10 user	German	8092 1308 20
Plant license	German	8092 1308 98
1 user	French	8092 1308 21
5 user	French	8092 1308 25
10 user	French	8092 1308 30
Plant license	French	8092 1308 99

**TOOLSTALK POWER MACS WORLD RELEASE 10 GAUGING**

	Designation	Ordering No.
1 user	English	8092 1309 01
5 user	English	8092 1309 05
10 user	English	8092 1309 10
Plant license	English	8092 1309 97
1 user	German	8092 1309 11
5 user	German	8092 1309 15
10 user	German	8092 1309 20
Plant license	German	8092 1309 98
1 user	French	8092 1309 21
5 user	French	8092 1309 25
10 user	French	8092 1309 30
Plant license	French	8092 1309 99

**TOOLSTALK POWER MACS 4000 PRESSING**

	Designation	Ordering No.
1 User	English	8092 1310 01
5 Users	English	8092 1310 05
10 Users	English	8092 1310 10
Plant license	English	8092 1310 97



# *Quality assurance and manual tightening*

## **Contents**

STpad.....	173
STa6000 analyser.....	174
Transducers.....	177
Test benches .....	184
QA Torque Supervisor .....	185
STwrench.....	186
Mechanical wrenches.....	192
Mechatronic wrenches.....	194
End fittings for CWR / BWR / MWR.....	197



## Quality assurance and manual tightening that gives peace of mind

*An improperly tightened joint in any assembly process can cause costs for re-work or warranty and can damage manufacturers' brand image. Atlas Copco's wide range of manual tightening and quality assurance tools and systems offer the right tool for nearly any application to meet high-quality standards, secure error proofing functionalities or even verify measurement requirements.*

### **QUALITY ASSURANCE**

Atlas Copco's tightening quality assurance solutions meet torque, angle and pulse measurement requirements for all types of fastening tools and joint verification. This product line offers you tools, analyzers and benches for testing, calibrating, process control and check of residual torque of already tightened joints.

### **DATA COLLECTORS**

The Atlas Copco STpad represents the QA Platform 4.0 innovating data collector, guiding operators through step by step quality inspections, including visual and dimensional checks.

The STa6000 enables you to check the tool in the crib or along the line. Connected to a MRTT-C wrench the STa6000 is able to detect residual torque using the same patented algorithm as the electronic STwrench.

### **BENCHES**

The STbench is the new standard in tool check and joint simulation: it's the fastest solution in the market able to test any tool according to the real application joint condition, perfectly integrated in the QA Platform 4.0.

### **ELECTRONIC STWRENCH**

The four-patent STwrench that tightens a bolt with the most advanced torque or torqueangle-strategies with complete traceability and error-proofing functionalities even checking the residual torque on an already tightened joint.



### **MECHANICAL WRENCH SERIES**

Atlas Copco's mechanical wrench product line form the basis for manual tightening. Regardless whether you are working in assembly lines, rework or repair and maintenance, this product line always offers a suitable solution for your tightening situation, even if limited space handicaps your processes.

### **MECHATRONIC SYSTEM**

If an increased and controlled tightening process is needed, combine the high productivity of a click wrench with error proofing functionalities using the newly launched MWR Mechatronic system. This system provides a complete traceability while small dimensions allow to reach even joints inaccessible for standard tools.

## STPAD

STpad represents the QA Platform 4.0 wireless hub, guiding the operators through all quality checks, including non-torque test like visual and dimensional checks.

The STpad is a rugged and portable wireless tablet having 10.1" touch display, integrated camera and 2D barcode reader, satisfying MIL-STD 810G standard.

Thanks to flexible software licensing, different features can be enabled:

- **Tool check**

You can deliver highest tool test reliability and operator independence in latest assembly technology such as robot and automated spindles thanks to IRC-C Bluetooth communication. With an STpad you can have real time control over tightening results to assure the high quality you need for a satisfactory result.

- **Joint Check**

Quality auditors performing residual torque check with STwrench is now guided during the execution with pictures and text instructions.

Deep analysis such as torque/angle trace zoom is available from STpad display.

- **Visual Check**

STpad guide the operator also for those checks that don't require numerical measurement, such as defects collection and go-no go test. Visual check processes can be standardized and digitalized through visual check steps definition, avoiding operator mistakes and paperless data collection. Statistic data, corrective actions and issue assignable causes can be also tracked to improve related quality processes.

- **Dimensional Check**

There will always be productions where non-torque related checks need to be conducted – and reported – manually.

These measurements can be crucial information when working with quality assurance over the whole production. So whereas torque is reported automatically into the system, measurements from for example length or pressure, gauge needs to be reported manually to complete the big picture.

All results are safely stored in STpad internal memory or synchronized with QA Supervisor database.



STpad

Description	Ordering No.
<b>Device</b>	
STpad	8059 0957 00
<b>Accessories</b>	
STpad docking station	8059 0957 03
STpad external battery charger	8059 0957 04
<b>Licenses Electronic delivery</b>	
Tool Check	8059 0981 60
Joint Check	8059 0981 61
Visual Check	8059 0981 62
Dimensional Check	8059 0981 63
<b>Licenses Physical delivery</b>	
Tool Check	8059 0981 65
Joint Check	8059 0981 66
Visual Check	8059 0981 67
Dimensional Check	8059 0981 68

## STa6000

*In assembly operations worldwide there is an increasing focus on quality. Using sophisticated tools to tighten bolts is simply not enough. It's also important to monitor tool performance, and to test joints after they have been tightened. This is where the Atlas Copco STa6000 come in. The portable STa6000 can be used to check tool performance, repeatability and accuracy for all types of power tools and torque wrenches. Test your tools in the tool crib following service and continuously on the line to monitor performance or test your joint by checking the residual torque using our unique residual torque check function.*



### **STa6000**

Improve everyday tasks for Quality supervisors and operators. Reduced weight and compact design makes the STa6000 easy to carry along the line. Checking tools in the Tool Crib and on the line and checking tightened joints means quality guaranteed.

### **PORTABLE AND ERGONOMIC**

The compact STa6000 with long-life battery weighs less than 500 g. No special device is required to carry the system it can be conveniently hung on a strap from the operator's belt.

The STa6000 small size and features make it easy to use in the production line.

### **QUICK PROGRAMMING**

The STa6000 is designed for easy connection to Atlas Copco IRTT-B in-line transducers, SRTT-B static transducers and MRTT-C wrenches. It is also easy to connect the STa6000 to SRTT-L by specific cradle in order to have a compact complete solution. The STa6000 also works with the IRC-Connect, our Smart transducer. The IRC-connect is more than just a cable replacement, is a tool to simplify and improve your daily tasks with an incorporated memory that will store up to 5000 results and traces.

It provides automatic recognition and calibration and allows the operator to start a test with a few clicks: just selecting the tool type to be checked. The test setup is automatically created by STa6000.

### **MODULARITY – YOU BUY WHAT YOU NEED**

The STa6000 is easy to upgrade. You don't need to buy a complete new model. Simply add modules and accessories that expand the functionalities and create your customized torque analyzer system.

### **COMMONALITY CUTS COSTS**

The STa6000 utilizes the same modules and software as the STAnalyser and STWrench, thus saving you money.

### **CLEAR OPERATOR FEEDBACK**

STa6000 color screen features intuitive icon menus.

Feedback is clearly displayed thanks to the green or red screen, with the possibility to add a gauge indicator and fully customize information.

### **STa6000 BASIC**

The ideal solution for simple and quick tests.

#### **Quick programming**

- The quick tool or joint check test can be launched with STa6000 basic version. Up to 50000 results are stored in the device memory, traces can be seen with TT BLM if the software is purchased.
- No PC is required
- Test conditions can be set up right on the device for each test
- Color screen
- The green/red color screen guides the operator for the tests

### **STa6000 QC**

The ideal solution for operators requiring a complete testing solution.

This version includes all the features listed for the Basic one, and additional others:

#### **Tools and Psets database**

This is a list of tools you want to test (max. 1,000). It contains all information related to the tool, such as type, model, min. and max. torque, etc. The PSet defines how the test has to be performed with acceptance limits. A maximum of 1,000 PSets can be stored and 5 max. per tool can be assigned.

Continued...



- **Traces on display**

Traces can be seen directly on the STa6000 screen.

- **Customized screen**

The measure screen can be customized with all the important information to have them displayed during the test. It is possible to have on the measure screen information as Cm/Cmk values, sigma, last results also a graphical gauge indicator can be added.

- **Full text notes**

Text notes can be added to the results to keep the full traceability of the tests.

- **PF and PM Calibration**

STa6000 allows to complete calibrations simply connect the STa6000 to an Atlas Copco controller with either a Ethernet cable or with the small USB to serial adapter. All other operations are done by the STa6000 as the Pset is automatically read from the controller. The readings are also acquired and the new calibration value is stored in the controller. Calibration made easy, fast and completely error-proofed.

- Reports can be printed on a network printer.

## STa6000 AA

The recommended solution for Advanced Analysis.

- **The STa6000 ultimate solution**

All the features are included in this version, statistics CM/Cmk graphs and X/R charts can be visualized right on the STa6000 screen.

## TT BLM

With TT BLM software, it's possible to manage programs, settings, results and traces of the STa6000 remotely via the network from the office PC.

A smart Excel database for the STa6000 results is featured by TT BLM software.

**NOTE:** Software license is necessary for the above features.

## IRC-CONNECT

The IRC-Connect is not just a cable eliminator. It stores up to 5000 results that can be uploaded to the STa6000 as soon as they are connected. When this device is paired with the IRC-Connect the transducer is automatically recognized.

Thanks to the STa6000, plus multitesting functionality, up to 30 IRC-Connects can be connected at the same time for multi-spindle applications.

## TORQUE SUPERVISOR

STa6000 is fully integrated with Torque Supervisor software.

It's possible to take advantage of all the advanced features of Atlas Copco Quality data management software with STa6000, programming the tool check and joint check routes to be executed.

## ACCESSORIES

With the Barcode Module it is possible to automatically start a tool or a joint test, and it is possible store further scanned information on their results. In addition a work order can be defined to set the scanning order of different identifiers.

With IRC-W Radio Module you can wirelessly communicate to software.

With the USB/Serial converter, it is possible to synchronize to Power Focus, Power MACS and PST for their calibration.

Model	Ordering No.
STa6000 data analyzer	8059 0956 60
STa6000 Plus data analyzer	8059 0956 61
RBU QC for STa6000 Plus	8059 0956 62
RBU AA for STa6000 Plus	8059 0956 63
RBU QC API for STa6000 Plus	8059 0956 68
RBU AA API for STa6000 Plus	8059 0956 69
STa6000 rubber protection	8059 0956 76
STa6000 Plus stand	8059 0956 73
STa6000 Plus USB/Serial Adapter	8059 0956 74
Battery pack	8059 0955 61
Battery adapter	8059 0955 75
Battery charger	8059 0930 88
STa power supply <sup>a</sup>	4612 0300 21
IRC-B Module	8059 0920 10
IRC-W Module	8059 0920 15
BarCode Module	8059 0920 12
ACTA RS232 cable 3 m	4222 0546 03
ACTA RS232 cable 5 m	4222 0546 05

<sup>a</sup> STa6000 is provided with the power supply (Ordering No. 4612 0300 21) in the box. Battery has to be ordered separately.

## SOFTWARE TT BLM W09

	Ordering No.
1 user license	8059 0981 10
5 user license	8059 0981 11
10 user license	8059 0981 12
Plant license	8059 0981 13

## IRC-CONNECT

	Ordering No.
IRC-Connect Wi-Fi (ad hoc)	8059 0956 80
IRC-Connect Bluetooth	8059 0956 81



STa6000 Plus analyser



IRC-connect

## STa6000 BASIC

BASIC is the perfect solution for simple and quick tests.

## STa6000 QC

QC version for operators requiring a complete testing solution.

## STa6000 AA

AA version is the recommended solution for Advanced Analysis.

	BASIC	QC	AA RBU
<b>HARDWARE CAPABILITY</b>			
Number of Channel	1	1	1
Torque	yes	yes	yes
Angle (Encoder or Gyroscope)	yes	yes	yes
MRTT-C connection for joint checks	yes	yes	yes
Size in mm	110x200x45	110x200x45	110x200x45
Weight [grams]	<= 500	<= 500	<= 500
Color Display	yes	yes	yes
Keyboard	yes	yes	yes
Results Storage	50000	50000	50000
Traces storage	50000	50000	50000
RBU - Rapid Backup Unit	no	yes	yes
Direct Power Supply (slow charger 6H)	yes	yes	yes
RJ45 (Ethernet)	yes	yes	yes
USB	yes	yes	yes
Non Atlas Copco analog transducer connection	yes	yes	yes
<b>SOFTWARE CAPABILITY - ONBOARD</b>			
Languages	yes	yes	yes
Multi-units	yes	yes	yes
Pset	1 (not saved)	1000	1000
Batch Count	yes	yes	yes
CW/CCW	yes	yes	yes
Database - Tool	no	1000	1000
Quick Programming	yes	yes	yes
Power Focus and Power Macs calibration	no	yes	yes
Traces on display	no	yes	yes
Advanced analysis graphs on display	no	no	yes
Custom measurement screen	no	yes	yes
Wi-Fi print	yes (with IRC-W module)	yes (with IRC-W module)	yes (with IRC-W module)
Ethernet print	yes	yes	yes
<b>SOFTWARE FUNCTIONALTIES - ONBOARD</b>			
<b>Tool Check</b>			
Wrench testing	yes	yes	yes
Power tool testing	yes	yes	yes
Pulse Tool testing	yes	yes	yes
Min, Max, Med, Sigma statistics	yes	yes	yes
Cm/Cmk	no	yes	yes
SPC	no	yes	yes
<b>Joint Check</b>			
Yield point	yes	yes	yes
Residual Torque/Time	yes	yes	yes
Residual Torque/Angle	yes	yes	yes
Residual Torque/Peak	yes	yes	yes
Loose and Tight	yes	yes	yes
<b>SOFTWARE CAPABILITY - CONNECTIVITY</b>			
ToolsTalk BLM to view/export results and traces via Wi-Fi (with IRC-W), USB/RJ45	yes	yes	yes
ToolsTalk BLM to program test strategies via Wi-Fi (with IRC-W), USB/RJ45	no	yes	yes
Torque Supervisor via Wi-Fi (with IRC-W), USB/RJ45	no	yes	yes
API via Wi-Fi (with IRC-W), USB/RJ45	no	yes (with API RBU)	yes (with API RBU)

**SRTT-L**

SRTT-L is a family of transducers for the STAnalyser. It is designed for lower torque assembly tools. Both transducers and test joints are exchangeable and can be used with any STAnalyser. The modular design allows the user to scale his system as his needs evolve. The same SRTT-L plate can be used with any transducer in the SRTT-L family.



SRTT-L

Model	Ordering No.
SRTT-L main plate	8059 0955 85

**SRTT-L TRANSDUCERS**

Model	Rated capacity		Ordering No.
	Nm	ft lb	
SRTT-L 1 Nm	1	0.73	8059 0955 86
SRTT-L 4 Nm	4	2.95	8059 0955 87
SRTT-L 12 Nm	12	8.85	8059 0955 88
SRTT-L 30 Nm	30	22.12	8059 0955 89

**TEST JOINT FOR SRTT-L**

Model	Screw size	Rated capacity		Ordering No.
		Nm	ft lb	
TJ SRTT-L M4 S -1	M4	1	0.73	4145 0984 80
TJ SRTT-L M4 H -1	M4	1	0.73	4145 0984 83
TJ SRTT-L M6 S -4	M6	4	2.95	4145 0984 82
TJ SRTT-L M6 H -4	M6	4	2.95	4145 0984 85
TJ SRTT-L M6 S -12	M6	12	8.85	4145 0985 80
TJ SRTT-L M6 H -12	M6	12	8.85	4145 0985 82
TJ SRTT-L M8 S -12	M8	12	8.85	4145 0985 81
TJ SRTT-L M8 H -12	M8	12	8.85	4145 0985 83
TJ SRTT-L M8 S -30	M8	30	22.12	4145 0986 80
TJ SRTT-L M8 H -30	M8	30	22.12	4145 0986 82
TJ SRTT-L M10 S -30	M10	30	22.12	4145 0986 81
TJ SRTT-L M10 H -30	M10	30	22.12	4145 0986 83

**QRTT-B**

Transducers used for QST nutrunner as well as for fixtured Tensor tool calibration. This transducer enables fast, easy set-up with highest system accuracy. By using the QRTT-B, no special test adaptation device between the spindle and the product itself is needed.



QRTT-B

Model	Drive square in	Torque range		Ordering No.
		Nm	ft lb	
QRTT-B 20 Nm kit	3/8	4-20	3-15	8092 1164 13
QRTT-B 75 Nm kit	3/8	15-75	11-55	8092 1164 18
QRTT-B 200 Nm kit	1/2	40-200	30-150	8092 1164 23
QRTT-B 500 Nm kit	3/4	100-500	74-369	8092 1164 28
QRTT-B 1000 Nm kit	1	200-1000	148-737	8092 1164 33

**NOTE:** The QRTT-B includes the complementary kit for its installation.

## IRTT-B

IRTT-B is the Atlas Copco torque and torque/angle in-line rotary transducers incorporating significant improvements in durability and accuracy. The angle reading system use a patent solution which gives better resolution and longer life. The mechanics have also been completely reviewed to achieve a higher level of durability.

IRTT-B is equipped with a memory chip that is read by the Atlas Copco data analyser. In this way the Data analyser is automatically calibrated to the transducer sensitivity and avoids any possible set-up errors.



IRTT

Model	Drive		Torque range		Ordering No.	Model	Drive		Torque range		Ordering No.
	Hex in	Square in	Nm	ft lb			Hex in	Square in	Nm	ft lb	
<b>Torque models</b>						<b>Torque/angle models</b>					
IRTT-B 5-I06	1/4		1-5	0.8-3.6	8059 0942 05	IRTT-B 1A-I06	1/4		0.2-1	0.14-0.73	8059 0943 96
IRTT-B 5-06		1/4	1-5	0.8-3.6	8059 0942 07	IRTT-B-2A-I06	1/4		0.4-2	0.3-1.47	8059 0943 01
IRTT-B 20-I06	1/4		4-20	3-15	8059 0942 10	IRTT-B 5A-I06	1/4		1-5	0.8-3.6	8059 0943 06
IRTT-B 20-06		1/4	4-20	3-15	8059 0942 15	IRTT-B 5A-06		1/4	1-5	0.8-3.6	8059 0943 08
IRTT-B 25 -10		3/8	5-25	3.7-18.4	8059 0942 20	IRTT-B 20A-I06	1/4		4-20	3-15	8059 0943 11
IRTT-B 75-10		3/8	15-75	11-55	8059 0942 25	IRTT-B 20A-06		1/4	4-20	3-15	8059 0943 16
IRTT-B 180-13		1/2	36-180	27-133	8059 0942 30	IRTT-B 25A-10		3/8	5-25	3.7-18.4	8059 0943 21
IRTT-B 500-20		3/4	100-500	74-369	8059 0942 35	IRTT-B 75A-10		3/8	15-75	11-55	8059 0943 26
IRTT-B 750-25		1	150-750	111-553	8059 0942 40	IRTT-B 180A-13		1/2	36-180	27-133	8059 0943 31
IRTT-B 1400-25		1	280-1400	206.6-1033	8059 0942 45	IRTT-B 500A-20		3/4	100-500	74-369	8059 0943 36
IRTT-B 3000-38		1 1/2	600-3000	440-2200	8059 0942 52	IRTT-B 750A-25		1	150-750	111-553	8059 0943 41
IRTT-B 5000-38		1 1/2	1000-5000	737-3685	8059 0942 56	IRTT-B 1400A-25		1	280-1400	206.6-1033	8059 0943 46
						IRTT-B 3000A-38		1 1/2	600-3000	440-2200	8059 0943 52
						IRTT-B 5000A-38		1 1/2	1000-5000	737-3685	8059 0943 56
						IRTT-B 10000A-38		1 1/2	2000-10000	1474-7370	8059 0943 60

NOTE: All IRTT are equipped with 19-pin connector.



Test joint for IRTT-B

## TEST JOINT FOR IRTT-B

Test joint for IRTT-B	Nominal capacity		Tight angle at rated capacity	Ordering No.	Test joint for IRTT-B	Nominal capacity		Tight angle at rated capacity	Ordering No.
	Nm	ft lb				Nm	ft lb		
M4	1.5	1.1	45°	4145 0958 80	M10	30	22	30°	4080 0789 90
M4	2	1.5	900°	4145 0959 80	M10	30	22	540°	4080 0789 91
M4	3	2.2	45°	4145 0958 81	M12	50	36.9	180°	4080 0790 92
M6	4	3	900°	4145 0959 81	M12	60	44	30°	4080 0790 90
M6	6	4.4	45°	4145 0958 82	M12	60	44	540°	4080 0790 91
M6	7	5.1	900°	4145 0959 82	M14	90	66	30°	4080 0791 90
M6	9	6.6	45°	4145 0958 83	M14	90	66	540°	4080 0791 91
M6	10	7.3	900°	4145 0959 83	M14	100	73.8	180°	4080 0791 92
M8	15	11	30°	4080 0788 90	M16	135	99.6	180°	4080 0837 92
M8	15	11	540°	4080 0788 91	M16	200	148	60°	4080 0865 90
M8	20	14.8	180°	4080 0788 92	M16	200	148	360°	4080 0866 90
M8	25	18.4	60°	414 50958 84	M20	400	295	60°	4080 0867 90
M8	25	18.4	600°	4145 0959 84	M20	400	295	360°	4080 0868 90
					M30	800	590	60°	4080 0876 95
					M30	800	590	360°	4080 0876 90

## SRTT-B

### STATIONARY REACTION TORQUE TRANSDUCER

Stationary reaction torque transducers are designed for testing wrenches, click wrenches or for tightening tools where rotary action is not desired during measurement. When testing a shut-off tool, a joint simulator is required as an accessory.

The SRTT-B is the new generation of Atlas Copco stationary reaction torque transducers with improved durability thanks to their new mechanical design. The new patented system of fixing the joint simulator on top avoids any possible errors due to the play between the two devices.

A complete range of accessories and a mechanical joint simulator enables you to test shut-off tools or wrenches with square drive output.



SRTT-B

Model	Drive		Torque range		Ordering No.
	Hex mm	Square in	Nm	ft lb	
SRTT-B 0.5-13		1/2	0.1-0.5	0.08-0.37	8059 0946 03
SRTT-B 2-13		1/2	0.4-2	0.3-1.47	8059 0946 09
SRTT-B 5-13		1/2	1-5	0.8-3.6	8059 0946 15
SRTT-B 10-13		1/2	2-10	1.5-7.3	8059 0946 21
SRTT-B 25-36	36		5-25	3.7-18.4	8059 0946 28
SRTT-B 50-36	36		10-50	7.4-36	8059 0946 36
SRTT-B 100-36	36		20-100	14.8-73	8059 0946 45
SRTT-B 250-36	36		50-250	37-184	8059 0946 54
SRTT-B 500-50	50		100-500	74-368	8059 0946 63
SRTT-B 1000-50	50		200-1000	148-737	8059 0946 75
SRTT-B 2000-50	50		400-2000	295-1475	8059 0946 84

### TEST JOINT FOR SRTT-B



Test joint for SRTT-B

Model	SRTT-B Drive		Tool drive		Rated capacity		Ordering No.
	Hex mm	Square in	Hex mm	Square in	Nm	ft lb	
TJ SRTT-B S -0.5		1/2	1/4		0.5	0.37	8059 0940 01
TJ SRTT-B H -0.5		1/2	1/4		0.5	0.37	8059 0940 02
TJ SRTT-B S -2		1/2	1/4		2	1.47	8059 0940 03
TJ SRTT-B H -2		1/2	1/4		2	1.47	8059 0940 04
TJ SRTT-B S -5		1/2	1/4		5	3.69	8059 0940 05
TJ SRTT-B S -5		1/2	1/4		5	3.69	8059 0940 06
TJ SRTT-B S -10		1/2	1/4		10	7.36	8059 0940 20
TJ SRTT-B H -10		1/2	1/4		10	7.36	8059 0940 21
TJ SRTT-B S -25	36			3/8	25	18.40	8059 0940 07
TJ SRTT-B H -25	36			3/8	25	18.40	8059 0940 08
TJ SRTT-B S -50	36			1/2	50	36.88	8059 0940 09
TJ SRTT-B H -50	36			1/2	50	36.88	8059 0940 10
TJ SRTT-B S -100	36			1/2	100	73.76	8059 0940 11
TJ SRTT-B H -100	36			1/2	100	73.76	8059 0940 12
TJ SRTT-B S -250	36			1/2	250	184.40	8059 0940 13
TJ SRTT-B H -250	36			1/2	250	184.40	8059 0940 14
TJ SRTT-B S -500	50			3/4	500	368.78	8059 0940 15
TJ SRTT-B H -500	50			3/4	500	368.78	8059 0940 16
TJ SRTT-B 1000-50	50			1	1000	737.60	8059 0940 17

## Optional Accessories



Adapter



Square socket

### ADAPTERS

Adapter	Drive		Ordering No.
	Hex mm	Square in	
1/2" to 1/4"		1/2	8059 0978 63
1/2" to 3/8"		1/2	8059 0978 64
3/8" to 36	36		8059 0978 65
1/2" to 36	36		8059 0978 66
1/2" to 50	50		8059 0978 67
3/4" to 50	50		8059 0978 68
1" to 50	50		8059 0978 69

### SQUARE SOCKETS

Adapter	Ordering No.
1/4" - 1/4"	8059 0977 64
3/8" - 3/8"	8059 0977 65
1/2" - 1/2"	8059 0977 66
3/4" - 3/4"	8059 0977 67
1" - 1"	8059 0978 52
1/4" - 3/8"	8059 0977 68
3/8" - 1/2"	8059 0977 69
1/2" - 3/4"	8059 0977 70
3/4" - 1"	8059 0978 53



## MRTT-B SCREWDRIVER

MRTT-B is available in a screwdriver version for low torque applications from 0.1 to 15 Nm. The 15 Nm model has a precision reversible 1/4" drive ratchet consisting of two needle clutches. Sliding bush to convert left and right tightening. The very low friction avoids dragging the screws on the return motion.



MRTT-B

Model	Torque capacity		Square drive in	Weight		Length mm	Ordering No.
	Nm	ft lb		kg	lb		
MRTT-B 1-06	0.1-1	0.07-0.74	1/4	0.3	0.66	169	8059 0931 06
MRTT-B 5-06	0.5-5	0.36-3.67	1/4	0.3	0.66	169	8059 0931 15
MRTT-B 15-06	1.5-15	1.1-11.1	1/4	0.4	0.88	223	8059 0931 24

## Optional Accessories

### TRANSDUCER CABLE

The cable needed for all transducers and MRTT-B.

### CABLES

Length	Ordering No.
1 m	4145 0982 01
3 m	4145 0982 03
5 m	4145 0982 05
3 m curled cable	4145 0971 03

If non Atlas Copco transducers are used one of the following cables are required.

Model	Ordering No.
Industrial style Transducer cable 3 m 19 - 4	4145 0965 03
Industrial style Transducer cable 3 m 19 - 6	4145 0968 03
Industrial style Transducer cable 3 m 19 - 10	4145 0967 03

**MRTT-C**

The MRTT-C is a revolutionary way to think about a manual wrench. The MRTT-C is an advanced handle that can be connected to the standard smartHEAD used for the STwrench to create a wrench that can be connected to the STa6000 using a standard Atlas Copco cable.

The MRTT-C connected to the STa6000 with Residual or Production RBU can be used to detect the residual torque using the advanced Torque/Angle algorithm, same as the STwrench, or to tight a bolt for production applications.



MRTT-C

**SMARTHEADS**

Square connection smartHEAD have been added to the range of smartHEADs. The square connection smartHEADs allow customers to use any square end fitting, losing thought the poka yoke system offered by end fittings.

- Torque or Torque/Angle reading depending to the smartHEAD
- Led ring like STwrench
- Vibrating handle
- Buzzer
- TAG recognition
- Light in front

Model	Weight		Ordering No.
	kg	lb	
MRTT-C	0.42	0.93	8059 0930 10

Model	Capacity		Drive mm	Weight		Length mm	Ordering No.
	Nm	ft lb		kg	lb		
<b>smartHEAD only Torque</b>							
smartHEAD 30	6-30	4.5-22	9x12	0.20	0.44	167.5	8059 0920 31
smartHEAD 80	16-80	12-59	9x12	0.22	0.48	167.5	8059 0920 43
smartHEAD 150	30-150	23-111	14x18	0.55	1.21	271.0	8059 0920 48
smartHEAD 250	50-250	37-184	14x18	0.78	1.72	417.0	8059 0920 54
smartHEAD 400	80-400	59-295	14x18	0.93	2.05	584.0	8059 0920 60
smartHEAD 600	120-600	89-443	21x26	1.70	3.75	1048.5	8059 0920 66
smartHEAD 1000	300-1000	148-737	28	1.90	4.19	1344	8059 0920 80
<b>smartHEAD A Torque + Angle</b>							
smartHEAD A15	3-15	2.2-11	9x12	0.19	0.42	147.5	8059 0930 24
smartHEAD A30	6-30	4.5-22	9x12	0.19	0.42	147.5	8059 0930 31
smartHEAD A80	16-80	12-59	9x12	0.20	0.44	147.5	8059 0930 43
smartHEAD A150	30-150	23-111	14x18	0.57	1.25	271.0	8059 0930 48
smartHEAD A250	50-250	37-184	14x18	0.80	1.76	417.0	8059 0930 54
smartHEAD A400	80-400	59-295	14x18	0.95	2.09	584.0	8059 0930 60
smartHEAD A600	120-600	89-443	21x26	1.72	3.79	1048.5	8059 0930 66
smartHEAD A800	160-800	118-590	21x26	1.70	3.75	1048.5	8059 0988 26
smartHEAD A1000	300-1000	148-737	28	1.90	4.19	1344	8059 0930 80
<b>smartHEAD A Torque + Angle sq<sup>a</sup></b>							
smartHEAD Asq15	3-15	2.2-11	9x12	0.19	0.42	147.5	8059 0930 28
smartHEAD Asq30	6-30	4.5-22	9x12	0.19	0.42	147.5	8059 0930 32
smartHEAD Asq80	16-80	12-59	9x12	0.20	0.44	147.5	8059 0930 44
smartHEAD Asq150	30-150	23-111	14x18	0.55	1.21	271.0	8059 0930 50
smartHEAD Asq250	50-250	37-184	14x18	0.78	1.72	417.0	8059 0930 56
smartHEAD Asq400	80-400	59-295	14x18	0.93	2.05	584.0	8059 0930 62

<sup>a</sup>For standard square drive end fittings. **NOTE:** smartHEAD requires MRTT-C dedicated calibration.

**Dimensions**

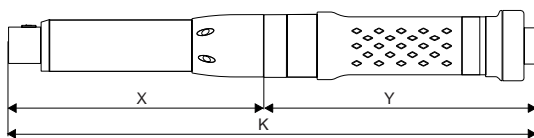

Model	X mm	Length		Total weight	
		Y mm	K mm	kg	lb
MRTT-C 15 Nm	139	166	325	0.60	1.29
MRTT-C 30 Nm	139	166	325	0.62	1.36
MRTT-C 80 Nm	139	166	325	0.64	1.41
MRTT-C 150 Nm	262	166	428	0.97	2.13
MRTT-C 250 Nm	408	166	574	1.20	2.64
MRTT-C 400 Nm	575	166	741	1.35	2.97
MRTT-C 600 Nm	1040	166	1206	2.12	4.67
MRTT-C 800 Nm	1040	166	1206	2.12	4.67
MRTT-C 1000 Nm	1270	166	1436	2.97	6.54

**Optional Accessories**

**TRANSDUCER CABLE**

The cable needed for all transducers and MRTT-C.

If non Atlas Copco transducers are used one of the following cables are required.

**CABLES**

Length	Ordering No.
1 m	4145 0982 01
3 m	4145 0982 03
5 m	4145 0982 05
10 m	4145 0982 10
3 m curled cable	4145 0971 03

Model	Ordering No.
Industrial style Transducer cable 3 m 19 - 4	4145 0965 03
Industrial style Transducer cable 3 m 19 - 6	4145 0968 03
Industrial style Transducer cable 3 m 19 - 10	4145 0967 03

## QUALITY ASSURANCE SYSTEM – SHARPENING YOUR COMPETITIVE EDGE

To ensure the highest quality of your fastening – and ultimately your company’s products – Atlas Copco has developed a comprehensive quality assurance system for micro torques. The ACTA MT4 system provides fast, accurate and reliable measurement of critical parameters.

### ACTA MT4 – SMART FEATURES

- Connect to PC via USB/RS232/Ethernet.
- 6 different engineering units to choose from.
- Colour configurable display (Torque/Angle/Status/Trace).
- Battery for portable usage.
- Programmable via keypad or software “ToolsTalk ACTA MT”.
- Dual transducer inputs.
- High resolution OLED colour display.
- Audio signal for operator feedback.
- Digital I/O signals for communication with external devices such as PLC.
- Tool speed measurement function possible when using MT TRA transducers.
- Store and export tightening data to excel with ToolsTalk ACTA MT PC software.
- Calculate average torque directly on the display.



MT TRA 500



MT TH



ACTA MT 4



MT TS

Model	Capacity		Drive	Overall length mm	Ordering No.
	cNm	in lb			
<b>Torque Analyzer</b>					
ACTA MT 4 <sup>a</sup>					8432 0820 04
<b>Manual screwdriver torque transducer</b>					
MT TH 1	1.0	0.09	Ø 3 mm	115	8432 0820 10
MT TH 2	2.0	0.18	Ø 3 mm	115	8432 0820 11
MT TH 5	5.0	0.44	Ø 3 mm	115	8432 0820 12
MT TH 10	10.0	0.88	Ø 3 mm	115	8432 0820 13
MT TH 20	20.0	1.77	Ø 3 mm	115	8432 0820 14
MT TH 50	50.0	4.42	1/4"	124	8432 0820 15
MT TH 100	100.0	8.85	1/4"	124	8432 0820 16
MT TH 200	200.0	17.70	1/4"	124	8432 0820 17
<b>Stationary reaction torque transducer</b>					
MT TS 1	1.0	0.09	Ø 3 mm	87	8432 0822 20
MT TS 2	2.0	0.18	Ø 3 mm	87	8432 0822 21
MT TS 5	5.0	0.44	Ø 3 mm	87	8432 0822 22
MT TS 10	10.0	0.88	Ø 3 mm	87	8432 0822 23
MT TS 20	20.0	1.77	Ø 3 mm	87	8432 0822 24
MT TS 50	50.0	4.42	1/4"	104.5	8432 0822 25
MT TS 100	100.0	8.85	1/4"	104.5	8432 0822 26
MT TS 200	200.0	17.70	1/4"	104.5	8432 0822 27
MT TS 500	500.0	44.25	1/4"	103	8432 0822 28
<b>In-line rotary torque and angle transducer</b>					
MT TRA 5	5.0	0.44	Ø 3 mm	76	8432 0820 42
MT TRA 10	10.0	0.88	Ø 5 mm	76	8432 0820 43
MT TRA 20	20.0	1.77	Ø 5 mm	76	8432 0820 44
MT TRA 50	50.0	4.42	1/4"	105	8432 0820 45
MT TRA 100	100.0	8.85	1/4"	105	8432 0820 46
MT TRA 200	200.0	17.70	1/4"	105	8432 0820 47
MT TRA 500	500.0	44.25	1/4"	105	8432 0820 48

<sup>a</sup> ToolsTalk ACTA MT (programming software) included.

## CABLES

Model	Ordering No.
Transducer cable	8432 0830 35
RS232 cable ACTA MT	8432 0831 39

## TEST JOINTS FOR CALIBRATION WITH MT TS

Model	Designation	Range cNm	Drive	Screw head profile	Ordering No.
Test joint	M6 Soft joint	500 - 1000	1/4" HEX	HEX 5 mm	8432 0833 62
	M6 Soft joint	200 - 500	1/4" HEX	HEX 5 mm	8432 0833 61
	M4 Soft joint	27 - 200	1/4" HEX	HEX 3 mm	8432 0833 60
	M3 Soft joint	5 - 27	1/4" HEX	HEX 3 mm	8432 0833 59
	M3 Soft joint	5 - 27	∅ 3 mm	HEX 3 mm	8432 0833 58
	M2 Soft joint	0 - 10	1/4" HEX	HEX 1.5 mm	8432 0833 57
	M2 Soft joint	0 - 10	∅ 3 mm	HEX 1.5 mm	8432 0833 56
	M6 Hard joint	200 - 1000	1/4" HEX	HEX 5 mm	8432 0833 55
	M4 Hard joint	27 - 200	1/4" HEX	HEX 3 mm	8432 0833 54
	M3 Hard joint	5 - 27	1/4" HEX	HEX 3 mm	8432 0833 53
	M3 Hard joint	5 - 27	∅ 3 mm	HEX 3 mm	8432 0833 52
	M2 Hard joint	0 - 10	1/4" HEX	HEX 1.5 mm	8432 0833 51
	M2 Hard joint	0 - 10	∅ 3 mm	HEX 1.5 mm	8432 0833 50

# Test Benches

## STBENCH

The Atlas Copco STbench represent the state of the art in joint simulation testing the tool according the production application. It provides maximum tool evaluation flexibility. DC electric, clutch, impulse and battery tools as well as torque wrenches can be evaluated in accordance with latest ISO standards.

The new hydraulic system design significantly improve the overall testing time by starting the test quickly and performing multiple test in short time. A new encoder increases the angle resolution, and the improved robust brushes increase transducer lifetime.

STbench new modular design includes different standard options to satisfy any customer needs:

- STpad for full accessibility. Thanks to the removable STpad and IRC-Connect, you can reach automated stations, robots or difficult to reach areas.
- Industrial PC as option instead STpad.
- Hydraulic brakes up to 3000 Nm.
- SRTT-B up to 2000 Nm, suitable for pulse tool.
- Tilting Top option improving test ergonomics.
- Articulated arm directly reaching the application without unmounting the tools from the application.

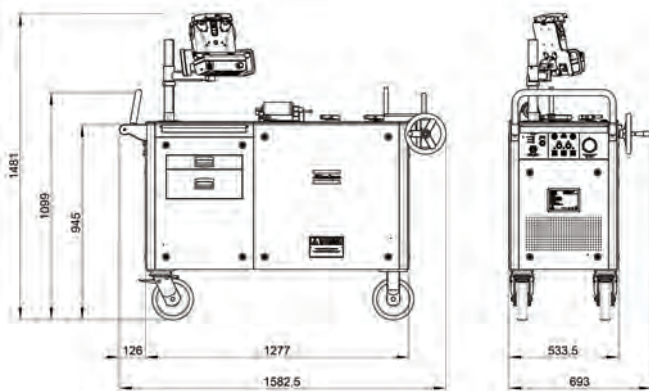

STbench Standard - Large frame dimensions

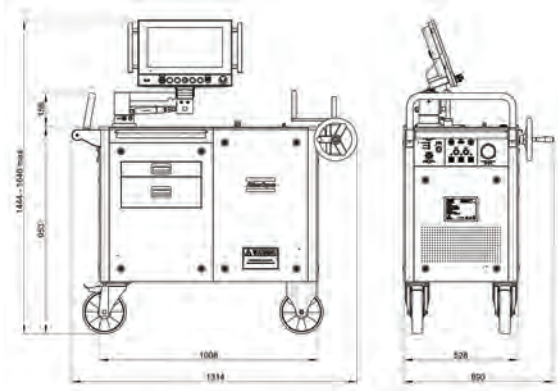

STbench Standard - Small frame dimensions



# Quality Assurance in Tightening Management Software

## QA SUPERVISOR

From scheduling to reporting QA Supervisor is a web based software, accessible from any device – always connected. It manages scheduling of the tests requested and shows status overview. The collection of data from STpad, STa6000 and STbench covers all the QA applications – and each user can work smoothly with a quality dashboard with personalized widgets. Even the reports are customizable to better meet user needs.

QA Supervisor requires one single installation to a server to be managed, this provides different advantages:

- Reduce maintenance and IT costs
- Each user can log in from any device connected to the network with user/ password access

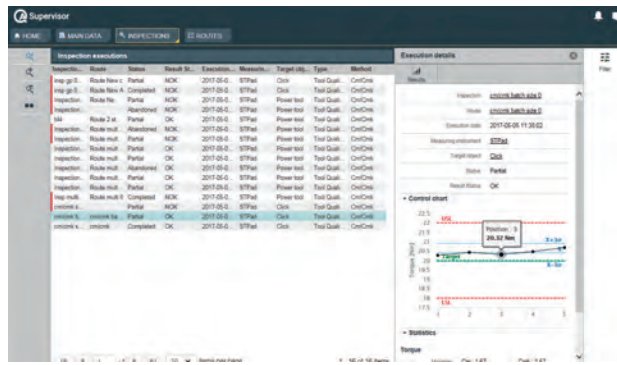

## QA SUPERVISOR

Description	Ordering No.	Description	Ordering No.
<b>Electronic delivery</b>		<b>Physical delivery</b>	
Tool Check	8059 0982 00	Tool Check	8059 0982 30
Joint Check	8059 0982 01	Joint Check	8059 0982 31
Dimensional Check	8059 0982 02	Dimensional Check	8059 0982 32
Visual Check	8059 0982 03	Visual Check	8059 0982 33
STa6000 only Tool Check	8059 0982 04	STa6000 only Tool Check	8059 0982 34
1 more device	8059 0982 08	1 more device	8059 0982 38
5 more devices	8059 0982 09	5 more devices	8059 0982 39
10 more devices	8059 0982 10	10 more devices	8059 0982 40
More than 30 devices	8059 0982 11	More than 30 devices	8059 0982 41
QA Supervisor JSB client	8059 0982 20	QA Supervisor JSB client	8059 0982 50
VDI Norms	8059 0982 14	VDI Norms	8059 0982 44
Dashboard	8059 0982 15	Dashboard	8059 0982 45

## Where the joints are critical

*Critical fastening duties are among the most essential tightening operations within industry today. So whether you're in the business of assembling cars or trucks, tractors or harvesters, trains or planes, you need to be in control when it comes to production and quality assurance.*

### **STWRENCH**

The Atlas Copco STwrench is much more than a standard transducerized hand-held nutrunner. Due to its modular design, you can build the STwrench to meet your exact requirements and create a tool that perfectly matches your applications.

Use the STwrench for production to get full traceability of the entire tightening operation, including torque control, angle control and yield control. Or build your wrench to just tighten your joint with high torque accuracy. Or use it for quality control to check residual torque, to perform joint analysis, including joint behaviour and stiffness, to set the correct tightening parameters for production and to test the reproducibility of joint stiffness on the benches.

### **THE ULTIMATE WRENCH FOR PRODUCTION AND QUALITY ASSURANCE**

With the STwrench you can build the functionality you need into your own tool. Choose three patented components – smartHEAD, RBU and the power supply-solution to suit your exact requirements. Then add a fourth: the patented controller that is standard for all STwrenches. Due to the modular design of the STwrench, you can mix and match components to suit all types of applications.

Use it as a basic stand-alone system or integrate it with Atlas Copco hardware and software. The STwrench is versatile enough to tighten hard-to-reach bolts using a variety of torque and angle strategies while providing complete traceability. Yet it handles quality control of residual torque just as easily as it does comprehensive joint analysis.

The STwrench implements a patented residual torque/angle measurement algorithm to measure the torque left on the joints by the tools in production. The STwrench residual torque/angle algorithm makes the residual torque check operator independent.



Furthermore, as the residual point is detected in real time, buzzer, LEDs and vibration alert the operator to stop, avoiding overtorquing.

### **SMARTHEAD**

The smartHEAD has a built-in memory chip to store calibration values that are automatically recognized by the STwrench controller. Choose from nine different sizes ranging from 15 to 1000 Nm, which is connected to the controller by a patented system allowing a fast connection. It can be with or without Gyroscope and the torque transducer is made to guarantee length-independent

reading. TAG recognition patented solution is used to assure Poka-Yoke operations. It includes at front a Led bright light to improve visibility in dark bolt area.

### **STWRENCH CONTROLLER**

This is the brain of the wrench. It has a clear and visible display, LED ring, vibrating handle and buzzer for immediate feedback to the operator. It has dedicated slots where you can insert the RBU, one wireless module and the Bar Code Module (see Optional Accessories).

The STwrench Controller can be powered by a patented bi-energy solution such as the long life STwrench Battery or by Tensor SL connected to the Power Focus via the STwrench Cable Box.

## STWRENCH RBU

Atlas Copco's patented Rapid Backup Unit (RBU) concept transfers functionality to a non-configured hardware unit,

ensuring that hardware can easily be upgraded. The RBU also acts as back-up for programming and configuration. If a change of hardware is required, just fit the RBU to the new hardware, switch on the unit and you're ready. All programming and network configurations are transferred in seconds. The RBU cuts downtime to a minimum.

## OPEN PROTOCOL AND API

The STwrench can be easily and wirelessly integrated with Customer systems thanks to the Open Protocol communication.

For more advanced integration, also the API are available in combination with the dedicated API RBU to integrate one or more STwrench in Customers' systems.

## Functionality Overview

FUNCTIONALITY	QUALITY		PRODUCTION		FUNCTIONALITY	QUALITY		PRODUCTION	
	SmartHEAD	smartHEAD A	smartHEAD	smartHEAD A		SmartHEAD	smartHEAD A	smartHEAD	smartHEAD A
<b>Controller</b>					<b>PSET</b>				
360° LED lights on board for operator feedback	x	x	x	x	Number of Psets	200	200	200	200
Keyboard	x	x	x	x	Batch count	x	x	x	x
Graphic Display	x	x	x	x	Number of job	255	255	255	255
USB mini to connect ToolsTalk BLM	x	x	x	x	Number of multistage	200	200	200	200
Infrared communication	x	x	x	x	CW/CCW operation	x	x	x	x
Buzzer	x	x	x	x	Bending correction		x		x
Rapid Back Up Unit (RBU)	x	x	x	x	Extension torque correction	x	x	x	x
Vibration	x	x	x	x	Extension angle correction		x		x
Shock detector	x	x	x	x					
<b>smartHEAD</b>					<b>General</b>				
Interchangeable head – Tag recognition	x	x	x	x	Transducer torque traceability	x	x	x	x
Light in front of smartHEAD	x	x	x	x	Result data storage	5000	5000	5000	5000
Gyroscope for angle measurement		x		x	Trace storage	10	10	10	10
Length-independent torque transducer	x	x	x	x	SPC	x	x	x	x
					Multi units (Nm, Kg/m)	x	x	x	x
<b>Free mode – programs</b>					Multi language menu	x	x	x	x
Track torque	x	x	x	x	Interchangeable head – Tag recognition writing function	x	x	x	x
Peak torque	x	x	x	x					
Track angle		x		x	<b>Connectivity</b>				
Residual check torque/time	x	x	x	x	PF connectivity for I/O or any type of fieldBus	x	x	x	x
Residual check torque/angle		x		x	ToolsNet	x	x	x	x
Tightening torque with angle monitoring		x		x					
<b>Quality audit</b>					<b>Optional</b>				
Peak	x	x	x	x	Barcode Reader	x	x	x	x
Residual Check Torque/Time	x	x	x	x	IRC-W	x	x	x	x
Residual Check Torque/Angle		x		x	IRC-B for Power Focus connectivity	x	x	x	x
Loosen And Retighten		x		x					
<b>Joint Analysis</b>					<b>ToolsTalk BLM</b>				
Torque/angle graphing		x		x	USB Connection	x	x	x	x
Yield point detection		x		x	Off Line programming	x	x	x	x
<b>Tightening</b>					Tightening Database to PC (Excel)	x	x	x	x
Torque with time monitoring			x	x	View trace	x	x	x	x
Torque with angle monitoring				x	Export trace in several formats	x	x	x	x
Torque plus angle				x	Overlay Traces	x	x	x	x
Yield				x	Trace zoom	x	x	x	x
Yield plus angle				x	Statistical analysis	x	x	x	x
Loose		x		x	Bar code reader configuration	x	x	x	x
Prevailing torque				x					



## SMARTHEADS AND CONTROLLER

Square connection smartHEAD have been added to the range of smartHEADs. The square connection smartHEADs allow customers to use any square end fitting a losing thought the poka yoke system offered by end fittings in this catalogue.

BI controller is the new controller with the battery inserted in the STwrench handle. New batteries are to be used only in this controller. Recharge these batteries using standard battery charger with BI battery charger adapter.

## HOW TO ORDER YOUR STWRENCH

1. Take the STwrench Controller
2. Select your smartHEAD
3. Select your End fitting tool
4. Select your RBU
5. Select the Battery
6. Select if you want optional modules



Model	Torque range		Drive mm	Weight		Length mm	Ordering No.
	Nm	ft lb		kg	lb		
<b>Controller</b>							
STwrench Controller				0.48	1.08	313	8059 0930 00
STwrench Controller BI				0.46	1.01	333	8059 0930 01
STwrench Controller Heavy Duty				0.98	2.08	313	8059 0930 03
<b>smartHEAD only Torque</b>							
smartHEAD 30	6-30	4.5-22	9x12	0.20	0.44	167.5	8059 0920 31
smartHEAD 80	16-80	12-59	9x12	0.22	0.48	167.5	8059 0920 43
smartHEAD 150	30-150	23-111	14x18	0.55	1.21	271.0	8059 0920 48
smartHEAD 250	50-250	37-184	14x18	0.78	1.72	417.0	8059 0920 54
smartHEAD 400	80-400	59-295	14x18	0.93	2.05	584.0	8059 0920 60
smartHEAD 600	120-600	89-443	21x26	1.70	3.75	1048.5	8059 0920 66
smartHEAD 1000	300-1000	148-737	28	1.90	4.19	1344	8059 0920 80
<b>smartHEAD A Torque + Angle</b>							
smartHEAD A15	3-15	2.2-11	9x12	0.19	0.42	147.5	8059 0930 24
smartHEAD A30	6-30	4.5-22	9x12	0.19	0.42	147.5	8059 0930 31
smartHEAD A80	16-80	12-59	9x12	0.20	0.44	147.5	8059 0930 43
smartHEAD A150	30-150	23-111	14x18	0.57	1.25	271.0	8059 0930 48
smartHEAD A250	50-250	37-184	14x18	0.80	1.76	417.0	8059 0930 54
smartHEAD A400	80-400	59-295	14x18	0.95	2.09	584.0	8059 0930 60
smartHEAD A600	120-600	89-443	21x26	1.72	3.79	1048.5	8059 0930 66
smartHEAD A800	160-800	118-590	21x26	1.70	3.75	1048.5	8059 0988 26
smartHEAD A1000	300-1000	148-737	28	1.90	4.19	1344	8059 0930 80
<b>smartHEAD A Torque + Angle sq<sup>a</sup></b>							
smartHEAD Asq15	3-15	2.2-11	9x12	0.19	0.42	147.5	8059 0930 28
smartHEAD Asq30	6-30	4.5-22	9x12	0.19	0.42	147.5	8059 0930 32
smartHEAD Asq80	16-80	12-59	9x12	0.20	0.44	147.5	8059 0930 44
smartHEAD Asq150	30-150	23-111	14x18	0.55	1.21	271.0	8059 0930 50
smartHEAD Asq250	50-250	37-184	14x18	0.78	1.72	417.0	8059 0930 56
smartHEAD Asq400	80-400	59-295	14x18	0.93	2.05	584.0	8059 0930 62
<b>RBU Rapid Backup unit</b>							
STwrench RBU Quality							8059 0930 90
STwrench RBU Production							8059 0930 91
STwrench RBU Quality API							8059 0930 93
STwrench RBU Production API							8059 0930 92
<b>Battery</b>							
STwrench battery							8059 0930 86
STwrench battery BI							8059 0930 85
STwrench battery HD							8059 0930 83

## SOFTWARE TT BLM W09

	Ordering No.
1 user license	8059 0981 10
5 user license	8059 0981 11
10 user license	8059 0981 12
Plant license	8059 0981 13

## Dimensions

<sup>a</sup>For standard end fittings.

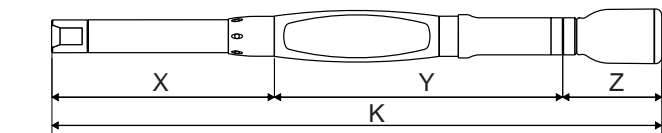

STwrench

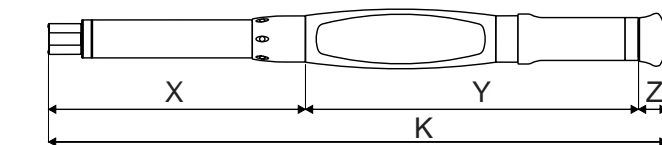

STwrench BI

Model	Length				Total weight	
	X mm	Y mm	Z mm	K mm	kg	lb
STwrench 15 Nm	139	280	96	515	1.00	2.20
STwrench 30 Nm	139	280	96	515	1.03	2.27
STwrench 80 Nm	139	280	96	515	1.06	2.34
STwrench 150 Nm	262	280	96	638	1.28	2.82
STwrench 250 Nm	408	280	96	784	1.51	2.33
STwrench 400 Nm	575	280	96	951	1.71	2.77
STwrench 600 Nm	1040	280	96	1416	2.87	6.33
STwrench 800 Nm	1040	280	96	1416	2.87	6.33
STwrench 1000 Nm	1270	280	96	1646	3.72	8.20
STwrench BI 15 Nm	139	280	32	441	0.80	1.76
STwrench BI 30 Nm	139	280	32	441	0.83	1.83
STwrench BI 80 Nm	139	280	32	441	0.86	1.89
STwrench BI 150 Nm	262	280	32	564	1.08	2.38
STwrench BI 250 Nm	408	280	32	710	1.31	2.89
STwrench BI 400 Nm	576	280	32	877	1.51	3.33
STwrench BI 600 Nm	1040	280	32	1341	2.67	5.89
STwrench BI 800 Nm	1040	280	32	1341	2.67	5.89
STwrench BI 1000 Nm	1270	280	32	1571	3.52	7.76

X. – smartHEAD, Y. – STwrench Controller, Z. – Battery, K. – Total length

## IRC MODULES

Two different IRC modules each with different wireless technology. No extra special software is needed, it is necessary only to plug in the new module to activate the communication. The communication can be to the Power Focus, to the QAT node, to the STwrench cradles or to different systems on the net. The radio modules Plus versions features a more powerful antenna for more stable connection and improved communication range.

**NOTE:** As the dimensions are bigger, a different cover needs to be mounted.

## BAR CODE MODULE

Enables the Bar Code to be read. STwrench is able to handle four different Bar Codes that can be used to activate or control the process and for traceability purposes. It is only necessary to plug in the module to activate the function.

## STWRENCH BATTERY

All batteries are lithium ion ones. The standard battery gives up to 16 h of working time (10 h if wireless communication is used). BI and HD batteries have a working time of 6 h (4 h with wireless communication). Use the standard or the HD battery with the standard controller. BI batteries are only for BI controllers.

## STWRENCH CABLE BOX

Wired to connect the STwrench to the Power Focus using a standard Tensor SL cable. The STwrench cable box supplies power to the wrench and handles the communication between the wrench and the Power Focus.

## STWRENCH BATTERY CHARGER

To recharge the battery, it can be mounted in a horizontal or vertical position, it takes 4 hours to complete recharge the STwrench battery.

## POWER FOCUS

For fieldbus connectivity and additional I/O port, or for backup station, the STwrench can be connected in wireless with PF or IRC Focus. It allow also the possibility to connect all QIF accessories such as stack light etc ...

## TOOL HOLDER

The tool holder is a cradle for the STwrench that can be mounted either on a table or on a wall, providing a safe housing for the wrench.

## RUBBER PROTECTION

Rubber protections for the STwrench provide both a protection for surfaces that come in contact with the wrench and a better grip for the user. Choose a rubber protection for each of the sections of the STwrench.

	Ordering No.
IRC-B Module	8059 0920 10
IRC-W Module	8059 0920 15
IRC-W Plus	8059 0920 16
IRC-B Plus	8059 0920 17
Back cover Plus	4612 2449 56
Bar Code	8059 0920 12
Battery	8059 0930 86
Battery BI	8059 0930 85
Battery HD	8059 0930 83
Battery charger	8059 0930 88
Battery charger adapter BI	8059 0930 89
Cable box	8059 0920 24
Tool holder	8059 0930 70
Controller rubber protection	8059 0930 72
Standard Battery rubber protection	8059 0930 73
30/80 Nm smarHEAD rubber protection	8059 0930 74
150 Nm smarHEAD rubber protection	8059 0930 75
250 Nm smarHEAD rubber protection	8059 0930 76
400 Nm smarHEAD rubber protection	8059 0930 79



IRC-module



Battery



Bar Code



Tool holder



Battery charger



# End Fittings for STwrench

## Standard end fitting tools with TAG

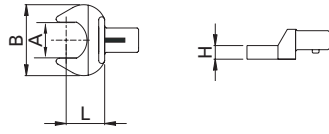

Type	A mm	B mm	H mm	L mm	g	Ordering No.	
Open end 9 x 12	7	22	5	17.5	40	4620 0001 00	
	8	22	5	17.5	39	4620 0002 00	
	9	26	5.5	17.5	38	4620 0003 00	
	10	26	5.5	17.5	42	4620 0004 00	
	11	26	5.5	17.5	41	4620 0005 00	
	12	30	7	17.5	43	4620 0006 00	
	13	30	7	17.5	48	4620 0007 00	
	14	35	8	17.5	52	4620 0008 00	
	15	35	8	17.5	51	4620 0009 00	
	16	38	8.5	17.5	58	4620 0010 00	
	17	38	8.5	17.5	60	4620 0011 00	
	18	42	9	20	71	4620 0012 00	
	19	42	9	20	74	4620 0013 00	
	14 x 18	13	30	7	25	128	4620 0049 00
		14	35	8	25	129	4620 0050 00
		15	35	8	25	132	4620 0051 00
		16	38	9	25	140	4620 0052 00
		17	38	9	25	136	4620 0053 00
		18	42	10	25	147	4620 0054 00
19		42	10	25	147	4620 0055 00	
21		50	11	25	171	4620 0056 00	
22		50	11	25	165	4620 0057 00	
24		53	12	25	167	4620 0058 00	
27		60	13	30	219	4620 0059 00	
30		66	14	30	245	4620 0060 00	
32		66	14	32.5	246	4620 0061 00	
34		66	14	32.5	239	4620 0062 00	

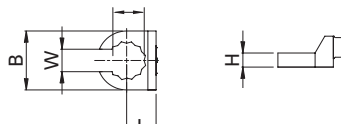

Type	Hex mm	B mm	H mm	W mm	L mm	g	Ordering No.
Flared end 9 x 12	10	22	12	7.1	17.5	57	4620 0028 00
	11	22.5	12	8.6	17.5	55	4620 0029 00
	12	23.5	12	9	17.5	59	4620 0030 00
	13	25.2	12	10	17.5	55	4620 0031 00
	14	27	13	11	17.5	60	4620 0032 00
	16	30	13	13	17.5	65	4620 0033 00
	17	31.5	13	14	17.5	65	4620 0034 00
	18	33	15	14.8	17.5	74	4620 0035 00
	19	34.5	15	15.8	19	80	4620 0036 00
	21	37.5	15	16.2	19	88	4620 0037 00
	22	39	15	17	19	92	4620 0038 00
	24	42	15	18	19	75	4620 0039 00

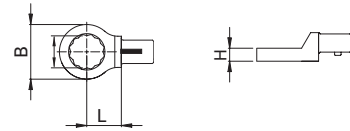

Type	Hex mm	B mm	H mm	L mm	g	Ordering No.
Ring end 9 x 12	7	13	8	17.5	37	4620 0014 00
	8	14.2	8	17.5	40	4620 0015 00
	10	17.2	9	17.5	44	4620 0016 00
	11	18.5	9	17.5	41	4620 0017 00
	12	20	12	17.5	49	4620 0018 00
	13	21.5	12	17.5	56	4620 0019 00
	14	23	12	17.5	52	4620 0020 00
	15	24.2	12	17.5	52	4620 0021 00
	16	25.7	13	17.5	54	4620 0022 00
	17	27.2	13	17.5	59	4620 0023 00
	18	28.5	13	17.5	56	4620 0024 00
	21	33	15	17.5	71	4620 0026 00
	22	34.5	15	17.5	74	4620 0027 00
	14 x 18	13	21.5	11	25	127
14		23	11	25	123	4620 0064 00
15		24.2	11	25	128	4620 0065 00
16		25.7	12	25	133	4620 0066 00
17		27.2	12	25	135	4620 0067 00
18		28.5	12	25	134	4620 0068 00
19		30.5	12	25	138	4620 0069 00
21		33	15	25	144	4620 0070 00
22		34.5	15	25	145	4620 0071 00
24		37.5	15	25	153	4620 0072 00
27		41.5	17	25	162	4620 0073 00
30		45	19	25	182	4620 0074 00
32		47.5	19	25	181	4620 0075 00
34		50.5	19	28	210	4620 0076 00
36		53	19	28	203	4620 0077 00
41		59	20	30	240	4620 0078 00

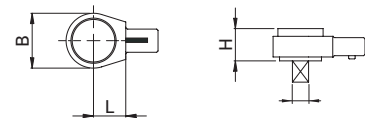

Type	Hex in	B mm	H mm	L mm	g	Ordering No.
Reversible ratchet 9 x 12	1/4	22	14.5	17.5	62	4620 0043 00
	3/8	33	24	17.5	136	4620 0044 00
	1/2	33	28.3	17.5	147	4620 0045 00
14 x 18	1/2	43	26.2	25	302	4620 0081 00 <sup>a</sup>
	3/4	50	30.7	25	467	4620 0082 00
21 x 26	3/4	69	30	62.5	1350	4620 0086 00
Ø 28	1	74	34	68	1840	4620 0088 00

The TAG placed on the ratchet defines the Pset.

<sup>a</sup> NOTE: The maximum torque which can be applied with 4620 0081 00 is 300 Nm.

NOTE: Since several sockets could be used, it is recommended to hold the socket in such a way that it is not possible to remove it (e.g. using a pin).

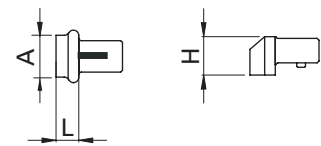

Type	A mm	H mm	L mm	g	Ordering No.
Blank end 9 x 12 for making up specials	8 x 14	14.5	8	30	4620 0048 00
Blank end 14 x 18	11 x 25	21.5	21	98	4620 0084 00
	21 x 26	13 x 30	30	13	220

## Standard end fitting tools without TAG

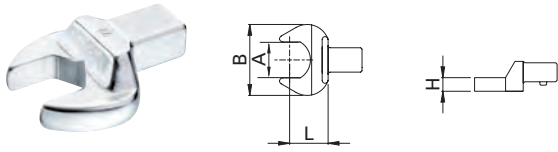

Type	A mm	B mm	H mm	L mm	g	Ordering No.	
<b>Open end 9 x 12</b>	7	22	5	17.5	40	8059 0975 00	
	8	22	5	17.5	39	8059 0975 01	
	9	26	5.5	17.5	38	8059 0975 02	
	10	26	5.5	17.5	42	8059 0975 03	
	11	26	5.5	17.5	41	8059 0975 04	
	12	30	7	17.5	43	8059 0975 05	
	13	30	7	17.5	48	8059 0975 06	
	14	35	8	17.5	52	8059 0975 07	
	15	35	8	17.5	51	8059 0975 08	
	16	38	8.5	17.5	58	8059 0975 09	
	17	38	8.5	17.5	60	8059 0975 10	
	18	42	9	20	71	8059 0975 11	
	19	42	9	20	74	8059 0975 12	
	<b>14 x 18</b>	13	30	7	25	128	8059 0976 00
		14	35	8	25	129	8059 0976 01
		15	35	8	25	132	8059 0976 02
		16	38	9	25	140	8059 0976 03
		17	38	9	25	136	8059 0976 04
18		42	10	25	147	8059 0976 05	
19		42	10	25	147	8059 0976 06	
21		50	11	25	171	8059 0976 07	
22		50	11	25	165	8059 0976 08	
24		53	12	25	167	8059 0976 09	
27		60	13	30	219	8059 0976 10	
30		66	14	30	245	8059 0976 11	
32		66	14	32.5	246	8059 0976 12	
34		66	14	32.5	239	8059 0976 13	

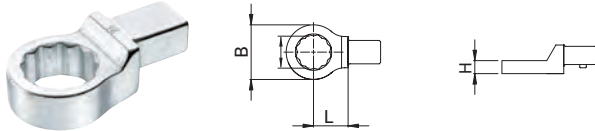

Type	Hex mm	B mm	H mm	L mm	g	Ordering No.
<b>Ring end 9 x 12</b>	7	13	8	17.5	37	8059 0975 13
	8	14.2	8	17.5	40	8059 0975 14
	10	17.2	9	17.5	44	8059 0975 15
	11	18.5	9	17.5	41	8059 0975 16
	12	20	12	17.5	49	8059 0975 17
	13	21.5	12	17.5	56	8059 0975 18
	14	23	12	17.5	52	8059 0975 19
	15	24.2	12	17.5	52	8059 0975 20
	16	25.7	13	17.5	54	8059 0975 21
	17	27.2	13	17.5	59	8059 0975 22
	18	28.5	13	17.5	56	8059 0975 23
	19	30.3	13	17.5	65	8059 0975 24
	21	33	15	17.5	71	8059 0975 25
	22	34.5	15	17.5	74	8059 0975 26
<b>14 x 18</b>	13	21.5	11	25	127	8059 0976 14
	14	23	11	25	123	8059 0976 15
	15	24.2	11	25	128	8059 0976 16
	16	25.7	12	25	133	8059 0976 17
	17	27.2	12	25	135	8059 0976 18
	18	28.5	12	25	134	8059 0976 19
	19	30.5	12	25	138	8059 0976 20
	21	33	15	25	144	8059 0976 21
	22	34.5	15	25	145	8059 0976 22
	24	37.5	15	25	153	8059 0976 23
	27	41.5	17	25	162	8059 0976 24
	30	45	19	25	182	8059 0976 25
	32	47.5	19	25	181	8059 0976 26
	34	50.5	19	28	210	8059 0976 27
	36	53	19	28	203	8059 0976 28
41	59	20	30	240	8059 0976 29	

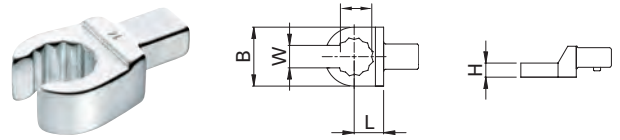

Type	Hex mm	B mm	H mm	W mm	L mm	g	Ordering No.
<b>Flared end 9 x 12</b>	10	22	12	7.1	17.5	57	8059 0975 27
	11	22.5	12	8.6	17.5	55	8059 0975 28
	12	23.5	12	9	17.5	59	8059 0975 29
	13	25.2	12	10	17.5	55	8059 0975 30
	14	27	13	11	17.5	60	8059 0975 31
	16	30	13	13	17.5	65	8059 0975 32
	17	31.5	13	14	17.5	65	8059 0975 33
	18	33	15	14.8	17.5	74	8059 0975 34
	19	34.5	15	15.8	19	80	8059 0975 35
	21	37.5	15	16.2	19	88	8059 0975 36
	22	39	15	17	19	92	8059 0975 37
	24	42	15	18	19	75	8059 0975 38

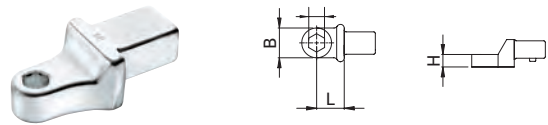

Type	Hex in	B mm	H mm	L mm	g	Ordering No.
<b>Bits holder 9 x 12</b>	1/4	14	10	17.5	50	8059 0975 45
	5/16	16	12.5	17.5	47	8059 0975 46
	5/16	16	12.5	25	112	8059 0976 34
<b>14 x 18</b>						

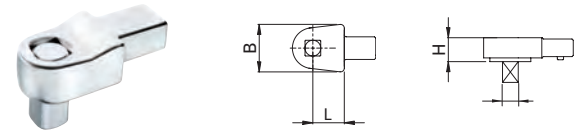

Type	Hex in	B mm	H mm	L mm	g	Ordering No.
<b>Fixed square 9 x 12</b>	1/4	22	14	17.5	71	8059 0975 39
	3/8	22	14	17.5	76	8059 0975 40
	1/2	22	14	17.5	82	8059 0975 41
	<b>14 x 18</b>					
	1/2	30	18	25	203	8059 0976 30
	3/4	40	25	25	396	8059 0976 31

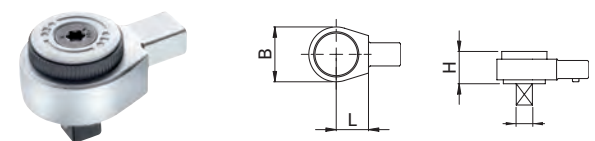

Type	Hex in	B mm	H mm	L mm	g	Ordering No.	
<b>Reversible ratchet 9 x 12</b>	1/4	22	14.5	17.5	62	8059 0975 42	
	3/8	33	24	17.5	136	8059 0975 43	
	1/2	33	28.3	17.5	147	8059 0975 44	
	<b>14 x 18</b>						
	1/2	43	26.2	25	302	8059 0976 32 <sup>a</sup>	
<b>14 x 18</b>	3/4	50	30.7	25	467	8059 0976 33	
	21 x 26	3/4	69	30	62.5	1350	8059 0976 38
	Ø 28	1	74	34	68	1840	8059 0976 40

<sup>a</sup> NOTE: The maximum torque which can be applied with 4620 0081 00 is 300 Nm.

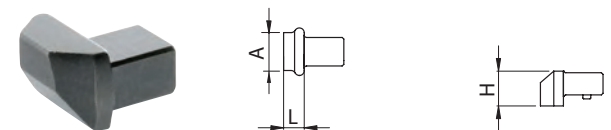

Type	A mm	H mm	L mm	g mm	Ordering No.
<b>Blank end 9 x 12 for making up specials</b>	8 x 14	14.5	8	30	8059 0975 47
<b>Blank end 14 x 18</b>	11 x 25	21.5	21	98	8059 0976 35
<b>21 x 26</b>	13 x 30	30	13	220	8059 0976 36

### Mechanical wrench series

*The mechanical wrenches in the Atlas Copco Saltus product line form the basis for manual tightening. They enable you to find the optimal solution for your individual tightening situation regardless whether you are working in assembly lines, rework or repair and maintenance, and even when limited operating space is available.*

The wrenches are also the perfect back-up strategy for your controlled assembly technology.

With regard to workplace equipment and costs, manual tightening wrenches are often more efficient and increase your productivity. The easy handling has earned wide acceptance among operators.

Our different wrench types offer the right strategy for nearly any application.

#### **CWR 'CLICK' WRENCH SERIES**

The torque wrenches in our CWR series provide the distinctive “click” which is a very clear feedback when reaching the pre-set torque value. The repeatability of  $\pm 4\%$  makes them perfect for use in assembly lines.

Standard drive enables the use of a wide range of suitable end fittings.

#### **BWR 'BREAKING' WRENCH SERIES**

The torque wrenches in our BWR series are primarily used in professional industrial environments. The possibility of over-tightening is significantly reduced due to a  $22^\circ$  breaking-angle of the unique BWR mechanism. Therefore, the BWR wrenches are very well-suited for use in assembly lines as well as for repair and maintenance.

You can profit from a wide range of end fittings which are quickly changed.

#### **MICROSWITCH ADAPTOR**

This new adaptor upgrades your click or breaking wrenches into a signal transmitting wrench. Connected via cable to a customer's PLC system, this adaptor can support control functionalities as batch counting and line control.



#### **SWR 'SLIPPING' WRENCH SERIES**

The torque wrenches in the SWR series are “automatically triggered” once the pre-set torque value is reached. The Camover-technology completely avoids over-tightening. After triggering, the SWR wrench is again ready to use. The integrated ratchet function ensures you controlled clockwise tightening. The high repeating accuracy with a tolerance of  $\pm 4\%$  makes the SWR wrenches ideal for assembly lines for extreme continuous operation.

## CWR 'CLICK' WRENCH SERIES

- Wide range from 2Nm up to 300 Nm.
- Very small sizes ideal for tightening in limited space.
- Repeatability of  $\pm 4\%$ .
- Easy and safe adjusting and handling.
- Standard drive (9x12 or 14x18) for a wide range of suitable end fittings.

## BWR – 'BREAKING' WRENCH SERIES

- High process reliability as over-tightening is significantly reduced due to the 22° breaking angle.
- Wide range of wrenches from 2Nm up to 2000Nm.
- BWR-D models allow use of standardized end fittings with 9x12 or 14x18 drive.
- Extremely high durability and high repeatability of  $\pm 4\%$ .
- Robust construction.
- Easy and safe adjusting.

## SWR 'SLIPPING' WRENCH SERIES

- Torque range from 5Nm up to 110Nm.
- High process reliability as camover mechanism avoids over-tightening.
- Overloading of the wrench itself is impossible.
- Repeatability of  $\pm 4\%$ .
- Robust construction.
- Easy and safe adjusting.
- 3/8" (SWR-30 / SWR-60) respectively 1/2" (SWR-110) ratchet drive allows use of standard sockets.

## MICROSWITCH ADAPTOR

- Upgrades CWR or BWR wrenches (as seen from revision D) into signal transmitting devices.
- Easy support of control functionalities as batch counting and line control.



Model	Torque range		Length mm	Weight		Ø mm	Drive	Ordering No.
	Nm	ft lb		kg	lb			
<b>CWR models</b>								
CWR-20	3-20	2.2-14.8	129	0.248	0.547	21	9x12	8439 0041 00
CWR-25	2-25	1.5-18.4	174	0.288	0.635	21	9x12	8439 0041 01
CWR-50	5-50	3.7-37	236	0.466	1.027	21	9x12	8439 0041 02
CWR-85	15-85	11-62.7	305	0.576	1.270	21	9x12	8439 0041 03
CWR-120	50-120	37-88.5	349	0.666	1.468	24	9x12	8439 0041 04
CWR-200	50-200	37-148	419	0.916	2.019	30x26	14x18	8439 0041 05
CWR-300	60-300	44.2-221	685	1.366	3.012	32x28	14x18	8439 0041 06
<b>BWR models</b>								
BWR-20 D	02-20	1.5-14.8	275	0.540	1.190	21	9x12	8439 0042 20
BWR-35 D	05-35	3.7-25.8	275	0.715	1.576	21	9x12	8439 0042 21
BWR-100 D	20-100	14.8-74	410	1.232	2.716	24	9x12	8439 0042 22
BWR-240 D	80-240	59-177	677	2.529	5.575	36	14x18	8439 0042 23
BWR-440 D	140-440	103.0-324.5	857	4.690	10.340	36	14x18	8439 0042 24
BWR-750	300-750	221-553	961	6.400	14.110	20x41	BWR-750	8439 0042 05
BWR-1300	500-1300	369-959	1256	8.140	17.946	21x45	BWR-1300	8439 0042 06
BWR-2000	800-2000	590-1475	1982	13.450	29.652	21x45	BWR-2000	8439 0042 07
<b>SWR models</b>								
SWR-30	5-30	3.7-22	269	0.640	1.411	–	3/8"	8439 0043 00
SWR-60	15-60	11-44	354	1.050	2.315	–	3/8"	8439 0043 01
SWR-110	40-110	29.5-96	453	1.900	4.189	–	1/2"	8439 0043 02
<b>Microswitch adaptor</b>								
Microswitch adaptor kit for BWR-240 D								4027 5009 93
Microswitch adaptor kit for BWR-440 D								4027 5009 94
Microswitch	–	–	60	0.111	0.245	42	M18x1.5	4027 5015 90
Helix cable	–	–	2-6	0.341	0.752	–	–	8439 0030 00
Hook spanner				42				4027 5015 89



Microswitch adaptor



CWR with Microswitch adaptor

## Accessories

### PROTECTION CAPS

Model	Ordering No.
<b>MWR / CWR protection cap</b>	
5 pcs (blue)	4027 5022 20
5 pcs (green)	4027 5022 21
5 pcs (red)	4027 5022 22
5 pcs (Colormix)	4027 5022 23
5 pcs (gold)	4027 5022 24
5 pcs (black)	4027 5022 25





# MWR Mechatronic system – more than a click!

*Increase the quality of your joints considerably with the error proofing functionalities of the MWR mechatronic system. Combining the productivity of a click wrench with the traceability of an electronic one, this smart manual fastening system optimizes your tightening processes enormously. The online results provide a complete traceability of the tightening process.*

### **MWR MECHATRONIC WRENCH SERIES**

Based on the mechanical “click” wrench the MWR mechatronic wrench is highly productive. The clear physical feedback with the distinctive “click” in combination with the colored LEDs makes it easy to handle even for untrained workers.

Size and performance makes the MWR wrenches optimal for limited space applications with all functionalities in a compact size. Thanks to standard drive (9x12 and 14x18), the operator can choose from a wide range of end fittings for his application.

Two different models offer the right strategy depending on customers' needs and application:

- MWR-S (OK signal only)
- MWR-TA (Torque and angle measurement).

Clean up your work areas with the MWR charging cradle, a stable holder and battery charger, which ensures that the wrench is always ready for performance.

### **CONTROLLER FOCUS 61**

In combination with the controller Focus 61 the MWR mechatronic wrench series offers a controlled tightening process monitoring torque, angle and correct time of release. An optional stacklight connected to the Focus controller signals the status or any error of the tightening.

The Focus controller handles the process and collects all data reporting all results in real time for full traceability. While managers can monitor everything via ToolsNet.





# MWR Mechatronic Wrench

## MWR MECHATRONIC WRENCH SERIES

- High process reliability thanks to complete process monitoring.
- Wide range from 5 - 300 Nm.
- Small size of 177 mm makes the MWR-25 ideal for tightening in limited space.
- MWR-S: OK signal only.
- MWR-TA: torque and angle measurement.
- Colored LEDs for clear feedback.
- Standard drive (9x12 and 14x18) for wide range of end fittings.

MWR-25



MWR-50



Model	Torque range		Length mm	Weight		Drive	Ordering No.
	Nm	ft lb		kg	lb		
MWR-25 S	5-25	3.7-18.4	177	0.446	0.983	9x12	8439 0044 00
MWR-50 S	10-50	7.4-36.9	234	0.565	1.246	9x12	8439 0044 01
MWR-85 S	17-85	12.5-62.7	307	0.630	1.389	9x12	8439 0044 02
MWR-200 S	40-200	29.5-147.5	419	0.851	1.876	14x18	8439 0044 03
MWR-300 S	60-300	44.2-221.2	898	2.5	5.512	14x18	8439 0044 04
MWR-25 TA	5-25	3.7-18.4	177	0.446	0.983	9x12	8439 0044 20
MWR-50 TA	10-50	7.4-36.9	234	0.565	1.246	9x12	8439 0044 21
MWR-85 TA	17-85	12.5-62.7	307	0.630	1.389	9x12	8439 0044 22
MWR-200 TA	40-200	29.5-147.5	419	0.851	1.876	14x18	8439 0044 23
MWR-300 TA	60-300	44.2-221.2	898	2.5	5.512	14x18	8439 0044 24

## Accessories

Model	Ordering No.
Charging cradle	4027 5022 10
Setting key	4027 5013 96
Protection cover	4027 5026 28
Charging cradle clips (HD)	4027 5026 14
Recharg. battery, NIMH AAA MWR 1.2 V, 1000 mAh	4027 5021 01
Stacklight ESL-04 Standard	8433 0570 13
IO Expander (open)	8433 0564 39
IO Expander (sealed)	8433 0564 45

### MWR -KIT

Model	Ordering No.
MWR - KIT <sup>a</sup>	4027 5022 06
MWR - KIT Power supply	4027 5022 11

<sup>a</sup> MWR-KIT does not come with power supply and it must be ordered separately.



Charging cradle

### ANTENNAS

Model	Ordering No.
Antenna, 868 MHz	4027 5022 13
Antenna, 915 MHz	4027 5022 14
Cable-antenna, 2,5 m 868/915 MHz	4027 5022 15
Extended cable-antenna, 5 m, 868/915 MHz	4027 5020 95



Protection cover



Setting key

## CONTROLLER FOCUS 61

- Easy data collection of all necessary tightening information
- Communication via ToolsNet and Atlas Copco Open Protocol



Focus 61

Model	Dimensions mm	Weight		Ordering No.
		kg	lb	
Focus 61	147x219x121	2.5	5.5	8439 0044 31

## Accessories

Model	Ordering No.
Focus 61 Dig. Out connector	4027 5022 04

## FUNCTIONALITY OVERVIEW

Controller	Focus 61
Number of workstations	2
Number of administrable MWR	10
Wireless wrench communication	•
Communication Standard	•
Communication Open Protocol	•
Toolsnet communication	•
TTBLM communication	•
Possibility to add protocols	•
LAN/Ethernet communication	•
LAN/Ethernet programming	•
Job programming	•
Batch programming	•
Results storage	25.000
Languages: English - German	•
Multi-unit	•
Display	•
BNC Antenna	•
LAN/Ethernet Interface	2
Barcode interface	•
Number of workstations	2
Number of wrenches	10
Communication	Open Protocol
Barcode	•
ToolsNet	•
Atlas Copco I/O Bus	•

# End fittings for CWR/BWR-D/MWR

## Open End

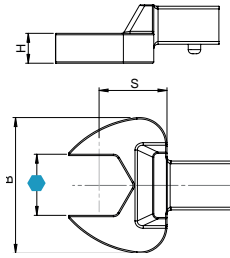

	mm/in	B mm	H mm	S mm	g	Max Nm	Ordering No.
<b>9 x 12</b>							
7	22	5	17.5	40	7	4027 5011 00	
8	22	5	17.5	39	10	4027 5011 01	
9	26	5.5	17.5	38	14	4027 5011 02	
10	26	5.5	17.5	42	20	4027 5011 03	
11	26	5.5	17.5	41	25	4027 5011 04	
12	30	7	17.5	43	32	4027 5011 05	
13	30	7	17.5	48	40	4027 5011 06	
14	35	8	17.5	52	50	4027 5011 07	
15	35	8	17.5	51	60	4027 5011 08	
16	38	8.5	17.5	58	70	4027 5011 09	
17	38	8.5	17.5	60	80	4027 5011 10	
18	42	9	20	71	100	4027 5011 11	
19	42	9	20	74	115	4027 5011 12	
20	42	9	20	76	115	4027 5011 13	
21	46	11	22	95	115	4027 5011 14	
22	46	11	22	95	115	4027 5011 15	
24	48	11	25	106	130	4027 5011 16	
27	58	13	30	235	150	4027 5011 17	
32	64	15	40	267	190	4027 5011 18	
1/4	22	5	17.5	37	7	4027 5010 00	
5/16	22	5	17.5	36	10	4027 5010 01	
3/8	26	5.5	17.5	38	20	4027 5010 02	
7/16	26	5.5	17.5	38	25	4027 5010 03	
1/2	30	7	17.5	47	32	4027 5010 04	
9/16	34	8	17.5	50	50	4027 5010 05	
5/8	38	8.5	17.5	56	70	4027 5010 06	
11/16	38	8.5	17.5	57	80	4027 5010 07	
3/4	42	9	20	71	115	4027 5010 08	
<b>14 x 18</b>							
13	30	7	25	128	40	4027 5011 21	
14	35	8	25	129	50	4027 5011 22	
15	35	8	25	132	60	4027 5011 23	
16	38	9	25	140	70	4027 5011 24	
17	38	9	25	136	80	4027 5011 25	
18	42	10	25	147	90	4027 5011 26	
19	42	10	25	145	95	4027 5011 27	
20	42	10	25	155	100	4027 5011 28	
21	50	11	25	171	130	4027 5011 29	
22	50	11	25	165	150	4027 5011 30	
24	53	12	25	167	180	4027 5011 31	
27	60	13	30	219	220	4027 5011 32	
28	60	13	30	222	250	4027 5011 33	
29	60	13	30	222	270	4027 5011 34	
30	66	14	30	245	300	4027 5011 35	
32	66	14	32.5	246	300	4027 5011 36	
34	66	14	32.5	239	300	4027 5011 37	
36	66	14	32.5	275	300	4027 5011 38	
7/16	30	7	25	127	40	4027 5010 50	
1/2	30	7	25	127	40	4027 5010 51	
9/16	35	8	25	132	50	4027 5010 52	
5/8	38	9	25	141	70	4027 5010 53	
11/16	38	9	25	136	80	4027 5010 54	
3/4	42	10	25	144	95	4027 5010 55	
13/16	50	11	25	160	150	4027 5010 56	
7/8	50	11	25	158	150	4027 5010 57	
15/16	53	12	25	176	180	4027 5010 58	
1	53	12	25	172	180	4027 5010 59	
1.1/8	60	13	30	223	220	4027 5010 60	

## Box End

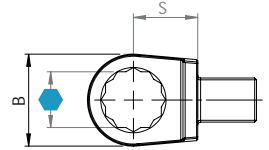

	mm/in	B mm	H mm	S mm	g	Max Nm	Ordering No.
<b>9 x 12</b>							
7	13	8	17.5	38	25	4027 5011 50	
8	13.5	8	17.5	37	35	4027 5011 51	
9	16	8	17.5	35	40	4027 5011 52	
10	18	9	17.5	40	55	4027 5011 53	
11	18.5	9	17.5	44	70	4027 5011 54	
12	20.5	11	17.5	41	85	4027 5011 55	
13	21.5	11	17.5	49	100	4027 5011 56	
14	25	12	17.5	55	115	4027 5011 57	
15	25	12	17.5	52	120	4027 5011 58	
16	26	12	17.5	54	120	4027 5011 59	
17	27	13	17.5	59	120	4027 5011 60	
18	28	13	17.5	56	120	4027 5011 61	
19	30.5	13	17.5	65	120	4027 5011 62	
21	33	15	17.5	71	120	4027 5011 63	
22	34.5	15	17.5	74	120	4027 5011 64	
1/4	13.5	8	17.5	39	25	4027 5010 13	
5/16	13.5	8	17.5	38	35	4027 5010 14	
3/8	18	8	17.5	41	55	4027 5010 15	
7/16	18	9	17.5	41	70	4027 5010 16	
1/2	22	12	17.5	51	100	4027 5010 17	
9/16	25	12	17.5	57	115	4027 5010 18	
5/8	27	13	17.5	61	120	4027 5010 19	
11/16	27	13	17.5	57	120	4027 5010 20	
3/4	30	13	17.5	62	120	4027 5010 21	
13/16	34	14.5	17.5	75	120	4027 5010 22	
7/8	34	15	20	77	120	4027 5010 23	
<b>14 x 18</b>							
13	22.5	11	25	130	100	4027 5011 67	
14	23	11	25	123	110	4027 5011 68	
15	24	11	25	128	120	4027 5011 69	
16	25.5	12	25	133	140	4027 5011 70	
17	27	12	25	135	160	4027 5011 71	
18	29	13	25	134	185	4027 5011 72	
19	30.5	13	25	138	210	4027 5011 73	
20	33	13	25	140	230	4027 5011 74	
21	33	15	25	144	260	4027 5011 75	
22	34.5	15	25	145	300	4027 5011 76	
24	37.5	15	25	153	350	4027 5011 77	
27	42.5	17	25	162	450	4027 5011 78	
30	46	19	25	182	550	4027 5011 79	
32	47.5	19	25	181	650	4027 5011 80	
34	52	19	28	210	650	4027 5011 81	
36	54	19	28	203	700	4027 5011 82	
41	60	20	30	240	750	4027 5011 83	
1/2	30	11	25	134	100	4027 5010 70	
9/16	30	11	25	133	110	4027 5010 71	
5/8	30	12	25	135	140	4027 5010 72	
11/16	30	12	25	136	160	4027 5010 73	
3/4	31	12	25	145	210	4027 5010 74	
13/16	34	15	25	159	260	4027 5010 75	
7/8	35	15	25	156	300	4027 5010 76	

# End fittings for CWR/BWR-D/MWR

## Bits Holders

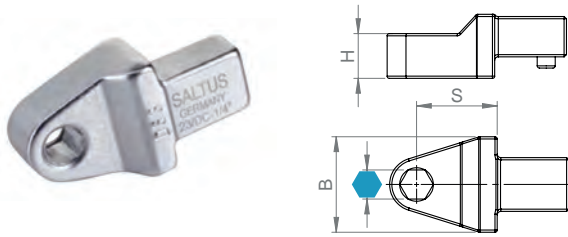

	in	B mm	H mm	S mm	g	Ordering No.
9 x 12	5/16	14	10	17.5	45	4027 5012 10
	1/4	16	12.5	17.5	47	4027 5012 11
14 x 18	5/16	16	12.5	25	112	4027 5012 13

## Flared End

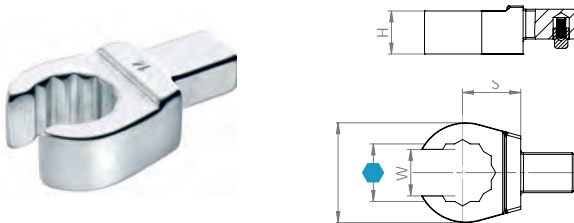

	mm/in	B mm	H mm	S mm	W mm	g	Max Nm	Ordering No.
9 x 12	10	21.5	11	17.5	7.1	57	20	4027 5011 90
	11	22.5	11	17.5	8.6	55	25	4027 5011 91
	12	24.5	12	17.5	9	59	32	4027 5011 92
	13	26	13	17.5	10	55	40	4027 5011 93
	14	27	13	17.5	11	60	50	4027 5011 94
	15	27	13	17.5	12	60	50	4027 5011 95
	16	30.5	13	17.5	13	65	80	4027 5011 96
	17	31.5	13	17.5	14	64	82	4027 5011 97
	18	33	15	17.5	15	74	100	4027 5011 98
	19	34	15	17.5	16	80	115	4027 5011 99
	21	38.5	15	20	17	88	120	4027 5012 00
	22	39.5	15	20	17	92	120	4027 5012 01
	24	40	15	20	18	75	120	4027 5012 02
	27	45	17	25	20	120	140	4027 5012 03
	3/8	18	8	17.5	7.1	39	20	4027 5010 30
7/16	21	12	17.5	8.6	50	25	4027 5010 31	
1/2	26	13	17.5	10	61	32	4027 5010 32	
9/16	27	13	17.5	11	58	50	4027 5010 33	
5/8	30	13	17.5	14	62	80	4027 5010 34	
11/16	30	13	17.5	14	58	82	4027 5010 35	
3/4	34	15	17.5	15.8	71	115	4027 5010 36	

## Hexagon Ratchet

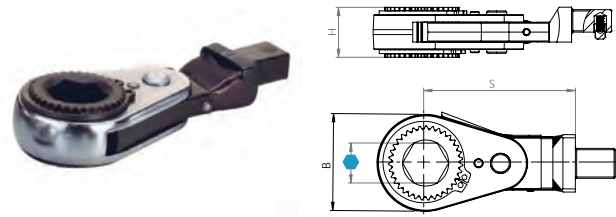

	mm/in	B mm	H mm	S mm	g	Teeth	Max Nm	Ordering No.
9 x 12	10	28	13.5	51	95	33	25	4027 5012 30
	11	28	13.5	51	95	33	25	4027 5012 31
	12	28	13.5	51	95	33	25	4027 5012 32
	13	28	13.5	51	95	33	25	4027 5012 33
	14	32	16	56	140	34	35	4027 5012 34
	15	32	16	56	140	34	35	4027 5012 35
	16	39	20	61	205	35	70	4027 5012 36
	17	39	20	61	205	35	70	4027 5012 37
	18	39	20	61	205	35	70	4027 5012 38
	19	39	20	61	205	35	70	4027 5012 39
	21	45	23	61	290	36	85	4027 5012 40
	22	45	23	61	290	36	85	4027 5012 41
	24	45	23	61	290	36	85	4027 5012 42

## Open Hexagon Ratchet

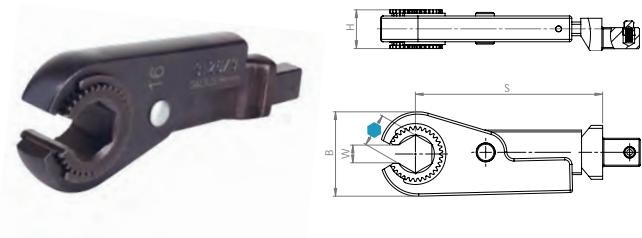

	mm/in	B mm	H mm	S mm	W mm	g	Max Nm	Ordering No.	
9 x 12	8	30	16.5	48	5.1	90	15	4027 5012 50	
	9	30	16.5	48	6.3	90	15	4027 5012 51	
	10	30	16.5	48	6.3	89	15	4027 5012 52	
	11	30	16.5	48	6.3	89	15	4027 5012 53	
	12	36	16.5	81	7.1	200	18	4027 5012 54	
	13	36	16.5	81	7.6	200	18	4027 5012 55	
	14	36	16.5	81	8	200	18	4027 5012 56	
	15	44	20.5	83	9.1	280	45	4027 5012 57	
	16	44	20.5	83	9.6	280	45	4027 5012 58	
	17	44	20.5	83	10	280	45	4027 5012 59	
	18	44	20.5	83	10.5	280	45	4027 5012 60	
	19	44	20.5	83	10.5	280	45	4027 5012 61	
	<b>With reinforced bottom 9 x 12</b>								
	10	30	16.5	48	6.3	91	15	4027 5012 63	
	11	30	16.5	48	6.3	91	15	4027 5012 64	
12	30	16.5	48	7.1	91	15	4027 5012 65		
13	30	20.5	48	7.6	91	15	4027 5012 66		

# End fittings for CWR/BWR-D/MWR

## Open End with Ratchet Function

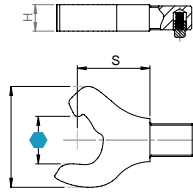

	mm/in	B mm	H mm	S mm	g	Ordering No.
<b>9 x 12</b>						
	10	22.5	10	17.5	34	4027 5012 80
	11	24.5	10	21	39	4027 5012 81
	12	26.7	10	21	42	4027 5012 82
	13	30	10	23	49	4027 5012 83
	14	30.5	10	25.5	55	4027 5012 84
	15	32	10	27	60	4027 5012 85
	16	35	10	28	65	4027 5012 86
	17	37	10	29	68	4027 5012 87
	18	38	10	32.5	78	4027 5012 88
	19	41	10	33	90	4027 5012 89
	21	46.5	10	35	100	4027 5012 90
	22	46.5	10	35	97	4027 5012 91
	24	50	10	37.5	115	4027 5012 92
	27	57	10	47.5	156	4027 5012 93
	30	62	10	52.5	182	4027 5012 94
	32	67	12	52.5	234	4027 5012 95
<b>14 x 18</b>						
	17	37	16	28	125	4027 5012 98
	18	41	16	32	12	4027 5012 99
	19	41	16	32.5	130	4027 5013 00
	21	46.5	16	35	150	4027 5013 01
	22	46.6	16	40	203	4027 5013 02
	24	50	16	41	220	4027 5013 03
	27	57	16	47	270	4027 5013 04
	30	63	16	52	310	4027 5013 05
	32	67	16	53	336	4027 5013 06
	36	75	16	54	388	4027 5013 07

## Setting Key CWR/MWR



	g	Ordering No.
Setting key, CWR/MWR	169	4027 5013 96

## Blank End



	B mm	H mm	S mm	g	Ordering No.
<b>9 x 12</b>					
Assembled	23	14	9	30	4027 5012 20
	23	14	9	30	4027 5012 21
<b>14 x 18</b>					
Assembled	30	21	13	98	4027 5012 23
	30	21	13	98	4027 5012 24

## Fixed Square

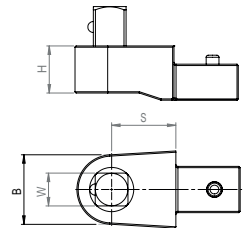

	in	B mm	H mm	S mm	g	Max Nm	Ordering No.
<b>9 x 12</b>							
	1/4	20	14	17.5	76	40	4027 5013 20
	3/8	20	14	17.5	82	80	4027 5013 21
	1/2	20	14	17.5	71	100	4027 5013 22
<b>14 x 18</b>							
	1/2	27	18	25	203	300	4027 5013 24
	3/4	40	25	25	396	650	4027 5013 25

## Non-Reversible Ratchet End

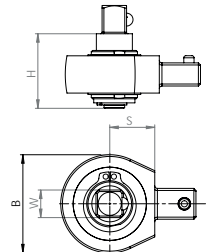

	in	B mm	H mm	S mm	g	Max Nm	Ordering No.
<b>9 x 12</b>							
	3/8	38	29.5	17.5	140	80	4027 5013 30
	1/2	38	29.5	17.5	180	100	4027 5013 31
<b>14 x 18</b>							
	1/2	44	29.5	25	230	300	4027 5013 33

## Reversible Ratchet End

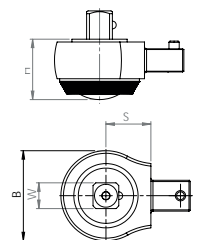

	in	B mm	H mm	S mm	g	Max Nm	Ordering No.
<b>9 x 12</b>							
	1/4	27	27	17.5	68	50	4027 5013 40
	3/8	36.5	25	17.5	140	100	4027 5013 41
	1/2	33.5	37	17.5	150	120	4027 5013 42
<b>14 x 18</b>							
	1/2	41	26	25	320	250	4027 5013 44
	3/4	62	32	46	865	800	4027 5013 45



# End fittings for CWR/BWR-D/MWR

## Round-shank Adapter



Type	S mm	g	Ordering No.
<b>9 x 12</b>			
J-Shank	24	68	4027 5016 90
Y-Shank	29	71	4027 5016 91
X-Shank	31	86	4027 5016 92
Z-Shank	56	314	4027 5016 93
<b>14 x 18</b>			
J-Shank	24	105	4027 5017 00
Y-Shank	29	104	4027 5017 01
X-Shank	31	121	4027 5017 02
Z-Shank	56	349	4027 5017 03

## Connectors for Dovetails Inserts

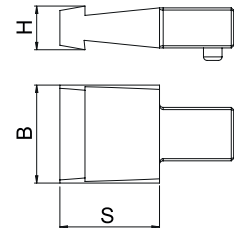

	B mm	H mm	S mm	g	Ordering No.
<b>9 x 12</b>	22	10	21.5	39	4027 5013 90
<b>14 x 18</b>	29	10	26.5	92	4027 5013 91

# End fittings for BWR

## Open End

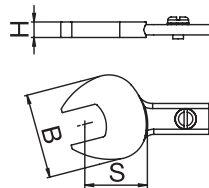

	B mm	H mm	S mm	g	Max Nm	Ordering No.
<b>BWR 750</b>						
21	62	12	58	600	300	4027 5001 20
22	62	12	58	600	300	4027 5001 21
24	70	14	58	620	320	4027 5001 22
27	75	15	58	700	360	4027 5001 23
30	80	15	58	820	420	4027 5001 24
32	82	17	58	850	490	4027 5001 25
34	86	17	62	860	570	4027 5001 26
36	86	17	62	860	570	4027 5001 27
41	92	20	64	950	620	4027 5001 28
46	97	22	66	980	630	4027 5001 29
13/16	62	12	58	600	300	4027 5007 30
7/8	62	12	58	600	300	4027 5007 31
15/16	70	14	58	620	320	4027 5007 32
1	75	15	58	700	360	4027 5007 33
1 1/8	80	15	58	820	420	4027 5007 34
<b>BWR 1300/2000</b>						
24	70	14	53	950	350	4027 5001 50
27	75	15	53	960	480	4027 5001 51
30	82	17	53	1050	600	4027 5001 52
32	82	17	61	1150	750	4027 5001 53
34	86	18	64	1200	890	4027 5001 54
36	86	18	65	1200	890	4027 5001 55
41	92	20	77	1650	1150	4027 5001 56
46	97	22	80	1800	1450	4027 5001 57
50	104	22	82	1900	1750	4027 5001 58
55	110	22	83	1985	1800	4027 5001 59
60	115	22	86	2000	1850	4027 5001 60
75	170	25	113	3500	2000	4027 5001 61
15/16	70	14	53	950	350	4027 5007 40
1	75	15	53	960	480	4027 5007 41
1 1/8	82	17	53	1050	600	4027 5007 42

## Box End

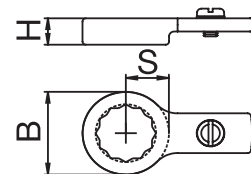

	B mm	H mm	S mm	g	Max Nm	Ordering No.
<b>BWR 750</b>						
21	40	14	58	450	320	4027 5003 00
22	40	14	58	470	320	4027 5003 01
24	43	14	58	500	480	4027 5003 02
27	47	16	58	520	480	4027 5003 03
30	54	16	58	535	700	4027 5003 04
32	56	16	58	565	750	4027 5003 05
34	60	19	58	575	750	4027 5003 06
36	60	19	58	575	750	4027 5003 07
38	60	19	58	565	750	4027 5003 08
41	65	19	58	585	750	4027 5003 09
46	69	19	58	600	750	4027 5003 10
13/16	40	14	58	450	320	4027 5008 30
7/8	40	14	58	470	320	4027 5008 31
15/16	43	14	58	500	480	4027 5008 32
1	47	16	58	520	480	4027 5008 33
<b>BWR 1300/2000</b>						
24	52	18	58	750	520	4027 5003 30
27	56	18	58	760	560	4027 5003 31
30	60	18	58	800	740	4027 5003 32
32	62	18	58	820	950	4027 5003 33
34	62	18	58	850	1200	4027 5003 34
36	70	18	58	850	1200	4027 5003 35
41	70	18	58	940	1800	4027 5003 36
46	78	20	58	1080	2000	4027 5003 37
50	85	22	58	1180	2000	4027 5003 38
55	90	22	58	1250	2000	4027 5003 39
60	95	22	58	1300	2000	4027 5003 40
15/16	52	18	58	750	520	4027 5008 40
1	56	18	58	760	560	4027 5008 41

## Fixed Square End

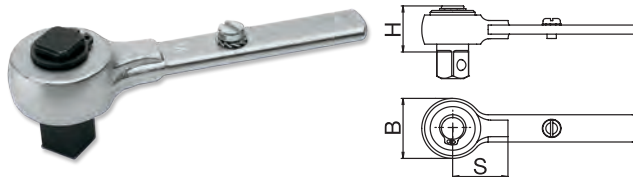

	in x mm	B mm	H mm	S mm	g	Max Nm	Ordering No.
<b>BWR 750</b>	3/4x70	48	70	58	775	750	4027 5005 11
<b>BWR 1300/2000</b>	3/4x70	73	70	58	1400	1000	4027 5005 16
	1x70	73	70	58	1700	2000	4027 5005 17

## Ratchet End



	in x mm	B mm	H mm	S mm	g	Max Nm	Ordering No.
<b>BWR 750</b>	3/4x70	72	70	58	1250	750	4027 5005 55
<b>BWR 1300/2000</b>	3/4x70	85	70	58	1700	1000	4027 5005 60
	1x80	85	80	58	2000	2000	4027 5005 61

## Reversible Ratchet End

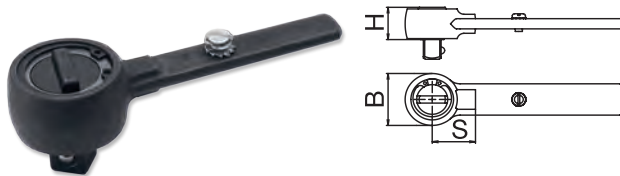

	in	B mm	H mm	S mm	g	Max Nm	Ordering No.
<b>BWR 750</b>	3/4	68	70	58	1250	750	4027 5005 93
<b>BWR 1300/2000</b>	3/4	68	70	58	1500	1000	4027 5005 98
	1	68	70	58	1500	1000	4027 5005 99

## Round-shank Adapter



Type	S mm	g	Ordering No.
<b>BWR 750</b>			
X-Shank	31	455	4027 5009 73
Z-Shank	56	686	4027 5009 83
<b>BWR 1300/2000</b>			
Z-Shank	56	924	4027 5009 84

## Setting Key BWR/BWR-D



	g	Ordering No.
Setting key BWR 20 (D) up to 100 (D)	97	4027 5006 10
Setting key BWR 240 (D)	164	4027 5006 11
Setting key BWR 440 (D)	428	4027 5006 12
Setting key BWR 750 up to 2000	603	4027 5006 13

## Setting Key SWR



	g	Ordering No.
Setting key set SWR -30	94	4027 5030 00
Setting key set SWR-60	171	4027 5030 01
Setting key set SWR-110	429	4027 5030 02

# Grinders

## Contents

Introduction.....	203
Guide.....	204
Product safety.....	205
Turbine grinders and sanders.....	206
Die grinders.....	209
Straight grinders.....	211
Vertical grinders.....	214
Vertical sanders.....	216
Angle grinders.....	218
Angle sanders.....	220
Belt sanders.....	222
Orbital and random orbital sanders.....	223
Dust extraction.....	225
Routers.....	228
Circular cutters.....	229





## Maximum material removal with minimum effort

*Atlas Copco Turbine Grinders give you twice the power with half the weight and are impossible to stall with the right installation! Atlas Copco's range covers all, you can rely on maximum material removal with minimum effort.*

### DIE GRINDING

Small precision deburring – die grinding is performed with either tungsten carbide, high speed steel burrs or mounted points.

The choice of burr depends on the size of your job. A larger volume of removed material will require a bigger size of the burr's head.

Select the tool r/min depending on the diameter of the burr head, the material to be ground and the material in the rotary burr. Use tungsten carbide burrs for hard and tough materials. High speed steel burrs are recommended for unhardened and medium hard materials. Example, see table below:

Burr head Ø		Hardened steel Tough materials	Unhardened steel	Soft material
			Softer materials Cast iron	Wood, brass Plastics, Al.
Up to 6 mm	– TC	38000	38000	38000
	– HSS	–	20000	20000
Up to 12 mm	– TC	30000	30000	30000
	– HSS	–	–	20000

TC – Tungsten carbide tipped rotary burr. HSS – High speed steel burrs.

For mounted points, follow the recommendations that relate to the particular mounted point.

### ROUGH GRINDING

Pure material removal is determined by the power generated at the grinding process. The applied feed force and the rotation of the wheel generates a cutting force which, multiplied by the peripheral speed of the wheel, represents the power of removed material. (Power=Peripheral speed x Cutting force).

A powerful grinder will provide enough power with maintained rotational speed, when applying feed-force. A suitable combination of operative rotational speed, feed-force applied by the operator and power of the grinder, will give you the best combination for the material removal required.

As rough grinding is performed with bonded abrasives, a limitation of rotational speed is necessary in order to prevent wheel fractures due to centrifugal force.

The peripheral speed is limited to 80 m/s for fibre reinforced depressed center, straight and cutting off wheels. Resin bonded cup and straight wheels are limited to a peripheral speed of 50 m/s.

### SANDING AND POLISHING

Unlike die and rough grinding, sanding and polishing applies to requirements of a surface. A fine surface will require a fine grit paper, fine Scotch-Brite, Bear Tex or a soft polishing bonnet. Rougher surface grinding will require a higher material removal rate and thus a coarser grit paper.

Similar to rough grinding, a rough surface, ground with coarse grit will benefit from a high rotational speed. The limitations are, however, the maximum allowed speed of the backing pad and the fibre disc.

Normal sanding speeds for fibre discs of diameter 125 mm, 180 mm and 230 mm are 4000 to 6000 r/min.

Polishing with different pastes and compounds requires low speed in combination with high torque. Suitable speeds are 1800 to 2200 r/min.

Sanding with wet coated abrasives is best performed at low speeds, partly because water is thrown out into the periphery and partly because of the fine grit.

Scotch-Brite, Bear Tex and flap wheels perform best at 50% of their maximum allowed rotational speeds.

### THE SPEED GOVERNOR

The amount of material removed in the grinding process depends on the power of the tool and the operative rotational speed. The diagram below shows the correlation between torque, power and rotational speed of a non governed pneumatic grinder.

In order to remove material, the operator has to apply a feed-force on the work-piece. Consequently the rotational speed decreases and having passed approximately 50% of the free speed, the operative power outtake starts to decrease. Theoretically, the most material would be removed at approximately 50% of the free speed on a non governed grinder, (diagram 1).

Atlas Copco grinders are compact and smooth running, partly due to their speed governor. The air is governed to the air flow necessary to maintain the rotational speed regardless of load (to the extent of the power of the grinder).

The correlation between power, torque and rotational speed of a governed grinder is shown in diagram 2.

A theoretical optimum of material removal is reached at approximately 80% of the free speed. The grinder generates maximum power, removing more material with applied feed force. The rotational speed decreases negligibly.

Air is used economically, as the flow through the motor is adjusted after applied load. Air consumption at free speed is minimized. The governor opens and lets in more air during load thus keeping the optimal r/min.

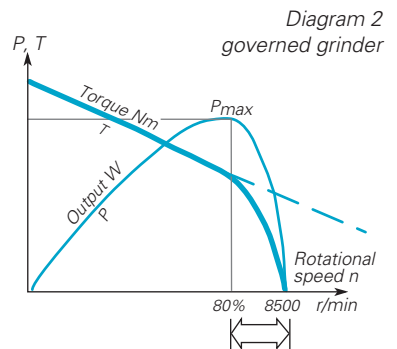
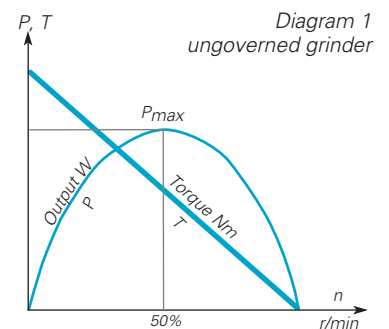

# Guides

## DIE GRINDING AND DEBURRING

SEE PAGE 209

1 Carbide burrs



2 Mounted points

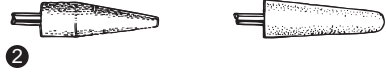

## ROUGH GRINDING AND CUTTING OFF

SEE PAGE 206, 207, 211 AND 214

3 Depressed center wheels



4 Cut off wheels



5 Cup wheels



6 Flap wheels



7 Straight wheels



8 Cone wheels



## SANDING AND POLISHING

SEE PAGE 216, 220 AND 223

9 Fibre discs

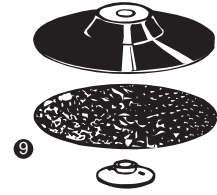

10 Wire brushes



11 Coated abrasives

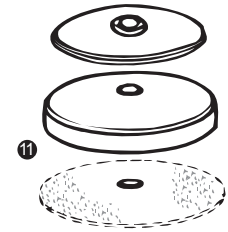

12 Polishing bonnets

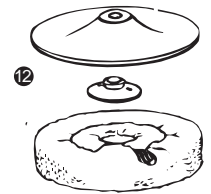

13 Radial flap wheels

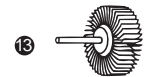

14 Scotch-Brite



## DIAMETER – PERIPHERAL SPEED – R/MIN

The table below will help you to translate the peripheral speed of the grinding wheel to the correct rotational speed of the grinder when using a grinding wheel with a specific diameter.

Grinding wheel dia mm	Peripheral speed in meters per second													
	10	15	20	25	28	30	33	35	40	45	48	50	60	80
25	7640	11460	15280	19100	21390	22920	25210	26740	30560	34380	36670	38200	45840	61120
40	4770	7160	9550	11930	13370	14320	15750	16710	19100	21480	22920	23870	28650	38200
50	3820	5730	7640	9550	10690	11460	12600	13370	15280	17190	18330	19100	22920	30560
63	3303	4540	6060	7560	8480	9090	10000	10610	12120	13640	14550	15150	18190	24250
80	2380	3580	4770	5960	6680	7160	7870	8350	9550	10740	11460	11930	14320	19100
100	1910	2860	3820	4770	5340	5730	6300	6680	7640	8590	9160	9550	11460	15280
115	1660	2490	3320	4150	4650	4980	5480	5810	6640	7470	7970	8300	9960	13400
125	1520	2290	3050	3820	4270	4580	5040	5340	6110	6870	7330	7640	9160	12280
150	1270	1910	2540	3180	3560	3820	4200	4450	5090	5730	6110	6360	7640	10180
180	1060	1590	2120	2650	2970	3180	3500	3710	4240	4770	5090	5300	6360	8480
200	950	1430	1910	2380	2670	2860	3150	3340	3820	4290	4580	4770	5730	7640
230	830	1240	1660	2070	2320	2490	2740	2900	3320	3730	3980	4150	4980	6640
250	760	1140	1520	1910	2130	2290	2520	2670	3050	3430	3660	3820	4580	6110
300	630	950	1270	1590	1780	1910	2100	2220	2540	2860	3050	3180	3820	5090



## THIS IS YOUR RESPONSIBILITY

Always read and understand the safety information supplied with the tool and on [www.atlascopco.com](http://www.atlascopco.com). All locally legislated safety rules regarding installation, operation and maintenance shall be respected at all times.

### 1. Check the free speed

- The measured speed at a pressure of 6.3 bars must not exceed the rated speed, which is marked on the grinder.
- Remove the grinding wheel and outer flange before checking the free speed.
- Carry out checks daily.
- Make sure the speed marking on the tool is legible.
- Return the machine for repair in the event of overspeeding.



### 2. Check the wheel guard

The wheel guard protects your health and safety.

- Always use the recommended wheel guard.
- Check that it is not damaged.
- Never use a grinder without the wheel guard.
- Position the wheel guard between yourself and the grinding wheel.



Check that the trigger is working correctly.

- The trigger must never be removed or fixed by tape for example.
- If the trigger is not working properly, make sure that it is replaced.

### 3. Maximum speed

Make sure that the stated maximum speed of the grinding wheel is greater than or equal to the speed specified on the grinder.

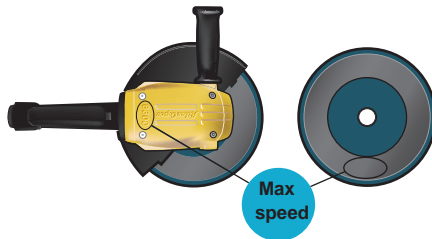

### 4. Check the grinding wheel

Make sure that the grinding wheel is not cracked or damaged in any way.

- The grinding wheel should have the correct hole dimensions and be fitted correctly on the spindle to avoid unbalanced vibrations.
- Damaged grinding wheels must be removed and replaced immediately.
- Do not use dropped or damaged wheels, as these can cause serious injuries.

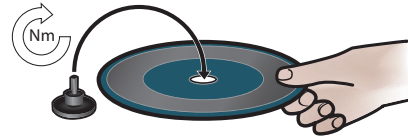

### 5. Check the flange and wheel

Make sure that flange and wheel combinations correspond to national regulations.

- Check that the flanges are undamaged and clean.
- Attach the wheel with the recommended torque.
- Always disconnect the air-supply when changing the wheel or adjusting the tool.
- Test-run your grinder in a protected area after assembling the wheel.
- Check that the grinder is working correctly.



### 6. Personal protection equipment

Make sure that operators wear:

- Eye protection, goggles or a visor.
- Ear protection.
- Gloves.
- Steel toe-capped shoes.
- Protective clothing, such as a leather apron.
- A helmet (for heavier applications).
- Avoid loosely hanging clothing, hair, jewellery (risk of getting caught).



### 7. Working area

Ensure that the area in which you are working is kept free from other people so that no one can get injured.

- People nearby must also wear hearing and eye protection.
- Check that there is good ventilation and dust extraction from the premises.
- There should be a stand or a place available, on which the machine can be safely placed.
- Work within a sealed-off area, if possible with protecting walls, since there is a risk that broken discs could fly off.

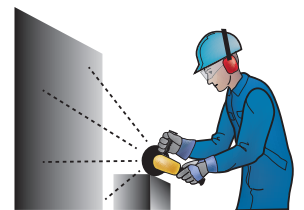

### During work

Stop using the grinder if abnormally loud noises and vibrations occur during use. The grinder and its accessories must not be modified in any way.

### After the work is finished

Make sure the machine is switched off and has come to a complete stop before it is put down. Put down the tool carefully, so that there is no risk of the tool starting by itself.



### Maintenance

Make sure you follow the service instructions provided and the recommended service intervals. Do not dismantle safety-related parts such as the speed governor and overspeed shut off. These parts should be completely replaced when damaged.

## TURBINE TECHNOLOGY BOOSTS PRODUCTIVITY

More efficient than a conventional vane grinder motor, the 2 stage turbine motor in the GTG25 provides an extremely high efficiency leading to great rate of material removal on the roughest surfaces. A speed governor ensures optimum process speed and process time is cut to a minimum. Since the job is done faster, the total energy consumption is significantly lower for each job.

## REDUCES OPERATOR STRAIN

The GTG25 is ergonomically designed in every aspect. Its high power-to-weight ratio, 2.5 kW of power in a 2.1 kg tool, makes grinding much easier for the user. Combined with other GTG25 features, for example, an ergonomic angled throttle handle and an autobalancer to minimize vibrations, the overall result is less strain on the operator.



GTG25 F120-13



GTG25 F085-18

## HIGHLY SERVICE FRIENDLY

With its all-metal design, the GTG25 turbine grinder is a robust, durable tool. Service intervals are long and servicing is easy thanks to modular internal components and Service Kits from Atlas Copco.

Model	Max free speed r/min	For wheel dia		Spindle thread	Max output		Weight		Height over spindle		Air consumption at free speed				Rec. hose size		Air inlet thread BSP	Ordering No.
		mm	in		kW	hp	kg	lb	mm	in	l/s	cfm	l/s	cfm	mm	in		
<b>For grinding and cutting off</b>																		
GTG25 F120-13	12000	125	5	–	2.5	3.4	2.1	5.07	59	2.3	32	67.8	9	19	16	5/8	3/8	8423 2525 01
GTG25 F120-M14	12000	125	5	M14	2.5	3.4	2.1	5.07	59	2.3	32	67.8	9	19	16	5/8	3/8	8423 2525 10
GTG25 F120-5/8	12000	125	5	UNC 5/8"	2.5	3.4	2.1	5.07	59	2.3	32	67.8	9	19	16	5/8	3/8	8423 2525 12
GTG25 F085-18	8500	180	7	–	2.5	3.4	2.2	5.29	59	2.3	32	67.8	9	19	16	5/8	3/8	8423 2525 02
GTG25 F085-M14	8500	180	7	M14	2.5	3.4	2.2	5.29	59	2.3	32	67.8	9	19	16	5/8	3/8	8423 2525 11
GTG25 F085-5/8	8500	180	7	UNC 5/8"	2.5	3.4	2.2	5.29	59	2.3	32	67.8	9	19	16	5/8	3/8	8423 2525 13
<b>For wire brush</b>																		
GTG25 F085-13	8500	125	5	–	2.5	3.4	2.1	5.07	59	2.3	32	67.8	9	19	16	5/8	3/8	8423 2525 15
<b>For sanding</b>																		
GTG25-S085	8500	180	7	5/8-11	2.5	3.4	2.0	4.4	59	2.3	32	67.8	9	19	16	5/8	3/8	8423 2525 03
GTG25-S085-M14	8500	180	7	M14	2.5	3.4	2.0	4.4	59	2.3	32	67.8	9	19	16	5/8	3/8	8423 2525 04
GTG25-S060	6000	230	9	5/8-11	2.5	3.4	2.0	4.4	59	2.3	32	67.8	9	19	16	5/8	3/8	8423 2525 20
GTG25-S060-M14	6000	230	9	M14	2.5	3.4	2.0	4.4	59	2.3	32	67.8	9	19	16	5/8	3/8	8423 2525 21

## Accessories

### TOOL ACCESSORIES

Model	Ordering No.
Whip-hose (incl.)	4175 0738 90
Deflector kit (incl.)	4175 0667 90
Exhaust hose	4150 1532 95
Flange center depressed wheel (incl.)	4175 0777 90
Flange cut off (incl.)	4175 0777 92
Spot suction kit for sander	3780 4090 27

### SPOT SUCTION KIT

	Ordering No.
<b>Spot suction kit for diamond cutting wheel</b> Ø 180 mm	3780 4090 35
<b>Spot suction kit for depressed center wheel</b> Ø 180 mm	3780 4090 30
<b>Add on spot suction</b> Ø 125 mm	3780 4032 14
Ø 180-230 mm	3780 4032 12

### AIR LINE ACCESSORIES

Model	Ordering No.
MultiFlex	8202 1350 22
Claw coupling	9000 0262 00
Blow protector	8202 0100 62
HM Open XL hose reel	8202 1183 39

## Productivity Kits

Model	Air inlet BSP	Max air flow	Hose, 5 m	Coupling	Lubrication	Ordering No.
MAXI F/R C-T16	1/2	60 l/s	Turbo 16 mm	Claw	No	8202 0850 05

The GTG40 are the most powerful grinders in the turbine grinder range, with incredible power for their size and weight. The range includes angle and straight type grinders for virtually every common rough grinding application.

- GTG40 F – for rough grinding and cutting off with depressed center wheels.
- GTG40 S – for surface finishing with fibre discs and wire brushes.
- GTG40 C – for rough grinding with cup wheels.
- Dust extraction – Efficient accessory for extraction of air-borne dust in sanding applications with fiber discs.



GTG40 F066-23



GTG40 S060-C15



GTG40 F085-18



GTG40 S060

### MORE EFFECTIVE

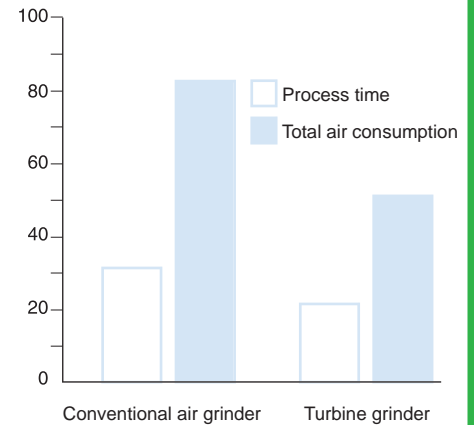

The turbine motor is more efficient than a conventional grinder motor. Therefore it takes less time to do the same job. Also the total air consumption will be a lot less for a specific job.

Model	Max free speed r/min	For wheel dia mm	Max output		Weight		Height over spindle		Air consumption at				Rec. hose size		Air inlet thread BSP	Ordering No.
			kW	hp	kg	lb	mm	in	max output l/s	free speed l/s	cfm	cfm	mm	in		
<b>For grinding and cutting off</b>																
GTG40 F085-18	8500	180	4.5	6.1	3.8	8.4	128	5.0	60	126	20	42	16	5/8	1/2	8423 2900 10
GTG40 F066-23	6600	230	4.5	6.1	4.0	8.8	128	5.0	60	126	20	42	16	5/8	1/2	8423 2910 10
<b>For sanding with fibre disc and wire brush</b>																
GTG40 S060	6000	140 <sup>a</sup>	4.5	6.1	3.6	7.9	132	5.2	60	126	20	42	16	5/8	1/2	8423 2930 00
<b>For cup wheel type 11</b>																
GTG40 S072-C13	7200	125	4.5	6.1	4.1	9.1	126	5.0	60	126	20	42	16	5/8	1/2	8423 2930 30
GTG40 S060-C15 <sup>b</sup>	6000	150	4.5	6.1	4.3	10.5	126	5.0	60	126	20	42	16	5/8	1/2	8423 2930 10

<sup>a</sup> For wire brush, Ø 230 mm for fibre disc. <sup>b</sup> Spindle thread: UNC 5/8". Length 23.5 mm.

## Accessories Included

### GTG40

Adjustable wheel guard  
 Support handle  
 Attachments flanges for 1.5-7 mm thick cut-off wheels and 2.5-8 mm thick depressed center wheels  
 Whip hose 0.7 m long, 16 mm dia complete with nipple and ErgoNIP 10  
 Hex key for wheel change

## Optional Accessories

### GTG40

	Ordering No.
Heavy duty backing pad for sanding Ø 180 mm (7")	4170 1192 90
Ø 230 mm (9")	4170 1193 90
Hand shield	4175 0165 90
Adapter for positioning support handle 120/135° between handles	4175 0164 90 <sup>b</sup>
Adapter kit fibre disc	4175 0238 90
Dust extraction kit for 180 mm fiber disc GTG40 S060	3780 4090 11 <sup>a</sup>
Hose kit including 1.8 m vacuum hose, Ø 38 mm and air hose Ø 13 mm	3780 2724 41
Friction plate complete	4175 0186 90
Attachment for cup wheel with plane hole	4175 0178 90

<sup>a</sup> Incl. flow chamber, suction cap and support pad.

<sup>b</sup> Included as standard in GTG40 S060-C15.

### GTG40

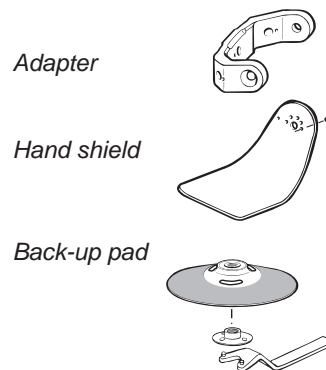

## Productivity Kits

Model	Air inlet BSP	Max air flow	Hose, 5 m	Coupling	Lubrication	Ordering No.
MAXI F/R C-T16	1/2	60 l/s	Turbo 16 mm	Claw	No	8202 0850 05



## Service Kits

GTG40	4081 0153 90
GTR40	4081 0153 91

- LSF07 is a high speed model for precision grinding and polishing. LSF07 is delivered with a 3 mm collet and can be equipped with a 1/8" collet as optional. (Without speed governor)
- LSF12/LSV12 – Small and comfortable die grinder with up to 360 W for maximum control in cramped spaces. All models are delivered with speed governor and a well balanced 6 mm Erickson collet.
- LSF19/LSV19 – All models in the 19 series are equipped with a powerful 0.5 kW air motor and a speed governor. The angled models (LSV) have a patented solution that overcomes temperature and leakage problems commonly associated with angle head tools. The result is a leak free and self-cooled angle head. All models are lubrication free except for the high speed model LSF19 S460.
- LSF29/LSV29 – Powerful 1 kW air motor, with speed governor and scatter damping. Impressive power-to-weight ratio.
- LSF39 – One of the most powerful one hand die grinders on the market, up to 1.8 kW. The die grinders in the 39 series are lubrication free with scatter damping for maximum operator comfort and safety.



Model	Max free speed r/min	Rec. max dia of		Max output kW	Max output hp	Weight kg	Length lb	Length mm	Air consumption at				Rec. hose size mm	Air inlet thread BSP	Collet size	Ordering No.	
		Tungsten carbide burrs mm	Mounted points mm						max output l/s	free speed cfm	l/s	cfm					
<b>Straight die grinders</b>																	
LSF12 S400-1 <sup>a</sup>	40000	9	16	0.36	0.48	0.4	0.8	170	9.8	20.8	7.0	14.8	8	5/16	1/4	6 mm	8423 1124 04
LSF12 S310-1	31000	12	20	0.32	0.43	0.4	0.8	170	9.2	19.5	4.2	8.9	8	5/16	1/4	6 mm	8423 1124 03
LSF12 S250-1 <sup>a</sup>	25000	12	20	0.29	0.39	0.4	0.8	170	8.5	18.0	3.4	7.2	8	5/16	1/4	6 mm	8423 1124 02
LSF12 S200-1 <sup>a</sup>	20000	12	20	0.24	0.32	0.4	0.8	170	8.1	17.2	2.6	5.5	8	5/16	1/4	6 mm	8423 1124 01
LSF19 S460E-1/R	46000	9	16	0.51	0.68	0.7	1.5	293	11.4	24.0	15.0	31.5	10	3/8	1/4	6 mm	8423 1224 90
LSF19 S460-1	46000	9	16	0.51	0.68	0.5	1.1	193	11.4	24.0	15.0	31.5	10	3/8	1/4	6 mm	8423 1224 82
LSF19 S460E-1	46000	9	16	0.51	0.68	0.7	1.5	293	11.4	24.0	15.0	31.5	10	3/8	1/4	6 mm	8423 1224 87
LSF19 S300-1	30000	12	20	0.50	0.67	0.5	1.1	193	11.3	23.7	6.6	13.8	10	3/8	1/4	6 mm	8423 1224 81
LSF19 S300-2	30000	12	20	0.50	0.67	0.5	1.1	193	11.3	23.7	6.6	13.8	10	3/8	1/4	1/4 in	8423 1224 84
LSF19 S300-1/R	30000	12	20	0.50	0.67	0.5	1.1	193	11.3	23.7	6.6	13.8	10	3/8	1/4	6 mm	8423 1224 89
LSF19 S300E-1	30000	12	20	0.50	0.67	0.7	1.5	293	11.3	23.7	6.6	13.8	10	3/8	1/4	6 mm	8423 1224 86
LSF19 S300E-1/R	30000	12	20	0.50	0.67	0.7	1.5	293	11.3	23.7	6.6	13.8	10	3/8	1/4	6 mm	8423 1224 88
LSF19 S200-1	20000	12	20	0.50	0.67	0.5	1.1	193	9.6	20.1	3.5	7.4	10	3/8	1/4	6 mm	8423 1224 80
LSF19 S200-2	20000	12	20	0.50	0.67	0.5	1.1	193	9.6	20.1	3.5	7.4	10	3/8	1/4	1/4 in	8423 1224 83
LSF19 S200E-1	20000	12	20	0.50	0.67	0.7	1.5	293	9.6	20.1	3.5	7.4	10	3/8	1/4	6 mm	8423 1224 85
LSF29 S120	12000	16	40	0.67	0.9	0.8	1.7	213	17.0	36.0	3.5	7.4	13	1/2	3/8	6 mm	8423 0127 00
LSF29 S120-HD R	12000	16	40	0.67	0.9	1.2	2.6	213	17.0	36.0	3.5	7.4	13	1/2	3/8	6 mm	8423 0127 23
LSF29 S120E-HD R	12000	16	40	0.67	0.9	1.6	3.5	332	17.0	36.0	3.5	7.4	13	1/2	3/8	6 mm	8423 0127 22
LSF29 S150	15000	16	40	0.79	1.1	0.8	1.7	213	18.0	38.1	4.4	9.3	13	1/2	3/8	6 mm	8423 0127 02
LSF29 S150E	15000	16	40	0.79	1.1	1.4	3.1	332	18.0	38.1	4.4	9.3	13	1/2	3/8	6 mm	8423 0127 04
LSF29 S180	18000	16	40	0.88	1.2	0.8	1.7	213	20.0	42.4	6.2	13.1	13	1/2	3/8	6 mm	8423 0127 05
LSF29 S180-HD R	18000	16	40	0.88	1.2	1.2	2.6	213	20.0	42.4	6.2	13.1	13	1/2	3/8	6 mm	8423 0127 25
LSF29 S180E	18000	16	40	0.88	1.2	1.4	3.1	332	20.0	42.4	6.2	13.1	13	1/2	3/8	6 mm	8423 0127 08
LSF29 S180E-HD R	18000	16	40	0.88	1.2	1.6	3.5	332	20.0	42.4	6.2	13.1	13	1/2	3/8	6 mm	8423 0127 24
LSF29 S250 <sup>a</sup>	25000	12	32	1.03	1.4	0.8	1.7	213	22.0	46.6	8.6	18.2	13	1/2	3/8	6 mm	8423 0127 11
LSF29 S250-HD R <sup>a</sup>	25000	12	32	1.03	1.4	1.2	2.6	213	22.0	46.6	8.6	18.2	13	1/2	3/8	6 mm	8423 0127 27
LSF29 S250E <sup>a</sup>	25000	12	32	1.03	1.4	1.4	3.1	332	22.0	46.6	8.6	18.2	13	1/2	3/8	6 mm	8423 0127 14
LSF29 S250E-HD R <sup>a</sup>	25000	12	32	1.03	1.4	1.6	3.5	332	22.0	46.6	8.6	18.2	13	1/2	3/8	6 mm	8423 0127 26
LSF39 S120E	12000	16	40	1.5	2.0	1.6	3.6	367	24.2	51.3	9.0	19.1	13	1/2	3/8	6 mm	8423 1233 00
LSF39 S150E	15000	16	40	1.7	2.3	1.6	3.6	367	27.6	58.5	12.1	25.6	13	1/2	3/8	6 mm	8423 1233 01
LSF39 S180E	18000	16	40	1.8	2.5	1.6	3.6	367	30.8	65.3	15.2	32.2	13	1/2	3/8	6 mm	8423 1233 02
LSF39 S250E <sup>a</sup>	25000	16	40	1.8	2.5	1.6	3.6	367	32.9	69.7	33.2	70.3	13	1/2	3/8	6 mm	8423 1233 03

<sup>a</sup> Not lubrication-free.

E = Extended version R = Model is rigid, without scatter damping

Continued...



Model	Max free speed r/min	Rec. max dia of		Max output		Weight kg lb	Length mm	Air consumption at				Rec. hose size mm in	Air inlet thread BSP	Collet size	Ordering No.		
		Tungsten carbide burrs mm	Mount- ed points mm					kW	hp	max output						free speed	
				l/s	cfm					l/s	cfm						
<b>Angle die grinders</b>																	
LSV12 S200-1 <sup>a</sup>	20000	12	20	0.29	0.39	0.5	1.2	166	9.5	20.1	6.4	13.6	8	5/16	1/4	6 mm	8423 1124 06
LSV12 S120-1 <sup>a</sup>	12000	12	20	0.24	0.33	0.5	1.2	166	8.3	17.6	3.0	6.4	8	5/16	1/4	6 mm	8423 1124 05
LSV19 S200-1	20000	12	20	0.46	0.62	0.6	1.3	185	11.3	23.9	7.5	15.9	10	3/8	1/4	6 mm	8423 0111 41
LSV19 S120-1	12000	12	20	0.46	0.62	0.6	1.3	185	11.3	23.9	7.5	15.9	10	3/8	1/4	6 mm	8423 0111 43
LSV19 S080-1	8000	12	20	0.37	0.50	0.6	1.3	185	11.3	23.9	6.5	13.8	10	3/8	1/4	6 mm	8423 0111 46
LSV28 S150	15000	16	40	0.68	0.91	1.2	2.5	250	17.0	36.0	8.3	17.6	10	3/8	3/8	6 mm	8423 0125 54
<b>Grinders for polishing</b>																	
LSF29 S030 R	3000	—	—	0.83	1.1	1.2	2.6	257	20.0	42.4	6.2	13.1	13	1/2	3/8	6	8423 0127 18
LSF29 S030E	3000	—	—	0.83	1.1	1.8	4.0	381	20.0	42.4	6.2	13.1	13	1/2	3/8	6	8423 0127 19
LSF29 S070 R <sup>a</sup>	7000	—	—	0.98	1.3	1.2	2.6	256	22.0	46.6	8.6	18.2	13	1/2	3/8	6	8423 0127 20
LSF29 S070E <sup>a</sup>	7000	—	—	0.98	1.3	1.8	4.0	381	22.0	46.6	8.6	18.2	13	1/2	3/8	6	8423 0127 21
<b>High speed pen model</b>																	
LSF07 S850	88000	4	6	0.10	0.10	0.4	0.9	173	2.2	4.9	2.3	4.6	4.5	3/16	—	3 mm	8423 1222 03

<sup>a</sup> Not lubrication-free. E = Extended version R = Model is rigid, without scatter damping

## Accessories Included

LSF07	LSF/LSV12	LSF/LSV19/28/29	LSF39
Air hose, ErgoNIP 08, Collet 3 mm (See ill 1.)	Spanner, Collet 6 mm (See ill. 1), Air hose, Air hose nipple and clamp, Exhaust hose	Spanner, Collet 6 mm (See ill. 1), Air hose, Air hose nipple and clamp, Exhaust hose	Air hose nipple, Collet 6 mm (See ill 1.)

## Optional Accessories

	LSF07	LSF/LSV12	LSF/LSV19	LSF/LSV29	LSF39	See ill.
<b>Optional collets</b>						
Collet 1/8"	4150 1822 00	4150 2226 46	-	-	-	1
Collet 3 mm	4150 1800 00	-	4150 0081 00	4150 0081 00	-	1
Collet 6 mm	-	4150 2226 03	4150 0075 00	4150 0075 00	4150 1453 00	1
Collet 8 mm	-	-	4150 0074 00	4150 0074 00	4150 0706 00	1
Collet 1/4"	-	-	4150 0076 00	4150 0076 00	4150 1754 00	1
Collet 10 mm	-	-	-	-	4150 0681 00	1
Collar	-	4150 2226 02	-	-	-	7
Collet nut	-	4150 2226 04	4150 0760 00	4150 0760 00	4150 0849 00	3
Collet nut and holder	-	-	-	4110 0844 90	-	-
Extension 75 mm/3"	-	-	4150 0674 00 <sup>a</sup>	4150 0674 00 <sup>a</sup>	-	4
<b>For machining of plastic and fibre glass</b>						
Diamond burr Ø 6 mm	-	3780 5013 70	3780 5013 70	-	-	2
Diamond drum Ø 27 mm	-	-	3780 5033 00	-	-	5
Spot suction kit for burr (burr not incl.)	3780 3015 23	-	3780 3015 22	-	-	6
Spot suction kit for drum (drum not incl.)	-	-	3780 4011 61 <sup>b</sup>	-	-	6
Cone wheel adapter UNF 3/8	-	-	-	4150 2326 80 <sup>c</sup>	-	-
Cone wheel adapter UNC/W 5/8	-	-	-	4150 2292 85 <sup>c</sup>	-	-

<sup>a</sup> Only for rigid (-R) models <sup>b</sup> For use with 6 mm collet <sup>c</sup> Only for extended (-E) models

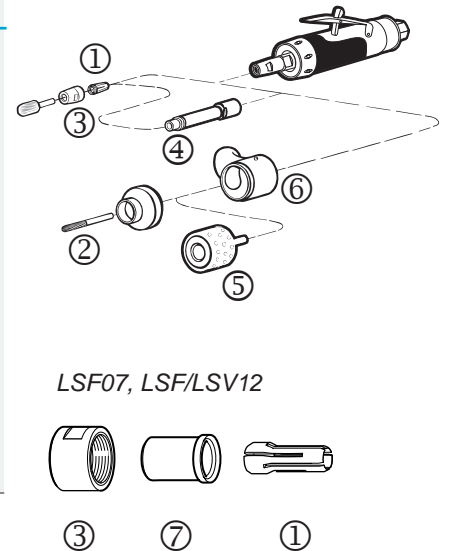

LSF07, LSF/LSV12

## Productivity Kits

Model	Air inlet BSP	Max air flow	Hose, 5 m	Coupling	Lubrication	Ordering No.
MIDI Optimizer F/RD EQ10-R13-W, incl. whiphose	3/8	23 l/s	Rubair 13 mm	ErgoQIC 10	Yes	8202 0850 14
MIDI Optimizer F/RD EQ10-R13-W, incl. whiphose	—	23 l/s	Rubair 13 mm	ErgoQIC 10	Yes	8202 0850 15
MIDI Optimizer F/RD EQ10-T13	3/8	35 l/s	Turbo 13 mm	ErgoQIC 10	Yes	8202 0850 17
MIDI Optimizer F/R EQ10-T13	1/2	35 l/s	Turbo 13 mm	ErgoQIC 10	No	8202 0850 04
MIDI Optimizer F/RD EQ10-T13	1/2	35 l/s	Turbo 13 mm	ErgoQIC 10	Yes	8202 0850 13



## Service Kits

07 series 4081 0243 90 12 series 4081 0472 90 19 series 4081 0486 90 29 series 4081 0581 00 39 series 4081 0581 03  
210 Grinders

Atlas Copco straight grinders for cone wheel or collet, are suitable for grinding in holes and cavities in castings. They require rough abrasives, which must be attached to the tool with a rigid shank or to be mounted directly to the spindle.

The power ranges from 1.5 kW to 2 kW. All Atlas Copco tools are designed with focus on operator ergonomics and maximum power, the best combination for maximum productivity.

- If you need maximum power, then LSR48 is the natural choice. You will have access to 2 kW in combination with an autobalancer for even less vibrations.



Model	Max free speed r/min	Max output		Weight		Length mm	Air consumption at				Rec. hose size		Air inlet thread BSP	Ordering No.
							max output		free speed					
							kW	hp	kg	lb	l/s	cfm		
LSR48 S150-CW	15000	2.0	2.7	2.3	5.0	450	35.0	74.0	19.0	40.0	16	5/8	1/2	8423 1430 08
LSR48 S120-CW	12000	1.8	2.4	2.3	5.0	450	30.0	64.0	13.0	27.0	16	5/8	1/2	8423 1430 05
LSR48 S090-CW	9000	1.5	2.0	2.3	5.0	450	28.0	59.0	11.0	23.0	16	5/8	1/2	8423 1430 03

LSR48 has UNC 1/2" spindle for direct attachment of a cone wheel. For UNC 5/8" spindle or collet use an adapter (not included).

## Accessories Included

Whip hose  
Wrench



## Service Kits

48 series      4081 2023 90

## Optional Accessories

	See ill.	Ordering No.
<b>Adapter for cone wheel with thread</b>		
UNC/W 5/8"	4	4150 0945 01
<b>Collet type</b>		
Nut	1a	4150 0849 00
Collet Ø 6 mm	1b	4150 1453 00
Collet Ø 8 mm	1b	4150 0706 00
Collet Ø 9 mm	1b	4150 0765 00
Collet Ø 10 mm	1b	4150 0681 00
Collet Ø 1/4"	1b	4150 1754 00
Collet holder	1c	4150 0680 01

**NOTE:** Adapters are not included with the tool, and need to be ordered to attach a cone wheel.

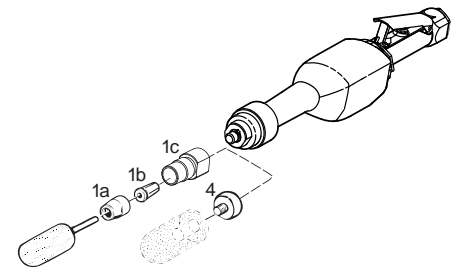

LSR48

## Productivity Kits

Model	Air inlet BSP	Max air flow	Hose, 5 m	Coupling	Lubrication	Ordering No.
MIDI Optimizer F/R EQ10-T13	1/2	35 l/s	Turbo 13 mm	ErgoQIC 10	No	8202 0850 04
MIDI Optimizer F/RD EQ10-T13	1/2	35 l/s	Turbo 13 mm	ErgoQIC 10	Yes	8202 0850 13
MIDI Optimizer F/RD EQ10-T16	1/2	40 l/s	Turbo 16 mm	ErgoQIC 10	Yes	8202 0850 12

# Straight Grinders

# For Straight Wheels

Atlas Copco straight grinders, equipped with a straight type 1 grinding wheel, offer a high rate of material removal in application like cutting and grinding of welds and edges.

The power ranges from 0.6 kW to 2.9 kW.

- The LSR28 is suitable for lighter applications where accessibility is first priority. Low sound and low vibration levels thanks to the unique vibration damping system. Thermally insulated throttle handle and piped away exhaust air are some of the LSR28 product features, all designed for the best comfort for the operator.
- LSR43 has a proven and rigid design, and is suitable for those really tough applications where durability is needed.
- If you need maximum power, then LSR48 or LSR64 is the choice. 2.9 kW in combination with auto balancer for even less vibrations (LSR48).



Model	Max free speed r/min	For wheel dia. DxTxH mm	Spindle thread and length	Max output		Weight		Length mm	Air consumption at				Rec. hose size		Air inlet thread BSP	Ordering No.
				kW	hp	kg	lb		max output l/s	free speed l/s	free speed cfm	max output cfm	mm	in		
LSR28 S180-05	18000	50x13x10	UNF 3/8x42	0.82	1.09	1.9	4.1	340	19.8	42.0	7.3	15.5	13	3/8	1/2	8423 1325 04
LSR28 S150-10	15000	100x13x20	UNC 1/2x42	0.70	0.94	2.2	4.8	340	18.0	38.2	5.8	12.3	13	3/8	1/2	8423 1325 02
LSR43 S150-10	15000	100x25x25	UNC 1/2x49	1.0	1.4	2.8	6.2	460	23.0	49.0	10.0	21.0	13	1/2	1/2	8423 1430 34
LSR43 S120-08	12000	80x25x13	UNC 1/2x49	0.9	1.2	2.5	5.5	460	20.0	42.0	7.0	15.0	13	1/2	1/2	8423 1430 26
LSR43 S090-10	9000	100x25x13	UNC 1/2x49	0.8	1.1	2.4	5.3	460	18.0	38.0	5.0	11.0	13	1/2	1/2	8423 1430 18
LSR48 S120-08 <sup>a</sup>	12000	80x25x13-25	UNC 1/2x37	1.8	2.4	3.0	6.6	498	30.0	64.0	13.0	28.0	16	5/8	1/2	8423 1430 04
LSR48 S120-10	12000	100x32x16-25	UNC 5/8x49	1.8	2.4	3.5	7.7	495	30.0	64.0	13.0	28.0	16	5/8	1/2	8423 1430 09
LSR48 S120-13	12000	125x25x16-25	UNC 5/8x42	1.8	2.4	3.6	7.9	487	30.0	64.0	13.0	28.0	16	5/8	1/2	8423 1430 06
LSR48 S090-10 <sup>a</sup>	9000	100x25x13-25	UNC 1/2x37	1.5	2.0	3.2	7.0	495	28.0	59.0	11.0	23.0	16	5/8	1/2	8423 1430 02
LSR64 S100-15	10000	150x25x25	UNC 5/8x55	2.9	4.0	5.8	2.8	535	53.0	112.0	26.0	55.0	16	5/8	1/2	8423 1640 55
LSR64 S072-13	7200	125x25x16	UNC 5/8x55	2.5	3.4	5.4	11.9	535	45.0	95.0	14.0	30.0	16	5/8	1/2	8423 1640 30
LSR64 S060-15	6000	150x25x16	UNC 5/8x55	2.3	3.1	5.4	11.9	535	41.0	87.0	11.0	23.0	16	5/8	1/2	8423 1640 22

DxTxH = Diameter x Thickness x Hole.

<sup>a</sup> LSR48 S120-08 and LSR48 S090-10 are equipped with closed wheel guard.

Model	Max free speed r/min	Spindle thread and length	Max output		Weight		Length mm	Air consumption at				Rec. hose size		Air inlet thread BSP	Ordering No.
			kW	hp	kg	lb		max output l/s	free speed l/s	free speed cfm	max output cfm	mm	in		
<b>For wire brushes</b>															
LSR64 S041	4100	UNC 5/8 x 55	1.6	2.5	5.4	11.9	535	29.0	61.0	7.0	15.0	16	5/8	1/2	8423 1640 14

## Accessories Included

### LSR28

Wheel guard, size according to type  
Nut, flanges  
Air hose, air hose nipple and clamp  
Exhaust hose  
Wrenches

### LSR43

Wheel guard, size according to type  
Nut  
Flanges  
Pin key

### LSR48

Whip hose  
Hook wrench  
Pin key  
Wheel guard, size according to type  
Flanges that suit wheels with inner diameter of 13/16/20 and 25 mm

### LSR64

Wheel guard, size according to type  
Nut, flanges  
Air hose nipple and clamp  
Wrenches

## Optional Accessories

	LSR28	LSR64	See ill.
Rear flange, for 125-150x25x32 wheel	-	4150 0620 00	1
50-100x13x20 wheel	4150 1271 01	-	1
Spacer, to fit cone wheel	-	4150 0787 00	2

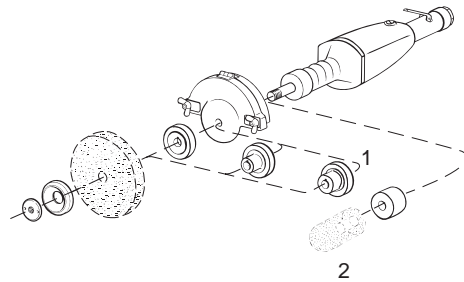

## Productivity Kits

Model	Air inlet BSP	Max air flow	Hose, 5 m	Coupling	Lubrication	Ordering No.
MIDI Optimizer F/RD EQ10-R13-W, incl. whiphose	3/8	23 l/s	Rubair 13 mm	ErgoQIC 10	Yes	8202 0850 14
MIDI Optimizer F/RD EQ10-R13-W, incl. whiphose	-	23 l/s	Rubair 13 mm	ErgoQIC 10	Yes	8202 0850 15
MIDI Optimizer F/RD EQ10-T13	3/8	35 l/s	Turbo 13 mm	ErgoQIC 10	Yes	8202 0850 17
MIDI Optimizer F/R EQ10-T13	1/2	35 l/s	Turbo 13 mm	ErgoQIC 10	No	8202 0850 04
MIDI Optimizer F/RD EQ10-T13	1/2	35 l/s	Turbo 13 mm	ErgoQIC 10	Yes	8202 0850 13
MIDI Optimizer F/RD EQ10-T16	1/2	40 l/s	Turbo 16 mm	ErgoQIC 10	Yes	8202 0850 12
MAXI F/R C-T16	1/2	60 l/s	Turbo 16 mm	Claw	No	8202 0850 05



## Service Kits

28 series	4081 0317 90
43 series	4081 0020 90
48 series	4081 2023 90
64 series	4081 0138 90

# Vertical Grinders For Depressed Center, Cut-off and Cup Wheels

The rigid design with a vertically standing air moto gives impressively long service life and durability.

- LSS series is suitable for rough grinding and cutting off operations on open surfaces.
- The power is impressive and ranges from 1.4 kW to a massive 3.8 kW.
- LSS53 is equipped with a unique silencer that reduces the sound peaks created at start and shut-off.



Model	Max free speed r/min	For wheel dia mm	Spindle thread and length	Max output		Weight		Height over spindle mm	Air consumption at				Rec. hose size		Air inlet thread BSP	Ordering No.
				kW	hp	kg	lb		max output l/s	free speed cfm	l/s	cfm	mm	in		
LSS53 S072-C13	7200	125	UNC 5/8x30	1.3	1.8	3.1	6.8	180	26.0	55.0	8.0	17.0	13	1/2	1/2	8423 2534 12
LSS53 S085-18	8500	180	UNC 5/8x30	1.4	1.9	2.9	6.4	180	27.0	57.0	10.0	21.0	13	1/2	1/2	8423 2530 72
LSS64 S060-23	6000	230	UNC 5/8x31	2.2	3.0	5.1	12.6	201	40.0	85.0	9.0	19.0	16	5/8	1/2	8423 2641 46
LSS64 S060-C15	6000	150	UNC 5/8x31	2.2	3.0	5.0	11.0	201	40.0	85.0	9.0	19.0	16	5/8	1/2	8423 2641 04
LSS64 S085-18	8500	180	UNC 5/8x31	2.6	3.5	4.7	10.4	201	50.0	106.0	13.0	28.0	16	5/8	1/2	8423 2641 38
LSS84 S060-23	6000	230	UNC 5/8x32	3.8	5.1	6.0	13.2	217	65.0	138.0	17.0	36.0	19	3/4	1/2	8423 2840 26

- 13 = 125 mm wheel.
- 18 = 180 mm wheel.
- 23 = 230 mm wheel.
- C13 = 125 mm cup wheel.
- C15 = 150 mm cup wheel.



## Accessories Included

Wheel guard	
Flange	4170 0758 01
Nut	4170 0220 01
Wrenches	

## Optional Accessories

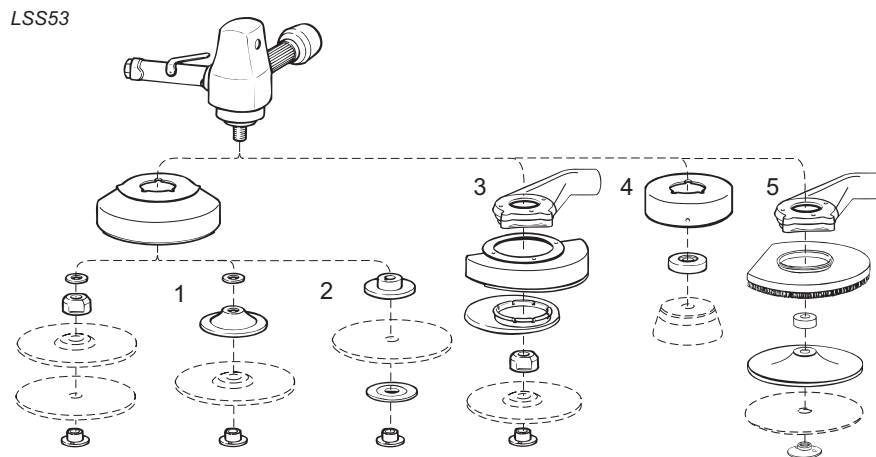

	LSS53	LSS64	See ill.
Accessory for depressed center wheel Includes: Rear and outer flange, nut and pin wrench	4170 0219 87	4170 0219 87	1
Accessory for cut off wheel Includes: Rear and outer flange, nut and pin wrench	4170 1133 87	-	2
Accessory for cup wheel 125 mm Includes: Wheel guard and flange	4170 0664 80	-	4
Accessory for cup wheel 150 mm Includes: Wheel guard and flange	-	4170 0652 80	4
Spot suction kit for fibre disc 180 mm	3780 4011 00	-	5

## Productivity Kits

Model	Air inlet BSP	Max air flow	Hose, 5 m	Coupling	Lubrication	Ordering No.
MIDI Optimizer F/RD EQ10-R13-W, incl. whiphose	3/8	23 l/s	Rubair 13 mm	ErgoQIC 10	Yes	8202 0850 14
MIDI Optimizer F/RD EQ10-R13-W, incl. whiphose	-	23 l/s	Rubair 13 mm	ErgoQIC 10	Yes	8202 0850 15
MIDI Optimizer F/RD EQ10-T13	3/8	35 l/s	Turbo 13 mm	ErgoQIC 10	Yes	8202 0850 17
MIDI Optimizer F/R EQ10-T13	1/2	35 l/s	Turbo 13 mm	ErgoQIC 10	No	8202 0850 04
MIDI Optimizer F/RD EQ10-T13	1/2	35 l/s	Turbo 13 mm	ErgoQIC 10	Yes	8202 0850 13
MIDI Optimizer F/RD EQ10-T16	1/2	40 l/s	Turbo 16 mm	ErgoQIC 10	Yes	8202 0850 12
MAXI F/R C-T16	1/2	60 l/s	Turbo 16 mm	Claw	No	8202 0850 05



## Service Kits

LSS53	4081 0132 90
LSS64	4081 0133 90
LSS84	4081 0136 90

Surface sanding jobs with coarse grit fiber discs on stiff pads or with wire brushes, require power. The Atlas Copco LSS series are reliable workhorses with lots of power that will be at your service for a long time. The rigid design with a vertically standing air motor and nodular cast iron cylinder gives impressively long service life and durability.

- LSS series is a good choice in applications where accessibility is of less importance.
- LSS53 is equipped with a unique silencer that reduces the sound peaks created at start and shut-off.



LSS53

Model	Max free speed r/min	Rec. pad size dia mm	Spindle thread and length	Max output		Weight		Height over spindle mm	Air consumption at				Rec. hose size		Air inlet thread BSP	Ordering No.
				kW	hp	kg	lb		max output		free speed		mm	in		
									l/s	cfm	l/s	cfm				
LSS53 S060	6000	180	UNC 5/8 x 30	1.2	1.6	2.3	5.1	180	24.0	51.0	7.0	15.0	13	1/2	1/2	8423 2530 23
LSS53 S060-M14	6000	180	M14 x 31	1.2	1.6	2.3	5.1	180	24.0	51.0	7.0	15.0	13	1/2	1/2	8423 2530 27

## Optional Accessories

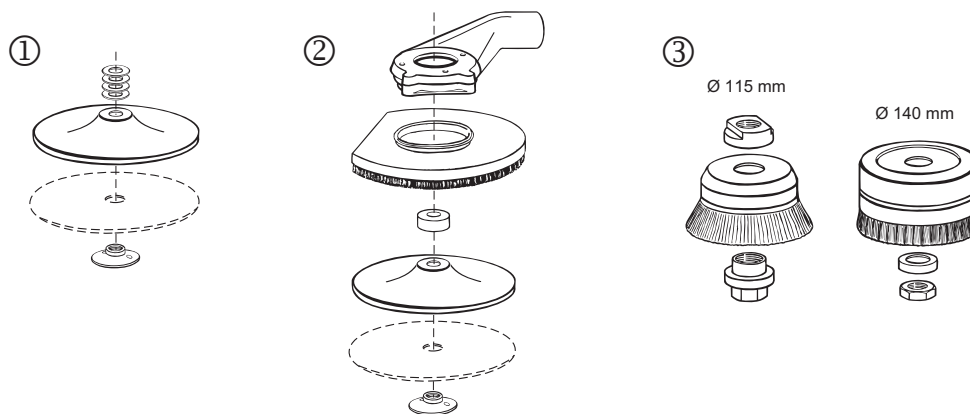

	Soft	Medium	Stiff	See illustration
<b>Backing set</b>				
Standard type Ø 125 mm - 5/8"	4170 0768 80	-	-	1
Standard type Ø 180 mm - 5/8"	4170 0756 80	-	4170 0757 80	1
Heavy duty type - Ø 180 mm - 5/8"	4170 0660 81 <sup>a</sup>	4170 0660 82 <sup>a</sup>	4170 0660 83 <sup>a</sup>	
<b>Backing set with cooling ribs</b>				
Ø 125 mm - 5/8" and M14	-	4150 1962 80	-	-
Ø 180 mm - 5/8" and M14	-	4150 1962 81	4150 1962 83	-
	<b>LSS53</b>	<b>LSS64</b>		<b>See illustration</b>
<b>Spot suction kit for fiber disc</b>				
Ø 180 mm	3780 4011 00 <sup>b</sup>	-	-	2
<b>Wire brushes</b>				
Wire brush 115 mm	4170 0491 00	-	-	3
Attachment set for wire brush	4170 0459 81	4170 0550 80	-	3

<sup>a</sup> = Includes washers, rubber hub, back-up pad, nut, wrench.

<sup>b</sup> = Includes flow chamber, cap, washers, backingpad, nut.

## Productivity Kits

Model	Air inlet BSP	Max air flow	Hose, 5 m	Coupling	Lubrication	Ordering No.
MIDI Optimizer F/RD EQ10-R13-W, incl. whiphose	3/8	23 l/s	Rubair 13 mm	ErgoQIC 10	Yes	8202 0850 14
MIDI Optimizer F/RD EQ10-R13-W, incl. whiphose	-	23 l/s	Rubair 13 mm	ErgoQIC 10	Yes	8202 0850 15
MIDI Optimizer F/RD EQ10-T13	3/8	35 l/s	Turbo 13 mm	ErgoQIC 10	Yes	8202 0850 17
MIDI Optimizer F/R EQ10-T13	1/2	35 l/s	Turbo 13 mm	ErgoQIC 10	No	8202 0850 04
MIDI Optimizer F/RD EQ10-T13	1/2	35 l/s	Turbo 13 mm	ErgoQIC 10	Yes	8202 0850 13
MIDI Optimizer F/RD EQ10-T16	1/2	40 l/s	Turbo 16 mm	ErgoQIC 10	Yes	8202 0850 12
MAXI F/R C-T16	1/2	60 l/s	Turbo 16 mm	Claw	No	8202 0850 05



## Service Kits

LSS53	4081 0132 90
LSS64	4081 0133 90

# Angle Grinders

# For Depressed Center and Cut-off Wheels

No matter which of our vane grinders you choose you will get durable tools with high power and low weight. In addition, vibrations and noise are on a low level.

- LSV19** – For work in cramped spaces, the LSV19 is small yet powerful, and lubrication free.  
 Features: Speed governor, sealed angle head, thermally insulated handle and lubrication-free air motor.
- LSV28** – Small, yet powerful giving 0.75 kW.  
 Features: Speed governor, sealed angle head, thermally insulated handle and lubrication-free air motor (LSV28 S060-18 model).
- LSV39** – If you are looking for the most powerful one-hand angle grinder on the market, then you have found it – up to 1.8 kW.  
 Features: Speed governor, sealed angle head, lubrication-free air motor, lockable spindle and thermally insulated handle. The auto balancer reduces the vibrations by up to 50%.
- LSV48** – Our most powerful angle vane grinder with 1.9 kW for ultimate productivity.  
 Features: Speed governor, sealed angle head, lubrication-free air motor, lockable spindle and thermally insulated handle. The autobalancer reduces the vibrations by up to 50%.



LSV28



LSV39



LSV19



LSV48

Model	Max free speed r/min	For wheel dia DxTxH <sup>a</sup> mm	Spindle thread and length	Max output		Weight		Height over spindle mm	Air consumption at				Rec. hose size		Air inlet thread BSP	Ordering No.
				kW	hp	kg	lb		max output l/s	free speed cfm	l/s	cfm	mm	in		
LSV19 S170-08	17000	80x7x10	UNF 3/8"x17	0.45	0.60	0.7	1.6	71	11.2	23.0	6.6	14.0	10	3/8	1/4	8423 0111 40
LSV28 ST12-10	12000	100x7x16	UNF 3/8"x17	0.75	1.00	1.7	3.7	75	17.4	36.9	7.5	15.9	10	3/8	3/8	8423 0125 14
LSV28 ST13-10E	13000	100x7x9.5	UNF 3/8"x17	0.75	1.00	1.5	3.3	70	21.5	45.0	14.5	30.0	10	3/8	3/8	8423 0125 29
LSV28 ST12-12	12000	115x7x22	UNF 3/8"x17	0.75	1.00	1.7	3.7	75	17.4	36.9	7.5	15.9	10	3/8	3/8	8423 0125 16
LSV28 ST12-13	12000	125x7x22	UNF 3/8"x17	0.75	1.00	1.7	3.7	75	17.4	36.9	7.5	15.9	10	3/8	3/8	8423 0125 17
LSV28 S060-18	6000	180 <sup>b</sup>	UNC 5/8"x32	0.73	0.98	2.5	5.4	87	16.0	33.9	7.3	15.5	10	3/8	3/8	8423 0135 53
LSV39 SA12-125	12000	125x7x22	M14x21	1.80	2.40	1.8	4.0	96	29.8	63.0	17.6	37.0	13	1/2	3/8	8423 0133 01
LSV48 SA085-18	8500	180x7x22	M14x9	1.9	2.5	2.7	5.9	88	36.0	76.0	17.0	36.0	16	5/8	1/2	8423 0132 06
LSV48 SA066-23	6600	230x7x22	UNC 5/8"x10	1.9	2.5	2.9	6.4	88	36.0	76.0	17.0	36.0	16	5/8	1/2	8423 0132 08
<b>For wire brush</b>																
LSV39 SA085-125	8500	125x7x22	M14x21	1.80	2.40	1.8	4.0	96	29.5	61.1	16.3	33.7	13	1/2	3/8	8423 0133 09

<sup>a</sup> DxTxH = Diameter x Thickness x Hole.

<sup>b</sup> Specially for flexible depressed center wheel.

SA = Autobalancer.

With wheel guard for wheel diam. –08 = Ø 80 mm

–10 = Ø 100 mm

–12 = Ø 115 mm

–125 = Ø 125 mm

–13 = Ø 125 mm

–18 = Ø 180 mm

–23 = Ø 230 mm



## Service Kits

LSV19	4081 0486 90
LSV28	4081 0317 90
LSV39	4081 0537 90
LSV48	4081 0312 90

## Accessories Included

### LSV19

Wheel guard 80 mm  
 Flanges 4150 1158 80  
 Air hose nipple, clamp  
 Wrenches  
 Exhaust hose set

### LSV28

Wheel guard  
 Flanges 4150 1160 80  
 Support handle 4150 1521 80  
 Air hose, air hose nipple, clamp  
 Wrenches  
 Exhaust hose set

### LSV39

Adjustable wheel guard  
 Wheel attachment flanges  
 Wrenches for flanges  
 Spindle lock  
 Soft grip support handle  
 Exhaust hose  
 Autobalancer  
 Whip hose Turbo 13 with ErgoNIP 10

### LSV48

Wheel guard  
 Flange nut 4150 1160 02  
 Support handle 4175 0868 82

## Optional Accessories

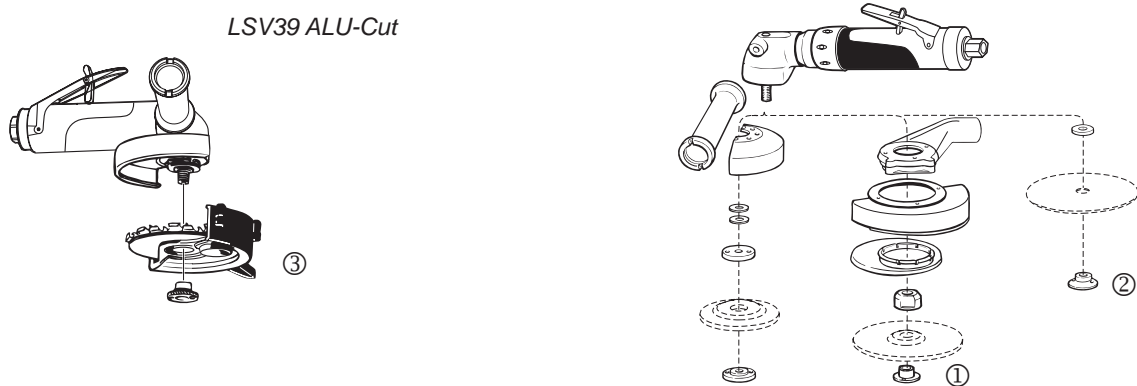

	LSV28	LSV39	LSV48	See illustration
<b>Spot suction kit for depressed center wheel</b> Ø 125 mm	3780 4008 70	3780 4008 73	-	1
<b>Spot suction for diamond cutting blade</b> Ø 125 mm (Cutting depth 30 mm)	-	3780 4008 74	-	-
Ø 180 mm (Cutting depth 50 mm)	-	-	3780 4093 42	-
<b>Diamond cutting blade</b> Ø 75 mm	3780 5073 00	-	-	-
Ø 100 mm	3780 5074 00	-	-	-
Ø 125 mm	-	3780 5074 61	-	-
Ø 180 mm	-	-	3780 5074 62	-
<b>Alu-Cut</b> Alu-Cut guard kit	-	4112 1166 90	-	3
Carbide tipped cutter Ø 125 mm, t=2 mm	-	4112 1164 00 <sup>a</sup>	-	-
Carbide tipped cutter Ø 125 mm, t=4 mm	-	4112 1162 00 <sup>b</sup>	-	-
Adapter for fitting flexible depressed center wheel (for LSV28 S060-18)	4170 0759 00	-	-	2
Quick flange nut, M14 Fixtec nut	-	4150 1929 00	4150 1929 00	-
<b>Add on spot suction</b> Ø 115-125 mm	3780 4032 14	3780 4032 14	3780 4032 14	-
Ø 180-230 mm	-	-	3780 4032 12	-

<sup>a</sup> For cutting applications in aluminum.

<sup>b</sup> For milling applications in aluminum.

## Productivity Kits

Model	Air inlet BSP	Max air flow	Hose, 5 m	Coupling	Lubrication	Ordering No.
MIDI Optimizer F/RD EQ10-R13-W, incl. whiphose	3/8	23 l/s	Rubair 13 mm	ErgoQIC 10	Yes	8202 0850 14
MIDI Optimizer F/RD EQ10-R13-W, incl. whiphose	-	23 l/s	Rubair 13 mm	ErgoQIC 10	Yes	8202 0850 15
MIDI Optimizer F/RD EQ10-T13	3/8	35 l/s	Turbo 13 mm	ErgoQIC 10	Yes	8202 0850 17
MIDI Optimizer F/R EQ10-T13	1/2	35 l/s	Turbo 13 mm	ErgoQIC 10	No	8202 0850 04
MIDI Optimizer F/RD EQ10-T13	1/2	35 l/s	Turbo 13 mm	ErgoQIC 10	Yes	8202 0850 13
MIDI Optimizer F/RD EQ10-T16	1/2	40 l/s	Turbo 16 mm	ErgoQIC 10	Yes	8202 0850 12



- LSV12 series sander** – For finer work where less power and more control are needed. Available with collet or threaded spindle.  
 Features: Speed governor, high quality gears and lever with feathering characteristics.
- LSV28 series sander** – The 28 series comes in various speeds and in a wet sanding version. Wet sanders have central water supply (water feed through the angle head) for optimal water distribution on the work surface.  
 Features: Speed governor, sealed angle head, LF models have lubrication-free air motor.
- LSV39 series sander** – Powerful one hand sander for medium rough to rough sanding.  
 Features: Speed governor, sealed angle head, lubrication-free air motor and lockable spindle.
- LSV48 series sander** – Our most powerful angle vane sander with 1.9 kW for ultimate productivity.  
 Features: Speed governor, sealed angle head, lubrication-free air motor, autobalancer and lockable spindle.



Model	Max free speed r/min	Rec. pad size max dia mm	Spindle thread and length	Max output		Weight kg	Length mm	Height over spindle mm	Air consumption at				Rec. hose size mm in	Air inlet thread BSP	Ordering No.		
				kW	hp				max output		free speed						
<b>With collet</b>																	
LSV12 S200-1	20000	50	— <sup>a</sup>	0.29	0.39	0.5	1.2	166	76	9.5	20.1	6.4	13.6	8	5/16	1/4	8423 1124 06
LSV12 S120-1	12000	75	— <sup>a</sup>	0.24	0.33	0.5	1.2	166	76	8.3	17.6	3.0	6.4	8	5/16	1/4	8423 1124 05
LSV19 S200-1	20000	50	— <sup>a</sup>	0.46	0.62	0.6	1.3	185	79	11.3	23.9	7.5	15.9	10	3/8	1/4	8423 0111 41
LSV19 S120-1	12000	75	— <sup>a</sup>	0.46	0.62	0.6	1.3	185	79	11.3	23.9	7.5	15.9	10	3/8	1/4	8423 0111 43
LSV19 S080-1	8000	75	— <sup>a</sup>	0.37	0.5	0.6	1.3	185	79	11.3	23.9	6.5	13.8	10	3/8	1/4	8423 0111 46
<b>With threaded spindle</b>																	
LSV12 S200	20000	50	UNC 1/4"x8	0.29	0.39	0.5	1.2	166	58	8.3	17.6	3.0	6.4	8	5/16	1/4	8423 1124 08
LSV12 S120	12000	75	UNC 1/4"x8	0.24	0.33	0.5	1.2	166	58	8.3	17.6	3.0	6.4	8	5/16	1/4	8423 1124 07
LSV19 S200	20000	50	UNC 1/4"x8	0.46	0.62	0.6	1.3	185	58	11.3	23.9	7.5	15.9	10	3/8	1/4	8423 0111 42
LSV19 S120	12000	75	UNC 1/4"x8	0.46	0.62	0.6	1.3	185	58	11.3	23.9	7.5	15.9	10	3/8	1/4	8423 0111 44
LSV19 S080	8000	75	UNC 1/4"x8	0.37	0.5	0.6	1.3	185	58	11.3	23.9	6.5	13.8	10	3/8	1/4	8423 0111 45
<b>Rotary sanders. Dry sanding</b>																	
LSV28 S060	6000	180	UNC 5/8"x32	0.73	0.98	1.5	3.2	265	87	16.0	33.9	7.3	15.5	10	3/8	3/8	8423 0125 30
LSV28 S060-M14	6000	180	M14x16	0.73	0.98	1.5	3.2	265	87	16.0	33.9	7.3	15.5	10	3/8	3/8	8423 0125 64
LSV28 S040	4000	180	UNC 5/8"x32	0.62	0.83	1.5	3.2	265	87	15.0	31.8	4.0	8.5	10	3/8	3/8	8423 0126 22
LSV28 ST034	3400	180	UNC 5/8"x32	0.71	0.95	1.7	3.7	289	87	18.0	38.2	7.7	16.3	10	3/8	3/8	8423 0135 80
LSV28 S021	2100	180	UNC 5/8"x32	0.68	0.91	1.9	4.1	289	87	16.0	33.9	5.6	11.9	10	3/8	3/8	8423 0125 19
LSV28 S021-M14	2100	180	M14x16	0.68	0.91	1.9	4.1	289	87	16.0	33.9	5.6	11.9	10	3/8	3/8	8423 0125 72
<b>Wet sanding</b>																	
LSV28 S040-01-M14	4000	180	M14x16	0.62	0.83	1.5	3.2	268	87	15.0	31.8	5.0	10.6	10	3/8	3/8	8423 0125 12
LSV28 ST008-01 LF	800	200	UNC 5/8"x32	0.68	0.91	2.0	4.3	307	87	16.0	33.9	5.6	11.9	10	3/8	3/8	8423 0125 51
<b>Lubrication-free. Dry sanding</b>																	
LSV28 ST013-M14 LF	1300	180	M14x16	0.68	0.91	1.7	3.7	289	87	20.0	42.4	9.0	19.1	10	3/8	3/8	8423 0125 28
LSV28 ST013 LF	1300	180	UNC 5/8"x32	0.68	0.91	1.7	3.7	289	87	20.0	42.4	9.0	19.1	10	3/8	3/8	8423 0126 26
LSV39 S085-5/8	8500	180	5/8" x 28	1.80	2.40	1.6	3.5	231	96	29.5	61.1	16.3	33.7	13	1/2	3/8	8423 0133 03
LSV39 S085-M14	8500	180	M14 x 28	1.80	2.40	1.6	3.5	231	96	29.5	61.1	16.3	33.7	13	1/2	3/8	8423 0133 04
LSV39 S066-5/8	6600	180	5/8" x 28	1.60	2.10	1.6	3.5	231	96	26.2	54.3	11.6	24.0	13	1/2	3/8	8423 0133 05
LSV39 S066-M14	6600	180	M14 x 28	1.60	2.10	1.6	3.5	231	96	26.2	54.3	11.6	24.0	13	1/2	3/8	8423 0133 06
LSV39 S120-5/8	12000	125	5/8" x 28	1.80	2.40	1.6	3.5	231	96	29.5	61.1	16.3	33.7	13	1/2	3/8	8423 0133 07
LSV48 SA085	8500	180	UNC 5/8"x21	1.9	2.5	2.3	5.1	316	78	36.0	76.0	17.0	36.0	16	5/8	1/2	8423 0132 02
LSV48 SA085-M14	8500	180	M14x18	1.9	2.5	2.3	5.1	316	78	36.0	76.0	17.0	36.0	16	5/8	1/2	8423 0132 03
LSV48 SA066	6600	180	UNC 5/8"x21	1.9	2.5	2.3	5.1	316	78	36.0	76.0	17.0	36.0	16	5/8	1/2	8423 0132 00

<sup>a</sup> Ø 6 mm collet.

-ST = Models with planetary gears.

-SA = Autobalancer.

## Accessories Included

Air hose nipple	Exhaust hose (LSV19/28/39)	Wrenches
Clamp	Support handle (LSV28/39/48)	

## Optional Accessories

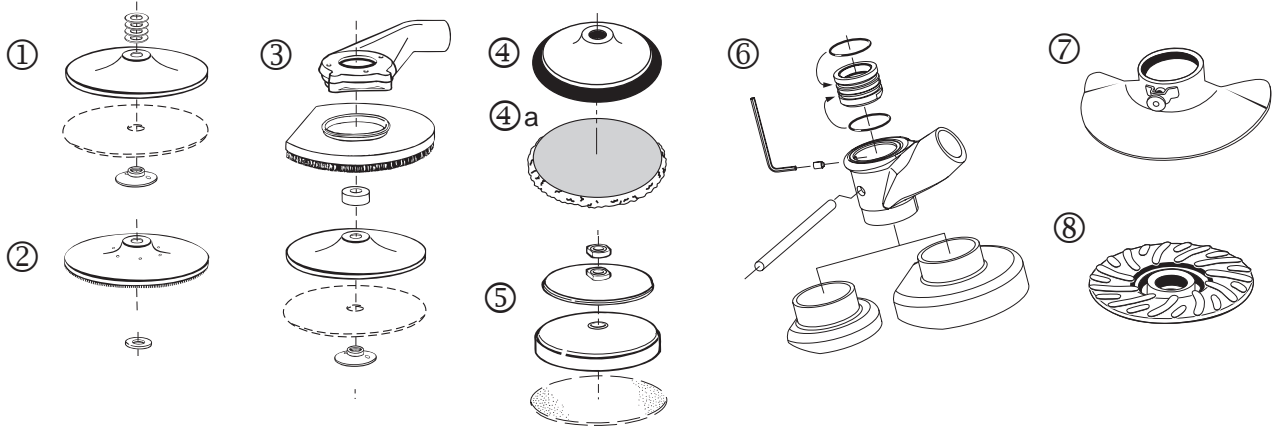

	LSV12	LSV19	LSV28	LSV39	LSV48	See ill.
<b>Backing set, standard type</b>						
Ø 125 mm - 5/8" - soft	-	-	4170 0768 80	4170 0768 80	4170 0768 80	1
Ø 180 mm - 5/8" - soft	-	-	4170 0756 80	4170 0756 80	4170 0756 80	1
Ø 180 mm - 5/8" - stiff	-	-	4170 0757 80	4170 0757 80	4170 0757 80	1
<b>Backing set with cooling ribs</b>						
Ø 125 mm - 5/8" and M14, medium	-	-	4150 1962 80	4150 1962 80	4150 1962 80	2
Ø 180 mm - 5/8" and M14, stiff	-	-	-	4150 1962 83	4150 1962 83	2
Ø 180 mm - 5/8" and M14, medium	-	-	4150 1962 81	4150 1962 81	4150 1962 81	2
<b>Backing set, heavy duty type</b>						
Ø 120 mm - M14	-	-	-	4175 0883 93	4175 0883 93	8
Ø 162 mm - M14	-	-	-	4175 0883 91	4175 0883 91	8
Ø 120 mm - 5/8"	-	-	-	4175 0883 92	4175 0883 92	8
Ø 162 mm - 5/8"	-	-	-	4175 0883 90	4175 0883 90	8
<b>Backing set for polishing - velcro</b>						
Ø 150 mm - 5/8" (max 2500 rpm)	-	-	4112 6092 15	-	-	4
Ø 150 mm - Lambs wool bonnet	-	-	4112 6093 15	-	-	4a
<b>Backing set for wet sanding</b>						
Ø 180 mm - 5/8" - foam rubber (max 2500 rpm)	-	-	4170 0428 83	-	-	5
<b>Spot suction kit for fiber disc</b>						
Ø 125 mm	-	-	3780 4007 80 <sup>a</sup>	3780 4008 85	-	3
Ø 180 mm	-	-	3780 4007 90 <sup>b/</sup> 3780 4031 60 <sup>c</sup>	3780 4008 84	3780 4093 40	3
Ø 50 - 75 mm	3780 4092 64 <sup>d</sup>	3780 4092 62 <sup>d/</sup> 3780 4092 65 <sup>e</sup>	-	-	-	6
Hand shield for 125-180 mm	-	-	-	4150 1936 80	-	7
Hand shield large, for 125-180 mm	-	-	-	4150 1941 80	-	7

<sup>a</sup> = Suits LSV28 S060      <sup>c</sup> = Suits LSV28 S021      <sup>e</sup> = For model with threaded spindle  
<sup>b</sup> = Suits LSV28 S040/060      <sup>d</sup> = For model with collet

## Productivity Kits

Model	Air inlet BSP	Max air flow	Hose, 5 m	Coupling	Lubrication	Ordering No.
MIDI Optimizer F/RD EQ10-R13-W, incl. whiphose	3/8	23 l/s	Rubair 13 mm	ErgoQIC 10	Yes	8202 0850 14
MIDI Optimizer F/RD EQ10-R13-W, incl. whiphose	-	23 l/s	Rubair 13 mm	ErgoQIC 10	Yes	8202 0850 15
MIDI Optimizer F/RD EQ10-T13	3/8	35 l/s	Turbo 13 mm	ErgoQIC 10	Yes	8202 0850 17
MIDI Optimizer F/R EQ10-T13	1/2	35 l/s	Turbo 13 mm	ErgoQIC 10	No	8202 0850 04
MIDI Optimizer F/RD EQ10-T13	1/2	35 l/s	Turbo 13 mm	ErgoQIC 10	Yes	8202 0850 13
MIDI Optimizer F/RD EQ10-T16	1/2	40 l/s	Turbo 16 mm	ErgoQIC 10	Yes	8202 0850 12



## Service Kits

LSV19	4081 0486 90	LSV39	4081 0537 90
LSV28	4081 0317 90	LSV48	4081 0312 90

# Belt Sanders

# For Sanding and Polishing

LMB27/LMB35 are suitable for precision sanding where access is difficult with conventional sanders.

The head rotation provides a versatile solution for many applications.



Model	Max output		Belt speed m/min	Belt dimension mm	Weight		Air consumption at free speed		Rec. hose size		Air inlet thread BSP in	Ordering No.
	kW	hp			kg	lb	l/s	cfm	mm	in		
LMB27 S014	0.275	0.37	1400	13X305	0.9	2	10	21.2	10	3/8	1/4	8423 0305 10
LMB35 S015	0.350	0.41	1500	19X520	1	2.2	11	23.3	10	3/8	1/4	8423 0305 20

## Accessories

### CONTACT ARM SANDING BELTS / CONTACT ARM FELT BELTS

Model	Ordering No.
<b>Contact arm sanding belts</b>	
<b>LMB27</b>	
13 x 305 mm (1/2" x 12")(std arm)	4112 3007 88
3 and 6 x 305 mm (1/8" and 1/4" x 12")	4112 3007 78
<b>LMB35</b>	
19 x 520 mm (3/4" x 20-1/2")(std arm)	4112 3008 83
19 x 460 mm (3/4" x 18")	4112 3008 81
<b>Contact arm felt belts</b>	
<b>LMB27</b>	
13 x 305 mm (1/2" x 12")	4112 3007 79

### 3M SANDING BELT KIT

	Grit size			
	40+	60+	80+	120+
<b>G2410</b>				
20 pcs, 6 x 305 mm (1/4"x12")	4170 1208 00	4170 1208 02	4170 1208 03	4170 1208 04
20 pcs, 13 x 305 mm (1/2"x12")	4170 1208 05	4170 1208 06	4170 1208 07	4170 1208 08
<b>G2420</b>				
20 pcs, 19 x 520 mm (3/4"x20-1/2")	4170 1208 13	4170 1208 14	4170 1208 15	4170 1208 16

### 3M SCOTCH-BRITE FELT BELT KIT

	Coars	Medium	Very fine
	<b>LMB27</b>		
10 pcs, 13 x 305 mm (1/2"x12")	4170 1210 00	4170 1210 01	4170 1210 02



## Service Kits

Model	Ordering No.
<b>Service kit motor</b>	
LMB35	4081 0520 90
LMB27	4081 0501 90
<b>Service kit general</b>	
LMB35	4081 0519 90
LMB27	4081 0502 90
<b>Service kit belt support</b>	
LMB35	4081 0521 90
LMB27	4081 0503 90

# Orbital and Random Orbital Sanders

Atlas Copco series of random orbital sanders combines all the important customer and application requirements in a very competitive range of products. Applications like sanding before painting and surface coating, polishing with wax and surface conditioner are all quickly done with the small and easily operated LST20-range of sanders.

All models are lubrication free and have silicone free components. The full range includes standard and dust extraction models, with three different orbit diameters to choose from.



Model	Max free speed r/min	Pad size mm	Orbit dia mm	Max output		Weight		Height over spindle mm	Length mm	Air consumption at free speed		Rec. hose size mm	Air inlet thread BSP	Ordering No.
				kW	hp	kg	lb			l/s	cfm			
<b>Random orbital – Standard</b>														
LST30 H090-11	9000	110	8	0.3	0.4	1.2	2.6	120	255	7.5	16	8	1/4	8423 0361 64
LST30 H090-15	9000	150	8	0.3	0.4	1.2	2.6	120	275	7.5	16	8	1/4	8423 0361 72
LST30 S090-15	9000	150	8	0.3	0.4	1.1	2.4	120	175	7.5	16	8	1/4	8423 0361 98
<b>Self suction<sup>a</sup></b>														
LST31 H090-15	9000	150	8	0.3	0.4	1.4	3.0	120	300	7.5	16	8	1/4	8423 0363 19
<b>Central suction<sup>b</sup></b>														
LST32 H090-15	9000	150	8	0.3	0.4	1.4	3.0	120	300	7.5	16	8	1/4	8423 0362 55
LST32 S090-15	9000	150	8	0.3	0.4	1.3	2.9	120	200	7.5	16	8	1/4	8423 0362 71
<b>Orbital – Standard</b>														
LSO30 S070-3	7000	93x170	5	0.3	0.4	1.6	3.5	125	185	7.5	16	8	1/4	8423 0360 16
LSO30 H070-3	7000	93x170	5	0.3	0.4	1.7	3.7	125	285	7.5	16	8	1/4	8423 0360 24
<b>Central suction<sup>c</sup></b>														
LSO32 H070-3	7000	93x170	5	0.3	0.4	1.8	4.0	125	310	7.5	16	8	1/4	8423 0361 07
<b>Standard model</b>														
LST20 R350	12000	90	5	0.2	0.27	0.85	1.85	95	127	8	17	8	1/4	8423 0361 65
LST20 R550	12000	125	5	0.2	0.27	0.85	1.85	83	127	8	17	8	1/4	8423 0361 69
LST20 R650	12000	150	5	0.2	0.27	0.85	1.85	83	127	8	17	8	1/4	8423 0361 73
LST20 R525	12000	125	2.4	0.2	0.27	0.85	1.85	83	127	8	17	8	1/4	8423 0361 81
LST20 R625	12000	150	2.4	0.2	0.27	0.85	1.85	83	127	8	17	8	1/4	8423 0361 84
<b>Extraction model – self suction</b>														
LST21 R550	12000	125	5	0.2	0.27	0.85	1.85	83	133 <sup>d</sup>	8	17	8	1/4	8423 0361 70
LST21 R650	12000	150	5	0.2	0.27	0.85	1.85	83	133 <sup>d</sup>	8	17	8	1/4	8423 0361 74
<b>Extraction model – central suction<sup>c</sup></b>														
LST22 R550	12000	125	5	0.2	0.27	0.85	1.85	83	133 <sup>d</sup>	8	17	8	1/4	8423 0361 71
LST22 R650	12000	150	5	0.2	0.27	0.85	1.85	83	133 <sup>d</sup>	8	17	8	1/4	8423 0361 75

<sup>a</sup> Includes dust collecting bag.

<sup>b</sup> Required air flow 150 m<sup>3</sup>/h or 88 cfm.

<sup>c</sup> Required air flow 60 m<sup>3</sup>/h or 35 cfm.

<sup>d</sup> 186 mm (7.3") suction hose connector included.

H = With handle.

S = Without handle.

-9 Velcro pad, 9 holes.

## Accessories Included

### LSO

Base pad  
Perforating plate  
Hose nipple for 8 mm hose

### LST20/21/22

Velcro pad  
U-wrench for pad change  
Air hose nipple  
Dust hose and bag (LST21)  
Large and small grip cover

### LST30/31/32

Velcro pad  
Bar for changing pad  
Hose nipple for 8 mm hose  
LST31 incl dust collection kit

## Optional Accessories

### LSO

For LSO	Ordering No.
Base pad, vinyl for F-type	4112 0787 01

### LST20/21/22, PAD FOR SELF STICK PAPER

	Ordering No.		
	Dia 89 mm	Dia 125 mm	Dia 150 mm
For LST20	4112 1231 00	4112 1233 00	4112 1235 00
For LST21/22		4112 1232 00	4112 1234 00

### LST20/21/22, PAD FOR VELCRO BACK PAPER

	Ordering No.		
	Dia 89 mm	Dia 125 mm	Dia 150 mm
For LST 20	4112 1218 00	4112 1216 00	4112 1214 00
For LST 21/22	-	4112 1217 00	4112 1215 00

### LST30/31/32

	Ordering No.
Pad velcro, Ø 150 mm	4112 0795 01 <sup>a</sup>
Pad velcro, Ø 110 mm	4112 0792 02 <sup>b</sup>

<sup>a</sup>LST30-15    <sup>b</sup>LST30/32-11



## Service Kits

LST20/21/22	4112 1300 90
LST30/31/32	4081 0131 90

### LSO

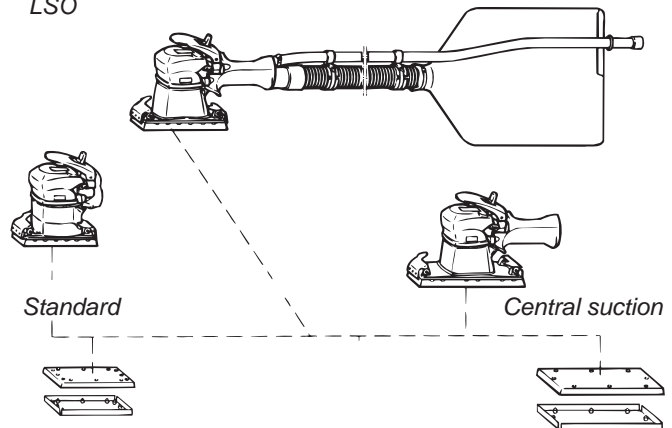

### LST

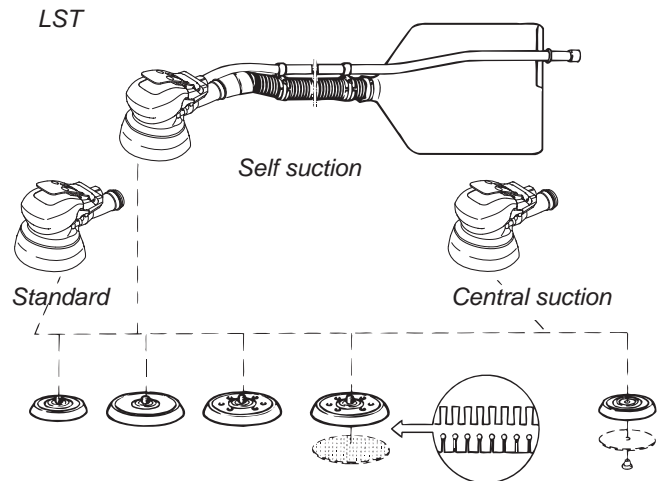

## HOLE PATTERN DIMENSIONS FOR SANDING PAPER, DUST EXTRACTION MODELS

### LSO31/32/33 S/H070-3 R-type pad

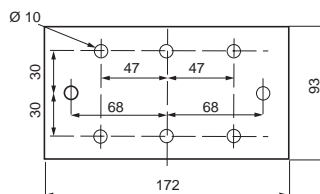

### LSO31/32-3 F-type pad

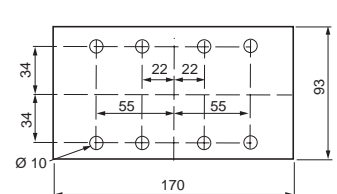

### LST20/21/22, 30/31/32

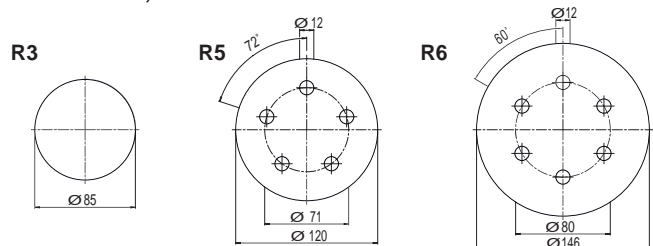



The fact that dust can represent a hazard in the working environment is well documented.

Dust particles from certain materials are dangerous to health. Even inert dust particles that cause no permanent damage can still be retained in the body and make breathing more difficult.

Efficient dust control can make a significant contribution to efficiency and productivity in industrial operations. It is already a requirement in countries with strict health and safety regulations.

Efficient dust control will:

- Reduce the health risk for operators exposed to potentially dangerous particles.
- Give a more favourable working environment which will encourage greater efficiency and effort from those who operate industrial tools.

The most efficient method of dust collection is extraction at the point of dust creation, i.e. on the tool itself. This not only ensures very efficient extraction but also allows a relatively low power vacuum source to be used.

Atlas Copco spot suction kits provide



**LSV 39**

an extraction hood fixed to the tool. It is fitted with a plastic or brush edge to trap heavier particles as well as the small ones. The following pages show a number of applications and the necessary dust extraction kits with their contents.

## MODELS PREPARED FOR USE WITH SPOT SUCTION KIT

Model	Max free speed r/min	Max output		Weight		Height over spindle		Air consumption at				Spindle thread	Air inlet thread BSP	Ordering No.
								max power		free speed				
								l/s	cfm	l/s	cfm			
LSV48 SA085	8500	1.9	2.5	2.3	5.1	78	3	36	76	17	36	UNC 5/8x21	1/2	8423 0132 02
LSV48 SA066	6600	1.9	2.5	2.3	5.1	78	3	36	76	17	36	UNC 5/8x21	1/2	8423 0132 00
LSV39 S085-5/8	8500	1.80	2.4	1.6	3.5	96	3.8	29.5	61.1	16.3	33.7	5/8x28	3/8	8423 0133 03
LSV39 S085-M14	8500	1.80	2.4	1.6	3.5	96	3.8	29.5	61.1	16.3	33.7	M14x28	3/8	8423 0133 04
LSV39 S066-5/8	6600	1.60	2.1	1.6	3.5	96	3.8	26.2	54.3	11.6	24	5/8x28	3/8	8423 0133 05
LSV39 S066-M14	6600	1.60	2.1	1.6	3.5	96	3.8	26.2	54.3	11.6	24	M14x28	3/8	8423 0133 06
LSV39 S120-5/8	12000	1.80	2.4	1.6	3.5	96	3.8	29.5	61.1	16.3	33.7	5/8x28	3/8	8423 0133 07

Spot suction kits are not included and must be ordered separately, see below.

## SPOT SUCTION KITS FOR GTG25, LSV48 AND LSV39

Model	Ordering No.	Application			
		Sanding Fiber disc dia, mm		Cutting GRP cutting with cutter disc dia, mm	
		125	180	125	180
GTG25 S085	8423 2525 03		3780 4090 27		
GTG25 S085-M14	8423 2525 04		3780 4090 27		
LSV48 SA085	8423 0132 02		3780 4093 40		3780 4093 42
LSV48 SA066	8423 0132 00		3780 4093 40		3780 4093 42
LSV39 S085-5/8	8423 0133 03		3780 4008 84		
LSV39 S085-M14	8423 0133 04		3780 4008 84		
LSV39 S066-5/8	8423 0133 05		3780 4008 84		
LSV39 S066-M14	8423 0133 06		3780 4008 84		
LSV39 S120-5/8	8423 0133 07	3780 4008 85		3780 4008 74	
<b>Optional accessory</b> Cutting disc				3780 5074 61	3780 5074 62

## KIT FOR BURR AND DRUM

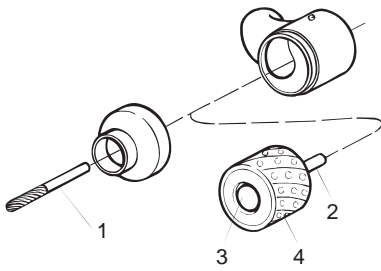

## KIT FOR SANDING PAD

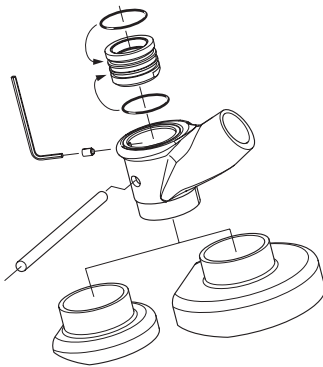

Add on spot suction

## KIT FOR DEPRESSED CENTER AND CUT OFF WHEELS

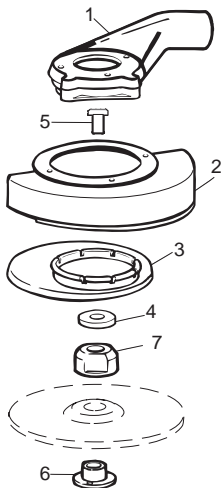

## SPOT SUCTION KITS FOR DIE GRINDERS

Suction requirement: 125 m<sup>3</sup>/h (LSV12), 125 m<sup>3</sup>/h (LSF19), 200 m<sup>3</sup>/h (LSF28)

		Ordering No.
LSV12	<b>KIT for sanding pad dia 50 and 75 mm</b>	3780 4092 64
LSF19 S	<b>KIT for burr</b>	3780 3015 22
	Optional 1 Diamond burr 6 mm	3780 5013 70
LSF19 S	<b>KIT for drum</b>	3780 4011 61
	Includes 2 Shaft dia 6 mm	3780 5090 30
	3 Locking screw	3780 5090 60
	Optional 4 Diamond drum 27 mm	3780 5033 00
LSV19 S with collet	<b>KIT for sanding, pad Ø 50 and Ø 75 mm</b>	3780 4092 62
LSV19 S with threaded spindle	<b>KIT for sanding, pad Ø 50 and Ø 75 mm</b>	3780 4092 65
LSF28 S	<b>KIT for burr</b>	3780 4007 42
	Optional 1 Diamond burr 6 mm	3780 5013 70
LSF28 S	<b>KIT for drum</b>	3780 4011 73
	Includes 2 Shaft dia 8 mm	3780 5091 00
	3 Locking nut	3780 5092 00
	Optional 4 Diamond drum, Ø 52 mm	3780 5035 00

## ADD ON SPOT SUCTION

	Ordering No.
Ø 125 mm	3780 4032 14
Ø 180-230 mm	3780 4032 12

## SPOT SUCTION KITS FOR DEPRESSED CENTER WHEELS

Suction requirement: 250 m<sup>3</sup>/h

		Ordering No.
LSV28 ST12 125 mm wheel	<b>KIT</b>	3780 4008 70
	Includes 5 Adapter UNF 3/8" UNC 5/8"	4021 0457 00
	6 Nut 5/8"	3780 2722 00

## VACUUM HOSE, 1.8 M

Hose	Ordering No.
Ø 25 mm for 125 m <sup>3</sup> /h suction requirement	3780 2724 20
Ø 32 mm for 200 m <sup>3</sup> /h suction requirement	3780 2724 31
Ø 38 mm for 250 m <sup>3</sup> /h suction requirement	3780 2724 40

## BRUSH FOR SUCTION CAP

	Ordering No.
Separate brush for cap Ø 125 mm (20 mm high)	3780 2678 00
Separate brush for cap Ø 180 mm (20 mm high)	3780 2677 50
Separate brush for cap Ø 180 mm (30 mm high)	3780 2677 30

LSV28/39/48/GTG40

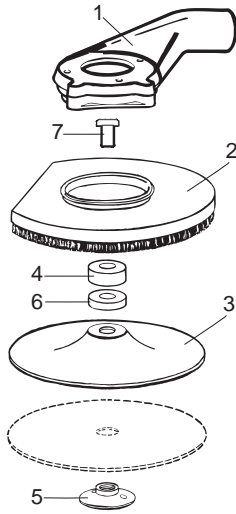

### SPOT SUCTION KITS FOR SANDING WITH FIBER DISC. SANDERS WITH UNC 5/8" SPINDLE.

Suction requirement: 250 m <sup>3</sup> /h		Ordering No.
LSV28 S040/S060 125 mm	<b>KIT</b>	3780 4007 80
Includes	2 Suction cap 125 mm with brush	3780 2650 20
	3 Backing pad 125 mm	3780 2710 30
	4 Distance washer 12 mm	3780 2721 60
	5 Nut 5/8"	3780 2722 00
LSV28 ST12-13 125 mm	<b>KIT</b>	3780 4008 60
Includes	2 Suction cap 125 mm with brush	3780 2650 20
	3 Backing pad 125 mm	3780 2710 30
	6 Distance washer 9 mm	3780 2721 50
	7 Adapter UNF 3/8" UNC 5/8"	4021 0457 00
	5 Nut 5/8"	3780 2722 00
LSV28 S040/S060 180 mm	<b>KIT</b>	3780 4007 90
Includes	2 Suction cap 180 mm with brush	3780 2675 00
	3 Backing pad 180 mm	3780 2710 60
	6 Distance washer 9 mm	3780 2721 50
	5 Nut 5/8"	3780 2726 70
LSV28 S021 180 mm	<b>KIT</b>	3780 4031 60
Includes	2 Suction cap 180 mm with brush	3780 2675 00
	3 Backing pad	3780 2710 60
	6 Distance washer 12 mm	3780 2721 60
	5 Nut 5/8"	3780 2726 70
LSV39 S066/S085 180 mm	<b>KIT</b>	3780 4008 84
Includes	2 Suction cap 180 mm with brush	3780 2675 00
	3 Backing pad 180 mm	3780 2710 60
	5 Nut 5/8"	3780 2726 70
	6 Distance washer 9 mm	3780 2721 50
LSV39 S120 125 mm	<b>KIT</b>	3780 4008 85
Includes	2 Suction cap 125 mm with brush	3780 2650 20
	3 Backing pad 125 mm	3780 2710 30
	5 Nut 5/8"	3780 2726 70
	6 Distance washer 9 mm	3780 2721 50
LSV48 SA066/SA085 180 mm	<b>KIT</b>	3780 4093 40
Includes	2 Suction cap 180 mm with brush	3780 2675 00
	3 Backing pad 180 mm	3780 2710 60
	4 Distance washer 9 mm	3780 2721 50
	5 Nut 5/8"	3780 2726 70
LSS53 S060 180 mm	<b>KIT</b>	3780 4011 00
Includes	2 Suction cap 180 mm with brush	3780 2675 00
	3 Backing pad 180 mm	3780 2710 60
	4 Distance washer 12 mm	3780 2721 60
	5 Nut 5/8"	3780 2726 70
GTG40 S060 180 mm	<b>KIT</b>	3780 4090 11
Includes	2 Suction cap 180 mm with brush	3780 2675 31
	3 Backing pad 180 mm	3780 2710 60
	4 Distance washer 6 mm	3780 2721 40
	5 Nut 5/8"	3780 2722 00

Pattern fixture cutting of composite in the aerospace industry as well as trimming of composite materials is preferably done with a router. The LSK37 is the only router with dust extraction and support bearing integrated into one unit. The LSK38 is prepared for using other router heads that are available on the market. This gives the LSK excellent performance and ergonomics in most composite applications.

- **Productive** – The speed governor maintains the rotational speed at applied feed force which enables fast and effective cutting and prevents the bit from clogging.
- **Ergonomic** – An integrated dust extraction hood for deportation of hazardous dust, thermally insulated throttle handle, sound dampening exhaust valve and piped-away exhaust air provides the operator with the best working environment.



LSK38



LSK37

Model	Free speed r/min	Collet size	Weight		Power		Air consumption		Rec. hose size		Hose fitting thread BSP	Ordering No.
			kg	lb	kW	hp	l/s	cfm	mm	in		
LSK37 S250-DS1	25000	6 mm	2.8	6.1	0.7	0.95	18	32	13	1/2	3/8	8423 1234 41
LSK37 S250-DS2	25000	1/4"	2.8	6.1	0.7	0.95	18	32	13	1/2	3/8	8423 1234 42
LSK38 S250 Do	25000	1/4"	1.1	2.2	1.3	1.8	28	58	13	1/2	3/8	8423 0700 00
LSK38 S180 Do	18000	1/4"	1.1	2.2	1.3	1.8	28	58	13	1/2	3/8	8423 0700 01

Suction requirement: LSK37: 200 m<sup>3</sup>/h. **NOTE:** LSK38 delivered without router head.

**KIT FOR SANDING WITH FIBER DISC**

Circular cutting operations in glass and carbon fiber as well as sheet metal and wood can successfully be performed with a circular cutter.

- **Effective** – LCS10 and LCS38 cut to a depth of 10 and 26 mm respectively.
- LCS38 is suitable for diamond coated blades only.
- **Dust extraction** – Cutting of composite materials generates dust containing particles that are hazardous to health. The dust must be deported in order to prevent the operator from inhaling it.

LCS38 is equipped with a cutter blade guard with integrated dust extraction hood for external vacuum source.

LCS38



LCS10



Model	Free speed r/min	Max output		Max cutting depth mm	Max cutter blade dia mm	Weight		Air consumption at free speed		Rec. hose size		Air inlet thread BSP	Ordering No.
		kW	hp			kg	lb	l/s	cfm	mm	in		
LCS10	3000	0.3	0.4	10	50	1.4	3.1	7.6	16	6.3	1/4	1/4	8424 1161 38
LCS38 S150D <sup>a</sup>	15000	1.3	1.7	26	100	1.7	3.7	28.0	58	13.0	1/2	3/8	8424 1125 06

<sup>a</sup> Suction requirement: 200 m<sup>3</sup>/h.

**Accessories Included**

**LCS38**

- Flanges for diamond blade
- Hose nipple for 13 mm air hose
- Exhaust hose

**Optional Accessories**

**CUTTER BLADES**

Model	Application	Max thickness of material mm	No. of teeth mm	Dia mm	Hole mm	Ordering No.
LCS10	Steel sheet	1.0	92	50	10	4190 0394 00
	Steel sheet	1.0	62	50	10	4190 0395 00 (std)
	Aluminum	2.5	34	50	10	4190 0396 00
	Wood	10.0	34	50	10	4190 0396 00
LCS38	Glassfibre	18.0	44/60 (Grain)	75	12	3780 5073 00
	Glassfibre	25.0	44/60 (Grain)	100	12	3780 5074 00

Model	Ordering No.
Suction hose set for LCS38 (L= 150 mm, Dia 1 1/4")	3780 2724 31

**Productivity Kits**

Model	Air inlet BSP	Max air flow	Hose, 5 m	Coupling	Lubrication	Ordering No.
MIDI Optimizer F/RD EQ10-T13	3/8	35 l/s	Turbo 13 mm	ErgoQIC 10	Yes	8202 0850 17
MIDI Optimizer F/R EQ10-T13	1/2	35 l/s	Turbo 13 mm	ErgoQIC 10	No	8202 0850 04
MIDI Optimizer F/RD EQ10-T13	1/2	35 l/s	Turbo 13 mm	ErgoQIC 10	Yes	8202 0850 13





# *Percussive tools*

## **Contents**

Introduction.....	231
Product safety.....	232
Chipping hammers .....	233
Scalers.....	235
Chisels.....	237
Riveting system .....	240
Riveting hammers.....	241
Bucking bars.....	243



# These tools make light of the toughest jobs

*Atlas Copco percussive tools are ideal for all material removal tasks in foundries, engineering workshops and shipyards. Built-in-ergonomic features such as vibration damping reduce the human load, delay fatigue and help protect the operator against the ill effects of long-term exposure to vibration and noise.*

Our tools are made out of lightweight alloys to keep weight down while maintaining performance. This makes our tools extremely effective in the hands of your skilled operators.

### **WELD FLUX REMOVAL**

Our tools are used when fettling welds from flux and spatter and in general scaling operations.

The conventional scaler RRC 13 and RRC 13B with a blowing function are the preferred models for these types of application. These tools have the right power and a sturdy reliable design. They also have a low vibration level for conventional models.

### **RUST AND PAINT REMOVAL**

Rust and paint removal is a common application found in various types of industries such as shipbuilding, large transport sector and on offshore rigs.

Our RVM07B has low noise and is vibration damped. The standard chisel delivered with the tool is carbide tipped for a long service life. The tool is also equipped with a clean blowing device.

For lighter jobs the needle scaler RRC 13N is the ideal tool. Needle sets of different shapes and material are available to suit most operations.

### **CHIPPING AND SCALING**

Percussive tools for chipping and scaling are widely used in all kinds of metalworking, construction and other industrial areas. Applications could be slag chipping, concrete trimming and sheet-metal cutting.

We offer high power-to-weight tools for these kind of applications. RRF 21/31 and RRD 37/57 models are vibration damped for operator comfort.

Our RRC22-RRC75 models are robust and highly dependable conventional chipping hammers suitable for heavy roughening.



# Product Safety

**IMPORTANT:** All local safety regulations with respect to installation, operation and overhaul must always be followed.

## AVOID ACCIDENTS

- 1** The chisel, die or punch may fall out or may be shot out of the tool accidentally causing serious injury.

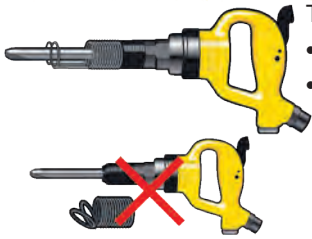

To prevent injury from a flying chisel:

- Always use a retainer.
- Inspect the retainer for wear or damage regularly.



- Be aware that the chisel may break during operation.
- Never trigger a hammer unless held against a work piece.
- Remove chisel, die or punch from tool when work is over.
- When finishing a job, disconnect the tool from its air supply.
- Before changing accessories, chisel or die – disconnect the tool from the air supply.

- 2** Chips and sparks should be prevented from striking an eye or another worker.



To prevent vision loss:

- Always wear eye protection.
- Isolate work of this kind by using barriers between work stations.
- Do not use the tool for other purposes than it is intended for.

- 3** Gloves protect fingers from pinching, scuffing and scraping.

- Protective shoes may prevent your feet from being injured.

- 4** Explosive atmosphere must not be ignited.



To prevent injury and property loss from fires:

- Use other technique.
- Use accessories of non sparking material (e.g. needle attachment of Beryllium copper for a needle scaler).

- 5** Electric shock may be fatal.

- Avoid chiseling into electric wiring hidden inside walls etc.

## LONG TERM RISKS

- 6** Always use ear protection.



To prevent gradual loss of hearing due to exposure to high noise level – wear ear protection.

- 7** Vibration may be harmful to hands and arms.



- Use vibration dampened tools if available.
- Reduce the total time of exposure to vibrations, particularly if the operator has to guide the chisel by hand.

- 8** Dust generated during operation may be harmful.

- Use spot suction or a breathing apparatus.

## PROPER USE AND MAINTENANCE

- 9** Do not perform idle blows with a hammer.



- They will cause high internal stresses and shorten the life of the tool.
- Note the risk of shooting out the chisel, die or punch if the retainer is not in order or damaged.

- 10** Quick coupling.

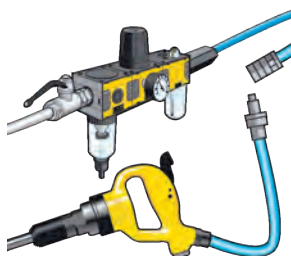

- If a coupling is used on a percussive tool, it should be separated from the tool by a whip hose (length 0.5 m).

- 11** Follow the tool manual and the lubrication instructions.

- 12** Perform overhauls at regular intervals.

- **RRF21/31** have a sturdy D-handle in light metal alloy for a high power-to-weight ratio and steady grip. The compact, vibration-controlled design offers good accessibility and ease of use.
- **RRD37/57** are light, quiet and have a long service life. They have light alloy tool casings, low vibration and noise levels, vibration damping in both hand grips, and piped away exhaust.



Model	Blows Hz	Piston dia		Stroke		Energy per blow		Weight		Bushing		Air consumption		Hose size		Air inlet	Ordering No.
		mm	in	mm	in	J	ft lb	kg	lb	mm	in	l/s	cfm	mm	in	BSP	
RRF21-01	57	18	0.7	33	1.3	2.0	1.5	1.75	3.3	12.7 <sup>c</sup>	0.50	6.5	13.8	10.0	3/8	3/8	8425 1104 05
RRF31-01	38	22	0.9	43	1.7	4.4	3.2	2.5	5.3	12.7 <sup>c</sup>	0.50	7.5	15.9	10.0	3/8	3/8	8425 1104 15
RRF31-02	38	22	0.9	43	1.7	4.4	3.2	2.5	5.3	12.7 <sup>c</sup>	0.50	7.5	15.9	10.0	3/8	3/8	8425 1104 16
RRD37-11	35	27/19 <sup>a</sup>	1.1/0.8	70	2.8	6.8	5.0	3.0	6.6	17.3 <sup>d</sup>	0.68	7.2	15.3	12.5	1/2	special <sup>e</sup>	8425 1101 22
RRD57-11	31	28/18 <sup>b</sup>	1.1/0.8	92	3.6	9.3	6.9	3.4	7.5	17.3 <sup>d</sup>	0.68	9.5	20.1	12.5	1/2	special <sup>e</sup>	8425 1103 20
RRD57-12	31	28/18 <sup>b</sup>	1.1/0.8	92	3.6	9.3	6.9	3.4	7.5	17.3 <sup>d</sup>	0.68	9.5	20.1	12.5	1/2	special <sup>e</sup>	8425 1103 38

<sup>a</sup> Effective piston dia 19 mm, 0.75 in.

<sup>b</sup> Effective piston dia 21.5 mm, 0.85 in.

<sup>c</sup> ISO.

<sup>d</sup> Spline.

<sup>e</sup> Integrated hose barb.

-01 and -11: Guided models.

-02 and -12: Non guided models.

# Chipping Hammers

- **Dependable** – Their robust construction makes them highly dependable.
- **Efficient** – RRC65 and RRC75 have a blow rate which makes them particularly suitable for roughening.
- **Chisel retainer** – for safer jobs – RRC22-RRC75 are delivered with a chisel retainer as standard. For the same reason choose a tool that can be guided via the machine itself and not by holding the chisel.

Atlas Copco chipping hammers of series RRC are delivered with a standard, guided ISO hexagon nozzle (-01) or a round, non guided shank nozzle (-02).



Model	Blows Hz	Piston dia		Stroke		Energy per blow		Weight		Bushing		Air consumption		Hose size		Air inlet	Ordering No.
		mm	in	mm	in	J	ft lb	kg	lb	mm	in	l/s	cfm	mm	in	BSP	
RRC22F-01	62	15	0.6	52	2.0	2.7	2.0	2.2	4.9	12.7 <sup>a</sup>	0.50	6.2	13.1	10	3/8	3/8	8425 0202 22
RRC22F-02	62	15	0.6	52	2.0	2.7	2.0	2.2	4.9	12.7 <sup>a</sup>	0.50	6.2	13.1	10	3/8	3/8	8425 0202 30
RRC34B-01	45	24	0.9	67	2.6	5.5	4.1	4.5	9.9	17.3 <sup>a</sup>	0.68	8.0	14.0	12.5	1/2	special <sup>b</sup>	8425 0212 53
RRC65B-01	40	29	1.1	50	2.0	10.0	7.3	5.9	13.0	17.3 <sup>a</sup>	0.68	10.8	22.9	12.5	1/2	special <sup>b</sup>	8425 0225 33
RRC75B-01	30	29	1.1	75	3.0	16.0	11.8	6.5	14.3	17.3 <sup>a</sup>	0.68	14.0	29.6	12.5	1/2	special <sup>b</sup>	8425 0225 58

<sup>a</sup> ISO. <sup>b</sup> Integrated hose barb.

## Dimensions

Model	L mm	H mm	D mm
RRF21	245	160	33
RRF31	265	170	36
RRD37	418	175	—
RRD57	458	190	—

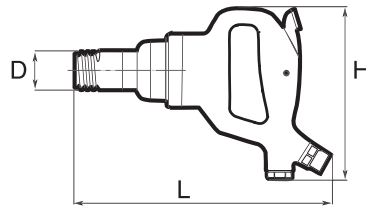

RRF21/31

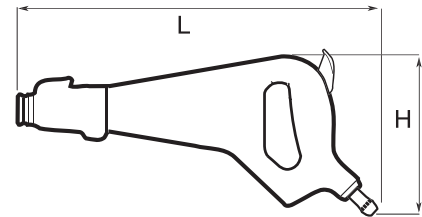

RRD37/57

Model	L mm	H mm	D mm
RRC22	260	155	34
RRC34	330	160	43
RRC65	335	170	54
RRC75	390	170	54

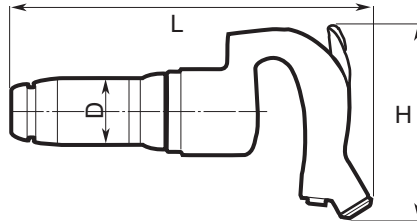

RRC

## Accessories Included

### RRF MODELS

Chisel retainer and a hose fitting

### RRD MODELS

Flat chisel  
Silencer complete  
Hand grip  
Key

### RRC MODELS

Chisel retainer and hose fitting

## Optional Accessories

Model	Ordering No.
<b>Power regulator</b>	
RRF21 and -31	3512 0273 80
<b>Retainer, open type</b>	
RRF21	3512 0290 90
RRF31	3512 0305 90
<b>Protective handle kit</b>	
RRF21	3512 0349 81
RRF31	3512 0349 82

### CHISELS

For a wide choice of chisels, see separate page.

## Productivity Kits

Model	Max air flow	Hose, 5 m	Coupling	Lubrication	Ordering No.
<b>For percussive tools with 3/8" BSP air inlet incl. whip hose</b>					
MIDI Optimizer F/RD EQ10-R13-W	23 l/s	Rubair 13 mm	ErgoQIC 10	Yes	8202 0850 14
<b>For percussive tools incl whip hose, no tool nipple included</b>					
MIDI Optimizer F/RD EQ10-R13-W	23 l/s	Rubair 13 mm	ErgoQIC 10	Yes	8202 0850 15



RVM07B is the obvious choice for task such as weld dressing light concrete trimming and for removal of paint and rust.

- **Vibration-damped with low-noise level.**
- **Two-job capacity** – RVM07B features a clean-blowing device which is very useful in order to keep the work piece clean from slagg and other particles from the process.



RVM07B

Model	Blows Hz	Length mm	Weight incl. standard chisel		Air consumption		Hose size		Air inlet BSP	Ordering No.
			kg	lb	l/s	cfm	mm	in		
RVM07B	100	273	1.7	3.8	3.8	8.1	6.3	1/4	1/4	8425 0105 25

## Dimensions

Model	L mm	D mm
RVM07B	273	38

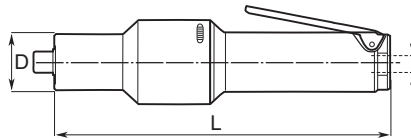

Choose between two different models for heavy slag chipping and for instant trimming of concrete.

- **High removal rate** – RRC13 is very effective and has a high removal rate in relation to its low weight.
- **Well proven** percussive mechanism and retainer.
- **Two-job capacity** – RRC13B with extra clean-blowing device.
- **Improved back head** – Throttle valve and lever with really Heavy Duty performance for long service life. Clean blowing system with twice the previous blow



RRC13B

capacity. Big blow button for easy operation and sturdy valve stem to resist rough handling.

Model	Blows Hz	Piston dia		Stroke		Energy per blow		Length mm	Weight		Air consumption		Hose size		Air inlet BSP	Ordering No.
		mm	in	mm	in	J	ft lb		kg	lb	l/s	cfm	mm	in		
RRC13	73	15	0.6	35	1.4	1.4	1.0	221	1.4	3.1	4.0	8.0	10	3/8	3/8	8425 0101 30
RRC13B	73	15	0.6	35	1.4	1.4	1.0	231	1.6	3.5	4.0	8.0	10	3/8	3/8	8425 0101 33

## Dimensions

Model	L mm	H mm	D <sub>1</sub> mm	D <sub>2</sub> mm
RRC13	221	65	45	41.5
RRC13B	231	65	45	41.5

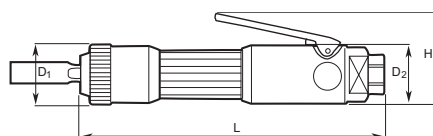

# Needle Scaler

The effective needle scaler, RRC13N, is based on the same fundamental design as the straight chipping hammers of type RRC13.

- **Sturdy design** – Easy to maintain.
- **Versatile** – The needle scaler is used to remove welding slag, rust and paint from steel structures.



RRC13N

Model	Blows Hz	Piston dia		Stroke		Energy per blow		Length mm	Weight		Air consumption		Hose size		Air inlet BSP	Ordering No.
		mm	in	mm	in	J	ft lb		kg	lb	l/s	cfm	mm	in		
RRC13N	73	15	0.6	35	1.4	1.4	1.0	352	1.9	4.2	4.0	8.0	10	3/8	3/8	8425 0101 36

## Dimensions

Model	L <sub>1</sub> mm	L <sub>2</sub> mm	D mm
RRC13N	282	352	38

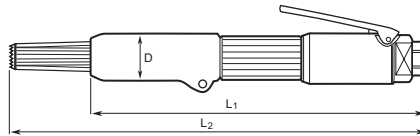

## Accessories Included

### FOR RRC13

Hose fitting  
Scaling chisel

### FOR RMV07B

Hose fitting  
Flat carbide tipped chisel 10x120 mm

## Optional Accessories

### FOR RRC13, 13B

RRC13 / RRC13B	Ordering No.
Hand guard	3510 0246 90
Silencer	3510 0366 80

Chisels for RRC13 and -13B:  
Square shank 13.0 mm

### FOR RRC13N

#### NEEDLE-SET OF 19 NEEDLES, LENGTH 100 MM

Material	Ordering No.
Steel, standard	3510 0221 90
Steel flat ends	3510 0227 90
Stainless steel flat ends	3510 0228 90
Beryllium copper flat ends (spark resistant)	3510 0229 90

### FOR RMV07B

Carbide tipped chisels and through hardened chisels with other length and width, see separate page for chisels.

## Productivity Kits

Model	Max air flow	Hose	Coupling	Lubrication	Ordering No.
<b>For percussive tools with 3/8" BSP air inlet incl. whip hose</b>					
MIDI Optimizer F/RD EQ10-R13-W	23 l/s	Rubair 13 mm	ErgoQIC 10	Yes	8202 0850 14
<b>For percussive tools incl whip hose, no tool nipple included</b>					
MIDI Optimizer F/RD EQ10-R13-W	23 l/s	Rubair 13 mm	ErgoQIC 10	Yes	8202 0850 15

# Chisels for chipping hammers and scalers



**CHISELS FOR CHIPPING HAMMERS.** All chisels are normally through hardened. Otherwise, see tables.

Figure	Shank type	Tools	Table
	Hexagon and round shank ISO, round collar 12.7 mm	RRC22F-01, RRC22F-02, RRF21, RRF31	1
	Hexagon shank ISO without round collar 17.3 mm	RRC34-01, RRC65-01, RRC75-01	2
	Round shank ISO, without collar 17.3 mm	RRC34-02, RRC65-02, RRC75-02	2
	Hexagon shank ISO round collar 17.3 mm	RRC34B-01, RRC65B-01, RRC75B-01	3
	Round shank ISO, with splines 17.3 mm	RRD37, RRD57	3

# Chisels for chipping hammers and scalers

TABLE 1











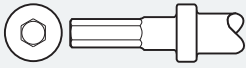









						 <b>A</b> Hex ISO 12.7 mm (1/2") Ordering No.		 <b>B</b> Round ISO 12.7 mm (1/2") Ordering No.	
Chisel type	Designation	Width		Length					
		mm	in	mm	in				
	Chisel blank	13	0.51	200	7.9	3085 0182 00			
		13	0.51	350	13.8	3085 0182 01			
		13	0.51	400	15.7	3085 0182 04			
		13	0.51	500	19.7	3085 0182 05			
	Flat chisel	13	0.51	200	7.9	3085 0183 00		3085 0184 00	
		35	1.38	300	11.8	3085 0376 00			
	Sharp chisel	15	0.59	200	7.9	3085 0170 00			
		15	0.59	300	11.8	3085 0170 01			
	Spot weld chisel	17	0.69	200	7.9	3085 0301 00			
	Angle scraper chisel	30	1.18	200	7.9	3085 0262 00			
	Pipe cutting chisel	20	0.78	200	7.9	3085 0302 00			
		35	1.38	200	7.9	3085 0303 00			
	Plate cutting chisel	14.5	0.57	200	7.9	3085 0263 00			
	Plate cutting chisel	16	0.62	200	7.9	3085 0173 00			
	Moil point chisel	13	0.51	200	7.9	3085 0297 00			
		13	0.51	305	12.0	3085 0297 01			

TABLE 2

						 <b>A</b> Round 17.3 mm (0.68") ISO Ordering No.		 <b>B</b> Hexagon 17.3 mm (0.68") ISO Ordering No.	
Chisel type	Designation	Width		Length					
		mm	in	mm	in				
	Chisel blank	23	0.91	200	7.9	3085 0150 00			
		23	0.91	560	22.0			3085 0140 01	
	Flat chisel	23	0.91	225	8.9	3085 0225 00		3085 0224 00	

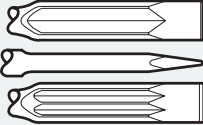
# Chisels for chipping hammers and scalers

TABLE 3

Chisel type		Width		Length		Hex ISO 17.3 mm (0.68") Ordering No.	Width		Length		Round ISO with splines 17.3 mm (0.68") Ordering No.
		mm	in	mm	in		mm	in	mm	in	
		22 0.86		335	13.1	3085 0220 00	22	0.86	250	9.8	3085 0242 00
		22 0.86		560	22.0	3085 0220 01	22	0.86	340	13.4	3085 0242 01
		22 0.86		1060	41.7	3085 0220 02	22	0.86	550	21.7	3085 0242 02
		22 0.86		260	10.2	3085 0221 00	22	0.86	215	8.5	3085 0236 00
		22 0.86		335	13.1	3085 0221 01	22	0.86	250	9.8	3085 0236 01
		22 0.86		560	41.9	3085 0221 02	22	0.86	340	13.4	3085 0236 02
		22 0.86		550	21.7	3085 0236 03	22	0.86	550	21.7	3085 0236 03
		32 1.26		335	13.1	3085 0989 00	32	1.26	340	13.4	3085 0252 00
		50 1.97		335	13.1	3085 0235 00	50	1.97	340	13.4	3085 0250 00
		130 5.12		400	15.7	3085 0342 00	130	5.12	400	15.7	3085 0998 00
		50 1.97		335	13.1	3085 0349 00	50	1.97	335	13.2	3085 0350 00
		130 5.12		400	15.7	3085 0342 00	130	5.12	400	15.7	3085 0998 00
		50 1.97		335	13.1	3085 0349 00	50	1.97	335	13.2	3085 0350 00
		130 5.12		400	15.7	3085 0342 00	130	5.12	400	15.7	3085 0998 00
		22 0.86		335	13.1	3085 0223 00	22	0.86	340	13.4	3085 0249 00
		22 0.86		560	15.7	3085 0223 01	22	0.86	560	15.7	3085 0223 01



## Minimum vibration, maximum productivity

*Atlas Copco's top-of-the-line riveting systems are designed to minimize the riveter's exposure to vibration, while maintaining high tool performance. The RRH recoilless riveting hammer has an air cushion behind the hammer piston which efficiently kills vibrations. The same air dampening technique is used in RBB bucking bars. It raises individual productivity and boosts output in your plant.*

The Atlas Copco riveting system includes vibration-damped hammers RRH and bucking bars RBB – as well as conventional riveting hammers RRN.

The vibration-damped riveting hammers – RRH – are available in different sizes.

Each size is available in “Trigger start” and “Push to start” models.

The conventional riveting hammer – RRN – is available in one size: RRN11P.

### CRITICAL FACTORS

The number of blows and the power are critical factors which determine the strength of a riveted joint. A few powerful blows are needed to fill out the hole and form a head when upsetting the rivet. The impact force is critical to some extent when working with aluminum alloys, as too many blows can embrittle the metal.

In terms of capacity, the tools overlap. The selection guide below helps you to find the right tool for your particular application of riveting.

The vibration-damped bucking bars RBB are available in two versions – the simple spring damped – SP type and the air servo assisted SA type.



## Selection Guide

Hammer model <sup>a</sup>	Nominal Max. Rivet Diameter Capacity						Bucking bar model required <sup>b</sup>
	Dural		Steel		Titanium		
	mm	in	mm	in	mm	in	
RRN11	2-5	3/32 - 3/16	1-4	3/32 - 5/32			
RRH04	2-5	3/32 - 3/16	1-4	3/21 - 5/32			RBB04
RRH06	4-7	5/32 - 1/4	3-6	1/8 - 1/4	2-4	3/32 - 5/32	
RRH08	5-8	3/16 - 5/16	4-7	5/32 - 1/4	3-6	1/8 - 1/4	
RRH10	5-9	3/16 - 3/8	6-8	1/4 - 5/16	4-7	5/32 - 1/4	
RRH12	8-11	5/16 - 7/16	7-10	1/4 - 3/8	6-9	1/4 - 3/8	
RRH14	11-13	7/16 - 1/2	9-12	3/8 - 15/32	8-11	5/16 - 7/16	

<sup>a</sup> Hammer capacity depends on direct/indirect riveting as well as Panel density and stiffness.

<sup>b</sup> Bucking bar capacity is dependent on dolly weight.

## Vibration-damped

## Riveting Hammers

RRH is a unique series of riveting hammers incorporating completely revolutionary ergonomic advantages.

- **Versatile** – RRH can easily cope with rivets in diameters up to 13 mm.
- **Vibration-damped system** – The RRH vibration-damped riveting hammer, combined with the RBB vibration-damped bucking bar, offer an unbeatable system for riveting.
- **Adjustable power.**
- **Adjustable hand guard** – Support hand grip is vibration-damped.
- Now new models with trigger start for excellent handling. Pistol grip with rubber coating.



Model	Airframe ref	Blows per minute	Rivet set shank		Piston dia		Stroke		Energy per blow		Weight		Air consumption		Hose size		Air inlet		Ordering No.
			mm	in	mm	in	mm	in	J	ft lb	kg	lb	l/s	cfm	mm	in	BSP		
<b>With push start</b>																			
RRH04P-01	2X	3960	10.0	0.4	15	0.6	40	1.6	2.0	1.5	1.0	2.2	3.7	6	6.3	1/4	1/4	8426 1111 07	
RRH04P-02	2X	3960	10.2	0.4	15	0.6	40	1.6	2.0	1.5	1.0	2.2	3.7	6	6.3	1/4	1/4	8426 1111 15	
RRH04P-12	2X	3960	10.2	0.4	15	0.6	40	1.6	2.0	1.5	1.0	2.2	3.7	6	6.3	1/4	1/4	8426 1111 25	
RRH06P	3X	2160	10.2	0.4	15	0.6	102	4.0	6.0	4.4	1.3	2.9	9.0	19	10.0	3/8	1/4	8426 1111 04	
RRH08P	4X	1440	10.2	0.4	15	0.6	137	5.4	8.0	5.9	1.4	3.0	10.0	21	10.0	3/8	1/4	8426 1111 09	
RRH10P	5XB	1500	12.7	0.5	19	0.7	118	4.6	13.0	9.6	2.0	4.4	12.0	24	10.0	3/8	1/4	8426 1110 20	
RRH12P	7XB	1200	12.7	0.5	19	0.7	153	6.0	16.0	11.8	2.1	4.6	13.0	28	10.0	3/8	1/4	8426 1110 47	
RRH14P	9XB	1080	12.7	0.5	19	0.7	188	7.4	19.5	14.4	2.2	4.8	13.0	28	10.0	3/8	1/4	8426 1110 80	
<b>With trigger start</b>																			
RRH04P TS-12	2X	3960	10.2	0.4	15	0.6	40	1.6	2.0	1.5	1.0	2.2	3.7	6	6.3	1/4	1/4	8426 1111 27	
RRH06P TS	3X	2160	10.2	0.4	15	0.6	102	4.0	6.0	4.4	1.3	2.9	9.0	19	10.0	3/8	1/4	8426 1111 66	
RRH08P TS	4X	1440	10.2	0.4	15	0.6	137	5.4	8.0	5.9	1.4	3.0	10.0	21	10.0	3/8	1/4	8426 1111 68	
RRH10P TS	5XB	1500	12.7	0.5	19	0.7	118	4.6	13.0	9.6	2.0	4.4	12.0	24	10.0	3/8	1/4	8426 1110 70	
RRH12P TS	7XB	1200	12.7	0.5	19	0.7	153	6.0	16.0	11.8	2.1	4.6	13.0	28	10.0	3/8	1/4	8426 1110 72	
RRH14P TS	9XB	1080	12.7	0.5	19	0.7	188	7.4	19.5	14.4	2.2	4.8	13.0	28	10.0	3/8	1/4	8426 1110 81	
RRH12P TS -ENG	7XB	1200	12.7	0.5	19	0.7	153	6.0	16.0	11.8	2.1	4.6	13.0	28	10.0	3/8	1/4	8426 1110 49	
RRH14P TS -ENG	9XB	1080	12.7	0.5	19	0.7	188	7.4	19.5	14.4	2.2	4.8	13.0	28	10.0	3/8	1/4	8426 1110 82	

-01 means 10 mm short shank rivet set.

-02 means 10.2 mm short shank rivet set.

-12 means 10.2 mm stand shank rivet set.

## Conventional Type

## Riveting Hammers

For riveting in confined spaces we recommend our RRN11 riveting hammer.

- **RRN11** – is the smallest riveting hammer available on the market, with unique accessibility.
- **Adjustable** – The RRN11 has a built-in adjustment knob with which you can set the power for different rivet materials and sizes.
- **Controllable** – The trigger is easily operated and provides excellent control.



Model	Airframe ref	Blows per minute	Rivet set shank		Piston dia		Stroke		Energy per blow		Weight		Air consumption		Hose size		Air inlet		Ordering No.
			mm	in	mm	in	mm	in	J	ft lb	kg	lb	l/s	cfm	mm	in	BSP		
RRN11P-01	2X	3960	10.0	0.4	15	0.6	40	1.6	2.0	1.5	1.2	2.6	3.4	7.2	6.3	1/4	1/8	8426 1101 05	
RRN11P-02	2X	3960	10.2	0.4	15	0.6	40	1.6	2.0	1.5	1.2	2.6	3.4	7.2	6.3	1/4	1/8	8426 1101 13	

-01 means 10 mm short shank rivet set.

-02 means 10.2 mm short shank rivet set.

## Dimensions

Model	L mm	H mm	C mm
<b>RRH</b>			
RRH04-01	160	147	23
RRH04-02	160	147	23
RRH04-12	175	147	23
RRH06	225	147	24
RRH08P	244	147	24
RRH10P	264	150	27
RRH12P	299	150	27
RRH14P	334	150	27
<b>RRN</b>			
RRN11P	100	170	23

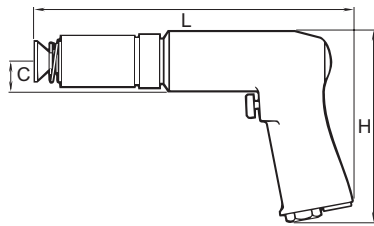

RRH

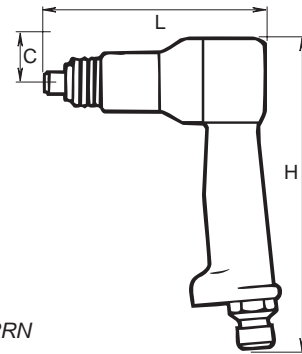

RRN

## Accessories Included

### FOR RRH MODELS

Hose fitting  
Flush set  
Open spring retainer

### FOR RRN11P

Hose fitting and retainer  
Blank rivet set  
Retainers for blank and flush rivet set

## Optional Accessories

### RIVET SETS. RRH AND RRN

Hammer type	Model	Shank mm	Flush set	Ordering No.	Blank rivet set	Ordering No.
RRH04P-01 RRN11P-01	(-01)	10.0 spec		3085 0347 00		3006 0983 00
RRH04P-02 RRN11P-02	(-02)	10.2 spec		3085 0352 00		3085 0353 00
RRH04P-12 RRH06P RRH08P	(-12)	10.2 std		3085 0324 00		3085 0022 00
RRH10P RRH12P RRH14P		12.7 std		3085 0323 00		3085 0021 00
RRH04P-12 RRH06P RRH08P		10.2 std				3085 0212 00 Mandrel blank
RRH04P-12 RRH06P RRH08P		10.2 std				3085 0212 02

An efficient riveting system consists of vibration-damped bucking bars together with vibration-damped riveting hammers.

- **Cramped spaces** – Mini bucking bars RBB04SP are ideal for work in confined spaces. The large mass types -04, -05 will in most applications set the rivet faster than the smaller models.



Model	Weight		Diameter		Ordering No.
	kg	lb	mm	in	
<b>Mini bucking bars</b>					
RBB04SP-01	0.8	1.8	46	1.8	8426 9101 10
RBB04SP-04	1.3	2.9	46	1.8	8426 9101 13
RBB04SP-05	1.4	3.1	46	1.8	8426 9101 14
RBB04SP-06	1.1	2.5	46	1.8	8426 9101 15

## Dimensions

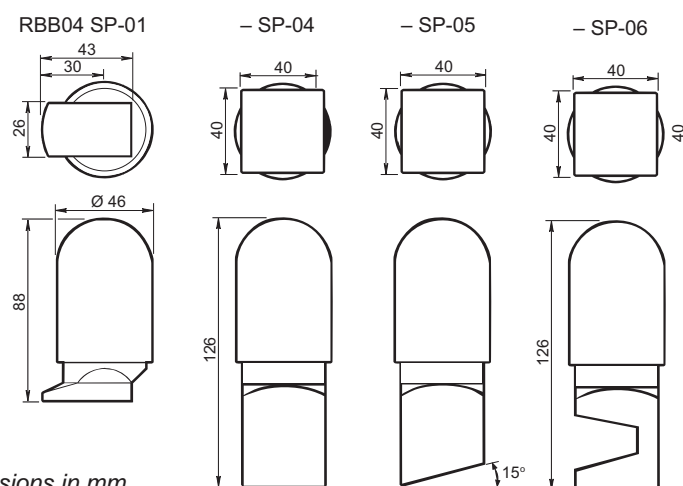

Dimensions in mm



# Drills

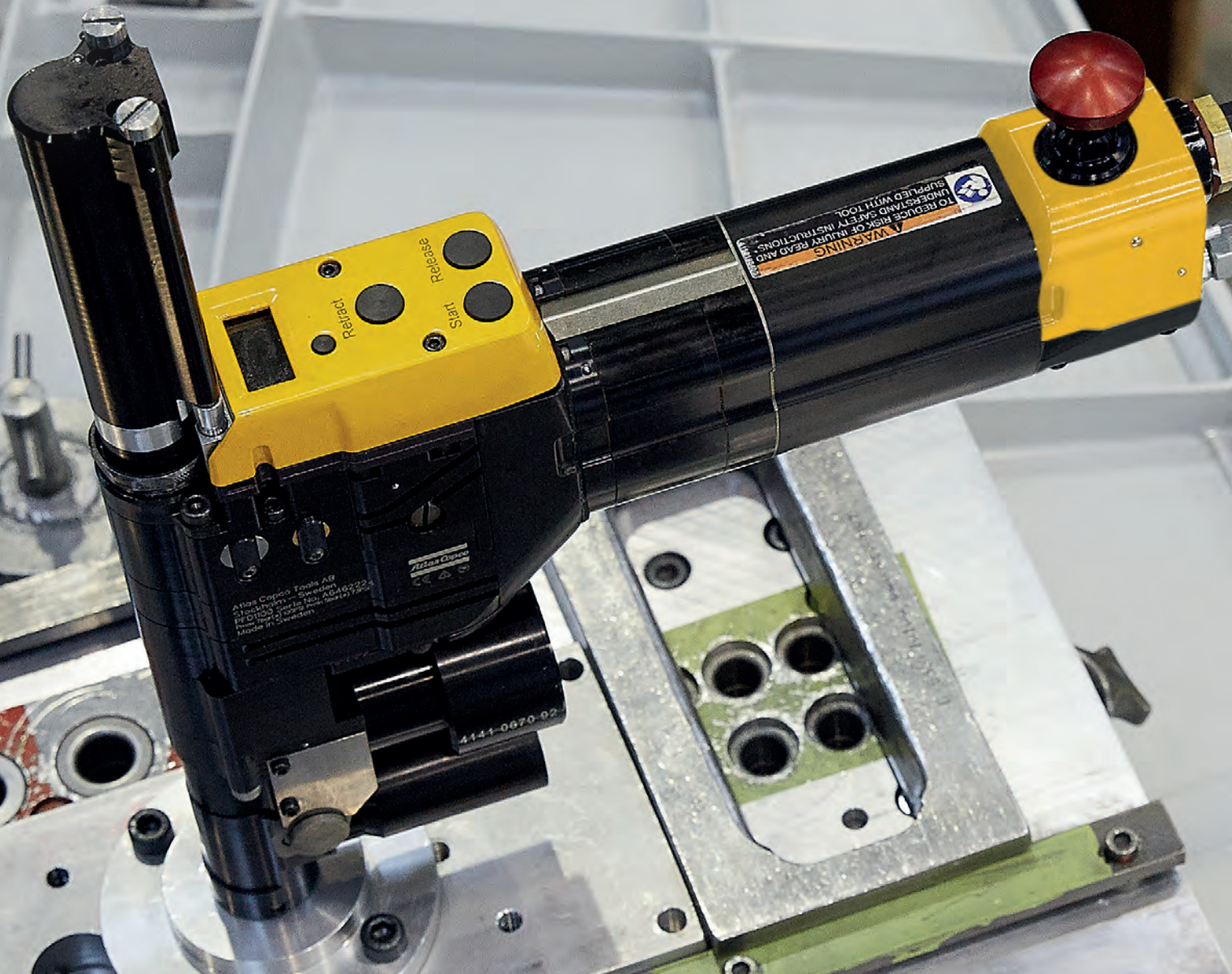

## Contents

Introduction.....	245
Pistol grip drills .....	247
Straight drills.....	251
Angle drills.....	253
Modular drills .....	257
Micro stop drills.....	260
Tappers.....	262
Positive feed drills.....	264



# Reliable, productive and comfortable to work with



*The handheld drills in Atlas Copco's wide range are of the highest quality and built to provide consistent reliability and performance in a wide range of applications. Their advanced ergonomic designs make your job easier, safer and more efficient.*

From the time our first drill was produced in 1901, Atlas Copco has demonstrated a genuine understanding of customer needs. Our drills have evolved to meet changing customer demands over the years. Whatever the job, Atlas Copco has a drill to match your exact requirements.

### **RELIABLE**

When you pick up an Atlas Copco drill, you can be confident that it will do the job over and over again.

### **POWERFULLY PRODUCTIVE**

Despite their compact designs, our drills consistently deliver all the power you need. Their high power-to-weight ratio ensures maximum material removal in the shortest possible time.

### **ERGONOMIC**

Thanks to 50 years of focusing on ergonomics, Atlas Copco drills fit comfortably in your hand. Grips are anatomically shaped to keep your arm and wrist straight, reducing the risk of injury during

long-term use. The light weight and perfect balance of each drill enables you to guide it smoothly and easily. Low noise and vibration levels make the tools comfortable to work with all day long.

### **DURABLE, LOW MAINTENANCE**

The rugged, lubrication-free designs of our drills can withstand the toughest industrial situations and go on working day in, day out. Maintenance requirements are low.

### **QUALITY THROUGHOUT THE TOOLS' LIFE-CYCLE**

Atlas Copco stands for quality, from the manufacture of critical drill components, through production and sales, to service and support throughout the tools' long life-cycle.



# Drills

## LBB 16 FEATURES



## LBB 16S FEATURES

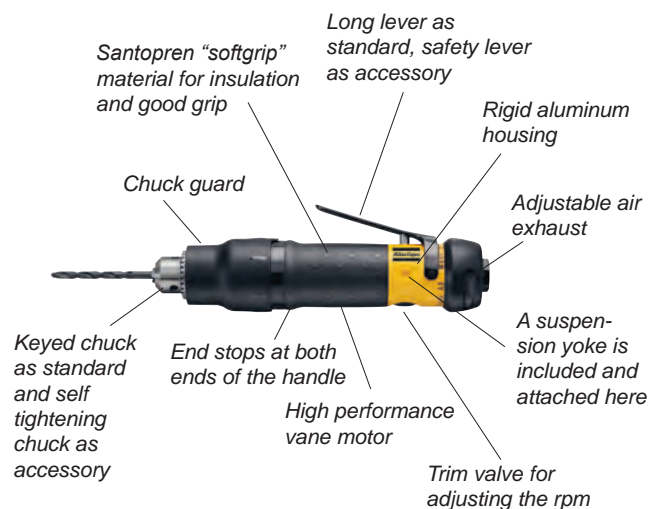

## Selection Guide

The speed for a specific drilling operation should be chosen on the basis of the material in the workpiece and the diameter of the hole.

In the selection guide, you will find proposals for suitable free speeds for selection of the correct tool.

Please use the information below as a guide only. Many variables contribute to the optimal speed choice for a specific application.

Cutting speed <sup>a</sup> m/min	Material		rpm																												
			300	400	500	600	700	800	1000	1200	1300	1500	1700	1900	2200	2400	2600	2900	3000	3300	3700	3800	4500	5500	6000	6400	6500	20000	23000	26000	
5	Titanium	Alloy Steel	5	4	3	3	2	2	2	1	1	1	1	1	1	1	1	1	1	1	1	1	1	1							
10			11	8	6	5	5	4	3	3	2	2	2	2	1	1	1	1	1	1	1	1	1	1	1	1	1	1	1		
15			Cast iron	Mild steel	12	10	8	7	6	5	4	4	3	3	3	2	2	2	2	2	2	1	1	1	1	1	1	1	1	1	
20					16	13	11	9	8	6	5	5	4	4	3	3	3	2	2	2	2	2	2	2	2	2	1	1	1	1	
25								13	11	10	8	7	6	5	5	4	4	3	3	3	3	2	2	2	2	2	2	1	1	1	1
30	Hard plastics								10	8	7	6	5	4	4	4	3	3	3	3	3	3	2	2	2	2	1	1			
35										9	9	7	7	6	5	5	4	4	4	3	3	3	3	2	2	2	2	2	1		
40											10	8	7	7	6	5	5	4	4	4	3	3	3	3	2	2	2	2	2	1	1
45												10	8	8	7	6	5	5	4	4	4	4	3	3	3	3	2	2	2	1	1
50	Composite	Aluminum and bronze															6	5	5	5	4	4	4	3	3	2	2	1	1		
55																10	9	8	7	6	6	5	5	5	4	3	3	3	3	1	1
60																	11	10	9	7	7	6	6	5	5	4	3	3	3	1	1
65																		12	9	8	7	6	6	5	5	4	3	3	3	1	1
70																		13	10												1
75																			14												1
80																				15											1
85																					16										1
90																															1
95																															1
100																															1
105																															1
110	Wood and board																												1		
115																														1	
120																														1	
125																														1	
130																														1	
135																														1	
140																														1	
145																														1	
150																														1	

<sup>a</sup> Remember that, if the speed is too low the cycle time increases.

Regardless of which model you choose, you'll get a product with superior ergonomics and productivity.

- Quiet – Very low noise level.
- Comfortable grip – For high precision.
- Two-hand grip available – Gives even greater flexibility.
- Lubrication-free – For clean working environment and operator comfort.



Model	Free speed r/min	Chuck capacity mm	Weight with chuck		Air consumption at free speed		Hose size		Air inlet thread BSP	Power		Stall torque Nm	With chuck Ordering No.	Without chuck	
			kg	lb	l/s	cfm	mm	in		W	hp			Model	Ordering No.
<b>Non-reversible drills with air supply through handle</b>															
LBB16 EP-003 <sup>b</sup>	300	10	0.7	1.5	8.0	17.0	6.3	1/4	1/4	290	0.4	-	8421 0108 01	003-U	8421 0108 02
LBB16 EP-005 <sup>b</sup>	500	10	0.7	1.5	8.0	17.0	6.3	1/4	1/4	290	0.4	21.6	8421 0108 06	005-U	8421 0108 07
LBB16 EP-005-U-AL <sup>c</sup>	500	10	0.7	1.5	8.0	17.0	6.3	1/4	1/4	290	0.4	21.6	8421 0108 16	-	-
LBB16 EP-010	1000	10	0.7	1.5	8.0	17.0	6.3	1/4	1/4	290	0.4	7.8	8421 0108 10	010-U	8421 0108 11
LBB16 EP-010-U-AL <sup>c</sup>	1000	10	0.7	1.5	8.0	17.0	6.3	1/4	1/4	290	0.4	7.8	8421 0108 15	-	-
LBB16 EP-024 <sup>a</sup>	2400	6.5	0.6	1.2	8.0	17.0	6.3	1/4	1/4	290	0.4	4.2	8421 0108 20	024-U	8421 0108 21
LBB16 EP-024-AL <sup>c</sup>	2400	6.5	0.6	1.2	8.0	17.0	6.3	1/4	1/4	290	0.4	4.2	8421 0108 19	-	-
LBB16 EP-033 <sup>a</sup>	3300	6.5	0.6	1.2	8.0	17.0	6.3	1/4	1/4	290	0.4	3.4	8421 0108 30	033-U	8421 0108 31
LBB16 EP-033-AL <sup>c</sup>	3300	6.5	0.6	1.2	8.0	17.0	6.3	1/4	1/4	290	0.4	3.4	8421 0108 18	-	-
LBB16 EP-045 <sup>a</sup>	4500	6.5	0.6	1.2	8.0	17.0	6.3	1/4	1/4	290	0.4	2.0	8421 0108 40	045-U	8421 0108 41
LBB16 EP-045-AL <sup>c</sup>	4500	6.5	0.6	1.2	8.0	17.0	6.3	1/4	1/4	290	0.4	2.0	8421 0108 04	-	-
LBB16 EP-060 <sup>a</sup>	6000	6.5	0.6	1.2	8.0	17.0	6.3	1/4	1/4	290	0.4	1.7	8421 0108 50	060-U	8421 0108 51
LBB16 EP-060-AL <sup>c</sup>	6000	6.5	0.6	1.2	8.0	17.0	6.3	1/4	1/4	290	0.4	1.7	8421 0108 25	-	-
LBB16 EP-200 <sup>a</sup>	20000	6.5	0.6	1.2	8.0	17.0	6.3	1/4	1/4	290	0.4	0.5	8421 0108 60	200-U	-
LBB16 EPX-005 <sup>b</sup>	500	10	0.7	1.5	9.5	20.0	6.3	1/4	1/4	340	0.45	25.2	8421 0108 08	005-U	8421 0108 09
LBB16 EPX-010 <sup>b</sup>	1000	10	0.7	1.5	9.5	20	6.3	1/4	1/4	340	0.45	12.3	8421 0108 12	010-U	8421 0108 03
LBB16 EPX-024 <sup>a</sup>	2400	6.5	0.6	1.2	9.5	20.0	6.3	1/4	1/4	340	0.45	4.9	8421 0108 22	024-U	8421 0108 23
LBB16 EPX-033 <sup>a</sup>	3300	6.5	0.6	1.2	9.5	20.0	6.3	1/4	1/4	340	0.45	3.7	8421 0108 32	033-U	8421 0108 33
LBB16 EPX-045 <sup>a</sup>	4500	6.5	0.6	1.2	9.5	20.0	6.3	1/4	1/4	340	0.45	3.0	8421 0108 42	045-U	8421 0108 43
LBB16 EPX-060 <sup>a</sup>	6000	6.5	0.6	1.2	9.5	20.0	6.3	1/4	1/4	340	0.45	2.3	8421 0108 52	060-U	8421 0108 53
LBB16 EPX-200 <sup>a</sup>	20000	6.5	0.6	1.2	9.5	20	6.3	1/4	1/4	340	0.45	0.6	8421 0108 82	200-U	8421 0108 63
LBB26 EPX-003 <sup>b</sup>	300	13	0.82	1.8	14.5	31.8	10.0	3/8	1/4	500	0.7	53.5	8421 0500 00	003-U	8421 0500 01
LBB26 EPX-005 <sup>b</sup>	500	13	0.82	1.8	14.5	31.8	10.0	3/8	1/4	500	0.7	31.6	8421 0500 02	005-U	8421 0500 03
LBB26 EPX-007 <sup>b</sup>	700	13	0.82	1.8	14.5	31.8	10.0	3/8	1/4	500	0.7	24.6	8421 0500 04	007-U	8421 0500 05
LBB26 EPX-013 <sup>ab</sup>	1300	10	0.79	1.7	14.5	31.8	10.0	3/8	1/4	500	0.7	14.7	8421 0500 06	013-U	8421 0500 07
LBB26 EPX-019 <sup>a</sup>	1900	10	0.79	1.7	14.5	31.8	10.0	3/8	1/4	500	0.7	9.9	8421 0500 24	019-U	8421 0500 25
LBB26 EPX-026 <sup>a</sup>	2600	8	0.79	1.7	14.5	31.8	10.0	3/8	1/4	500	0.7	7.7	8421 0500 08	026-U	8421 0500 09
LBB26 EPX-033 <sup>a</sup>	3300	8	0.69	1.5	14.5	31.8	10.0	3/8	1/4	500	0.7	5.7	8421 0500 10	033-U	8421 0500 11
LBB26 EPX-045 <sup>a</sup>	4500	8	0.69	1.5	14.5	31.8	10.0	3/8	1/4	500	0.7	4.1	8421 0500 12	045-U	8421 0500 13
LBB26 EPX-060 <sup>a</sup>	6000	8	0.69	1.5	14.5	31.8	10.0	3/8	1/4	500	0.7	3.3	8421 0500 14	060-U	8421 0500 15
LBB26 EPX-200 <sup>a</sup>	22000	6.5	0.69	1.5	14.5	31.8	10.0	3/8	1/4	500	0.7	0.8	8421 0500 28	200-U	8421 0500 29
LBB36 H005 <sup>b</sup>	500	-	1.2	3.3	16.5	34.9	10	3/8	3/8	700	0.9	43.8	-	-H005U	8421 0408 03
LBB36 H007 <sup>b</sup>	700	13	1.6	3.5	16.5	34.9	10	3/8	3/8	700	0.9	37.2	8421 0408 07	-H007U	8421 0408 05
LBB36 H013 <sup>a</sup>	1300	10	1.5	3.3	16.5	34.9	10.0	3/8	3/8	700	0.9	19.5	8421 0408 15	-H013U	8421 0408 13
LBB36 H026 <sup>a</sup>	2600	10	1.2	2.5	16.5	34.9	10.0	3/8	3/8	700	0.9	10.3	8421 0408 33	-H026U	8421 0408 31
LBB36 H033 <sup>a</sup>	3300	10	1.2	2.5	16.5	34.9	10.0	3/8	3/8	700	0.9	8.6	8421 0408 41	-H033U	8421 0408 39
LBB36 H060 <sup>a</sup>	6000	6.5	1.2	2.5	16.5	34.9	10.0	3/8	3/8	700	0.9	5.0	8421 0408 49	-H060U	8421 0408 47
LBB36 H200 <sup>a</sup>	22000	6.5	1.0	2.2	16.5	34.9	10.0	3/8	3/8	700	0.9	1.3	8421 0408 55	-H200U	8421 0408 53
LBB37 H006	600	13	1.2	2.5	20.5	44.0	10.0	3/8	3/8	820	1.1	48.0	8421 0608 06	-H006U	8421 0608 14
LBB37 H015	1500	10	1.5	3.3	20.5	44.0	10.0	3/8	3/8	820	1.1	22.5	8421 0608 05	-H015U	8421 0608 15
LBB37 H037	3700	10	1.2	2.5	20.5	44.0	10.0	3/8	3/8	820	1.1	9.2	8421 0608 13	-H037U	8421 0608 16
LBB37 H065	6500	6.5	1.2	2.5	20.5	44.0	10.0	3/8	3/8	820	1.1	5.0	8421 0608 11	-H065U	8421 0608 17
LBB37 H230	23000	6.5	1.0	2.2	20.5	44.0	10.0	3/8	3/8	820	1.1	1.3	8421 0608 03	-H230U	8421 0608 18
LBB45 H004 <sup>b</sup>	400	16	4.3	9.3	10.0	21.0	10.0	3/8	1/4	700	0.9	-	8421 0501 16	-	-
LBB45 H006 <sup>b</sup>	600	16	4.3	9.3	10.0	21.0	10.0	3/8	1/4	700	0.9	-	8421 0501 24	-H006U	8421 0501 40
LBB45 H017 <sup>b</sup>	1700	16	4.2	9.3	10.0	21.0	10.0	3/8	1/4	700	0.9	-	8421 0501 32	-	-
<b>ATEX certified models</b>															
LBB26 EPX005-ATEX	500	13	0.82	1.8	14.5	31.8	10	3/8	1/4	500	0.7	-	8421 0500 22	-	-
LBB26 EPX007-ATEX	700	13	0.82	1.8	14.5	31.8	10	3/8	1/4	500	0.7	-	8421 0500 21	-	-
LBB26 EPX013-ATEX	1300	10	0.79	1.7	14.5	31.8	10	3/8	1/4	500	0.7	-	8421 0500 20	-	-
LBB26 EPX026-ATEX	2600	8	0.79	1.7	14.5	31.8	10	3/8	1/4	500	0.7	-	8421 0500 19	-	-

<sup>a</sup> Including chuck guard. <sup>b</sup> Including support handle. <sup>c</sup> -AL = Drill nose is non painted silver Aluminum.

Continued...

Model	Torque range soft joint		Free speed r/min	Weight		Length mm	CS distance mm	Air consumption at free speed		Rec. hose size mm	Air inlet thread in	Ordering No.
	Nm	in lb		kg	lb			l/s	cfm			
<b>Reversible drill, taper and screwdriver</b>												
COMBI22 HR2	2.0-2.7	18-24	3600	0.9	2.0	205	20	7	15	8	1/4	8431 0255 89
COMBI22 HR5	2.7-5.7	24-50	1600	0.9	2.0	205	20	7	15	8	1/4	8431 0255 80
COMBI22 HR10	5.0-10.0	44-89	800	1.1	2.4	240	20	7	15	8	1/4	8431 0255 62
COMBI34 HR04	8.0-18.0	71-160	400	1.5	3.3	228	20	9	19	10	1/4	8431 0311 32
COMBI34 HR08	8.0-11.0	71-97	750	1.3	2.9	218	20	9	19	10	1/4	8431 0311 34
COMBI34 HR16	4.0-8.0	35-71	1600	1.0	2.2	179	20	9	19	10	1/4	8431 0311 36

## Dimensions

### LBB EP/EPX/H

Model	L mm	H mm	C mm	D mm	E mm
LBB16 EP/EPX-200	177	131	16.5	31.4	13.8
LBB16 EP/EPX-060	177	131	16.5	31.4	13.8
LBB16 EP/EPX-045	177	131	16.5	31.4	13.8
LBB16 EP/EPX-033	177	131	16.5	31.4	13.8
LBB16 EP/EPX-024	177	131	16.5	31.4	13.8
LBB16 EP/EPX-010	190	131	16.5	31.4	27.0
LBB16 EP/EPX-005	190	131	16.5	31.4	27.0
LBB16 EP-003	190	131	16.5	31.4	27.0
LBB26 EPX-060	180	147	21	39	-
LBB26 EPX-045	180	147	21	39	-
LBB26 EPX-033	180	147	21	39	-
LBB26 EPX-026	180	147	21	39	-
LBB26 EPX-019	196	147	21	39	-
LBB26 EPX-013	196	147	21	39	-
LBB26 EPX-007	196	147	21	39	-
LBB26 EPX-005	196	147	21	39	-
LBB26 EPX-003	196	147	21	39	-
LBB36 H200	217	157	23	41.5	16.5
LBB36 H060	217	157	23	41.5	16.5
LBB36 H033	217	157	23	41.5	16.5
LBB36 H026	217	157	23	41.5	16.5
LBB36 H013	256	157	23	41.5	64.0
LBB36 H007	256	157	23	41.5	64.0
LBB36 H005	256	157	23	41.5	64.0
LBB37 H230	217	157	23	41.5	16.5
LBB37 H065	217	157	23	41.5	16.5
LBB37 H037	217	157	23	41.5	16.5
LBB37 H015	256	157	23	41.5	64.0
LBB37 H006	256	157	23	41.5	64.0
LBB45 H006	360	185	33	60	113
LBB45 H017	360	185	33	60	113
LBB45 H004	360	185	33	60	113

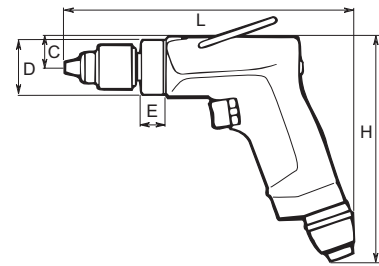

## Accessories Included

Chuck, chuck key, hose nipple.

LBB16 and -36/37 with suspension yoke and with chuck guard where possible.

LBB16 and -36/37 have a 3/8" -24 UNF spindle thread.

LBB36 H005 and LBB37 H006 have a 1/2" -20 UNF thread.

LBB45 has a JT3 taper mount.

## Optional Accessories

### KEY CHUCKS

Mount	Body diameter mm	Chuck capacity mm	Ordering No.		
			Chuck (key incl)	Key only	Key designation
3/8-24UNF	30	0.0- 6.5	4021 0283 00	4021 0293 00	S1
3/8-24UNF	30	0.5- 8.0	4021 0495 00	4021 0293 00	S1
3/8-24UNF	36	2.0-10.0	4021 0416 01	4021 0449 00	S8
JT3	59	3.0-16.0	4021 0423 00	4021 0301 00	S3



Key chuck

## Optional Accessories

### QUICK CHUCKS

Mount	Chuck dia mm	Chuck capacity mm	Ordering No.
3/8-24UNF	34	0.0- 6.5	4021 0400 00
3/8-24UNF	34	0.0- 8.0	4021 0401 00
3/8-24UNF	36	0.0-10.0	4021 0402 00
3/8-24UNF	36	2.0-13.0	4021 0403 00



Quick chuck

### COLLET CHUCK AND COLLETS

Designation	Capacity		Ordering No.	
	mm	in		
Collet	3		4150 0081 00	
	6		4150 0075 00	
	8	5/16		4150 0074 00
		1/8		4150 0082 00
		5/32		4150 0648 00
		3/16		4150 0649 00
		1/4		4150 0076 00
Collet holder			4110 0844 90	
Collet nut			4150 0760 00	



Collet chuck and collets

### CHUCK GUARDS

For model	Max chuck dia mm	Ordering No.
LBB16 <sup>a</sup>	30	4110 1619 04
LBB26	36	4110 1728 02
LBB26	30	4110 1728 03
LBB36 <sup>b</sup>	36	4110 1415 00
LBB37 <sup>b</sup>	36	4110 1415 00

<sup>a</sup> The guards do not fit 1000 r/min models, 500 r/min and 300 r/min models.

<sup>b</sup> The chuck guards do not fit the 500 r/min, 600 r/min or 700 r/min models.



Chuck guard

### FLEX CONNECT

For model	Ordering No.
LBB16	4110 1601 80



Flex connect

### SPOT SUCTION ATTACHMENT

For model	Hose size in	Spot suction kit <sup>a</sup> Ordering No.	Hose kit Ordering No.
LBB16	1 1/4	4110 1715 80	4112 1227 00
LBB26	1 1/4	4110 1715 84	4112 1227 00
LBB36/37	1 1/4	4110 1716 80	4112 1227 00

<sup>a</sup> Spare part, nose piece kit, Ordering No. 4110 1700 90.

Other standard sizes of front nozzle available.



Spot suction attachment

### POWER FEED ARM FOR EXTRA FEED FORCE – LBB36 H005 AND LBB37 H006

	Ordering No.
Adapter piece (SR295), lever arm (SR201), chain (SR202) and No. 2 Morse socket (SR206)	4110 1416 80
Two extension pieces (SR204-1 and SR204-2), 370 and 750 mm long	4110 1417 80
No. 2 Morse socket	4110 1416 01



Power feed arm



## Optional Accessories

### SUPPORT HANDLES

For model	Ordering No.
LBB16	4110 1355 92
LBB26	4110 1355 95
LBB36/37	4110 1355 82
LBB45	4110 1355 84



Support handle

### OPTIONAL ACCESSORIES – LBB45

Designation	Ordering No.
No. 2 Morse socket	4130 1080 00

## Productivity Kits

Model	Max air flow	Hose, 5 m	Coupling	Lubrication	Ordering No.
<b>For drills with 1/4" BSP air inlet</b>					
MIDI Optimizer F/RD EQ08-C08	9 l/s	Cablair 8 mm	ErgoQIC 08	Yes	8202 0850 00
MIDI Optimizer F/R EQ08-C08	9 l/s	Cablair 8 mm	ErgoQIC 08	No	8202 0850 01
<b>For drills with 3/8" BSP air inlet</b>					
MIDI Optimizer F/RD EQ08-C10	16 l/s	Cablair 10 mm	ErgoQIC 08	Yes	8202 0850 07
<b>For drills with 3/8" BSP air inlet</b>					
MIDI Optimizer F/RD EQ10-C13	23 l/s	Cablair 13 mm	ErgoQIC 10	Yes	8202 0850 02
<b>For drills with 1/4" BSP air inlet</b>					
MIDI Optimizer F/RD EQ10-C13-1/4	23 l/s	Cablair 13 mm	ErgoQIC 10	Yes	8202 0850 11



## Service Kits

LBB16	4081 0271 90
LBB26	4081 2028 90
LGB/LBV34	4081 0035 90
LBB36/37	4081 0194 90
LBB45	4081 0139 90

Atlas Copco straight drills are primarily intended for vertical drilling operations and for drilling in cramped spaces.

- Quiet – Very low noise level.
- Very high power to weight ratio.
- Adjustable exhaust –The exhaust air is directed away from the operator.
- Lubrication-free – LBB16 drills are lubrication-free for clean working environment and operator comfort.



LBB16

Model	Free speed <sup>a</sup> r/min	Chuck capacity mm	Weight		Air consumption at free speed		Hose size		Air inlet thread BSP	Power		With chuck Ordering No.	Without chuck	
			kg	lb	l/s	cfm	mm	in		W	hp		Model	Ordering No.
<b>Drills with rear exhaust</b>														
LBB16 S260	26000	6.5	0.55	1.1	8.0	17	6.3	1/4	1/4	350	0.47	8421 0210 00	S260-U	8421 0210 10
LBB16 S064	6400	6.5	0.55	1.1	8.0	17	6.3	1/4	1/4	350	0.47	8421 0210 01	S064-U	8421 0210 11
LBB16 S045	4500	6.5	0.55	1.1	8.0	17	6.3	1/4	1/4	350	0.47	8421 0210 02	S045-U	8421 0210 12
LBB16 S038	3800	6.5	0.55	1.1	8.0	17	6.3	1/4	1/4	350	0.47	8421 0210 03	S038-U	8421 0210 13
LBB16 S029	2900	8	0.60	1.2	8.0	17	6.3	1/4	1/4	350	0.47	8421 0210 04	S029-U	8421 0210 14
LBB16 S022	2200	10	0.70	1.5	8.0	17	6.3	1/4	1/4	350	0.47	8421 0210 05	S022-U	8421 0210 15
LBB16 S012	1200	10	0.70	1.5	8.0	17	6.3	1/4	1/4	350	0.47	8421 0210 06	S012-U	8421 0210 16

<sup>a</sup> The free speed can be reduced to 50% of the maximum speed using the trim valve.

## Dimensions

Model	L	H	A
LBB16 S260	196	39	146
LBB16 S064	196	39	146
LBB16 S045	196	39	146
LBB16 S038	196	39	146
LBB16 S029	196	39	146
LBB16 S022	219	39	159
LBB16 S012	219	39	159

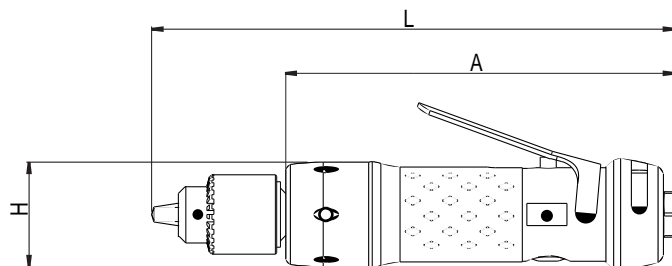

## Accessories Included

Chuck, chuck key  
Suspension yoke and chuck guard

## Optional Accessories

### KEY CHUCKS

Mount	Body diameter mm	Chuck capacity mm	Ordering No.		
			Chuck (key incl)	Key only	Key designation
3/8-24UNF	30	0.0- 6.5	4021 0283 00	4021 0293 00	S1
3/8-24UNF	30	0.5- 8.0	4021 0495 00	4021 0293 00	S1
3/8-24UNF	36	2.0-10.0	4021 0416 01	4021 0449 00	S8
JT3	59	3.0-16.0	4021 0423 00	4021 0301 00	S3



Key chuck

### QUICK CHUCKS

Mount	Chuck dia mm	Chuck capacity mm	Ordering No.
3/8-24UNF	34	0.0- 6.5	4021 0400 00
3/8-24UNF	34	0.0- 8.0	4021 0401 00
3/8-24UNF	36	0.0-10.0	4021 0402 00
3/8-24UNF	36	2.0-13.0	4021 0403 00



Quick chuck

### COLLET CHUCK AND COLLETS

Designation	Capacity		Ordering No.
	mm	in	
Collet	3		4150 0081 00
	6		4150 0075 00
	8	5/16	4150 0074 00
		1/8	4150 0082 00
		5/32	4150 0648 00
		3/16	4150 0649 00
		1/4	4150 0076 00
	Collet holder		
Collet nut			4150 0760 00



Collet chuck and collets

### SAFETY LEVER

For model	Ordering No.
LBB16S	4110 1787 90



Safety lever



## Service Kits

LBB16 4081 0438 90

- Quiet – Very low noise level.
- Low air consumption – Good operating economy.
- Side exhaust – The air can be directed to suit the operator.
- Rear exhaust – The air is piped away through a pliant hose.
- Lubrication-free – For clean working environment and operator comfort.
- Collet chuck or threaded spindle.
- Multiple lever options.

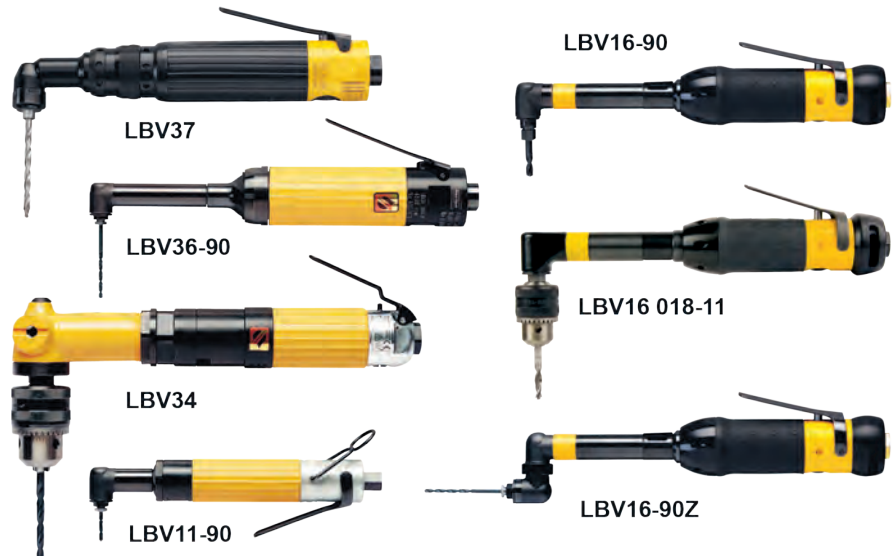

Model	Free speed r/min	Setting range rpm	Collet or chuck capacity mm	Weight		Air consumption at free speed		Hose dimension mm	Air inlet thread		Power		Ordering No.
				kg	lb	l/s	cfm		in	BSP	W	hp	
<b>30° angle head</b>													
LBV11 S029-S30	2900	–	5	0.5	1.1	4.0	8.5	5.0	1/8	1/8	110	0.16	8421 0108 70
LBV16 032-30	3200	1500-3200	5	0.5	1.1	8.7	18.4	6.3	1/4	1/4	300	0.4	8421 0110 05
LBV16 032-S30	3200	1500-3200	5	0.45	1.0	8.7	18.4	6.3	1/4	1/4	300	0.4	8421 0110 04
LBV16 032-32	3200	1500-3200	c	0.5	1.1	8.7	18.4	6.3	1/4	1/4	300	0.4	8421 0110 07
LBV16 032-S32	3200	1500-3200	c	0.45	1.0	8.7	18.4	6.3	1/4	1/4	300	0.4	8421 0110 06
LBV16 045-30	4500	3200-4500	5	0.5	1.1	8.7	18.4	6.3	1/4	1/4	300	0.4	8421 0110 71
LBV36 S030-30 <sup>d</sup>	3000	–	5	1.0	2.2	17.0	36.0	10.0	3/8	1/4	510	0.73	8421 0414 70
<b>45° angle head</b>													
LBV16 032-45	3200	1500-3200	5	0.5	1.1	8.7	18.4	6.3	1/4	1/4	300	0.4	8421 0110 59
LBV16 032-46	3200	1500-3200	c	0.5	1.1	8.7	18.4	6.3	1/4	1/4	300	0.4	8421 0110 60
<b>90° angle head</b>													
LBV11 S029-S90	2900	–	5	0.5	1.1	4.0	8.5	5.0	1/8	1/8	110	0.16	8421 0109 79
LBV16 032-90	3200	1500-3200	5	0.5	1.1	8.7	18.4	6.3	1/4	1/4	300	0.4	8421 0110 00
LBV16 032-S90	3200	1500-3200	5	0.45	1.0	8.7	18.4	6.3	1/4	1/4	300	0.4	8421 0110 01
LBV16 032-92	3200	1500-3200	c	0.5	1.1	8.7	18.4	6.3	1/4	1/4	300	0.4	8421 0110 03
LBV16 032-S92	3200	1500-3200	c	0.45	1.0	8.7	18.4	6.3	1/4	1/4	300	0.4	8421 0110 02
LBV16 045-90	4500	3200-4500	5	0.5	1.1	8.7	18.4	6.3	1/4	1/4	300	0.4	8421 0110 20
LBV16 045-92	4500	3200-4500	c	0.5	1.1	8.7	18.4	6.3	1/4	1/4	300	0.4	8421 0110 21
LBV16 055-90	5500	4500-5500	5	0.5	1.1	8.7	18.4	6.3	1/4	1/4	300	0.4	8421 0110 23
LBV16 055-S92	5500	4500-5500	c	0.45	1.0	8.7	18.4	6.3	1/4	1/4	300	0.4	8421 0110 58
LBV36 S030-90 <sup>d</sup>	3000	–	5	1.0	2.2	17.0	36.0	10.0	3/8	1/4	510	0.73	8421 0414 60
LBV36 S030-92 <sup>d</sup>	3000	–	c	1.0	2.2	17.0	36.0	10.0	3/8	1/4	510	0.73	8421 0414 64
LBV36 S045-90 <sup>d</sup>	4500	–	5	1.0	2.2	17.0	36.0	10.0	3/8	1/4	510	0.73	8421 0414 62
<b>360° angle head</b>													
LBV16 032-90Z	3200	1500-3200	5	0.5	1.1	8.7	18.4	6.3	1/4	1/4	300	0.4	8421 0110 64
LBV16 032-92Z	3200	1500-3200	c	0.5	1.1	8.7	18.4	6.3	1/4	1/4	300	0.4	8421 0110 68
<b>90° angle head – large angle head</b>													
LBV16 005-91	500	200-500	6.6	0.6	1.2	8.7	18.4	6.3	1/4	1/4	300	0.4	8421 0110 11
LBV16 005-93	500	200-500	c	0.6	1.2	8.7	18.4	6.3	1/4	1/4	300	0.4	8421 0110 12
LBV16 010-91	1000	500-1000	6.6	0.6	1.2	8.7	18.4	6.3	1/4	1/4	300	0.4	8421 0110 16
LBV16 010-93	1000	500-1000	c	0.6	1.2	8.7	18.4	6.3	1/4	1/4	300	0.4	8421 0110 17
LBV16 018-91	1800	800-1800	6.6	0.55	1.2	8.7	18.4	6.3	1/4	1/4	300	0.4	8421 0110 18
LBV16 018-93	1800	800-1800	c	0.55	1.2	8.7	18.4	6.3	1/4	1/4	300	0.4	8421 0110 19
LBV16 032-91	3200	1500-3200	6.6	0.55	1.2	8.7	18.4	6.3	1/4	1/4	300	0.4	8421 0110 09
LBV16 032-93	3200	1500-3200	c	0.55	1.2	8.7	18.4	6.3	1/4	1/4	300	0.4	8421 0110 10
LBV16 032-S93	3200	1500-3200	c	0.45	1.2	8.7	18.4	6.3	1/4	1/4	300	0.4	8421 0110 39
LBV16 045-91	4500	3200-4500	6.6	0.55	1.2	8.7	18.4	6.3	1/4	1/4	300	0.4	8421 0110 38
LBV36 S030-91 <sup>d</sup>	3000	–	6.6	1.0	2.2	17.0	36.0	10.0	3/8	1/4	510	0.73	8421 0414 50
LBV36 S060-91 <sup>d</sup>	6000	–	6.6	1.0	2.2	17.0	36.0	10.0	3/8	1/4	510	0.73	8421 0414 51
LBV36 S030-93 <sup>d</sup>	3000	–	c	1.0	2.2	17.0	36.0	10.0	3/8	1/4	510	0.73	8421 0414 52
LBV36 S060-93 <sup>d</sup>	6000	–	c	1.0	2.2	17.0	36.0	10.0	3/8	1/4	510	0.73	8421 0414 53
<b>90° angle head – Key chuck models</b>													
LBV16 018-11	1800	800-1800	8 <sup>a</sup>	0.8	1.7	8.7	18.4	6.3	1/4	1/4	300	0.4	8421 0110 22
LBV34 S005 <sup>b</sup>	500	–	13 <sup>a</sup>	2.1	4.6	11.0	23.3	10.0	3/8	1/4	400	0.6	8421 0309 04
LBV34 S010 <sup>b</sup>	1000	–	10 <sup>a</sup>	2.0	4.4	11.0	23.3	10.0	3/8	1/4	400	0.6	8421 0309 12
LBV34 S040 <sup>b</sup>	4000	–	6.5 <sup>a</sup>	1.5	3.3	11.0	23.3	10.0	3/8	1/4	400	0.6	8421 0309 46
<b>90° angle head – heavy-duty</b>													
LBV37 030	3000	–	c	1.1	2.4	22	46	10.0	3/8	3/8	820	1.1	8421 0414 54

<sup>a</sup> Spindle thread, male 3/8"-24 UNF. <sup>b</sup> Side exhaust. <sup>c</sup> Internal thread 1/4"-28. <sup>d</sup> Short lever as standard.

## Dimensions

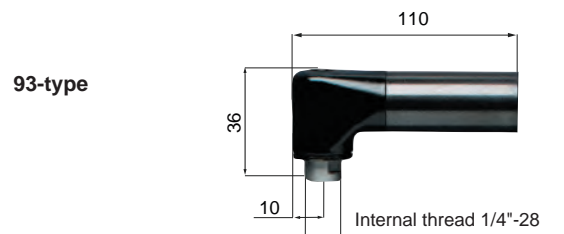
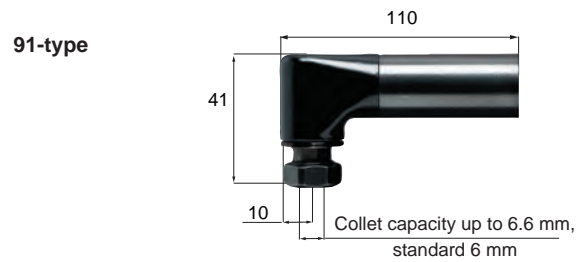
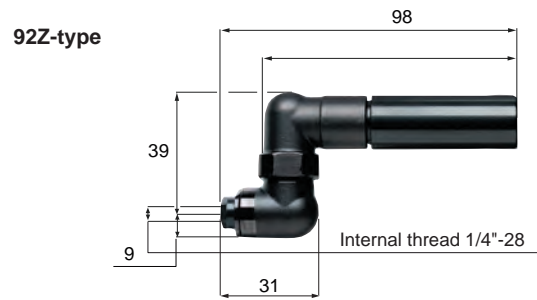
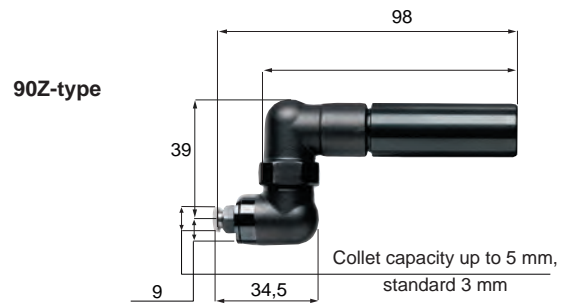
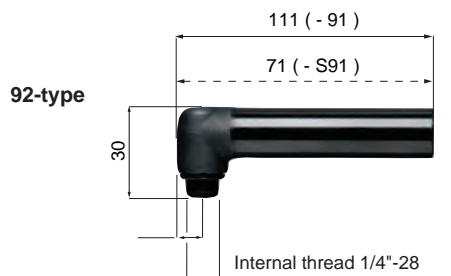
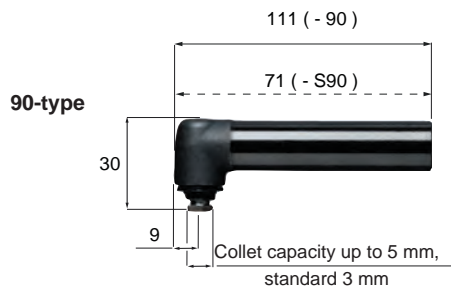
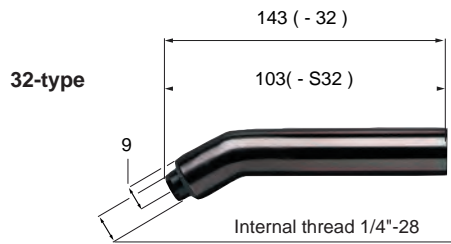
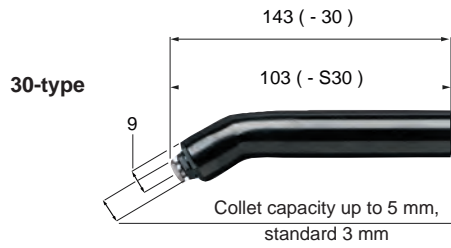



## Dimensions

### DRILLING CAPACITY

Model	Angle head mm				
	A	B	C	L	H
LBV11 S027-S30	59	25	18	224	30
LBV11 S025-S90	44	30	18	204	30
LBV16 032-S30	103	25	17	241	42
LBV16 032-30	143	25	17	281	42
LBV16 032-S32	103	25	17	241	42
LBV16 032-32	143	25	17	281	42
LBV16 032-90	111	30	17	248	42
LBV16 032-S90	71	30	17	209	42
LBV16 032-S92	71	30	17	209	42
LBV16 032-92	111	30	17	249	42
LBV16 032-90Z	145	48	17	283	42
LBV16 032-91	110	39	20	248	42
LBV16 032-93	110	36	20	248	42
LBV16 005-91	110	39	20	248	42
LBV16 005-93	110	36	20	248	42
LBV16 010-91	110	39	20	248	42
LBV16 010-93	110	36	20	248	42
LBV16 018-91	110	39	20	248	42
LBV16 018-93	110	36	20	248	42
LBV34 S040	92	97	20	255	43
LBV34 S010	92	114	20	290	43
LBV34 S005	92	120	20	290	43
LBV36 S030-91	92	41	20	252	43
LBV36 S060-91	92	41	20	252	43
LBV36 S030-93	92	36	20	252	43
LBV36 S060-93	92	36	20	252	43
LBV36 S030-30	122	26	18	281	43
LBV36 S045-30	122	26	18	281	43
LBV36 S030-90	112	30	18	272	43
LBV36 S045-90	112	30	18	272	43
LBV36 S030-92	112	30	18	272	43
LBV37 030	55	39	23	262	43
LBV37 HD030	55	39	23	262	43

LBV11, -16, -36  
30°

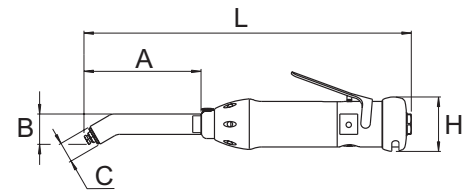

LBV11, -16, -36  
90°

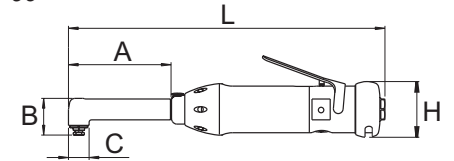

LBV16, -25  
360°

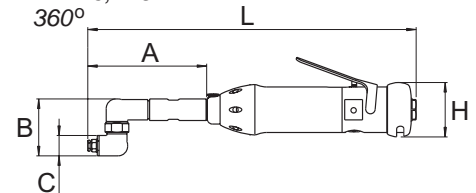

LBV34  
90°

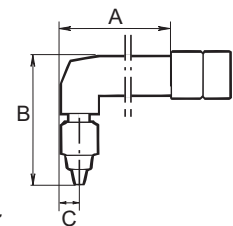

LBV37  
90°

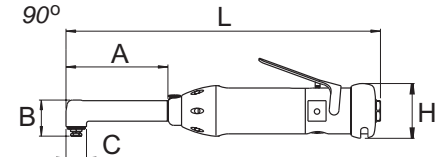

## Accessories Included

### KEY WRENCHES

Collet or chuck with key  
3 mm collet (5.0 collet capacity head)  
6 mm collet (6.6 collet capacity head)

## Optional Accessories

### SAFETY LEVERS

For model	Ordering No.
LBV16	4110 1787 90
LBV34 S010	4150 1035 90
LBV36/37	4150 1594 97



Safety lever



The LBD16M and LBP16M are designed with the operator in focus. A lightweight tool with a powerful air motor combined with interchangeable angle heads equals excellent flexibility in any handheld drilling operation. Swap to a new head in a matter of seconds with the easy-to-use quick change mechanism. With the LBD16M and LBP16M, you are always ready to take on any job in ever changing drilling applications.

- Quick change system – Easy-to-use and robust quick change design for high durability.
- Indexable head – The head can be positioned in any direction for maximum accessibility.
- High power lubrication free motor – No more oil aerosols, for a safer and cleaner working environment.



Model	Free speed <sup>a</sup> rpm	Motor speed <sup>b</sup>	Weight		Air consumption		Hose size		Air inlet thread BSP	Power		Ordering No.
			kg	lb	l/s	cfm	mm	in		W	hp	
<b>Straight motor units</b>												
LBD16M-005	500	600	0.57	1.25	8.7	18.4	6.3	1/4	1/4	300	0.4	8421 0122 05
LBD16M-010	1000	1200	0.57	1.25	8.7	18.4	6.3	1/4	1/4	300	0.4	8421 0122 10
LBD16M-018	1800	2100	0.57	1.25	8.7	18.4	6.3	1/4	1/4	300	0.4	8421 0122 18
LBD16M-032	3200	3600	0.45	1	8.7	18.4	6.3	1/4	1/4	300	0.4	8421 0122 32
LBD16M-045	4500	5100	0.45	1	8.7	18.4	6.3	1/4	1/4	300	0.4	8421 0122 45
LBD16M-055	5500	6200	0.45	1	8.7	18.4	6.3	1/4	1/4	300	0.4	8421 0122 55
<b>Pistol motor units</b>												
LBP16M-005	500	600	0.55	1.2	9.5	20.0	6.3	1/4	1/4	340	0.45	8421 0124 05
LBP16M-010	1000	1100	0.55	1.2	9.5	20.0	6.3	1/4	1/4	340	0.45	8421 0124 10
LBP16M-018	1800	2100	0.55	1.2	9.5	20.0	6.3	1/4	1/4	340	0.45	8421 0124 18
LBP16M-033	3300	3700	0.5	1.1	9.5	20.0	6.3	1/4	1/4	340	0.45	8421 0124 33
LBP16M-045	4500	5100	0.5	1.1	9.5	20.0	6.3	1/4	1/4	340	0.45	8421 0124 45
LBP16M-060	6000	6800	0.5	1.1	9.5	20.0	6.3	1/4	1/4	340	0.45	8421 0124 60

<sup>a</sup> The free speed is given when used with a 90° angle head. <sup>b</sup> Multiply this value with the Speed ratio to get the free speed of each angle head.

## ANGLE HEADS

Model	Angle head	Weight		Collet capacity	Thread in	Speed ratio	Length		Ordering No.
		kg	lb				mm	in	
<b>Angle heads with collet – Short</b>									
BHM90SC-5-0	90°	0.2	0.5	5.0	–	14:16	65.5	2.58	8421 0123 02
<b>Angle heads with collet – Standard</b>									
BHM90C-5-0	90°	0.17	0.36	5.0	–	14:16	88.5	3.48	8421 0123 00
BHM90C-6-6	90°	0.24	0.55	6.6	–	1:1	89.6	3.53	8421 0123 05
BHM90C-8-0	90°	0.24	0.55	8.0	–	1:1	89.7	3.54	8421 0123 80
BHM45C-5-0	45°	0.20	0.44	5.0	–	14:15	117.3	4.62	8421 0123 10
BHM30C-5-0	30°	0.20	0.44	5.0	–	14:15	120.4	4.74	8421 0123 20
BHM30C-6-6	30°	0.20	0.44	6.6	–	14:15	127	5	8421 0123 15
BHM90ZC-5-0	360°	0.21	0.47	5.0	–	7:9	100.8	3.97	8421 0123 30
BHM90ZC-6-6	360°	0.21	0.47	6.6	–	7:9	108	4.25	8421 0123 40
<b>Angle heads with collet – Extended</b>									
BHM90EC-5-0	90°	0.26	0.58	5.0	–	14:16	128.5	5.06	8421 0123 08
BHM45EC-5-0	45°	0.29	0.64	5.0	–	14:15	157.3	6.19	8421 0123 18
BHM30EC-5-0	30°	0.29	0.64	5.0	–	14:15	160.4	6.31	8421 0123 28
BHM90EZC-5-0	360°	0.30	0.67	5.0	–	7:9	140.8	5.54	8421 0123 38
<b>Angle head with internal thread – Standard</b>									
BHM90T-1-4	90°	0.17	0.36	–	1/4"-28	14:16	88.5	3.48	8421 0123 01
BHM90LT-1-4	90°	0.23	0.52	–	1/4"-28	14:16	89.6	3.53	8421 0123 06
BHM45T-1-4	45°	0.20	0.44	–	1/4"-28	14:15	118.2	4.65	8421 0123 11
BHM30T-1-4	30°	0.20	0.44	–	1/4"-28	14:15	121.1	4.77	8421 0123 21
BHM90ZT-1-4	360°	0.21	0.47	–	1/4"-28	7:9	101	3.98	8421 0123 31
<b>Angle head with internal thread – Extended</b>									
BHM90ET-1-4	90°	0.26	0.58	–	1/4"-28	14:16	128.5	5.06	8421 0123 09
BHM90EZT-1-4	360°	0.30	0.67	–	1/4"-28	7:9	141	5.55	8421 0123 39
<b>Straight short head</b>									
BHM0C-5-0	0°	0.14	0.31	5.0	–	1:1	78	3.07	8421 0123 43
BHM0T-1-4	0°	0.14	0.31	–	1/4"-28	1:1	78	3.07	8421 0123 44

Angle heads Standard/Extended (pictures shows extended versions)



## Dimensions

### ANGLE HEAD DIMENSIONS

Model	A mm	B mm	C mm	L mm	H mm	Ordering No.
<b>90° heads</b>						
BHM90SC-5-0	65.5	29.8	17	106.2	19.8	8421 0123 02
BHM90C-5-0	88.5	29.8	17	129.2	19.8	8421 0123 00
BHM90C-6-6	90	39.3	20	130.3	20	8421 0123 05
BHM90C-8-0	90	41.1	20	130.3	20	8421 0123 80
BHM90EC-5-0	128.5	29.8	17	169.2	19.8	8421 0123 08
BHM90T-1-4	88.5	30	17	129.2	19.8	8421 0123 01
BHM90LT-1-4	90	36	20	130.3	20	8421 0123 06
BHM90ET-1-4	128.5	30	14	169.2	19.8	8421 0123 09
<b>30° heads</b>						
BHM30C-5-0	120.4	25	17	161	19.8	8421 0123 20
BHM30C-6-6	127.3	32.3	17	168	19.8	8421 0123 15
BHM30EC-5-0	160.4	25.2	17	201	19.8	8421 0123 28
BHM30T-1-4	121.1	26.4	17	161.6	19.8	8421 0123 21
<b>45° heads</b>						
BHM45C-5-0	117.3	30.5	17	158	19.8	8421 0123 10
BHM45EC-5-0	157.3	30.5	17	198	19.8	8421 0123 18
BHM45T-1-4	118.2	31.4	17	159	19.8	8421 0123 11
<b>360° heads</b>						
BHM90ZC-5-0	100.8	45.9	17	141.5	19.8	8421 0123 30
BHM90ZC-6-6	107.3	45.9	17	148	19.8	8421 0123 40
BHM90EZC-5-0	140.8	45.9	17	181.5	19.8	8421 0123 38
BHM90ZT-1-4	101	45.9	17	141.5	19.8	8421 0123 31
BHM90EZT-1-4	141	45.9	17	181.5	19.8	8421 0123 39
BHM90XZC-5-0	140.8	—	17	181.5	19.8	8421 0123 33
<b>Straight heads</b>						
BHM0C-5-0	78	—	17	119	19.8	8421 0123 43
BHM0C-6-6	81	20	20	122	17	8421 0123 46
BHM0C-8-0	81	20	20	122	17	8421 0123 47
BHM0T-1-4	78	—	17	119	19.8	8421 0123 44
<b>Extension - for chuck</b>						
EXTENSION	35	—	17.5	76	28.5	4110 1692 90

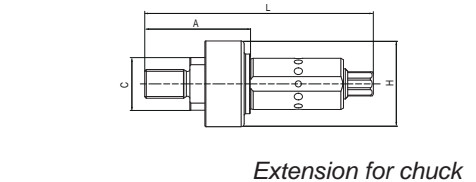
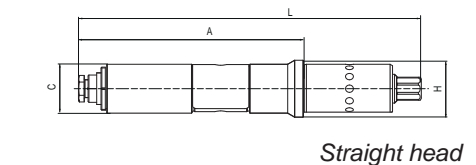
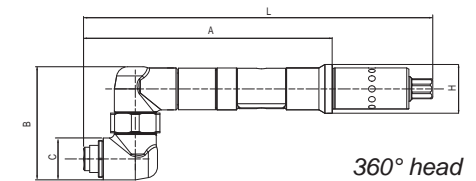
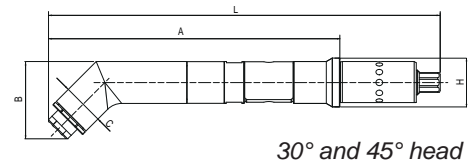
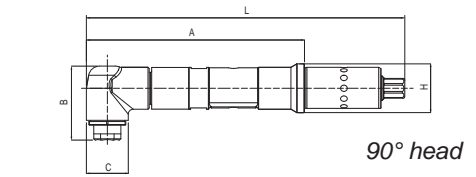

## Optional Accessories



### STRAIGHT DRILL HEAD FOR CHUCK

For model	Ordering No.
LBD16M, LBP16M	4110 1692 90

### SAFETY LEVERS

For model	Ordering No.
LBD16M	4110 1787 90



### SHORT LEVERS

For model	Ordering No.
LBD16M	4210 2306 04

### COLLETS FOR 5.0 MM CAPACITY ANGLE HEAD BHMC-5-0 (-30, -45, -90, -90Z)

Capacity mm	Ordering No.	Capacity mm	Ordering No.	Capacity in/mm	Ordering No.
1.0	4110 0438 01	3.4	4110 0438 33	1/16	4110 0438 19
1.5	4110 0438 02	3.5	4110 0438 13	3/32	4110 0438 20
1.8	4110 0438 28	3.6	4110 0438 24	1/8	4110 0438 21
2.0	4110 0438 03	3.7	4110 0438 34	5/32	4110 0438 22
2.1	4110 0438 29	3.8	4110 0438 14	3/16	4110 0438 23
2.2	4110 0438 04	3.9	4110 0438 35	<b>Multipack x 50</b>	
2.3	4110 0438 30	4.0	4110 0438 15	2.5	4110 0500 25
2.4	4110 0438 05	4.1	4110 0438 25	2.6	4110 0500 26
2.5	4110 0438 06	4.2	4110 0438 26	3.3	4110 0500 33
2.6	4110 0438 07	4.3	4110 0438 36	4.1	4110 0500 41
2.7	4110 0438 31	4.4	4110 0438 37	4.9	4110 0500 49
2.8	4110 0438 32	4.5	4110 0438 16		
2.9	4110 0438 08	4.6	4110 0438 38		
3.0	4110 0438 09	4.7	4110 0438 39		
3.1	4110 0438 10	4.8	4110 0438 18		
3.2	4110 0438 11	4.9	4110 0438 40		
3.3	4110 0438 12	5.0	4110 0438 27		

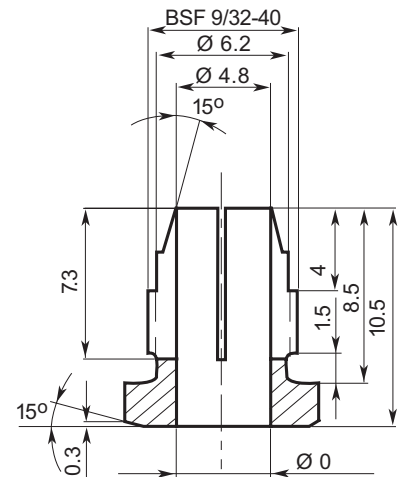

Collets for 5.0 mm (Thread BSF 9/32 -40)

### COLLETS FOR 6.6 MM CAPACITY ANGLE HEAD BHMC-6-6 (-30, -90, -90Z)

Capacity mm	Ordering No.	Capacity mm	Ordering No.
1.6	4110 1411 01	5.0	4110 1411 18
1.8	4110 1411 02	5.2	4110 1411 19
2.0	4110 1411 03	5.4	4110 1411 20
2.2	4110 1411 04	5.6	4110 1411 21
2.4	4110 1411 05	5.8	4110 1411 22
2.6	4110 1411 06	6.0	4110 1411 23
2.8	4110 1411 07	6.2	4110 1411 24
3.0	4110 1411 08	6.4	4110 1411 25
3.2	4110 1411 09	6.6	4110 1411 26
3.4	4110 1411 10	<b>Multipack x 50</b>	
3.6	4110 1411 11	4.8	4110 0500 48
3.8	4110 1411 12	5.6	4110 0500 56
4.0	4110 1411 13	6.0	4110 0500 60
4.2	4110 1411 14	6.4	4110 0500 64
4.6	4110 1411 16		
4.8	4110 1411 17		

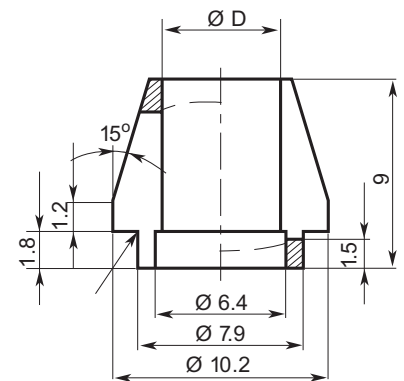

Collets for 6.6 mm

Collet nut 4110 1410 00, to be ordered separately.

### COLLETS FOR 8.0 MM CAPACITY ANGLE HEAD BHMC-8-0 (-90)

Capacity mm	Ordering No.	Capacity mm	Ordering No.
6.8	4110 1812 01	7.6	4110 1812 05
7.0	4110 1812 02	7.8	4110 1812 06
7.2	4110 1812 03	8.0	4110 1812 07
7.4	4110 1812 04		

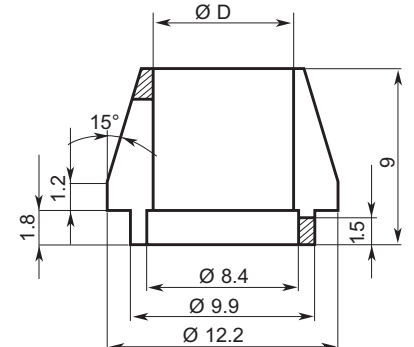

Collets for 8.0 mm



## Service Kits

LBD16M 4081 0322 90

LBP16M 4081 0271 90



The Atlas Copco LBS36 drill is equipped with an integrated micro stop. It is designed for the aerospace industry where the focus is on high-precision drilling, reaming and countersinking.

- **Accurate** – The integrated micro stop function makes the LBS36 unique for high-precision drilling of rivet holes and other fasteners. Minimized spindle run-out is achieved by eliminating standard drill chuck.
- **Ergonomic handle design** – The integrated micro stop function makes the tool shorter and lighter in weight.
- **Flexible** – Can be used for drilling, reaming, countersinking and, in certain applications, a combined operation using a form bit.
- **Dust extraction** – Equipped with a specially designed spot suction system for working in composite materials.
- **Lubrication-free** – For clean working environment and operator comfort.



Model	Free speed r/min	Spindle thread in/mm	Stroke		Setting range ±		Weight		Hose size		Air consumption		Air inlet thread BSP	Ordering No.
			mm	in	mm	in	kg	lb	mm	in	l/s	cfm		
LBS26 H033-40	3300	1/4"-28	40	1.6	6	1/4	0.9	2.0	10	3/8	14.5	31.8	3/8	8421 0220 40
LBS26 H013-40	1300	1/4"-28	40	1.6	6	1/4	1.2	2.6	10	3/8	14.5	31.8	3/8	8421 0220 45
LBS36 H033-40	3300	1/4"-28	40	1.6	6	1/4	1.2	2.6	10	3/8	16.5	34.9	3/8	8421 0220 80
LBS36 H013-40	1300	1/4"-28	40	1.6	6	1/4	1.5	3.3	10	3/8	16.5	34.9	3/8	8421 0220 90

## Dimensions

Model	L mm	H mm	C mm
LBS26 H033-40	253	146	21
LBS26 H013-40	285	146	21
LBS36 H033-40	281	157	21
LBS36 H013-40	314	157	21

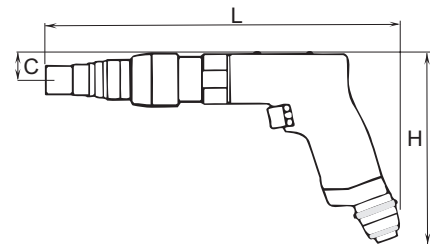

## Accessories Included

Hose nipple  
2x2 mm Allen wrenches

## Optional Accessories

Designation		Attachment	Ordering No.
Plain base, dia 24 mm	Fig 1	M 20x1	4110 1521 00
Plain base for nylon ring (attached with thread M35x1)	Fig 2	M 20x1	4110 1522 00
Separate nylon ring for above base, outer dia 40 mm, thread M35x1	Fig 3	M 20x1	4110 1523 00
Plain base, dia 14.5 mm	Fig 4	M 20x1	4110 1520 00

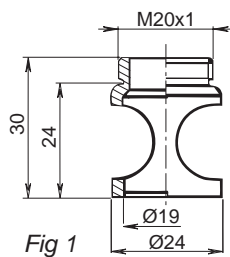

Fig 1

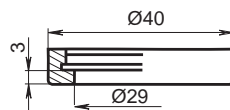

Fig 3

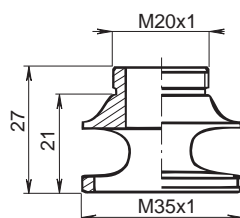

Fig 2

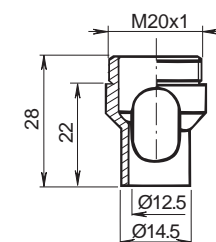

Fig 4



## Service Kits

LBS26 4081 0507 90  
LBS36 4081 0005 90

Atlas Copco tappers are designed for tapping and thread-cleaning operations with thread taps. The tools are fitted with a tap chuck as standard.

- Comfortable and effective – The ergonomically designed handle gives a comfortable grip and maximum performance.
- Higher productivity – Double speed when you withdraw the machine.
- Low noise level – Rear-directed exhaust gives a lower noise level.
- Lubrication-free – For a clean working environment and operator comfort.
- Quick change system – Upgrade your old tool, or order a new one with this system. Various tap holders can be used to change a broken tap or to change to a different tap size.
- Lower cost – The efficient air motor, together with interchangeable components from our standard drills, cut your costs.



Model	Free speed		Tapping capacity mm	Weight		Hose dimension		Air inlet thread BSP	Air consumption		With chuck Ordering No.	
	Forward r/min	Reverse r/min		kg	lb	mm	in		l/s	cfm		
<b>Pistol-grip tappers with air supply through handle</b>												
LGB34 H007	700	1400	10	1.8	4.0	10.0	3/8	1/4	7.5	15.9	8421 0311 66	
LGB34 H007Q <sup>a</sup>	700	1400	10	1.8	4.0	10.0	3/8	1/4	7.5	15.9	8421 0311 76	
LGB36 H007Q <sup>a</sup>	700	1400	12	2.0	4.4	10.0	3/8	3/8	16.5	34.9	8421 0411 00	
<b>Straight tappers</b>												
LGB34 S007	700	1400	10	1.8	4.0	10.0	3/8	1/4	7.5	15.9	8421 0311 72	

<sup>a</sup> Quick change system.

Taper: Jacob 1

## Dimensions

Model	L mm	H mm	C mm
LGB34 H007	300	156	20
LGB34 S007	293	43	21
LGB36 H007	335	157	20

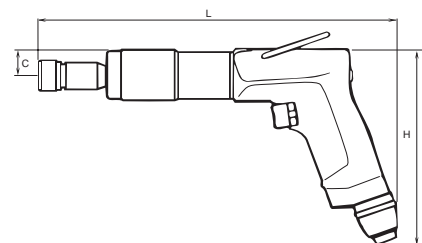

## Accessories Included

### Non Quick change system

LGB34 Chuck complete with collet 6.4-10 mm 4021 0469 00

### Quick change system

Chuck plus one tap holder with collet for M6 shank Ø 6.3 mm.

## Optional Accessories

### COLLETS FOR NON QUICK CHANGE SYSTEM

Model	Capacity		Ordering No.
	mm	inch	
LGB34	3.5 - 6.5	0.139 - 0.257	4021 0337 00
	4.5 - 8.1	0.176 - 0.320	4021 0336 00
	6.4 - 9.7	0.253 - 0.383	4021 0456 00

### COLLETS FOR QUICK CHANGE SYSTEM

Collets for tap size mm	Shank dia		Ordering No.
	mm	in	
M2.2/M2.5	2.8		4021 0414 01
M3	3.15	1/8	4021 0414 02
M3.5	3.5		4021 0414 03
M4	4.0		4021 0414 04
M4.5	4.5		4021 0414 05
M5	5.0	3/16	4021 0414 06
M5.5	5.6	7/32	4021 0414 07
M6	6.4	1/4	4021 0414 08
M6 (DIN)	6.0		4021 0414 13
M7	7.1	9/32	4021 0414 09
M8/M11	8.0	5/16 & 7/16	4021 0414 10
M9/M12	9.0	1/2	4021 0414 11
M10	10.0	3/8	4021 0414 12

### COMPLETING EXISTING EQUIPMENT WITH QUICK CHANGE SYSTEM

Accessories	Length mm	Ordering No.
Quick change chuck	47	4021 0406 90
Tap holder	58	4021 0408 00



## Service Kits

LGB34 4081 0035 90  
LGB36 4081 0194 90

# Robust and versatile, the PFD-drills are your best choice for holemaking

### **PRODUCTIVITY**

With this platform you have all you need for hole preparation. Reduce cycle time and increase output with a powerful turbine motor. This robust tool is well suited for factory environment and the long service intervals maximizes uptime of your investments.

### **HOLE QUALITY**

Keep your workplace clean with Atlas Copco's ChipLet® feature which makes chips easy to evacuate. With ChipLet® during countersinking, you have a one-step process. Giving process improvements in terms of both productivity and quality.

### **ERGONOMICS**

My operators will really appreciate how all the controls on the tool are grouped in one and the same place. This reduces the risk of operator errors. The tool is also very well balanced which makes it easy to move around.

### **SAFE OPERATION**

The modular design means fewer back-up tools. You can also save on service as the platform is based on standard, reusable components.

### **SUPPORT**

The modular approach means quick deliveries when needed, and makes it easy to re-work your existing products when urgent applications come up. With our technical documentation and support you will quickly put new tools to work on your assembly line.





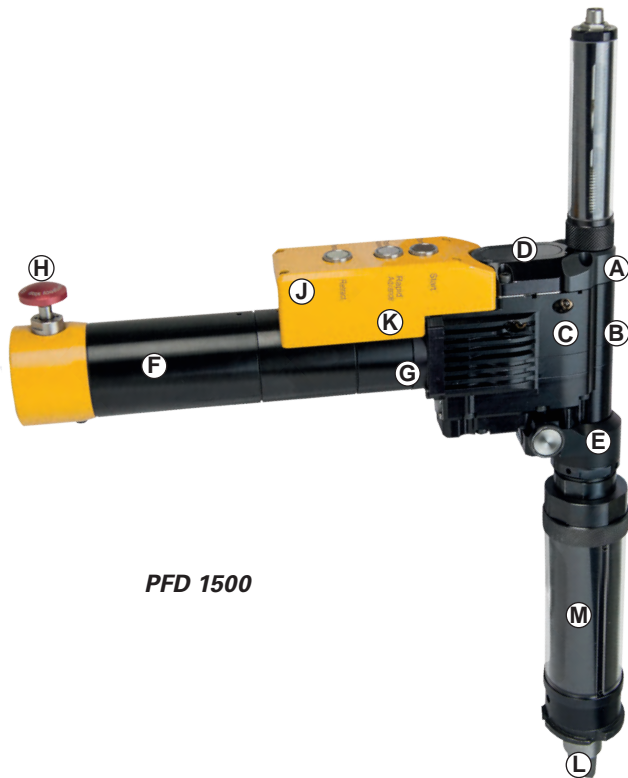

PFD 1500

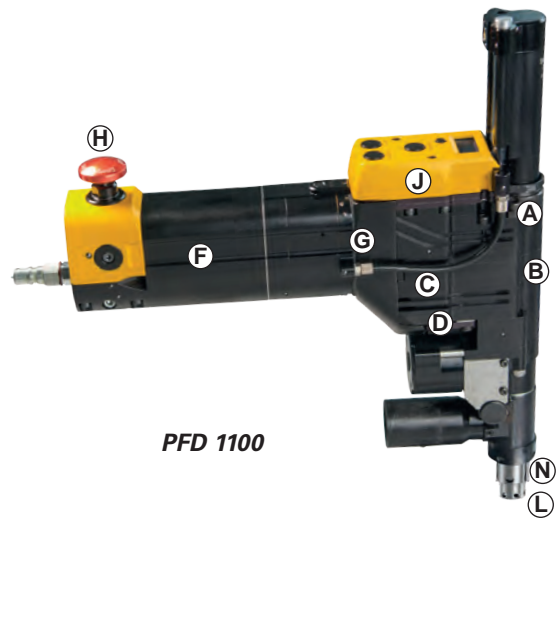

PFD 1100

PFD 1500

Item	Ordering No.
PFD1500RA-200-R	8440 1500 39
Indexer-1-9-16	4141 0306 90
PFD1500-IPR2	4141 0034 92
Spindle-1500-12-9-6	4141 0004 91
Guard-1500-12	4141 0323 91
Nose-8IN-1-1-2	4141 0245 90

**Example:** Twistlock model with rapid advance and indexer. Spindle with 9/16"-18" interface, speed of 200 rpm and feed of 0.05 mm/r (0.002 IPR). Suitable for drilling of 19 mm holes (3/4") in Ti or Ti/CFRP stacks.

PFD 1100

Item	Ordering No.
PFD1100RA-IFB110B	8440 1110 66
Spindle-CC-1100-2	4141 0742 90
Guard-1100-2in-p	4141 0826 92
Guide-CC-R-1100-M6	4141 0743 91
Bush-CC-1100-53	4141 0707 92
Foot-CC-1100-MINI	4141 0764 90
Mandrel-CC-25.4-A	4141 0806 28
Collet-CC-1	4141 0813 28

**Example:** Concentric collet model with inboard lubricator, counter and ChipLet®. Spindle with M6 interface, speed of 2600 rpm and feed of 0.07 mm/r (0.003 IPR). Suitable for drill and countersink of Ø 6.35 (1/4") holes in Al or Al/CFRP stacks.

- Ⓐ Optional ChipLet® module which effectively breaks chips while drilling for improved chip evacuation and hole quality.
- Ⓑ Angle head with superior durability with double needle bearings for both feed and drive gear.
- Ⓒ Overload clutch protects the angle head and drive train from overthrust.
- Ⓓ The replaceable feed cassette system enables quick and easy change of feed rate.
- Ⓔ Optional indexer which allows the tool to be locked in the jig also when free space is compromised.
- Ⓕ High torque, high power governed air motor maintains cutting speed while drilling.
- Ⓖ Easy-to-change split gearbox for quick adjustment of rpm.
- Ⓗ Emergency stop fully compliant with the European machinery directive for a high level of safety.
- Ⓙ Rapid advance of spindle reduces cycle time and makes setup a quick and safe task.
- Ⓚ Reliable and user-friendly tool controls with optional cycle counter.
- Ⓛ Best in class spindle power and thrust capabilities. A wide range of speeds and feeds.
- Ⓜ A large selection of tool noses with or without vacuum port makes the tool fit existing drill jigs.
- Ⓝ Concentric collet foot which allows clamp force for countersinking up to diameter 22 mm (7/8"). Debris protection and efficient vacuum exhaust of chips. Foot is modular and easily removed for drill bit change.

## Specifications

Feature	PFD1100		PFD1500	
	Metric	Imperial	Metric	Imperial
Motor	Turbine	Turbine	Vane	Vane
Drill and ream	yes	yes	yes	yes
Countersinking	yes	yes	no	no
Sound level	78 dB(A)	78 dB(A)	83 dB(A)	83 dB(A)
Spindle power	1.7 kW	2.3 hp	1.5 kW	2.0 hp
Max hole	15.9 mm	5/8"	32 mm	1 1/4"
Max countersink	22 mm	7/8"	N/A	N/A
Max speed	7300 rpm	7300 rpm	2360 rpm	2360 rpm
Min speed	350 rpm	350 rpm	38 rpm	38 rpm
Max thrust	2000 N	450 lbf	4000 N	900 lbf
Max clamp force (cc)	1800 N	400 lbf	N/A	N/A
Max feed	0.17 mm/rev	0.007 IPR	0.25 mm/rev	0.010 IPR
Tool weight (base)	3.0 kg	6.6 lb	5.5 kg	12.0 lb
Max air consumption	30 l/s	60 cfm	35 l/s	70 cfm
Air inlet	1/2" BSP	1/2" NPT	1/2" BSP	1/2" NPT
Operating pressure	5.5–7.5 bar	80–110 psi	5.5–7.5 bar	80–110 psi
Angle head radius	16.0 mm	5/8"	17.8 mm	0.7"
Air hose	13 mm	1/2"	16 mm	5/8"

Collet



Mandrel



Counter sink stop nut



## Optional Equipment

Item	PFD1100	PFD1500
Chipler®	yes	yes
Rapid advance	no	yes (with J-Clutch)
Lubrication pump	inboard, 30 ml	onboard, 55 ml
Counter	yes	yes
Indexer	yes	yes
Tool handle	no	yes
Nose sizes	21k–23k	23k–25k
Concentric collet	yes	no
Max collet outer diameter	1 3/8"	N/A

Tool nose with vacuum port



Tool nose



Tool nose indexer



Concentric collet unit

## Air Installation

Item	PFD1100 Light to Medium Duty Cycle	PFD1500 / PFD1100 Heavy Duty Cycle
Swivel	MultiFlex with 1/2	MultiFlex with 1/2
Coupling	ErgoQIC 08 with H13	ErgoQIC 10 with H16
Air fitting	ErgoNIP 08 with 1/2	ErgoNIP 10 with 1/2
Hose	PVC 13, 30 m coil	PVC 16, 30 m coil
Clamp	clamp for PVC 13	clamp for PVC 13
Air preparation unit	MIDI Optimizer F/R A with 1/2	Optimizer F/R A with 1/2
Ball valve	BAL-1A with 1/2	BAL-1A with 1/2
Connection	Double with two 1/2	Double with two 1/2

# *Air line infrastructure*



## **Contents**

Introduction.....	268	Fittings .....	299
Product safety.....	269	Hoses .....	302
Air preparation units .....	270	Spiral hoses.....	307
Optimizer air tool oil.....	275	Productivity kits.....	308
Direct lubrication units .....	276	Pre-mounted hose kits.....	309
Quick couplings .....	278	Hose reels .....	311
Claw couplings .....	296	Blow guns .....	316
Ball valves .....	297	Test equipment .....	316
Swivel connectors.....	298		



# Ensure the full potential of your pneumatic tools

*To ensure that you benefit from the full potential power of your tools, Atlas Copco has developed a full range of air line infrastructure products to be used with pneumatic tools and equipment.*

### **PRODUCTIVITY**

By using Atlas Copco's air line infrastructure products and accessories you ensure that you have a correct air line installation for your tool. This will provide the correct air flow to the tool, ensuring that you benefit from its full potential power, and that you reach the correct torque in torque-controlled tools. By using the recommended installation you will also minimize the service requirements of the tool.

### **ENERGY EFFICIENCY**

With a correct installation you will not only achieve the tool's full potential power, you will also reduce energy costs. All Atlas Copco products and accessories are designed for minimum pressure drop, which ensures that the compressor is not "working overtime".

### **SAFETY**

All products and accessories are designed to meet the highest demands for a safe working environment. Atlas Copco has developed a wide range of safety couplings and hose reels to meet today's high standards in terms of workplace safety.

### **QUALITY**

All Atlas Copco products and accessories are made of the highest quality materials for long production cycles and to withstand rough treatment. Choose Atlas Copco and you will be sure of high quality products.



All local safety regulations with respect to installation, operation and overhaul must always be followed. Please read the separate instructions regarding safety which are supplied with all products in order to improve your own safety!

## BALL VALVE

- Switch off the compressed air with the ball valve when you are not working (see fig. 1).
- Open all ball valves gently in order to discover improperly tightened devices (see fig. 5).

## AIR PREPARATION UNITS

- Please check for solvents which change the structure of polycarbonate<sup>a</sup> bowls.

These solvents make the polycarbonate brittle so it can break. Normally polycarbonate is not easy to break. If you need to use aggressive solvents, please contact us and we will help you choose the right equipment.

- Use bowl guard.

An easy way to eliminate this type of accident is to use a bowl guard on MINI and MIDI units. The MAXI unit has an aluminum bowl with a new, more chemical resistant plastic on the inside as standard.

Check that the bowls are properly tightened and that all units are fitted together before switching on the compressed air with the ball valve.

## QUICK SAFETY COUPLINGS

To increase the safety and reduce the risk of operator injuries we recommend you to always buy couplings with a safety function. Couplings with a safety function are disconnected in

two stages in order to vent the coupling and minimize the risk of sudden component separation, which has the potential to cause operator injury.

Never open a quick coupling with a screwdriver in order to ventilate the air.

## CLAW COUPLINGS

- Be very careful (see fig. 1+2+3).

They are always open and must be used very carefully. To increase safety when using claw couplings, we recommend the claw LNH claw coupling with a lock nut.

## CLAMPS AND CONNECTIONS

- Avoid screwdrivers when tightening.

Check that they are properly tightened. Avoid screwdrivers when tightening, they can easily slip and damage your hand. Use a wrench. If you need to use a screwdriver, mount the clamp in a vice.

## HOSES

When mounting hoses on hose connections, use water and soap in order to make the hose slip on to the connection. Do not use oil. Water and soap will dry up. Remove leaking hoses. A small leakage can quickly become a large hole.

## BLOW GUNS

- Use the safety version. It eliminates the risk of air at high pressure coming into direct contact with skin.

<sup>a</sup> Polycarbonate has good chemical resistance to all solvents except chemicals containing acetone, benzol, glycerine, some hydraulic and synthetic oils, chloroform, methyl alcohol, carbon tetrachloride (and similar solvents), carbon disulphide, perchloroethylene, toluene, trichloroethylene, xylene (nitrocellulose, thinner), acetic acid.

## FOLLOW THIS ORDER WHEN WORKING WITH CLAW COUPLINGS.

### How to open a claw coupling:

- 1 Close the ball valve.



- 4 How to close a claw coupling:

Make sure that the two claw couplings are mounted together.

Use claw couplings with lock nut (LNH) or use a lock spring for safer locking.



- 2 Run the tool so the air ventilates out.



- 5 Open the ball valve gently.



- 3 Release the claw coupling.

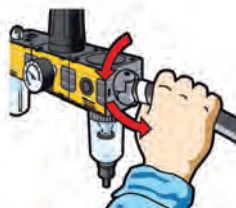



## Saving your tooling investment

*Being global solution providers of tooling, compressors, vacuum solutions, etc. We at Atlas Copco would like to assist you, our customer's in achieving the maximum productivity out of out of your tool. We know that a well-designed air network can reduce your air leakage cost, enhance the performance of your tool, lead to greater productivity, energy efficient and in turn less down time.*

Atlas Copco air preparation units, such as filters, regulators and lubricators, enable your tools to run at optimal levels, hence reducing downtime and increasing productivity. The filter ensures compressed air comes cleaner to the tool without any partials that might affect the performance of your tool in an adverse way, the regulator helps maintain a stable dynamic pressure and the lubricator helps to oil the tool in a controlled way.

### **FILTER – (F)**

Separating water and solid particles from the airline and compressor. Using filters results in higher quality air, you ensure longer service intervals, improved efficiency. Based on the centrifugal phenomena, gravity and centrifugal force, remove the heavy water partials resulting in minimum contamination of the tools motor and body from dirt partials.

Atlas Copco filters separate up to 98% of the water when operating within the design working range. With auto drainage the bowl is emptied when the accumulated water reaches a certain level.

### **REGULATOR – REG\***

Airline regulators used for natural gases and compressed air with built in lockable setting knobs are used to supply a constant flow of air to as required to maintain the efficiency of the tool being used.

The air pressure regulator ensures that the pre-set working pressure remains constant regardless of pressure variations in the intake air and minor variations in the air flow rate. By preventing unnecessary consumption of air, the air pressure regulator improves overall operating economy. Regulators are used to provide constant air pressure to the tool at all times and to prevent minor air flow fluctuations that can affect the performance of the tool.

### **LUBRICATOR – DIM**

Lubrication for more power and longer lifetime of the tool, lubrication is essential to prolong the life of the vane in the tool motor (unless stated otherwise). The life of the vanes may decrease to as little as 1/10th of the normal working time. Tests in Atlas Copco laboratories

Showed that the power output of a grinder decreases by 15-20% after 20 minutes when not lubricated. With the use of a lubricator you will prolong the lifetime of a vane motor up to three times and the motor will work much more efficiently, and with less friction.

F/R units are combined filter / regulators assembled together. F/R units are recommended in every case where both filters and regulators are needed. Filtering and regulating and lubricating properties are almost the same as for individual units.



Filter – FIL



Regulator – REG



Lubricator – DIM

\*(1 bar pressure drop from 6.3 bar means 20% lost efficiency)

Air preparation unit MINI-Range main application is to prepare the air for pneumatic components. MINI units have a 1/4" BSP connection thread, are ideal for small tooling applications.

**WORKING TEMPERATURE**

-10°C to 50°C

**MAX WORKING PRESSURE**

10 bar (232 psi)

**DESCRIPTION**

Sinter filter centrifugal principle, diaphragm-type pressure with relieving feature, lubricator with automatic oil filling.

**MEDIUM**

Compressed air and neutral gases

**SUPPLY PRESSURE**

1.5 - 16 Bar at inlet

0.5 - 10 Bar at outlet

**FILTER ELEMENT**

5µm



Model	Maximum air flow l/s	Bowl material	Filter condensate drainage	Max condensate capacity cm <sup>3</sup>	Max oil capacity cm <sup>3</sup>	Weight kg	Ordering No.
<b>Filters</b>							
MINI-FIL-1/4-BSP	37	Plastic, PC with PA bowl guard	Automatic	10	-	0.28	4221 0001 31
<b>Regulators</b>							
MINI-REG-1/4-BSP	34	-	-	-	-	0.30	4221 0001 39
<b>Lubricators</b>							
MINI-LUB-1/4-BSP	46	Plastic, PC with PA bowl guard	-	-	40	0.29	4221 0001 47
<b>Filter/regulator</b>							
MINI-F/R-1/4-BSP	34	Plastic, PC with PA bowl guard	Automatic	10	-	0.48	4221 0001 55
<b>Filter/regulator+lubricator</b>							
MINI-FRL-1/4-BSP	29	Plastic, PC with PA bowl guard	Automatic	10	40	0.78	4221 0001 63

**NOTE:** All separate units, mounting brackets, assembly kits and pressure gauges need to be ordered separately. MINI-F/R-1/4-BSP and MINI-FRL-1/4-BSP are delivered with gauge.

The MIDI Range is suitable for more than 90% of the Atlas Copco tool range and is the best choice for assembly tools, percussive tools, drills, nibblers and grinders up to Turbo. The MIDI has a 1/2" BSP connection thread and a housing and bowl of high-tech polymer.

**WORKING TEMPERATURE**

-10 °C to 50°C

**NOTE:** For dry compressed air, ice formation must be avoided.

**DESCRIPTION**

Sinter filter centrifugal principle, diaphragm-type pressure with relieving feature, lubricator with automatic oil filling.

**MEDIUM**

Compressed air, neutral gases

**SUPPLY PRESSURE**

1.5 to 16 Bar at inlet  
0.5 - 10 Bar at outlet

**FILTER ELEMENT**

5µm



Model	Maximum air flow l/s	Bowl material	Filter condensate drainage	Max condensate capacity cm <sup>3</sup>	Max oil capacity cm <sup>3</sup>	Weight kg	Ordering No.
<b>Filters</b>							
MIDI-FIL-1/2-BSP	59	Plastic, PC with PA bowl guard	Automatic	31	-	0.4	4221 0001 33
<b>Regulators</b>							
MIDI-REG-1/2-BSP	83	-	-	-	-	0.49	4221 0001 41
<b>Lubricators</b>							
MIDI-LUB-1/2-BSP	134	Plastic, PC with PA bowl guard	-	-	80	0.41	4221 0001 49
<b>Filter/Regulator</b>							
MIDI-F/R-1/2-BSP	83	Plastic, PC with PA bowl guard	Automatic	31	-	0.66	4221 0001 57
<b>Filter/Regulator/Lubricator</b>							
MIDI-FRL-1/2-BSP	65	Plastic, PC with PA bowl guard	Automatic	31	80	1.16	4221 0001 65

**NOTE:** All separate units, mounting brackets, assembly kits and pressure gauges need to be ordered separately. MIDI-F/R-1/2-BSP and MIDI-FRL-1/2-BSP are delivered with gauge.

The high flow MAXI air preparation unit's main application is to prepare the air for pneumatic tools which are large air consumers when long distribution hoses and multi connectors are used. A good example is Atlas Copco Turbo grinders.

### WORKING TEMPERATURE

-10°C to +50°C

**NOTE:** For dry compressed air, ice formation must be avoided.

### DESCRIPTION

Sinter filter centrifugal principle, diaphragm-type pressure with relieving feature, lubricator with automatic oil filling.

### MEDIUM

Compressed air, neutral gases.

### SUPPLY PRESSURE

1.5 to 16 Bar at inlet

0.5 - 10 Bar at outlet

### FILTER ELEMENT

5µm



Model	Maximum air flow l/s	Bowl material	Filter condensate drainage	Max condensate capacity cm <sup>3</sup>	Max oil capacity cm <sup>3</sup>	Weight kg	Ordering No.
<b>Filters</b>							
MAXI-FIL-3/4-BSP	134 <sup>a</sup>	Plastic, PC with PA bowl guard	Automatic	69	-	0.9	4221 0001 35
MAXI-FIL-1-BSP	134 <sup>a</sup>	Plastic, PC with PA bowl guard	Automatic	69	-	0.8	4221 0001 37
<b>Regulators</b>							
MAXI-REG-3/4-BSP	237	Plastic, PC with PA bowl guard	-	-	-	1.02	4221 0001 43
MAXI-REG-1-BSP	237	Plastic, PC with PA bowl guard	-	-	-	0.95	4221 0001 45
<b>Lubricators</b>							
MAXI-LUB-3/4-BSP	234	Plastic, PC with PA bowl guard	-	-	181	0.95	4221 0001 51
MAXI-LUB-1-BSP	234	Plastic, PC with PA bowl guard	-	-	181	0.89	4221 0001 53
<b>Filter/regulator</b>							
MAXI-F/R-3/4-BSP	217	Plastic, PC with PA bowl guard	Automatic	69	-	1.29	4221 0001 59
MAXI-FRL-1-BSP	217	Plastic, PC with PA bowl guard	Automatic	69	-	1.29	4221 0001 61
<b>Filter/Regulator/Lubricator</b>							
MAXI-FRL-3/4-BSP	200	Plastic, PC with PA bowl guard	Automatic	69	181	1.29	4221 0001 67
MAXI-FRL-1-BSP	200	Plastic, PC with PA bowl guard	Automatic	69	181	1.23	4221 0001 69

<sup>a</sup> 8 bar inlet pressure, 1 bar pressure drop.

**NOTE:** All separate units, mounting brackets, assembly kits and pressure gauges need to be ordered separately. MAXI-F/R-3/4-BSP, MAXI-F/R-1-BSP, MAXI-FRL-3/4-BSP and MAXI-FRL-1-BSP are delivered with gauge.

Accessories: Maxi FRL stand, metal bowl, pressure language, ball valve are all on accessory page.

## Optional Accessories

### SINGLE FILTER ACCESSORIES

Designation	Ordering No.
Semi/Manual Drain: for MINI series	4221 0001 75
Autodrain: for all three ranges	4221 0001 76
<b>Metal filter bowl with level indicator and automatic drain (P1 max 10 bar)</b>	
MINI series	4221 0002 04
MIDI series	4221 0002 05
MAXI series	4221 0002 07

### SINGLE REGULATOR ACCESSORIES

Designation	Ordering No.
Pressure Gauge 1: Standard (Metal material) BSP	4221 0001 77
Pressure Gauge 1: Standard (Metal material) NPT	4221 0001 78
Pressure Gauge 2: Heavy Duty (Larger size in metal)	4221 0001 79

### SINGLE LUBRICATOR ACCESSORIES

Designation	Ordering No.		
	MINI	MIDI	MAXI
<b>Metal bowl with level indicator and fill valve (Die cast, Zinc)</b>			
	4221 0001 80	4221 0001 81	4221 0001 82

### FILTER, REGULATOR AND LUBRICATOR ACCESSORIES

Designation	Ordering No.
<b>MINI</b>	
Coupling kit - (Steel, for wall mounting, 1x)	4221 0001 83
Mounting bracket - (Steel, for control panel mounting, 1x)	4221 0001 84
Coupling kit - for connecting F+R+L units, 1x)	4221 0001 85
<b>MIDI</b>	
Coupling kit - (Steel, for wall mounting, 1x)	4221 0001 86
Mounting bracket - (Steel, for control panel mounting, 1x)	4221 0001 87
Coupling kit - For connecting F+R+L units, 1x)	4221 0001 88
<b>MAXI</b>	
Coupling kit - (Steel, for wall mounting, 1x)	4221 0001 89
Coupling kit - for connecting F+R+L units, 1x)	4221 0001 90
Coupling kit - (Steel, for wall mounting, 1x)	4221 0002 00

**NOTE:**Control panel nut included in the bracket kit for all models.  
The Auto Drain fits to the complete FRL range and is already factory mounted on the complete FRL range.

### BALL VALVE (LOCKABLE)

Designation	Ordering No.
Size MINI	8202 1350 63
Size MIDI	8202 1350 64
Size MAXI 3/4"	8202 1350 65
Size MAXI 1"	8202 1350 66

**NOTE:** Control panel nut is included with the bracket



Mounting bracket kit



Filter element



Pressure gauge



Ball valve



## AIR TOOL OIL

Atlas Copco air tool oil is a white, oil based lubricant for pneumatic tools. It has excellent antiwear properties and contains additives preventing oxidation and foaming. Optimizer air tool oil provides a better working environment, compared to conventional mist lubrication oils and is recommended when stringent demands are placed on the working environment.

- Provides a better working environment.
- Excellent antiwear properties.
- Minimizes wear on components.



## Technical Data

Temperature range	-25°C to +70°C
Density at 15°C	869 kg/m <sup>3</sup>
Viscosity at 40°C	22 mm <sup>2</sup> /s
Pour point	-48°C
Flash point COC	>170°C

Model	Ordering No.
Optimizer 0.5 liter	9090 0000 02
Optimizer 1 liter	9090 0000 04
Optimizer 4 liter	9090 0000 06

## SINGLE POINT LUBRICATOR DOSOL

Accurate lubrication for tools in intermittent service.

The Atlas Copco DOSOL system for direct lubrication is based on an injector pump which meters out the oil in exact doses, actuated by pulses of compressed air. The oil dosage can be regulated from a fraction of a drop to a full drop.

- **Exact amount** – Precision injector, adjustable for exact amount of oil.
- **Oil directly at the tool** – The oil is conveyed through a capillary tube directly to the lubrication point.

A single-point lubricator (SPL) consists of an injector pump fitted to a valve body, converting interruptions in compressed air flow into pulses. In the majority of cases, an oil bowl is fitted on each lubricator.

Every DOSOL SPL unit can be finely tuned to inject from 1 to 1/10 of a drop of oil in 40 steps (30 to 3 mm<sup>3</sup>). Every DOSOL SPL unit includes as standard a counter with a switch that allows the lubricator to operate every first, fifth or tenth tool cycle.

The adjusting knob features a positive stop at both maximum and minimum settings, which means that a zero setting is not possible.

The preset quantity of oil is supplied to the tool through a small-bore nylon tube inside the air hose. 7.5 m of oil-filled nylon tubing is included as standard.



## MULTIPLE-POINT LUBRICATOR DOSOL

For supplying lubricant to an unlimited number of lubrication points on a machine or in a pneumatic system.

The DOSOL multiple-point lubricator (MPL) consists of a number of JECT 01 oil metering pumps assembled into a "package" with a common BASE base-plate. A stack may contain up to ten JECT 01 units. Several such assemblies may be used together.

- All oil pumps are supplied with oil via the BASE from an oil container or central oil reservoir. A line for pneumatic signals from the equipment to be lubricated is also connected to the BASE.
- The lubricant is conveyed through small-bore nylon tubing which should be ended with check valves.
- With the TEN counter the lubricator can be actuated every first, fifth or tenth tool cycle.

Every DOSOL MPL unit can be finely tuned to inject from 1 to 1/10 drop of oil in 40 steps (30 to 3 mm<sup>3</sup>). This helps to minimize the oil dose. The adjusting knob features a positive stop at both maximum and minimum settings, which means that zero setting is not possible.

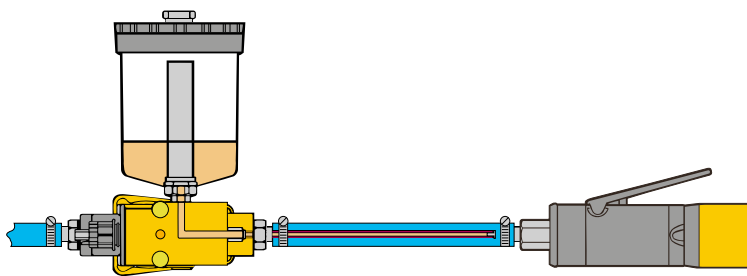

## SINGLE-POINT LUBRICATOR, DOS

Model	Connection thread BSP in	Air flow l/s		Working pressure bar		Temperature range °C		Ordering No.
		min	max <sup>a</sup>	min	max	min	max	
DOS 15B-C <sup>b</sup>	1/2	2.3	45	3.2	10	-30°	+60°	8202 4201 73
DOS 15B-CR <sup>c</sup>	1/2	2.3	45	3.2	10	-30°	+60°	8202 4202 72
DOS 20B-C <sup>b</sup>	3/4	2.3	53	3.2	10	-30°	+60°	8202 4201 81
DOS 20B-CR <sup>c</sup>	3/4	2.3	53	3.2	10	-30°	+60°	8202 4202 80

<sup>a</sup> At 6 bar and DP = 0.2 bar.

<sup>b</sup> With counter and 7.5 m oil-filled nylon tubing.

<sup>c</sup> With 0.3 l oil container counter and 7.5 m oil-filled nylon tubing.

## Optional Accessories

### FOR SINGLE POINT LUBRICATOR DOSOL

Designation	Ordering No.
Nylon tubing 3.2 mm outside diameter	
7.5 m, oil-filled	9090 1418 00
7.5 m, without oil	9090 1419 00
100 m, with oil	9090 1420 00
Barbed nipple for joining of 3.2 mm tubes	9090 1423 00
Check valve for outer end of nylon tubing, dia ext. 3.2 mm	9090 2050 00

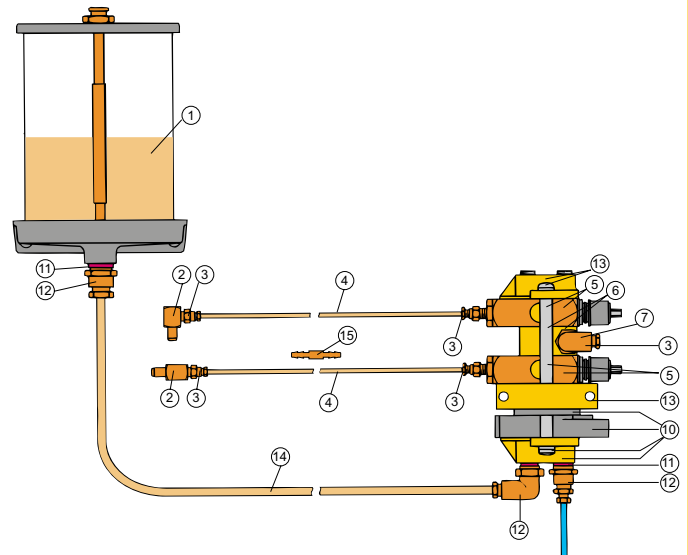

**NOTE:** When the counter TEN is used in MPL installations an intermediate, black plastic part is used (supplied with all TEN counters) between BASE and TEN.

### FOR MULTI POINT LUBRICATOR DOSOL

#### MULTIPLE-POINT LUBRICATOR, BASE, JECT 01

Designation	BSP in	Ordering No.
BASE baseplate	Plate	8202 4205 04
	Oil port	1/4
	Air port	1/4
	Clamp	
	Oil port	1/4
	Air port	1/4
JECT 01 oil pump	Oil delivery port	1/8
		8202 4203 10

#### TEN-counter

When lubricating equipment with a very low air consumption or very short time in operation it may be difficult to set a sufficiently small dose of oil. In such cases a counter is connected underneath the base plate BASE. The oil pumps will then be actuated only on each, every fifth or every tenth air pulse. The air signal is connected to the clamp underneath the counter. Ordering No. 8202 4206 03

#### Side-ported air block kit

If all pumps are not to be actuated simultaneously, a signal block is installed between the oil pumps in the stack. The pumps below the signal block will then be actuated via the base plate BASE and those above it from a separate signal via the signal block.

Ordering No. 8202 4206 03

Ref No. in figure	Designation	Ordering No.
1	Oil container 0.3 l for direct mounting 0.95 l for wall mounting (1/4" BSP female) 1.9 l for wall mounting (1/4" BSP female)	9090 1415 00 9090 1416 00 9090 1417 00
2	Check valve 1/8" BSPT 90° elbow male x 1/8" BSP female 1/8" BSPT, straight male x 1/8" BSP female	9090 1427 00 9090 1426 00
3	Male adapter 1/8" BSPT, straight for tube outer diameter 3.2 mm	9090 1425 00
4	Capillary tubing 7.5 m, outer dia. 3.2 mm prefilled with oil 7.5 m, outer dia. 3.2 mm without oil 100 m, outer dia. 3.2 mm with oil	9090 1418 00 9090 1419 00 9090 1420 00
5	JECT 01 kit <sup>a</sup>	8202 4203 10
6	Side-ported air block kit	9090 1424 00
7	Fiber packing for 1/8" BSP	0657 5742 00
10	Counter TEN kit	8202 4206 03
11	Fiber packing for 1/4" BSP	0657 5764 00
12	Male adapter 1/4" BSP, straight for tube outer diameter 8 mm	9090 0715 00
13	BASE kit	8202 4205 04
14	Nylon tube, outer diameter 8 mm (sold by the meter)	9030 0060 00
15	Barbed nipple for joining of nylon tubes outer diameter 3.2 mm	9090 1423 00
16	Nylon tube outer diameter 5 mm (sold by the meter)	9030 0059 00

<sup>a</sup> With high temperature Viton seals 8202 4203 15.

## Ensure the highest air flow and lowest pressure drop of your pneumatic tools

*Whenever tools or pneumatic equipment need to be changed, or you need to make quick connections of hoses to an air outlet, Atlas Copco couplings are the energy efficient and high productivity choice.*

### ENERGY EFFICIENCY

All Atlas Copco couplings are designed to ensure minimum pressure drop and thus reduce energy consumption.

### PRODUCTIVITY

Exceptionally high air flow ensures full power to your tools.

### QUALITY

Atlas Copco couplings are light and compact and the bodies are made of hardened steel, which provides long life in the toughest applications.

### ERGONOMICS

The couplings from Atlas Copco features compact dimensions and low weight for the operator.

### SAFETY

ErgoQIC and SmartQIC are vented safety versions to minimize the risk of sudden component separation and sound bang. The safety features are according to EN 983 and ISO 4414.

### THE RANGE

Atlas Copco offers four product groups of quick couplings in many international standards:

- ErgoQIC - full flow coupling.
- SmartQIC - Safety vented coupling.
- QIC - Entry level coupling.
- Claw - High flow and durable coupling.

## Selection Guide









Standard Type	Global standard			Euro standard			US standard / ISO 6150-B			Asia standard	
				7.6 (7.4) mm	10.4 mm	15 mm	5.3 mm (1/4")	8.2 mm (3/8")	11 mm (1/2")		7.5
Atlas Copco ErgoQIC	08	10		10AC	08E	15E		08US	10US	15US	10 A
Atlas Copco SmartQIC					08E	15E		08US	10US	15US	10 A
Atlas Copco QIC				10			15	08			
Atlas Copco Claw			Claw								
CEJN					320	410		310	430	550	315
Oetiker					SC C			SC B1	SC E	SC H	SC D
Tema				1650	1600	1700	1750	1400			
Rectus				33	25/26	27	34	23/24	30	37	13
Prevost					ESC/ERC07			IRC/ISC06	IRC/ISC08	ISG 11	ORG
Nitto Kohki											20/30/40
Amflo								C20B	C26	C10	
Bosch					7.2						
Parker						55		30 / B23	25F	17	
Foster								3003	4404	5205	
Abnox					x						
Afnor NF 49053								x	x	x	
Camozzi					508/5180						
Dynaquip								1/4"	3/8"		
EWO					x						
Festo					KD						
Gromelle								600	900		
Hansen								22/3000	400/4000	500/5000	
Ingersoll Rand					7S7			A2/MS/102	A3/103/203	A4/104/204	
Kaeser					x						
Legris					25/26	27		23/24	30		13
Tomco								180	4000	5000	

## MAXIMIZE YOUR PRODUCTIVITY!

Select full flow couplings from Atlas Copco



- Recommended by Atlas Copco for your application and tool.

			ErgoQIC 08US	ErgoQIC 08 ErgoQIC 10AC	ErgoQIC 10 A	ErgoQIC 08E	ErgoQIC 10US	ErgoQIC 10	ErgoQIC 15E	ErgoQIC 15US
		Air flow capacity	0-11 l/s	0-18 l/s	0-22 l/s	0-24 l/s	0-27 l/s	0-40 l/s	0-49 l/s	0-52 l/s
	Screwdrivers	Bolt size	M2-M6	2-8 l/s	•	•	•	•		
		Bolt size	1/4" HEX and 3/8"	2-9 l/s	•	•	•	•		
	Impact wrenches	Bolt size	3/8" and 1/2"	10-20 l/s	•	•	•	•		
		Bolt size	1" and 1 1/2"	28-37 l/s					•	•
		Bolt size								
	Pulse tools	Bolt size	M4-M5	9 l/s	•	•	•	•		
		Bolt size	M6-M12	15-25 l/s	•	•	•	•	•	•
		Bolt size	M14-M20	32-49 l/s					•	•
	Drills	Power	<820 W	8-21 l/s	•	•	•	•		
		Size								
	Chipping hammers	Power	<7 kg	6.5-14 l/s	•	•	•	•		
		Size								
	Die grinders	Power	<500 W	3-10 l/s	•	•	•	•		
		Power	500-900 W	7-19 l/s			•	•	•	
		Power	0.9-2 kW	20-35 l/s			•	•	•	•
	Turbine grinders	Power	<2.5 kW	32 l/s				•	•	•
		Size								
	Blow guns			4-7.5 l/s	•	•	•	•		

### ERGOQIC

The ErgoQIC coupling is a ball valve coupling with a safety feature offering a higher flow than ordinary coupling systems. The ErgoQIC is a strong and durable full flow quick coupling with no air restriction inside the coupling. It is suitable for assembly tools, drills and grinders. Upgrading any air system with ErgoQIC will give the benefits of productivity and energy efficiency. ErgoQIC is designed to minimize the risk of sudden component separation and sound bang. The safety features are according to EN 983 and ISO 4414. It is made of hardened steel.

The ErgoQIC disconnects in two steps; first you push in and bend slowly – the pressurized air hose will then vent, and as a second step you can disconnect without risk of harming the operator.



### SMARTQIC

SMARTQIC is the latest generation of pneumatic safety couplings and nipples. The couplings offers high flow and low pressure drop with innovative safety features. The design has a unique safety venting feature when disconnecting, thus minimizing risk of injury to the operator.

Durable and tough, the couplings are made out of zinc-plated steel/brass material and the entire product range complies with safety standards ISO 4414 and EN 983. SMARTQIC couplings also complies with OSHA 1910.95.

Suitable for many types of applications and pneumatic tools; such as screwdrivers, assembly tools, drills and grinders.



### CLAW

CLAW couplings are made from drop-forged, hardened steel which can withstand rough treatment and ensures a long life even under difficult conditions. The coupling head is the same for all hose sizes, which can therefore be freely combined. The recommended maximum working pressure is 10 bar.



### MULTIFLEX SWIVEL

MultiFlex Swivel is a multi-directional connector. Once the tool is connected the hose will stay in the ideal position however much the operator and the tool move around. The MultiFlex bends and rotates 360° in all directions while the hose stays straight.







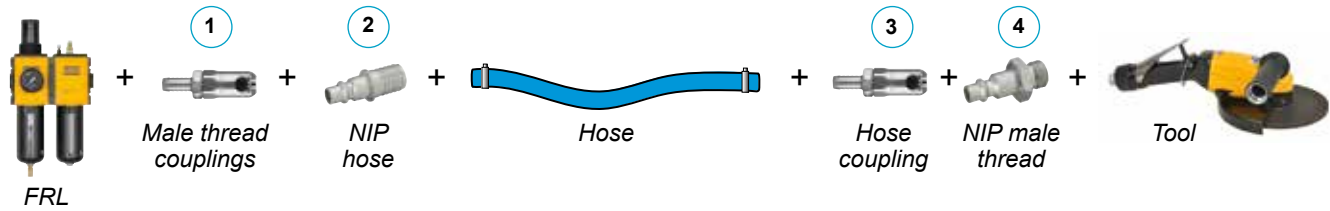

## HOWTO...

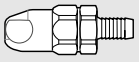

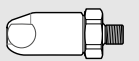
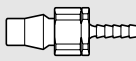
**NOTE:** Most Atlas Copco tools come with a female thread, please check the tread before choosing your coupling and nip selection.  
Same selection process can be used for all couplings e.g. SmartQic ; ErgoQic, etc..

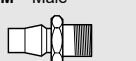
EXAMPLE				EXAMPLE			
Connection type	Coupling ErgoQIC 10	Ordering No.	Size	Connection type	Nipple ErgoNIP 10	Ordering No.	Size
			mm in				mm in
 H – Hose	H06	8202 1120 30	6.3 1/4	 H – Hose	H06	8202 1220 35	6.3 1/4
	H08	8202 1120 40	8 5/16		H08	8202 1220 43	8 5/16
	H10	8202 1120 02	10 3/8		H10	8202 1220 50	10 3/8
	H13	8202 1120 10	12.5 1/2		H13	8202 1220 68	12.5 1/2
	H16	8202 1120 50	16 5/8		H16	8202 1220 76	16 5/8
	H20	8202 1120 60	19 3/4		H20	8202 1220 77	19 3/4
 M – Male	M08	8202 1120 85	1/4 BSP	 SH – Safety Hose <sup>a</sup>	SH06	8202 1220 37	6.3 1/4
	M10	8202 1120 93	3/8 BSP		SH08	8202 1220 45	8 5/16
	M15	8202 1120 97	1/2 BSP		SH10	8202 1220 52	10 3/8
	M20	8202 1120 98	3/4 BSP		SH13	8202 1220 70	12.5 1/2
	M25	8202 1120 99	1 BSP		SH16	8202 1220 74	16 5/8
 F – Female	F08	8202 1121 00	1/4 BSP	 M – Male	M08	8202 1220 01	1/4 BSP
	F10	8202 1121 05	3/8 BSP		M10	8202 1220 19	3/8 BSP
	F15	8202 1121 10	1/2 BSP		M15	8202 1220 27	1/2 BSP



Nipple profile

## ErgoQIC 08

### ATLAS COPCO GLOBAL STANDARD

The ErgoQIC 08 is a full flow quick coupling with no air restriction inside the coupling. It is suitable for assembly tools, drills and small grinders. Upgrading any air system with ErgoQIC 08 will give the benefits of productivity and energy efficiency.

- Full flow coupling.
- Ergonomic design, small size and low weight.
- Strong and durable.
- Safety feature according to EN 983 / ISO 4414.
- Protective rubber cover available.
- Main market: Global.

### Technical Data

Max flow capacity	29 l/s (0.5 bar ΔP)
Economical air flow	18 l/s (0.2 bar ΔP)
Max working pressure	16 bar
Temperature range	-10°C to +70°C

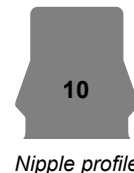

Nipple profile

## ErgoQIC 10

### ATLAS COPCO GLOBAL STANDARD

The ErgoQIC 10 is a full flow coupling with no air restriction inside the coupling. It is suitable for assembly tools, drills and grinders. Upgrading any air system with ErgoQIC 10 will give the benefits of productivity and energy efficiency.

- Extreme full flow coupling.
- Strong and durable.
- Minimized connection force.
- Safety feature according to EN 983 / ISO 4414.
- Protective rubber cover available.
- Main market: Global.

### Technical Data

Max flow capacity	60 l/s (0.5 bar ΔP)
Economical air flow	40 l/s (0.2 bar ΔP)
Max working pressure	16 bar
Temperature range	-10°C to +70°C

## ERGOQIC 08 AND ERGONIP 08, 18 L/S (recommended air flow at 6.3 bar pressure)

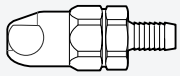
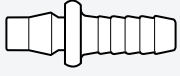
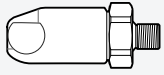
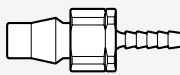
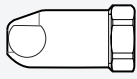
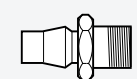
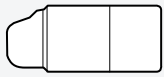
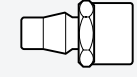
Connection type	Coupling ErgoQIC 08	Ordering No.	Size		Connection type	Nipple ErgoNIP 08	Ordering No.	Size	
			mm	in				mm	in
<b>H – Hose</b> 	H06	8202 1110 04	6.3	1/4	<b>H – Hose</b> 	H05	8202 1210 33	5	3/16
	H08	8202 1110 12	8	5/16		H06	8202 1210 37	6.3	1/4
	H10	8202 1110 38	10	3/8		H08	8202 1210 45	8	5/16
	H13	8202 1110 40	12.5	1/2		H10	8202 1210 52	10	3/8
<b>M – Male</b> 	M08	8202 1110 61	1/4 BSP	<b>SH – Safety Hose<sup>a</sup></b> 	SH06	8202 1210 39	6.3	1/4	
	M10	8202 1110 79	3/8 BSP		SH08	8202 1210 47	8	5/16	
	M15	8202 1110 87	1/2 BSP		SH10	8202 1210 50	10	3/8	
<b>F – Female</b> 	F08	8202 1110 90	1/4 BSP	<b>M – Male</b> 	M06	8202 1210 03	1/8 BSP		
	F10	8202 1110 95	3/8 BSP		M08	8202 1210 11	1/4 BSP		
<b>Protective cover</b> 		9090 1940 00				M10	8202 1210 29	3/8 BSP	
							M15	8202 1210 31	1/2 BSP
					<b>F – Female</b> 	F08	8202 1210 60	1/4 BSP	
						F10	8202 1210 62	3/8 BSP	

<sup>a</sup> For joining hoses longer than 3 meters.

## ERGOQIC 10 AND ERGONIP 10, 40 L/S (recommended air flow at 6.3 bar pressure)

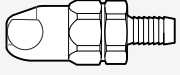
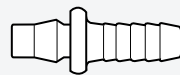
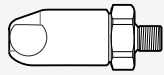
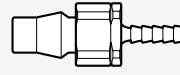
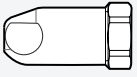
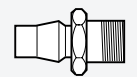
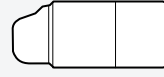
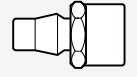
Connection type	Coupling ErgoQIC 10	Ordering No.	Size		Connection type	Nipple ErgoNIP 10	Ordering No.	Size	
			mm	in				mm	in
<b>H – Hose</b> 	H06	8202 1120 30	6.3	1/4	<b>H – Hose</b> 	H06	8202 1220 35	6.3	1/4
	H08	8202 1120 40	8	5/16		H08	8202 1220 43	8	5/16
	H10	8202 1120 02	10	3/8		H10	8202 1220 50	10	3/8
	H13	8202 1120 10	12.5	1/2		H13	8202 1220 68	12.5	1/2
	H16	8202 1120 50	16	5/8		H16	8202 1220 76	16	5/8
	H20	8202 1120 60	19	3/4		H20	8202 1220 77	19	3/4
<b>M – Male</b> 	M08	8202 1120 85	1/4 BSP	<b>SH – Safety Hose<sup>a</sup></b> 	SH06	8202 1220 37	6.3	1/4	
	M10	8202 1120 93	3/8 BSP		SH08	8202 1220 45	8	5/16	
	M15	8202 1120 97	1/2 BSP		SH10	8202 1220 52	10	3/8	
	M20	8202 1120 98	3/4 BSP		SH13	8202 1220 70	12.5	1/2	
	M25	8202 1120 99	1 BSP		SH16	8202 1220 74	16	5/8	
<b>F – Female</b> 	F08	8202 1121 00	1/4 BSP	<b>M – Male</b> 	M08	8202 1220 01	1/4 BSP		
	F10	8202 1121 05	3/8 BSP		M10	8202 1220 19	3/8 BSP		
	F15	8202 1121 10	1/2 BSP		M15	8202 1220 27	1/2 BSP		
<b>Protective cover</b> 		9090 1931 00		<b>F – Female</b> 	F08	8202 1220 84	1/4 BSP		
						F10	8202 1220 86	3/8 BSP	
						F15	8202 1220 88	1/2 BSP	

<sup>a</sup> For joining hoses longer than 3 meters.

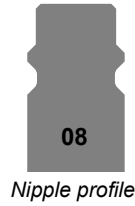

Nipple profile

**ErgoQIC 08E**

**EURO STANDARD 7.6 (7.4)**

The ErgoQIC 08E is a full flow quick coupling with no air restriction inside the coupling. It is suitable for assembly tools, drills and small grinders. Upgrading any air system using Eurostandard nipples with ErgoQIC 08E couplings will give the benefits of productivity and energy efficiency.

- Full flow coupling.
- Ergonomic design, small size and low weight.
- Strong and durable.
- Safety feature according to EN 983 / ISO 4414.
- Protective rubber cover available.
- Main market: Europe.

**Technical Data**

Max flow capacity	38 l/s (0.5 bar ΔP)
Economical air flow	24 l/s (0.2 bar ΔP)
Max working pressure	16 bar
Temperature range	-10°C to +70°C

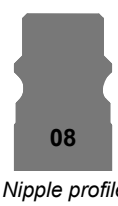

Nipple profile

**Atlas Copco SmartQIC 08E**

**EURO STANDARD 7.6 (7.4)**

Safety coupling with venting connection, high flow and low pressure drop.



Common standard used in EU-markets for many types of assembly and material removal tools.

- High reliability with low pressure drop.
- Safety function with vented connection.
- High durability and easy handling.
- High air flow and increased productivity.
- Minimizes hose whip and injuries to operator.
- Long life time.
- Safety feature according to ISO-standard 4414 and EN 983.
- Complies with OSHA 1910.95.
- Main market: Europe.

**Technical Data**

Max flow capacity	38 l/s (0.5 bar ΔP)
Economical air flow	35 l/s (0.2 bar ΔP)
Max working pressure	16 bar
Temperature range	-20°C to +100°C

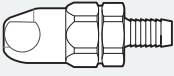
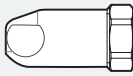
## ERGOQIC 08E, 24 L/S (recommended air flow at 6.3 bar pressure)

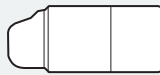
Connection type	Coupling ErgoQIC 08E	Ordering No.	Size		Connection type	Coupling ErgoQIC 08E	Ordering No.	Size	
			mm	in				mm	in
<b>H – Hose</b> 	H06	8202 1106 00	6.3	1/4	<b>F – Female</b> 	F08	8202 1106 07	1/4	BSP
	H08	8202 1106 01	8	5/16		F10	8202 1106 08	3/8	BSP
	H10	8202 1106 02	10	3/8		F15	8202 1106 09	1/2	BSP
	H13	8202 1106 03	12.5	1/2					
<b>M – Male thread</b> 	M08	8202 1106 04	1/4	BSP	<b>Protective cover</b> 		9090 1940 01		
	M10	8202 1106 05	3/8	BSP					
	M15	8202 1106 06	1/2	BSP					

## SMARTQIC 08E, 35 L/S (recommended air flow at 6.3 bar pressure)

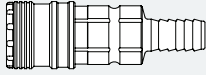
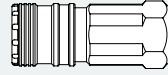
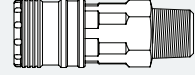
Connection type	Coupling SmartQIC-08E	Ordering No.	Size		Connection type	Coupling SmartQIC-08E	Ordering No.	Size	
			mm	in				mm	in
<b>H – Hose</b> 	H08	4221 0010 00	8	1/4	<b>F – Female</b> 	F06	4221 0010 06	1/4	BSP
	H10	4221 0010 01	10	5/16		F10	4221 0010 07	3/8	BSP
	H13	4221 0010 02	13	3/8		F15	4221 0010 08	1/2	BSP
<b>M – Male</b> 	M06	4221 0010 03*	1/4	BSPT					
	M10	4221 0010 04*	3/8	BSPT					
	M15	4221 0010 05*	1/2	BSPT					

## NIP 08E, 35 L/S (recommended air flow at 6.3 bar pressure) FOR ERGOQIC 08E AND SMARTQIC 08E

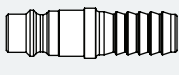
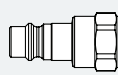
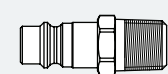
Connection type	Nipple NIP-08E	Ordering No.	Size		Connection type	Nipple NIP-08E	Ordering No.	Size	
			mm	in				mm	in
<b>H – Hose</b> 	H06	4221 0011 00	6.3	1/4	<b>F – Female</b> 	F06	4221 0011 07	1/4	BSP
	H08	4221 0011 01	8	5/16		F10	4221 0011 08	3/8	BSP
	H10	4221 0011 02	10	3/8		F15	4221 0011 09	1/2	BSP
	H13	4221 0011 03	13	5/16					
<b>M – Male</b> 	M04	4221 0002 81*	1/8	BSPT					
	M06	4221 0011 04	1/4	BSP					
	M10	4221 0011 05	3/8	BSP					
	M15	4221 0011 06	1/2	BSP					

\* Preapplied sealent.

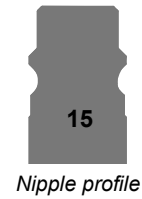
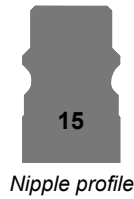

## ErgoQIC 15E

### EURO STANDARD 10.4

The ErgoQIC 15E is a full flow coupling with no air restriction inside the coupling suitable for large air consuming assembly tools, drills and grinders. Upgrading any air system with ErgoQIC 15E will give the benefit of productivity and energy efficiency.

- Extreme full flow coupling.
- Strong and durable.
- Minimized connection force.
- Safety feature according to EN 983 / ISO 4414.
- Main market: Europe.

### Technical Data

Max flow capacity	76 l/s (0.5 bar ΔP)
Economical air flow	49 l/s (0.2 bar ΔP)
Max working pressure	16 bar
Temperature range	-20°C to +80°C

## Atlas Copco SmartQIC 15E

### EURO STANDARD 10.4

Safety coupling with venting connection, high flow and low pressure drop.

Common standard used in EU-markets for many types of assembly and material removal tools.



- High reliability with low pressure drop.
- Safety function with vented connection.
- High durability and easy handling.
- High air flow and increased productivity.
- Minimizes hose whip and injuries to operator.
- Long life time.
- Safety feature according to ISO-standard 4414 and EN 983.
- Complies with OSHA 1910.95.
- Main market: Europe.

### Technical Data



Max flow capacity	68 l/s (0.5 bar ΔP)
Economical air flow	63 l/s (0.2 bar ΔP)
Max working pressure	16 bar
Temperature range	-20°C to +100°C

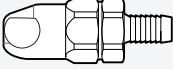
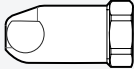

## ERGOQIC 15E, 49 L/S (recommended air flow at 6.3 bar pressure)

Connection type	Coupling ErgoQIC 15E	Ordering No.	Size		Connection type	Coupling ErgoQIC 15E	Ordering No.	Size	
			mm	in				mm	in
<b>H – Hose</b> 	H10	8202 1106 50	10	3/8	<b>F – Female</b> 	F10	8202 1106 70	3/8 BSP	
	H13	8202 1106 51	12.5	1/2		F15	8202 1106 71	1/2 BSP	
	H16	8202 1106 52	10	3/8					
	H20	8202 1106 53	12.5	1/2					
<b>M – Male thread</b> 	M10	8202 1106 60	3/8 BSP						
	M15	8202 1106 61	1/2 BSP						
	M20	8202 1106 62	3/4 BSP						
	M25	8202 1106 63	1 BSP						

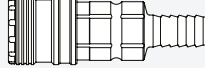
## SMARTQIC 15E, 63 L/S (recommended air flow at 6.3 bar pressure)

Connection type	Coupling SmartQIC 15E	Ordering No.	Size		Connection type	Coupling SmartQIC 15E	Ordering No.	Size	
			mm	in				mm	in
<b>H – Hose</b> 	H10	4221 0020 00	10	3/8	<b>F – Female</b> 	F10	4221 0020 07	3/8 BSP	
	H13	4221 0020 01	13	1/2		F15	4221 0020 08	1/2 BSP	
	H16	4221 0020 02	16	5/8		F20	4221 0020 09	3/4 BSP	
	H20	4221 0020 03	19	3/4					
<b>M – Male</b> 	M10	4221 0020 04	3/8 BSPT						
	M15	4221 0020 05	1/2 BSPT						
	M20	4221 0020 06	3/4 BSPT						

## NIP-15E, EU 10.4, 63 L/S (recommended air flow at 6.3 bar pressure) FOR ERGOQIC 15E AND SMARTQIC 15E

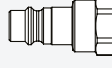
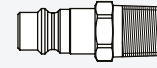
Connection type	Nipple NIP 15E	Ordering No.	Size		Connection type	Nipple NIP 15E	Ordering No.	Size	
			mm	in				mm	in
<b>H – Hose</b> 	H10	4221 0021 00	10	3/8	<b>F – Female</b> 	F10	4221 0021 07	3/8 BSP	
	H13	4221 0021 01	13	1/2		F15	4221 0021 08	1/2 BSP	
	H16	4221 0021 02	16	5/8		F20	4221 0021 09	3/4 BSP	
	H20	4221 0021 03	19	3/4					
<b>M – Male thread</b> 	M10	4221 0021 04	3/8 BSPT						
	M15	4221 0021 05	1/2 BSPT						
	M20	4221 0021 06	1/2 BSPT						

NOTE: T at the end stands for tapered thread e.g. BSPT.

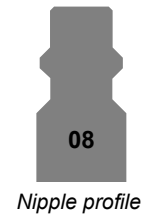
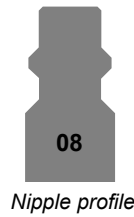

**ErgoQIC 08US**

**ISO 6150-B / US STANDARD**

The ErgoQIC 08US is a full flow quick coupling with no air restriction inside the coupling suitable for assembly tools, drills and small grinders. Upgrading any air system with ErgoQIC 08US will give the benefit of productivity and energy efficiency.

- Full flow coupling.
- Ergonomic design, small size and low weight.
- Strong and durable.
- Safety feature according to EN 983 / ISO 4414.
- Main market: North America, France, Norway and Spain.

**Technical Data**

Max flow capacity	17 l/s (0.5 bar ΔP)
Economical air flow	11 l/s (0.2 bar ΔP)
Max working pressure	16 bar
Temperature range	-20°C to 80°C

**Atlas Copco SmartQIC 08US**

**ISO 6150-B / US STANDARD**

Safety coupling with venting connection, high flow and low pressure drop.

- High reliability with low pressure drop.
- Safety function with vented connection.
- High durability and easy handling.
- High air flow and increased productivity.
- Minimizes hose whip and injuries to operator.
- Long life time.
- Safety feature according to ISO-standard 4414 and EN 983.
- Main market: Benelux, France, Norway and North America.

**Technical Data**

Max flow capacity	16 l/s (0.5 bar ΔP)
Economical air flow	15 l/s (0.2 bar ΔP)
Max working pressure	16 bar
Temperature range	-20°C to +100°C

# Quick Couplings

# ISO 6150-B / US Standard 5.3 mm (1/4")

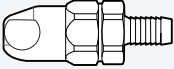
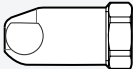
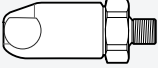

## ERGOQIC 08US, 11 L/S (recommended air flow at 6.3 bar pressure)

Connection type	Coupling ErgoQIC 08US	Ordering No.	Size		Connection type	Coupling ErgoQIC 08US	Ordering No.	Size	
			mm	in				mm	in
<b>H – Hose</b> 	H06	8202 1103 00	6.3	1/4	<b>F – Female</b> 	F08	8202 1103 11	1/4	BSP
	H08	8202 1103 01	8	5/16		F10	8202 1103 13	3/8	BSP
	H10	8202 1103 02	10	3/8					
<b>M – Male thread</b> 	M08	8202 1103 05		1/4 BSP					
	M10	8202 1103 07		3/8 BSP					
	M15	8202 1103 09		1/2 BSP					

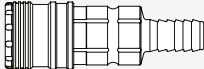
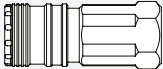
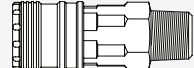
## SMARTQIC 08US, 15 L/S (recommended air flow at 6.3 bar pressure)

Connection type	Coupling SmartQIC 08US	Ordering No.	Size		Connection type	Coupling SmartQIC 08US	Ordering No.	Size	
			mm	in				mm	in
<b>H – Hose</b> 	H06	4221 0030 00	6.3	1/4	<b>F – Female</b> 	F08	4221 0030 07	1/4	BSP
	H08	4221 0030 01	8	5/16		F10	4221 0030 08	3/8	BSP
	H10	4221 0030 02	10	3/8		F08	4221 0030 09	1/4	NPT
<b>M – Male</b> 	M08	4221 0030 03*		3/8 BSPT					
	M10	4221 0030 04*		1/2 BSPT					
	M08	4221 0030 05		3/8 NPT					
	M10	4221 0030 06		1/2 NPT					

## NIP 08US, 11 L/S (recommended air flow at 6.3 bar pressure) FOR ERGOQIC 08US AND SMARTQIC 08US

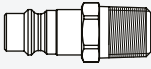
Connection type	Nipple NIP 08US	Ordering No.	Size		Connection type	Nipple NIP 08US	Ordering No.	Size	
			mm	in				mm	in
<b>H – Hose</b> 	H06	4221 0031 00	6.3	1/4	<b>F – Female</b> 	F06	4221 0031 07	1/4	BSP
	H08	4221 0031 01	8	5/16		F10	4221 0031 08	3/8	BSP
	H10	4221 0031 02	10	3/8		F06	4221 0031 09	1/4	NPT
<b>M – Male thread</b> 	M04	4221 0002 82*		1/8 BSPT					
	M08	4221 0031 03*		1/4 BSPT					
	M10	4221 0031 04*		3/8 BSPT					
	M08	4221 0031 05*		1/4 NPT					
	M10	4221 0031 06*		3/8 NPT					

\* Preapplied sealant.

**NOTE:** T at the end stands for tapered thread e.g. BSPT.

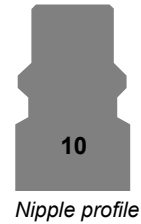
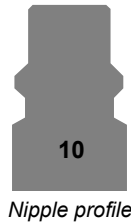

### ErgoQIC 10US

#### ISO 6150-B / US STANDARD

The ErgoQIC 10US is a full flow quick coupling with no air restriction inside the coupling suitable for assembly tools, drills and small grinders. Upgrading any air system with ErgoQIC 10US couplings will give the benefit of productivity and energy efficiency. It is interchangeable with US 3/8" standard nipples.

- Full flow coupling.
- Ergonomic design, small size and low weight.
- Strong and durable.
- Safety feature according to EN 983 / ISO 4414.
- Main market: North America, France, Norway and Spain.

#### Technical Data

Max flow capacity	43 l/s (0.5 bar ΔP)
Economical air flow	27 l/s (0.2 bar ΔP)
Max working pressure	16 bar
Temperature range	-20°C to 80°C

### Atlas Copco SmartQIC 10US

#### ISO 6150-B / US STANDARD



Safety coupling with venting connection, high flow and low pressure drop.

- High reliability with low pressure drop.
- Safety function with vented connections.
- High durability and easy handling.
- High air flow and increased productivity.
- Minimizes hose whip and injuries to operator.
- Long life time.
- Safety feature according to ISO-standard 4414 and EN 983.
- Main market: Benelux, France, Norway and North America.

#### Technical Data

Max flow capacity	43 l/s (0.5 bar ΔP)
Economical air flow	39 l/s (0.2 bar ΔP)
Max working pressure	16 bar
Temperature range	-20°C to +100°C

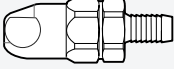
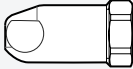

### ERGOQIC 10US, 27 L/S (recommended air flow at 6.3 bar pressure)

Connection type	Coupling ErgoQIC 10US	Ordering No.	Size		Connection type	Coupling ErgoQIC 10US	Ordering No.	Size	
			mm	in				mm	in
<b>H – Hose</b> 	H08	8202 1107 01	8	5/6	<b>F – Female</b> 	F08	8202 1107 13	1/4	BSP
	H10	8202 1107 02	10	3/8		F10	8202 1107 15	3/8	BSP
	H13	8202 1107 03	12.5	1/2		F15	8202 1107 17	1/2	BSP
	H20	8202 1107 05	19	3/4					
<b>M – Male thread</b> 	M08	8202 1107 07	1/4	BSP					
	M10	8202 1107 09	3/8	BSP					
	M15	8202 1107 11	1/2	BSP					

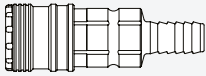
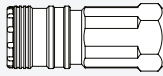
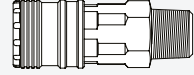
### SMARTQIC 10US, 39 L/S (recommended air flow at 6.3 bar pressure)

Connection type	Coupling SmartQIC 10US	Ordering No.	Size		Connection type	Coupling SmartQIC 10US	Ordering No.	Size	
			mm	in				mm	in
<b>H – Hose</b> 	H10	4221 0050 00	10	3/2	<b>F – Female</b> 	F10	4221 0050 06	3/8	BSP
	H13	4221 0050 01	13	1/2		F15	4221 0050 07	1/2	BSP
						F10	4221 0050 08	3/8	NPT
						F15	4221 0050 09	1/2	NPT
<b>M – Male</b> 	M10	4221 0050 02	3/8	BSPT					
	M15	4221 0050 03	1/2	BSPT					
	M10	4221 0050 04	3/8	NPT					
	M15	4221 0050 05	1/2	NPT					

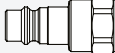
### NIP-10US, 39 L/S (recommended air flow at 6.3 bar pressure) FOR ERGOQIC 10US AND SMARTQIC 10US

Connection type	Nipple NIP 10US	Ordering No.	Size		Connection type	Nipple NIP 10US	Ordering No.	Size	
			mm	in				mm	in
<b>H – Hose</b> 	H08	4221 0051 00	8	5/16	<b>F – Female</b> 	F06	4221 0051 09	1/4	BSP
	H10	4221 0051 01	10	3/8		F10	4221 0051 10	3/8	BSP
	H13	4221 0051 02	13	1/2		F15	4221 0051 11	1/2	BSP
						F06	4221 0051 12	1/4	NPT
						F10	4221 0051 13	3/8	NPT
						F15	4221 0051 14	1/2	NPT
<b>M – Male thread</b> 	M06	4221 0051 03	1/4	BSPT					
	M10	4221 0051 04	3/8	BSPT					
	M15	4221 0051 05	1/2	BSP					
	M06	4221 0051 06	1/4	NPT					
	M10	4221 0051 07	3/8	NPT					
	M15	4221 0051 08	1/2	NPT					

**NOTE:** T at the end stands for tapered thread e.g. BSPT.



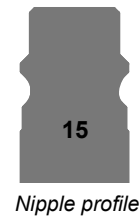
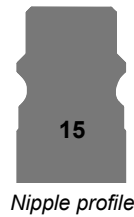

### ErgoQIC 15US

#### ISO 6150-B / US STANDARD

The ErgoQIC 15US is a full flow coupling with no air restriction inside the coupling suitable for large air consuming assembly tools, drills and grinders. Upgrading any air system with ErgoQIC 15US will give the benefit of productivity and energy efficiency. It is interchangeable with US 1/2" standard nipples.

- Extreme full flow coupling.
- Strong and durable.
- Minimized connection force.
- Safety feature according to EN 983 / ISO 4414.
- Main market: North America, France, Norway and Spain.

### Atlas Copco SmartQIC 15US

#### ISO 6150-B / US STANDARD

Safety coupling with venting connection, high flow and low pressure drop.

- High reliability with low pressure drop.
- Safety function with vented connection.
- High durability and easy handling.
- High air flow and increased productivity.
- Minimizes hose whip and injuries to operator.
- Long life time.
- Safety feature according to ISO-standard 4414 and EN 983.
- Main market: North America, France, Norway and Spain.

### Technical Data

Max flow capacity	77 l/s (0.5 bar ΔP)
Economical air flow	52 l/s (0.2 bar ΔP)
Max working pressure	16 bar
Temperature range	-20°C to +80°C

### Technical Data

Max flow capacity	69 l/s (0.5 bar ΔP)
Economical air flow	64 l/s (0.2 bar ΔP)
Max working pressure	16 bar
Temperature range	-20°C to +100°C

### ERGOQIC 15US, 52 L/S (recommended air flow at 6.3 bar pressure)

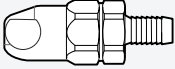
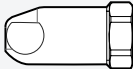
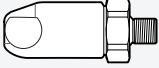
Connection type	Coupling ErgoQIC 15US	Ordering No.	Size		Connection type	Coupling ErgoQIC 15US	Ordering No.	Size	
			mm	in				mm	in
<b>H – Hose</b> 	H10	8202 1108 02	10	3/8	<b>F – Female</b> 	F10	8202 1108 15	3/8	BSP
	H13	8202 1108 03	12.5	1/2		F15	8202 1108 17	1/2	BSP
	H16	8202 1108 04	16	5/8					
	H20	8202 1108 05	19	3/4					
<b>M – Male thread</b> 	M10	8202 1108 09	3/8	BSP					
	M15	8202 1108 11	1/2	BSP					

### SMARTQIC 15US, 8 L/S (recommended air flow at 6.3 bar pressure)

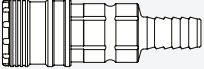
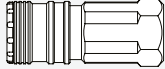
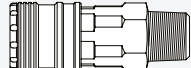
Connection type	Coupling SmartQIC 15US	Ordering No.	Size		Connection type	Coupling SmartQIC 15US	Ordering No.	Size	
			mm	in				mm	in
<b>H – Hose</b> 	H13	4221 0040 00	13	1/2	<b>F – Female</b> 	F10	4221 0040 06	3/8	NPT
	H20	4221 0040 02	19	3/4		F15	4221 0040 07	1/2	NPT
						F20	4221 0040 08	3/4	NPT
<b>M – Male</b> 	M10	4221 0040 03	3/8	NPT					
	M15	4221 0040 04	1/2	NPT					
	M20	4221 0040 05	3/4	NPT					

### NIP 15US, 52 L/S (recommended air flow at 6.3 bar pressure) FOR ERGOQIC 15US AND SMARTQIC 15US

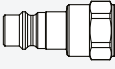
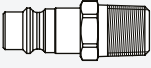
Connection type	Nipple NIP 15US	Ordering No.	Size		Connection type	Nipple NIP 15US	Ordering No.	Size	
			mm	in				mm	in
<b>H – Hose</b> 	H10	4221 0041 00	10	3/8	<b>F – Female</b> 	F10	4221 0041 07	3/8	NPT
	H13	4221 0041 01	13	1/2		F15	4221 0041 08	1/2	NPT
	H20	4221 0041 03	19	3/4		F20	4221 0041 09	3/4	NPT
<b>M – Male thread</b> 	M10	4221 0041 04	3/8	NPT					
	M15	4221 0041 05	1/2	NPT					
	M20	4221 0041 06	3/4	NPT					

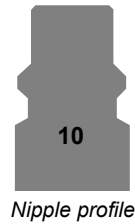

Nipple profile

## ErgoQIC 10AC

### ATLAS COPCO GLOBAL STANDARD

The ErgoQIC 10AC is a full flow quick coupling with no air restriction inside the coupling suitable for assembly tools, drills and small grinders. Upgrading any air system with ErgoQIC 10AC will give the benefit of productivity and energy efficiency.

- Full flow coupling.
- Ergonomic design, small size and low weight.
- Strong and durable.
- Safety feature according to EN 983 / ISO 4414.
- Main market: Nordic, Benelux and Italy.

### Technical Data

Max flow capacity	26 l/s (0.5 bar ΔP)
Economical air flow	17 l/s (0.2 bar ΔP)
Max working pressure	16 bar
Temperature range	-10°C to +70°C

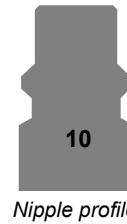

Nipple profile

## QIC 10

### ATLAS COPCO GLOBAL STANDARD

The QIC 10 is a small quick coupling suitable for assembly tools and drills. The QIC 10 can withstand extremely rough handling in tough applications.

- High flow coupling.
- Strong and durable.
- One-hand operation.
- Main market: Europe and Australia.

### Technical Data

Max flow capacity	24 l/s (0.5 bar ΔP)
Economical air flow	15 l/s (0.2 bar ΔP)
Max working pressure	16 bar
Temperature range	-20°C to +80°C

## Euro standard 15 mm



Nipple profile

## QIC 15

### EURO STANDARD 15 MM

The QIC 15 quick coupling is suitable for assembly tools, grinders and drills. The QIC 15 can withstand extremely rough handling in tough applications.

- Extremely high flow.
- Strong and durable.
- One-hand operation.
- Main market: Europe.

### Technical Data

Max flow capacity	48 l/s (0.5 bar ΔP)
Economical air flow	30 l/s (0.2 bar ΔP)
Max working pressure	10 bar
Temperature range	-20°C to +80°C

## ERGOQIC 10AC, 17 L/S (recommended air flow at 6.3 bar pressure)

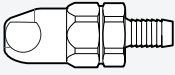
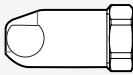
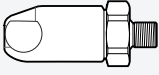

Connection type	Coupling ErgoQIC 10AC	Ordering No.	Size		Connection type	Coupling ErgoQIC 10AC	Ordering No.	Size	
			mm	in				mm	in
<b>H – Hose</b> 	H08	8202 1109 01	8	5/16	<b>F – Female</b> 	F08	8202 1109 09	1/4	BSP
	H10	8202 1109 02	10	3/8		F10	8202 1109 10	3/8	BSP
	H13	8202 1109 03	12.5	1/2		F15	8202 1109 11	1/2	BSP
<b>M – Male thread</b> 	M08	8202 1109 05	1/4	BSP					
	M10	8202 1109 06	3/8	BSP					
	M15	8202 1109 07	1/2	BSP					

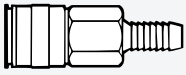
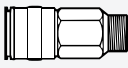
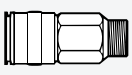
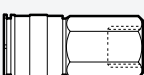
## QIC 10, 15 L/S (recommended air flow at 6.3 bar pressure)

Connection type	Coupling QIC 10	Ordering No.	Size		Connection type	Coupling QIC 10	Ordering No.	Size	
			mm	in				mm	in
<b>H – Hose</b> 	H06	8202 1302 02	6.3	1/4	<b>MT – Male taper thread</b> 	MT15	8202 1302 51	1/2	BSPT
	H08	8202 1302 10	8	5/16					
	H10	8202 1302 28	10	3/8					
	H13	8202 1302 34	12.5	1/2					
<b>M – Male thread</b> 	M08	8202 1302 36	1/4	BSP	<b>F – Female</b> 	F08	8202 1302 69	1/4	BSP
	M10	8202 1302 44	3/8	BSP					

<sup>a</sup> For hoses longer than 3 meters.

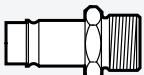
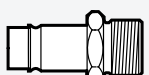
## NIP 10, 17 L/S (recommended air flow at 6.3 bar pressure) FOR ERGOQIC 10AC AND QIC 10

Connection type	Nipple NIP 10	Ordering No.	Size		Connection type	Nipple NIP 10	Ordering No.	Size	
			mm	in				mm	in
<b>H – Hose</b> 	H06	8202 1202 11	6.3	3/8	<b>MT – Male taper thread</b> 	MT08	8202 1202 60	1/4	BSPT
	H08	8202 1202 94	8	1/2		MT10	8202 1202 78	3/8	BSPT
	H10	8202 1202 29	10	5/8		MT15	8202 1203 02	1/2	BSPT
	H13	8202 1202 34	12.5	3/4					
<b>M – Male thread</b> 	M06	8202 1202 37	1/8	BSP	<b>F – Female</b> 	F08	8202 1202 86	1/4	BSP
	M08	8202 1202 45	1/4	BSP		F10	8202 1202 87	3/8	BSP
	M10	8202 1202 52	3/8	BSP					

## 15 mm

## QIC 15 AND NIP 15, 30 L/S (recommended air flow at 6.3 bar pressure)

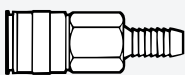
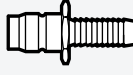
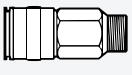
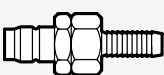
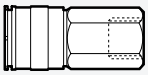
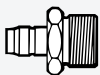
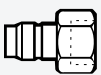
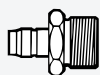
Connection type	Coupling QIC 15	Ordering No.	Size		Connection type	Nipple NIP 15	Ordering No.	Size	
			mm	in				mm	in
<b>H – Hose</b> 	H10	8202 1304 00	10	3/8	<b>H – Hose</b> 	H06	8202 1251 03	6.3	1/4
	H13	8202 1304 18	12.5	1/2		H08	8202 1252 28	8	5/16
	H16	8202 1304 26	16	5/8		H10	8202 1251 11	10	3/8
<b>M – Male thread</b> 	M08	8202 1304 34	1/4	BSP	<b>SH – Safety Hose <sup>a</sup></b> 	SH10	8202 1203 44	10	3/8
	M10	8202 1304 42	3/8	BSP		SH16	8202 1203 69	16	5/8
	M15	8202 1304 59	1/2	BSP					
<b>F – Female thread</b> 	F15	8202 1304 67	1/2	BSP	<b>M – Male thread /</b> 	M10	8202 1251 45	3/8	BSP
						M15	8202 1251 52	1/2	BSP
<b>F – Female thread</b> 	F08	8202 1251 94	1/4	BSP	<b>MT – Male taper thread</b> 	MT08	8202 1251 60	1/4	BSPT
	F10	8202 1252 02	3/8	BSP		MT10	8202 1251 78	3/8	BSPT
	F15	8202 1252 10	1/2	BSP		MT15	8202 1251 86	1/2	BSPT

<sup>a</sup> For hoses longer than 3 meters.

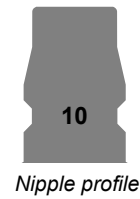
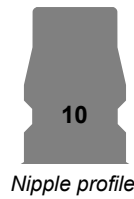

## ErgoQIC 10A

### ASIA STANDARD 7.5 MM

The ErgoQIC 10 ASIA is a full flow coupling with no air restriction inside the coupling. It is suitable for assembly tools, drills and grinders. Upgrading any air system with ErgoQIC 10 ASIA will give the benefits of productivity and energy efficiency.

- Extreme full flow coupling.
- Strong and durable.
- Minimized connection force.
- Safety feature according to EN 983 / ISO 4414.
- Main market: Asia, Australia, Italy and South America.

## Atlas Copco SmartQIC 10A

### ASIA STANDARD 7.5 MM

Safety coupling with venting connection, high flow and low pressure drop.

- High reliability with low pressure drop.
- Safety function with vented connection.
- High durability and easy handling.
- High air flow and increased productivity.
- Minimizes hose whip and injuries to operator.
- Long life time.
- Safety feature according to ISO-standard 4414 and EN 983.
- Main market: Asia, Australia, Italy and South America.

## Technical Data

Max flow capacity	35 l/s (0.5 bar ΔP)
Economical air flow	22 l/s (0.2 bar ΔP)
Max working pressure	16 bar
Temperature range	-10°C to +70°C

## Technical Data

Max flow capacity	33 l/s (0.5 bar ΔP)
Economical air flow	32 l/s (0.2 bar ΔP)
Max working pressure	16 bar
Temperature range	-20°C to +100°C



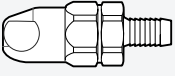
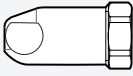
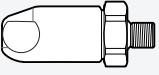

## ERGOQIC 10A, 22 L/S (recommended air flow at 6.3 bar pressure)

Connection type	Coupling ErgoQIC 10A	Ordering No.	Size		Connection type	Coupling ErgoQIC 10A	Ordering No.	Size	
			mm	in				mm	in
<b>H – Hose</b> 	H06	8202 1104 00	6.3	1/4	<b>FT – Female taper thread</b> 	FT08	8202 1104 09	1/4	BSPT
	H08	8202 1104 01	8	5/16		FT10	8202 1104 10	3/8	BSPT
	H10	8202 1104 02	10	3/8		FT15	8202 1104 11	1/2	BSPT
	H13	8202 1104 03	12.5	1/2					
<b>MT – Male taper thread</b> 	MT08	8202 1104 05	1/4	BSPT					
	MT10	8202 1104 06	3/8	BSPT					
	MT15	8202 1104 07	1/2	BSPT					

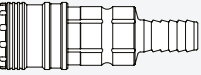
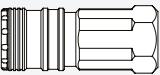
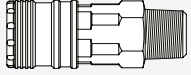
## SMARTQIC 10A, 32 L/S (recommended air flow at 6.3 bar pressure)

Connection type	Coupling SmartQIC 10A	Ordering No.	Size		Connection type	Coupling SmartQIC 10A	Ordering No.	Size	
			mm	in				mm	in
<b>H – Hose</b> 	H06	4221 0060 00	6.3	1/4	<b>F – Female thread</b> 	F06	4221 0060 06	1/4	BSP
	H08	4221 0060 01	7	9/32		F10	4221 0060 07	3/8	BSP
	H10	4221 0060 02	10	3/8		F15	4221 0060 08	1/2	BSP
<b>M – Male thread</b> 	M06	4221 0060 03*	1/4	BSP					
	M10	4221 0060 04*	3/8	BSP					
	M15	4221 0060 05*	1/2	BSP					

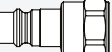
## NIP 10A, 22 L/S (recommended air flow at 6.3 bar pressure) FOR ERGOQIC 10A AND SMARTQIC 10A

Connection type	Nipple NIP 10A	Ordering No.	Size		Connection type	Nipple NIP 10A	Ordering No.	Size	
			mm	in				mm	in
<b>H – Hose</b> 	H06	4221 0061 00	6.3	1/4	<b>F – Female</b> 	F06	4221 0061 07	1/4	BSPT
	H08	4221 0061 01	7	9/32		F10	4221 0061 08	3/8	BSPT
	H10	4221 0061 02	10	3/8		F15	4221 0061 09	1/2	BSPT
	H13	4221 0061 03	12.5	1/2					
<b>M – Male thread</b> 	M04	4221 0002 83	1/8	BSPT					
	M06	4221 0061 04	1/4	BSPT					
	M10	4221 0061 05	3/8	BSPT					
	M15	4221 0061 06	1/2	BSPT					

\* Preapplied sealent.



**NOTE:** T at the end stands for tapered thread e.g. BSPT.

CLAW couplings are made from drop-forged, hardened steel which can withstand rough treatment and ensures a long life even under difficult conditions. The coupling head is the same for all sizes, which can therefore be freely combined.

The recommended maximum working pressure is 10 bar.

- Large bore – machined surfaces give low air resistance and minimum pressure drop.
- Robust claws – will withstand rough handling without deformation.
- Locking lugs – precision-made to provide a reliable lock.
- Special rubber packings – resistant to oil and temperature changes. Max. temperature 80°C (176°F).
- Packing seats – lathe-turned grooves ensure a leak-proof seal.
- Couplings are zinc-plated and thus effectively treated against corrosion.
- Available with extra protective cover.

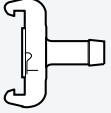
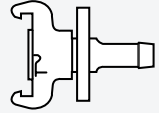
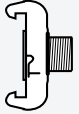
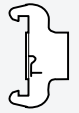
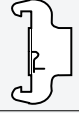

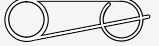
Connection type	Coupling CLAW	Ordering No.	Size		Bore B, mm
			mm	in	
<b>H – Hose</b> 	H06	9000 0308 00	6.3	1/4	5.0
	H10	9000 0309 00	10	3/8	8.0
	H13	9000 0310 00	12.5	1/2	10.5
	H16	9000 0311 00	16	5/8	13.5
	H20	9000 0312 00	19	3/4	17.0
	H25	9000 0313 00	25	1	22.0
<b>LNH – Lock nut, Hose</b> 	LNH10	9000 0260 00	10	3/8	8.0
	LNH13	9000 0261 00	12.5	1/2	10.5
	LNH16	9000 0262 00	16	5/8	13.5
	LNH20	9000 0263 00	19	3/4	17.2
	LNH25	9000 0264 00	25	1	22.0
<b>M – Male thread</b> 	M10	9000 0300 00		3/8 BSP	11.2
	M15	9000 0301 00		1/2 BSP	14.8
	M20	9000 0302 00		3/4 BSP	19.0
	M25	9000 0303 00		1 BSP	25.5
<b>F – Female thread</b> 	F10	9000 0304 00		3/8 BSP	15.0
	F15	9000 0305 00		1/2 BSP	18.6
	F20	9000 0306 00		3/4 BSP	24.0
	F25	9000 0307 00		1 BSP	25.0
Protection cover for CLAW couplings		9000 0314 00			
Extra packing for CLAW couplings		For type H, M and F For LNH10, -13 and -16 For LNH20 and -25	9000 0000 00 (+80°C), 9000 0000 01 (+200°C) <sup>a</sup> 9000 0015 00 9000 0268 00 (+80°C), 9000 0319 00 (+200°C) <sup>a</sup>		
Safety lock spring		3176 8640 90	25 pieces		

<sup>a</sup> Viton-green.

## BAL AND BAL-1A

The Atlas Copco valves BAL and BAL-1A are both suitable for air, water and many other liquids and gases due to the choice of material.

- Silicone-free grease – Both are lubricated with silicone-free grease which is important when spray-painting.
- Maximum through flow – Full bore valve to DIN standards.
- Housing and ball made of chrome-plated hot-stamped brass MS 58.
- Handle of enamelled aluminum.

## BAL – WITH NITRILE RUBBER SEALS

BAL valves can be used in all settings between fully open and fully closed.

The balls and the seals can be replaced without the body being removed from the piping.

## BAL-1A – WITH TEFLON SEALS

Intended for operating either fully open or fully closed.



## Technical data

### BAL

Maximum working pressure: 16 bar.

Working temperature range: -20°C to +90°C.

### BAL-1A

Maximum working pressure: 16 bar (BAL-1A 40 and 50: max. 16 bar up to +100°C).

Working temperature range: -30°C to +200°C. (BAL-1A 40 and 50: at +200°C max. working pressure is reduced to 8 bar).

Model	Connection thread in BSP	Bore D mm	L mm	H mm	I mm	Ordering No.
BAL 08	1/4	9.5	50	41	-	8202 0301 05
BAL 10	3/8	9.5	50	41	-	8202 0302 04
BAL 15	1/2	12.5	60	43	-	8202 0303 03
BAL 20	3/4	19	75	55	-	8202 0304 02
BAL 25	1	24.5	90	64	-	8202 0305 01
BAL-1A 08	1/4	8	43	44	73	8202 0306 03
BAL-1A 10	3/8	10	50	47	73	8202 0306 11
BAL-1A 15	1/2	15	61	53	94	8202 0306 29
BAL-1A 20	3/4	20	70	57	94	8202 0306 37
BAL-1A 25	1	25	83	67.5	122	8202 0306 45
BAL-1A 32	1 1/4	32	100	83	150	8202 0306 52
BAL-1A 40	1 1/2	38	107	87	150	8202 0306 60
BAL-1A 50	2	50	129	103	193	8202 0306 78

## Dimensions

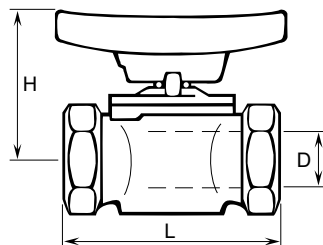

BAL

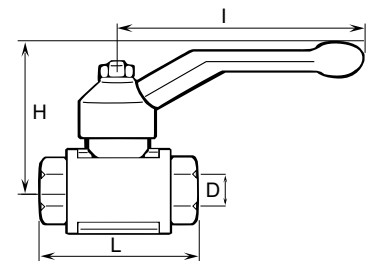

BAL-1A

**MULTIFLEX SWIVEL  
MULTI-DIRECTIONAL CONNECTOR**

The MultiFlex swivel is an ingenious multi-directional connector. Connect your tool and the hose will stay in the ideal position however much you and the tool move around. The MultiFlex bends and rotates 360° in all directions while the hose stays straight. It takes the effort out of working in those cramped spaces. What's more, the hose feels almost weightless and it reduces hose wear. It's the magic of MultiFlex – a marriage of ergonomic thinking and ingenious design.



- Ergonomic.
- Reduces hose wear.
- High flow capacity.
- Minimum pressure drop.
- Strong and durable.
- Available with rubber (EPDM) protective cover.
- Fits most pneumatic tools.

Model	Max rec. air flow <sup>a</sup> l/s cfm		Thread		Weight g	Length mm	Dia mm	Ordering No.
			Inlet female in	Outlet male in				
<b>Standard</b>								
MultiFlex 1/8" BSP	12	25	1/8	1/8	73	66.2	24	8202 1350 18
MultiFlex 1/4" BSP	12	25	1/4	1/4	73	66.2	24	8202 1350 20
MultiFlex 3/8" BSP	32	68	3/8	3/8	130	80.6	29.5	8202 1350 22
MultiFlex 1/2" BSP	32	68	1/2	1/2	125	80.6	29.5	8202 1350 24
<b>Protective rubber cover</b>								
MultiFlex 1/8" BSP	12	25	1/8	1/8	76	66.2	27	8202 1350 40
MultiFlex 1/4" BSP	12	25	1/4	1/4	76	66.2	27	8202 1350 41
MultiFlex 3/8" BSP	32	68	3/8	3/8	130	80.6	29.5	8202 1350 42
<b>High air flow</b>								
MultiFlex 1/2" BSP	54	114	1/2	1/2	326	98.3	39	8202 1350 60
<b>Female to male thread</b>								
FBSP 1/4" - MBSP 1/8"	12	25	1/4	1/8	73	66.2	24	8202 1350 67

The pressure drop will be 0.2 bar at an inlet pressure of 6 bar.



## SIMPLE PRESSURE CLAMPS FOR PVC HOSES

For CABLAIR	For PVC	One-lugged steel clamp mm	Ordering No.
–	–	5.2- 6.2	0347 0122 18
–	–	5.9- 7.0	0347 0122 19
–	03	7.0- 8.5	0347 0122 05
06	05	8.5-10.0	0347 0122 06
08	06	9.8-11.8	0347 0122 07
–	08	11.3-13.3	0347 0122 08
10	–	12.8-14.8	0347 0122 09
–	10	14.6-16.8	0347 0122 10
13	–	16.5-18.8	0347 0122 11
–	13	18.0-20.3	0347 0122 12
16	–	20.2-22.8	0347 0122 13
–	–	22.0-24.8	0347 0122 14
20	–	23.3-26.3	0347 0122 15
–	–	26.5-30.0	0347 0122 16
25	–	29.8-33.1	0347 0122 22



## MEDIUM PRESSURE CLAMPS FOR PVC HOSES

For CABLAIR	For PVC, POLUR	Medium clamp worm drive mm	Ordering No.
–	–	8.0-14.0	0347 6102 00
–	08	11.0-17.0	0347 6103 00
–	10	11.0-17.0	0347 6103 00
–	–	13.0-20.0	0347 6104 00
16	13	15.0-24.0	0347 6105 00
20	16	19.0-28.0	0347 6106 00
–	20	22.0-32.0	0347 6107 00
25	25	26.0-38.0	0347 6109 00
–	–	32.0-44.0	0347 6111 00
–	–	38.0-50.0	0347 6112 00
–	–	50.0-65.0	0347 6113 00



## MEDIUM PRESSURE CLAMPS FOR RUBBER HOSES

For TURBO	For RUBAIR	Medium clamp worm drive mm	Ordering No.
–	06	11.0-17.0	0347 6103 00
13	10	13.0-20.0	0347 6104 00
16	13	15.0-24.0	0347 6105 00
–	16	19.0-28.0	0347 6106 00
20	–	22.0-32.0	0347 6107 00
–	20	26.0-38.0	0347 6109 00



## HEAVY-DUTY PRESSURE CLAMPS FOR RUBBER HOSES

For TURBO	For RUBAIR	Heavy-duty clamp mm	Ordering No.
–	–	22.0-25.0	9000 0194 00
20	16	25.0-28.0	9000 0195 00
–	20	29.0-32.0	9000 0196 00
–	25	34.0-38.0	9000 0197 00



## HOSE CONNECTION

Male thread – hose nipple

Thread in	Hose size		Ordering No.
	mm	in	
1/8 BSP	3.2	1/8	9000 0523 00
1/8 BSPT	5	3/16	4010 0031 00
1/8 BSPT	6.3	1/4	9000 0240 00
1/4 BSP	3.2	1/8	9000 0524 00
1/4 BSPT	6.3	1/4	9000 0241 00
1/4 BSPT	8	5/16	9090 1715 00
1/4 BSPT	10	3/8	9000 0247 00
3/8 BSPT	10	3/8	9000 0242 00
3/8 BSPT	12.5	1/2	9000 0248 00
1/2 BSPT	12.5	1/2	9000 0243 00
1/2 BSPT	16	5/8	9000 0244 00
1/2 BSP	20	3/4	4150 0429 00
3/4 BSPT	20	3/4	9000 0245 00
1 BSPT	25	1	9000 0246 00



## GASKETS

For couplings with male parallel thread	Fiber gasket between material and nipple Ordering No.
1/8 BSP	0657 5742 00
1/4 BSP	0657 5764 00
3/8 BSP	0657 5785 00
1/2 BSP	0653 0500 01
3/4 BSP	0657 5823 00
1 BSP	0657 5830 00



## REDUCING NIPPLE IN BRASS

Female thread in	Male thread in	Ordering No.
1/4 BSP	1/8 BSP	9721 4000 94
3/8 BSP	1/4 BSP	9721 4000 92
1/2 BSP	3/8 BSP	9721 4000 93



## SWIVELS

Air inlet	Air outlet Male BSP	Max Swivel bend from centre line	Ordering No.
5/16" hose	1/4	30°	4210 3134 80

Recommended flow max 10 l/s



# Fittings

## BUSHING

Male thread – female thread



Male thread in	Female thread in	Ordering No.
1/4 BSP	1/8 BSP	9090 0799 00
3/8 BSP	1/4 BSP	9090 0798 00
1/2 BSP	1/4 BSP	9090 1469 00
1/2 BSP	3/8 BSP	9090 0797 00
3/4 BSP	1/2 BSP	9090 0796 00
1 BSPT	3/4 BSP	9090 0795 00

## DOUBLE CONNECTION

Male taper thread – male taper thread



From thread in	To thread in	Ordering No.
1/8 BSPT	1/8 BSPT	9090 0100 00
1/8 BSPT	1/4 BSPT	9090 0110 00
1/4 BSPT	1/4 BSPT	9090 0120 00
1/4 BSPT	3/8 BSPT	9090 0130 00
3/8 BSPT	3/8 BSPT	9090 0140 00
3/8 BSPT	1/2 BSPT	9090 0150 00
1/2 BSPT	1/2 BSPT	9090 0160 00
1/2 BSPT	3/4 BSPT	9090 0170 00
3/4 BSPT	3/4 BSPT	9090 0180 00
3/4 BSPT	1 BSPT	9090 0190 00
1 BSPT	1 BSPT	9090 0200 00

## DOUBLE ADJUSTABLE CONNECTION

Male thread – male thread



From thread in	To thread in	Ordering No.
1/2 BSP	1/2 BSP	9090 0806 00

## SEALING RINGS FOR DOUBLE ADJUSTABLE CONNECTION



For coupling with male thread in	Spare rubber sealing ring for adjustable connections Ordering No.
1/2 BSP	9090 0884 00
1 BSP	9090 0886 00

## HOSE CONNECTION WITH CLAMP NUT AND SPRING GUARD



### 1 Clamp nut, brass

Hose diameter Outside/Inside mm	Male thread in	Ordering No.
10/8	1/4 BSP	9721 4002 89
12/10	3/8 BSP	9721 4000 88
15/12.5	1/2 BSP	9721 4000 89

Male threaded hose nipple with clamp nut should be used with female threaded quick couplings.

### 2 Spring guard in steel

Hose diameter Outside/Inside mm	Ordering No.
10/8	9721 4002 88
12/10	9721 4000 91
15/12	9721 4002 85

The spring guard should be used with the clamp nut above.

## MANIFOLDS

3/8 inlet on each side, 1/4 outlets for couplings



Inlet in	Thread		Number of outlets	Ordering No.
	Inlet in	Outlet in		
3/8 BSP	1/4 BSP	1/4 BSP	4	9090 0201 00
3/8 BSP	1/4 BSP	1/4 BSP	5	9090 0201 01
3/8 BSP	1/4 BSP	1/4 BSP	6	9090 0201 02

## MANIFOLDS

3/8 inlet on each side, 1/4 outlet on both sides for couplings



Inlet in	Thread		Number of outlets	Ordering No.
	Inlet in	Outlet in		
3/8 BSP	1/4 BSP	1/4 BSP	4	9090 0201 10
3/8 BSP	1/4 BSP	1/4 BSP	6	9090 0201 11
3/8 BSP	1/4 BSP	1/4 BSP	8	9090 0201 12
3/8 BSP	1/4 BSP	1/4 BSP	10	9090 0201 13



## Y-CONNECTIONS

2 female outlets and 1 male inlet

Model	Female thread in	Male thread in	Ordering No.
F/F/M08	1/4 BSP	1/4 BSP	9090 0201 86
F/F/M10	3/8 BSP	3/8 BSP	9090 0201 87
F/F/M15	1/2 BSP	1/2 BSP	9090 0201 85



## PIPE TEE

Model	Female threads in	Ordering No.
F08	1/4 BSP	9090 0201 51
F10	3/8 BSP	9090 0201 53
F15	1/2 BSP	9090 0201 50
F20	3/4 BSP	9090 0201 52
F25	1 BSP	9090 0201 54



## PIPE CROSS

Model	Female thread in	Ordering No.
F08	1/4 BSP	9090 0201 21
F10	3/8 BSP	9090 0201 22
F15	1/2 BSP	9090 0201 20



## BRANCH TEE

2 female outlets and 1 male inlet

Model	Female thread in	Male thread in	Ordering No.
2xF08 1xM08	1/4 BSP	1/4 BSP	9090 0201 61
2xF10 1xM10	3/8 BSP	3/8 BSP	9090 0201 63
2xF15 1xM15	1/2 BSP	1/2 BSP	9090 0201 60
2xF20 1xM20	3/4 BSP	3/4 BSP	9090 0201 62
2xF25 1xM25	1 BSP	1 BSP	9090 0201 64



## CROSS

3 female threads and 1 male thread

Model	Female thread in	Male thread in	Ordering No.
3xF08 1xM08	1/4 BSP	1/4 BSP	9090 0201 31
3xF10 1xM10	3/8 BSP	3/8 BSP	9090 0201 32
3xF15 1xM15	1/2 BSP	1/2 BSP	9090 0201 30



## RUN TEE

2 female outlets and 1 male inlet

Model	Female thread in	Male thread in	Ordering No.
F08/M08/F08	1/4 BSP	1/4 BSP	9090 0201 71
F10/M10/F10	3/8 BSP	3/8 BSP	9090 0201 72
F15/M15/F15	1/2 BSP	1/2 BSP	9090 0201 70



## PIPE ELBOW

Model	Female thread in	Ordering No.
F08	1/4 BSP	9090 0201 40
F10	3/8 BSP	9090 0201 43
F15	1/2 BSP	9090 0201 41
F20	3/4 BSP	9090 0201 42
F25	1 BSP	9090 0201 44



## HEX HEAD PLUG

Model	Male thread in	Ordering No.
M08	1/4 BSP	9090 0201 81
M10	3/8 BSP	9090 0201 84
M15	1/2 BSP	9090 0201 80
M20	3/4 BSP	9090 0201 83
M25	1 BSP	9090 0201 82

## Pressure drop diagram for straight hoses

This diagram helps you to choose the right hose according to the air consumption of the tool and the length of the hose. The purpose of the diagram is to ensure that the pressure drop in the hoses does not exceed 0.2 bar.

### HOW TO READ THE DIAGRAM:

Look up the tools required air consumption at 6 bar.

Use this value in the diagram .

What length of hose do you need?

Look at the diagram to see which hose size you need.

Decide which type of hose you need, Atlas Copco Tools has seven different hoses covering all types of needs for pneumatic hand tools.

### EXAMPLE

The tool has an air consumption of 10 l/s and the application requires a hose length of 7 m. These two values have a cross point slightly under the 10 mm size hose (7 m of 10 mm hose gives a value of approximately 11 l/s).

Therefore a 10 mm hose will be suitable.

### PRESSURE DROP DIAGRAM FOR HOSES

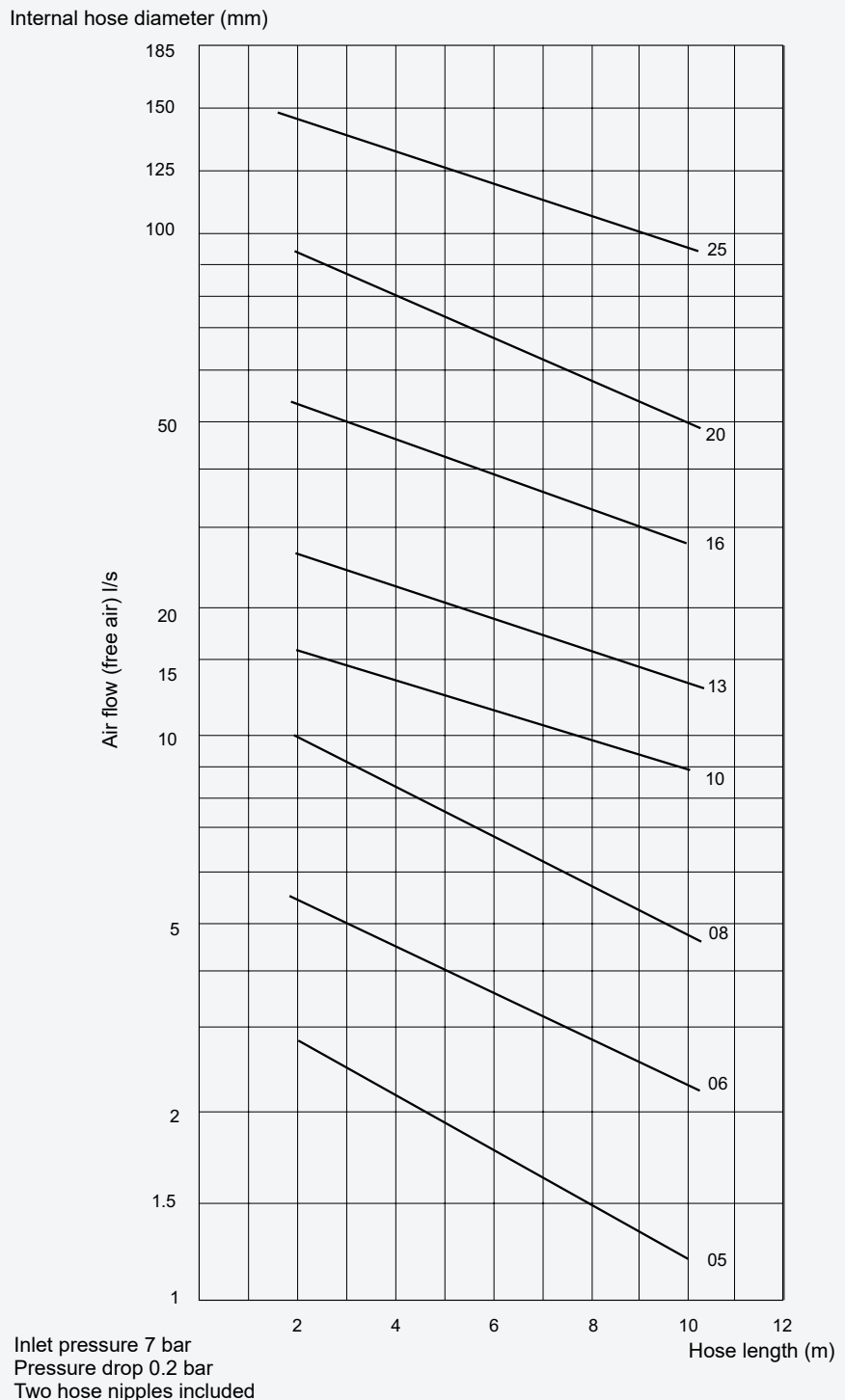

## CABLAIR HOSES

### SUPER-LIGHT FLEXIBLE PVC-HOSE

Cablair is made of high-strength, high performance PVC compound. The Cablair hose weighs 30-50% less and is much softer and more flexible than conventional PVC hoses. This ensures complete freedom of movement for operators of pneumatic hand tools.

- Low weight.
- Extremely soft and flexible.
- Silicone free.
- Ergonomic.
- Working temperature -15°C to +60°C.



Model	Hose inside dia		Hose outside dia mm	Max working pressure <sup>a</sup> bar	Max rec. air flow <sup>b</sup> l/s	Weight per 30 m coil kg	Ordering No.
	mm	in					
CABLAIR 06	6	1/4	8.5	14	4	1.2	9093 0035 11
CABLAIR 08	8	1/3	11	14	7.5	1.7	9093 0035 41
CABLAIR 10	10	2/5	13	12	13	2.1	9093 0035 71
CABLAIR 13	12.5	1/2	16	11	21	3.0	9093 0036 01
CABLAIR 16	16	5/8	21	8	43	5.4	9093 0036 31
CABLAIR 20	19	3/4	24	8	75	5.8	9093 0036 61
CABLAIR 25	25	1	31.5	7	125	10.4	9093 0036 91

<sup>a</sup> With a safety factor of 3 at 20°C (at the max temp of +60°C the working pressure should be reduced by 50%).

<sup>b</sup> The pressure drop will be 0.2 bar on a hose length of 5 m.

## CABLAIR ESD

### EXTRA FLEXIBLE ANTISTATIC AIR HOSE

Cablair ESD is designed specifically for use within the computer manufacturing industry. The hose possesses properties which enable ESDS (electrostatic sensitive devices) to be handled in a protected area with a low risk level, as a result of electrostatic discharge. In addition to a known demand in the computer industry, it is expected that potential exists in the electronics, radio and communication fields. The connection device must be earthed/grounded.

- Extra flexible.
- Antistatic.
- Silicone free.
- Testing in accordance with BS2050:1978 (1998) 4.12.
- Working temperature -15°C to +60°C.



Model	Hose inside dia		Hose outside dia		Max working pressure <sup>a</sup> bar	Max rec. air flow l/s	Weight per 30 m coil kg	Ordering No.
	mm	in	mm	in				
CABLAIR ESD 06	6	1/4	11	7/16	10	4	2.34	8202 0501 06
CABLAIR ESD 08	8	5/16	12	1/2	9	7.5	2.56	8202 0501 08
CABLAIR ESD 10	10	3/8	14	9/16	8	13	2.71	8202 0501 10
CABLAIR ESD 13	13	1/2	18	23/32	7	21	4.41	8202 0501 13

<sup>a</sup> With a safety factor of 3 at 20°C (at the max temp of +60°C the working pressure should be reduced by 50%).

## PVC HOSES

### STRONG PVC HOSE FOR HEAVY-DUTY APPLICATIONS

PVC hose has high resistance to abrasion, which makes it the ideal hose for tough working environments such as workshops, factories, garages, etc. It is mainly recommended for indoor use.

- Long service life.
- Pliable.
- Transparent.
- Working temperature -15°C to +60°C.



Model	Hose inside dia		Hose outside dia mm	Max working pressure <sup>a</sup> bar	Max rec. air flow <sup>b</sup> l/s	Weight per 30 m coil kg	Ordering No.
	mm	in					
PVC 03	3.2	1/8	7	20	0.7	1.4	9093 0037 21
PVC 05	5	3/16	9	10	2.1	1.9	9093 0037 51
PVC 06	6.3	1/4	11	10	4	2.5	9093 0037 81
PVC 08	8	5/16	12	10	7.5	2.9	9093 0038 11
PVC 10	10	3/8	14	14	13	3.7	9093 0038 41
PVC 13	12.5	1/2	18	13	21	5.9	9093 0038 71
PVC 16	16	5/8	22	12	43	7.2	9093 0039 01
PVC 20	19	3/4	25	10	75	8.3	9093 0039 31
PVC 25	25	1	32	10	125	12.5	9093 0039 61

<sup>a</sup> With a safety factor of 3 at 20°C (at the max temp of +60°C the working pressure should be reduced by 50%).

<sup>b</sup> The pressure drop will be 0.2 bar on a hose length of 5 m.

## POLUR

### HIGH RESISTANT POLYURETHANE HOSE

Polur hose is the most environmentally friendly solution. It has high resistance to abrasion and it is oil resistant. Polur hose has a much longer lifetime than PVC hoses. Polur is ideal in tough working conditions such as workshops, factories, garages, shipyards and construction sites due to its flexibility, even at minus degrees. Polur is recommended for indoor and outdoor use.

- Oil resistant.
- Flexible.
- Long service life.
- Working temperature -30°C to +60°C.



Model	Hose inside dia		Hose outside dia mm	Max working pressure <sup>a</sup> bar	Max rec. air flow <sup>b</sup> l/s	Weight per 25 m coil kg	Ordering No.
	mm	in					
POLUR 08	8	5/16	12	20	7.5	2.2	8202 0601 08
POLUR 10	10	3/8	14	16	13	2.5	8202 0602 10
POLUR 13	13	1/2	18	13	21	4.0	8202 0603 13

<sup>a</sup> With a safety factor of 3 at 20°C (at the max temp of +60°C the working pressure should be reduced by 50%).

<sup>b</sup> The pressure drop will be 0.2 bar on a hose length of 5 m, including 2 nipples and at an inlet pressure of 7 bar.



## TURBO

### SUPER-LIGHT FLEXIBLE RUBBER HOSE

Turbo hose has been developed for flexible use both indoor and outdoor. The hose weighs 30-40% less than conventional rubber hoses, making it ideal for foundries, shipyards, engineering workshops and construction sites. Turbo hose is oil resistant.

- Extremely low weight.
- Soft and flexible.
- Antistatic.
- Grinding and welding spatter resistant.
- Working temperature -30°C to +70°C.



Model	Hose inside dia		Hose outside dia mm	Max working pressure <sup>a</sup> bar	Max rec. air flow <sup>b</sup> l/s	Weight per		Ordering No.
	mm	in				20 m coil kg	30 m coil kg	
TURBO 13	13	1/2	19	20	21	3.9	–	9093 0057 91
TURBO 13	13	1/2	19	20	21	–	5.9	9093 0057 93
TURBO 16	16.8	2/3	22.8	20	43	4.8	–	9093 0057 31
TURBO 16	16.8	2/3	22.8	20	43	–	7.2	9093 0057 33
TURBO 20	21	5/6	27	20	75	5.4	–	9093 0057 61
TURBO 20	21	5/6	27	20	75	–	8.1	9093 0057 62

<sup>a</sup> With a safety factor of 3 at 20°C.

<sup>b</sup> The pressure drop will be 0.2 bar on a hose length of 5 m, including 2 nipples and at an inlet pressure of 7 bar.

## RUBBER

### DURABLE REINFORCED EXTRA THICK HEAVY DUTY RUBBER HOSE

The hose withstands rough handling and is suitable for the most demanding tasks in construction, mining, shipyards, foundries etc. The inner lining is black EPDM rubber, conductive to dissipate static electricity. Reinforcement with high tensile strength made of syntetic textile yarns.

- Durable.
- Antistatic.
- Grinding and welding spatter resistant.
- Working temperature -25°C to +70°C.



Model	Hose inside dia		Hose outside dia mm	Max working pressure <sup>a</sup> bar	Max rec. air flow <sup>b</sup> l/s	Length m	Weight kg	Ordering No.
	mm	in						
RUBBER	6.3	1/4	12	16	4	30	3.5	9030 2036 00
RUBBER	10	3/8	17	16	13	30	6.9	9030 2037 00
RUBBER	12.5	1/2	22	16	21	30	12.3	9030 2038 00
RUBBER	16	5/8	25	16	43	30	13.9	9030 2039 00
RUBBER	20	3/4	30	16	75	30	19.3	9030 2040 00
RUBBER	20	3/4	30	16	75	20	12.9	9030 2040 03
RUBBER	25	1	36	16	125	30	24.0	9030 2041 00
RUBBER	25	1	36	16	125	20	16.0	9030 2041 03

<sup>a</sup> With a safety factor of 5 at 20°C.

<sup>b</sup> The pressure drop will be 0.2 bar on a hose length of 5 m, including 2 nipples and at an inlet pressure of 7 bar.

## RUBAIR

### DURABLE REINFORCED HEAVY DUTY RUBBER HOSE

Rubair hose is double reinforced to fulfil all general heavy duty demands and is recommended for indoor and outdoor use. Rubair hose is oil resistant.

- Durable.
- Antistatic.
- Grinding and welding spatter resistant.
- Working temperature -20°C to +80°C.



Model	Hose inside dia		Hose outside dia mm	Max working pressure <sup>a</sup> bar	Max rec. air flow <sup>b</sup> l/s	Weight per 20 m coil kg	Ordering No.
	mm	in					
RUBAIR 10	10	3/8	16.0	16	13	3.6	8202 0402 10
RUBAIR 13	12.5	1/2	19.1	16	21	4.7	8202 0403 13
RUBAIR 16	16	5/8	23.0	16	43	6.1	8202 0404 16
RUBAIR 20	20	3/4	26.6	16	75	7.8	8202 0405 20

<sup>a</sup> With a safety factor of 5 at 20°C.

<sup>b</sup> The pressure drop will be 0.2 bar on a hose length of 5 m, including 2 nipples and at an inlet pressure of 7 bar.

## SPI

### ELASTIC HOSE FOR VERTICAL AND HORIZONTAL APPLICATIONS

SPI elastic spiral hose is ideal for air tools used at varying distances from a fixed air outlet. It is easily stretched and retracts immediately when released. When used with hand tools, its self-storage principle ensures that the hose is kept off the floor and out of the way of the operator. The SPI 1 and SPI 2 have ball bearing swivels fitted on the long hose side to allow 360° rotation. All spiral hoses, except the SPI4, are fitted with plastic spring guard. SPI is the ideal hose in combination with a balancer.

- Self-retractable.
- Light and flexible.
- Strong and durable.
- Tubing material: Polyurethane (100% PUR).
- Hardness: Shore A 98 +2.
- Colour: Blue.
- Working pressure: 8 bar at 23°C.
- Burst pressure: 25 bar at 23°C.
- Temperature range: -40°C to +70°C.



Model	Hose inside dia mm	Hose outside dia mm	Max. rec. air flow <sup>a</sup> l/s	Working range m	Length			Max spiral dia mm (D)	Male threads in BSP	Ordering No.
					(A) mm	(B) mm	(C) mm			
SPI 1SPSW-S	6.5	10	7	2	500	165	150	55	1/4	8202 0508 71
SPI 1SPSW-M	6.5	10	5	4	500	330	150	55	1/4	8202 0508 73
SPI 2SPSW-S	8	12	13	2	500	130	150	70	3/8	8202 0508 75
SPI 2SPSW-M	8	12	10	4	500	270	150	70	3/8	8202 0508 77
SPI 2SPSW-L	8	12	9	6	500	435	150	70	3/8	8202 0508 79
SPI 2SPSW-XL	8	12	6	8	500	600	150	70	3/8	8202 0508 81
SPI 3SP-S	11	16	25	2	500	135	150	98	3/8	8202 0508 82
SPI 3SP-M	11	16	22	4	500	260	150	98	3/8	8202 0508 84
SPI 3SP-L	11	16	17	6	500	390	150	98	3/8	8202 0508 86
SPI 3SP-XL	11	16	13	8	500	550	150	98	3/8	8202 0508 88
SPI 4SP-XXL	13	19	21	10	500	850	500	115	3/8	8202 0508 90

<sup>a</sup> At inlet pressure 6 bar and pressure drop 0.5 bar.

## Dimensions

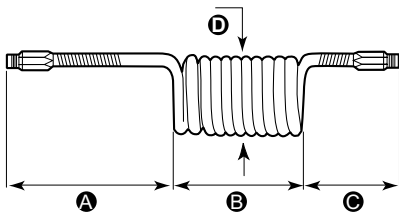

# Productivity Kits

Productivity kits boost productivity, extend tool lifetime and ensure minimum pressure drop.

Each productivity kit includes ball valve, air preparation unit, and the couplings, hose and nipples needed for correct and safe installation of the tool.

Just choose the correct productivity kit based on the air flow requirement of the tool and whether the tool needs lubrication or not. You'll be surprised how much the productivity kit improves the performance of the tool.

- Improves the performance of the tool.
- Fast and easy installation.
- Extends tool lifetime.



## PRODUCTIVITY KITS FOR SCREWDRIVERS, DRILLS AND GRINDERS

Model	Max air flow	Hose, 5 m	Coupling	Lubrication	Ordering No.
<b>For small screwdrivers and small drills with 1/8" BSP air inlet</b>					
MIDI Optimizer F/RD EQ08-C06-1/8	6 l/s	Cablair 6 mm	ErgoQIC 08	Yes	8202 0850 10
MIDI Optimizer F/R EQ08-C06-1/8	6 l/s	Cablair 6 mm	ErgoQIC 08	No	8202 0850 19
<b>For screwdrivers and drills with 1/4" BSP air inlet</b>					
MIDI Optimizer F/RD EQ08-C08	9 l/s	Cablair 8 mm	ErgoQIC 08	Yes	8202 0850 00
MIDI Optimizer F/R EQ08-C08	9 l/s	Cablair 8 mm	ErgoQIC 08	No	8202 0850 01
<b>For 1/2" drills and small nutrunners with 3/8" BSP air inlet</b>					
MIDI Optimizer F/RD EQ08-C10	16 l/s	Cablair 10 mm	ErgoQIC 08	Yes	8202 0850 07
<b>For 1/2" small nutrunners with 1/4" BSP air inlet</b>					
MIDI Optimizer F/RD EQ08-C10	16 l/s	Cablair 10 mm	ErgoQIC 08	Yes	8202 0850 03
MIDI Optimizer F/RD EQ10-R10	16 l/s	Rubair 10 mm	ErgoQIC 10	Yes	8202 0850 16
<b>For percussive tools and grinders with 3/8" BSP air inlet incl. whiphose</b>					
MIDI Optimizer F/RD EQ10-R13-W	23 l/s	Rubair 13 mm	ErgoQIC 10	Yes	8202 0850 14
<b>For percussive tools and grinders, incl. whiphose, no tool nipple included</b>					
MIDI Optimizer F/RD EQ10-R13-W	23 l/s	Rubair 13 mm	ErgoQIC 10	Yes	8202 0850 15
<b>For drills and nutrunners with 3/8" BSP air inlet</b>					
MIDI Optimizer F/RD EQ10-C13	23 l/s	Cablair 13 mm	ErgoQIC 10	Yes	8202 0850 02
<b>For drills and nutrunners with 1/4" BSP air inlet</b>					
MIDI Optimizer F/RD EQ10-C13-1/4	23 l/s	Cablair 13 mm	ErgoQIC 10	Yes	8202 0850 11
<b>For grinders and nutrunners with 3/8" BSP air inlet</b>					
MIDI Optimizer F/RD EQ10-T13	35 l/s	Turbo 13 mm	ErgoQIC 10	Yes	8202 0850 17
MIDI Optimizer F/RD EQ10-T16 (For LSV39)	35 l/s	Turbo 16 mm	ErgoQIC 10	Yes	8202 0850 42
<b>For grinders and nutrunners with 1/2" BSP air inlet</b>					
MIDI Optimizer F/R EQ10-T13	35 l/s	Turbo 13 mm	ErgoQIC 10	No	8202 0850 04
MIDI Optimizer F/RD EQ10-T13	35 l/s	Turbo 13 mm	ErgoQIC 10	Yes	8202 0850 13
<b>For grinders with 1/2" BSP air inlet</b>					
MIDI Optimizer F/RD EQ10-T16	40 l/s	Turbo 16 mm	ErgoQIC 10	Yes	8202 0850 12
<b>For large Turbo grinders with 1/2" BSP air inlet</b>					
MAXI F/R C-T16	60 l/s	Turbo 16 mm	Claw	No	8202 0850 05

## PRODUCTIVITY KITS FOR IMPACT WRENCHES AND PULSE TOOLS

Model	Max air flow	Hose, 5 m	Coupling	Lubrication	Ordering No.
<b>For small impacts and pulse tools with 1/4" BSP air inlet</b>					
MIDI Optimizer F/RD EP EQ08-C08	9 l/s	Cablair 8 mm	ErgoQIC 08	Yes	8202 0850 35
<b>For 1/2" impact wrenches and pulse tools with 3/8" BSP air inlet</b>					
MIDI Optimizer F/RD EQ08-C10	16 l/s	Cablair 10 mm	ErgoQIC 08	Yes	8202 0850 36
<b>For 1/2" impact wrenches and pulse tools with 1/4" BSP air inlet</b>					
MIDI Optimizer F/RD EQ08-C10	16 l/s	Cablair 10 mm	ErgoQIC 08	Yes	8202 0850 37
MIDI Optimizer F/RD EQ10-R10	16 l/s	Rubair 10 mm	ErgoQIC 10	Yes	8202 0850 38
<b>For impact wrenches and pulse tools with 3/8" BSP air inlet</b>					
MIDI Optimizer F/RD EQ10-C13	23 l/s	Cablair 13 mm	ErgoQIC 10	Yes	8202 0850 39
<b>For impact wrenches and pulse tools with 1/2" BSP air inlet</b>					
MIDI Optimizer F/RD EQ10-T13	35 l/s	Turbo 13 mm	ErgoQIC 10	Yes	8202 0850 41

## PRE-MOUNTED HOSE KITS

Atlas Copco hose kits provides an easy way to choose the right hose and coupling combination for pneumatic tools. Each kit is ready for immediate use without the need of assembly tools.

- Correct combination hose – coupling.
- Leak free hose connections.
- Immediate use.



## HOSE KITS

Hose	Hose inside dia mm	Length m	Nipple	Coupling	Air inlet thread nipple	Ordering No.
Cablaire	6	5	ErgoNIP 08	ErgoQIC 08	1/8" BSP	8202 1182 01
Cablaire	6	5	ErgoNIP 10	ErgoQIC 08	1/8" BSP	8202 1180 67
Cablaire	8	5	ErgoNIP 08	ErgoQIC 08	1/4" BSP	8202 1182 02
Cablaire	8	5	NIP 08	ErgoQIC 08US	-	8202 1182 21
Cablaire	8	5	ErgoNIP 10	ErgoQIC 08	1/4" BSP	8202 1180 77
Cablaire	10	5	ErgoNIP 08	ErgoQIC 08	1/4" BSP	8202 1182 03
Cablaire	10	5	ErgoNIP 10	ErgoQIC 08	14" BSP	8202 1180 30
Cablaire	12.5	5	ErgoNIP 10	ErgoQIC 10	3/8" BSP	8202 1180 79
Cablaire	12.5	5	ErgoNIP 10	ErgoQIC 10	-	8202 1182 10
Cablaire	12.5	5	NIP 10US	ErgoQIC 10US	-	8202 1182 18
Cablaire	12.5	8.5	ErgoNIP 10	ErgoQIC 10	-	8202 1182 20
Cablaire	12.5	10	ErgoNIP 10	ErgoQIC 10	-	8202 1182 15
PVC	10	5	ErgoNIP 10	ErgoQIC 10	1/4" BSP	8202 1180 18
PVC	10	5	ErgoNIP 10	ErgoQIC 08	3/8" BSP	8202 1180 31
Rubair	10	5	ErgoNIP 10	ErgoQIC 10	3/8" BSP	8202 1180 20
Rubair	10	5	ErgoNIP 10	ErgoQIC 10	1/4" BSP	8202 1180 43
Rubair	12.5	5	NIP 10US	ErgoQIC 10US	-	8202 1182 24
Rubair	20	5	CLAW	ErgoQIC 10	-	8202 1180 24
Turbo	12.5	5	ErgoNIP 10	ErgoQIC 10	3/8" BSP	8202 1182 07
Turbo	12.5	5	ErgoNIP 10	ErgoQIC 10	1/2" BSP	8202 1180 22
Turbo	12.5	5	NIP 10US	ErgoQIC 10US	-	8202 1182 19
Turbo	16.8	5	ErgoNIP 10	ErgoQIC 10	1/2" BSP	8202 1180 34
Turbo	16.8	5	CLAW	ErgoQIC 10	1/2" BSP	8202 1181 80
Turbo	16.8	5	NIP 15US	ErgoQIC 15US	-	8202 1182 22
Turbo	16.8	10	ErgoNIP 10	ErgoQIC 10	-	8202 1180 46
Turbo	21	20	CLAW	ErgoQIC 10	-	8202 1181 75
Turbo	16	5	ErgoNIP-10-M10	ErgoQIC 10	-	8202 1180 51



## WHIP HOSE KITS

Hose	Hose inside dia mm	Length m	Nipple	Male thread	Ordering No.
Cablaire	10	0.7	ErgoNIP 10	1/4" BSPT	8202 1180 19
Cablaire	10	1.5	ErgoNIP 10	1/4" BSPT	8202 1182 30
Cablaire	10	1.5	ErgoNIP 10	3/8" BSPT	8202 1182 35
Cablaire	10	0.7	ErgoNIP 08	1/4" BSPT	8202 1180 47
PVC	10	0.7	ErgoNIP 08	3/8" BSPT	8202 1180 50
Rubair	10	0.7	ErgoNIP 10	1/4" BSPT	8202 1180 42
Rubair	10	0.7	ErgoNIP 10	3/8" BSPT	8202 1180 44
Rubair	12.5	0.7	ErgoNIP 10	1/2" BSPT	8202 1180 23
Turbo	16.8	0.5	ErgoNIP 10	1/2" BSPT	8202 1180 28
Turbo	16.8	5	CLAW	1/2" BSPT	8202 1181 95



# Pre-mounted Hose Kits and Whip Hoses

## PRE-MOUNTED HOSE KITS

Atlas Copco SmartQIC hose kits provides an easy and safe way to choose the right hose and coupling combination for pneumatic tools.

Each kit is ready for immediate use without the need of assembly tools.

- Correct combination hose – coupling.
- Leak free hose connections.
- Plug & Play
- Each hose kit is provided with 2 extra Nips as shown in the picture and mentioned in the details.



## HOSE KITS AND WHIP HOSES

Market	Application	Nipples included	Max rec. air flow		Max working pressure		Ordering No.	
			l/s	cfm	bar	psi		
<b>EU 7.6</b>								
SmartQIC 08E	Hose kit	Assembly	1/4"	7.5	15.9	14	203	4221 0000 80
		Assembly	1/4" and 3/8"	13	27.5	12	174	4221 0000 81
		Assembly	1/4" and 3/8"	13	27.5	12	174	4221 0000 82
		Assembly	3/8" and 1/2"	21	44.5	11	160	4221 0000 85
		Assembly	3/8" and 1/2"	21	44.5	11	160	4221 0000 86
		Heavy Duty	3/8" and 1/2"	21	44.5	20	290	4221 0000 83
	Heavy Duty	3/8" and 1/2"	21	44.5	20	290	4221 0000 84	
	Whip hose	Assembly	1/4"	7.5	15.9	14	203	4221 0001 09
		Assembly	3/8"	13	27.5	12	174	4221 0001 10
		Assembly	3/8"	21	44.5	11	160	4221 0001 11
<b>EU 10.4</b>								
SmartQIC 15E	Hose kit	Assembly	3/8" and 1/2"	21	44.5	11	160	4221 0000 89
		Assembly	3/8" and 1/2"	21	44.5	11	160	4221 0000 90
		Heavy Duty	3/8" and 1/2"	21	44.5	20	290	4221 0000 87
		Heavy Duty	3/8" and 1/2"	21	44.5	20	290	4221 0000 88
		Heavy Duty	1/2" and 3/4"	43	91.1	20	290	4221 0000 91
		Heavy Duty	1/2" and 3/4"	43	91.1	20	290	4221 0000 92
	Whip hose	Heavy Duty	3/8"	21	44.5	20	290	4221 0001 12
		Heavy Duty	1/2"	43	91.1	20	290	4221 0001 13
	<b>ISO 6150-B – US/Global</b>							
	SmartQIC 08US	Hose kit	Assembly	1/4"	7.5	15.9	14	203
Assembly			1/4" and 3/8"	13	27.5	12	174	4221 0000 94
Assembly			1/4" and 3/8"	13	27.5	12	174	4221 0000 95
Assembly			3/8"	13	27.5	12	174	4221 0001 14
SmartQIC 10US	Hose kit	Assembly	1/4" and 3/8"	13	27.5	12	174	4221 0001 01
		Assembly	1/4" and 3/8"	13	27.5	12	174	4221 0001 02
		Assembly	3/8" and 1/2"	21	44.5	11	160	4221 0001 05
		Assembly	3/8" and 1/2"	21	44.5	11	160	4221 0001 06
		Heavy Duty	3/8" and 1/2"	21	44.5	20	290	4221 0001 03
		Heavy Duty	3/8" and 1/2"	21	44.5	20	290	4221 0001 04
	Whip hose	Assembly	3/8"	13	27.5	12	174	4221 0001 17
		Assembly	3/8"	21	44.5	11	160	4221 0001 18
Heavy Duty		3/8"	21	44.5	20	290	4221 0001 19	
SmartQIC 15US	Hose kit	Assembly	3/8" and 1/2"	21	44.5	11	160	4221 0000 97
		Assembly	3/8" and 1/2"	21	44.5	11	160	4221 0000 98
		Heavy Duty	3/8" and 1/2"	21	44.5	20	290	4221 0000 96
		Heavy Duty	1/2" and 3/4"	75	158.9	20	290	4221 0000 99
		Heavy Duty	1/2" and 3/4"	75	158.9	20	290	4221 0001 00
	Whip hose	Assembly	3/8"	21	44.5	11	160	4221 0001 15
Heavy Duty		3/8"	21	44.5	20	290	4221 0001 16	
<b>Asia</b>								
SmartQIC 10A	Hose kit	Assembly	1/4"	7.5	15.9	14	203	4221 0001 07
		Assembly	1/4" and 3/8"	13	27.5	12	174	4221 0001 08

## HM LIGHT

The HM Light has a robust design with a high impact composite casing. The outlet slot is optimized to provide an ideal pull-out angle for the hose. The HM Light is recommended for small and medium screwdrivers, small and medium pulse tools, small drills, impact wrenches up to 1/2" size and riveting and chipping hammers.

- Snap-on, pivoting wall bracket.
- PVC/PUR hose.
- Hose end provided with pressed fitting and steel spiral hose protector (NPT and BSP).
- Hose easily replaced when needed.
- Drum with ball bearings on both sides.
- Working temperature: 0°C - +50°C.
- Inlet hose length: 1 m.



Model	Hose length m	Hose type	Hose inside dia		Connection inlet hose inside dia (cut of hose) mm	Connection distribution hose BSP	Max working pressure bar	Economical air flow (at 0.2 bar pressure drop) l/s	Max air flow capacity (at 0.5 bar pressure drop) l/s	Weight kg	Ordering No.
HM LIGHT 8-8	8	PVC/PUR	8	5/16	10	1/4	12	4	7	3	8202 1183 30
HM LIGHT 8-12	12	PVC/PUR	8	5/16	10	1/4	15	3	5	5	8202 1183 31
HM LIGHT 10-10	10	PVC/PUR	10	3/8	10	3/8	15	6	10	5	8202 1183 32

## Dimensions

HM LIGHT 8-8 (8-12)

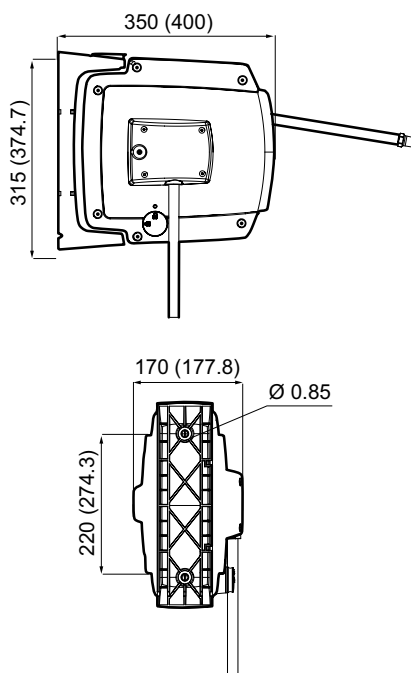

## FLOW CHART.

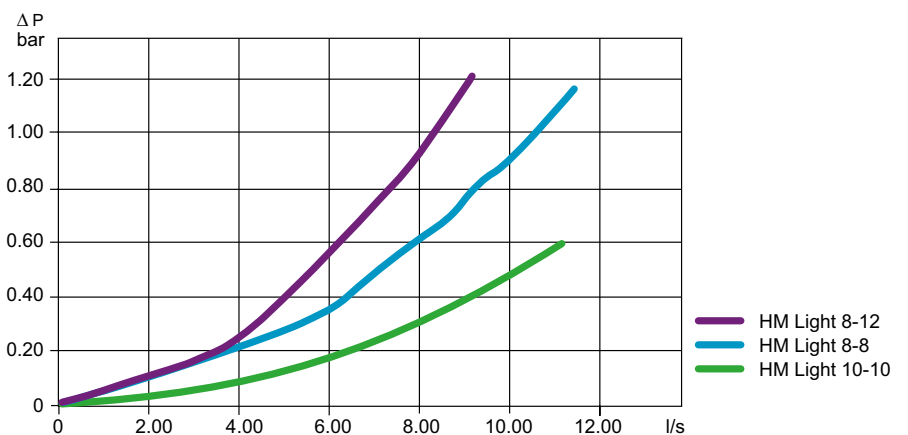

## HM OPEN

The HM Open has an open composite casing, steel frame and 10 mm or 13 mm hose. HM Open is a reliable, medium sized hose reel recommended for screwdrivers, impact wrenches, pulse tools, drills, chipping and riveting hammers and grinders up 1000 W.

- Spatter resistant rubber hose.
- Outlet roller position can be adjusted through 120 degrees for optimal pull-out angle.
- Hose end provided with steel spiral hose protector (NPT and BSP).
- Latch function is easily disengaged.
- Spring tension is easily adjusted.
- Floor, wall or ceiling mounting.
- Working temperature: -10°C - +60°C.
- Max working pressure: 15 bar.
- Inlet hose length: 1 m.



Model	Hose length m	Hose type	Hose inside dia		Connection inlet hose inside dia (cut of hose) mm	Connection distribution hose BSP	Economical air flow (at 0.2 bar pressure drop) l/s	Max air flow capacity (at 0.5 bar pressure drop) l/s	Weight kg	Ordering No.
			mm	in						
HM OPEN 10-15	15	Rubber	10	3/8	12.5	3/8	5	9	11	8202 1183 33
HM OPEN 10-20	20	Rubber	10	3/8	12.5	3/8	5	7	14	8202 1183 34
HM OPEN 12-10	10	Rubber	12.5	1/2	12.5	1/2	13	22	12	8202 1183 35
HM OPEN 12-15	15	Rubber	12.5	1/2	12.5	1/2	11	17	13	8202 1183 36

Pivoting wall brackets needs to be ordered separately.

## Dimensions

HM Open 12-10 (12-15)

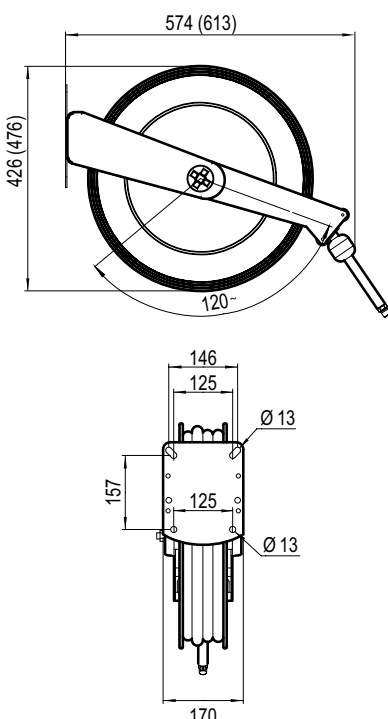

## FLOW CHART.

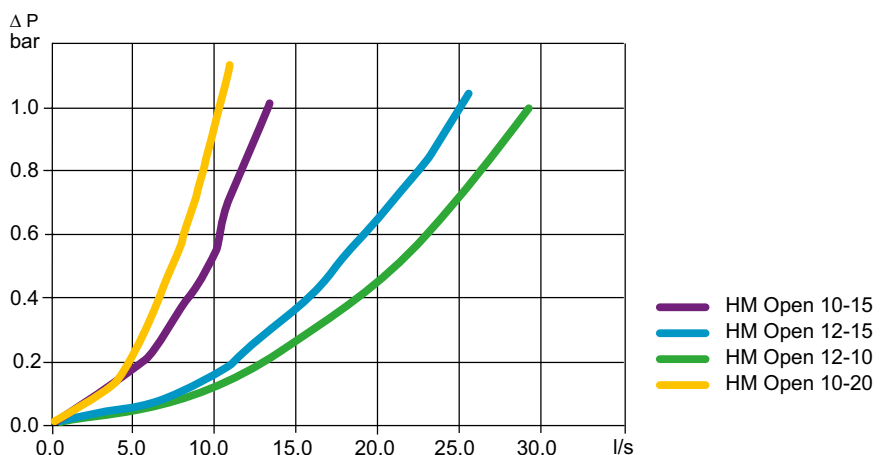

## Accessories

	Ordering No.
Pivoting wall bracket	4390 2080 10

## HM OPEN XL

Hose reels in the HM Open XL series have an open die cast aluminium casing and 3/8" or 1/2" hose. HM Open XL hose reels are recommended for screwdrivers, impact wrenches, pulse tools, drills, chipping and riveting hammers and high powered grinders.

- Spatter resistant rubber hose.
- Floor, wall or ceiling mounting.
- Revolving hinge for flexible use.
- Working temperature: -10°C - +60°C.
- Max working pressure: 15 bar.
- Inlet hose length: 1 m.



Model	Hose length m	Hose type	Hose inside dia		Connection inlet	Connection distribution hose BSP	Economical air flow (at 0.2 bar pressure drop) l/s	Max air flow capacity (at 0.5 bar pressure drop) l/s	Weight	
			mm	in	hose inside dia (cut of hose) mm				kg	Ordering No.
HM OPEN XL 12-20	20	Rubber	12.5	1/2	12.5	1/2	8	14	27	8202 1183 37
HM OPEN XL 12-30	30	Rubber	12.5	1/2	12.5	1/2	8	12	28	8202 1183 38
HM OPEN XL 19-15	15	Rubber	19	3/4	19	3/4	27	44	28	8202 1183 39
HM OPEN XL 25-10	10	Rubber	25	1	25	1	60	95	30	8202 1183 40

Pivoting wall brackets needs to be ordered separately.

## Dimensions

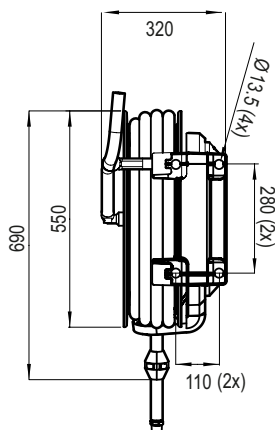
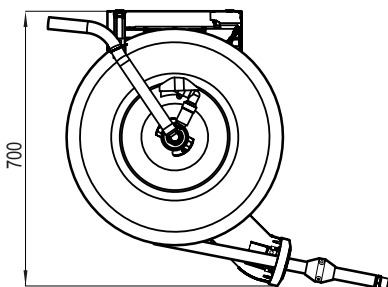

## FLOW CHART

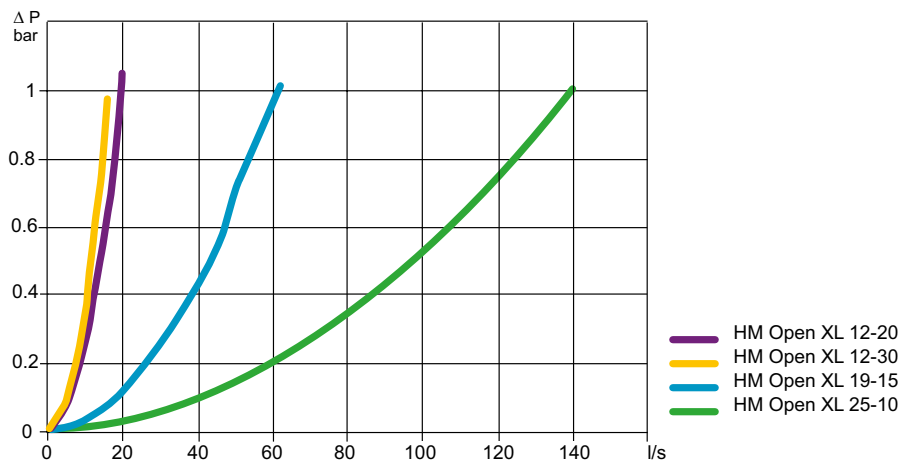

## Accessories

	Ordering No.
Pivoting wall bracket	4390 2080 11

## HM FLEX L

The HM FLEX L, with a steel casing and high quality rubber hose, handles both air and water. The HM FLEX L is recommended for all screwdrivers, pulse tools, impact wrenches, drills, chipping and riveting hammers and grinders up to 1000 W.

- NBR rubber hose.
- Movable brackets for floor, wall and ceiling mounting.
- High flow capacity.
- Working temperature: -30°C - +60°C.
- Max working pressure is 15 bar.
- Inlet hose length: 1 m.



## Dimensions

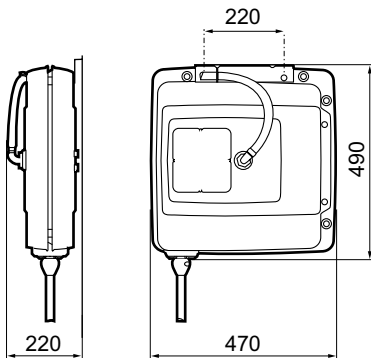

Model	Length m	Hose	Hose inside dia		Connection inlet BSP male	Connection distribution hose BSP		Air flow l/s	Weight kg	Ordering No.
			mm	in		male	male			
HM FLEX L	10	Rubber	12.5	1/2	1/2	1/2	22	16	8202 1181 56	



### RIL BALANCER

RIL balancers always keep the tool in place, handy and easily accessible. RIL balancers are available as retractors or weightless positioning balancers.

Safety chain included with all RIL balancers.

### RIL RETRACTORS

- Adjustable wire stop.
- High quality spring and construction.
- Load range 0 to 10 kg.

### HOSE REEL BALANCER – HRIL

Models in the HRIL range of hose reel balancers are specifically designed for use with small pneumatic hand tools.

The integrated air hose and support cable ensure the work area is kept tidy and the tool is easy to control.

- Ergonomics – The retraction force over hose travel remains almost constant which minimizes load on the operator and ensures smooth operation.
- An easily adjusted rubber stop is fitted on the hose which allows the tool to be set at the optimum position.
- The retraction force is easily ad.



Model	Capacity range		Max rec. air flow <sup>a</sup> l/s	Hose travel m	Weight		Max working pressure bar	Dimensions			Ordering No.
	kg	lb			kg	lb		A mm	B mm	C mm	
HRIL 1	0.2-0.5	0.4-1.1	3.5	1.2	1.2	2.6	10	92	132	173	8202 0600 03
HRIL 3	0.5-1.4	1.1-3.1	5.5	1.0	1.2	2.6	10	92	132	173	8202 0600 11
HRIL 4	0.7-2.0	1.5-4.4	6.5	1.0	1.4	3.1	10	92	132	173	8202 0600 29

<sup>a</sup> At inlet pressure of 6 bar pressure drop is 0.4 bar.

## Dimensions

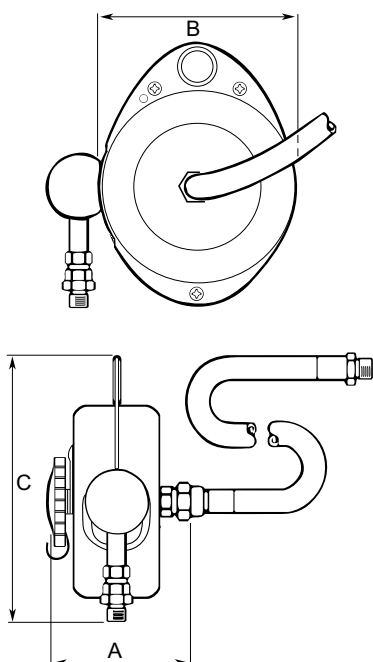

## Optional Accessories

Designation	Ordering No.
Safety chain	4391 4045 90

## BLOW GUN BG-SERIES

Atlas Copco blow guns BG-series are hard wearing, user friendly solution for all cleaning applications. The plastic body offer flexibility in handling for both left and right handed users, it insulate against cold and it reduce the risk of scratches to worksurfaces. The blow gun has excellent throtteling properties allowing easy regulation of the air flow. The blow guns have air inlet thread in brass that is fully covered by the plastic body. Two versions available with star tip to reduce risk of damages or injuries if the tube is pressed against workpiece or skin.

- High flow capacity.
- Suspension.
- Plastic body to avoid scratches.
- Air inlet thread in brass.
- Star tip availability for improved safety.
- Complies with OSHA STD1-13.1 and OSHA 1910.95.



Model	Version	Working pressure bar	Air flow l/s	Weight		Air inlet thread BSP	Ordering No.
				kg	lb		
BG 2603-HF	Long tube, high flow	6.3	7.5	0.13	0.29	1/4	8202 1006 04
BG 2604-SHF	Short tube	6.3	4.3	0.12	0.26	1/4	8202 1006 05
BG 2605-STSS	Short tube, star tip	6.3	6.6	0.12	0.26	1/4	8202 1006 06
BG 2606-STS	Long tube, star tip, silencer	6.3	6.3	0.14	0.31	1/4	8202 1006 07

## Test Equipment

### PRESSURE CONTROL UNIT

The unit consists of a high quality pressure gauge and the necessary couplings for checking the air pressure at the air inlet of the machine.

Ordering No. 4145 0699 81.



# *Air motors*

A worker in a blue uniform is kneeling and working on a large, shiny stainless steel industrial tank. The worker is using a tool to adjust a component on the tank. The background shows other industrial equipment and a blue wall.

## **Contents**

Air motors .....	318
LZB vane air motors .....	319
LZL vane air motors.....	319
Air motor support.....	320



## Atlas Copco air motors

*Air motors from Atlas Copco – the reliable, cost-effective solution when applying power to rotating machines. Consider the air motor features and characteristics giving large benefits to the designer.*



### **AIR MOTOR FEATURES AND CHARACTERISTICS**

- Leading the industry in development and innovation.
- Offering a comprehensive range of standard air motors.
- A premier supplier of air motors engineered to meet customer requirements.
- Delivering orders, on time, to customer schedules.
- Offering a truly worldwide service.

### **FEATURES FOR LZB MOTORS**

#### **Lubrication-free air motors**

Equipped with low friction vanes and sealed bearings the lubrication-free motors release no lubricants into the air. They offer a viable drive solution for applications where oil mist must be avoided. For normal operations lubrication can still be used.

#### **Stainless steel air motors for harsh and aggressive environments**

Atlas Copco's stainless steel motors enlarge the field of applications to areas where the environment is corrosive. This can be in the food processing industries where corrosive detergents are used or

in the chemical industry where the atmosphere as such is corrosive.

Atlas Copco's stainless steel motors have a "clean" design. Their smooth surfaces are cylindrical with no pockets where dirt can collect. The motors are easy to clean. The motors have double seals in Viton at the output shaft to prevent dirt and liquids from entering the motor gears. The seals also prevent the gear lubricant from leaking out. All external parts, including the output shaft, are made of stainless steel. The grease in the motor complies with NSF H1 and FDA 21CFR § 178.3570. For applications where there might be moisture in the compressed air the stainless steel LZB-motors can be equipped with a stainless steel motor cell as an option. With this option the motor becomes 100% stainless, both internal and external.

#### **High torque air motors when a real workhorse is needed**

Fitted with extra strong planetary gears the high torque air motors provide torques up to 680 Nm. The gears are dimensioned to stand being loaded at full stall torque indefinitely. Despite their strength the high torque air motors are compact compared to solutions with helical or worm gears. Lubrication-free versions are also available.

### **Customized air motors to your individual specifications**

Whatever the requirement, Atlas Copco is always happy to help customers find solutions to their special needs. For OEMs, for instance, a customized air motor can be the most efficient solution when integrating an air motor into a machine or a tool. Special motors may have unique casings or mounting arrangements. They may utilize non-standard materials or surface coatings and be designed to achieve a specific output.



### **CERTIFIED VERSIONS**

Our air motors are available with certification as standard, in compliance with the European Union's ATEX Directive on equipment for potentially explosive environments.

## LZB RANGE

### 0.1 – 2.80 KW

LZB Atlas Copco vane motors are compact, lightweight, and energy efficient. They are available in a variety of gear ratios to meet a large range of speed and torque requirements. They are particularly suitable for building into hand held machines, or indeed any industrial equipment.



Model	Max output		Speed range at max output r/min	Torque range at max output		Min start torque range		Free speed r/min	No. of gear ratios	Motor diameter	
	kW	hp		Nm	ft lb	Nm	ft lb			mm	in
<b>Non-reversible</b>											
LZB14	0.16	0.21	320-9100	0.17-4.8	0.13-3.5	0.23-8.5	0.17-6.27	700-19500	5	27	1.1
LZB22	0.27	0.36	210-9600	0.27-11.8	0.20-8.7	0.32-22	0.24-16.2	480-21500	7	36	1.4
LZB33/34	0.39	0.52	10-9400	0.40-349	0.30-257	0.69-680	0.51-502	20-19000	17	42	1.7
LZB42	0.71	0.95	23-10000	0.68-272	0.5-201	1.09-435	0.80-321	42-19000	12	46	1.8
LZB46	0.84	1.13	25-10800	0.74-299	0.55-221	1.20-485	0.88-358	45-20000	12	46	1.8
LZB54	1.20	1.61	70-10000	1.15-161	0.85-119	1.80-261	1.33-193	125-18000	10	60	2.4
LZB66	1.87	2.51	55-8200	2.2-308	1.62-227	3.2-456	2.4-336	110-16000	10	60	2.4
LZB77	2.80	3.75	80-1220	22-332	16-245	35-536	26-395	165-2600	7	100	3.9
<b>Reversible</b>											
LZB14	0.11	0.15	250-7000	0.15-4.3	0.11-3.2	0.24-6.9	0.18-5.1	490-13000	5	27	1.1
LZB22	0.16	0.21	5-7000	0.24-10.5	0.18-7.7	0.32-14	0.24-10.3	5-13100	9	36	1.4
LZB33/34	0.25	0.34	7-7000	0.34-300	0.25-221	0.46-412	0.34-304	10-13300	21	42	1.6
LZB42	0.53	0.71	19-8000	0.63-255	0.46-188	0.85-344	0.63-254	33-14200	12	46	1.8
LZB46	0.63	0.84	20-8500	0.71-287	0.52-212	0.96-388	0.71-286	35-15800	12	46	1.8
LZB54	0.82	1.10	47-6800	1.15-161	0.85-119	1.40-207	1.03-153	90-12000	10	60	2.4
LZB66	1.46	1.96	50-7500	1.9-259	1.4-191	2.4-337	1.8-249	90-13500	10	60	2.4
LZB77	2.40	3.22	80-1280	18-274	13.3-202	24-374	18-276	155-2300	7	100	3.9

The LZB14, LZB22 and LZB33 models are available in lubrication-free versions. LZB14, LZB22 and LZB33 can be obtained in a stainless steel version. The standard non-reversible motors have clockwise rotation but can also be obtained with anti-clockwise rotation.

## LZL RANGE

### 1.05 – 5.2 KW

LZL Atlas Copco vane motors are designed to give outstanding starting characteristics, and low speed performance. The range is rugged and constructed for a long service life. With proven design, the LZL has been the machine tool builder's choice for decades.



Model	Torque at 3000 r/min		Power at 3000 r/min		Stall torque		Air consumption at 3000 r/min <sup>a</sup>		Max allowed speed r/min	Weight	
	Nm	ft lb	kW	hp	Nm	ft lb	l/s	cfm		kg	lb
LZL03 M	1.3	0.95	0.41	0.55	3.3	2.4	16	34	3000	2.9	6.4
LZL05 M	2.0	1.5	0.63	0.84	5.8	4.3	25	52	3000	3.9	8.6

<sup>a</sup> Note that the air consumption in a typical mixing application normally is less than 50% of the values in the table  
LZL 03/05 available with IEC and Nema flange. LZL05 also available in stainless steel.

Model	Max output		Speed at max output r/min	Torque at max output		Min start torque		Max allowed speed r/min	No. of gear ratios
	kW	hp		Nm	ft lb	Nm	ft lb		
<b>Motor only</b>									
LZL03 S	1.7	2.5	7500	2.2	1.6	2.8	2.1	11000	–
LZL05 S	2.1	2.8	6300	3.1	2.3	4.8	3.5	9200	–
LZL15	3.2	4.3	4500	6.8	5.0	10.9	8.0	7200	–
LZL25	5.0	6.7	4000	12.0	8.8	18.0	13.2	6000	–
LZL35	6.5	8.7	3100	20.0	14.7	32.0	23.6	5000	–
<b>With helical gear unit</b>									
LZL05 <sup>a</sup>	2.0	2.6	45-512	36-403	27-297	56-624	41-460	65-740	6
LZL15 <sup>a</sup>	3.0	4.1	26-389	74-1071	55-790	116-1668	86-1230	43-639	6
LZL25 <sup>a</sup>	4.8	6.4	25-370	128-1836	94-1354	192-2754	141-2031	36-531	6
LZL35 <sup>a</sup>	6.2	8.3	61-464	128-944	94-696	192-1417	141-1045	111-838	4

<sup>a</sup> Not ATEX certified.



## Customized air motors to your individual specifications

*Whatever the requirement, Atlas Copco is always happy to help customers find solutions to their special needs. For OEMs, for instance, a customized air motor can be the most efficient solution when integrating an air motor into a machine or tool.*

*Special motors may have unique casings or mounting arrangements. They may utilize non-standard materials or surface coatings and be designed to achieve a specific output.*

### **SELECT YOUR AIR MOTOR WITH OUR WEB BASED MOTOR SELECTION PROGRAM**

Use the web based Air Motor Selection tool to choose the correct motor for your application.

The designer specifies the required torque and speed of the motor and within seconds the program chooses the optimum motor. It also supplies complete documentation with performance curves and motor data.

Visit <https://webbox.atlascopco.com/air-motor/> to access the program.

### **AIR MOTOR DRAWING LIBRARY**

CAD-drawings of any of the hundreds of different Atlas Copco air motors are available to designers, just download (in both 2D and 3D formats) via Internet from Atlas Copco Drawing Library. These CAD-drawings can then be quickly and easily inserted into the designer's machine drawing.

### **WHEN MORE INFORMATION IS REQUIRED**

For further information on Atlas Copco vane motors please ask for a copy of our Air Motor catalogue or browse to our Links and Downloads section on [www.atlascopco.com](http://www.atlascopco.com) to download the catalogue.



# Service



## Contents

Introduction.....	322	Service Maintenance .....	325
Service packages .....	323	Service Optimization.....	327
Service Start-up .....	324		



## Service solutions at Atlas Copco

Every production line and industrial site is unique and has its own challenges.

With that in mind, our service solutions are designed to help you get the most out of your industrial equipment. We combine analyses of production data with know-how and expertise in order to enhance your productivity and quality; while keeping you cost efficiency maintenance under control.

Our service offering consists of various services and options to further customise your maintenance agreement and fit your needs:



<b>OPTIMIZATION</b>	<b>Optimization</b>		
<b>MAINTENANCE</b>			
Software Maintenance	<b>TechCover</b>		
KPI's – Set-up and reports On-site workshop Tool Management System	<b>ToolCover Uptime</b>		
ToolCover Protect plus repairs including spares			
Preventive Maintenance Tool Calibration	<b>ToolCover Protect</b>		
Calibration	<b>Calibration – Tooling and QA</b>		
Repairs	<b>Repairs</b>		
<b>START-UP</b>	<b>EasyStart</b>		

## Start-up

Starting a new operation requires meticulous planning, investment and training. Getting started quickly and smoothly ensures you're delivering value from the first day. Our start-up service solutions ensure that customers equipment is 'right first time', whilst also ensuring it delivers the optimum quality level and cost efficiency.



## Maintenance

Atlas Copco can manage your entire maintenance cycle, whilst supporting our customers with preventive maintenance programs. Our maintenance solutions help customers optimize performance, decrease production downtime, whilst ensuring the right quality of your products. All within a controlled maintenance cost.



## Optimization

In your production, there are many factors which might affect the right performance of your equipment. Not only is the tooling important, but also the operator, materials, joint conditions and software. Through our optimization services, we offer the possibility to improve assembly processes whilst optimizing performance.



## EasyStart

EasyStart offers a trouble-free and efficient start of operations for your tightening system. Through a globally standardized and certified process for every step, from programming to training, you will get it right the first time, saving time and money.





**RapidRepair**

RapidRepair, ensures damaged tools are quickly repaired and back in production with minimal administration, cost and inconvenience.



With a predefined, easy and practical process, we take full care of the whole repair cycle – with a leading turnaround time from door to door, because easy is both faster and less expensive.

**ToolCover**

ToolCover maintenance solutions help optimize performance and gain efficiencies in production, whilst minimizing tool costs and production risks.



With a modular set of products, ToolCover is designed to meet specific needs and tool usage.

ToolCover solutions are always:

- Reducing maintenance & Repair time
- Built on global best practice processes and service certificates
- Offered with a fixed Preventive Maintenance cost
- Coupled with discounts on spare parts

**Calibration**

With our network of calibration laboratories we offer a complete package of calibration services to help control quality for all assembly tools and measurement equipment in production.



The most efficient way to control quality:

- Traceability and document management.
- Calibration/verification of transducerized tools and controllers.
- Torque adjustment and capability test.
- Verification test for a specific application.
- Accredited and factory calibration of measurement equipment.
- Testing and calibration of click and torque wrenches.



**TechCover Software Solutions**



TechCover support solutions help protect production investment while optimizing production performance, quality and availability, whilst minimizing production risks.

With a modular set of products, TechCover is designed to meet your specific support requirements.

TechCover solutions are always:

- Reducing Resolution Times.
- Built on global best practice processes and support expertise.
- Offered with at fixed cost.
- Coupled with free access on software updates.

**BASED ON YOUR NEEDS, YOU CAN CHOOSE BETWEEN PROTECT, STABILITY, UPTIME.**

*Please see below our value proposition*

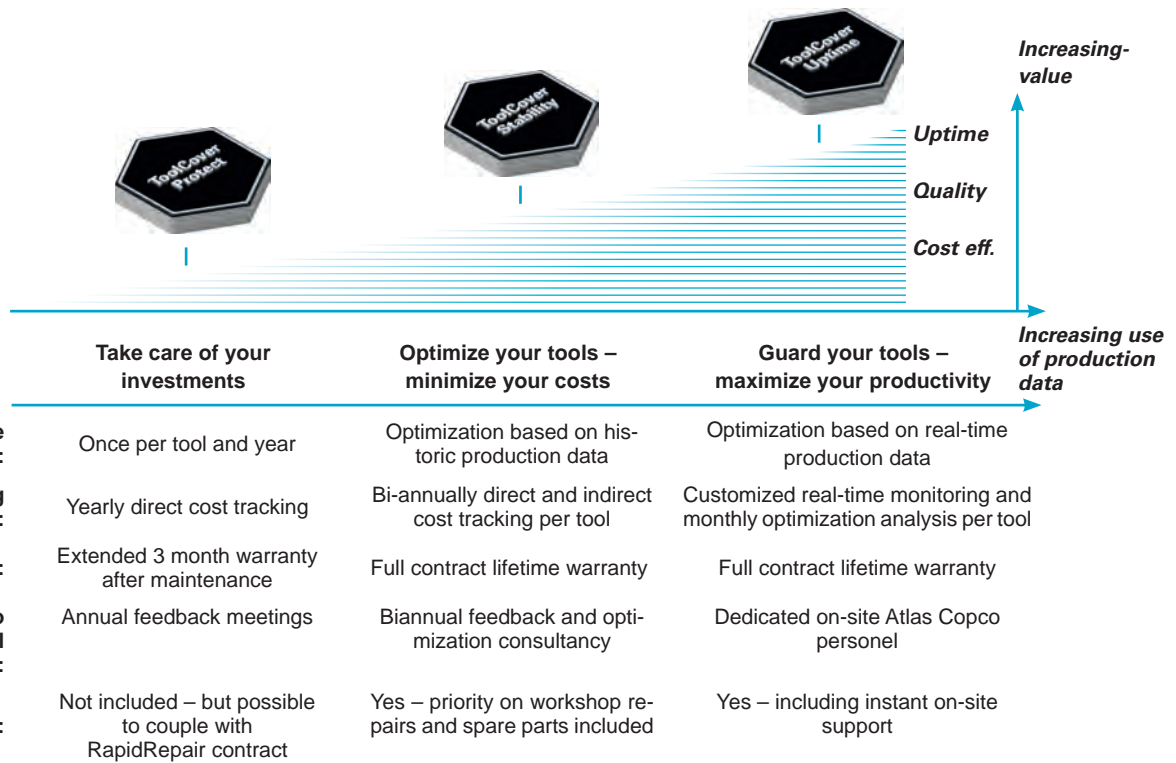

**Production optimization**

Zero fault production at the lowest total cost. Atlas Copco Service can help improve productivity within an existing assembly, or in a new production project.



We ensure that the focus remains on quality and efficiency from concept and R&D, through to full production:

- Joint analysis and optimization.
- Process optimization
- Program optimization

**Training**

Training provide your personnel with the capability to determine whether production issues and interruptions are the result of problems with the tooling or with the parts used in assembly.



Help raise productivity. Having well-trained operators, line engineers and quality people in your operations, means higher productivity and quality.

We have developed an extensive range of training courses that are provided locally through the Atlas Copco global network.

**ResultScan**

ResultScan reduces your risk of sending defective products to your customers. Thereby decreasing costs of warranty, rework and recall.



It identifies your application's optimal monitoring limits. Installing these limits enables you to identify cross threading, material problems and operational errors, before the customer does. It reduces your risk of sending defective products to customers. Thereby decreasing costs of warranty, rework and recall.





# Tool Designations

BAL – Ball valve	LMV – Pneumatic nutrunner, stall type, angle model
BCP BL – Battery screwdriver, pistol grip, clutch type	LSF – Die grinder
BCV – Battery nutrunner, angle model, clutch type	LSK – Routers
	LSO – Orbital sander
CABLAIR – CABLAIR hose	LSR – Straight grinder
CLAW – Claw coupling	LSS – Vertical grinder and sander
COL – Colibri balancer	LST – Random orbital sander
COMBI – Pneumatic screwdriver, direct drive	LSV – Angle grinder and sander
COMBI – Pistol grip drill	LTC – Pneumatic nutrunner, shut-off type, crowfoot
	LTD – Pneumatic nutrunner, shut-off type, straight model
DIM – Air preparation unit, lubricator	LTO – Pneumatic nutrunner, shut-off type, tube nut
DOS – Direct lubricator unit	LTP – Pneumatic nutrunner, shut-off type, pistol grip
	LTV – Pneumatic nutrunner/screwdriver, shut-off angle model
EBL – Electric screwdriver, brushless clutch type	LUD – Pneumatic screwdriver, direct drive
EP C/X/XS – Hydraulic impulse nutrunner, non shut-off, ERGOPULSE	LUF – Pneumatic screwdriver, slip-clutch
EP PTI/PTS/PTX – Hydraulic impulse nutrunner, shut-off, ERGOPULSE	LUM – Pneumatic screwdriver, shut-off clutch
ErgoNIP – Nipple	LZB – Small vane air motor
ErgoQIC – Quick coupling	LZL – Vane air motor
ETC ST – Electric nutrunner, shut-off type, crowfoot, TENSOR ST	
ETC STB – Battery nutrunner, crowfoot, TENSOR STB	MRTT-B – Screwdriver for low torque applications
ETD ES – Electric nutrunner, shut-off type, straight model, TENSOR ES	MT TH – Torque In/Line rotary transducer
ETD M – Electric screwdriver, hand-held "Digitork", MicroTorque	MT TR – Torque&Angle In/Line rotary transducer
ETD SL – Electric screwdriver, straight model, TENSOR SL	MT TRA – Stationary torque transducer
ETD ST – Electric nutrunner, shut-off type, straight model, TENSOR ST	MT TS – Manual screwdriver torque transducer
ETD STR – Electric screwdriver, straight model, TENSOR STR	Multiflex – Swivel connectors
ETF M – Electric screwdriver, fixtured "Digitork", MicroTorque	
ETF MT – Electric screwdriver, fixtured transducerized, MicroTorque	NIP – Nipple
ETF SL – Electric screwdriver, shut-off type, fixture, TENSOR SL	
ETO ST – Electric nutrunner, shut-off type, open end, TENSOR ST	Optimizer – Air tool oil
ETO STB – Battery nutrunner, tube nut, TENSOR STB	
ETP SB – Battery nutrunner, pistol grip TENSOR SB	PFD – Power feed drills
ETP SL – Electric screwdriver, shut-off type, pistol grip, TENSOR SL	POLUR – Polyurethane hose
ETP STB – Battery nutrunner, pistol grip TENSOR STB	PVC – PVC hose
ETP ST – Electric nutrunner, shut-off type, pistol grip, TENSOR ST	
ETP STR – Electric screwdriver, pistol grip, TENSOR STR	QIC – Quick coupling
ETD ES – Electric nutrunner, shut-off type, angle model, TENSOR ES	QRTT – Transducer for spindle and fixtured tool calibration
ETV SB – Battery nutrunner, angle model, TENSOR SB	QST – Fixtured electric nutrunner, shut-off type
ETV SL – Electric screwdriver, angle model, TENSOR SL	
ETV ST – Electric nutrunner, shut-off type, angle model, TENSOR ST	RBB – Bucking bar, vibration damped
ETV STR – Electric screwdriver, angle model, TENSOR STR	REG – Air preparation unit, regulator
ETV STB – Battery nutrunner, angle model, TENSOR STB	RIL – Balancer
ETX – Fixtured electric nutrunner, shut-off type	RRC – Chipping hammer, conventional type
	RRD – Chipping hammer, vibration damped
FIL – Air preparation unit, filter	RRF – Chipping hammer, vibration damped
	RRH – Riveting hammers, vibration damped
GHP – Torque arm, MicroTorque	RRN – Riveting hammer, conventional type
GTG – Turbo grinder	RTP – Pneumatic nutrunner, pistol grip
GTR – Straight turbo grinder	RUBAIR – Rubber hose
GUN – Blow gun	RVM – Scaler, vibration damped
HM – Hose reel	SM – Torque arm, parallel
HRIL – Hose reel	SMC – Carbon arm
HT – Torque testers	SML – Torque arm, linear
	SPI – Spiral hose
IRTT-B – In-line rotary torque and torque/angle transducer	SMS – Torque arm, linear
	SRB – Battery nutrunner
JSB – Joint Simulator Bench	SRTT-B – Static reaction torque transducer
	SRTT-L – Transducer for STanalyser
LBB – Pistol grip and straight drill	STB – Static Transducer Bench
LBD M – Modular drill, straight model	
LBR – Pneumatic nutrunner, stall type, ratchet wrenches	TBP – Battery nutrunner
LBS – Micro stop drill	TPS – Tool Positioning System
LBV – Angle drill	TT – Torque testers
LBP M – Modular drills, pistol model	TURBO – Rubber hose
LCS – Circular cutters	TWIST – Pneumatic screwdriver, slip-clutch
LGB – Tapper	
LMD – Pneumatic nutrunner, stall type, straight model	WP – Balancer
LMK – Pneumatic nutrunner, stall type, worm drive	
LMP – Pneumatic nutrunner, stall type, pistol grip	
LMS – Impact wrenches, non shut-off type	



**Atlas Copco AB**

(publ) SE-105 23 Stockholm, Sweden

Phone: +46 8 743 80 00

Reg. no: 556014-2720

[atlascopco.com](http://atlascopco.com)

