

Aristokraft®



New In This Book

First order date 01/07/2019

Door Style & Finish Expansions

5-Piece Drawer Front option on Brellin PureStyle™ Page 12

Flagstone stain on Avalon Cherry and Maple, and Sinclair Birch Page 20

Winstead door style in Birch Page 18

Antique, Stone Gray, and White Paint on Saybrooke Birch Page 20

Stone Gray and White Paint on Sinclair Birch (July 2018) Page 20

Burlap stain on all Maple and Birch door styles except Sinclair (July 2018) Page 19-20

Base Cabinets

Open Shelf Base Microwave Cabinet (BMW_DD) Page 100

Product Updates

Vanity Double Drawer Bases and Vanity Sink Drawer Base change from 4 drawer stack to 3 drawer stack
VDDB42-60 and VSDB60 Page 127, 131

Vanity Door and Drawer Bases change from 2 false panels to 1
VDD30-36 change to VSD30-36 Page 126-127

Discontinuations

Cherry Wheat Finish

WHCONSTR30

WHCONSTR36

DBFP30-4

DBFP36-4

Cherry BP4896

AC2417.5

ACS1817.5

ACS2417.5

ACS3017.5

PSMTCAP8 in Toasted Antique

PSMTBEAD8 in Toasted Antique

FF396 in Toasted Antique

F531A45 in Toasted Antique

OL3x3



5-Piece Drawer Front on Brellin

Page 12

Based on popular demand, Aristokraft is launching a 5-piece drawer option for Brellin. The clean lines of Brellin PureStyle™ laminate offer aesthetic simplicity and style versatility.

Winstead Birch

Page 18

Expanding Winstead to Birch introduces a new lower price point option for both Winstead stained and painted door styles, satisfying consumer's desires for a more modern, transitional look.



Flagstone on Sinclair & Avalon

Page 20

Now available on two of our most popular door styles, Flagstone's brown undertones impart a subtle earthiness to this gray stain, answering the call for a neutral that pairs well with paints, interior décor, and current countertop trends.

Paint on Saybrooke and Sinclair

Page 20

We are pleased to announce we have added paint finish options to two of our bestselling partial overlay door styles. Saybrooke is now available in Antique, Stone Gray and White, while Sinclair is available in Stone Gray and White.



Burlap Stain

Page 19-20

Launched last summer, Burlap is a transitional, medium brown stain featuring a touch of gray, that mingles effortlessly with a wide variety of contemporary wood tones. Available on Birch, Rustic Birch and Maple, this on-trend, fashionable finish provides a fresh look flexible enough to go with almost any décor.

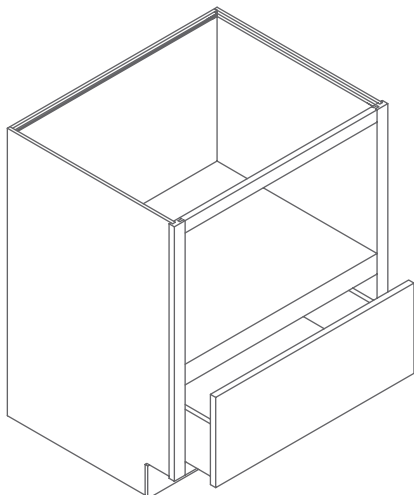

Open Shelf Base Microwave

Page 178

This new cabinet will feature a matching interior, deep drawer at bottom of cabinet, reduced width top cross rail on frame and opening positioned higher than our current microwave shelves.

TABLE OF CONTENTS

Product Description Index	2-3
Product Code Index	4-5
Characteristics of Wood	6
Characteristics of Paint and Laminate/Humidification Effects	7
Door Styles	8-18
Finish Descriptions and Process	19
Finish Availability	20
Door Style Numbers	21-24
Common Style Numbers	25
Construction Specifications	26
Ordering Information	27
Mullion Door Information	28
Cabinet Specifications	29-32
Design Checklist/Tips to the Installer	33
NKBA Guidelines	34-35
Moulding Solutions	36-37
Organization Solutions	38
Wall Cabinets	39-86
Wall Cabinets/Straight	39-64
Wall Cabinets/Wood Hoods	65-69
Wall Cabinets/Corner	69-82
Wall Cabinets/End	83
Wall Cabinets/Peninsula	84-86
Base Cabinets	87-105
Base Cabinets/Straight	87-95
Base Cabinets/Sink	96-98
Base Cabinets/Drawer	99
Base Cabinets/Microwave	100-101
Base Cabinets/Corner	101-104
Base Cabinets/End	104-105
Base Cabinets/Peninsula	105
Tall Cabinets	106-119
Other Room Cabinets	120-123
Vanity Cabinets	124-136
Universal Design Cabinets	137-142
Mouldings & Trim	143-164
Accessories & Parts	164-184
Warped Door Policy/Cabinet Care Suggestions	185
Policies/Information	186
Warranty	186

Desc	Code	Page	Desc	Code	Page
Angled Fluted Filler	BLVDFF	150	Diagonal Corner Wall w/Mullion Doors	DCMD	73
Angled Heat Shield	HEATSHIELDAN	169	Diagonal Glass Shelf Kit	GSKDC	168
Art Corbel	CORBELART	154	Dishwasher Panel	PDWP	160
Bar Bracket Corbel	BARCORBEL8	153	Double Oven Cabinet w/Butt Doors	OD..B	107
Base Box Column Pull-out Cabinet	BBCPO	91	Double Wastebasket Roll-out Kit	DWBR	172
Base Built-in Microwave Cabinet	BMW..35	100	End Panel w/Stile	PEPR	159
Base Built-in Microwave Cabinet Universal Design	BMW..32.5	141	English Bar Column Leg	ENGBARCOLUMN	157
Base Cabinet	B	87	English Island Column Leg	ENGLISCOLUMN	157
Base Cabinet Universal Design	B..32.5	137	Filler	F	150
Base Cabinet w/Butt Doors	B..B	87	Filler Fluted	FFL	150
Base Cabinet w/Butt Doors Universal Design	B..32.5B	137	Filler Reeded	FF	150
Base Cabinet w/Doors Prepped for Glass	BPG	93	Filter for Wood Hood Blower	FILTER	69
Base Cabinet w/Double Roll Tray	B..RT-2	88	Floating Shelves	FS	64
Base Cabinet w/Double Roll Trays & Butt Doors	B..RT2B	88	Four Drawer Base	DB-4	99
Base Cabinet w/Full Height Butt Doors	B..FHB	91	Frame Spacer	HNGSPCRF	174
Base Cabinet w/Full Height Butt Doors, 12" Deep	B..FH-12B	90	Full Overlay Crown Moulding	MFOLCR8	144
Base Cabinet w/Full Height Butt Doors Universal Design	B..32.5FHB	137	Glass Shelf Kit	GSK	168
Base Cabinet w/Full Height Doors	B..FH	90	Hardware	H	179
Base Cabinet w/Full Height Doors, 12" Deep	B..FH-12	90	Hinge Angle Restrictor Clip	HNGRESCLP	174
Base Cabinet w/Full Height Doors Universal Design	B..32.5FH	137	Hinge Spacer	HNGSPCRD	174
Design			Insert Crown Moulding	MICROWN8	144
Base Cabinet w/Mullion Doors	BMD	92	Island Leg	ISLEG	157
Base Cabinet w/Roll Tray	B..RT	88	Kneespace Drawer	KDT	123
Base Cabinet w/Roll Tray & Butt Doors	B..RTB	88	Laminate End Panel	EPA	161
Base Cabinet w/Tray Divider	B..TD	87	Large Corbel	LGCORBEL	155
Base Corner	BC	104	Large Cove Crown Moulding	MLCOVECR8	144
Base Corner Cabinet Universal Design	BC..32.5	141	Light Rail Moulding	MLR	148
Base Corner Filler	BCF	150	Light Rail Moulding	MLR	148
Base End Cabinet	BEC	105	Linen Closet Shelf Kit	LKS	136
Base End Cabinet	BEFC	104	Linen Closet SuperCabinet™ w/Removable Hamper	LCD..SC	135
Base Lazy Susan	BLS	102	Linen Closet w/Drawer	LCD	134
Base Lazy Susan Universal Design	BLS..32.5	139	Microwave Cabinet	TMW	109
Base Microwave Cabinets w/Deep Drawer	BMW..DD	100	Microwave Wall Open Shelf	MWOL	63
Base Open Cabinet	BOL	92	Microwave Wall Cabinet w/Butt Doors	MWC..B	61
Base Pantry Pull-out Cabinet	BPP	91	Mission Corbel	CORBELMIS	155
Base Pots & Pans Pull-out	BPPP	94	Organizer Shelves	ORG	165
Base Roto Easy Reach Cabinet	BRER	101	Outside Corner Moulding	MOCW	143
Base Shoe Moulding	MBS8	149	Oven Cabinet w/Butt Doors	OCSD..B	106
Base SuperCabinet™ Pull-out/Roll-out w/Butt Doors	BSC..PRB	89	Oven Installation Kit	OCINSTALLKIT	169
Base SuperCabinet™	BSC..PRPB		Oven with Microwave Cabinet	OMS	112
Pull-out/Roll-out/Pull-out w/Butt Doors		90	Overlay	OL	152
Base SuperCabinet™ Roll-out/Pull-out w/Butt Doors	BSC..RPB	89	Pantry Roll Tray Kit	UPK	171
Base Wastebasket	BWB	94	Pantry SuperCabinet™	PSC	115
Base Wastebasket, Full Height Doors w/Bottom Mount Guide	BWB15FHBMG	95	Pantry SuperCabinet™ w/Butt Doors	PSC..B	115
Base Wastebasket w/Bottom Mount Guide	BWB..BMG	95	Pegged Dish Organizer	PDO	167
Base Wastebasket w/Full Height Doors	BWB..FH	94	Pegged Dish Organizer Posts	PDOPOSTS	167
Batten Moulding	MBAT8	147	Peninsula Base	PB	105
Beadboard Panel	BP	160	Peninsula Base w/Butt Doors	PB..B	105
Bookcase Base	BKB	121	Peninsula Wall Cabinet	PW	84
Bookcase Base w/Butt Doors	BKB..B	121	Peninsula Wall Cabinets w/4 Butt Doors Prepped for Glass	PWPG..B	86
Bookcase	BK	120	Peninsula Wall Cabinet w/Butt Doors	PW..B	84
Bookshelf Kit	BKSHELFKIT	165	Peninsula Wall Cabinet w/Mullion Butt Doors	PWMD..B	85
Box Column Filler, Base	B33527BCF	151	Pint of Stain	STAINPT	175
Box Column Filler, Tall	T39627BCF	151	Pint of Toner	TONERPT	175
Box Column Filler, Wall	W34215BCF	151	Plastic Cutlery Drawer Tray	PCDT	167
Bun Lille Foot	BUNLIFFOOT	156	Plywood End Panel w/Stile	PEPRPLY	159
CabMat™	CABMAT36	168	Plywood Refrigerator End Panel w/Stile	PREPRP	159
Canopy Wood Hood, Arch	WHCA	65	PureStyle™ Crown Moulding	PSMCROWN8	144
Chrome Tray Divider Kit	CTDK	172	PureStyle™ Full Overlay Crown Moulding	PSMFOLCR8	144
Counter Top Moulding Bevel	MCTB	146	PureStyle™ Insert Crown Moulding	PSMICROWN8	144
Counter Top Moulding Radius	MCTR8	146	PureStyle™ Quarter Round Moulding	MQR8	147
Counter Top Moulding Traditional	MCTT8	146	PureStyle™ Scribe Moulding	PSMSW8	143
Country Sink Base	CNTYSB	97	PureStyle™ Tall Crown Moulding	PSMTCROWN8	144
Country Sink Base w/Butt Doors	CNTYSB..B	97	PureStyle™ Tall Light Rail Moulding	PSMTRL8	148
Cove Moulding	MCV	147	PureStyle™ Traditional Cap Moulding	PSMTCAP8	148
Cove Shaker Corbel	COVECORBEL12	153	PureStyle™ Traditional Soffit Trim Moulding	PSMTST8	147
Craftsman Foot	CRAFTFOOT	156	PureStyle™ Trim Moulding	PSMTW8	143
Crown Moulding	MCROWN8	144	PureStyle™ Triple Bead Moulding	PSMTBEAD8	143
Crown Moulding Shaker	MSHKRCROWN8	144	Quarter Round Moulding	PSMQR8	147
Decorative Angled/Fluted/Plain Filler	F..A	150	Quart of Stain	STAINQT	175
Decorative Base End Panel	DBEP	162	Range Panel	RP	163
Decorative End Panel 32.5	DVEP32.5	162	Reed Leg	RDLEG	157
Decorative End Panel Full Height	DBEPFH	162	Refrigerator End Panel	PREF	159
Decorative End Panel Full Height, 12" Deep	DBEPFH-12	162	Refrigerator End Panel w/Stile	PREPR	159
Decorative Mission Leg	DLEGMSSION	157	Refrigerator Wall Cabinet	RW	58
Decorative Peninsula Base End Panel	DPBEP	162	Refrigerator Wall Cabinet w/Butt Doors	RW..B	58
Decorative Utility End Panel	DUEP	162	Removable Vanity Wall Sink Cabinet	RVWS	142
Decorative Vanity End Panel	DVEP	162	Roll Tray Bumper Pad	RTBP	172
Decorative Wall End Panel	DWEP	162	Roll Tray Kit	TKIT	171
Dentil Moulding	MDENTIL	149	Rope Moulding	MROPE8	149
Diagonal Corner Roto Wall Cabinet	DCR	79	Shaker Corbel	SHKCORBEL11	154
Diagonal Corner Wall Cabinet	DC	69	Sink Base Diagonal Corner Cabinet	SBDC	97
Diagonal Corner Wall Open Cabinet	DCOL	72	Sink Base SuperCabinet™ w/Butt Doors	SB..STNSB	97
Diagonal Corner Wall Prepped for Glass	DCPG	76	Sink Base SuperCabinet™ w/Butt Doors	SB..STSB	96
			Sink Base w/Butt Doors Universal Design	SB..32.5B	138
			Sink Front Corner	SFC	98

Desc	Code	Page	Desc	Code	Page
Sink Front End Panel	PSFEP	159	Wall End Cabinet	WECL	83
Sink Front w/Butt Doors Universal Design	SF..32.5B	138	Wall Message Center Cabinet	WMC	61
Sink/Range Base	SB	96	Wall Open Cabinet	WOL	44
Sink/Range Base w/Butt Doors	SB..B	96	Wall Spice Rack	SRD	166
Sink/Range Front	SF	98	Wall System Shelf	WSS	164
Sink/Range Front w/Butt Doors	SF..B	98	What-Not Shelf	WN	64
Sink Tilt-out Tray	STOT..WHB	173	Wine Cube	WCUBE	63
Sink Unit w/Front Panel Universal Design	SU..32.5	138	Wine Cube Drawer	WCUBEDRW	63
Small Corbel	SMCORBEL	155	Wine Rack Cabinet	WR	60
Small Cove Crown Moulding	MSMCOVECR8	144	Wine Storage Cabinets	WSC	63
Smart Stop™ Doors Mechanism	SSDM	173	Wood Cutlery Drawer Tray	WCDT	167
Soffit Filler Moulding	MSFM8	146	Wood Hood Blower	TWHBLOWER	68
Split Turning End	SPTREND	153	Wood Hood Chimney	WHC	66
Split Turning Reed	REED	153	Wood Hood Chimney Shiplap	WHCSL	67
Split Turning Spool	SPOOL	153	Wood Hood Chimney Tall	WHCT	66
Square Corner/Base Roto Easy Reach Cabinet	SCER	101	Wood Hood Conversion Kit	TWHCONVKIT	68
Square Corner Roto Base	SCR	102	Wood Hood Shiplap	WHSL	67
Square Corner Roto Base Universal Design	SCR..32.5	139	Wood Hood Square	WHS	66
Square Corner Wall Cabinet	SC	81	Wood Scribe Moulding	MSW8	143
Square Corner Wall Cabinet w/Butt Doors	SC..B	81	6-way Adjustable Hinge	HINGE6WAY	173
Square Foot	SQFOOT	156	6-way Adjustable Hinge	HINGE6WAYSC	173
Starter Moulding	MSTR8	145			
Starter Moulding Shaker	MSFMS8	145			
Stem Glass Holder	SGH	165			
Stock Panel - Aristex™ Laminate	PA	160			
Stock Panel - Veneer	P	160			
Stock Panel - Veneer	PP	160			
Straight Bar Leg	STBARLEG	157			
Straight Heat Shield	HEATSHIELDST	169			
Straight Island Leg	STISLEG	157			
Tall Crown Moulding	MTCROWN8	144			
Tall Light Rail Moulding	MTLR8	148			
Tapered Leg	TAPLEG	156			
Tapered Wood Hood	TWH	65			
Three Drawer Base	DB	99			
Three Drawer Base Universal Design	DB..32.5	139			
Three Drawer Base w/False Panel	DBFP	99			
Toekick	TOEKICK	164			
Toekick Cap	TKC	164			
Toekick Filler	TKF	150			
Toekick Tulip Foot	TKTLFOOT	156			
Touch-up Kit	TUKIT	175			
Touch-up Spray Can	TUPSPRAY	175			
Touch-Up Stick	TUPSTICK	175			
Traditional Batten Moulding	MTBAT8	149			
Traditional Cap Moulding	MTCAP8	148			
Traditional Soffit Trim Moulding	MTST8	147			
Traditional Trim Moulding	MTT8	148			
Trim Moulding	MTW8	143			
Triple Bead Moulding	MTBEAD8	143			
Utility Cabinet	U	117			
Utility Cabinet w/Butt Doors	U..B	117			
Utility Shelf Kit	UKS	170			
Valance Arch	V..RA	158			
Valance Corbel	VCORBEL	154			
Valance Straight	V..ST	158			
Vanity Base	VB	124			
Vanity Base Pull-out	VBP	126			
Vanity Base w/Butt Doors	VB..B	125			
Vanity Console Base	VCB	125			
Vanity Console Base w/Butt Doors	VCB..B	124			
Vanity Double Drawer Base	Vddb	127			
Vanity Double Drawer Base Trimmable	VddbT	128			
Vanity Drawer Trimmable	VDT..B	133			
Vanity File Drawer	VFD	122			
Vanity File Drawer Base	VFDB	121			
Vanity Four Drawer Base	VDB-4	132			
Vanity Medicine Cabinet	VMC	135			
Vanity Sink Base	VSb	129			
Vanity Sink Base w/Butt Doors	VSb..B	129			
Vanity Doors & Drawer Base	VSD	126			
Vanity Sink Drawer Base	VSDB	131			
Vanity Tank Topper	VTT..B	133			
Vanity Tapered End Panel	VTEP	163			
Vanity Tapered End Panel 32.5	VTEP32.5	163			
Vanity Three Drawer Base	VDB	131			
Vanity Tri-View Medicine Cabinet	VTMC	135			
Vanity Wall Cabinet	VWC	133			
Vanity Wall Sink Cabinet	VWS	142			
Veneer End Panel	EPV	161			
Wall Cabinet	W	39			
Wall Cabinet w/Butt Doors	W..B	39			
Wall Cabinet w/Butt Doors Prepped for Glass	WPG..B	55			
Wall Cabinet w/Doors Prepped for Glass	WPG	53			
Wall Cabinet w/Mullion Doors	WMD	48			
Wall Cabinet w/Mullion Butt Doors	WMD..B	49			
Wall Drawer Unit	WD	60			
Wall Easy Reach Cabinet	WER	79			
Wall End Cabinet	WEC	83			

Code	Description	Page	Code	Description	Page
B	Base Cabinet	87	GSK	Glass Shelf Kit	168
B..32.5	Base Cabinet Universal Design	137	GKDC	Diagonal Glass Shelf Kit	168
B..B	Base Cabinet w/Butt Doors	87	H	Hardware	179
B..32.5B	Base Cabinet w/Butt Doors Universal Design	137	HEATSHIELDAN	Angled Heat Shield	169
B..FH	Base Cabinet w/Full Height Doors	90	HEATSHIELDST	Straight Heat Shield	169
B..32.5FH	Base Cabinet w/Full Height Doors Universal Design	137	HINGE6WAY	6-way Adjustable Hinge	173
B..FHB	Base Cabinet w/Full Height Butt Doors	91	HINGE6WAYSC	6-way Adjustable Hinge	173
B..32.5FHB	Base Cabinet w/Full Height Butt Doors Universal Design	137	HNGSPCRD	Hinge Spacer	174
B..FH-12	Base Cabinet w/Full Height Doors, 12" Deep	90	HNGSPCRF	Frame Spacer	174
B..FH-12B	Base Cabinet w/Full Height Butt Doors, 12" Deep	90	HNGRESCLP	Hinge Angle Restrictor Clip	174
B..RT-2	Base Cabinet w/Double Roll Tray	88	ISLEG	Island Leg	157
B..RT	Base Cabinet w/Roll Tray	88	KDT	Kneespace Drawer	123
B..RT2B	Base Cabinet w/Double Roll Trays & Butt Doors	88	LCD	Linen Closet w/Drawer	134
B..RTB	Base Cabinet w/Roll Tray & Butt Doors	88	LCD..SC	Linen Closet SuperCabinet™ w/Removable Hamper	135
B..TD	Base Cabinet w/Tray Divider	87	LGCORBEL	Large Corbel	155
B33527BCF	Box Column Filler, Base	151	LKS	Linen Closet Shelf Kit	136
BARCORBEL8	Bar Bracket Corbel	153	MBAT8	Batten Moulding	147
BBCPO	Base Box Column Pull-out Cabinet	91	MBS8	Base Shoe Moulding	149
BC	Base Corner	104	MCROWN8	Crown Moulding	144
BC..32.5	Base Corner Cabinet Universal Design	141	MCTB8	Counter Top Moulding Bevel	146
BEC	Base End Cabinet	105	MCTR8	Counter Top Moulding Radius	146
BECF	Base End Cabinet	104	MCTT8	Counter Top Moulding Traditional	146
BK	Bookcase	120	MCV8	Cove Moulding	147
BKB	Bookcase Base	121	MDENTIL8	Dentil Moulding	149
BKB..B	Bookcase Base w/Butt Doors	121	MFOLCR8	Full Overlay Crown Moulding	144
BKSHELFKIT	Bookshelf Kit	165	MICROWN8	Insert Crown Moulding	144
BLS	Base Lazy Susan	102	MLCOVECR8	Large Cove Crown Moulding	144
BLS..32.5	Base Lazy Susan Universal Design	139	MLR8	Light Rail Moulding	148
BLVDF	Angled Fluted Filler	150	MOCW8	Outside Corner Moulding	143
BMD	Base Cabinet w/Mullion Doors	92	MQR8	Quarter Round Moulding	147
BMW..35	Base Built-in Microwave Cabinet	100	MROPE8	Rope Moulding	149
BMW..32.5	Base Built-in Microwave Cabinet Universal Design	141	MSFM8	Soffit Filler Moulding	146
BMW..DD	Base Microwave Cabinets w/Deep Drawer	100	MSFM58	Starter Moulding Shaker	145
BOL	Base Open Cabinet	92	MSHKRCROWN8	Crown Moulding Shaker	144
BP	Beadboard Panel	160	MSMCOVECR8	Small Cove Crown Moulding	144
BPG	Base Cabinet w/Doors Prepped for Glass	93	MSTR8	Starter Moulding	145
BPP	Base Pantry Pull-out Cabinet	91	MSW8	Wood Scribe Moulding	143
BPPP	Base Pots & Pans Pull-out	94	MTBAT8	Traditional Batten Moulding	149
BRER	Base Roto Easy Reach Cabinet	101	MTBEAD8	Triple Bead Moulding	143
BSC..PRB	Base SuperCabinet™ Pull-out/Roll-out w/Butt Doors	89	MTCAP8	Traditional Cap Moulding	148
BSC..PRPB	Base SuperCabinet™ Pull-out/Roll-out/Pull-out w/Butt Doors	90	MTCROWN8	Tall Crown Moulding	144
BSC..RPB	Base SuperCabinet™ Roll-out/Pull-out w/Butt Doors	89	MTLR8	Tall Light Rail Moulding	148
BUNLIFFOOT	Bun Lille Foot	156	MTST8	Traditional Soffit Trim Moulding	147
BWB	Base Wastebasket	94	MTW8	Trim Moulding	143
BWB..BMG	Base Wastebasket w/Bottom Mount Guide	95	MWC..B	Microwave Wall Cabinet w/Butt Doors	61
BWB..FH	Base Wastebasket w/Full Height Doors	94	MWOL	Microwave Wall Open Shelf	63
BWB15FHBMG	Base Wastebasket, Full Height Doors w/Bottom Mount Guide	95	OCSD..B	Oven Cabinet w/Butt Doors	106
CABMAT36	CabMat™	168	OD..B	Double Oven Cabinet w/Butt Doors	107
CNTYSB	Country Sink Base	97	OCINSTALLKIT	Oven Installation Kit	169
CNTYSB..B	Country Sink Base w/Butt Doors	97	OMS	Oven with Microwave Cabinet	112
CORBELART	Art Corbel	154	OL	Overlay	152
CORBELMIS	Mission Corbel	155	ORG	Organizer Shelves	165
COVECORBEL12	Cove Shaker Corbel	153	P	Stock Panel - Veneer	160
CRAFTFOOT	Craftsman Foot	156	PA	Stock Panel - Aristex™ Laminate	160
CTDK	Chrome Tray Divider Kit	172	PB	Peninsula Base	105
DB	Three Drawer Base	99	PB..B	Peninsula Base w/Butt Doors	105
DB..32.5	Three Drawer Base Universal Design	139	PCDT	Plastic Cutlery Drawer Tray	167
DB-4	Four Drawer Base	99	PDO	Pegged Dish Organizer	167
DBEP	Decorative Base End Panel	162	PDOPOSTS	Pegged Dish Organizer Posts	167
DBFP	Three Drawer Base w/False Panel	99	PDWP	Dishwasher Panel	160
DBEPFH	Decorative End Panel Full Height	162	PEPR	End Panel w/Stile	159
DBEPFH-12	Decorative End Panel Full Height, 12" Deep	162	PEPRPLY	Plywood End Panel w/Stile	159
DC	Diagonal Corner Wall Cabinet	69	PP	Stock Panel - Veneer	160
DCMD	Diagonal Corner Wall w/Mullion Doors	73	PREF	Refrigerator End Panel	159
DCOL	Diagonal Corner Wall Open Cabinet	72	PREPR	Refrigerator End Panel w/Stile	159
DCPG	Diagonal Corner Wall Prepped for Glass	76	PREPRP	Plywood Refrigerator End Panel w/Stile	159
DCR	Diagonal Corner Roto Wall Cabinet	79	PSC	Pantry SuperCabinet™	115
DLEGMISION	Decorative Mission Leg	157	PSC..B	Pantry SuperCabinet™ w/Butt Doors	115
DPBEP	Decorative Peninsula Base End Panel	162	PSFEP	Sink Front End Panel	159
DUEP	Decorative Utility End Panel	162	PSMCROWN8	PureStyle™ Crown Moulding	144
DVEP	Decorative Vanity End Panel	162	PSMFOLCR8	PureStyle™ Full Overlay Crown Moulding	144
DVEP32.5	Decorative End Panel 32.5	162	PSMICROWN8	PureStyle™ Insert Crown Moulding	144
DWBR	Double Wastebasket Roll-out Kit	172	PSMQR8	PureStyle™ Quarter Round Moulding	147
DWEP	Decorative Wall End Panel	162	PSMSW8	PureStyle™ Scribe Moulding	143
ENGBARCOLUMN	English Bar Column Leg	157	PSMTBEAD8	PureStyle™ Triple Bead Moulding	143
ENGISLCOLUMN	English Island Column Leg	157	PSMTCAP8	PureStyle™ Traditional Cap Moulding	148
EPA	Laminate End Panel	161	PSMTCROWN8	PureStyle™ Tall Crown Moulding	144
EPV	Veneer End Panel	161	PSMTLR8	PureStyle™ Tall Light Rail Moulding	148
F	Filler	150	PSMTST8	PureStyle™ Traditional Soffit Trim Moulding	147
F..A	Decorative Angled/Fluted/Plain Filler	150	PSMTW8	PureStyle™ Trim Moulding	143
FBC	Base Corner Filler	150	PW	Peninsula Wall Cabinet	84
FF	Filler Reeded	150	PW..B	Peninsula Wall Cabinet w/Butt Doors	84
FFL	Filler Fluted	150	PWMD..B	Peninsula Wall Cabinet w/Mullion Butt Doors	85
FS	Floating Shelves	64	PWPG..B	Peninsula Wall Cabinets w/4 Butt Doors Prepped for Glass	86
FILTER	Filter for Wood Hood Blower	69	RDLEG	Reed Leg	157
			REED	Split Turning Reed	153
			RP	Range Panel	163
			RTBP	Roll Tray Bumper Pad	172

Code	Description	Page	Code	Description	Page
RVWS	Removable Vanity Wall Sink Cabinet	142	WHCA	Canopy Wood Hood, Arch	65
RW	Refrigerator Wall Cabinet	58	WHCSL	Wood Hood Chimney Shiplap	67
RW..B	Refrigerator Wall Cabinet w/Butt Doors	58	WHS	Wood Hood Square	66
SB	Sink/Range Base	96	WHSL	Wood Hood Shiplap	67
SB..B	Sink/Range Base w/Butt Doors	96	WMC	Wall Message Center Cabinet	61
SB..32.5B	Sink Base w/Butt Doors Universal Design	138	WMD	Wall Cabinet w/Mullion Doors	48
SB..STNSB	Sink Base SuperCabinet™ w/Butt Doors	97	WMD..B	Wall Cabinet w/Mullion Butt Doors	49
SB..STSB	Sink Base SuperCabinet™ w/Butt Doors	96	WN	What-Not Shelf	64
SBDC	Sink Base Diagonal Corner Cabinet	97	WOL	Wall Open Cabinet	44
SC	Square Corner Wall Cabinet	81	WPG	Wall Cabinet w/Doors Prepped for Glass	53
SC..B	Square Corner Wall Cabinet w/Butt Doors	81	WPG..B	Wall Cabinet w/Butt Doors Prepped for Glass	55
SCER	Square Corner/Base Roto Easy Reach Cabinet	101	WR	Wine Rack Cabinet	60
SCR	Square Corner Roto Base	102	WSC	Wine Storage Cabinets	63
SCR..32.5	Square Corner Roto Base Universal Design	139	WSS	Wall System Shelf	164
SF	Sink/Range Front	98			
SF..B	Sink/Range Front w/Butt Doors	98			
SF..32.5B	Sink Front w/Butt Doors Universal Design	138			
SFC	Sink Front Corner	98			
SGH	Stem Glass Holder	165			
SHKCORBEL11	Shaker Corbel	154			
SMCORBEL	Small Corbel	155			
SPOOL	Split Turning Spool	153			
SPTRINGEND	Split Turning End	153			
SQFOOT	Square Foot	156			
SRD	Wall Spice Rack	166			
SSDM	Smart Stop™ Doors Mechanism	173			
STAINPT	Pint of Stain	175			
STAINQT	Quart of Stain	175			
STBARLEG	Straight Bar Leg	157			
STISLEG	Straight Island Leg	157			
STOT..WHB	Sink Tilt-out Tray	173			
SU..32.5	Sink Unit w/Front Panel Universal Design	138			
T39627BCF	Box Column Filler, Tall	151			
TAPLEG	Tapered Leg	156			
TKC	Toekick Cap	164			
TKF	Toekick Filler	150			
TKIT	Roll Tray Kit	171			
TKTLFOOT	Toekick Tulip Foot	156			
TMW	Microwave Cabinet	109			
TOEKICK	Toekick	164			
TONERPT	Pint of Toner	175			
TUKIT	Touch-up Kit	175			
TUPSPRAY	Touch-up Spray Can	175			
TUPSTICK	Touch-up Stick	175			
TWH	Tapered Wood Hood	65			
TWHBLOWER	Wood Hood Blower	68			
TWHCONVKIT	Wood Hood Conversion Kit	68			
U	Utility Cabinet	117			
U..B	Utility Cabinet w/Butt Doors	117			
UKS	Utility Shelf Kit	170			
UPK	Pantry Roll Tray Kit	171			
V..RA	Valance Arch	158			
V..ST	Valance Straight	158			
VB	Vanity Base	124			
VB..B	Vanity Base w/Butt Doors	125			
VBP	Vanity Base Pull-out	126			
VCB	Vanity Console Base	125			
VCB..B	Vanity Console Base w/Butt Doors	124			
VCORBEL	Valance Corbel	154			
VDB	Vanity Three Drawer Base	131			
VDB-4	Vanity Four Drawer Base	132			
VDDB	Vanity Double Drawer Base	127			
VDDBT	Vanity Double Drawer Base Trimmable	128			
VDT..B	Vanity Drawer Trimmable	133			
VFD	Vanity File Drawer	122			
VFDB	Vanity File Drawer Base	121			
VMC	Vanity Medicine Cabinet	135			
VSB	Vanity Sink Base	129			
VSB..B	Vanity Sink Base w/Butt Doors	129			
VSD	Vanity Doors & Drawer Base	126			
VSDB	Vanity Sink Drawer Base	131			
VTEP	Vanity Tapered End Panel	163			
VTEP32.5	Vanity Tapered End Panel 32.5	163			
VTMC	Vanity Tri-View Medicine Cabinet	135			
VTT..B	Vanity Tank Topper	133			
VWC	Vanity Wall Cabinet	133			
VWS	Vanity Wall Sink Cabinet	142			
W	Wall Cabinet	39			
W..B	Wall Cabinet w/Butt Doors	39			
W34215BCF	Box Column Filler, Wall	151			
WCDT	Wood Cutlery Drawer Tray	167			
WCUBE	Wine Cube	63			
WCUBEDRW	Wine Cube Drawer	63			
WD	Wall Drawer Unit	60			
WEC	Wall End Cabinet	83			
WECL	Wall End Cabinet	83			
WER	Wall Easy Reach Cabinet	79			
WHC	Wood Hood Chimney	66			
WHCT	Wood Hood Chimney Tall	66			

Wood Types

No matter which wood type you choose for your new kitchen or bath cabinetry, please keep in mind that no two pieces of wood are exactly the same. Stains are likely to exaggerate the difference between open and closed grains and other markings in wood. Grain variation and color change should be expected. As hardwood ages, it will darken when exposed to different types of light. Color differences or changes in wood can also be caused by exposure to harsh chemicals, extreme heat, or other contributing external conditions. Additionally, wood species exhibit other defining characteristics, such as mineral deposits/streaks, knots, sap runs, pin holes, and wormholes. These markings make the wood unique and contribute to its enduring beauty.

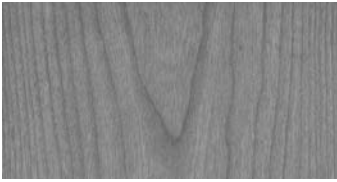

Cherry

- ▶ Top-of-the-line hardwood with a rich, natural reddish-brown tone
- ▶ Uniform tight grain allows finishes to be applied with ease
- ▶ Characteristics include mineral streaks, pin knots, and curly graining
- ▶ Darkens with age and exposure to light
- ▶ Smooth wood grain pattern with random markings

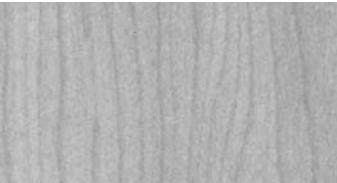

Maple

- ▶ Strong, resilient wood with a uniform tight grain and smooth, even appearance
- ▶ Mineral streaks are common and will appear darker with stain
- ▶ Subtle wood grain markings include fine lines and wavy or curly graining
- ▶ Small, black "bird's eye" dots

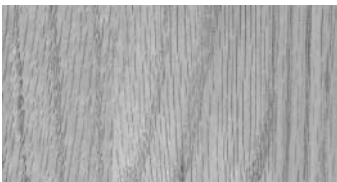

Oak

- ▶ Very strong wood with distinct grain patterns
- ▶ Grain variations create a color gradation when stain is applied
- ▶ Grain patterns include fine lines, pin stripes, leafy grains, and watery figures



Birch

- ▶ Even-textured, fine-grained wood with a curly or wavy pattern
- ▶ Strong with a high resistance to abrasion
- ▶ Smooth, dense surface texture
- ▶ Tight wood grain appearance

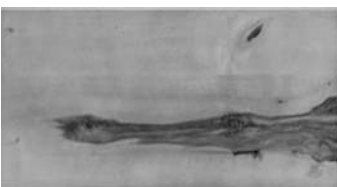

Rustic Characteristics

Solid-wood Doors and Drawer Fronts, may have varying amounts of the following:

- ▶ Sound Closed Knot (stable / not moveable) – Acceptable up to 3" in diameter
- ▶ Sound Knot with Cracks – Acceptable up to 2" in diameter, with open portion not to exceed $\frac{3}{4}$ " in diameter or length. May be completely visible through to back side of door.
- ▶ Open Knot – Acceptable up to $\frac{3}{4}$ " in diameter or length of open portion of knot. May be completely visible through to back side of door. (Note: Holes created by open knots are acceptable and desirable for this rustic look.)
- ▶ Unsound Knot (loose / moveable) – Unacceptable
- ▶ Knot Cluster (cluster of tight, sound knots) – Acceptable in all sizes and quantities
- ▶ Season Checks (crack) – Acceptable, as long as light does not pass through opening
- ▶ Worm / Pin Holes – Acceptable if present on less than 50% of door and less than $\frac{1}{4}$ " in diameter. May be completely visible through to back side of door.
- ▶ Worm Tracks – Acceptable if present on less than 50% of door and less than $\frac{1}{8}$ " in diameter and 8" in length
- ▶ Mineral Stains / Streaks / Deposits – Acceptable if present on less than 50% of door. May be black or brown in color.
- ▶ Natural Wood Figuring – Acceptable to have bird's eye, curly graining, burl graining or tiger striping if present on less than 50% of door

Veneer Panels / Mouldings / Other Trim Items:

- ▶ Will have few to no sound closed knots, sound knots with cracks, open knots, or knot clusters
- ▶ May have some visible worm / pin holes, mineral stains / streaks / deposits, or natural wood figuring

Characteristics of Paint

Paint will develop hairline cracks in the finish, most notable around the joints. This is a result of natural expansion and contraction of the genuine hardwoods used in the manufacturing of this product. Hairline cracks are not considered a defect in the cabinetry or finish and will not be considered a reason for product replacement.

Select components on painted door styles and accessories may be constructed of hardwood or Medium Density Fiberboard (MDF) to provide a smoother finish and be more resistant to warping, expansion, and contraction.

Characteristics of Laminates

Thermofoil

- ▶ Doors & drawer fronts are shaped MDF core covered with a seamless vinyl laminate on face & edges, and a melamine laminate on back
- ▶ Vinyl laminate is applied to MDF with an adhesive using heat & pressure
- ▶ Creates a product with excellent wear and heat resistance properties

PureStyle™

- ▶ Durable, laminate-based material that provides superior abrasion resistance
- ▶ Meets/exceeds all KCMA performance standards
- ▶ Wrapped door rails and panels
- ▶ Clear, pre-impregnated top coat for superior durability (glazed styles have an oven-cured top coat)
- ▶ Lineals and core panel material are made of MDF to ensure a consistent and stable product
- ▶ PureStyle™ doors can be distinguished from painted cabinets by their picture-perfect distribution of satin, smooth color

These doors offer the durability of a laminate and the beauty of paint, while bringing peace of mind to those who care about creating a better environment - both inside and outside of their homes. Molded decorative door profile with a durable, yet attractive finish offers care-free maintenance. In addition to a uniform appearance, cabinets will have:

- ▶ A sleek surface
- ▶ A design that replicates a painted finish with optimum durability
- ▶ A fresh, contemporary feel that is also at home in a more traditional setting

Humidification

Cabinet components are typically manufactured at a target range of 40%–50% relative humidity. This works well because even unhumidified homes stay between 20% and 70% in normal years with typical cooking and washing activities.

In extremely cold, dry winters some doors can be exposed to conditions where relative humidity is below 20% for weeks at a time, causing shrinkage to occur. Conversely, where in-home relative humidity exceeds 70% for extended periods of time, expansion could occur. In certain geographic locations of the country, it is natural for the humidity to reach and remain at 80% for several weeks during the new construction period. Exposure to sustained conditions such as these could cause opening of the joints, and will not be considered as a reason for product replacement.

Aristokraft recommends product be stored and installed in an atmosphere where the humidity level and temperature are controlled.

Humidification Effects on a Door with a Miter Joint

High Humidity

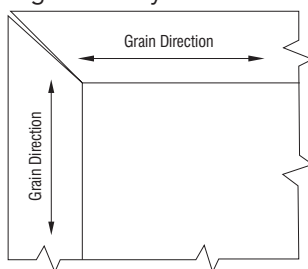

When wood swells, miter joints open as shown above.

Low Humidity

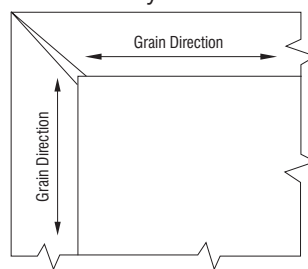

When wood shrinks, miter joints open as shown above.

Steps Consumers Can Take To Protect Real Wood Furnishings

- **Keep an eye on the humidity inside the home.** Reasonably accurate digital thermometers-hygrometer units are available to measure humidity.
- **Maintain the humidity at or above 20% when the temperature is below 20 degrees and over 35% when the temperature is above 20 degrees.** Some ways this may be accomplished are installing a whole-house humidifier on the furnace, running a portable humidifier in key rooms, or placing pans of water near the heat registers.
- **Don't over do it.** Significant condensation on windows is a sign the humidity levels are too high for outside temperature conditions.
- **Recognize that finished wood responds to humidity over a period of several days to several weeks.** It takes time before the wood returns to normal after any correction to the environment.

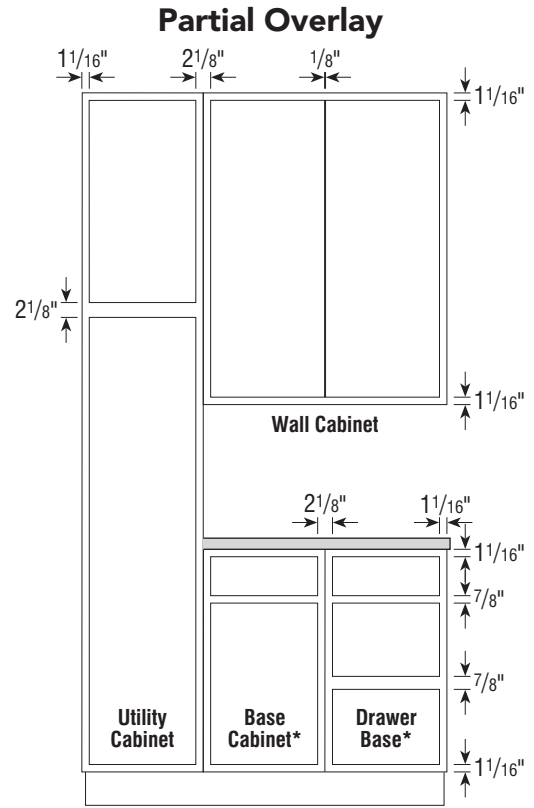
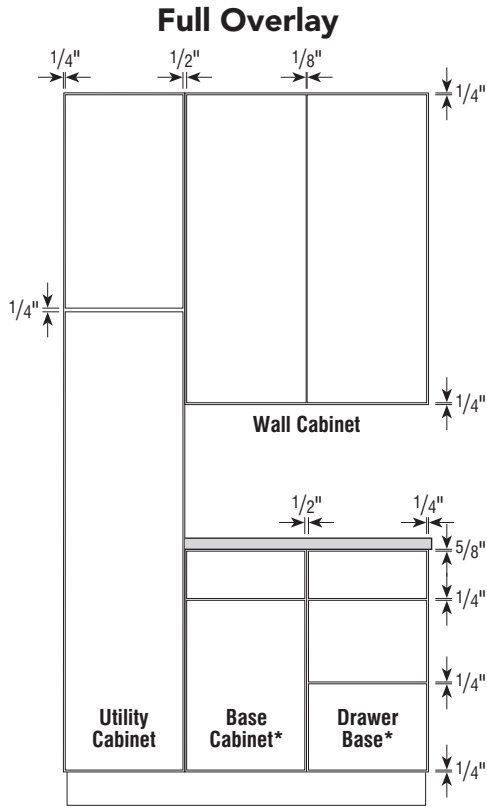

*35" high application shown
One double door center stile cabinet has the same reveal as two single door cabinets.

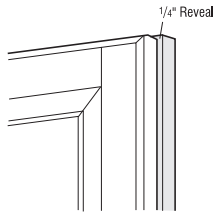

Full Overlay

► Full overlay doors reveal 1/4" of the cabinet face frame.

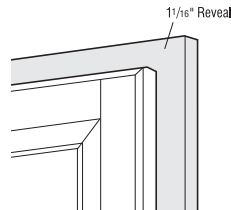

Partial Overlay 7/16"

► Partial overlay doors reveal 1 1/16" of the cabinet face frame.

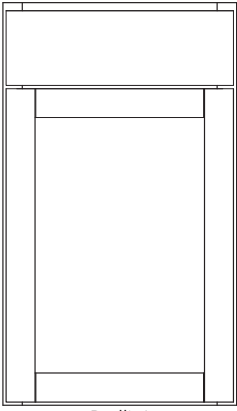

Brellin*
(page 12)

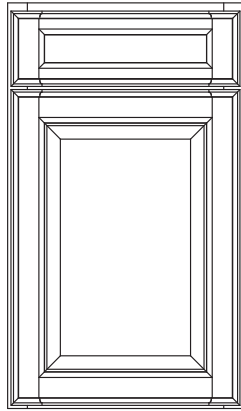

Briarcliff
(Also available in Arch)
(page 12)

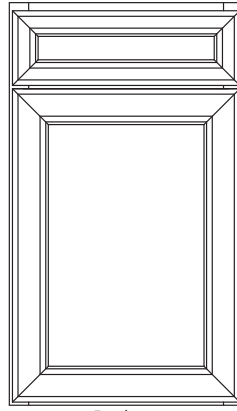

Durham
(page 13)

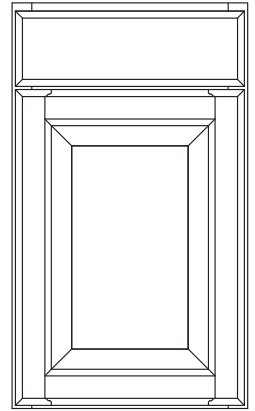

Eastland*
(page 13)

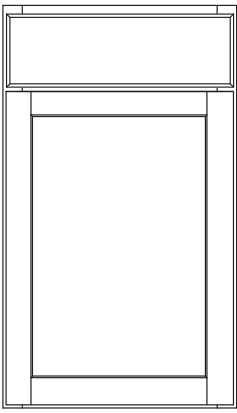

Harrison*
(page 14)

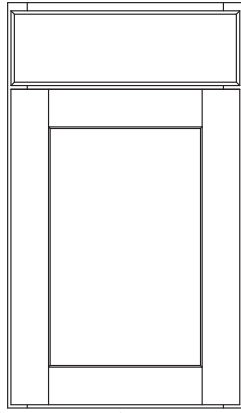

Korbett*
(page 14)

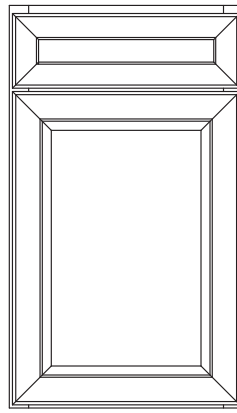

Overton
(page 15)

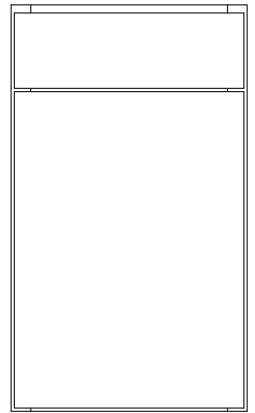

Teagan
(page 17)

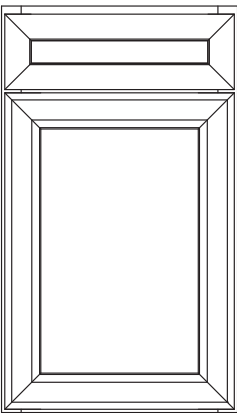

Wentworth
(page 17)

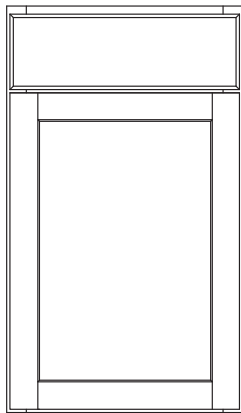

Winstead*
(page 18)

*Available with 5-piece Drawer Fronts

Partial Overlay Door Styles

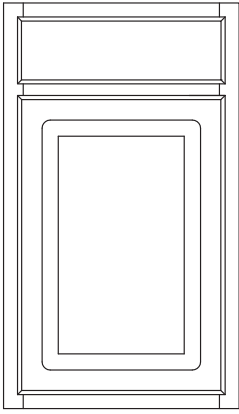

Augusta
(page 11)

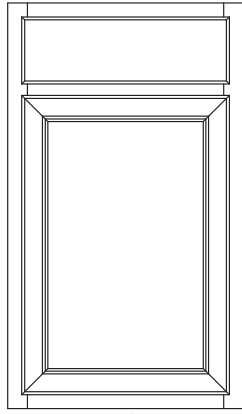

Avalon
(page 11)

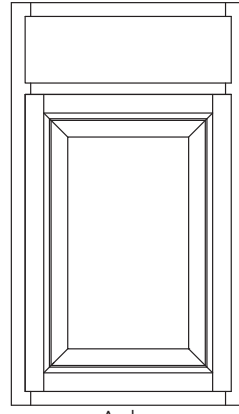

Ayden
(page 11)

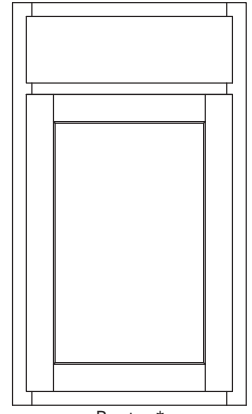

Benton*
(page 12)

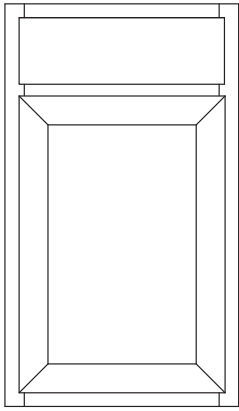

Ellis
(page 13)

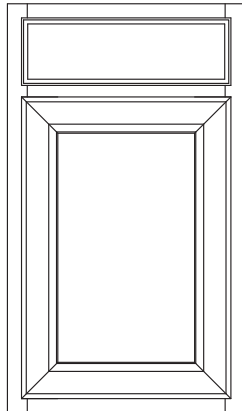

Landen*
(page 14)

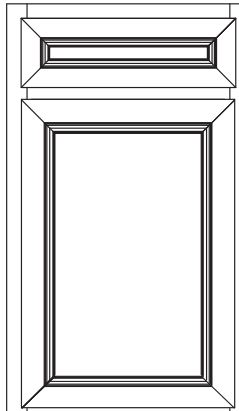

Lillian
(page 15)

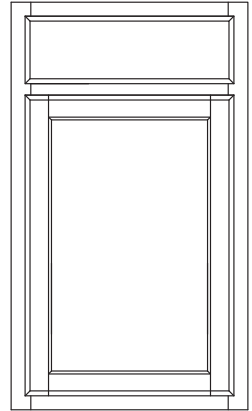

Oakland
(page 15)

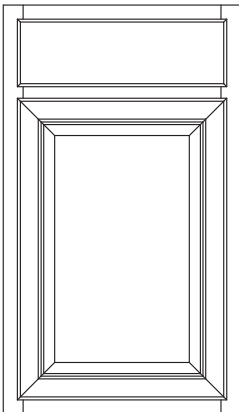

Radford
(page 16)

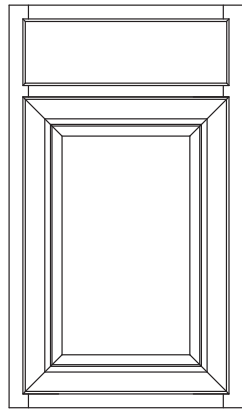

Saybrooke*
(page 16)

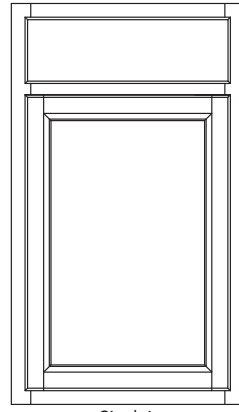

Sinclair
(page 16)

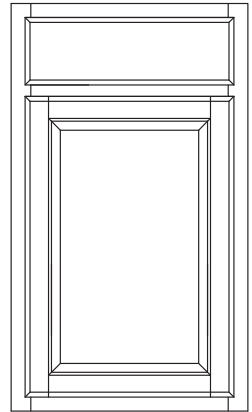

Westbury
(page 18)

*Available with 5-piece Drawer Fronts

DOOR STYLES

Augusta

Partial Overlay

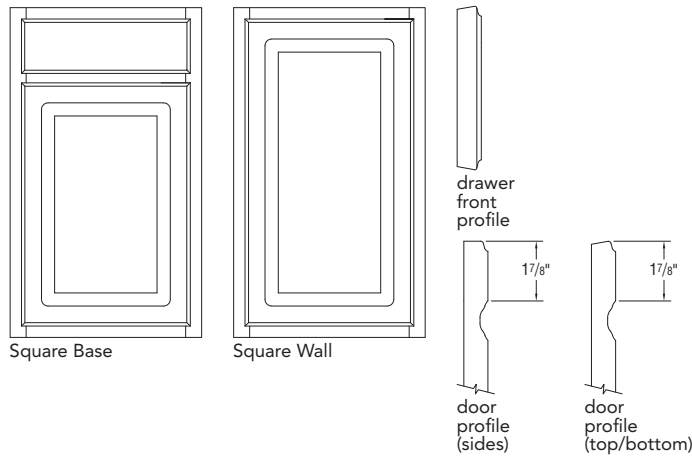

SPECIE & FINISH AVAILABILITY	
Thermofoil	Standard Finish

- ▶ Raised Panel Profile
- ▶ 3/4" Thick Door
- ▶ Reverse Bevel Profile, No Hardware Required

Note: Thermofoil will not withstand sustained temperatures in excess of 170°F. A 3" filler or heat shield is required between any thermofoil surface and any heat source to be in compliance with cabinet warranty.

Avalon

Partial Overlay

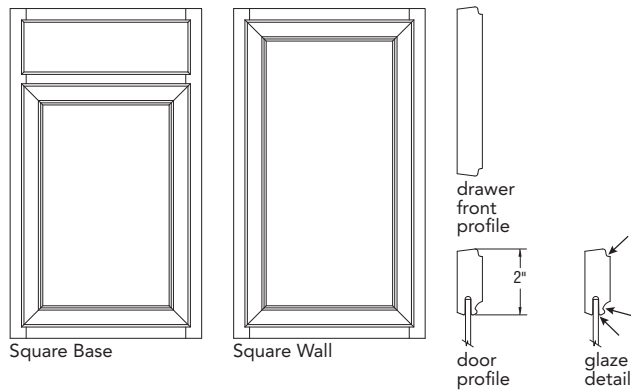

SPECIE & FINISH AVAILABILITY	
Cherry	Standard Finish
	Glaze
Maple	Standard Finish
	Glaze

- ▶ Flat Veneer Center Panel
- ▶ 3/4" Thick Solid Door Rail
- ▶ Miter Construction
- ▶ Reverse Bevel Profile, No Hardware Required

Ayden

Partial Overlay

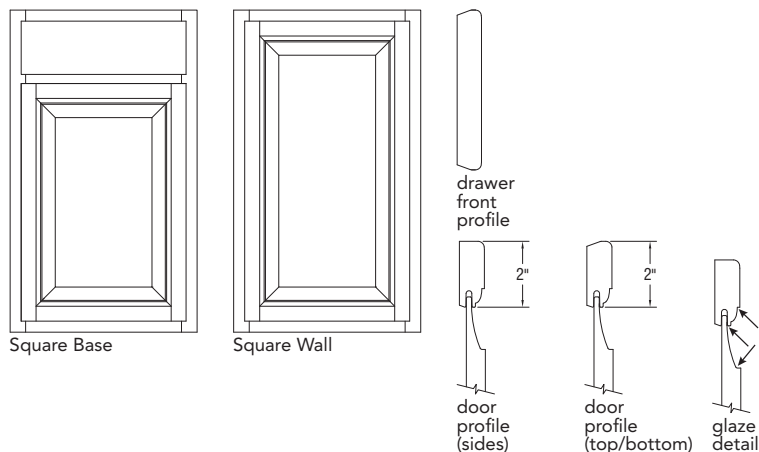

SPECIE & FINISH AVAILABILITY	
Rustic Birch	Standard Finish
	Glaze

- ▶ Raised Solid Center Panel
- ▶ 3/4" Thick Solid Door Rail
- ▶ Hardware Recommended
- ▶ Rustic Characteristics on Door and Drawer Fronts only
- ▶ Selected Rustic Trim Items Available. Use Common Styles for Maple Finishes When Not Available. See page 180.

Glazed edges indicated by arrows on side view drawings.

DOOR STYLES

Benton

Partial Overlay

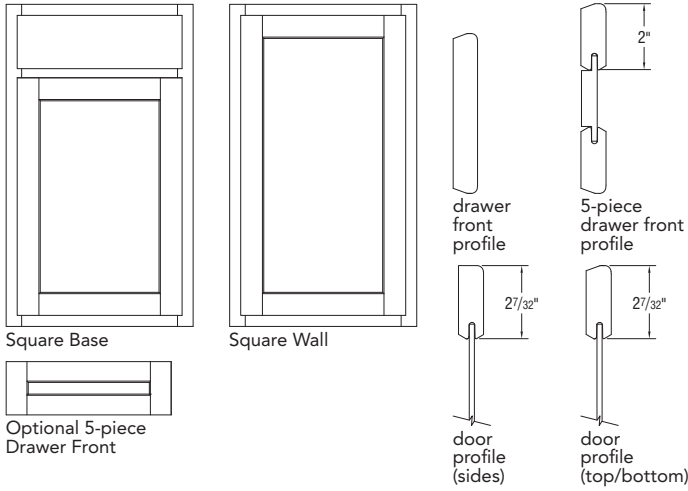

SPECIE & FINISH AVAILABILITY

Birch	Standard Finish
Paint	

- ▶ Flat Veneer Center Panel
- ▶ 3/4" Thick Solid Door Rail
- ▶ Birch Styles Use Maple Accessories
- ▶ Reverse Bevel Profile, No Hardware Required

Brellin

Full Overlay

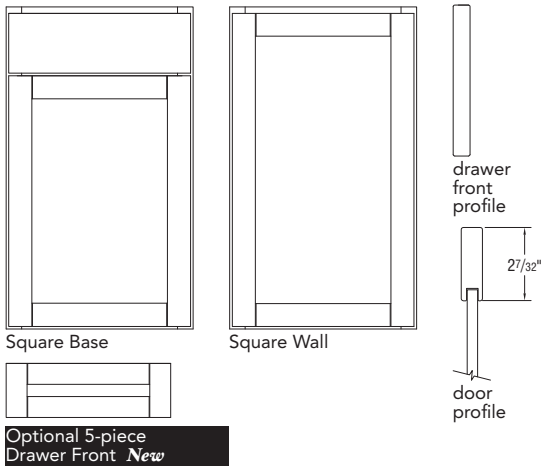

SPECIE & FINISH AVAILABILITY

PureStyle™	Standard Finish
------------	-----------------

- ▶ Flat Laminate Center Panel
- ▶ 3/8" Thick Door
- ▶ 6-way Adjustable Hinges
- ▶ Hardware Recommended

Briarcliff II

Full Overlay

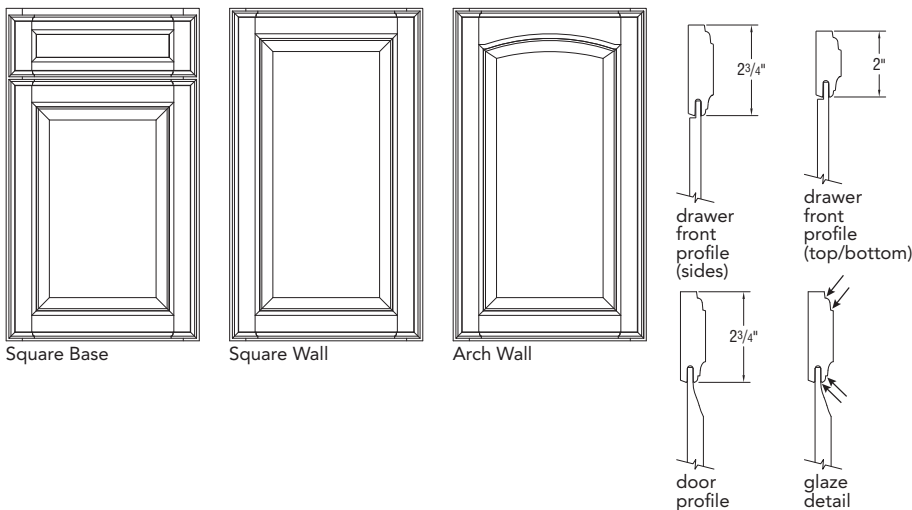

SPECIE & FINISH AVAILABILITY

Cherry	Standard Finish
	Glaze
Maple	Standard Finish
	Glaze
Paint	

- ▶ Raised Veneer Center Panel
- ▶ 3/4" Thick Solid Door Rail
- ▶ On 5-piece Drawer Front with Recessed Center Panel, Drawer Fronts 11 7/8" and Higher will have a Raised Veneer Center Panel with Vertical Grain.
- ▶ Hardware Recommended
- ▶ Square Doors on Base Cabinets
- ▶ Arch Available in Maple Only
- ▶ Arch only available on Wall Cabinets

Glazed edges indicated by arrows on side view drawings.

DOOR STYLES

Durham

Full Overlay

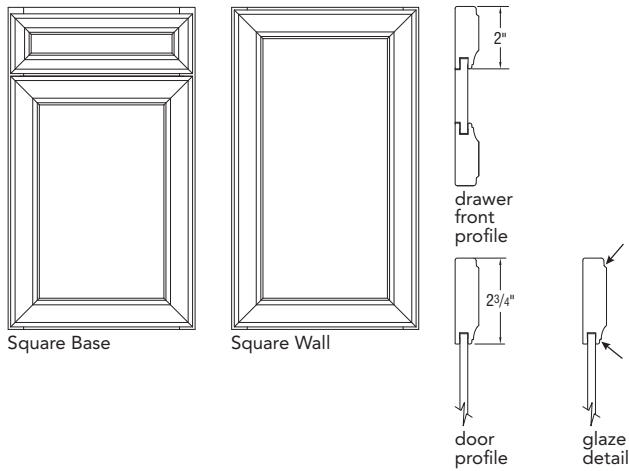

SPECIE & FINISH AVAILABILITY	
PureStyle™	Standard Finish

- ▶ 3/4" Thick Door Rail
- ▶ Miter Construction
- ▶ Flat Laminate Center Panel
- ▶ 5-piece Miter Drawer Front
- ▶ Toasted Antique Glaze Available on Selected Trim Items. See page 180.
- ▶ Hardware Recommended

Eastland

Full Overlay

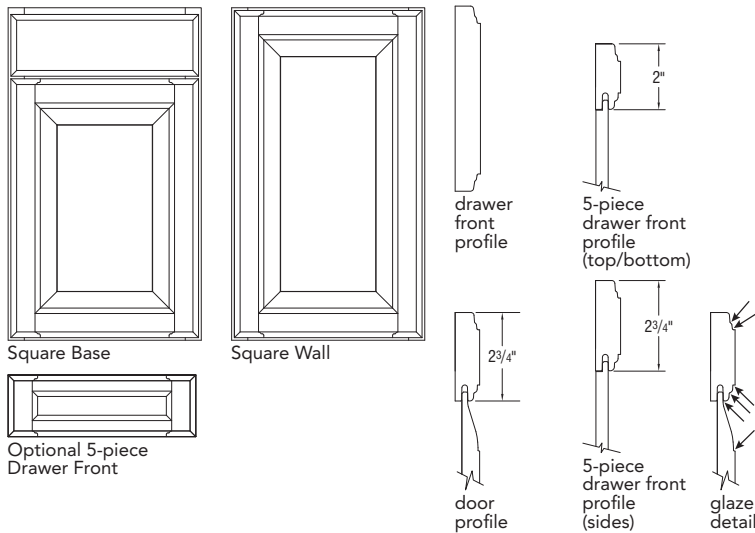

SPECIE & FINISH AVAILABILITY	
Maple	Standard Finish
	Glaze
Paint	

- ▶ Raised Solid Center Panel
- ▶ 3/4" Thick Solid Door Rail
- ▶ On 5-piece Drawer Front with Recessed Center Panel, Drawer Fronts 11 5/8" and Higher will have a Raised Veneer Center Panel with Vertical Grain.
- ▶ Square Doors on Base Cabinets
- ▶ Hardware Recommended

Ellis

Partial Overlay

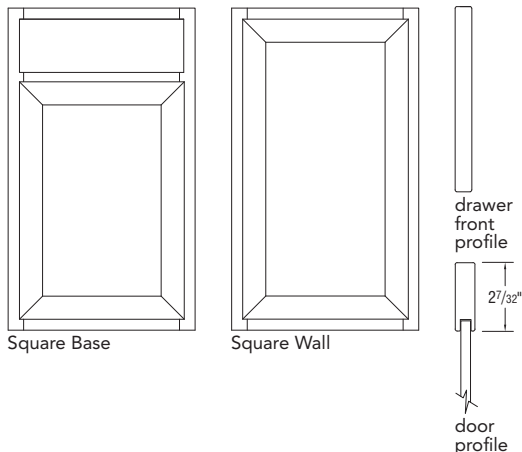

SPECIE & FINISH AVAILABILITY	
PureStyle™	Standard Finish

- ▶ 5/8" Thick Door
- ▶ Miter Construction
- ▶ Flat Laminate Center Panel
- ▶ 6-way Adjustable Hinges
- ▶ Hardware Recommended

Glazed edges indicated by arrows on side view drawings.

DOOR STYLES

Harrison

Full Overlay

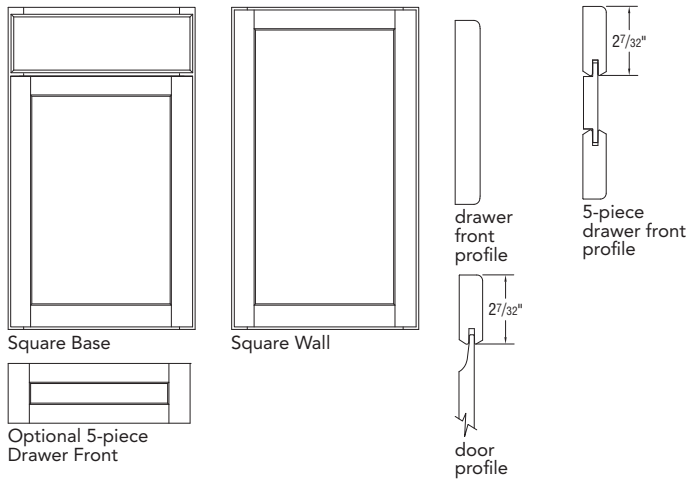

SPECIE & FINISH AVAILABILITY	
Rustic Birch	Standard Finish

- ▶ Reversed Raised Solid Center Panel
- ▶ 3/4" Thick Solid Door Rail
- ▶ Hardware Recommended
- ▶ Rustic Characteristics on Door and Drawer Fronts only
- ▶ Selected Rustic Trim Items Available. Use Common Styles for Maple Finishes When Not Available. See page 180.

Korbett

Full Overlay

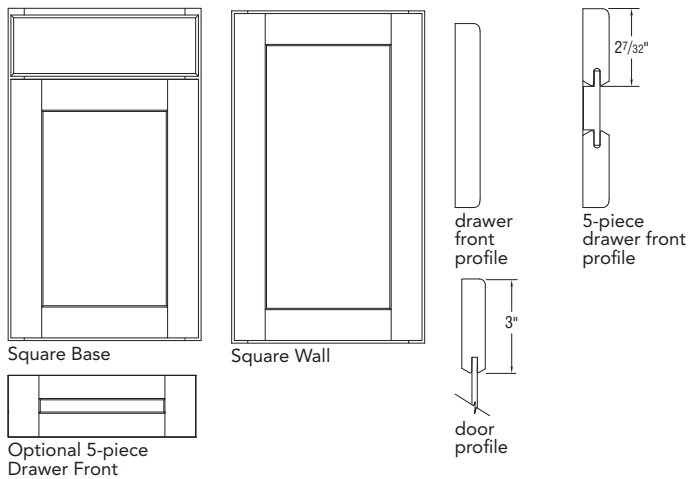

SPECIE & FINISH AVAILABILITY	
Cherry	Standard Finish
Maple	Standard Finish
Paint	

- ▶ Flat Veneer Center Panel
- ▶ 3" Wide Stile and Rail Shaker

Landen

Partial Overlay

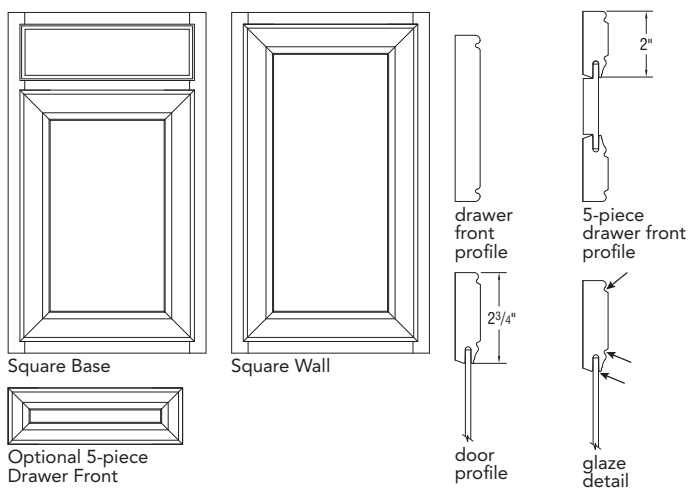

SPECIE & FINISH AVAILABILITY	
Maple	Standard Finish
	Glaze
Paint	

- ▶ Flat Veneer Center Panel
- ▶ 3/4" Thick Solid Door Rail
- ▶ Miter Construction
- ▶ Hardware Recommended

Glazed edges indicated by arrows on side view drawings.

DOOR STYLES

Lillian

Partial Overlay

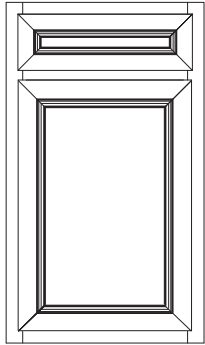

Square Base

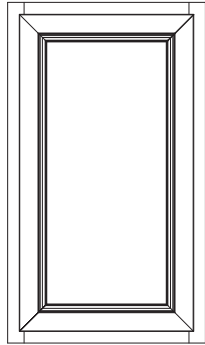

Square Wall

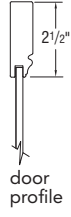

door profile

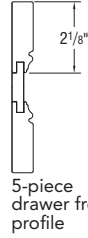

5-piece drawer front profile

SPECIE & FINISH AVAILABILITY

PureStyle™	Standard Finish
------------	-----------------

- ▶ 3/4" Thick Door Rail
- ▶ Flat Laminate Center Panel
- ▶ Miter Construction
- ▶ 5-piece Miter Drawer Front
- ▶ Hardware Recommended

Oakland

Partial Overlay

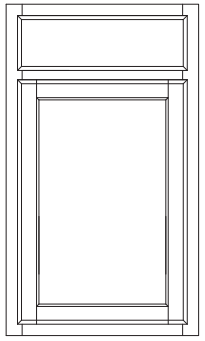

Square Base

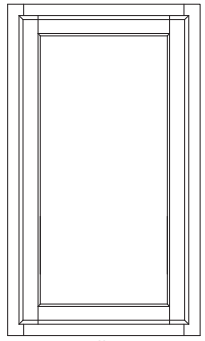

Square Wall

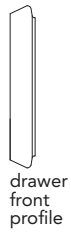

drawer front profile

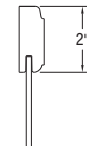

door profile (sides)

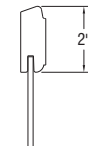

door profile (top/bottom)

SPECIE & FINISH AVAILABILITY

Oak	Standard Finish
-----	-----------------

- ▶ Flat Veneer Center Panel
- ▶ 3/4" Thick Solid Door Rail
- ▶ Reverse Bevel Profile, No Hardware Required

Overton

Full Overlay

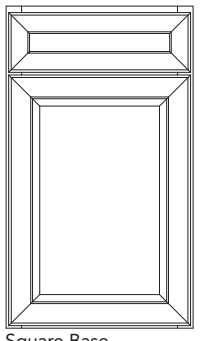

Square Base

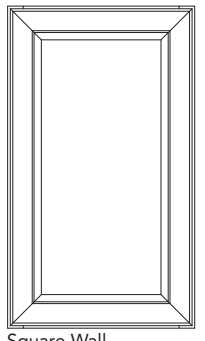

Square Wall

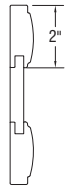

drawer front profile

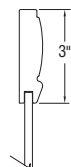

door profile

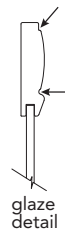

glaze detail

SPECIE & FINISH AVAILABILITY

PureStyle™	Standard Finish
------------	-----------------

- ▶ 3/4" Thick Door Rail
- ▶ Miter Construction
- ▶ Flat Laminate Center Panel
- ▶ 5-piece Miter Drawer Front
- ▶ Toasted Antique Glaze Only Available on Selected Trim Items. See page 180.
- ▶ Hardware Recommended

Glazed edges indicated by arrows on side view drawings.

DOOR STYLES

Radford

Partial Overlay

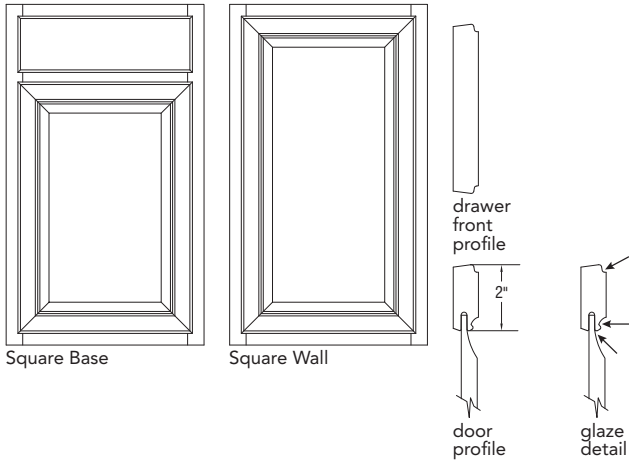

SPECIE & FINISH AVAILABILITY	
Maple	Standard Finish
	Glaze

- ▶ Raised Veneer Center Panel
- ▶ 3/4" Thick Solid Door Rail
- ▶ Miter Construction
- ▶ Reverse Bevel Profile, No Hardware Required

Saybrooke

Partial Overlay

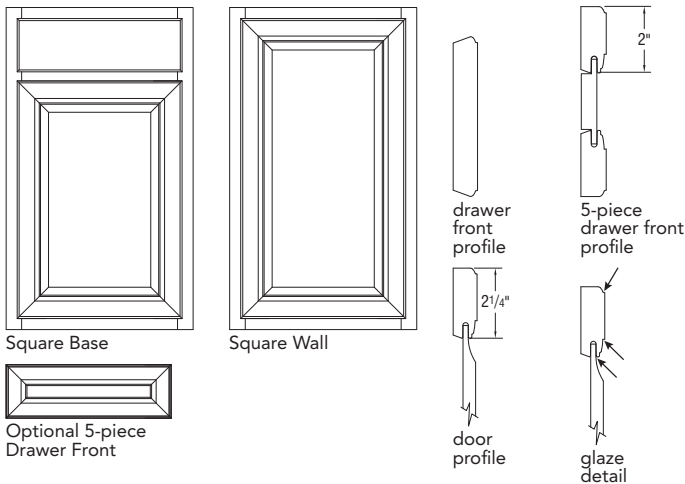

SPECIE & FINISH AVAILABILITY	
Birch	Standard Finish
	Glaze
Paint	

- ▶ Raised Veneer Center Panel
- ▶ 3/4" Thick Solid Door Rail
- ▶ On 5-piece Drawer Front with Recessed Center Panel, Drawer Fronts 11 5/8" and Higher will have a Raised Veneer Center Panel with Vertical Grain.
- ▶ Miter Construction
- ▶ Birch Styles Use Maple Accessories
- ▶ Hardware Recommended

Sinclair

Partial Overlay

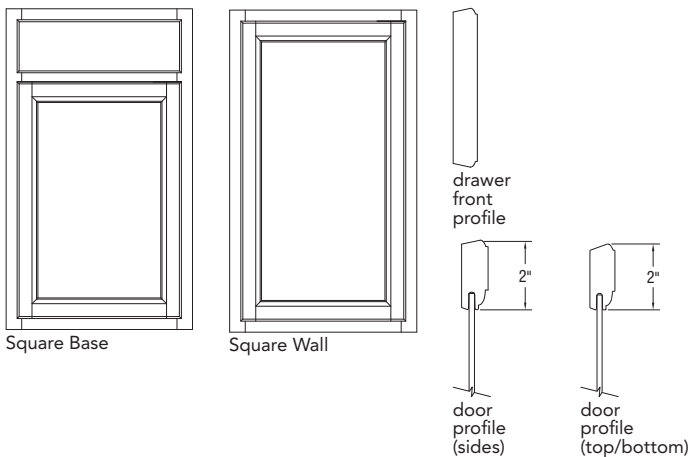

SPECIE & FINISH AVAILABILITY	
Birch	Standard Finish
	Paint

- ▶ Flat Veneer Center Panel
- ▶ 3/4" Thick Solid Door Rail
- ▶ Birch Styles Use Maple Accessories
- ▶ Reverse Bevel Profile, No Hardware Required

Glazed edges indicated by arrows on side view drawings.

DOOR STYLES

Teagan

Full Overlay

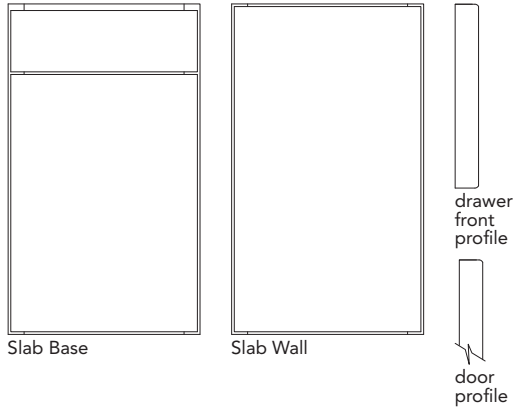

SPECIE & FINISH AVAILABILITY	
Maple	Standard Finish
Paint	

- ▶ Veneer Slab Door
- ▶ Veneer Face and Back with Furniture Board Core
- ▶ 3mm Wood Edging on all Edges
- ▶ Hardware Recommended

Wentworth

Full Overlay

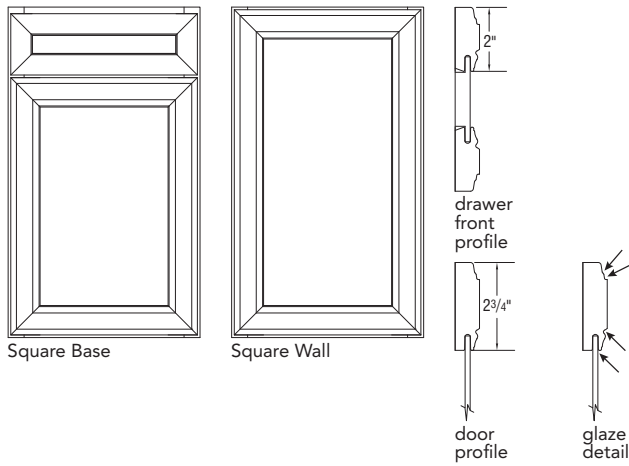

SPECIE & FINISH AVAILABILITY	
Maple	Standard Finish
	Glaze
Paint	

- ▶ Flat Veneer Center Panel
- ▶ 3/4" Thick Solid Door Rail
- ▶ Miter Construction
- ▶ 5-piece Miter Drawer Front
- ▶ Hardware Recommended

Glazed edges indicated by arrows on side view drawings.

DOOR STYLES

Westbury

Partial Overlay

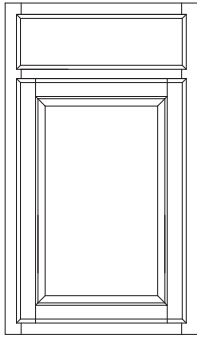

Square Base

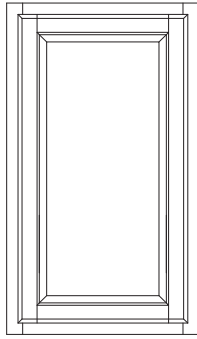

Square Wall



drawer front profile



door profile (sides)



door profile (top/bottom)

SPECIE & FINISH AVAILABILITY

Oak	Standard Finish
-----	-----------------

- ▶ Raised Veneer Center Panel
- ▶ 3/4" Thick Solid Door Rail
- ▶ Reverse Bevel Profile, No Hardware Required

Winstead

Full Overlay

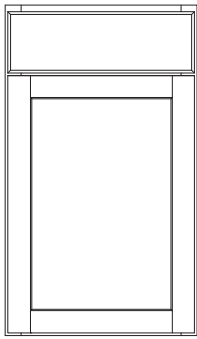

Square Base

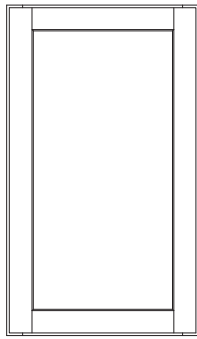

Square Wall



drawer front profile



door profile



5-piece drawer front profile

SPECIE & FINISH AVAILABILITY

Birch <i>New</i>	Standard Finish
Maple	Standard Finish
Paint	

- ▶ Flat Veneer Center Panel
- ▶ 3/4" Thick Solid Door Rail
- ▶ Hardware Recommended
- ▶ Optional 5-piece Drawer Front not available on Birch Stain.

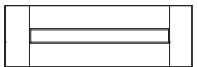

Optional 5-piece Drawer Front

Finish Descriptions

	FINISH NAME	DESCRIPTION
Stain/Glaze*	Autumn	Mid-tone stain with warm, copper tones
	Burlap <i>New</i>	Medium brown stain with a touch of gray
	Café	Dark brown stain with red undertones
	Flagstone	Dark, gray stain with brown undertones
	Java Glaze	Red toned base stain, highlighted by a dark brown glaze
	Natural	Natural finish is achieved with a clear coat which allows the pure beauty of natural wood grain to show.
	Pumpnickel Glaze	Warm medium brown stain highlighted by a dark brown glaze
	Rouge	Traditional, cinnamon red tones
	Saddle	Medium, warm brown stain
	Sarsaparilla	Rich, deep brown stain
	Umber	Medium to dark brown stain
Wheat	Light stain with golden undertones	
Paint**/PureStyle™	Antique Paint	Warm, off-white color
	Glacier Gray	Cool, light gray color
	Stone Gray	Cool, medium gray color
	Toasted Antique	Warm, off-white finish enhanced by the appearance of a medium brown glaze
	White	A pure white color

*Aristokraft's Hand-Contoured Glazing is an additional step in the finishing process that highlights door detail and enhances the richness of wood color and tone. Because glazing is achieved by hand, variations will occur throughout any door, and from one door to the next. The outcome will range from a consistent, even appearance to more varied coverage. The variation is a desirable feature and brings out the uniqueness of glazing.

**On wood products, normal movement is typical due to change in climatic conditions. This will cause hairline cracks at stile, rail and panel joints. This hairline cracking is a normal characteristic of painted finishes and will not be considered a reason for product replacement.

Finishing Process

Aristokraft offers a variety of cabinet construction and finish options in order to allow for maximum design flexibility. Below are details about wood characteristics to assist you in deciding on a wood type and finish.

The Aristokraft finishing process starts with top quality lumber that is sanded down to reach difficult areas before the doors are assembled. After assembly, each door is inspected before a toner is applied with a spray. After applying toner to each door, drawer front, and face frame, a layer of stain is added using a spray finish which is then hand-rubbed into the wood for maximum penetration and long-lasting beauty. A catalyzed varnish is then applied during the finishing process to fill the grain. Finally, a UV topcoat is applied onto the door, providing a protective layer and beautiful, lasting finish. A final inspection is given at the end of the process to ensure each door is ready for cabinet assembly.

The finish you select for your door style is just as important as the wood type. Each piece of wood will react differently to the finish material used, resulting in a slight variation in shade within and between cabinets. When natural, light, or tinted finishes are applied, the natural grain characteristics are apparent. For easy care and lasting beauty, Aristokraft covers interior surfaces of cabinet walls, backs, and shelves with Aristex™ surface, a urethane-coated laminate.

How to Use Door Style Numbers

Each door style described in this catalog is available in three construction methods - Standard, Select, and APC. Depending on what finish color is being specified, each one will have its own unique style number.

- Examples:**
- ▶ Benton Sarsaparilla Standard = 244
 - ▶ Benton Sarsaparilla Select = 844
 - ▶ Benton Sarsaparilla APC = 644
 - ▶ Benton Sarsaparilla Standard 5-piece = 5CH
 - ▶ Benton Sarsaparilla Select 5-piece = 9CH
 - ▶ Benton Sarsaparilla APC 5-piece = 7CH

STYLE/COLOR	STD	SEL	APC	STD/5PC	SEL/5PC	APC/5PC	COMMON STYLE
Augusta Thermofoil White	5JV	9JV	7JV	-	-	-	184
Avalon Cherry Café	59T	99T	79T	-	-	-	159
Avalon Cherry Flagstone <i>New</i>	59H	99H	79H	-	-	-	150
Avalon Cherry Java Glaze	59N	99N	79N	-	-	-	169
Avalon Cherry Pumpnickel Glaze	59U	99U	79U	-	-	-	192
Avalon Cherry Rouge	59E	99E	79E	-	-	-	174
Avalon Cherry Saddle	59M	99M	79M	-	-	-	173
Avalon Cherry Umber	59D	99D	79D	-	-	-	156
Avalon Maple Autumn	55F	95F	75F	-	-	-	183
Avalon Maple Burlap <i>New</i>	55V	95V	75V	-	-	-	165
Avalon Maple Café	55T	95T	75T	-	-	-	167
Avalon Maple Flagstone <i>New</i>	55H	95H	75H	-	-	-	151
Avalon Maple Java Glaze	55N	95N	75N	-	-	-	168
Avalon Maple Natural	55C	95C	75C	-	-	-	182
Avalon Maple Pumpnickel Glaze	55U	95U	75U	-	-	-	191
Avalon Maple Rouge	55E	95E	75E	-	-	-	180
Avalon Maple Saddle	55M	95M	75M	-	-	-	170
Avalon Maple Sarsaparilla	55W	95W	75W	-	-	-	193
Avalon Maple Umber	55D	95D	75D	-	-	-	157
Ayden Rustic Birch Autumn	41F	81F	61F	-	-	-	161
Ayden Rustic Birch Burlap <i>New</i>	41V	81V	61V	-	-	-	189
Ayden Rustic Birch Café	41T	81T	61T	-	-	-	154
Ayden Rustic Birch Flagstone	41H	81H	61H	-	-	-	153
Ayden Rustic Birch Java Glaze	41N	81N	61N	-	-	-	178
Ayden Rustic Birch Pumpnickel Glaze	41U	81U	61U	-	-	-	196
Ayden Rustic Birch Rouge	41E	81E	61E	-	-	-	163
Ayden Rustic Birch Saddle	41M	81M	61M	-	-	-	164
Ayden Rustic Birch Umber	41D	81D	61D	-	-	-	155
Benton Paint Antique	246	846	646	5CB	9CB	7CB	198
Benton Birch Autumn	240	840	640	5CC	9CC	7CC	183
Benton Birch Burlap <i>New</i>	5LU	9LU	7LU	5LV	9LV	7LV	165
Benton Birch Café	541	941	741	5CD	9CD	7CD	167
Benton Birch Flagstone	248	848	648	5JD	9JD	7JD	151
Benton Birch Rouge	242	842	642	5CF	9CF	7CF	180
Benton Birch Saddle	243	843	643	5CG	9CG	7CG	170
Benton Birch Sarsaparilla	244	844	644	5CH	9CH	7CH	193
Benton Paint Stone Gray	5LT	9LT	7LT	5MP	9MP	7MP	181
Benton Birch Umber	247	847	647	5CJ	9CJ	7CJ	157
Benton Paint White	5KA	9KA	7KA	5KB	9KB	7KB	184
Brellin PureStyle™ Glacier Gray	252	852	652	5NN	9NN	7NN	194
Brellin PureStyle™ Stone Gray	283	883	683	5NP	9NP	7NP	181
Brellin PureStyle™ White	5JW	9JW	7JW	5NR	9NR	7NR	184
Briarcliff II Cherry Café	-	-	-	5BH	9BH	7BH	159
Briarcliff II Cherry Flagstone	-	-	-	5JB	9JB	7JB	150
Briarcliff II Cherry Java Glaze	-	-	-	5BG	9BG	7BG	169
Briarcliff II Cherry Pumpnickel Glaze	-	-	-	5BS	9BS	7BS	192
Briarcliff II Cherry Rouge	-	-	-	5BD	9BD	7BD	174
Briarcliff II Cherry Saddle	-	-	-	5BF	9BF	7BF	173
Briarcliff II Cherry Umber	-	-	-	5BC	9BC	7BC	156

STYLE/COLOR	STD	SEL	APC	STD/5PC	SEL/5PC	APC/5PC	COMMON STYLE
Briarcliff II Paint Antique	-	-	-	5AM	9AM	7AM	198
Briarcliff II Maple Autumn	-	-	-	5AD	9AD	7AD	183
Briarcliff II Maple Burlap <i>New</i>	-	-	-	5LX	9LX	7LX	165
Briarcliff II Maple Café	-	-	-	5AJ	9AJ	7AJ	167
Briarcliff II Maple Flagstone	-	-	-	5HZ	9HZ	7HZ	151
Briarcliff II Maple Java Glaze	-	-	-	5AH	9AH	7AH	168
Briarcliff II Maple Natural	-	-	-	5AA	9AA	7AA	182
Briarcliff II Maple Pumpernickel Glaze	-	-	-	5BT	9BT	7BT	191
Briarcliff II Maple Rouge	-	-	-	5AC	9AC	7AC	180
Briarcliff II Maple Saddle	-	-	-	5AG	9AG	7AG	170
Briarcliff II Maple Sarsaparilla	-	-	-	5AK	9AK	7AK	193
Briarcliff II Paint Stone Gray	-	-	-	5MU	9MU	7MU	181
Briarcliff II Maple Umber	-	-	-	5AB	9AB	7AB	157
Briarcliff II Paint White	-	-	-	5KC	9KC	7KC	184
Briarcliff II Paint Arch Antique	-	-	-	5BA	9BA	7BA	198
Briarcliff II Maple Arch Autumn	-	-	-	5AS	9AS	7AS	183
Briarcliff II Maple Arch Burlap <i>New</i>	-	-	-	5LW	9LW	7LW	165
Briarcliff II Maple Arch Café	-	-	-	5AX	9AX	7AX	167
Briarcliff II Arch Maple Flagstone	-	-	-	5JA	9JA	7JA	151
Briarcliff II Maple Arch Java Glaze	-	-	-	5AW	9AW	7AW	168
Briarcliff II Maple Arch Natural	-	-	-	5AN	9AN	7AN	182
Briarcliff II Maple Arch Pumpernickel Glaze	-	-	-	5BU	9BU	7BU	191
Briarcliff II Maple Arch Rouge	-	-	-	5AR	9AR	7AR	180
Briarcliff II Maple Arch Saddle	-	-	-	5AV	9AV	7AV	170
Briarcliff II Maple Arch Sarsaparilla	-	-	-	5AY	9AY	7AY	193
Briarcliff II Paint Arch Stone Gray	-	-	-	5MT	9MT	7MT	181
Briarcliff II Maple Arch Umber	-	-	-	5AP	9AP	7AP	157
Briarcliff II Paint Arch White	-	-	-	5KD	9KD	7KD	184
Durham PureStyle™ Glacier Gray	-	-	-	258	858	658	194
Durham PureStyle™ Stone Gray	-	-	-	284	884	684	181
Durham PureStyle™ Toasted Antique	-	-	-	211	811	611	199
Durham PureStyle™ White	-	-	-	5JX	9JX	7JX	184
Ellis PureStyle™ Stone Gray	285	885	685	-	-	-	181
Ellis PureStyle™ White	286	886	686	-	-	-	184
Eastland Paint Antique	527	927	727	5CT	9CT	7CT	198
Eastland Maple Autumn	552	952	752	5CU	9CU	7CU	183
Eastland Maple Burlap <i>New</i>	5LY	9LY	7LY	5LZ	9LZ	7LZ	165
Eastland Maple Café	521	921	721	5CV	9CV	7CV	167
Eastland Maple Flagstone	262	862	662	5JF	9JF	7JF	151
Eastland Maple Java Glaze	557	957	757	5CX	9CX	7CX	168
Eastland Maple Natural	551	951	751	5CY	9CY	7CY	182
Eastland Maple Pumpernickel Glaze	554	954	754	5DA	9DA	7DA	191
Eastland Maple Rouge	550	950	750	5CZ	9CZ	7CZ	180
Eastland Maple Saddle	556	956	756	5DB	9DB	7DB	170
Eastland Maple Sarsaparilla	559	959	759	5DC	9DC	7DC	193
Eastland Paint Stone Gray	5MV	9MV	7MV	5MW	9MW	7MW	181
Eastland Maple Umber	503	903	703	5DD	9DD	7DD	157
Eastland Paint White	5KE	9KE	7KE	5KF	9KF	7KF	184
Harrison Rustic Birch Autumn	46F	86F	66F	5EF	9EF	7EF	161
Harrison Rustic Birch Burlap <i>New</i>	46V	86V	66V	5MA	9MA	7MA	189
Harrison Rustic Birch Café	46T	86T	66T	5EG	9EG	7EG	154
Harrison Rustic Birch Flagstone	46H	86H	66H	5JJ	9JJ	7JJ	153
Harrison Rustic Birch Rouge	46E	86E	66E	5EJ	9EJ	7EJ	163
Harrison Rustic Birch Saddle	46M	86M	66M	5EK	9EK	7EK	164
Harrison Rustic Birch Umber	46D	86D	66D	5EL	9EL	7EL	155
Korbett Cherry Café	5HL	9HL	7HL	5HT	9HT	7HT	159
Korbett Cherry Flagstone	5HM	9HM	7HM	5HU	9HU	7HU	150
Korbett Cherry Rouge	5HN	9HN	7HN	5HV	9HV	7HV	174
Korbett Cherry Saddle	5HP	9HP	7HP	5HW	9HW	7HW	173
Korbett Cherry Umber	5HR	9HR	7HR	5HX	9HX	7HX	156

STYLE/COLOR	STD	SEL	APC	STD/5PC	SEL/5PC	APC/5PC	COMMON STYLE
Korbett Paint Antique	5GM	9GM	7GM	5GZ	9GZ	7GZ	198
Korbett Maple Autumn	5GN	9GN	7GN	5HA	9HA	7HA	183
Korbett Maple Burlap <i>New</i>	5MB	9MB	7MB	5MC	9MC	7MC	165
Korbett Maple Café	5GP	9GP	7GP	5HB	9HB	7HB	167
Korbett Maple Flagstone	5GS	9GS	7GS	5HD	9HD	7HD	151
Korbett Maple Natural	5GT	9GT	7GT	5HE	9HE	7HE	182
Korbett Maple Rouge	5GU	9GU	7GU	5HF	9HF	7HF	180
Korbett Maple Saddle	5GV	9GV	7GV	5HG	9HG	7HG	170
Korbett Maple Sarsaparilla	5GW	9GW	7GW	5HH	9HH	7HH	193
Korbett Paint Stone Gray	5MX	9MX	7MX	5MY	9MY	7MY	181
Korbett Maple Umber	5GX	9GX	7GX	5HJ	9HJ	7HJ	157
Korbett Paint White	5KG	9KG	7KG	5KH	9KH	7KH	184
Landen Paint Antique	588	988	788	5EM	9EM	7EM	198
Landen Maple Autumn	572	972	772	5EN	9EN	7EN	183
Landen Maple Burlap <i>New</i>	5MD	9MD	7MD	5ME	9ME	7ME	165
Landen Maple Café	525	925	725	5EP	9EP	7EP	167
Landen Maple Flagstone	264	864	664	5JK	9JK	7JK	151
Landen Maple Java Glaze	577	977	777	5ES	9ES	7ES	168
Landen Maple Natural	571	971	771	5ET	9ET	7ET	182
Landen Maple Pumpnickel Glaze	574	974	774	5EU	9EU	7EU	191
Landen Maple Rouge	570	970	770	5EV	9EV	7EV	180
Landen Maple Saddle	576	976	776	5EW	9EW	7EW	170
Landen Maple Sarsaparilla	579	979	779	5EX	9EX	7EX	193
Landen Paint Stone Gray	5MZ	9MZ	7MZ	5NA	9NA	7NA	181
Landen Maple Umber	505	905	705	5EY	9EY	7EY	157
Landen Paint White	5KJ	9KJ	7KJ	5KK	9KK	7KK	184
Lillian PureStyle™ Glacier Gray	-	-	-	281	881	681	194
Lillian PureStyle™ Stone Gray	-	-	-	282	882	682	181
Lillian PureStyle™ White	-	-	-	5JY	9JY	7JY	184
Oakland Oak Natural	275	875	675	-	-	-	188
Oakland Oak Saddle	253	853	653	-	-	-	171
Oakland Oak Sarsaparilla	251	851	651	-	-	-	187
Oakland Oak Umber	508	908	708	-	-	-	158
Oakland Oak Wheat	255	855	655	-	-	-	186
Overton PureStyle™ Toasted Antique	-	-	-	250	850	650	199
Radford Maple Autumn	56F	96F	76F	-	-	-	183
Radford Maple Burlap <i>New</i>	56V	96V	76V	-	-	-	165
Radford Maple Café	56T	96T	76T	-	-	-	167
Radford Maple Flagstone	56H	96H	76H	-	-	-	151
Radford Maple Java Glaze	56N	96N	76N	-	-	-	168
Radford Maple Natural	56C	96C	76C	-	-	-	182
Radford Maple Pumpnickel Glaze	56U	96U	76U	-	-	-	191
Radford Maple Rouge	56E	96E	76E	-	-	-	180
Radford Maple Saddle	56M	96M	76M	-	-	-	170
Radford Maple Sarsaparilla	56W	96W	76W	-	-	-	193
Radford Maple Umber	56D	96D	76D	-	-	-	157
Saybrooke Paint Antique <i>New</i>	5NG	9NG	7NG	5NH	9NH	7NH	198
Saybrooke Birch Autumn	225	825	625	5FS	9FS	7FS	183
Saybrooke Birch Burlap <i>New</i>	5MF	9MF	7MF	5MG	9MG	7MG	165
Saybrooke Birch Café	581	981	781	5FT	9FT	7FT	167
Saybrooke Birch Flagstone	259	859	659	5JN	9JN	7JN	151
Saybrooke Birch Java Glaze	277	877	677	5JT	9JT	7JT	168
Saybrooke Birch Pumpnickel Glaze	278	878	678	5JU	9JU	7JU	191
Saybrooke Birch Rouge	228	828	628	5FV	9FV	7FV	180
Saybrooke Birch Saddle	227	827	627	5FW	9FW	7FW	170
Saybrooke Birch Sarsaparilla	229	829	629	5FX	9FX	7FX	193
Saybrooke Paint Stone Gray <i>New</i>	5NJ	9NJ	7NJ	5NK	9NK	7NK	181
Saybrooke Birch Umber	501	901	701	5FY	9FY	7FY	157
Saybrooke Paint White <i>New</i>	5NL	9NL	7NL	5NM	9NM	7NM	184

STYLE/COLOR	STD	SEL	APC	STD/5PC	SEL/5PC	APC/5PC	COMMON STYLE
Sinclair Birch Autumn	220	820	620	-	-	-	183
Sinclair Birch Café	564	964	764	-	-	-	167
Sinclair Birch Flagstone <i>New</i>	5LS	9LS	7LS	-	-	-	151
Sinclair Birch Rouge	223	823	623	-	-	-	180
Sinclair Birch Saddle	222	822	622	-	-	-	170
Sinclair Birch Sarsaparilla	239	839	639	-	-	-	193
Sinclair Paint Stone Gray <i>New</i>	5ND	9ND	7ND	-	-	-	181
Sinclair Birch Umber	500	900	700	-	-	-	157
Sinclair Paint White <i>New</i>	5NE	9NE	7NE	-	-	-	184
Teagan Paint Antique	58Y	98Y	78Y	-	-	-	198
Teagan Maple Autumn	58F	98F	78F	-	-	-	183
Teagan Maple Burlap <i>New</i>	58V	98V	78V	-	-	-	165
Teagan Maple Café	58T	98T	78T	-	-	-	167
Teagan Maple Flagstone	58H	98H	78H	-	-	-	151
Teagan Maple Natural	58C	98C	78C	-	-	-	182
Teagan Maple Rouge	58E	98E	78E	-	-	-	180
Teagan Maple Saddle	58M	98M	78M	-	-	-	170
Teagan Maple Sarsaparilla	58W	98W	78W	-	-	-	193
Teagan Paint Stone Gray	58S	98S	78S	-	-	-	181
Teagan Maple Umber	58D	98D	78D	-	-	-	157
Teagan Paint White	58Z	98Z	78Z	-	-	-	184
Wentworth Paint Antique	-	-	-	51Y	91Y	71Y	198
Wentworth Maple Autumn	-	-	-	51F	91F	71F	183
Wentworth Maple Burlap <i>New</i>	-	-	-	51V	91V	71V	165
Wentworth Maple Café	-	-	-	51T	91T	71T	167
Wentworth Maple Flagstone	-	-	-	51H	91H	71H	151
Wentworth Maple Java Glaze	-	-	-	51N	91N	71N	168
Wentworth Maple Natural	-	-	-	51C	91C	71C	182
Wentworth Maple Pumpernickel Glaze	-	-	-	51U	91U	71U	191
Wentworth Maple Rouge	-	-	-	51E	91E	71E	180
Wentworth Maple Saddle	-	-	-	51M	91M	71M	170
Wentworth Maple Sarsaparilla	-	-	-	51W	91W	71W	193
Wentworth Paint Stone Gray	-	-	-	51S	91S	71S	181
Wentworth Maple Umber	-	-	-	51D	91D	71D	157
Wentworth Paint White	-	-	-	51Z	91Z	71Z	184
Westbury Oak Natural	231	831	631	-	-	-	188
Westbury Oak Saddle	230	830	630	-	-	-	171
Westbury Oak Sarsaparilla	234	834	634	-	-	-	187
Westbury Oak Umber	506	906	706	-	-	-	158
Westbury Oak Wheat	236	836	636	-	-	-	186
Winstead Birch Autumn <i>New</i>	5NT	9NT	7NT	-	-	-	183
Winstead Birch Burlap <i>New</i>	5NU	9NU	7NU	-	-	-	165
Winstead Birch Café <i>New</i>	5NV	9NV	7NV	-	-	-	167
Winstead Birch Flagstone <i>New</i>	5NW	9NW	7NW	-	-	-	151
Winstead Birch Rouge <i>New</i>	5NX	9NX	7NX	-	-	-	180
Winstead Birch Saddle <i>New</i>	5NY	9NY	7NY	-	-	-	170
Winstead Birch Sarsaparilla <i>New</i>	5NZ	9NZ	7NZ	-	-	-	193
Winstead Birch Umber	5PB	9PB	7PB	-	-	-	157
Winstead Maple Autumn	543	943	743	5GA	9GA	7GA	183
Winstead Maple Burlap <i>New</i>	5MH	9MH	7MH	5MJ	9MJ	7MJ	165
Winstead Maple Café	594	994	794	5GB	9GB	7GB	167
Winstead Maple Flagstone	261	861	661	5JP	9JP	7JP	151
Winstead Maple Natural	542	942	742	5GD	9GD	7GD	182
Winstead Maple Rouge	540	940	740	5GE	9GE	7GE	180
Winstead Maple Saddle	545	945	745	5GF	9GF	7GF	170
Winstead Maple Sarsaparilla	547	947	747	5GG	9GG	7GG	193
Winstead Maple Umber	502	902	702	5GH	9GH	7GH	157
Winstead Paint Antique	549	949	749	5FZ	9FZ	7FZ	198
Winstead Paint Stone Gray	5NB	9NB	7NB	5NC	9NC	7NC	181
Winstead Paint White	5KL	9KL	7KL	5KM	9KM	7KM	184

Common Style Numbers for Finishes



In addition to the style numbers for door styles, there are several common items such as mouldings, panels, valances, fillers, organizers, wood hood units, open shelf units, and other parts that have been changed to a common style number based on finish. Look for the symbol (shown left) used throughout this book indicating Common Items. Please reference these common style numbers in the chart below.

Birch Antique	198
Birch Autumn*	183
Birch Burlap <i>New</i>	165
Birch Café*	167
Birch Flagstone*	151
Birch Java Glaze*	168
Birch Pumpnickel Glaze*	191
Birch Rouge*	180
Birch Saddle*	170
Birch Sarsaparilla*	193
Birch Umber*	157
Birch White	184
Cherry Café	159
Cherry Flagstone	150
Cherry Java Glaze	169
Cherry Pumpnickel Glaze	192
Cherry Rouge	174
Cherry Saddle	173
Cherry Umber	156
Cherry Wheat	176
Maple Autumn	183
Maple Burlap <i>New</i>	165
Maple Café	167
Maple Flagstone	151
Maple Java Glaze	168
Maple Natural	182
Maple Pumpnickel Glaze	191
Maple Rouge	180
Maple Saddle	170
Maple Sarsaparilla	193
Maple Umber	157
Oak Natural	188
Oak Saddle	171
Oak Sarsaparilla	187
Oak Umber	158
Oak Wheat	186
Rustic Birch Autumn	161
Rustic Birch Burlap <i>New</i>	189
Rustic Birch Café	154
Rustic Birch Flagstone	153
Rustic Birch Java Glaze	178
Rustic Birch Pumpnickel Glaze	196
Rustic Birch Saddle	164
Rustic Birch Rouge	163
Rustic Birch Umber	155
Antique	198
Glacier Gray	194
Stone Gray	181
Toasted Antique Glaze**	199
White	184

* Use Maple for Birch common items.

** Toasted Antique Glaze common style items will feature a glaze appearance and are only available on selected trim items. All other trim items should be ordered as Antique (#198).

Note:

–Antique, Glacier Gray, Stone Gray, and White common style items will be painted hardwood.

–Use common styles for Maple finishes when Rustic Birch is not available.

 Miscellaneous Style	010	Miscellaneous items such as Sink Tilt-out Trays, and Cutlery Trays should use Common Style #010.
---	-----	--

		CABINET CONSTRUCTION OPTIONS		
		STANDARD	SELECT	APC*
CABINET CONSTRUCTION OPTIONS	SIDES	3/8" Thick Furniture Board with Matching Laminate Exterior		3/8" Thick Plywood with Matching Laminate Exterior
	BACK	3/8" Thick Furniture Board		3/8" Thick Plywood
	TOP (Wall)	1/2" Thick Furniture Board		1/2" Thick Plywood
	BOTTOM (Wall)	1/2" Thick Furniture Board		1/2" Thick Plywood
	BOTTOM (Base)	3/8" Thick Furniture Board		3/8" Thick Plywood
	CORNERS (Base)	Four Furniture Board Braces		Two Plywood Stretcher Rails
	SHELVES (Wall and Tall)	Adjustable 3/4" Thick Full Depth Furniture Board (15 lbs. Maximum weight per square foot)		Adjustable 3/4" Thick Full Depth Plywood (15 lbs. maximum weight per sq. foot)
	SHELVES (Base)	Adjustable 3/4" Thick Half Depth Furniture Board Adjustable 3/4" Thick Full Depth Furniture Board on Open & Full Height Base Cabinets (Exclusions apply as noted throughout the book)		Adjustable 3/4" Thick Half Depth Plywood Adjustable 3/4" Thick Full Depth Plywood on Open & Full Height Base Cabinets (Exclusions apply as noted throughout the book)
	TOEKICK	3/8" Thick x 4" High Furniture Board, Recessed 3 3/8", Unfinished (Requires cover: TOEKICK/TOEKICK8)		3/8" Thick x 4" High Plywood, Recessed 3 3/8", Unfinished (Requires cover: TOEKICK/TOEKICK8/TOEKICKPLY8)
	FACE FRAME	3/4" x 1 1/2" Solid Wood		
	HINGES	6-way Adjustable, Fully Concealed, Steel Hinges	6-way Adjustable, Fully Concealed, Steel Hinges with Smart Stop™	
INTERIOR COMPONENTS	Aristex™ Maple Laminate			
		DRAWER CONSTRUCTION OPTIONS		
		STANDARD	SELECT	APC*
DRAWER CONSTRUCTION OPTIONS	BOX	1/2" Thick Furniture Board	3/4"*** Thick All Wood with Clear Topcoat	
	BOTTOM	3/8" Thick Furniture Board, Stapled into Sides, Front, & Back	1/4" Thick Plywood, Fully Captured	
	GUIDES	Side-mount, Epoxy-Coated, Double Rails, Captured on Two Sides	Concealed Full Extension Drawer Guides with Smart Stop™	
	JOINERY	Stapled Butt Joint	Dovetail Joint	
	DEPTH	Base Cabinets and 21" Deep Vanities – 20" 18" Deep Vanities – 15 1/2"	Base Cabinets – 21" 21" Deep Vanities – 18"	
	CAPACITY	Rated at 75 lbs. Capacity per drawer for all guides		

*Depending upon application, plywood components may contain MDF or particleboard in accordance with ANSI/HPVA HP-1 standards.

**Dovetail drawer with 3/4" nominal thick all-wood sides and full extension guides.

How to Order Upgrade Features

Each door style described in this catalog is available in three construction methods - Standard, Select, and APC. Depending on what finish color is being specified, each one will have its own unique style number.

- Examples:**
- ▶ Westbury Square Wheat is #236
 - ▶ Westbury Square Wheat Select is #836
 - ▶ Westbury Square Wheat APC is #636

Select and APC Upgrades for Cabinets with Drawers

- ▶ Most cabinets **with drawers** can be upgraded to Select and All-plywood Construction.
- ▶ Cabinets upgraded to Select feature a standard Dovetail Drawer Box with Concealed Full Extension Smart Stop™ Drawer Guides.
- ▶ Cabinets upgraded to All-plywood Construction (APC) feature the Select Dovetail Drawer Box and Concealed Full Extension Smart Stop™ Drawer Guides along with APC Box Construction.

5-piece Drawer Front Upgrades for Cabinets with Drawers

- ▶ Available on most cabinets with drawers on PLUS styles (except Teagan and Brellin).
- ▶ Can be applied to Standard, Select, and APC. (Select and APC will have additional upcharges)
- ▶ 5-Piece drawer front options are designated with a style name and a style number.
- ▶ 5-Piece drawer front pricing is an additional price added per drawer to the standard cabinet list price.

All-plywood Construction Upgrades (APC)

- ▶ Most walls, bases, tall, vanities, and universal cabinets can be upgraded to APC (All-plywood Construction).
- ▶ Add the following upcharge per cabinet to upgrade to APC.

Cabinet Front-Only (FO) Information and How to Order

- ▶ Cabinet front-onlys include the following parts (where applicable): frame, hinged door(s), drawer front(s), and non-matching toeboard.
- ▶ Parts not included: cabinets floor and cabinet accessories (door racks, wastebaskets, pull-outs, etc).
- ▶ Front-onlys are available in Standard door style numbers and are not trimmable.
- ▶ Front-only list price is 70% of the cabinet list price. Not available to order through 20/20, contact customer service to order.

Cabinet Frame Only (FM) Information

- ▶ Not trimmable.
- ▶ Not available to ship FedEx.
- ▶ Contact Customer Service to set up SKU frame only.
- ▶ Orderable via EDI after set up.

FO and FM are not available on the following cabinet types (contact customer service for additional questions):

- ▶ Sink Base Cabinets or Sink Fronts
- ▶ Base-height Vanities that share a frame configuration with a standard Base Cabinet
- ▶ Base Roll Tray Cabinets 15"-24" wide or 39"-48" wide
- ▶ 12" deep Base Cabinets (Use SKU for 24" deep)
- ▶ 15" or 24" deep Wall Cabinets (Use SKU for 12" deep)
- ▶ 18" deep Vanity Cabinets (Use SKU for 21" deep)
- ▶ 12" deep Utility Cabinets (Use SKU for 24" deep)
- ▶ Corner Cabinets with angled frames (SCER, SCR, BRER, BLS, BECF)
- ▶ Only available in standard construction, and will not be available with Soft Close Hinges.

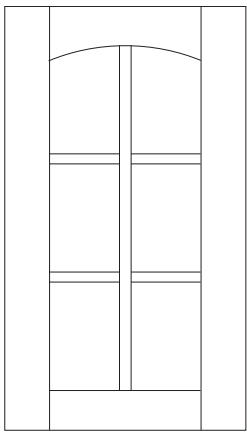

Standard Mullion Arch

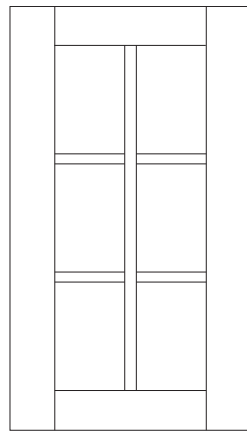

Standard Mullion Square

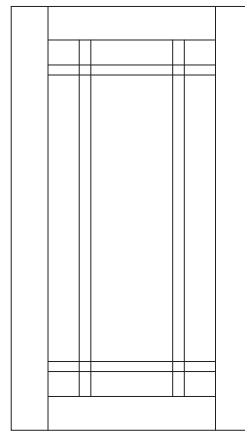

Shaker Mullion
Benton, Brellin, Ellis
Harrison, & Winstead Only

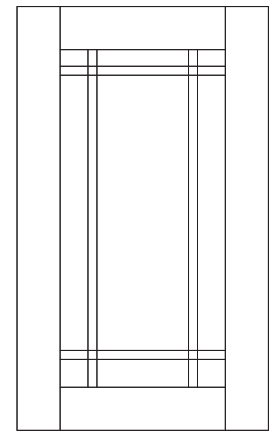

Shaker Mullion
Korbett

- ▶ Custom door sizes not available.
- ▶ Mullion Door cabinets are not available in Teagan and VanWyke.
- ▶ Cabinets with Mullion Doors include installed, clear tempered glass, and matching Aristex™ interior.
- ▶ Specify L or R on all single door Arch styles.
- ▶ For complementary Wall Mullion Door cabinet in Teagan order as Winstead Maple, as Teagan features a slab door design.

Mullion Door Grid Configurations

Refer to drawings below to see the Standard & Shaker configurations for cabinet width & height.

STANDARD MULLION DOOR GRID CONFIGURATIONS						
Cabinet Width	Cabinet Height					
	18"	21"	24"	30"	36"	42"
15"	B			A	A	A
18"	B			A	A	A
21"	B			A	A	A
24"	B		B	A	A	A
27"	B		B	A	A	A
30"	B	B	B	A	A	A
33"	B		B	A	A	A
36"	B	B	B	A	A	A
39"	B			A		
42"	B			A		
45"				A		
48"				A		
24" Diagonal	B		B	A	A	A
27" Diagonal	B		B	A	A	A

SHAKER MULLION DOOR GRID CONFIGURATIONS						
Cabinet Width	Cabinet Height					
	18"	21"	24"	30"	36"	42"
15"	C			C	C	C
18"	C			C	C	C
21"	C			C	C	C
24"	C		C	C	C	C
27"	C		C	C	C	C
30"	C	C	C	C	C	C
33"	C		C	C	C	C
36"	C	C	C	C	C	C
39"	C			C		
42"	C			C		
45"				C		
48"				C		
24" Diagonal	C		C	C	C	C
27" Diagonal	C		C	C	C	C

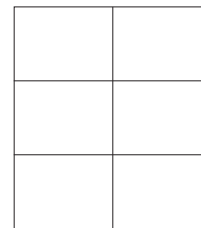

A

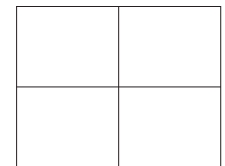

B

Available Door Styles:
Augusta, Avalon, Ayden, Briarcliff II, Durham, Eastland, Landen, Lillian, Oakland, Overton, Radford, Saybrooke, Sinclair, Wentworth, Westbury

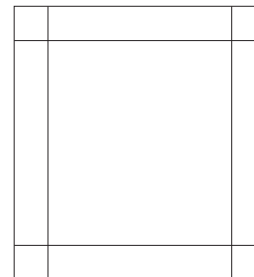

C

Available Door Styles:
Benton, Brellin, Ellis, Korbett, Harrison, Winstead

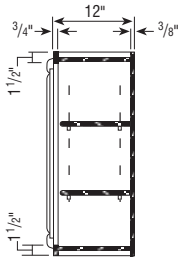

Wall Cabinet

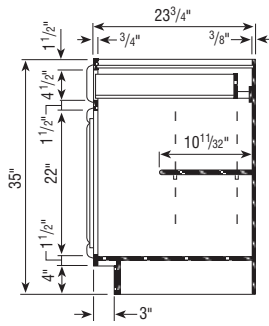

Base Cabinet

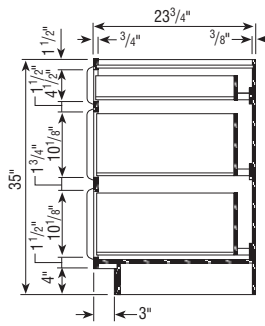

3-Drawer
Base Cabinet

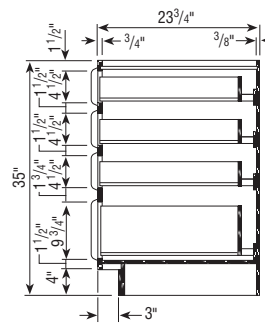

4-Drawer
Base Cabinet

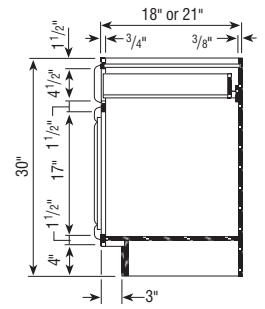

30" High
Vanity Cabinet

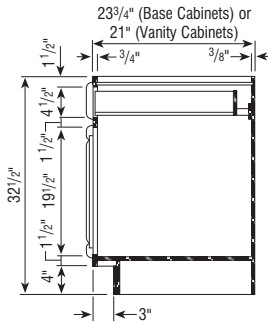

32 1/2" High
Base/Vanity

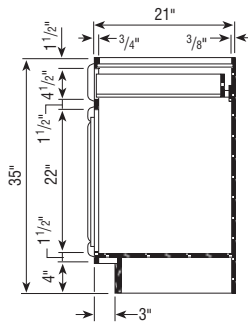

35" High
Vanity Cabinet

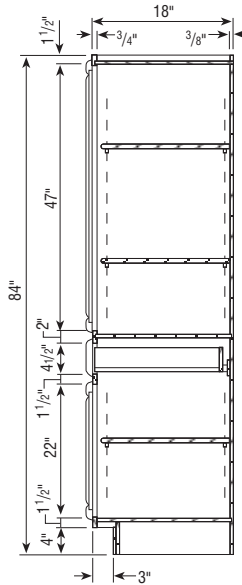

Linen Closet w/Drawer

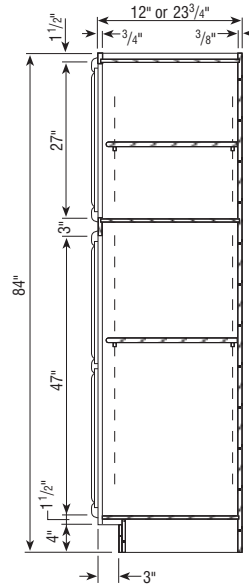

Utility Cabinet
Shelves not included

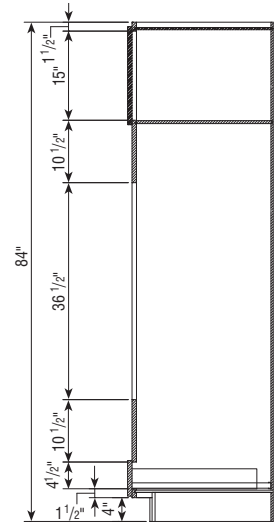

Double Oven Cabinet

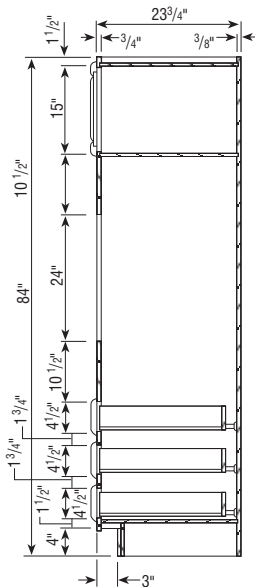

Single Oven Cabinet

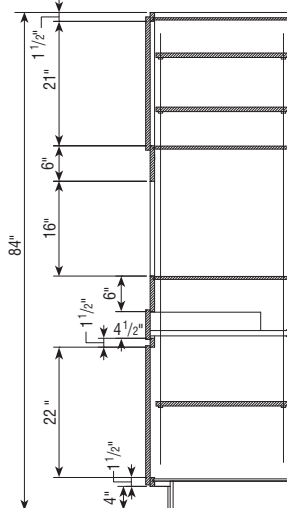

Tall Microwave Cabinet

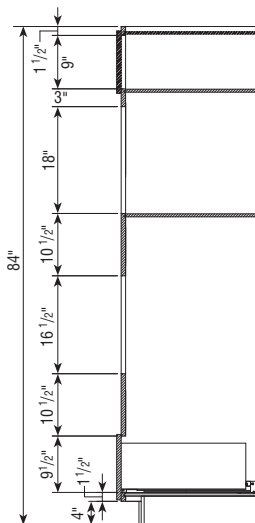

Oven Microwave Cabinet

Cabinet Specification Reference

- ▶ Number above wall cabinet represents height of cabinet.
- ▶ 1/2" Top and Bottom Rails on most cabinets.
- ▶ 1/2" Vertical Stiles on most cabinets, except OCS/OD/TMW Cabinets.
- ▶ Drawer box opening heights are 4 1/2" for small and 9 1/2", 9 3/4", or 10 1/8" for large (deep) drawers.

7/16" Overlay Door Styles:

- ▶ 1 1/16" Reveal around doors (1 1/16" of Face Frame shows).
- ▶ Door size for Single Door Cabinets: Frame opening + 7/8"
- ▶ Door size for Butt Door Cabinets: (Frame opening + 3/4")/2
- ▶ 4 1/2" High Drawer opening = 5 1/8" Drawer Front.

Full Overlay Door Styles:

- ▶ 1/4" Reveal around doors (1/4" of Face Frame shows).
- ▶ Door size for Single Door Cabinets: Frame opening + 2 1/2"
- ▶ Door size for Butt Door Cabinets: (Frame opening + 2 3/8")/2
- ▶ 4 1/2" High Drawer opening = 5 3/4" Drawer Front.

84" High Application

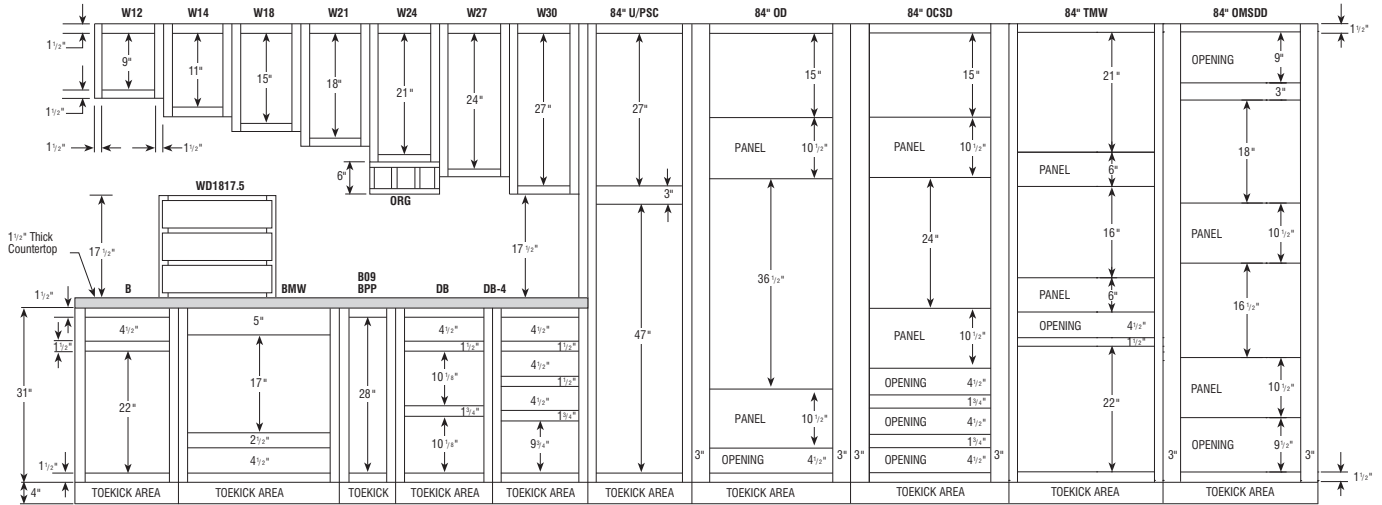

90" High Application

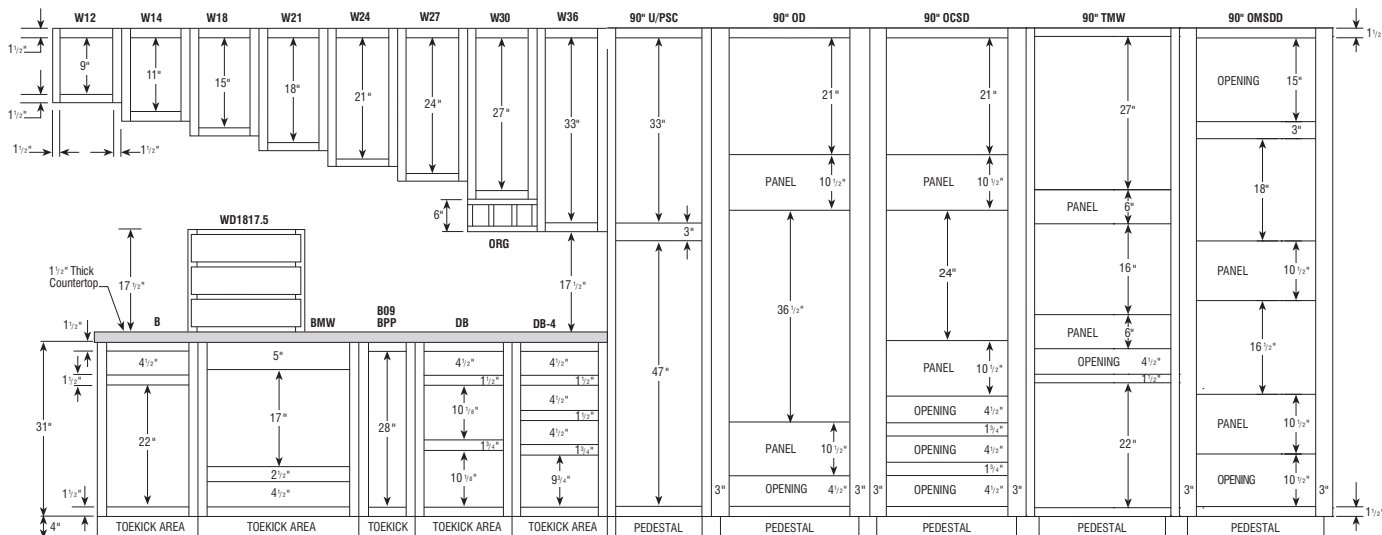

96" High Application

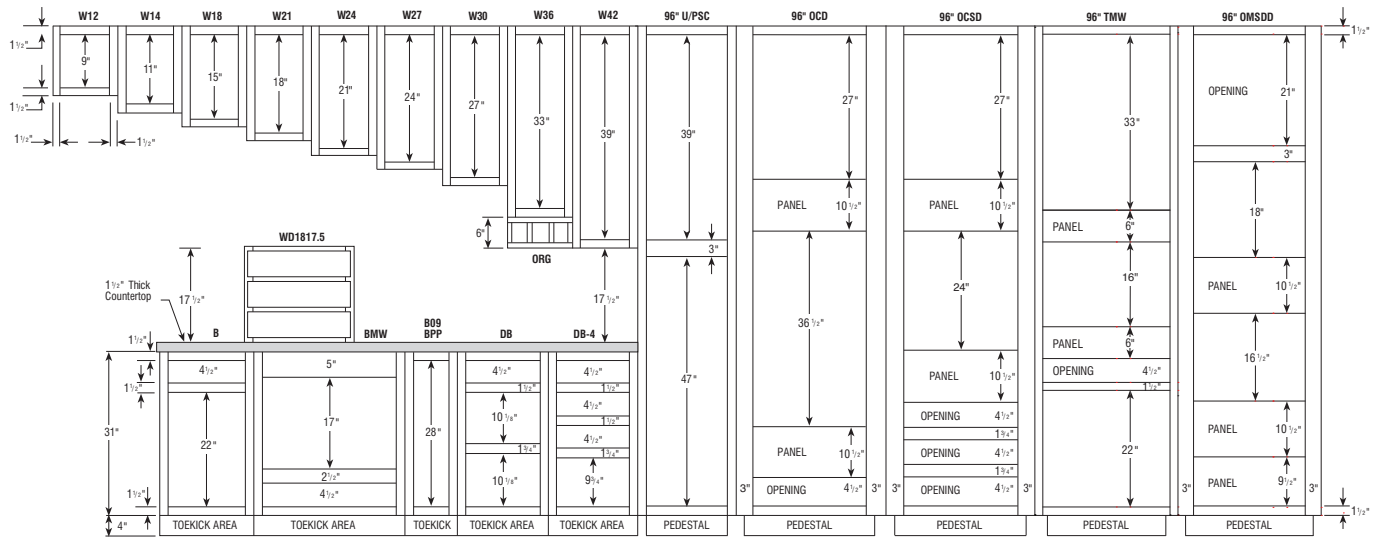

30" High Desk Cabinets

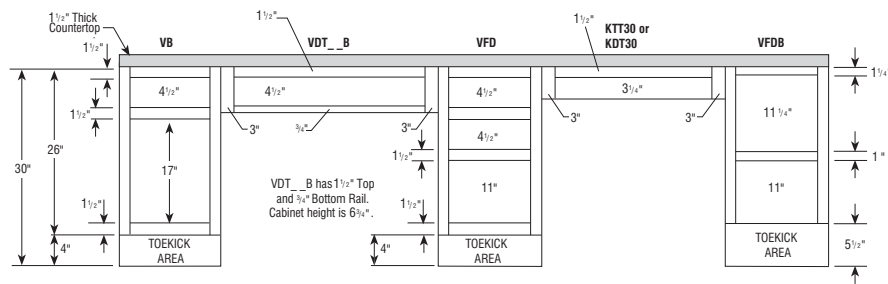

30" High Vanity Cabinets

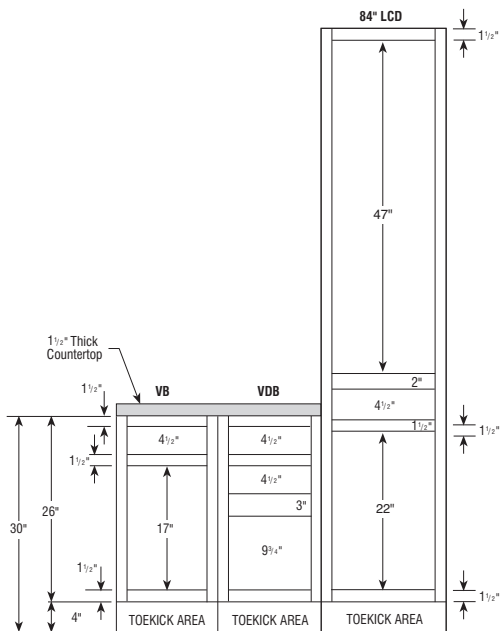

32 1/2" High Vanity Cabinets

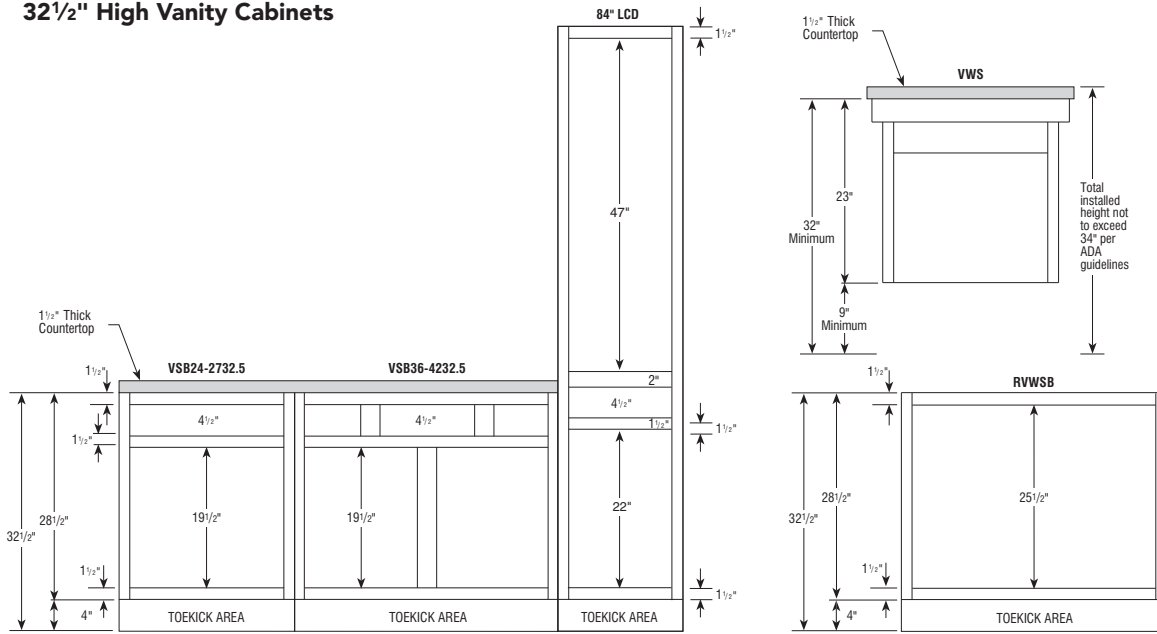

35" High Vanity Cabinets

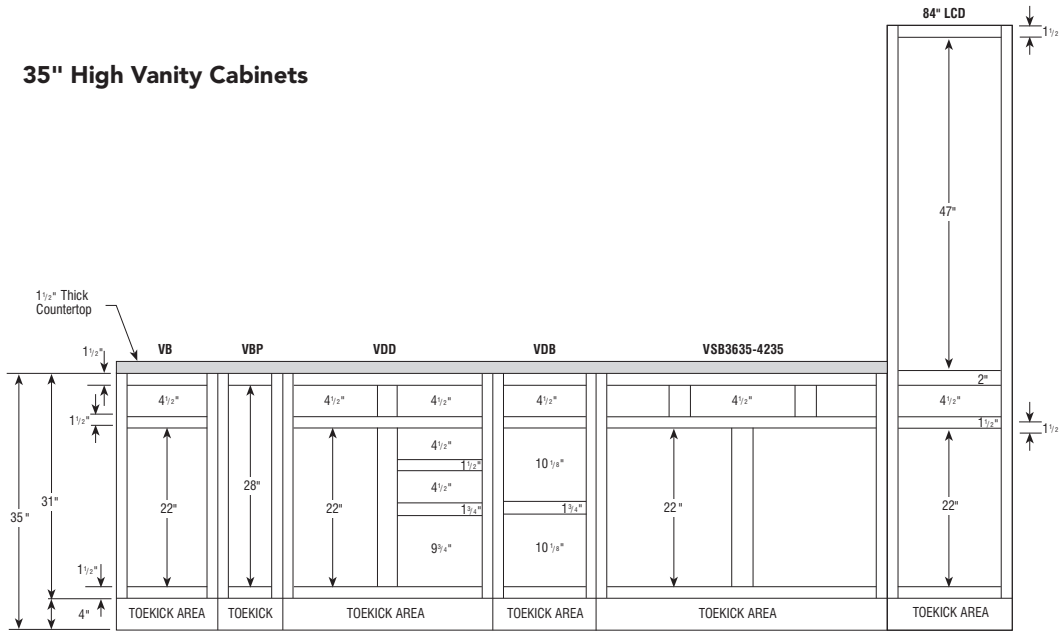

32 1/2" High Base Cabinets (Universal Design Application)

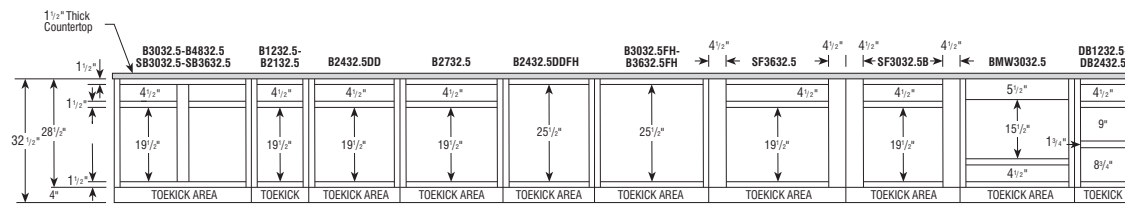

- ▶ 32 1/2" High Cabinets are designed to comply with ADA (Americans with Disabilities Act) requirements of a 34" high overall counter height, including a 1 1/2" counter top.
- ▶ Refer to ADA guidelines for more details on designing in small spaces where extra width for turning radius may be required.
- ▶ Available in the following styles:
 - ▶ Avalon Maple
 - ▶ Benton Birch
 - ▶ Brellin PureStyle™
 - ▶ Landen Maple
 - ▶ Oakland Oak
 - ▶ Radford Maple
 - ▶ Saybrooke Birch
 - ▶ Sinclair Birch
 - ▶ Westbury Oak
 - ▶ Winstead Maple
- ▶ For Vanity Sink Base Cabinets, see page 129. For a Vanity Wall Sink Cabinet, see page 142.

Did you remember...

Styles and Pricing

- ▶ Select Door Style and Pricing Level from your 20/20 design program. (If copying and pasting from one order to another, remember to reset styles and pricing.)

End Finishing Options

Consider exposed end options:

- ▶ Use APC for exposed cabinets. The laminate end will age uniformly with the rest of the kitchen.
- ▶ Apply $\frac{3}{16}$ " veneer skin to hide $\frac{3}{16}$ " reveal. This will allow the ends to age uniformly with the rest of the kitchen and will make it flush.
- ▶ Apply decorative door kit (DBEP, DWEP, DVEP). This kit includes $\frac{3}{16}$ " veneer skin, decorative doors, and screws for field installation.
- ▶ Underside of Wall Cabinets are natural maple laminate, with a few exceptions such as WMD, WOL and WPG (exclusions to apply and noted throughout the book). Use light rail and skin to hide, especially when designing with Peninsula Wall Cabinets.

Wood and Finish Characteristics

Review specific details with the customer:

- ▶ Mineral Streaks, Birdseye Dots, Grain Variations (especially Rustic Birch).
- ▶ Color Variations/Darkening (especially Cherry).
- ▶ Finish Variations (Glazes are "consistently inconsistent"), hairline cracks may develop at frame joints on painted frames.

Clearances

- ▶ Add fillers between end cabinets and walls on full overlay door styles.
- ▶ Allow space between door/window trim and end cabinets for countertop and top moulding overhang.
- ▶ Include refrigerator door hinges in overall refrigerator height when placing cabinets above it.
- ▶ For minimum pull requirements on blind corner cabinets, see charts on pages 80, 103, and 140.
- ▶ Allow sufficient clearance (3") on each side of accessory cabinets (such as roll-out trays, swing-out units, etc).
- ▶ Doors on these cabinets must open fully for accessories to be functional.
- ▶ Ensure the height between the cooktop and range hood is 24" to meet NKBA guidelines.

Advise customer carefully on upper cabinet/microwave advantages/disadvantages as follows:

- ▶ Minimum of 18" from cooktop to upper cabinet/above the range microwave which allows for easy access to either, but less room over back burner.
- ▶ Minimum of 21" from cooktop to upper cabinet/microwave which allows for access to large pots on back burner of cooktop, but longer reach to microwave.

Fillers

- ▶ Place fillers toward end of run where least conspicuous if needed.
- ▶ Attach overlay fillers on top of base, wall, or tall fillers when using full overlay door styles to maintain a consistent reveal. Don't forget to include blind corner fillers.

Matching Interior Cabinets/Glass Options

- ▶ Use light rail and skin to hide color variation between bottom of WOL Cabinets next to any other cabinets.
- ▶ Verify mullion door grid matches customer expectations. (Advise customer of shaker grid pattern.)

Mouldings

- ▶ All toekicks must be skinned with TOEKICK, TOEKICK8, or TOEKICKPLY8.
- ▶ Verify the correct amount of moulding has been ordered.
- ▶ Order toekick caps.
- ▶ Order extra scribe.

Islands and Peninsulas

- ▶ Consider standard height bars are 35" tall and require 19" knee space. Raised bars are 42" tall.
- ▶ Consider Base Peninsula Cabinets (PB) are 23 $\frac{3}{4}$ " deep and require 12" of knee space.
- ▶ Use outside corner moulding if a skin is exposed on the back of the island.

Appliances

- ▶ Do not place dishwashers next to diagonal front cabinet (interference) or next to a range (no countertop support).
- ▶ Verify refrigerator door has enough clearance to open beyond 90 degrees so refrigerator drawers can be utilized. Refer to appliance manufacturer's specifications.
- ▶ Thermofoil will not withstand sustained temperatures in excess of 170°F. A 3" filler or heat shield is required between any thermofoil surface and any heat source to be in compliance with cabinet warranty.

Special Considerations

- ▶ Consider V-Groove skins and/or decorative doors on exposed cabinet sides in glazed kitchen.

Miscellaneous

- ▶ Order touch-up kit for future repairs.

Tips to the Installer

#10 x 2 $\frac{1}{2}$ " installation screws are furnished and packaged inside all cabinets for attachment to wall. Proper wall stud or ceiling joist installation is essential for Wall and Peninsula Cabinets to support weight. Whenever possible, cabinets should be attached to each other for additional strength. Excessive weight should not be put on cabinets hung by themselves. Shimming may be required to ensure proper alignment. Wallboard alone is not strong enough to support the cabinets.

Aristokraft's Warranty does not cover damage caused by improper installation. Please be sure to install cabinets properly and review all installation instructions. If you have questions, please contact your representative or customer service.

Wood Dust Warning

When cutting, sanding, sawing, or shaping cabinets or wood products, you are likely to generate wood dust. For your own safety, Aristokraft recommends that you wear a protective mask to prevent breathing wood dust. We also recommend eye protection to avoid injury by flying wood chips or sawdust during cabinet installation.

Kitchen Planning Guidelines

Door/Entry

- ▶ Door opening should be at least 32" wide.

Door Interference

- ▶ Entry door should not interfere with safe appliance operation or appliance doors.

Distance Between Work Centers

- ▶ With three work centers, the total distance traveled should not be more than 26' with no single leg of the triangle less than 4' or more than 9'.
- ▶ With more than three work centers, each additional travel distance to another work center should be no less than 4' or more than 9'. Each leg is measured from the center-front of the appliance/sink. No work triangle leg should intersect an island/peninsula by more than 12".

Separating Work Centers

- ▶ A tall obstacle should not separate two primary work centers. A properly recessed tall corner unit is acceptable.

Work Triangle Traffic

- ▶ Major traffic patterns should not cross through the basic work triangle.

Work Aisle

- ▶ The work aisle should be at least 42" for one cook and at least 48" for multiple cooks.

Walkway

- ▶ The walkway width should be at least 36".

Traffic Clearance At Seating

- ▶ Allow 32" of clearance from the table to wall/obstacle if no traffic passes behind a seated diner. If traffic passes behind the diner, allow at least 36" to edge past or 44" to walk past.

Seating Clearance

- ▶ 30" high tables/counters should allow a 24" wide by 18" deep space for each seated diner.
- ▶ 36" high counters should allow a 24" wide by 15" deep space for each seated diner and at least 15" kneespace.
- ▶ 42" high counters should allow a 24" wide by 12" deep space for each seated diner and at least 12" kneespace.

Clean-Up/Prep Sink Placement

- ▶ With only one sink, locate it adjacent to or across from the cooking surface and refrigerator.

Clean-Up/Prep Sink Landing Area

- ▶ Include at least a 24" landing space on one side of the sink and 18" on the other.
- ▶ If all the countertop at the sink is not the same height, plan a 24" landing space on one side of the sink and 3" of countertop frontage on the other, both at the same height of the sink.

Preparation/Work Area

- ▶ Include a section of countertop at least 36" wide x 24" deep next to the sink for a work area.

Dishwasher Placement

- ▶ Nearest edge of dishwasher should be within 36" of nearest edge of sink. Provide at least 21" of standing space between the edge of the dishwasher and countertop frontage/appliances/cabinets which are placed at a right angle to the dishwasher.

Waste Receptacles

- ▶ Include at least 2 waste receptacles, one near the sink and the other nearby for recycling.

Auxiliary Sink

- ▶ Provide at least 3" of countertop frontage on one side of the auxiliary sink and 18" on the other side, both at the same height of the sink.

Refrigerator Landing Area

- ▶ Include at least 15" of landing area on the handle side of the refrigerator, 15" on either side of a side-by-side refrigerator, 15" of landing space which is no more than 48" across from the front of the refrigerator, and 15" above or adjacent to any under counter-style refrigerator.

Cooking Surface Landing Area

- ▶ Include a minimum of 12" of landing area on one side of the cooking surface and 15" on the other.
- ▶ If cooking surface is at a different countertop height than the rest of the kitchen, then the 12" and 15" landing areas must be the same height as the cooking surface.
- ▶ For safety reasons, in an island or peninsula situation, the countertop should extend a minimum of 9" behind the cooking surface if the counter height is the same height as the cooking surface.

Cooking Surface Clearance

- ▶ Allow 24" between the cooking surface and a protected noncombustible surface above it.
- ▶ At least 30" of clearance is required between the cooking surface and an unprotected/combustible surface above it.
- ▶ If a microwave hood is used, then the manufacturer's specifications should be followed.

Cooking Surface Ventilation

- ▶ A correctly sized, ducted ventilation system is recommended for all cooking surface appliances. The recommended minimum is 150 CFM.
- ▶ Code requires that the manufacturer's specifications be followed. Minimum exhaust rate for a ducted hood is 100 CFM and must be ducted to the outside.
- ▶ Make-up airway may need to be provided. Refer to local codes.

Cooking Surface Safety

- ▶ Do not locate cooking surface under an operable window.
- ▶ Window treatments above cooking surface should not use flammable materials.
- ▶ Place a fire extinguisher near the kitchen exit away from cooking equipment.

Microwave Oven Placement

- ▶ The ideal location for the bottom of the microwave is 3" below the principle user's shoulder, but no more than 54" above the floor.

Kitchen Planning Guidelines (continued)

Microwave Landing Area

- ▶ Provide at least 15" above, below, or adjacent to the handle side of a microwave oven.

Oven Landing Area

- ▶ Include at least 15" next to or above the oven.
- ▶ A 15" landing area that is not more than 48" away is also acceptable as long as the oven does not open into a walkway.

Combining Landing Areas

- ▶ If two landing areas are adjacent to one another, determine a new minimum for the two by taking the longer of the two and adding 12".

Countertop Space

- ▶ A total of 158" of countertop frontage, 24" deep, with at least 15" clearance above is needed to accommodate all landing, preparation, work, and storage areas.

Countertop Edges

- ▶ Clipped or round corners rather than sharp edges are recommended on all counters.

Storage

- ▶ The recommended total shelf/drawer frontage for a small kitchen (less than 150 square feet) is 1400", a medium kitchen (151 to 350 square feet) is 1700", and for a large kitchen (greater than 350 square feet) is 2000".

Sizes:	S	M	L
Wall	300"	360"	360"
Base	520"	615"	660"
Drawer	360"	400"	525"
Pantry	180"	230"	310"
Misc.	40"	95"	145"

- ▶ The totals for wall, base, drawer, and pantry shelf/drawer frontage can be adjusted upward or downward as long as the recommended total stays the same.

Storage At Clean-Up/Prep Sink

- ▶ The recommended total for a small kitchen is 400", a medium kitchen is 480", a large kitchen is 560", and should be located within 72" of the centerline of the main clean-up/prep sink.

Corner Cabinet Storage

- ▶ At least one corner cabinet should include a functional storage device.

Electrical Receptacles

- ▶ GFCI (Ground-Fault-Circuit-Interrupter) protection is required on all receptacles servicing countertop surfaces within the kitchen.

Lighting

- ▶ Every work surface should be well illuminated. At least one wall switch-controlled light must be placed at the entrance.
- ▶ Window/skylight area, equal to at least 8% of the total square footage of the kitchen, or a total living space which includes a kitchen, is required.

Bathroom Planning Guidelines

Door/Entry

- ▶ Doorway opening should be at least 32", requiring a minimum 2' 10" wide door.

Door Interference

- ▶ Entry or fixture doors should not interfere with each other and/or the safe use of fixtures/cabinets.

Ceiling Height

- ▶ Bathroom floor to ceiling minimum height is 80". A shower or tub with a shower head shall have a minimum floor to ceiling height of 80" above a minimum area 30" x 30" at the shower head.

Clear Space

- ▶ Plan a clear space of 30" from the front edge of all fixtures to any opposite bath fixture, wall, or obstacle.
- ▶ A minimum space of at least 21" is required in front of lavatory, toilet, bidet, and tub, with a 24" minimum space in front of a shower entry.

Single Lavatory Placement

- ▶ The distance from the centerline of the lavatory to the sidewall/tall obstacle should be at least 20".
- ▶ The minimum distance required is 15". The minimum distance required between a wall and the edge of a lavatory is 4".

Double Lavatory Placement

- ▶ The distance between the centerlines of two lavatories should be at least 36".
- ▶ The minimum distance required is 30".
- ▶ The minimum distance required between the edges of two lavatories is 4".

Lavatory/Vanity Height

- ▶ The height for a lavatory varies between 32"–43" to fit the user.

Countertop Edges

- ▶ Clipped or round corners rather than sharp edges are recommended on all counters.

Shower Size

- ▶ The interior shower size should be at least 36" x 36". The minimum interior shower size required is 30" x 30".

NOTES ✓

- ▶ To create the Americana design, start with F396 and add MICROWN8/PSMICROWN8 and MROPE8 insert.
- ▶ To create the Art Linea design, start with MCTB8, add MBAT8 and another MCTB8 and support with cleat.

Americana

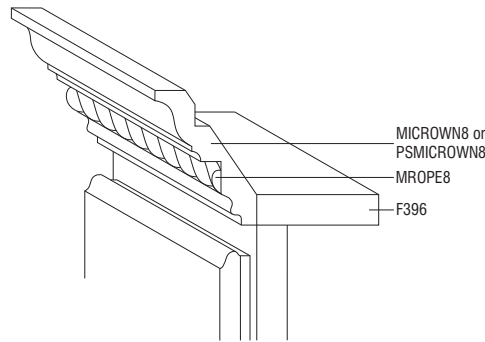

Art Linea

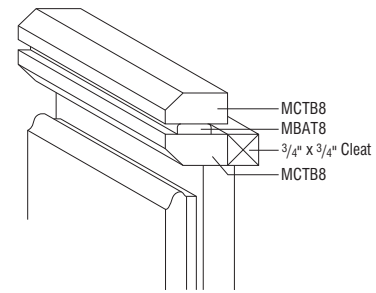

NOTES ✓

- ▶ To create the Aztec design, start with F396 and add MFOLCR8/PSMFOLCR8 and MDENTIL8 insert.
- ▶ To create the Baroque design, start with F396 and add MFOLCR8/PSMFOLCR8 and MROPE8 insert.

Aztec

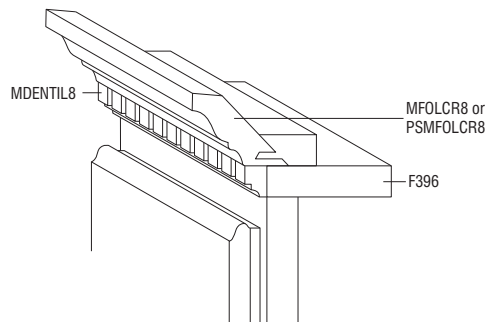

Baroque

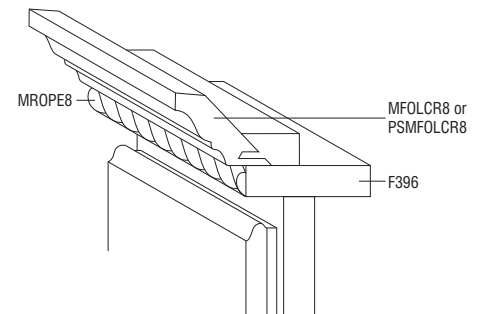

NOTES ✓

- ▶ To create the Georgian design, start with MBS8 and add MCROWN8/PSMCROWN8 and support with cleat.
- ▶ To create the Classical design, start with MTST8/PSMTST8 and add F396 cut to 1 1/2\"/>

Georgian

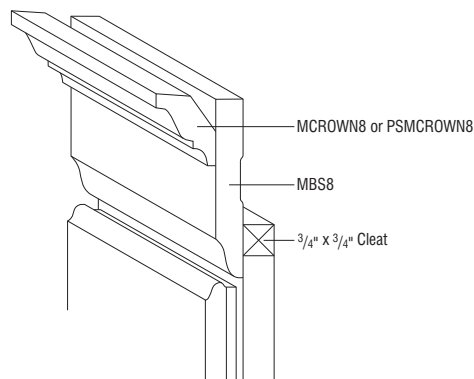

Classical

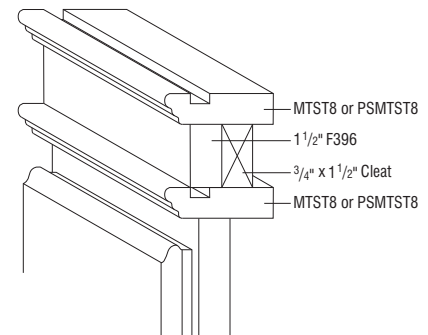

Mission

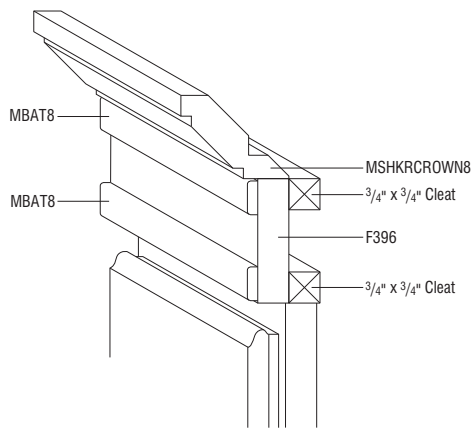

Monticello

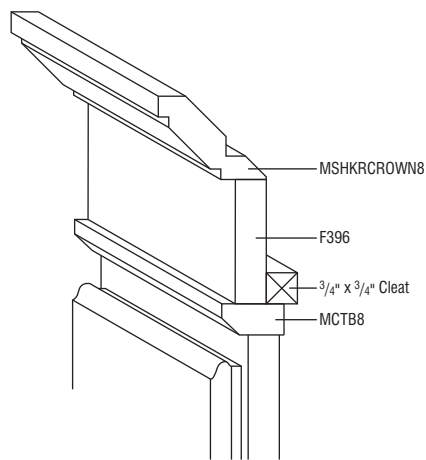

NOTES ✓

- ▶ To create the Mission design, start with F396 and add two MBAT8 and MSHKRCROWN8 and support with cleat.
- ▶ To create the Monticello design, start with MCTB8 and add F396 and MSHKRCROWN8 and support with cleat.
- ▶ Available in Maple finishes only.

Monarch

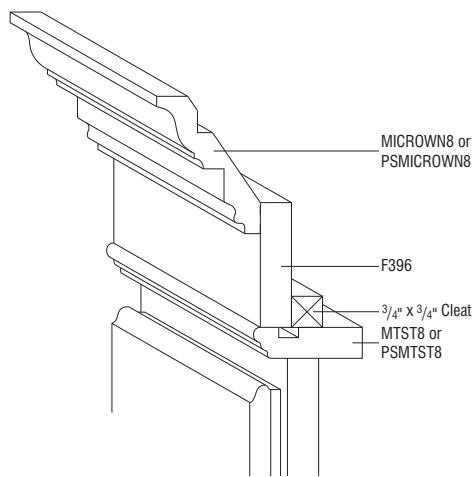

Regency

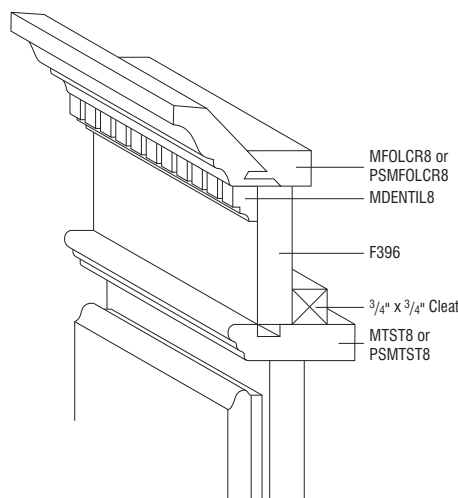

NOTES ✓

- ▶ To create the Monarch design, start with MTST8/PSMTST8 and add F396 and MICROWN8/PSMICROWN8 and support with cleat.
- ▶ To create the Regency design, start with MTST8/PSMTST8 and add F396 and MFOLCR8/PSMFOLCR8 and MDENTIL8 insert and support with cleat.

Renaissance

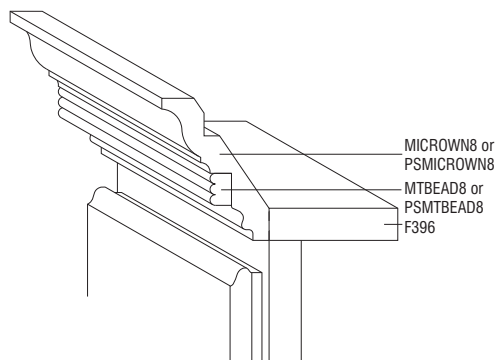

Romanesque

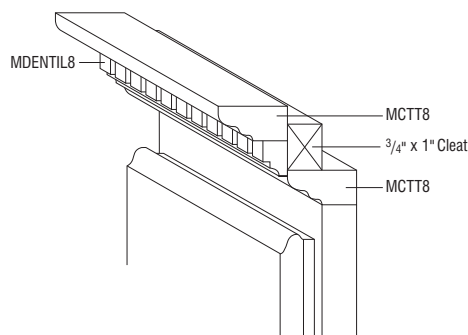

NOTES ✓

- ▶ To create the Renaissance design, start with F396 and add MICROWN8/PSMICROWN8 and MTBEAD8/PSMTBEAD8 insert.
- ▶ To create the Romanesque design, start with MCTT8 and add another MCTT8 and MDENTIL8 insert and support with cleat.

Organization Solutions



Look for the symbol (shown left) used throughout this book indicating organization solutions. Reference the chart below for organization applications.

		CABINET WIDTH														PAGE
		6"	9"	12"	15"	18"	21"	24"	27"	30"	33"	36"	39"	42"	45"	
WALL CABINETS																
DCR2430	Diagonal Corner Roto Wall Cabinet							✓ [†]								79
FS_ _	Floating Shelves							✓		✓		✓		✓		64
MWC_ _ _ _ B	Microwave Wall Cabinets (36" & 48" High)								✓	✓	✓					61
MWC_ _ _ _ _ B	Wall Built-in Microwave Cabinets (36" & 42" High)								✓	✓	✓					62
WD1817.5	Wall Drawer Unit					✓										60
WER24_ _	Wall Easy Reach Cabinets							✓ [†]								79
WMC12_ _	Wall Message Center Cabinets			✓												61
WR_ _ _ _	Wine Rack Cabinets (12" High)								✓		✓					60
WSC_ _ _ _ _	Wine Storage Cabinets			✓	✓	✓	✓	✓								63
BASE CABINETS																
B_ _ RT	Base Cabinets w/ Roll Trays				✓	✓	✓	✓	✓	✓	✓	✓	✓	✓	✓	88
B_ _ RT-2	Base Cabinets w/Double Roll Trays				✓	✓	✓	✓	✓	✓	✓	✓	✓	✓	✓	88
B_ _ TD	Base Cabinet with Tray Divider		✓	✓												87
BBCPO6	Base Box Column Pull-out Cabinet	✓														91
BEC12	Base End Cabinet (One Door)			✓												105
BECF24	Base End Cabinet (Two Doors)							✓								104
BLS_ _	Base Lazy Susan Cabinets										✓ [†]	✓ [†]				102
BMW_ _ 35/ BMW_ _ 35DD	Base Built-in Microwave Cabinet							✓	✓	✓	✓					100
BPP09	Base Pantry Pull-out Cabinet		✓													91
BPPP24	Base Pots & Pans Pull-out							✓								94
BRER36	Base Roto Easy Reach Cabinet											✓ [†]				101
BSC30PRB	Base SuperCabinets™									✓						89
BSC30RPB	Base SuperCabinets™									✓						89
BSC36PRPB	Base SuperCabinets™										✓					90
BWB_ _	Base Wastebaskets					✓	✓									94
BWB15FH	Base Wastebasket w/Full Height Door				✓											94
BWB_ _ BMG	Base Wastebaskets w/Bottom Mount Guide					✓	✓									95
BWB_ _ FHBMG	Base Wastebaskets, Full Height w/Bottom Mount Guide					✓										95
SB_ _ STNSB	Sink Base SuperCabinets™									✓		✓				97
SB_ _ STSB	Sink Base SuperCabinets™									✓		✓				96
SCER36	Square Corner Easy Reach Cabinet											✓ [†]				101
SCR_ _	Square Corner Roto Cabinets										✓ [†]	✓ [†]				102
TALL CABINETS																
PSC_ _ _ (B)	Pantry SuperCabinets™ (84", 90", 96" Tall)				✓	✓		✓		✓		✓				115
U_ _ _ (B)	Utility Cabinets (84", 90", 96" Tall - 23¼" Deep)				✓	✓		✓		✓		✓				117
U_ _ _ _ 12(B)	Utility Cabinets (84", 90", 96" Tall - 12" Deep)				✓	✓		✓		✓		✓				117
OTHER CABINETS																
VFDB18	Vanity File Drawer Base					✓										121
VFD_ _	Vanity File Drawers					✓	✓									122
VANITY CABINETS																
LCD_ _	Linen Closets w/Drawer (21" Deep)					✓	✓	✓								134
LCD_ _ 18	Linen Closets w/Drawer (18" Deep)					✓	✓	✓								134
LCD18SC	Linen Closet w/Removable Hamper					✓										135
VBPO935	Vanity Base Pull-out		✓													126
ACCESSORIES																
PCDT	Plastic Cutlery Tray (15", 18", 21", 24" Widths)				✓	✓	✓	✓								167
WCDT	Wood Cutlery Tray				✓	✓	✓	✓								167
DWBR	Double Wastebasket Roll-out (Fits: 15" Bases)				✓											172
PDO	Pegged Dish Organizer											✓				167
SRD_ _	Wall Spice Rack (Wall Cabinet Accessory)				✓	✓	✓									166
UPK_ _	Pantry Roll-out Kits				✓	✓	✓	✓		✓		✓				171

[†]Solutions for the corner.

Wall Cabinets, 12" High, 12" Deep

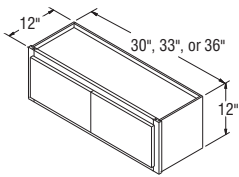

W3012B
W3312B
W3612B

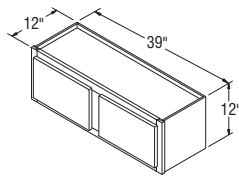

W3912

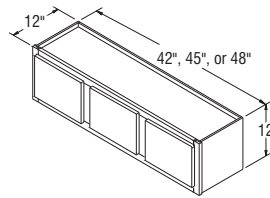

W4212
W4512
W4812

The following note applies to all Wall cabinets within this book.

- ▶ Wall cabinets may be flipped for a left or right hinge preference with the exception of Briarcliff II Arch.

NOTES ✓

- ▶ Shelves not available.
- ▶ Center door on W4212, W4512, and W4812 will be hinged on the left.

DESIGN SOLUTIONS

- ▶ Apply an End Panel Skin to create a flush end on the side of a Wall cabinet if installed at the end of a run for ease of Moulding installation.

Wall Cabinets, 14" High, 12" Deep

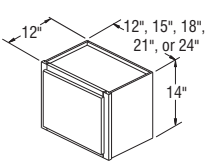

W1214*
W1514*
W1814*
W2114*
W2414*

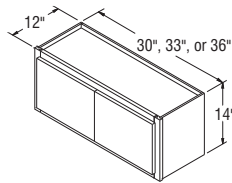

W3014B
W3314B
W3614B

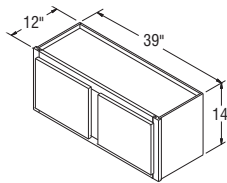

W3914

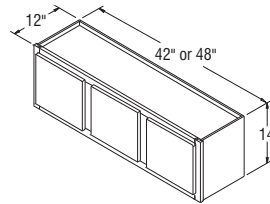

W4214
W4814

NOTES ✓

- ▶ Shelves not available.
- ▶ Center door on W4214 and W4814 will be hinged on the left.

DESIGN SOLUTIONS

- ▶ Apply an End Panel Skin to create a flush end on the side of a Wall cabinet if installed at the end of a run for ease of Moulding installation.

*Specify L or R on all single door Arch styles.

Wall Cabinets, 18" High, 12" Deep

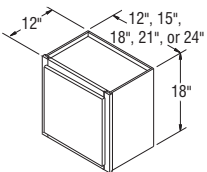

W1218*
W1518*
W1818*
W2118*
W2418*

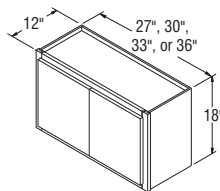

W2718B
W3018B
W3318B
W3618B

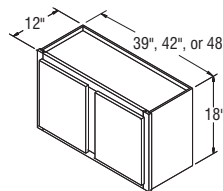

W3918
W4218
W4818

NOTES ✓

- ▶ Shelves not available.

DESIGN SOLUTIONS

- ▶ Apply an End Panel Skin to create a flush end on the side of a Wall cabinet if installed at the end of a run for ease of Moulding installation.

*Specify L or R on all single door Arch styles.

Wall Cabinets, 18" High, 15" Deep

NOTES ✓

- ▶ Shelves not available.
- ▶ When varying heights, make sure to also vary depths to allow moulding to lie against adjacent side of cabinet.

DESIGN SOLUTIONS

- ▶ Apply an End Panel Skin to create a flush end on the side of a Wall cabinet if installed at the end of a run for ease of Moulding installation.

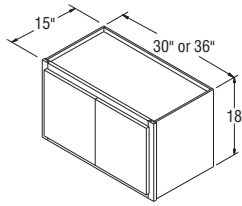

W301815B
W361815B

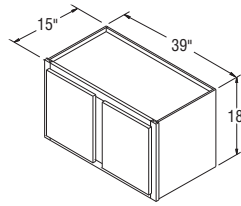

W391815

Wall Cabinets, 21" High, 12" Deep

NOTES ✓

- ▶ Shelves not available.

DESIGN SOLUTIONS

- ▶ Apply an End Panel Skin to create a flush end on the side of a Wall cabinet if installed at the end of a run for ease of Moulding installation.

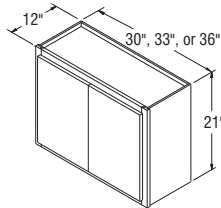

W3021B
W3321B
W3621B

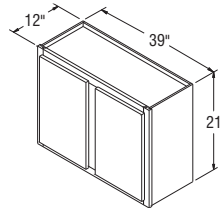

W3921

Wall Cabinets, 21" High, 15" Deep

NOTES ✓

- ▶ Shelves not available.
- ▶ When varying heights, make sure to also vary depths to allow moulding to lie against adjacent side of cabinet.

DESIGN SOLUTIONS

- ▶ Apply an End Panel Skin to create a flush end on the side of a Wall cabinet if installed at the end of a run for ease of Moulding installation.

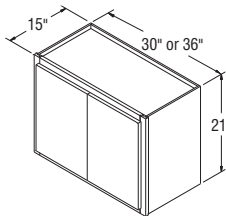

W302115B
W362115B

Wall Cabinets, 24" High, 12" Deep

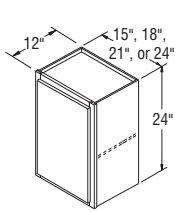

W1524*
W1824*
W2124*
W2424*

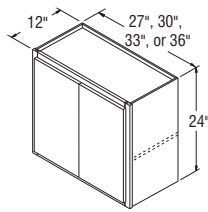

W2724B
W3024B
W3324B
W3624B

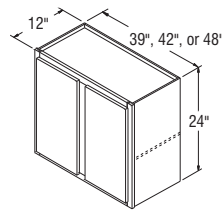

W3924
W4224
W4824

*Specify L or R on all single door Arch styles.

NOTES ✓

- ▶ Center shelf support clip included on Wall Double Door cabinets 27" wide and greater.
- ▶ One adjustable shelf.

DESIGN SOLUTIONS

- ▶ Apply an End Panel Skin to create a flush end on the side of a Wall cabinet if installed at the end of a run for ease of Moulding installation.

Wall Cabinets, 24" High, 15" Deep

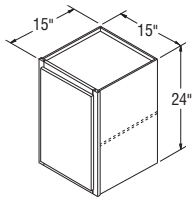

W152415*

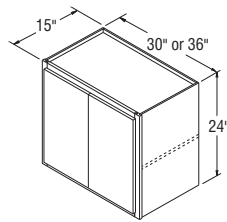

W302415B
W362415B

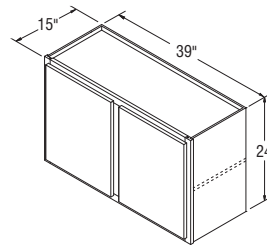

W392415

*Specify L or R on all single door Arch styles.

NOTES ✓

- ▶ Center shelf support clip included on Wall Double Door cabinets 27" wide and greater.
- ▶ One adjustable shelf.
- ▶ When varying heights, make sure to also vary depths to allow moulding to lie against adjacent side of cabinet.

DESIGN SOLUTIONS

- ▶ Apply an End Panel Skin to create a flush end on the side of a Wall cabinet if installed at the end of a run for ease of Moulding installation.

Wall Cabinets, 27" High, 12" Deep

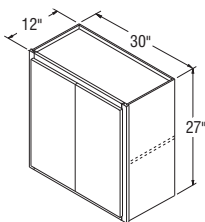

W3027B

NOTES ✓

- ▶ Center shelf support clip included on Wall Double Door cabinets 27" wide and greater.
- ▶ One adjustable shelf.

DESIGN SOLUTIONS

- ▶ Apply an End Panel Skin to create a flush end on the side of a Wall cabinet if installed at the end of a run for ease of Moulding installation.

Wall Cabinets, 30" High, 12" Deep

NOTES ✓

- ▶ Center shelf support clip included on Wall Double Door cabinets 27" wide and greater.
- ▶ Two adjustable shelves.
- ▶ All W0930 cabinets have square doors.

DESIGN SOLUTIONS

- ▶ Apply an End Panel Skin to create a flush end on the side of a Wall cabinet if installed at the end of a run for ease of Moulding installation.

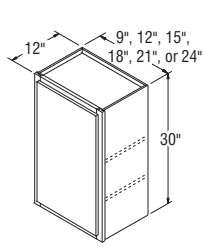

W0930
W1230*
W1530*
W1830*
W2130*
W2430*

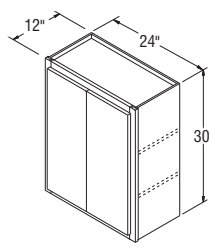

W2430DD

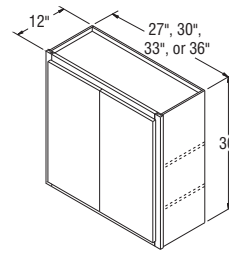

W2730B
W3030B
W3330B
W3630B

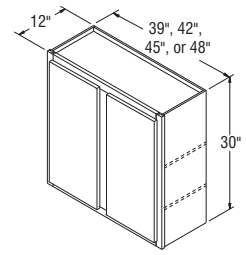

W3930
W4230
W4530
W4830

*Specify L or R on all single door Arch styles.

Wall Cabinets, 30" High, 15" Deep

NOTES ✓

- ▶ Center shelf support clip included on Wall Double Door cabinets 27" wide and greater.
- ▶ Two adjustable shelves.
- ▶ When varying heights, make sure to also vary depths to allow moulding to lie against adjacent side of cabinet.

DESIGN SOLUTIONS

- ▶ Apply an End Panel Skin to create a flush end on the side of a Wall cabinet if installed at the end of a run for ease of Moulding installation.

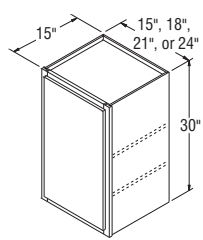

W153015*
W183015*
W213015*
W243015*

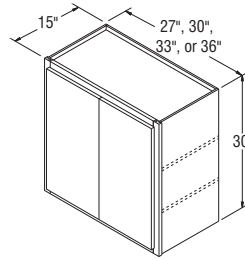

W273015B
W303015B
W333015B
W363015B

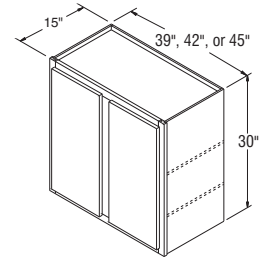

W393015
W423015
W453015

*Specify L or R on all single door Arch styles.

Wall Cabinets, 36" High, 12" Deep

NOTES ✓

- ▶ Center shelf support clip included on Wall Double Door cabinets 27" wide and greater.
- ▶ Two adjustable shelves.
- ▶ All W0936 cabinets have square doors.

DESIGN SOLUTIONS

- ▶ Apply an End Panel Skin to create a flush end on the side of a Wall cabinet if installed at the end of a run for ease of Moulding installation.

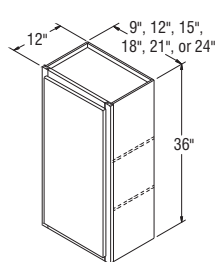

W0936
W1236*
W1536*
W1836*
W2136*
W2436*

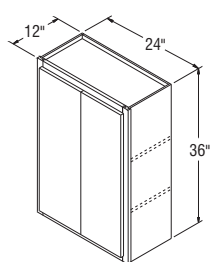

W2436DD

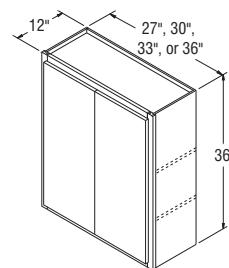

W2736B
W3036B
W3336B
W3636B

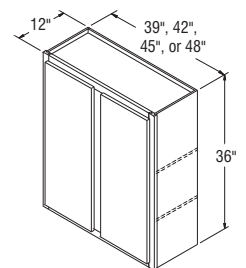

W3936
W4236
W4536
W4836

*Specify L or R on all single door Arch styles.

Wall Cabinets, 36" High, 15" Deep

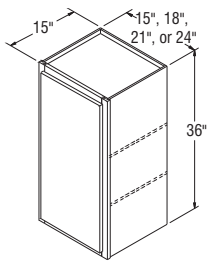

W153615*
W183615*
W213615*
W243615*

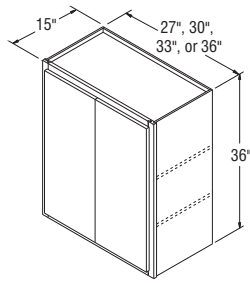

W273615B
W303615B
W333615B
W363615B

*Specify L or R on all single door Arch styles.

NOTES ✓

- ▶ Center shelf support clip included on Wall Double Door cabinets 27" wide and greater.
- ▶ Two adjustable shelves.
- ▶ When varying heights, make sure to also vary depths to allow moulding to lie against adjacent side of cabinet.

DESIGN SOLUTIONS

- ▶ Apply an End Panel Skin to create a flush end on the side of a Wall cabinet if installed at the end of a run for ease of Moulding installation.

Wall Cabinets, 42" High, 12" Deep

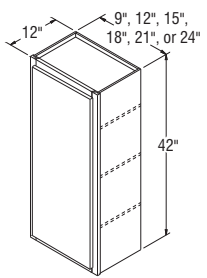

W0942
W1242*
W1542*
W1842*
W2142*
W2442*

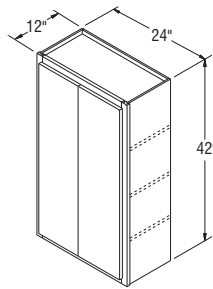

W2442DD

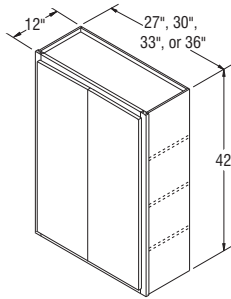

W2742B
W3042B
W3342B
W3642B

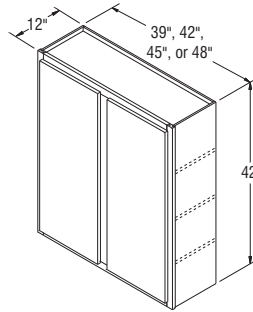

W3942
W4242
W4542
W4842

*Specify L or R on all single door Arch styles.

NOTES ✓

- ▶ Center shelf support clip included on Wall Double Door cabinets 27" wide and greater.
- ▶ Three adjustable shelves.
- ▶ All W0942 cabinets have square doors.

DESIGN SOLUTIONS

- ▶ Apply an End Panel Skin to create a flush end on the side of a Wall cabinet if installed at the end of a run for ease of Moulding installation.

Wall Cabinets, 42" High, 15" Deep

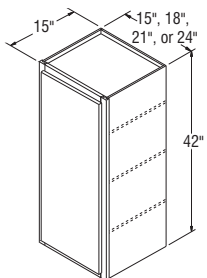

W154215*
W184215*
W214215*
W244215*

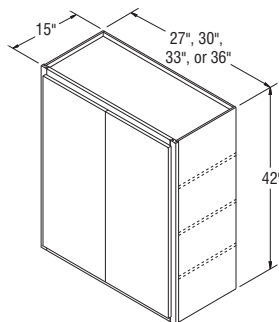

W274215B
W304215B
W334215B
W364215B

*Specify L or R on all single door Arch styles.

NOTES ✓

- ▶ Center shelf support clip included on Wall Double Door cabinets 27" wide and greater.
- ▶ Three adjustable shelves.
- ▶ When varying heights, make sure to also vary depths to allow moulding to lie against adjacent side of cabinet.

DESIGN SOLUTIONS

- ▶ Apply an End Panel Skin to create a flush end on the side of a Wall cabinet if installed at the end of a run for ease of Moulding installation.

Wall Open Cabinets, 12" High, 12" Deep

NOTES ✓

- ▶ Shelves not available.
- ▶ Cabinets include matching Aristex™ interior.
- ▶ Doors can be added in the field, if desired.

DESIGN SOLUTIONS

- ▶ Apply an End Panel Skin to create a flush end on the side of a Wall cabinet if installed at the end of a run for ease of Moulding installation.

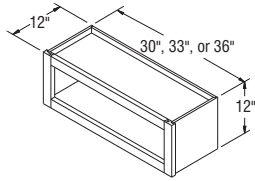

WOL3012
WOL3312
WOL3612

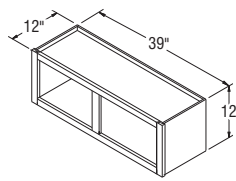

WOL3912

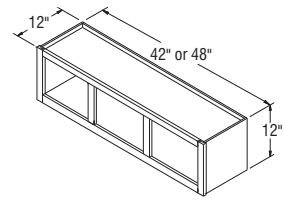

WOL4212
WOL4812

Wall Open Cabinets, 14" High, 12" Deep

NOTES ✓

- ▶ Shelves not available.
- ▶ Cabinets include matching Aristex™ interior.
- ▶ Doors can be added in the field, if desired.

DESIGN SOLUTIONS

- ▶ Apply an End Panel Skin to create a flush end on the side of a Wall cabinet if installed at the end of a run for ease of Moulding installation.

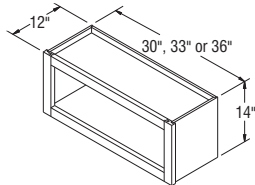

WOL3014
WOL3314
WOL3614

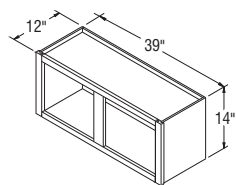

WOL3914

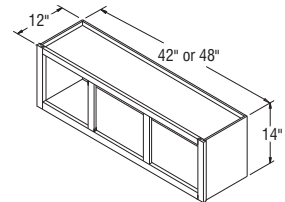

WOL4214
WOL4814

Wall Open Cabinets, 18" High, 12" Deep

NOTES ✓

- ▶ Shelves not available.
- ▶ Cabinets include matching Aristex™ interior.
- ▶ Doors can be added in the field, if desired.

DESIGN SOLUTIONS

- ▶ Apply an End Panel Skin to create a flush end on the side of a Wall cabinet if installed at the end of a run for ease of Moulding installation.

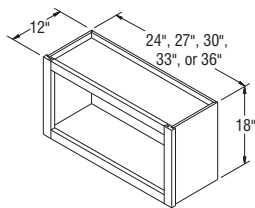

WOL2418
WOL2718
WOL3018
WOL3318
WOL3618

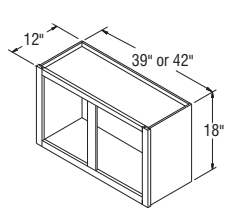

WOL3918
WOL4218

Wall Open Cabinets, 21" High, 12" Deep

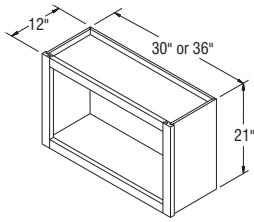

WOL3021
WOL3621

NOTES ✓

- ▶ Shelves not available.
- ▶ Cabinets include matching Aristex™ interior.
- ▶ Doors can be added in the field, if desired.

DESIGN SOLUTIONS

- ▶ Apply an End Panel Skin to create a flush end on the side of a Wall cabinet if installed at the end of a run for ease of Moulding installation.

Wall Open Cabinets, 21" High, 15" Deep

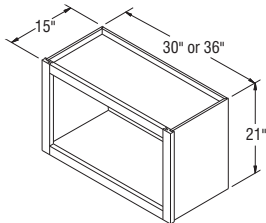

WOL302115
WOL362115

NOTES ✓

- ▶ Shelves not available.
- ▶ Cabinets include matching Aristex™ interior.
- ▶ Doors can be added in the field, if desired.
- ▶ When varying heights, make sure to also vary depths to allow moulding to lie against adjacent side of cabinet.

DESIGN SOLUTIONS

- ▶ Apply an End Panel Skin to create a flush end on the side of a Wall cabinet if installed at the end of a run for ease of Moulding installation.

Wall Open Cabinets, 24" High, 12" Deep

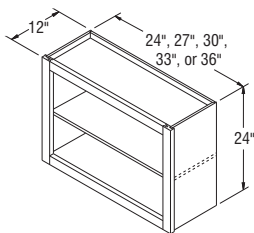

WOL2424
WOL2724
WOL3024
WOL3324
WOL3624

NOTES ✓

- ▶ One adjustable 3/4" thick matching Aristex™ shelf.
- ▶ Cabinets include matching Aristex™ interior.
- ▶ Doors can be added in the field, if desired.

DESIGN SOLUTIONS

- ▶ Apply an End Panel Skin to create a flush end on the side of a Wall cabinet if installed at the end of a run for ease of Moulding installation.

Wall Open Cabinets, 24" High, 15" Deep

NOTES ✓

- ▶ One adjustable 3/4" thick matching Aristex™ shelf.
- ▶ Cabinets include matching Aristex™ interior.
- ▶ Doors can be added in the field, if desired.
- ▶ When varying heights, make sure to also vary depths to allow moulding to lie against adjacent side of cabinet.

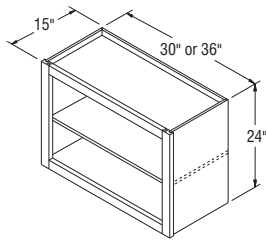

WOL302415
WOL362415

DESIGN SOLUTIONS

- ▶ Apply an End Panel Skin to create a flush end on the side of a Wall cabinet if installed at the end of a run for ease of Moulding installation.

Wall Open Cabinets, 30" High, 12" Deep

NOTES ✓

- ▶ Two adjustable 3/4" thick matching Aristex® shelves.
- ▶ Cabinets include matching Aristex™ interior.
- ▶ Doors can be added in the field, if desired.

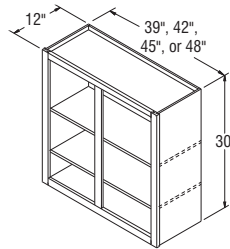
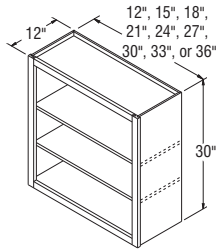

WOL1230
WOL1530
WOL1830
WOL2130
WOL2430
WOL2730
WOL3030
WOL3330
WOL3630

WOL3930
WOL4230
WOL4530
WOL4830

DESIGN SOLUTIONS

- ▶ Apply an End Panel Skin to create a flush end on the side of a Wall cabinet if installed at the end of a run for ease of Moulding installation.

Wall Open Cabinets, 30" High, 15" Deep

NOTES ✓

- ▶ Two adjustable 3/4" thick matching Aristex® shelves.
- ▶ Cabinets include matching Aristex™ interior.
- ▶ Doors can be added in the field, if desired.
- ▶ When varying heights, make sure to also vary depths to allow moulding to lie against adjacent side of cabinet.

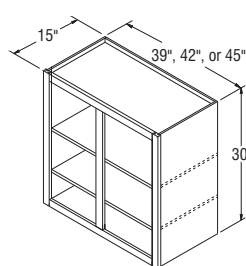
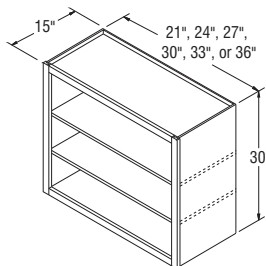

WOL213015
WOL243015
WOL273015
WOL303015
WOL333015
WOL363015

WOL393015
WOL423015
WOL453015

DESIGN SOLUTIONS

- ▶ Apply an End Panel Skin to create a flush end on the side of a Wall cabinet if installed at the end of a run for ease of Moulding installation.

Wall Open Cabinets, 36" High, 12" Deep

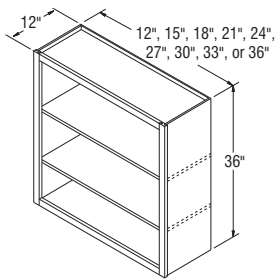

WOL1236 **WOL2736**
WOL1536 **WOL3036**
WOL1836 **WOL3336**
WOL2136 **WOL3636**
WOL2436

NOTES ✓

- ▶ Two adjustable $\frac{3}{4}$ " thick matching Aristex™ shelves.
- ▶ Cabinets include matching Aristex™ interior.
- ▶ Doors can be added in the field, if desired.

DESIGN SOLUTIONS

- ▶ Apply an End Panel Skin to create a flush end on the side of a Wall cabinet if installed at the end of a run for ease of Moulding installation.

Wall Open Cabinets, 36" High, 15" Deep

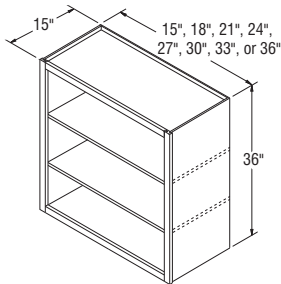

WOL153615
WOL183615
WOL213615
WOL243615
WOL273615
WOL303615
WOL333615
WOL363615

NOTES ✓

- ▶ Two adjustable $\frac{3}{4}$ " thick matching Aristex™ shelves.
- ▶ Cabinets include matching Aristex™ interior.
- ▶ Doors can be added in the field, if desired.
- ▶ When varying heights, make sure to also vary depths to allow moulding to lie against adjacent side of cabinet.

DESIGN SOLUTIONS

- ▶ Apply an End Panel Skin to create a flush end on the side of a Wall cabinet if installed at the end of a run for ease of Moulding installation.

Wall Open Cabinets, 42" High, 12" Deep

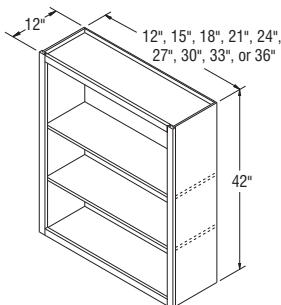

WOL1242 **WOL2742**
WOL1542 **WOL3042**
WOL1842 **WOL3342**
WOL2142 **WOL3642**
WOL2442

NOTES ✓

- ▶ Two adjustable $\frac{3}{4}$ " thick matching Aristex™ shelves.
- ▶ Cabinets include matching Aristex™ interior.
- ▶ Doors can be added in the field, if desired.

DESIGN SOLUTIONS

- ▶ Apply an End Panel Skin to create a flush end on the side of a Wall cabinet if installed at the end of a run for ease of Moulding installation.

Wall Open Cabinets, 42" High, 15" Deep

NOTES ✓

- ▶ Two adjustable ¾" thick matching Aristex™ shelves.
- ▶ Cabinets include matching Aristex™ shelves.
- ▶ Doors can be added in the field, if desired.
- ▶ When varying heights, make sure to also vary depths to allow moulding to lie against adjacent side of cabinet.

DESIGN SOLUTIONS

- ▶ Apply an End Panel Skin to create a flush end on the side of a Wall cabinet if installed at the end of a run for ease of Moulding installation.

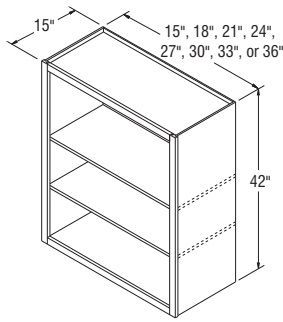

- WOL154215**
- WOL184215**
- WOL214215**
- WOL244215**
- WOL274215**
- WOL304215**
- WOL334215**
- WOL364215**

Wall Cabinets with Mullion Doors, 18" High, 12" Deep

NOTES ✓

- ▶ Shelves not available.
- ▶ Cabinets include installed, clear tempered glass, and matching Aristex™ interior.
- ▶ See page 28 for Standard and Shaker Mullion Door style availability and grid configurations.
- ▶ Mullion Door cabinets are not available in Teagan.

DESIGN SOLUTIONS

- ▶ Apply an End Panel Skin to create a flush end on the side of a Wall cabinet if installed at the end of a run for ease of Moulding installation.
- ▶ For complementary Wall Mullion Door cabinets in Teagan, order as Winstead Maple, as Teagan features a slab door design.

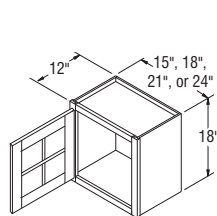

- WMD1518***
- WMD1818***
- WMD2118***
- WMD2418***

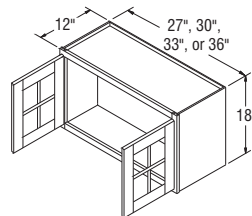

- WMD2718B**
- WMD3018B**
- WMD3318B**
- WMD3618B**

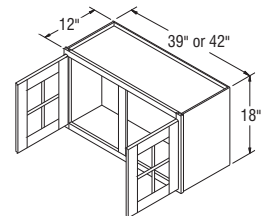

- WMD3918**
- WMD4218**

*Specify L or R on all single door Arch styles.

Wall Cabinets with Mullion Doors, 21" High, 12" Deep

NOTES ✓

- ▶ Shelves not available.
- ▶ Cabinets include installed, clear tempered glass, and matching Aristex™ interior.
- ▶ See page 28 for Standard and Shaker Mullion Door style availability and grid configurations.
- ▶ Mullion Door cabinets are not available in Teagan.

DESIGN SOLUTIONS

- ▶ Apply an End Panel Skin to create a flush end on the side of a Wall cabinet if installed at the end of a run for ease of Moulding installation.
- ▶ For complementary Wall Mullion Door cabinets in Teagan, order as Winstead Maple, as Teagan features a slab door design.

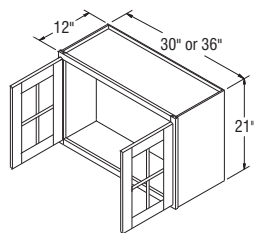

- WMD3021B**
- WMD3621B**

Wall Cabinets with Mullion Doors, 21" High, 15" Deep

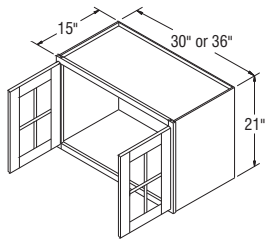

WMD302115B
WMD362115B

NOTES ✓

- ▶ Shelves not available.
- ▶ Cabinets include installed, clear tempered glass, and matching Aristex™ interior.
- ▶ See page 28 for Standard and Shaker Mullion Door style availability and grid configurations.
- ▶ Mullion Door cabinets are not available in Teagan.

DESIGN SOLUTIONS

- ▶ Apply an End Panel Skin to create a flush end on the side of a Wall cabinet if installed at the end of a run for ease of Moulding installation.
- ▶ For complementary Wall Mullion Door cabinets in Teagan, order as Winstead Maple, as Teagan features a slab door design.

Wall Cabinets with Mullion Doors, 24" High, 12" Deep

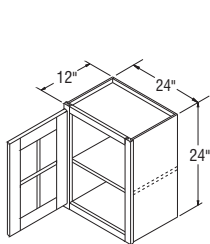

WMD2424*

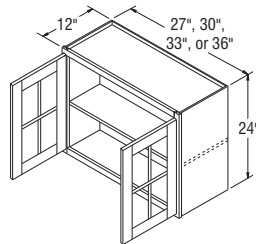

WMD2724B
WMD3024B
WMD3324B
WMD3624B

*Specify L or R on all single door Arch styles.

NOTES ✓

- ▶ One adjustable 3/4" thick matching Aristex™ shelf aligns with door mullions on Standard mullions, but does not align on Shaker mullions.
- ▶ Cabinets include installed, clear tempered glass, and matching Aristex™ interior.
- ▶ See page 28 for Standard and Shaker Mullion Door style availability and grid configurations.
- ▶ Mullion Door cabinets are not available in Teagan.

DESIGN SOLUTIONS

- ▶ Apply an End Panel Skin to create a flush end on the side of a Wall cabinet if installed at the end of a run for ease of Moulding installation.
- ▶ For complementary Wall Mullion Door cabinets in Teagan, order as Winstead Maple, as Teagan features a slab door design.

Wall Cabinets with Mullion Doors, 24" High, 15" Deep

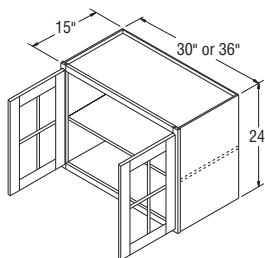

WMD302415B
WMD362415B

NOTES ✓

- ▶ One adjustable 3/4" thick matching Aristex™ shelf aligns with door mullions on Standard mullions, but does not align on Shaker mullions.
- ▶ Cabinets include installed, clear tempered glass, and matching Aristex™ interior.
- ▶ See page 28 for Standard and Shaker Mullion Door style availability and grid configurations.
- ▶ Mullion Door cabinets are not available in Teagan.

DESIGN SOLUTIONS

- ▶ Apply an End Panel Skin to create a flush end on the side of a Wall cabinet if installed at the end of a run for ease of Moulding installation.
- ▶ For complementary Wall Mullion Door cabinets in Teagan, order as Winstead Maple, as Teagan features a slab door design.

NOTES ✓

- ▶ Two adjustable 3/4" thick matching Aristex™ shelves align with door mullions on Standard mullions, but do not align on Shaker mullions.
- ▶ Cabinets include installed, clear tempered glass and matching Aristex™ interior.
- ▶ See page 28 for Standard and Shaker Mullion Door style availability and grid configurations.
- ▶ Mullion Door cabinets are not available in Teagan.

DESIGN SOLUTIONS

- ▶ Apply an End Panel Skin to create a flush end on the side of a Wall cabinet if installed at the end of a run for ease of Moulding installation.
- ▶ For complementary Wall Mullion Door cabinets in Teagan, order as Winstead Maple, as Teagan features a slab door design.

Wall Cabinets with Mullion Doors, 30" High, 12" Deep

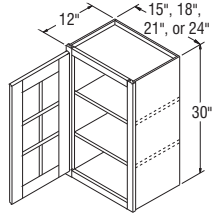

WMD1530*
WMD1830*
WMD2130*
WMD2430*

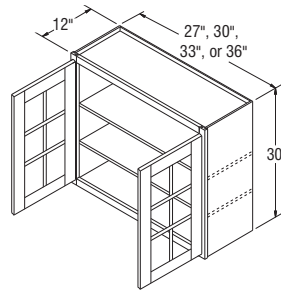

WMD2730B
WMD3030B
WMD3330B
WMD3630B

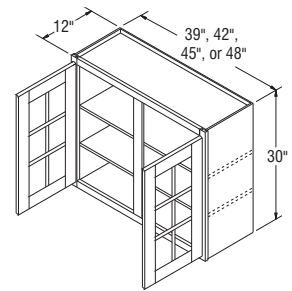

WMD3930
WMD4230
WMD4530
WMD4830

*Specify L or R on all single door Arch styles.

NOTES ✓

- ▶ Two adjustable 3/4" thick matching Aristex™ shelves align with door mullions on Standard mullions, but do not align on Shaker mullions.
- ▶ Cabinets include installed, clear tempered glass, and matching Aristex™ interior.
- ▶ See page 28 for Standard and Shaker Mullion Door style availability and grid configurations.
- ▶ Mullion Door cabinets are not available in Teagan.

DESIGN SOLUTIONS

- ▶ Apply an End Panel Skin to create a flush end on the side of a Wall cabinet if installed at the end of a run for ease of Moulding installation.
- ▶ For complementary Wall Mullion Door cabinets in Teagan, order as Winstead Maple, as Teagan features a slab door design.

Wall Cabinets with Mullion Doors, 30" High, 15" Deep

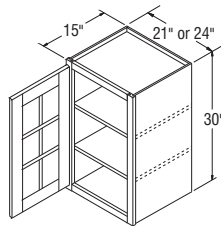

WMD213015*
WMD243015*

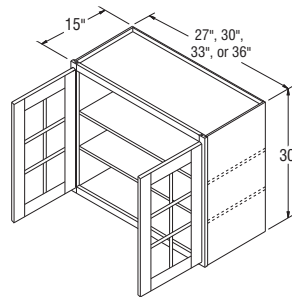

WMD273015B
WMD303015B
WMD333015B
WMD363015B

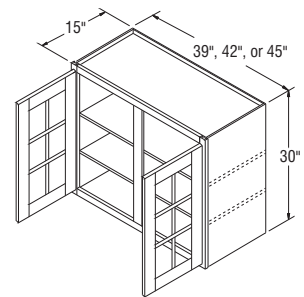

WMD393015
WMD423015
WMD453015

*Specify L or R on all single door Arch styles.

Wall Cabinets with Mullion Doors, 36" High, 12" Deep

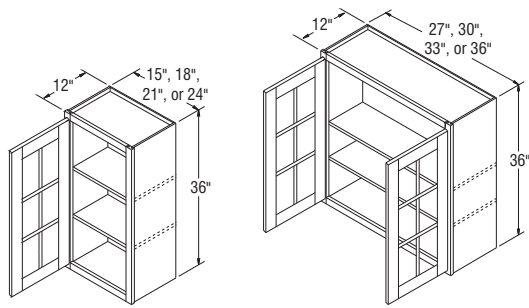

WMD1536*
WMD1836*
WMD2136*
WMD2436*

WMD2736B
WMD3036B
WMD3336B
WMD3636B

*Specify L or R on all single door Arch styles.

NOTES ✓

- ▶ Two adjustable $\frac{3}{4}$ " thick matching Aristex™ shelves align with door mullions on Standard mullions, but do not align on Shaker mullions.
- ▶ Cabinets include installed, clear tempered glass and matching Aristex™ interior.
- ▶ See page 28 for Standard and Shaker Mullion Door style availability and grid configurations.
- ▶ Mullion Door cabinets are not available in Teagan.

DESIGN SOLUTIONS

- ▶ Apply an End Panel Skin to create a flush end on the side of a Wall cabinet if installed at the end of a run for ease of Moulding installation.
- ▶ For complementary Wall Mullion Door cabinets in Teagan, order as Winstead Maple, as Teagan features a slab door design.

Wall Cabinets with Mullion Doors, 36" High, 15" Deep

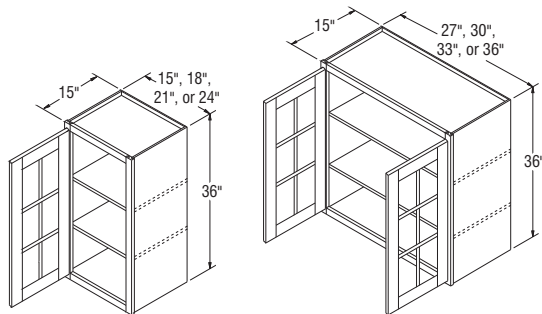

WMD153615*
WMD183615*
WMD213615*
WMD243615*

WMD273615B
WMD303615B
WMD333615B
WMD363615B

*Specify L or R on all single door Arch styles.

NOTES ✓

- ▶ Two adjustable $\frac{3}{4}$ " thick matching Aristex™ shelves align with door mullions on Standard mullions, but do not align on Shaker mullions.
- ▶ Cabinets include installed, clear tempered glass, and matching Aristex™ interior.
- ▶ See page 28 for Standard and Shaker Mullion Door style availability and grid configurations.
- ▶ Mullion Door cabinets are not available in Teagan.

DESIGN SOLUTIONS

- ▶ Apply an End Panel Skin to create a flush end on the side of a Wall cabinet if installed at the end of a run for ease of Moulding installation.
- ▶ For complementary Wall Mullion Door cabinets in Teagan, order as Winstead Maple, as Teagan features a slab door design.

Wall Cabinets with Mullion Doors, 42" High, 12" Deep

NOTES ✓

- ▶ Two adjustable 3/4" thick matching Aristex™ shelves align with door mullions on Standard mullions, but do not align on Shaker mullions.
- ▶ Cabinets include installed, clear tempered glass and matching Aristex™ interior.
- ▶ See page 28 for Standard and Shaker Mullion Door style availability and grid configurations.
- ▶ Mullion Door cabinets are not available in Teagan.

DESIGN SOLUTIONS

- ▶ Apply an End Panel Skin to create a flush end on the side of a Wall cabinet if installed at the end of a run for ease of Moulding installation.
- ▶ For complementary Wall Mullion Door cabinets in Teagan, order as Winstead Maple, as Teagan features a slab door design.

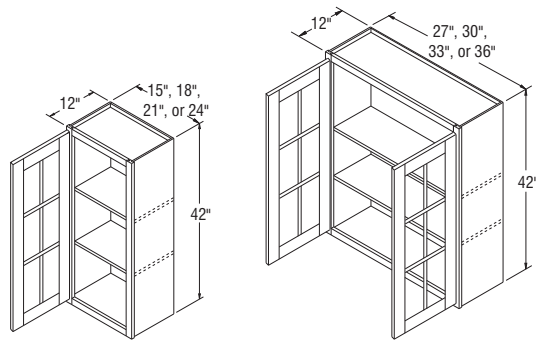

WMD1542*
WMD1842*
WMD2142*
WMD2442*

WMD2742B
WMD3042B
WMD3342B
WMD3642B

*Specify L or R on all single door Arch styles.

NOTES ✓

- ▶ Two adjustable 3/4" thick matching Aristex™ shelves align with door mullions on Standard mullions, but do not align on Shaker mullions.
- ▶ Cabinets include installed, clear tempered glass, and matching Aristex™ interior.
- ▶ See page 28 for Standard and Shaker Mullion Door style availability and grid configurations.
- ▶ Mullion Door cabinets are not available in Teagan.

DESIGN SOLUTIONS

- ▶ Apply an End Panel Skin to create a flush end on the side of a Wall cabinet if installed at the end of a run for ease of Moulding installation.
- ▶ For complementary Wall Mullion Door cabinets in Teagan, order as Winstead Maple, as Teagan features a slab door design.

Wall Cabinets with Mullion Doors, 42" High, 15" Deep

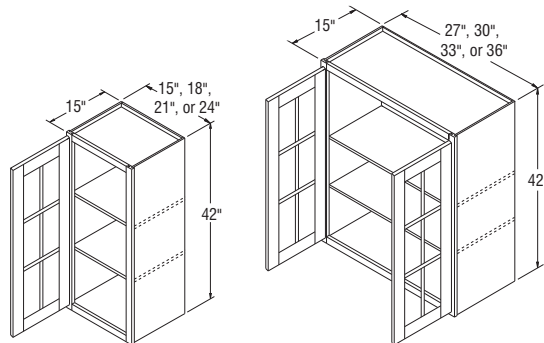

WMD154215*
WMD184215*
WMD214215*
WMD244215*

WMD274215B
WMD304215B
WMD334215B
WMD364215B

*Specify L or R on all single door Arch styles.

Wall Cabinets with Doors Prepped for Glass, 12" High, 12" Deep

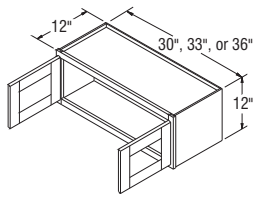

WPG3012B
WPG3312B
WPG3612B

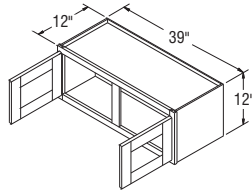

WPG3912

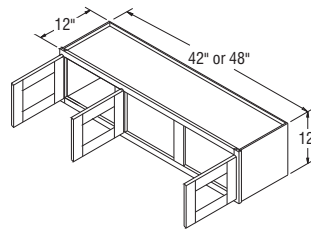

WPG4212
WPG4812

NOTES ✓

- ▶ Shelves not available.
- ▶ Cabinets include matching Aristex™ interior and clips to install glass (glass not included).
- ▶ Wall Prepped for Glass cabinets are not available in Augusta or Teagan.
- ▶ Center door on WPG4212 and WPG4812 will be hinged on the left.
- ▶ Doors Only for WPG cabinets can be ordered to meet the need for Doors Cut-for-glass.

DESIGN SOLUTIONS

- ▶ Apply an End Panel Skin to create a flush end on the side of a Wall cabinet if installed at the end of a run for ease of Moulding installation.
- ▶ For complementary Wall Prepped for Glass cabinets in Teagan, order as Winstead Maple, as Teagan features a slab door design.

Wall Cabinets with Doors Prepped for Glass, 14" High, 12" Deep

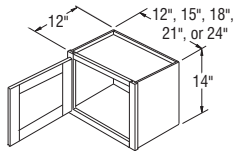

WPG1214*
WPG1514*
WPG1814*
WPG2114*
WPG2414*

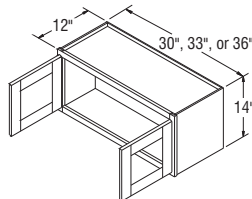

WPG3014B
WPG3314B
WPG3614B

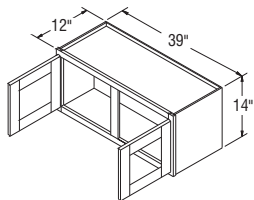

WPG3914

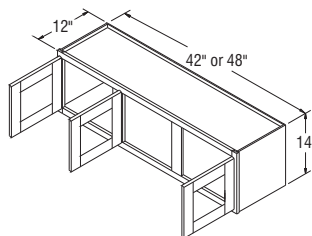

WPG4214
WPG4814

NOTES ✓

- ▶ Shelves not available.
- ▶ Cabinets include matching Aristex™ interior and clips to install glass (glass not included).
- ▶ Wall Prepped for Glass cabinets are not available in Augusta or Teagan.
- ▶ Center door on WPG4214 and WPG4814 will be hinged on the left.
- ▶ Doors Only for WPG cabinets can be ordered to meet the need for Doors Cut-for-glass.

DESIGN SOLUTIONS

- ▶ Apply an End Panel Skin to create a flush end on the side of a Wall cabinet if installed at the end of a run for ease of Moulding installation.
- ▶ For complementary Wall Prepped for Glass cabinets in Teagan, order as Winstead Maple, as Teagan features a slab door design.

*Specify L or R on all single door Arch styles.

NOTES ✓

- ▶ Shelves not available.
- ▶ Cabinets include matching Aristex™ interior and clips to install glass (glass not included).
- ▶ Wall Prepped for Glass cabinets are not available in Augusta or Teagan.
- ▶ Doors Only for WPG cabinets can be ordered to meet the need for Doors Cut-for-glass.

DESIGN SOLUTIONS

- ▶ Apply an End Panel Skin to create a flush end on the side of a Wall cabinet if installed at the end of a run for ease of Moulding installation.
- ▶ For complementary Wall Prepped for Glass cabinets in Teagan, order as Winstead Maple, as Teagan features a slab door design.

Wall Cabinets with Doors Prepped for Glass, 18" High, 12" Deep

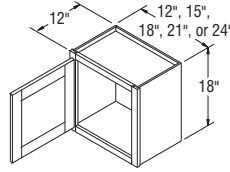

- WPG1218***
- WPG1518***
- WPG1818***
- WPG2118***
- WPG2418***

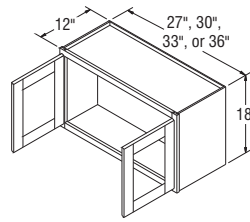

- WPG2718B**
- WPG3018B**
- WPG3318B**
- WPG3618B**

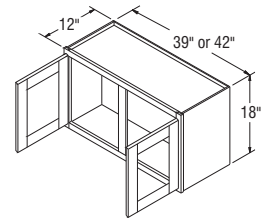

- WPG3918**
- WPG4218**

*Specify L or R on all single door Arch styles.

NOTES ✓

- ▶ Shelves not available.
- ▶ Cabinets include matching Aristex™ interior and clips to install glass (glass not included).
- ▶ Wall Prepped for Glass cabinets are not available in Augusta or Teagan.
- ▶ Doors Only for WPG cabinets can be ordered to meet the need for Doors Cut-for-glass.

DESIGN SOLUTIONS

- ▶ Apply an End Panel Skin to create a flush end on the side of a Wall cabinet if installed at the end of a run for ease of Moulding installation.
- ▶ For complementary Wall Prepped for Glass cabinets in Teagan, order as Winstead Maple, as Teagan features a slab door design.

Wall Cabinets with Doors Prepped for Glass, 21" High, 12" Deep

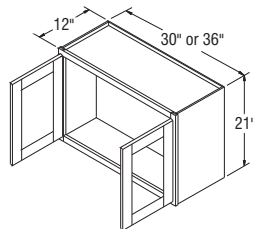

- WPG3021B**
- WPG3621B**

Wall Cabinets with Doors Prepped for Glass, 21" High, 15" Deep

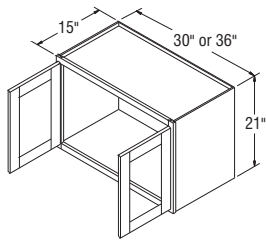

WPG302115B
WPG362115B

NOTES ✓

- ▶ Shelves not available.
- ▶ Cabinets include matching Aristex™ interior and clips to install glass (glass not included).
- ▶ Wall Prepped for Glass cabinets are not available in Augusta or Teagan.
- ▶ Doors Only for WPG cabinets can be ordered to meet the need for Doors Cut-for-glass.

DESIGN SOLUTIONS

- ▶ Apply an End Panel Skin to create a flush end on the side of a Wall cabinet if installed at the end of a run for ease of Moulding installation.
- ▶ For complementary Wall Prepped for Glass cabinets in Teagan, order as Winstead Maple, as Teagan features a slab door design.

Wall Cabinets with Doors Prepped for Glass, 24" High, 12" Deep

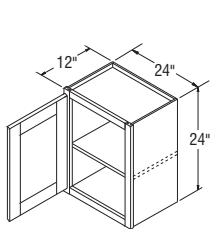

WPG2424*

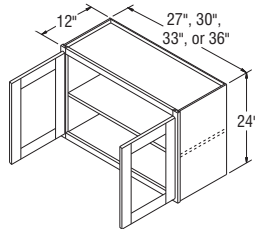

WPG2724B
WPG3024B
WPG3324B
WPG3624B

*Specify L or R on all single door Arch styles.

NOTES ✓

- ▶ Cabinets include matching Aristex™ interior and clips to install glass (glass not included).
- ▶ Wall Prepped for Glass cabinets are not available in Augusta or Teagan.
- ▶ Doors Only for WPG cabinets can be ordered to meet the need for Doors Cut-for-glass.

DESIGN SOLUTIONS

- ▶ Apply an End Panel Skin to create a flush end on the side of a Wall cabinet if installed at the end of a run for ease of Moulding installation.
- ▶ For complementary Wall Prepped for Glass cabinets in Teagan, order as Winstead Maple, as Teagan features a slab door design.

Wall Cabinets with Doors Prepped for Glass, 24" High, 15" Deep

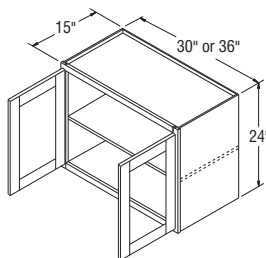

WPG302415B
WPG362415B

NOTES ✓

- ▶ Cabinets include matching Aristex™ interior and clips to install glass (glass not included).
- ▶ Wall Prepped for Glass cabinets are not available in Augusta or Teagan.
- ▶ Doors Only for WPG cabinets can be ordered to meet the need for Doors Cut-for-glass.

DESIGN SOLUTIONS

- ▶ Apply an End Panel Skin to create a flush end on the side of a Wall cabinet if installed at the end of a run for ease of Moulding installation.
- ▶ For complementary Wall Prepped for Glass cabinets in Teagan, order as Winstead Maple, as Teagan features a slab door design.

Wall Cabinets with Doors Prepped for Glass, 30" High, 12" Deep

NOTES ✓

- ▶ Cabinets include matching Aristex™ interior and clips to install glass (glass not included).
- ▶ Wall Prepped for Glass cabinets are not available in Augusta or Teagan.
- ▶ Doors Only for WPG cabinets can be ordered to meet the need for Doors Cut-for-glass.

DESIGN SOLUTIONS

- ▶ Apply an End Panel Skin to create a flush end on the side of a Wall cabinet if installed at the end of a run for ease of Moulding installation.
- ▶ For complementary Wall Prepped for Glass cabinets in Teagan, order as Winstead Maple, as Teagan features a slab door design.

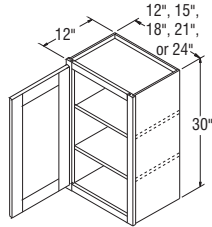

WPG1230*
WPG1530*
WPG1830*
WPG2130*
WPG2430*

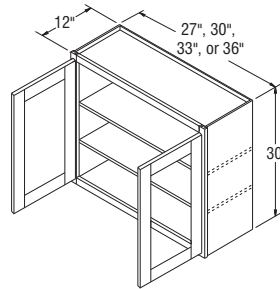

WPG2730B
WPG3030B
WPG3330B
WPG3630B

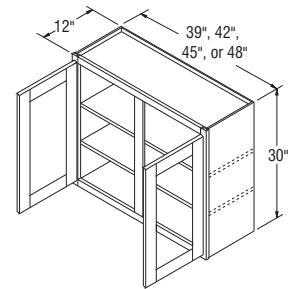

WPG3930
WPG4230
WPG4530
WPG4830

*Specify L or R on all single door Arch styles.

Wall Cabinets with Doors Prepped for Glass, 30" High, 15" Deep

NOTES ✓

- ▶ Cabinets include matching Aristex™ interior and clips to install glass (glass not included).
- ▶ Wall Prepped for Glass cabinets are not available in Augusta or Teagan.
- ▶ Doors Only for WPG cabinets can be ordered to meet the need for Doors Cut-for-glass.

DESIGN SOLUTIONS

- ▶ Apply an End Panel Skin to create a flush end on the side of a Wall cabinet if installed at the end of a run for ease of Moulding installation.
- ▶ For complementary Wall Prepped for Glass cabinets in Teagan, order as Winstead Maple, as Teagan features a slab door design.

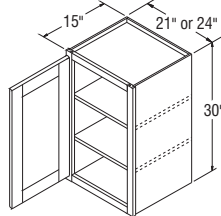

WPG213015*
WPG243015*

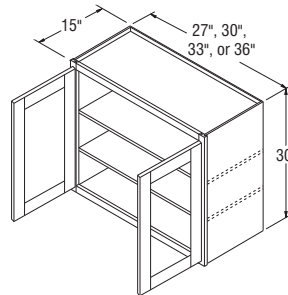

WPG273015B
WPG303015B
WPG333015B
WPG363015B

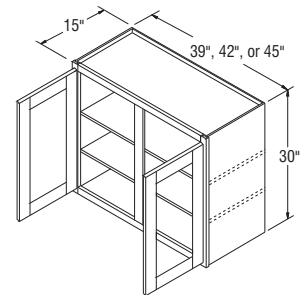

WPG393015
WPG423015
WPG453015

*Specify L or R on all single door Arch styles.

Wall Cabinets with Doors Prepped for Glass, 36" High, 12" Deep

NOTES ✓

- ▶ Cabinets include matching Aristex™ interior and clips to install glass (glass not included).
- ▶ Wall Prepped for Glass cabinets are not available in Augusta or Teagan.
- ▶ Doors Only for WPG cabinets can be ordered to meet the need for Doors Cut-for-glass.

DESIGN SOLUTIONS

- ▶ Apply an End Panel Skin to create a flush end on the side of a Wall cabinet if installed at the end of a run for ease of Moulding installation.
- ▶ For complementary Wall Prepped for Glass cabinets in Teagan, order as Winstead Maple, as Teagan features a slab door design.

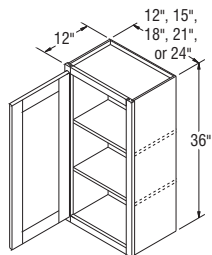

WPG1236*
WPG1536*
WPG1836*
WPG2136*
WPG2436*

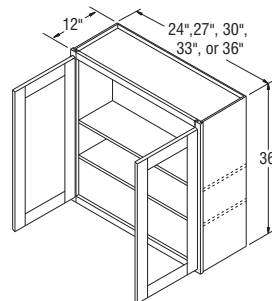

WPG2436DD
WPG2736B
WPG3036B
WPG3336B
WPG3636B

*Specify L or R on all single door Arch styles.

Wall Cabinets with Doors Prepped for Glass, 36" High, 15" Deep

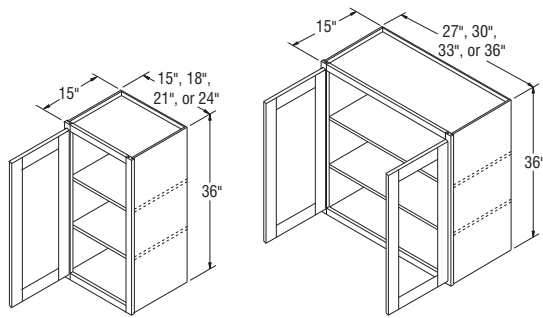

WPG153615*
WPG183615*
WPG213615*
WPG243615*

WPG273615B
WPG303615B
WPG333615B
WPG363615B

*Specify L or R on all single door Arch styles.

NOTES ✓

- ▶ Cabinets include matching Aristex™ interior and clips to install glass (glass not included).
- ▶ Wall Prepped for Glass cabinets are not available in Augusta or Teagan.
- ▶ Doors Only for WPG cabinets can be ordered to meet the need for Doors Cut-for-glass.

DESIGN SOLUTIONS

- ▶ Apply an End Panel Skin to create a flush end on the side of a Wall cabinet if installed at the end of a run for ease of Moulding installation.
- ▶ For complementary Wall Prepped for Glass cabinets in Teagan, order as Winstead Maple, as Teagan features a slab door design.

Wall Cabinets with Doors Prepped for Glass, 42" High, 12" Deep

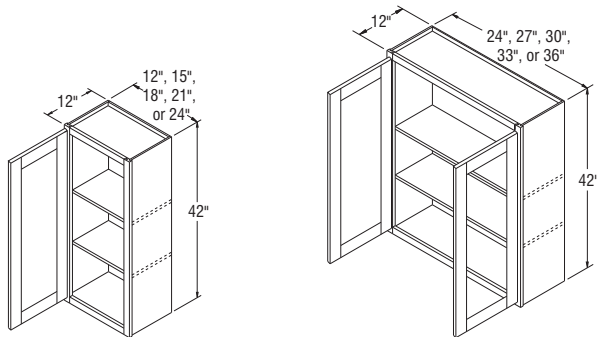

WPG1242*
WPG1542*
WPG1842*
WPG2142*
WPG2442*

WPG2442DD
WPG2742B
WPG3042B
WPG3342B
WPG3642B

*Specify L or R on all single door Arch styles.

NOTES ✓

- ▶ Cabinets include matching Aristex™ interior and clips to install glass (glass not included).
- ▶ Wall Prepped for Glass cabinets are not available in Augusta or Teagan.
- ▶ Doors Only for WPG cabinets can be ordered to meet the need for Doors Cut-for-glass.

DESIGN SOLUTIONS

- ▶ Apply an End Panel Skin to create a flush end on the side of a Wall cabinet if installed at the end of a run for ease of Moulding installation.
- ▶ For complementary Wall Prepped for Glass cabinets in Teagan, order as Winstead Maple, as Teagan features a slab door design.

Wall Cabinets with Doors Prepped for Glass, 42" High, 15" Deep

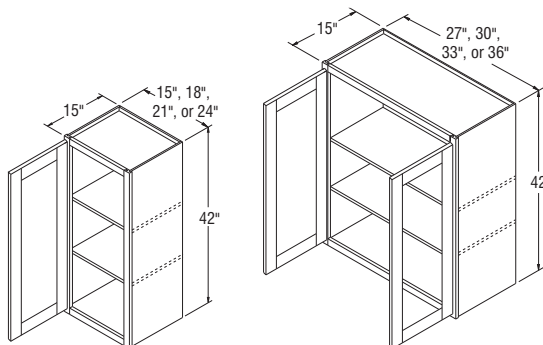

WPG154215*
WPG184215*
WPG214215*
WPG244215*

WPG274215B
WPG304215B
WPG334215B
WPG364215B

*Specify L or R on all single door Arch styles.

NOTES ✓

- ▶ Cabinets include matching Aristex™ interior and clips to install glass (glass not included).
- ▶ Wall Prepped for Glass cabinets are not available in Augusta or Teagan.
- ▶ Doors Only for WPG cabinets can be ordered to meet the need for Doors Cut-for-glass.

DESIGN SOLUTIONS

- ▶ Apply an End Panel Skin to create a flush end on the side of a Wall cabinet if installed at the end of a run for ease of Moulding installation.
- ▶ For complementary Wall Prepped for Glass cabinets in Teagan, order as Winstead Maple, as Teagan features a slab door design.

Refrigerator Wall Cabinets, 12" High, 23 3/4" Deep

NOTES ✓

- ▶ Shelves not available.
- ▶ Cabinets must be supported on three surfaces when mounted.
- ▶ Center door on RW4812 will be hinged on the left.
- ▶ When designing for built-in refrigerators, be sure to use necessary Fillers to provide proper clearance.

DESIGN SOLUTIONS

- ▶ Apply an End Panel Skin to create a flush end on the side of a Wall cabinet if installed at the end of a run for ease of Moulding installation.

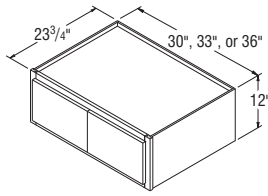

RW3012B
RW3312B
RW3612B

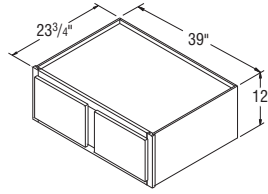

RW3912

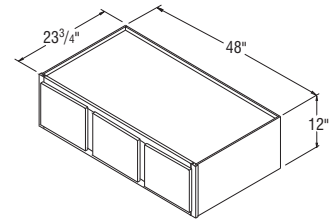

RW4812

Refrigerator Wall Cabinets, 14" High, 23 3/4" Deep

NOTES ✓

- ▶ Shelves not available.
- ▶ Cabinets must be supported on three surfaces when mounted.
- ▶ When designing for built-in refrigerators, be sure to use necessary Fillers to provide proper clearance.

DESIGN SOLUTIONS

- ▶ Apply an End Panel Skin to create a flush end on the side of a Wall cabinet if installed at the end of a run for ease of Moulding installation.

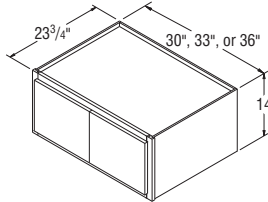

RW3014B
RW3314B
RW3614B

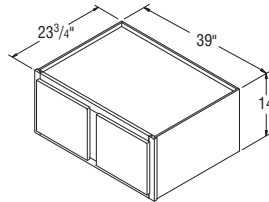

RW3914

Refrigerator Wall Cabinets, 18" High, 23 3/4" Deep

NOTES ✓

- ▶ Shelves not available.
- ▶ Cabinets must be supported on three surfaces when mounted.
- ▶ When designing for built-in refrigerators, be sure to use necessary Fillers to provide proper clearance.

DESIGN SOLUTIONS

- ▶ Apply an End Panel Skin to create a flush end on the side of a Wall cabinet if installed at the end of a run for ease of Moulding installation.

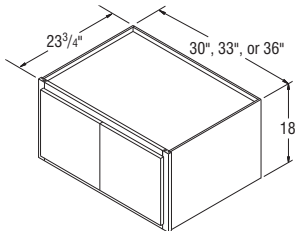

RW3018B
RW3318B
RW3618B

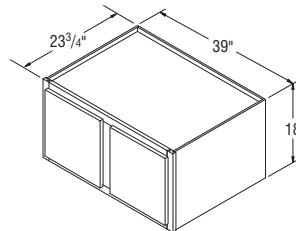

RW3918

Refrigerator Wall Cabinets, 21" High, 23 3/4" Deep

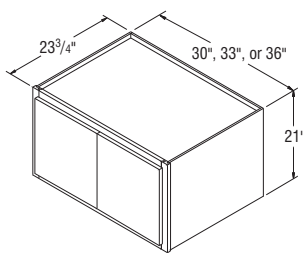

RW3021B
RW3321B
RW3621B

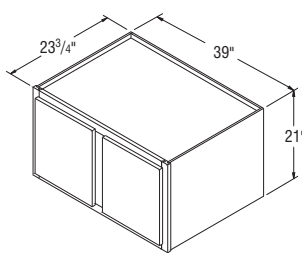

RW3921

NOTES ✓

- ▶ Shelves not available.
- ▶ Cabinets must be supported on three surfaces when mounted.
- ▶ When designing for built-in refrigerators, be sure to use necessary Fillers to provide proper clearance.

DESIGN SOLUTIONS

- ▶ Apply an End Panel Skin to create a flush end on the side of a Wall cabinet if installed at the end of a run for ease of Moulding installation.

Refrigerator Wall Cabinets, 24" High, 23 3/4" Deep

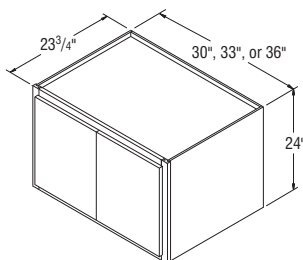

RW3024B
RW3324B
RW3624B

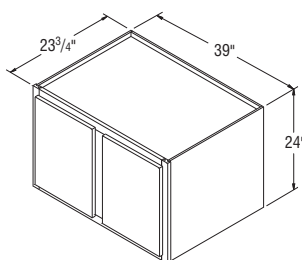

RW3924

NOTES ✓

- ▶ Shelves not available.
- ▶ Cabinets must be supported on three surfaces when mounted.
- ▶ When designing for built-in refrigerators, be sure to use necessary Fillers to provide proper clearance.

DESIGN SOLUTIONS

- ▶ Apply an End Panel Skin to create a flush end on the side of a Wall cabinet if installed at the end of a run for ease of Moulding installation.

NOTES ✓

- ▶ Matching Aristex™ interior.
- ▶ Can be installed horizontally or vertically.
- ▶ When installed vertically, wine rack can't be used as the end cabinet because the ends are recessed. Frame rail configuration will be unique from adjacent cabinets when installed vertically.
- ▶ WR3018 holds 11 bottles.
- ▶ WR3614 holds 13 bottles.
- ▶ Wine bottles may extend beyond face frame. Not recommended for high traffic areas.
- ▶ Wine Rack Cabinets do not feature finished face frames because they are not intended to be installed as stand-alone units.

DESIGN SOLUTIONS

- ▶ Apply an End Panel Skin to create a flush end on the side of a Wall cabinet if installed at the end of a run for ease of Moulding installation.



Wine Rack Cabinets, 12" Deep

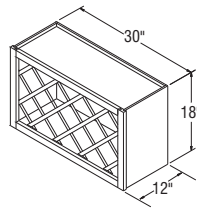

WR3018

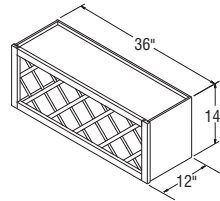

WR3614

NOTES ✓

- ▶ Drawer guides are side-mount Full extension.
- ▶ Dovetail drawer not available.
- ▶ Outside edge profile will match door.
- ▶ In countertop applications, backsplash must be cut out for flush installation against a wall.

DESIGN SOLUTIONS

- ▶ Apply an End Panel Skin to create a flush end on the side of a Wall cabinet if installed at the end of a run for ease of Moulding installation.



Wall Drawer Unit, 17 1/2" High, 18" Wide, 12" Deep

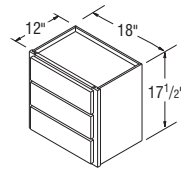

WD1817.5

Wall Message Center Cabinets, 12" Wide, 3" Deep

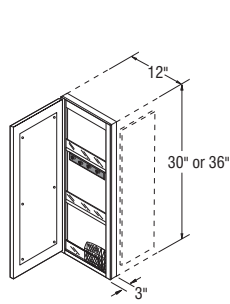

WMC1230*
WMC1236*

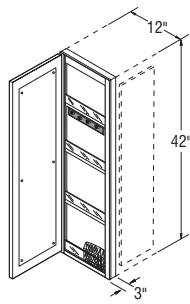

WMC1242*

*Must specify L or R on WMC cabinets.

NOTES ✓

- ▶ Cabinets include magnetic white board on back of door, key hooks, pencil holder, and fixed plexiglass-fronted $\frac{3}{4}$ " thick shelves.
- ▶ For proper installation, adjacent cabinet must have $\frac{1}{4}$ " panel applied, not included with WMC.
- ▶ Two cut to size veneered skins are included to achieve a flush fit when desired. Opaques will receive MDF skins.



Microwave Wall Cabinets, 36" High, 30" Wide, 12" Deep

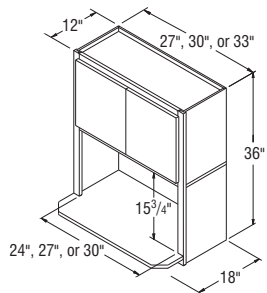

MWC2736B
MWC3036B
MWC3336B

NOTES ✓

- ▶ One fixed shelf for microwave and one fixed shelf for upper section.
- ▶ Bottom shelf ships loose, includes standard shelf clips.
- ▶ Matching Aristex™ interior throughout cabinet.
- ▶ Two doors.
- ▶ Cannot be installed next to Diagonal Wall cabinets.
- ▶ When using with 30" Wall cabinets, the MWC3036 will hang 6" below the Wall cabinet line.
- ▶ Designed for free-standing microwaves.

Microwave Wall Cabinets, 48" High, 30" Wide, 12" Deep

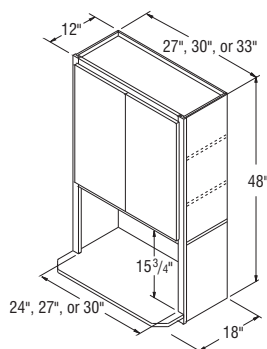

MWC3048B
MWC3048B
MWC3348B

NOTES ✓

- ▶ Two adjustable $\frac{3}{4}$ " shelves, one fixed shelf for microwave (bottom shelf ships loose, includes standard shelf clips), and one fixed shelf for upper section.
- ▶ Matching Aristex™ interior throughout cabinet.
- ▶ Two doors.
- ▶ Cannot be installed next to Diagonal Wall cabinets.
- ▶ When using with 42" Wall cabinets, the MWC3048 will hang 6" below the Wall cabinet line.
- ▶ Designed for free-standing microwaves.



NOTES ✓

- ▶ Matching Aristex™ interior throughout cabinet.
- ▶ Microwave opening is trimmable.
- ▶ Minimum opening – 27" W x 16½" H. Maximum opening – 27" W x 20½" H.
- ▶ Designed for built-in microwaves with trim kits.



Wall Built-in Microwave Cabinets, 36" High, 30" Wide, 21" Deep

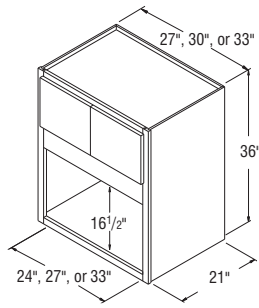

- MWC273621B**
- MWC303621B**
- MWC333621B**

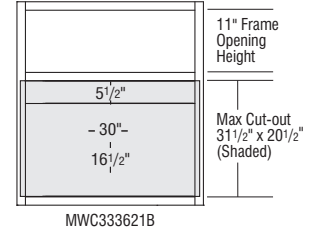
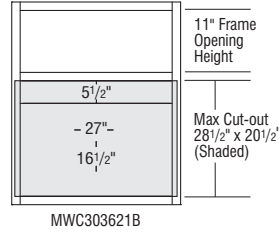
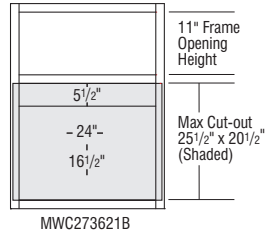

NOTES ✓

- ▶ Matching Aristex™ interior throughout cabinet.
- ▶ Microwave opening is trimmable.
- ▶ Minimum opening – 27" W x 16½" H. Maximum opening – 27" W x 20½" H.
- ▶ Designed for built-in microwaves with trim kits.



Wall Built-in Microwave Cabinets, 42" High, 30" Wide, 21" Deep

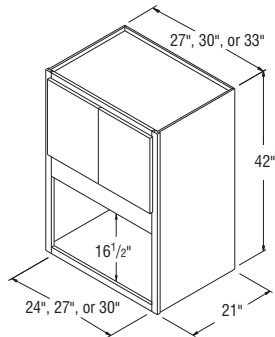

- MWC274221B**
- MWC304221B**
- MWC334221B**

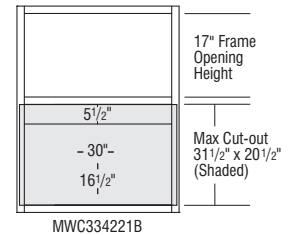
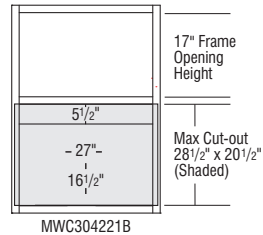
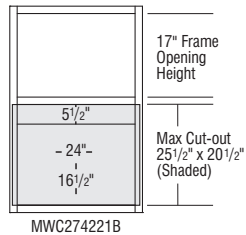

Microwave Wall Open Shelf, 12" Deep

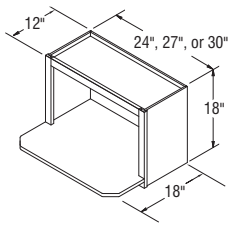

MWOL2418
MWOL2718
MWOL3018

NOTES ✓

- ▶ Shelf is 18" deep.
- ▶ Matching Aristex™ interior.



Wine Storage Cabinets

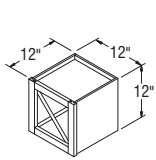

W121212

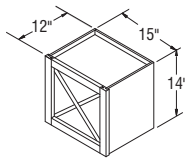

WSC151412

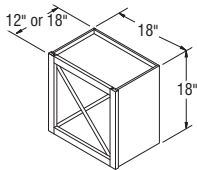

WSC181812
WSC181818

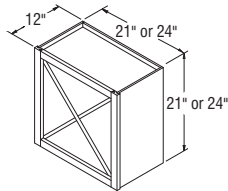

WSC212112
WSC242412

SKU	# of Bottles
WSC121212	4
WSC151412	8
WSC181812	18
WSC181818	18
WSC212112	24
WSC242412	32

NOTES ✓

- ▶ Must be installed between two cabinets, between cabinet and wall, or mounted to a horizontal surface.
- ▶ X configuration cannot be removed.
- ▶ Capacity will vary depending on wine bottle size.



Wine Cubes, 12" Deep

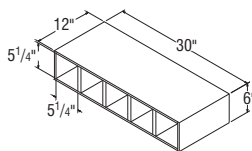

(5 openings)

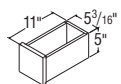

(includes 5 drawers)

WCUBE30
WCUBEDRW5

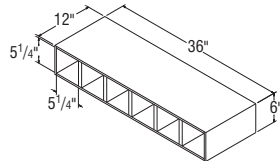

(6 openings)

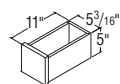

(includes 6 drawers)

WCUBE36
WCUBEDRW6

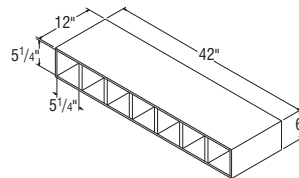

(7 openings)

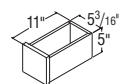

(includes 7 drawers)

WCUBE42
WCUBEDRW7

NOTES ✓

- ▶ Matching veneered finish interior.
- ▶ WCUBE may be positioned horizontally or vertically.
- ▶ WCUBEDRW features four-sided drawer boxes, no slides required. Does not include decorative hardware on any style.



NOTES ✓

- ▶ Matching veneered finish interior.



What-Not Shelves, 30" , 36" , and 42" High, 12" Wide, 5" Deep

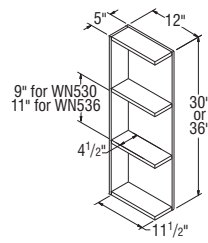

**WN530
WN536**

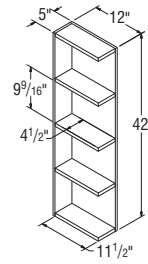

WN542

NOTES ✓

- ▶ Only available in Cherry, Maple and Oak species.
- ▶ Paint finishes available; PureStyle™ not available.
- ▶ Includes wood mounting plate with metal brackets. Once installed, mounting system is fully concealed.
- ▶ 3/4" thick solid-wood front and sides. 3/8" veneered furniture board top and bottom. Front and ends are mitered together.
- ▶ No modifications are available for this product.



Floating Shelves

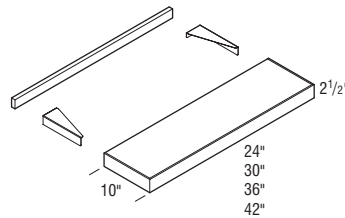

**FS24
FS30
FS36
FS42**

Weight Capacity per Shelf	
FS24	25 lbs.
FS30	31.5 lbs.
FS36	37.5 lbs.
FS42	43.75 lbs.

Canopy Wood Hoods, Arch, 30" and 36" Wide, 24" High

NOTES ✓

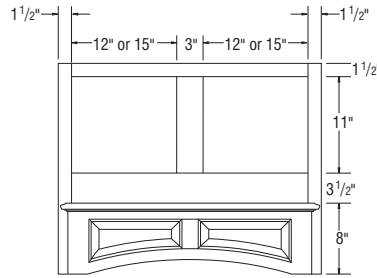
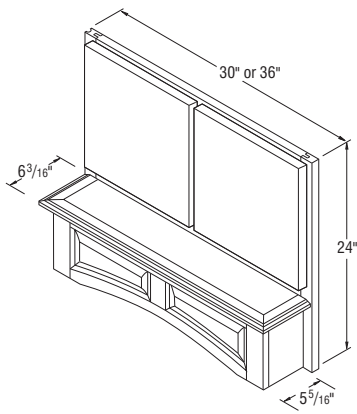

WHCA30
WHCA36

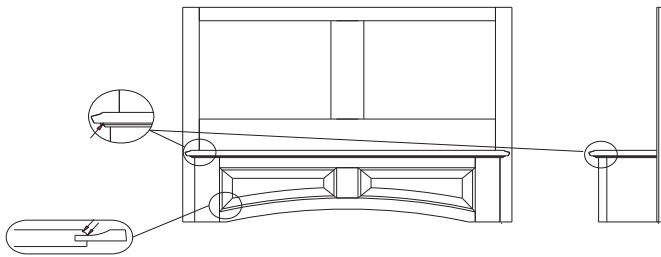

- ▶ Butt door styles will utilize butt door sizes, frame will always have a 3" center mullion.
- ▶ Install Wood Hoods between adjoining 12" deep cabinets (15" deep cabinets are not recommended).
- ▶ Doors matching the style ordered will be installed on hood.
- ▶ Durham and Overton Toasted Antique doors will have a glazed appearance, but rest of wood hood unit will be painted Antique.
- ▶ Wood Hoods ordered in Rustic Birch will not feature Rustic characteristics.
- ▶ Exhaust system not included. Compatible with TWHBLOWER390, TWHBLOWER500, and TWHCONVKIT.
- ▶ Check your local building code for installation heights above the range.
- ▶ Silver metallic liner included. Liner opening size: 10³/₄" deep by 19¹/₂" wide. Assembly required.
- ▶ Installation instructions and hardware included.
- ▶ Glazed edges indicated by arrows on drawings.

Tapered Wood Hoods, 30" and 36" Wide, 24" and 30" High

NOTES ✓

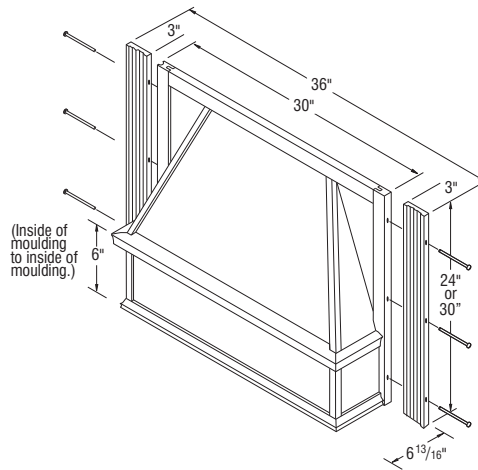
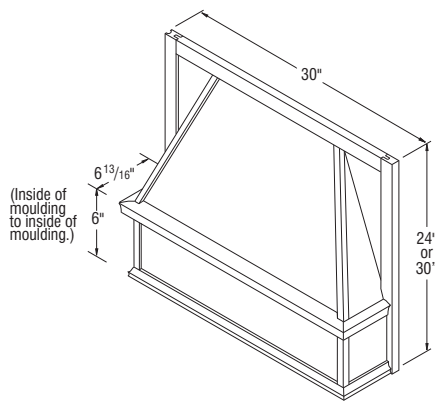

TWH30
TWH3030

TWH36
TWH3630

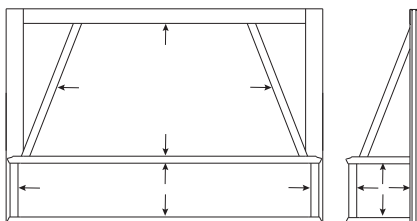

- ▶ Silver metallic liner included. Liner opening size: 10³/₄" deep by 19¹/₂" wide. Assembly required.
- ▶ Install Wood Hoods between adjoining 12" deep cabinets (15" deep cabinets are not recommended).
- ▶ When Antique is used for Durham and Overton, wood hood unit will not feature a glazed appearance. Toasted Antique not available.
- ▶ For Birch and Rustic Birch styles, order Maple. For Thermofoil and PureStyle™, order Maple paint.
- ▶ Check your local building code for installation heights above the range.
- ▶ TWH36 has two plain/fluted stiles with metal wings included to extend Hood to 36" width.
- ▶ Exhaust system not included. Compatible with TWHBLOWER390, TWHBLOWER500, and TWHCONVKIT.
- ▶ Glazed edges indicated by arrows on drawings.

Wood Hood Chimney, 30" and 36" Wide

NOTES ✓

- ▶ 3/4" thick plywood.
- ▶ Trimmable.
- ▶ Purchased with corresponding WHS.
- ▶ When Antique is used for Durham and Overton, wood hood unit will not feature a glazed appearance. Toasted Antique is not available.
- ▶ For Birch and Rustic Birch styles, order Maple. For Thermofoil and PureStyle™, order Maple paint.

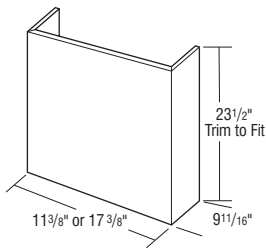

WHC30
WHC36

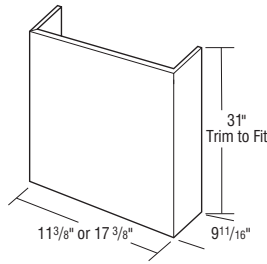

WHCT30
WHCT36

NOTES ✓

- ▶ Freestanding unit (must be properly secured to wall and cannot be attached to adjacent cabinets).
- ▶ Chimney available (WHC..).
- ▶ Check your local building code for installation heights above the range.
- ▶ Powder coated silver metallic metal liner included.
- ▶ Installation instructions and hardware included.
- ▶ Exhaust system not included. Compatible with TWHBLOWER390, TWHBLOWER500, and TWHCONVKIT.
- ▶ When Antique is used for Durham and Overton, wood hood unit will not feature a glazed appearance. Toasted Antique is not available.
- ▶ For Birch and Rustic Birch styles, order Maple. For Thermofoil and PureStyle™, order Maple paint.
- ▶ Glazed edges indicated by arrows on drawings.

Wood Hood Square, 30" and 36" Wide

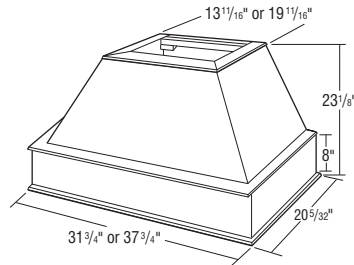

WHS30
WH36

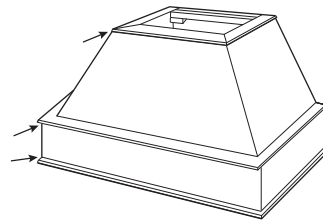

	Minimum Width Required
WHS30	33"
WHS36	39"

Wood Hood Shiplap, 30" and 36" Wide

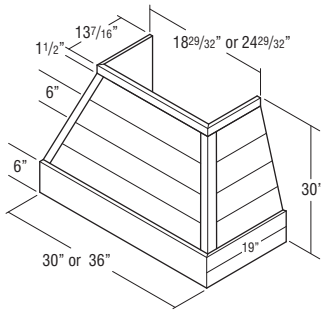

WHSL30
WHSL36

NOTES ✓

- ▶ Only available in Maple.
- ▶ When Antique is used for Durham and Overton, wood hood unit will not feature a glazed appearance. Toasted Antique not available.
- ▶ Powder coated silver metallic metal liner included.
- ▶ Check your local building code for installation heights above the range.
- ▶ Exhaust system not included. Compatible with TWHBLOWER390, TWHBLOWER500, and TWHCONVKIT.
- ▶ Freestanding unit (must be properly secured to wall and cannot be attached to adjacent cabinets).

Wood Hood Chimney Shiplap, 30" and 36" Wide

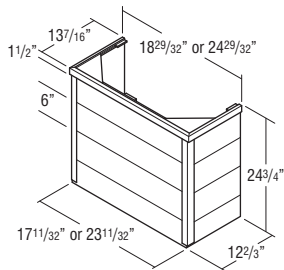

WHCSL30
WHCSL36

NOTES ✓

- ▶ Only available in Maple.
- ▶ Trimmable.
- ▶ When Antique is used for Durham and Overton, wood hood unit will not feature a glazed appearance. Toasted Antique is not available.
- ▶ Check your local building code for installation heights above the range.
- ▶ Purchase with corresponding WHSL.

Wood Hood Blower

NOTES ✓

- ▶ Compatible with WHCA and TWH Wood Hoods.
- ▶ 6" diameter vent.
- ▶ Silver metallic finish.
- ▶ One year warranty.
- ▶ Two 20-watt candelabra lights, (not included), and three fan setting levels.
- ▶ CFM Rating -
 TWHBLOWER390: 390 CFM (cubic feet per minute); 6 sones or 53.83 decibels
 TWHBLOWER500: 500 CFM (cubic feet per minute); 8.2 sones or 57.98 decibels
- ▶ Order under style #010. Manufacturer recommends 24" - 30" clearance between cooking surface and blower unit.
- ▶ Includes a dishwasher-safe aluminum filter for use with external ducting. Does not include charcoal filter for internal ducting with conversion kit (see FILTER390 or FILTER500).

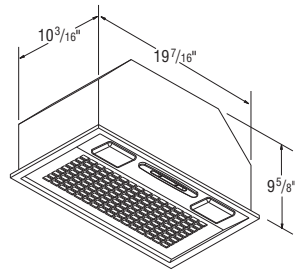

TWHBLOWER390

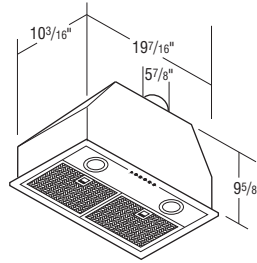

TWHBLOWER500



NOTES ✓

- ▶ Kit allows TWHBLOWER390 and TWHBLOWER500 to be vented internally.
- ▶ Order under style #010.
- ▶ Kit includes: One 21" x 7" round pipe, 1 adjustable collar, 1 white metal soffit grille, 1 adjustable boot, a 7" to 6" reducer, and FILTER390 (for TWHBLOWER390) or FILTER500 (for TWHBLOWER500).
- ▶ FILTER390 and FILTER500 also available to order separately for replacements.

Wood Hood Conversion Kit

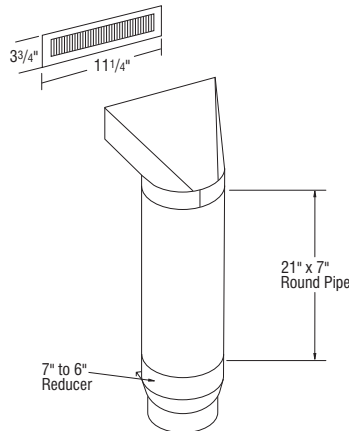

TWHCONVKIT



FILTER390
FILTER500

NOTES ✓

- ▶ Replacement charcoal filter for use when wood hood blower is ducted internally with the wood hood conversion kit (TWHCONVKIT).
- ▶ FILTER390 for use with TWHBLOWER390.
- ▶ FILTER500 for use with TWHBLOWER500.



Diagonal Corner Wall Cabinets, 14" High, 12" & 15" Deep

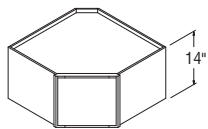

DC2414
DC2714

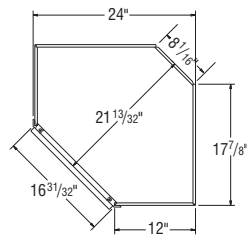

DC2414
TOP VIEW

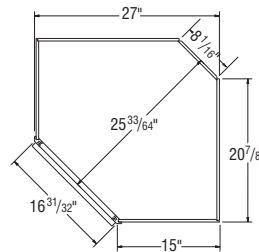

DC2714
TOP VIEW

NOTES ✓

- ▶ Shelves not available.
- ▶ All Diagonal Wall cabinets are reversible except for Arch styles.
- ▶ When installing, DC cabinets must be attached to at least one run of cabinets and both back walls.
- ▶ All full overlay doors are smaller to allow for proper door opening.

DESIGN SOLUTIONS

- ▶ Apply an End Panel Skin to create a flush end on the side of a Wall cabinet if installed at the end of a run for ease of Moulding installation.

Diagonal Corner Wall Cabinets, 18" High, 12" & 15" Deep

NOTES ✓

- ▶ Shelves not available.
- ▶ All Diagonal Wall cabinets are reversible except for Arch styles.
- ▶ When installing, DC cabinets must be attached to at least one run of cabinets and both back walls.
- ▶ All full overlay doors are smaller to allow for proper door opening.

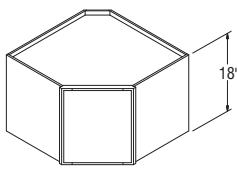

DC2418
DC2718

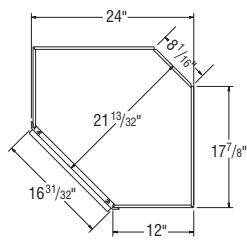

DC2418
TOP VIEW

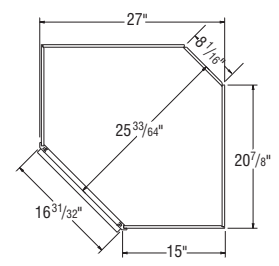

DC2718
TOP VIEW

DESIGN SOLUTIONS

- ▶ Apply an End Panel Skin to create a flush end on the side of a Wall cabinet if installed at the end of a run for ease of Moulding installation.

Diagonal Corner Wall Cabinets, 24" High, 12" & 15" Deep

NOTES ✓

- ▶ One adjustable shelf.
- ▶ Adjustable shelf cannot be removed/retrofitted.
- ▶ All Diagonal Wall cabinets are reversible except for Arch styles.
- ▶ When installing, DC cabinets must be attached to at least one run of cabinets and both back walls.
- ▶ All full overlay doors are smaller to allow for proper door opening.

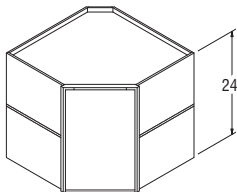

DC2424
DC2724

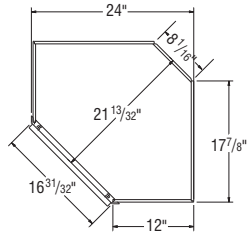

DC2424
TOP VIEW

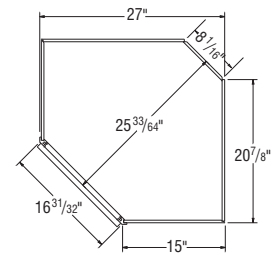

DC2724
TOP VIEW

DESIGN SOLUTIONS

- ▶ Apply an End Panel Skin to create a flush end on the side of a Wall cabinet if installed at the end of a run for ease of Moulding installation.

Diagonal Corner Wall Cabinets, 30" High, 12" & 15" Deep

NOTES ✓

- ▶ Two adjustable shelves.
- ▶ All Diagonal Wall cabinets are reversible except for Arch styles.
- ▶ When installing, DC cabinets must be attached to at least one run of cabinets and both back walls.
- ▶ All full overlay doors are smaller to allow for proper door opening.

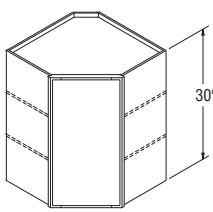

DC2430*
DC2730*

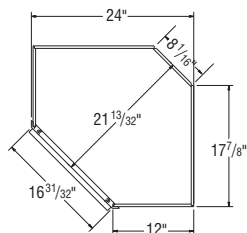

DC2430
TOP VIEW

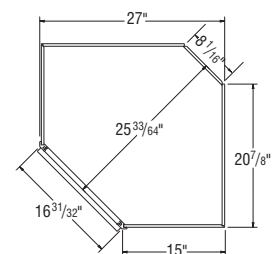

DC2730
TOP VIEW

DESIGN SOLUTIONS

- ▶ Apply an End Panel Skin to create a flush end on the side of a Wall cabinet if installed at the end of a run for ease of Moulding installation.

*Specify L or R on Arch styles.

Diagonal Corner Wall Cabinets, 36" High, 12" & 15" Deep

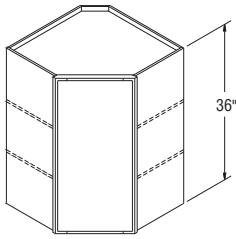

DC2436*
DC2736*

*Specify L or R on Arch styles.

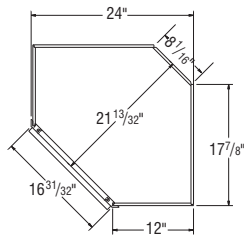

DC2436
TOP VIEW

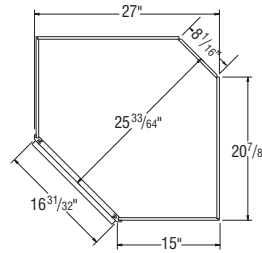

DC2736
TOP VIEW

NOTES ✓

- ▶ Two adjustable shelves.
- ▶ All Diagonal Wall cabinets are reversible except for Arch styles.
- ▶ When installing, DC cabinets must be attached to at least one run of cabinets and both back walls.
- ▶ All full overlay doors are smaller to allow for proper door opening.

DESIGN SOLUTIONS

- ▶ Apply an End Panel Skin to create a flush end on the side of a Wall cabinet if installed at the end of a run for ease of Moulding installation.

Diagonal Corner Wall Cabinets, 42" High, 12" & 15" Deep

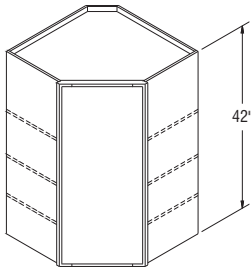

DC2442*
DC2742*

*Specify L or R on Arch styles.

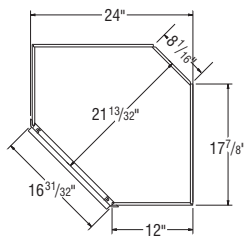

DC2442
TOP VIEW

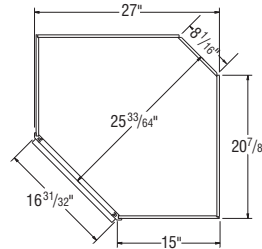

DC2742
TOP VIEW

NOTES ✓

- ▶ Three adjustable shelves.
- ▶ All Diagonal Wall cabinets are reversible except for Arch styles.
- ▶ When installing, DC cabinets must be attached to at least one run of cabinets and both back walls.
- ▶ All full overlay doors are smaller to allow for proper door opening.
- ▶ When varying heights, make sure to also vary depths to allow moulding to lie against adjacent side of cabinet.

DESIGN SOLUTIONS

- ▶ Apply an End Panel Skin to create a flush end on the side of a Wall cabinet if installed at the end of a run for ease of Moulding installation.

Diagonal Corner Open Wall Cabinets, 14" High, 12" & 15" Deep

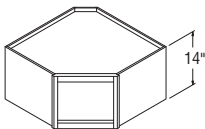

DCOL2414
DCOL2714

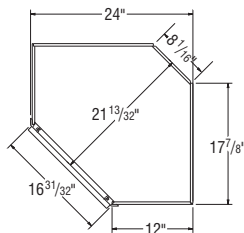

DCOL2414
TOP VIEW

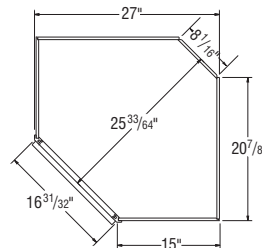

DCOL2714
TOP VIEW

NOTES ✓

- ▶ Shelves not available.
- ▶ Cabinets include matching Aristex™ interior.
- ▶ When installing, DCOL cabinets must be attached to at least one run of cabinets and both back walls.

DESIGN SOLUTIONS

- ▶ Apply an End Panel Skin to create a flush end on the side of a Wall cabinet if installed at the end of a run for ease of Moulding installation.

Diagonal Corner Open Wall Cabinets, 18" High, 12" & 15" Deep

NOTES ✓

- ▶ Shelves not available.
- ▶ Cabinets include matching Aristex™ interior.
- ▶ When installing, DCOL cabinets must be attached to at least one run of cabinets and both back walls.

DESIGN SOLUTIONS

- ▶ Apply an End Panel Skin to create a flush end on the side of a Wall cabinet if installed at the end of a run for ease of Moulding installation.

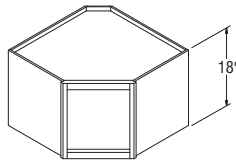

DCOL2418
DCOL2718

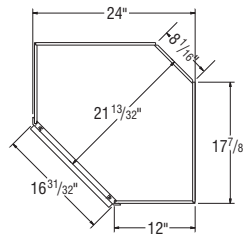

DCOL2418
TOP VIEW

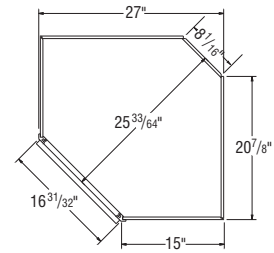

DCOL2718
TOP VIEW

NOTES ✓

- ▶ One adjustable 3/4" thick matching Aristex™ shelf.
- ▶ Shelf is plywood in all construction platforms.
- ▶ Cabinets include matching Aristex™ interior.
- ▶ When installing, DCOL cabinets must be attached to at least one run of cabinets and both back walls.

DESIGN SOLUTIONS

- ▶ Apply an End Panel Skin to create a flush end on the side of a Wall cabinet if installed at the end of a run for ease of Moulding installation.

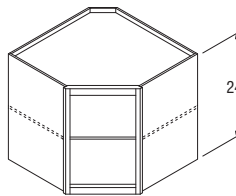

DCOL2424
DCOL2724

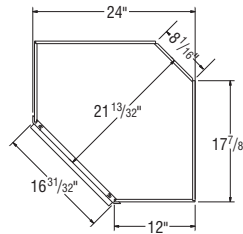

DCOL2424
TOP VIEW

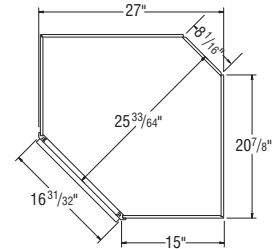

DCOL2724
TOP VIEW

NOTES ✓

- ▶ Two adjustable 3/4" thick matching Aristex™ shelves.
- ▶ Shelves are plywood in all construction platforms.
- ▶ Cabinets include matching Aristex™ interior.
- ▶ If a door is desired for a 7/16" partial overlay style, use a W1830 size door.
- ▶ Full overlay door styles cannot be added.
- ▶ When installing, DCOL cabinets must be attached to at least one run of cabinets and both back walls.

DESIGN SOLUTIONS

- ▶ Apply an End Panel Skin to create a flush end on the side of a Wall cabinet if installed at the end of a run for ease of Moulding installation.

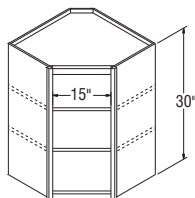

DCOL2430
DCOL2730

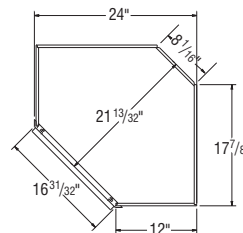

DCOL2430
TOP VIEW

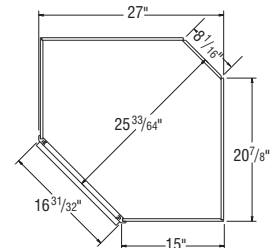

DCOL2730
TOP VIEW

Diagonal Corner Open Wall Cabinets, 30" High, 12" & 15" Deep

Diagonal Corner Open Wall Cabinets, 36" High, 12" & 15" Deep

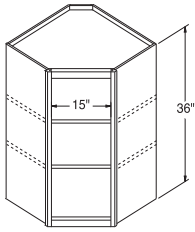

DCOL2436
DCOL2736

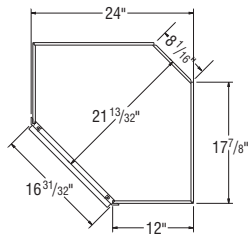

DCOL2436
TOP VIEW

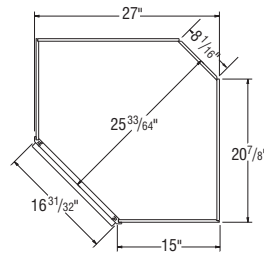

DCOL2736
TOP VIEW

NOTES ✓

- ▶ Two adjustable 3/4" thick matching Aristex™ shelves.
- ▶ Shelves are plywood in all construction platforms.
- ▶ Cabinets include matching Aristex™ interior.
- ▶ If a door is desired for a 7/16" partial overlay style, use a W1836 size door.
- ▶ Full overlay door styles cannot be added.
- ▶ When installing, DCOL cabinets must be attached to at least one run of cabinets and both back walls.

DESIGN SOLUTIONS

- ▶ Apply an End Panel Skin to create a flush end on the side of a Wall cabinet if installed at the end of a run for ease of Moulding installation.

Diagonal Corner Open Wall Cabinets, 42" High, 12" & 15" Deep

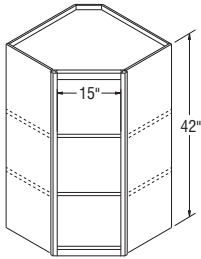

DCOL2442
DCOL2742

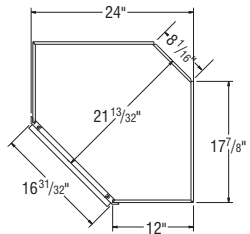

DCOL2442 TOP VIEW

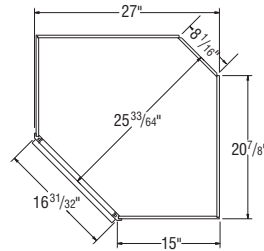

DCOL2742 TOP VIEW

NOTES ✓

- ▶ Two adjustable 3/4" thick matching Aristex™ shelves.
- ▶ Shelves are plywood in all construction platforms.
- ▶ Cabinets include matching Aristex™ interior.
- ▶ If a door is desired for a 7/16" partial overlay style, use a W1842 size door.
- ▶ Full overlay door styles cannot be added.
- ▶ When installing, DCOL cabinets must be attached to at least one run of cabinets and both back walls.

DESIGN SOLUTIONS

- ▶ Apply an End Panel Skin to create a flush end on the side of a Wall cabinet if installed at the end of a run for ease of Moulding installation.

Diagonal Corner Wall Cabinets with Mullion Door, 18" High, 12" & 15" Deep

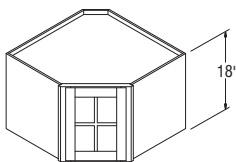

DCMD2418
DCMD2718

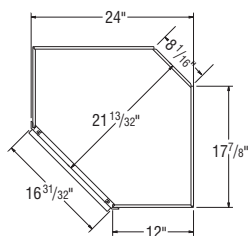

DCMD2418
TOP VIEW

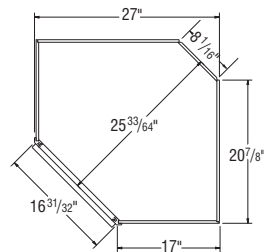

DCMD2718
TOP VIEW

NOTES ✓

- ▶ Shelves not available.
- ▶ Cabinets include installed, clear tempered glass, and matching Aristex™ interior.
- ▶ When installing, DCMD cabinets must be attached to at least one run of cabinets and both back walls.
- ▶ See page 28 for Standard and Shaker mullion door style availability and grid configurations.
- ▶ Mullion Door cabinets are not available in Teagan.

DESIGN SOLUTIONS

- ▶ Apply an End Panel Skin to create a flush end on the side of a Wall cabinet if installed at the end of a run for ease of Moulding installation.

NOTES ✓

- ▶ One adjustable 3/4" thick matching Aristex™ shelf that aligns with door mullions on Standard mullions, but do not align on Shaker mullions.
- ▶ Shelf is plywood in all construction platforms.
- ▶ Cabinets include installed, clear tempered glass, and matching Aristex™ interior.
- ▶ When installing, DCMD cabinets must be attached to at least one run of cabinets and both back walls.
- ▶ See page 28 for Standard and Shaker mullion door style availability and grid configurations.
- ▶ Mullion Door cabinets are not available in Teagan.

DESIGN SOLUTIONS

- ▶ Apply an End Panel Skin to create a flush end on the side of a Wall cabinet if installed at the end of a run for ease of Moulding installation.

Diagonal Corner Wall Cabinets with Mullion Door, 24" High, 12" & 15" Deep

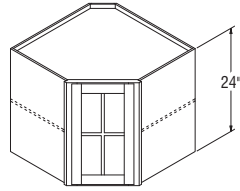

DCMD2424
DCMD2724

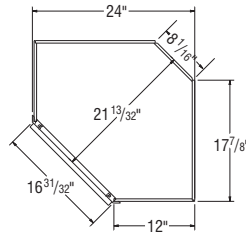

DCMD2424
TOP VIEW

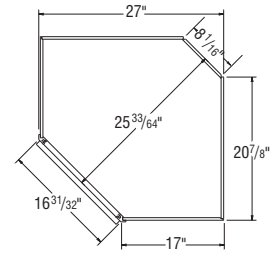

DCMD2424
TOP VIEW

NOTES ✓

- ▶ Two adjustable 3/4" thick matching Aristex™ shelves align with door mullions on Standard mullions, but do not align on Shaker mullions.
- ▶ Shelves are plywood in all construction platforms.
- ▶ Cabinets include installed, clear tempered glass, and matching Aristex™ interior.
- ▶ All Diagonal Wall cabinets are reversible except for Arch styles.
- ▶ When installing, DCMD cabinets must be attached to at least one run of cabinets and both back walls.
- ▶ All full overlay doors are smaller to allow for proper door opening.
- ▶ See page 28 for Standard and Shaker mullion door style availability and grid configurations.
- ▶ Mullion Door cabinets are not available in Teagan.

DESIGN SOLUTIONS

- ▶ Apply an End Panel Skin to create a flush end on the side of a Wall cabinet if installed at the end of a run for ease of Moulding installation.
- ▶ For complementary Wall Mullion Door cabinets in Teagan, order as Winstead Maple, as Teagan features a slab door design.

Diagonal Corner Wall Cabinets with Mullion Door, 30" High, 12" & 15" Deep

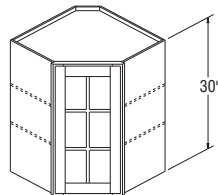

DCMD2430*
DCMD2730*

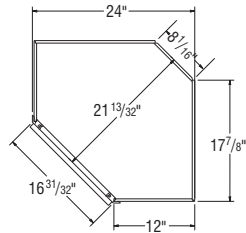

DCMD2430
TOP VIEW

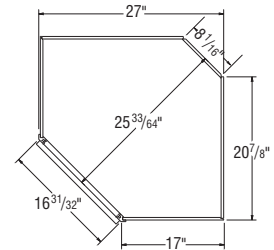

DCMD2730
TOP VIEW

*Specify L or R on Arch styles.

Diagonal Corner Wall Cabinets with Mullion Door, 36" High, 12" & 15" Deep

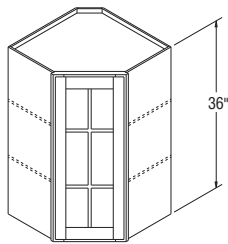

DCMD2436*
DCMD2736*

*Specify L or R on Arch styles.

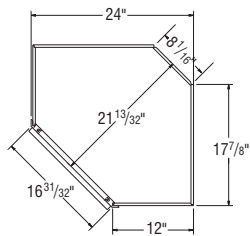

DCMD2436
TOP VIEW

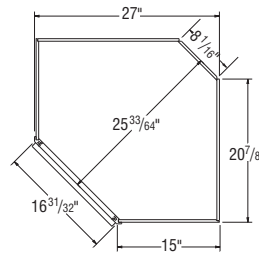

DCMD2736
TOP VIEW

NOTES

- ▶ Two adjustable $\frac{3}{4}$ " thick matching Aristex™ shelves align with door mullions on Standard mullions, but do not align on Shaker mullions.
- ▶ Shelves are plywood in all construction platforms.
- ▶ Cabinets include installed, clear tempered glass, and matching Aristex™ interior.
- ▶ All Diagonal Wall cabinets are reversible except for Arch styles.
- ▶ When installing, DCMD cabinets must be attached to at least one run of cabinets and both back walls.
- ▶ All full overlay doors are smaller to allow for proper door opening.
- ▶ See page 28 for Standard and Shaker mullion door style availability and grid configurations.
- ▶ Mullion Door cabinets are not available in Teagan.

DESIGN SOLUTIONS

- ▶ Apply an End Panel Skin to create a flush end on the side of a Wall cabinet if installed at the end of a run for ease of Moulding installation.
- ▶ For complementary Wall Mullion Door cabinets in Teagan, order as Winstead Maple, as Teagan features a slab door design.

Diagonal Corner Wall Cabinets with Mullion Door, 42" High, 12" & 15" Deep

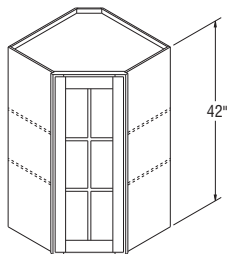

DCMD2442*
DCMD2742*

*Specify L or R on Arch styles.

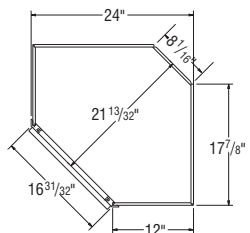

DCMD2442
TOP VIEW

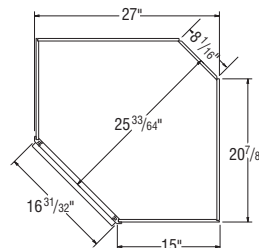

DCMD2742
TOP VIEW

NOTES

- ▶ Two adjustable $\frac{3}{4}$ " thick matching Aristex™ shelves align with door mullions on Standard mullions, but do not align on Shaker mullions.
- ▶ Shelves are plywood in all construction platforms.
- ▶ Cabinets include installed, clear tempered glass, and matching Aristex™ interior.
- ▶ All Diagonal Wall cabinets are reversible except for Arch styles.
- ▶ When installing, DCMD cabinets must be attached to at least one run of cabinets and both back walls.
- ▶ All full overlay doors are smaller to allow for proper door opening.
- ▶ See page 28 for Standard and Shaker mullion door style availability and grid configurations.
- ▶ Mullion Door cabinets are not available in Teagan.

DESIGN SOLUTIONS

- ▶ Apply an End Panel Skin to create a flush end on the side of a Wall cabinet if installed at the end of a run for ease of Moulding installation.
- ▶ For complementary Wall Mullion Door cabinets in Teagan, order as Winstead Maple, as Teagan features a slab door design.

Diagonal Corner Wall Cabinets w/Doors Prepped for Glass, 14" High, 12" & 15" Deep

NOTES ✓

- ▶ Shelves not available.
- ▶ Cabinets include matching Aristex™ interior and clips to install glass (glass not included).
- ▶ Diagonal Wall Cabinets are reversible except for Arch styles.
- ▶ When installing, DCPG cabinets must be attached to at least one run of cabinets and both back walls.
- ▶ All full overlay doors are smaller to allow for proper door opening.
- ▶ Wall Prepped for Glass cabinets are not available in Augusta or Teagan.

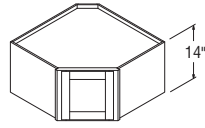

DCPG2414
DCPG2714

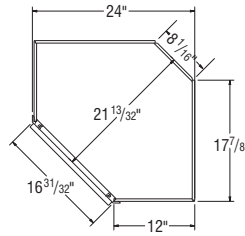

DCPG2414
TOP VIEW

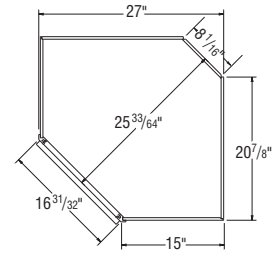

DCPG2714
TOP VIEW

DESIGN SOLUTIONS

- ▶ Apply an End Panel Skin to create a flush end on the side of a Wall cabinet if installed at the end of a run for ease of Moulding installation.
- ▶ For complementary Wall Prepped for Glass cabinets in Teagan, order as Winstead Maple, as Teagan features a slab door design.

NOTES ✓

Diagonal Corner Wall Cabinets w/Doors Prepped for Glass, 18" High, 12" & 15" Deep

- ▶ Shelves not available.
- ▶ Cabinets include matching Aristex™ interior and clips to install glass (glass not included).
- ▶ Diagonal Wall Cabinets are reversible except for Arch styles.
- ▶ All full overlay doors are smaller to allow for proper door opening.
- ▶ When installing, DCPG cabinets must be attached to at least one run of cabinets and both back walls.
- ▶ Wall Prepped for Glass cabinets are not available in Augusta or Teagan.

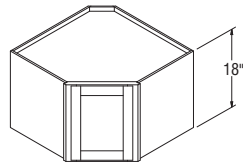

DCPG2418
DCPG2718

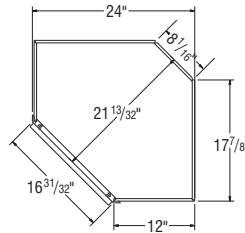

DCPG2418
TOP VIEW

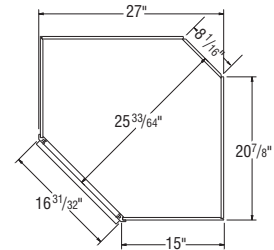

DCPG2718
TOP VIEW

DESIGN SOLUTIONS

- ▶ Apply an End Panel Skin to create a flush end on the side of a Wall cabinet if installed at the end of a run for ease of Moulding installation.
- ▶ For complementary Wall Prepped for Glass cabinets in Teagan, order as Winstead Maple, as Teagan features a slab door design.

Diagonal Corner Wall Cabinets w/Doors Prepped for Glass, 24" High, 12" & 15" Deep

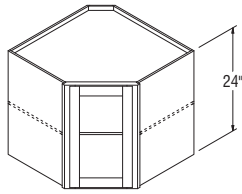

DCPG2424
DCPG2724

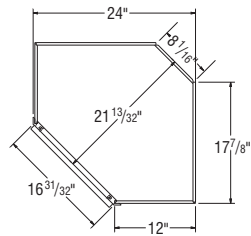

DCPG2424
TOP VIEW

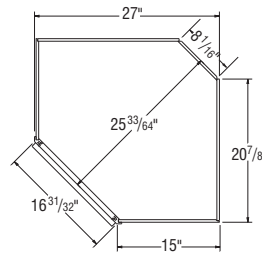

DCPG2724
TOP VIEW

NOTES

- ▶ Cabinets include matching Aristex™ interior and clips to install glass (glass not included).
- ▶ Shelf is plywood in all construction platforms.
- ▶ Diagonal Wall Cabinets are reversible except for Arch styles.
- ▶ All full overlay doors are smaller to allow for proper door opening.
- ▶ When installing, DCPG cabinets must be attached to at least one run of cabinets and both back walls.
- ▶ Wall Prepped for Glass cabinets are not available in Augusta or Teagan.

DESIGN SOLUTIONS

- ▶ Apply an End Panel Skin to create a flush end on the side of a Wall cabinet if installed at the end of a run for ease of Moulding installation.
- ▶ For complementary Wall Prepped for Glass cabinets in Teagan, order as Winstead Maple, as Teagan features a slab door design.

Diagonal Corner Wall Cabinets w/Doors Prepped for Glass, 30" High, 12" & 15" Deep

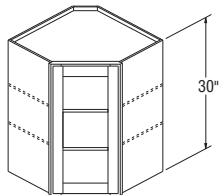

DCPG2430*
DCPG2730*

*Specify L or R on Arch styles.

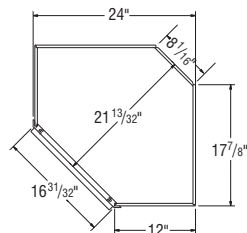

DCPG2430
TOP VIEW

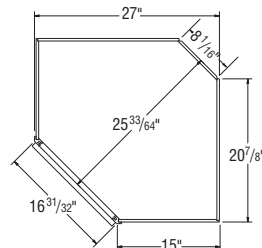

DCPG2730
TOP VIEW

NOTES

- ▶ Cabinets include matching Aristex™ interior and clips to install glass (glass not included).
- ▶ Shelves are plywood in all construction platforms.
- ▶ All Diagonal Wall cabinets are reversible except for Arch styles
- ▶ When installing, DCPG cabinets must be attached to at least one run of cabinets and both back walls.
- ▶ All full overlay doors are smaller to allow for proper door opening.
- ▶ Wall Prepped for Glass cabinets are not available in Augusta or Teagan.

DESIGN SOLUTIONS

- ▶ Apply an End Panel Skin to create a flush end on the side of a Wall cabinet if installed at the end of a run for ease of Moulding installation.
- ▶ For complementary Wall Prepped for Glass cabinets in Teagan, order as Winstead Maple, as Teagan features a slab door design.

NOTES ✓

- ▶ Cabinets include matching Aristex™ interior and clips to install glass (glass not included).
- ▶ Shelves are plywood in all construction platforms.
- ▶ All Diagonal Wall cabinets are reversible except for Arch styles.
- ▶ When installing, DCPG cabinets must be attached to at least one run of cabinets and both back walls.
- ▶ All full overlay doors are smaller to allow for proper door opening.
- ▶ Wall Prepped for Glass cabinets are not available in Augusta or Teagan.

DESIGN SOLUTIONS

- ▶ Apply an End Panel Skin to create a flush end on the side of a Wall cabinet if installed at the end of a run for ease of Moulding installation.
- ▶ For complementary Wall Prepped for Glass cabinets in Teagan, order as Winstead Maple, as Teagan features a slab door design.

Diagonal Corner Wall Cabinets w/Doors Prepped for Glass, 36" High, 12" & 15" Deep

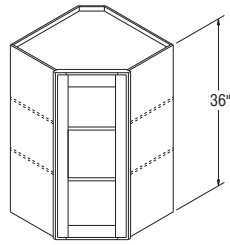

DCPG2436*
DCPG2736*

*Specify L or R on Arch styles.

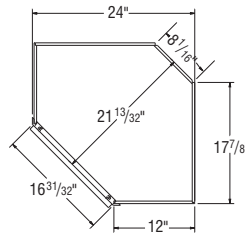

DCPG2436
TOP VIEW

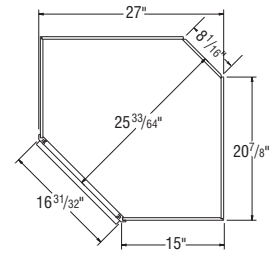

DCPG2736
TOP VIEW

NOTES ✓

- ▶ Cabinets include matching Aristex™ interior and clips to install glass (glass not included).
- ▶ Shelves are plywood in all construction platforms.
- ▶ All Diagonal Wall cabinets are reversible except for Arch styles.
- ▶ When installing, DCPG cabinets must be attached to at least one run of cabinets and both back walls.
- ▶ All full overlay doors are smaller to allow for proper door opening.
- ▶ Wall Prepped for Glass cabinets are not available in Augusta or Teagan.

DESIGN SOLUTIONS

- ▶ Apply an End Panel Skin to create a flush end on the side of a Wall cabinet if installed at the end of a run for ease of Moulding installation.
- ▶ For complementary Wall Prepped for Glass cabinets in Teagan, order as Winstead Maple, as Teagan features a slab door design.

Diagonal Corner Wall Cabinets w/Doors Prepped for Glass, 42" High, 12" & 15" Deep

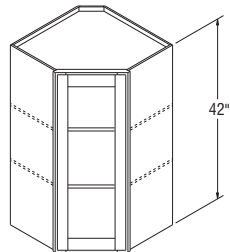

DCPG2442*
DCPG2742*

*Specify L or R on Arch styles.

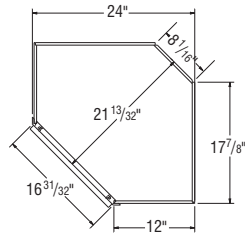

DCPG2442
TOP VIEW

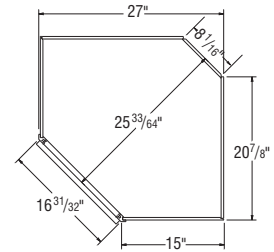

DCPG2742
TOP VIEW

Diagonal Corner Roto Wall Cabinet, 30" High, 12" Deep

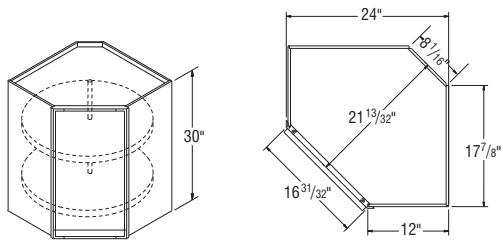

DCR2430*

TOP VIEW

*Specify L or R on Arch styles.

NOTES ✓

- ▶ Includes two white Roto shelves. Each shelf holds 30 lbs.
- ▶ 18" diameter shelves.
- ▶ Doors are reversible except for Arch styles.
- ▶ Cabinets must be attached to at least one run of cabinets and both back walls.

DESIGN SOLUTIONS

- ▶ Apply an End Panel Skin to create a flush end on the side of a Wall cabinet if installed at the end of a run for ease of Moulding installation.



Wall Easy Reach Cabinet, 30", 36", or 42" High, 12" Deep

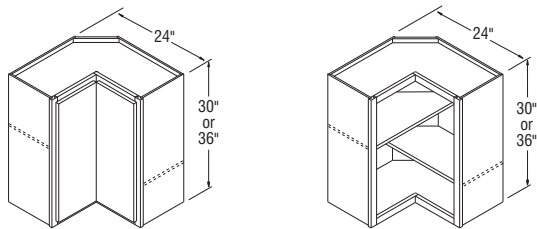

WER2430*
WER2436*

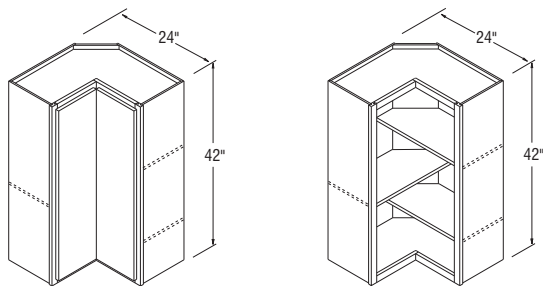

WER2442*

*Specify L or R on Arch styles.

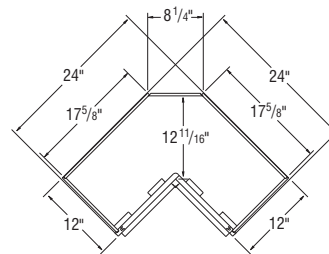

TOP VIEW

NOTES ✓

- ▶ WER2430 and WER2436 include two adjustable shelves.
- ▶ WER2442 includes three adjustable shelves.
- ▶ Doors are reversible except for Arch styles.
- ▶ One knuckle hinge door.
- ▶ Includes magnetic catch.
- ▶ Cabinets must be attached to at least one run of cabinets and both back walls.
- ▶ Soft Close Hinges are not available in Select and APC Construction.

DESIGN SOLUTIONS

- ▶ Apply an End Panel Skin to create a flush end on the side of a Wall cabinet if installed at the end of a run for ease of Moulding installation.



Wall Corner Cabinet Installation Charts

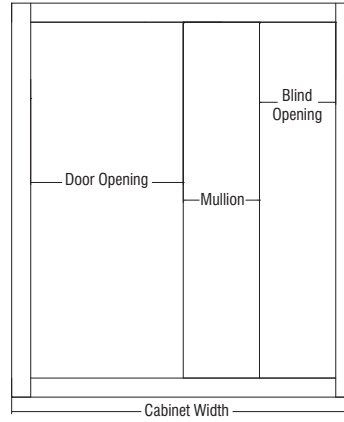
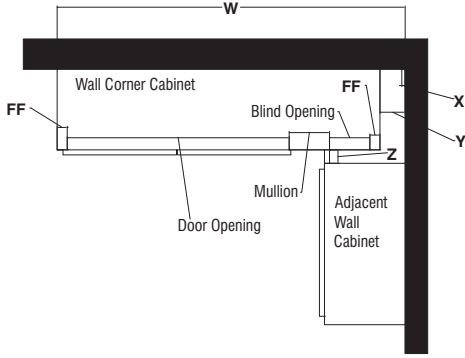

Full Overlay Square Corner Wall Cabinet Information

Full Overlay Styles	Actual Cabinet Width	X		Y	Z		W	
		Min. Pull	Min. Pull w/Hardware	Max. Pull	Min. Filler Required	Min. Filler Required w/Hardware	Min. Pull From Wall To End of Cabinet	Max Pull From Wall To End of Cabinet
SC24__	24"	1"	2½"	¾"	1"	2½"	25"	27¾"
SC30__	30"	1"	2½"	¾"	1"	2½"	31"	33¾"
SC33__	33"	1"	2½"	¾"	1"	2½"	34"	36¾"
SC36__	36"	1"	2½"	¾"	1"	2½"	37"	39¾"
SC42__	42"	1"	2½"	¾"	1"	2½"	43"	45¾"
SC48__	48"	1"	2½"	¾"	1"	2½"	49"	51¾"

7/16" Overlay Square Corner Wall Cabinet Information

7/16" Overlay Styles	Actual Cabinet Width	X		Y	Z		W	
		Min. Pull	Min. Pull w/Hardware	Max. Pull	Min. Filler Required	Min. Filler Required w/Hardware	Min. Pull From Wall To End of Cabinet	Max Pull From Wall To End of Cabinet
SC24__	24"	½"	2"	¾"	½"	2"	24½"	27¾"
SC30__	30"	½"	2"	¾"	½"	2"	30½"	33¾"
SC33__	33"	½"	2"	¾"	½"	2"	33½"	36¾"
SC36__	36"	½"	2"	¾"	½"	2"	36½"	39¾"
SC42__	42"	½"	2"	¾"	½"	2"	42½"	45¾"
SC48__	48"	½"	2"	¾"	½"	2"	48½"	51¾"

Square Corner Wall Door and Opening Sizes

SKU	7/16" Overlay Door	Full Overlay Door	Door Opening
SC2430	9⅞" x 27⅞"	11½" x 29½"	9" x 27"
SC3030	15⅞" x 27⅞"	17½" x 29½"	15" x 27"
SC3330	18⅞" x 27⅞"	20½" x 29½"	18" x 27"
SC3630	21⅞" x 27⅞"	23½" x 29½"	21" x 27"
SC4230B	13⅞" x 27⅞"	14⅞" x 29½"	27" x 27"
SC4830B	16⅞" x 27⅞"	17⅞" x 29½"	33" x 27"
SC2436	9⅞" x 33⅞"	11½" x 35½"	9" x 33"
SC3036	15" x 33"	17½" x 35½"	9" x 33"
SC3336	18⅞" x 33⅞"	20½" x 35½"	15" x 33"
SC3636	21" x 33"	23½" x 35½"	18" x 33"
SC4236B	13⅞" x 33⅞"	14⅞" x 35½"	27" x 33"
SC4836B	16⅞" x 33⅞"	17⅞" x 35½"	33" x 33"
SC2442	9⅞" x 39⅞"	11½" x 41½"	9" x 39"
SC3042	15⅞" x 39⅞"	17½" x 41½"	15" x 39"
SC3342	18⅞" x 39⅞"	20½" x 41½"	18" x 39"
SC3642	21⅞" x 39⅞"	23½" x 41½"	21" x 39"
SC4242B	13⅞" x 39⅞"	14⅞" x 41½"	27" x 39"
SC4842B	16⅞" x 39⅞"	17⅞" x 41½"	33" x 39"

Square Corner Wall Cabinets, 30" High, 12" Deep

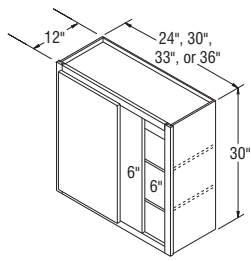

SC2430*
SC3030*
SC3330*
SC3630*

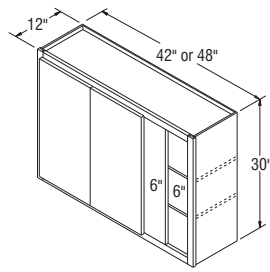

SC4230B*
SC4830B*

*Specify L or R blind designation on all Arch styles.

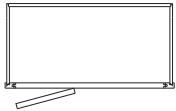

TOP VIEW
SC (RIGHT)

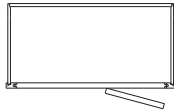

TOP VIEW
SC (LEFT)

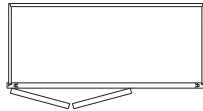

TOP VIEW
SC (RIGHT)

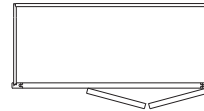

TOP VIEW
SC (LEFT)

NOTES ✓

- ▶ Two adjustable shelves.
- ▶ 3" Filler is included. Filler Overlays shipped unattached with Brellin, Briarcliff II, Durham, Eastland, Overton, and Wentworth styles.
- ▶ Hinging determines location of the blind. Door attaches to blind panel.
- ▶ Cabinets are reversible, except for Arch styles.
- ▶ Cover panel shipped with cabinet for field installation to cover 6" blind opening.
- ▶ Reference Installation Charts for proper sizing identification, see page 80.

DESIGN SOLUTIONS

- ▶ When a cabinet is "pulled," it will use proportionally more wall space. For example, a 30" wide Wall cabinet pulled 2" will use 32" of space.
- ▶ Blind side of Wall Corner cabinets cannot be installed next to a Range Hood or Microwave Shelf due to door interference.

Square Corner Wall Cabinets, 36" High, 12" Deep

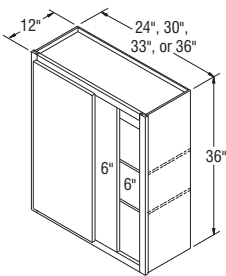

SC2436*
SC3036*
SC3336*
SC3636*

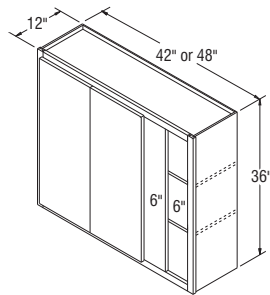

SC4236B*
SC4836B*

*Specify L or R blind designation on all Arch styles.

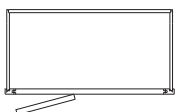

TOP VIEW
SC (RIGHT)

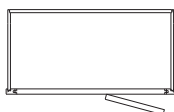

TOP VIEW
SC (LEFT)

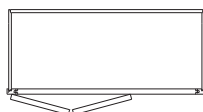

TOP VIEW
SC (RIGHT)

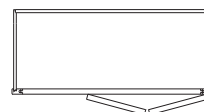

TOP VIEW
SC (LEFT)

NOTES ✓

- ▶ Two adjustable shelves.
- ▶ 3" Filler is included. Filler Overlays shipped unattached with Brellin, Briarcliff II, Durham, Eastland, Overton, and Wentworth styles.
- ▶ Hinging determines location of the blind. Door attaches to blind panel.
- ▶ Cabinets are reversible, except for Arch styles.
- ▶ Cover panel shipped with cabinet for field installation to cover 6" blind opening.
- ▶ Reference Installation Charts for proper sizing identification, see page 80.

DESIGN SOLUTIONS

- ▶ When a cabinet is "pulled," it will use proportionally more wall space. For example, a 30" wide Wall cabinet pulled 2" will use 32" of space.
- ▶ Blind side of Wall Corner cabinets cannot be installed next to a Range Hood or Microwave Shelf due to door interference.

Square Corner Wall Cabinets, 42" High, 12" Deep

NOTES ✓

- ▶ Three adjustable shelves.
- ▶ 3" Filler is included. Filler Overlays shipped unattached with Brellin, Briarcliff II, Durham, Eastland, Overton, and Wentworth styles.
- ▶ Hinging determines location of the blind. Door attaches to blind panel.
- ▶ Cabinets are reversible, except for Arch styles.
- ▶ Cover panel shipped with cabinet for field installation to cover 6" blind opening.
- ▶ Reference Installation Charts for proper sizing identification, see page 80.

DESIGN SOLUTIONS

- ▶ When a cabinet is "pulled," it will use proportionally more wall space. For example, a 30" wide Wall cabinet pulled 2" will use 32" of space.
- ▶ Blind side of Wall Corner cabinets cannot be installed next to a Range Hood or Microwave Shelf due to door interference.

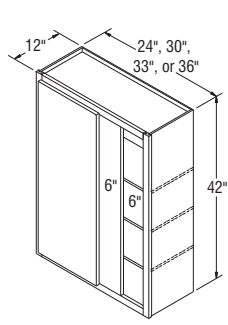

SC2442*
SC3042*
SC3342*
SC3642*

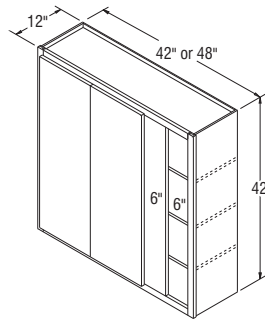

SC4242B*
SC4842B*

*Specify L or R blind designation on all Arch styles.

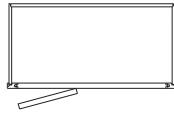

TOP VIEW
SC (RIGHT)

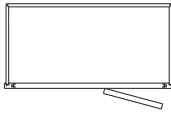

TOP VIEW
SC (LEFT)

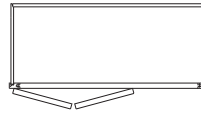

TOP VIEW
SC (RIGHT)

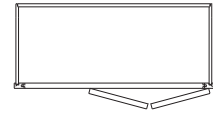

TOP VIEW
SC (LEFT)

Wall End Cabinets, Single Door, 30", 36", and 42" High, 12" Deep

NOTES ✓

- ▶ 30" and 36" cabinets include two adjustable shelves; 42" high cabinets include three adjustable shelves.
- ▶ Cabinet backs will not match front.

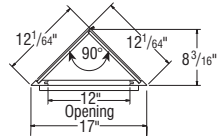
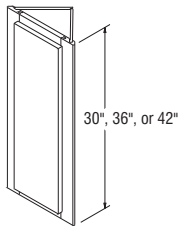

TOP VIEW

WEC1230
WEC1236
WEC1242

Wall End Cabinets, Double Door, 30", 36", and 42" High, 12" Deep

NOTES ✓

- ▶ 30" and 36" cabinets include two adjustable shelves; 42" high cabinets include three adjustable shelves.

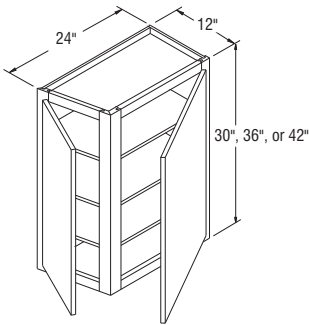

ANGLE - LEFT
HINGE - RIGHT

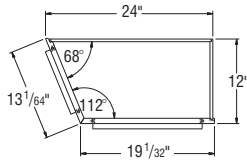

TOP VIEW

WECL2430*
WECL2430*
WECL2436*

WECL2436*
WECL2442*
WECL2442*

*Specify L or R to indicate hinging for front door on all styles.

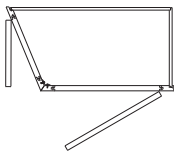

TOP VIEW
ANGLE - LEFT
HINGE - RIGHT

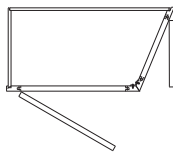

TOP VIEW
ANGLE - RIGHT
HINGE - LEFT

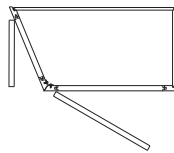

TOP VIEW
ANGLE - LEFT
HINGE - LEFT

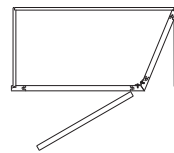

TOP VIEW
ANGLE - RIGHT
HINGE - RIGHT

Peninsula Wall Cabinets, 18" High, 12" Deep

NOTES ✓

► Shelves not available.

DESIGN SOLUTIONS

► Apply an End Panel Skin to create a flush end on the side of a Wall cabinet if installed at the end of a run for ease of Moulding installation.

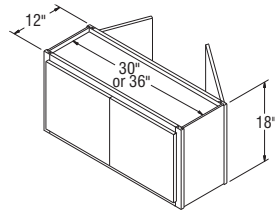

PW3018B

PW3618B

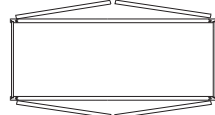

TOP VIEW

NOTES ✓

► One adjustable shelf.
► Single door reversible.

DESIGN SOLUTIONS

► Apply an End Panel Skin to create a flush end on the side of a Wall cabinet if installed at the end of a run for ease of Moulding installation.

Peninsula Wall Cabinets, 24" High, 12" Deep

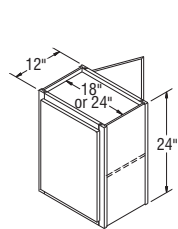

PW1824

PW2424

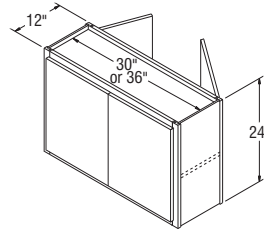

PW3024B

PW3624B

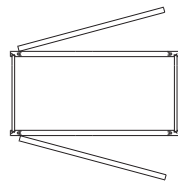

TOP VIEW

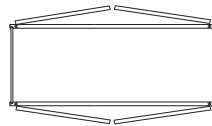

TOP VIEW

Peninsula Wall Cabinets, 30" High, 12" Deep

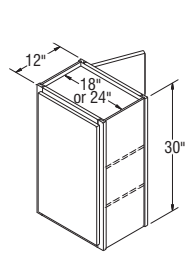

PW1830
PW2430

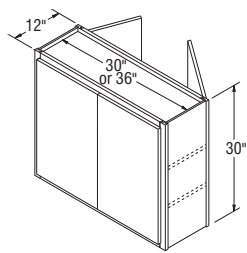

PW3030B
PW3630B

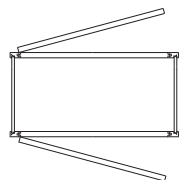

TOP VIEW

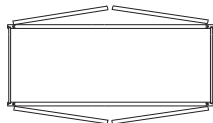

TOP VIEW

NOTES ✓

- ▶ Two adjustable shelves.
- ▶ Single door reversible.

DESIGN SOLUTIONS

- ▶ Apply an End Panel Skin to create a flush end on the side of a Wall cabinet if installed at the end of a run for ease of Moulding installation.

Peninsula Wall Cabinets with 4 Mullion Doors, 24" High, 12" Deep

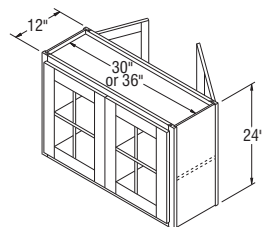

PWMD3024B
PWMD3624B

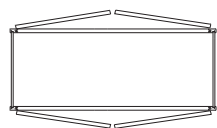

TOP VIEW

NOTES ✓

- ▶ One adjustable $\frac{3}{4}$ " thick matching Aristex™ shelf aligns with door mullions on Standard mullions, but does not align on Shaker mullions.
- ▶ Cabinets include installed clear tempered glass and matching Aristex™ interior.
- ▶ All doors are mullion.
- ▶ Backs of face frames are unfinished. See page 28 for Standard and Shaker mullion door style availability and grid configurations.
- ▶ Peninsula Mullion Door cabinets are not available in Teagan.

DESIGN SOLUTIONS

- ▶ Apply an End Panel Skin to create a flush end on the side of a Wall cabinet if installed at the end of a run for ease of Moulding installation.
- ▶ For complementary Peninsula Wall Mullion Door cabinets in Teagan, order as Winstead Maple, as Teagan features a slab door design.

NOTES ✓

- ▶ Cabinets include matching Aristex™ interior, one adjustable ¾" thick shelf, and clips to install glass (glass not included).
- ▶ Peninsula Wall Prepped for Glass cabinets are not available in Augusta or Teagan.

DESIGN SOLUTIONS

- ▶ Apply an End Panel Skin to create a flush end on the side of a Wall cabinet if installed at the end of a run for ease of Moulding installation.
- ▶ For complementary Peninsula Wall Prepped for Glass cabinets in Teagan, order as Winstead Maple, as Teagan features a slab door design.

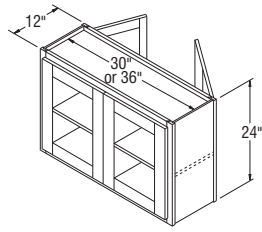
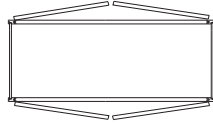
Peninsula Wall Cabinets with 4 Doors Prepped for Glass, 24" High, 12" Deep**PWPG3024B****PWPG3624B**

TOP VIEW

Base Cabinets, 35" High, 23 3/4" Deep

NOTES ✓

- ▶ B09 is a Full Height door and does not include an adjustable shelf or vertical partition.
- ▶ Includes one adjustable 3/4" thick half depth shelf.

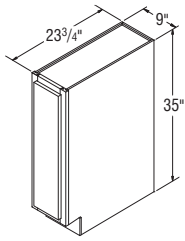

B09

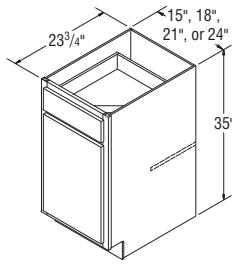

**B12
B18
B18**

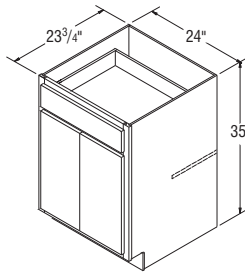

B24DD

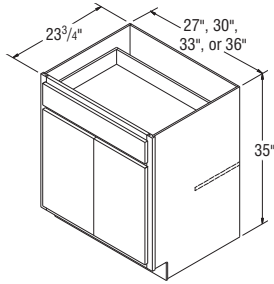

**B27B
B30B
B33B
B36B**

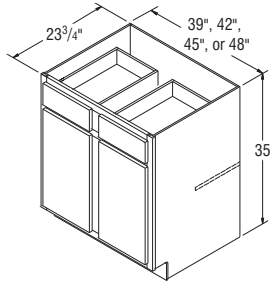

**B39
B42
B45
B48**

Base Cabinet Tray Divider, 35" Deep, 23 3/4" Deep

NOTES ✓

- ▶ B09TD is a Full Height door and includes an installed chrome tray divider.
- ▶ B12TD includes a standard base drawer with two installed chrome tray dividers.
- ▶ Tray Divider is also available as an accessory for field installation. See page 172.

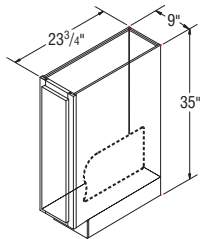

B09TD

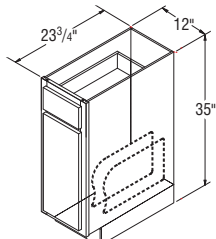

B12TD



NOTES ✓

- ▶ All Roll Tray cabinets include one half depth adjustable 3/4" thick shelf.
- ▶ Roll Trays feature 1/2" thick solid-wood front and furniture board sides and back.
- ▶ Additional Roll Trays on page 171 may be ordered separately (TKIT).
- ▶ Upgrade charges do not include Roll Trays.
- ▶ Roll Tray Bumper Pads will be included for field installation.
- ▶ Smart Stop™ drawer guides are not available on Roll Trays in Select and APC Construction.



Base Cabinets with Roll Tray, 35" High, 23 3/4" Deep

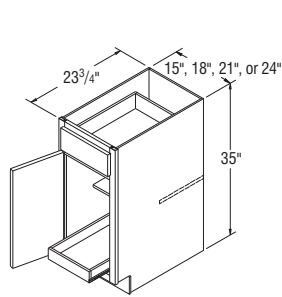

B15RT
B18RT

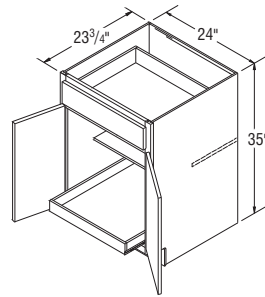

B21RT
B24RT

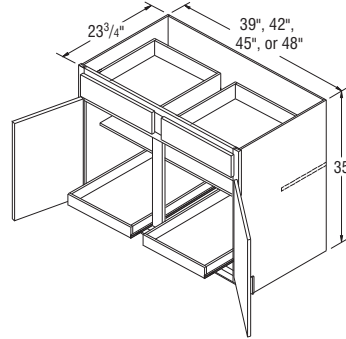

B24DDRT

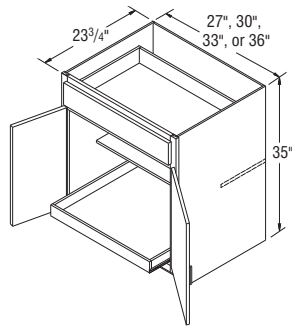

B27RTB
B30RTB
B33RTB
B36RTB

NOTES ✓

- ▶ Roll Trays feature 1/2" thick solid-wood front and furniture board sides and back.
- ▶ Additional Roll Trays on page 171 may be ordered separately (TKIT).
- ▶ Upgrade charges do not include Roll Trays.
- ▶ Roll Tray Bumper Pads will be included for field installation.
- ▶ Smart Stop™ drawer guides are not available on Roll Trays in Select and APC Construction.



Base Cabinets with Double Roll Trays, 35" High, 23 3/4" Deep

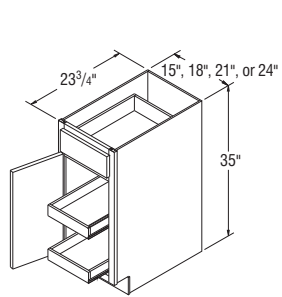

B15RT-2
B18RT-2

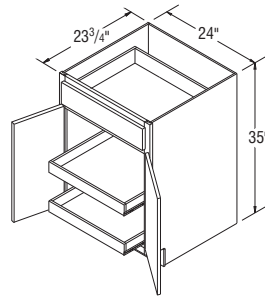

B21RT-2
B24RT-2

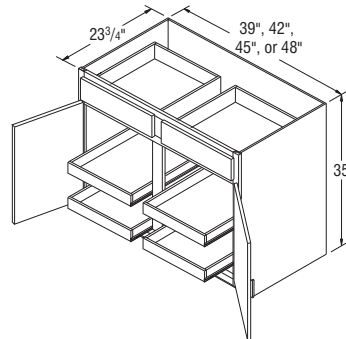

B24DDRT-2

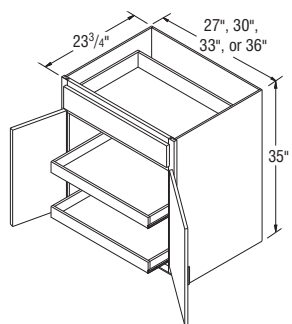

B27RT-2B
B30RT-2B
B33RT-2B
B36RT-2B

Base SuperCabinets™, 35" High, 30" Wide, 23 3/4" Deep (Pull-out/Roll-out)

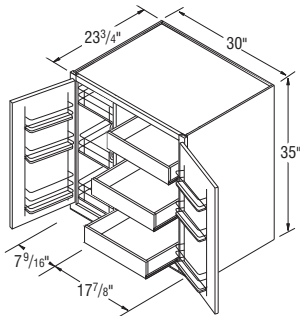

BSC30PRB

NOTES ✓

- ▶ SuperCabinet™ doors open 170° to allow sufficient Pull-out clearance. When installing a SuperCabinet™ near a wall or corner, please allow 12" of adjacent space for proper operation of interior Pull-outs.
- ▶ Roll Trays are solid-wood dovetail boxes with Full extension side-mounted guides.
- ▶ Upgrade charges do not include Roll Trays.
- ▶ Both doors will have a chrome and wood three-tiered rack that is 3 7/8" deep.
- ▶ Includes cabinet top.
- ▶ Smart Stop™ drawer guides are not available on Roll Trays in Select and APC Construction.
- ▶ Roll Tray Bumper Pads must be ordered separately.
- ▶ Soft Close Hinges are not available in Select and APC Construction.



Base SuperCabinets™, 35" High, 30" Wide, 23 3/4" Deep (Roll-out/Pull-out)

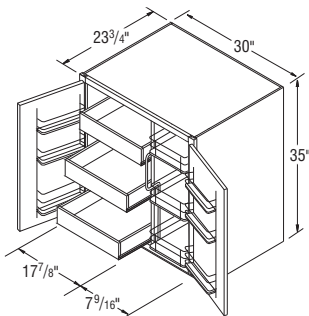

BSC30RPB

NOTES ✓

- ▶ SuperCabinet™ doors open 170° to allow sufficient Pull-out clearance. When installing a SuperCabinet™ near a wall or corner, please allow 12" of adjacent space for proper operation of interior Pull-outs.
- ▶ Roll Trays are solid-wood dovetail boxes with Full extension side-mounted guides.
- ▶ Upgrade charges do not include Roll Trays.
- ▶ Both doors will have a chrome and wood three-tiered rack that is 3 7/8" deep.
- ▶ Includes cabinet top.
- ▶ Smart Stop™ drawer guides are not available on Roll Trays in Select and APC Construction.
- ▶ Roll Tray Bumper Pads must be ordered separately.
- ▶ Soft Close Hinges are not available in Select and APC Construction.



NOTES ✓

- ▶ SuperCabinet™ doors open 170° to allow sufficient Pull-out clearance. When installing a SuperCabinet™ near a wall or corner, please allow 12" of adjacent space for proper operation of interior Pull-outs.
- ▶ Roll Trays are solid-wood dovetail boxes with Full extension side-mounted guides.
- ▶ Upgrade charges do not include Roll Trays.
- ▶ Both doors will have a chrome and wood three-tiered rack that is 3 3/8" deep.
- ▶ Includes cabinet top.
- ▶ Smart Stop™ drawer guides are not available on Roll Trays in Select and APC Construction.
- ▶ Roll Tray Bumper Pads must be ordered separately.
- ▶ Soft Close Hinges are not available in Select and APC Construction.



Base SuperCabinets™, 35" High, 36" Wide, 23 3/4" Deep (Pull-out/Roll-out/Pull-out)

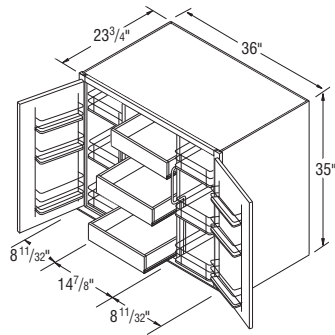

BSC36PRPB

Base Cabinets with Full Height Doors, 35" High, 12" Deep

NOTES ✓

- ▶ Includes one 3/4" thick full depth adjustable shelf.
- ▶ Use with BEC12 (page 105) to transition from standard 23 3/4" depth to 12" depth.

DESIGN SOLUTIONS

- ▶ Use in designs to create varying depths in kitchens, islands, hutches, bookcases, offices, and bathrooms.

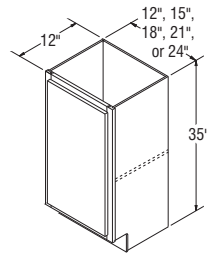

B12FH-12
B15FH-12
B18FH-12
B21FH-12
B24FH-12

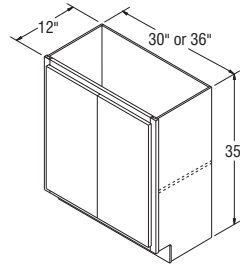

B30FH-12B
B36FH-12B

Base Cabinets with Full Height Doors, 35" High, 23 3/4" Deep

NOTES ✓

- Includes one 3/4" thick full depth adjustable shelf.

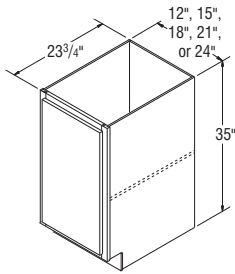

B12FH
B15FH
B18FH
B21FH
B24FH

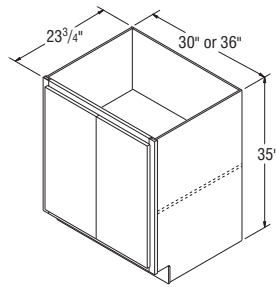

B30FHB
B36FHB

Base Box Column Pull-out Cabinet, 30" High, 6" Wide, 23" Deep

NOTES ✓

- Features a wood Pull-out unit with adjustable shelves, chrome rail sides, and Full extension guides. Filler included, must be attached in the field.
- Recommend installation between two cabinets. Can be installed on the end of a run by using a 3/4" Refrigerator End Panel.
- It is recommended that the OL631 Overlay be applied to the front of the BBCP06 to give it a finished look.
- Smart Stop™ drawer guides are not available in Select and APC Construction.

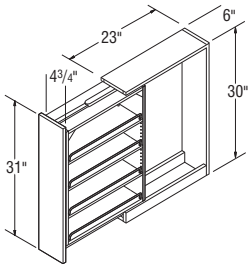

BBCP06*

*** In order to allow sufficient clearance, cabinet requires 6 1/8" space between adjacent cabinet face frames. Spacers included for proper installation.**

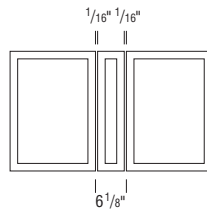

Total space required between face frames



Base Pantry Pull-out Cabinet, 35" High, 9" Wide, 23 3/4" Deep

NOTES ✓

- Features a wood Pull-out unit with adjustable shelves, chrome rail sides, and Full extension guides.
- Smart Stop™ drawer guides are not available in Select and APC Construction.

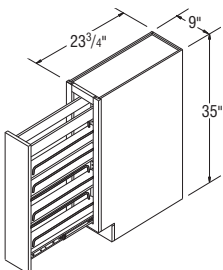

BPP09



NOTES ✓

- ▶ Cabinets include matching Aristex™ interior.
- ▶ Includes one 3/4" thick full depth adjustable shelf.

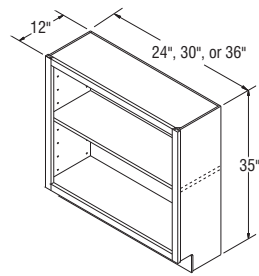

BOL2412
BOL3012
BOL3612

Base Open Cabinets, 35" High, 12" Deep

NOTES ✓

- ▶ Cabinets include matching Aristex™ interior.
- ▶ Includes one 3/4" thick full depth adjustable shelf.

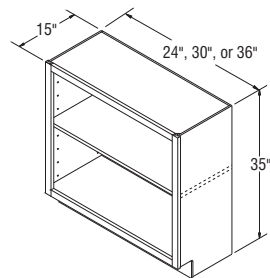

BOL2415
BOL3015
BOL3615

Base Open Cabinets, 35" High, 15" Deep

NOTES ✓

- ▶ Cabinets include installed clear tempered glass and matching Aristex™ interior.
- ▶ See page 28 for standard and shaker mullion door style availability and configurations.
- ▶ Mullion door cabinets not available in Teagan.
- ▶ Includes one 3/4" thick full depth adjustable shelf.
- ▶ For complementary Base Mullion Door cabinets in Teagan, order as Winstead Maple, as Teagan features a slab door design.

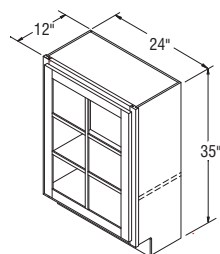

BMD2412FH

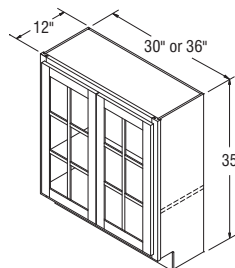

BMD3012FHB
BMD3612FHB

Base Cabinets with Mullion Doors, 35" High, 12" Deep

Base Cabinets with Mullion Doors, 35" High, 15" Deep

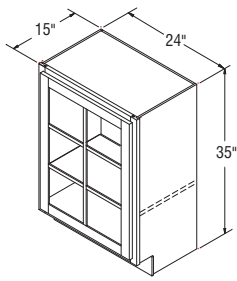

BMD2415FH

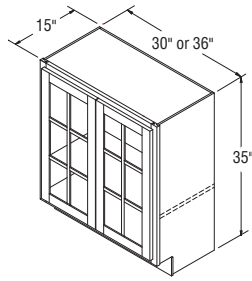

BMD3015FHB
BMD3615FHB

NOTES ✓

- ▶ Cabinets include installed clear tempered glass and matching Aristex™ interior.
- ▶ See page 28 for standard and shaker mullion door style availability and configurations.
- ▶ Mullion door cabinets not available in Teagan.
- ▶ Includes one ¾" thick full depth adjustable shelf.
- ▶ For complementary Base Mullion Door cabinets in Teagan, order as Winstead Maple, as Teagan features a slab door design.

Base Cabinets with Doors Prepped for Glass, 35" High, 12" Deep

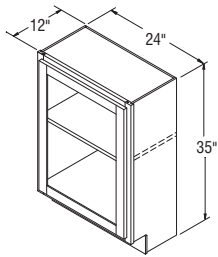

BPG2412FH

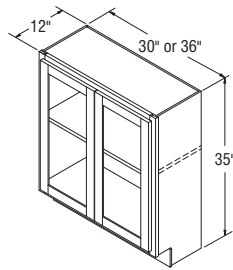

BPG3012FHB
BPG3612FHB

NOTES ✓

- ▶ Cabinets include matching Aristex™ interior and clips to install glass (glass not included).
- ▶ Includes one ¾" thick full depth adjustable shelf.
- ▶ Base Prepped for Glass cabinets are not available in Augusta or Teagan.
- ▶ For complementary Base Prepped for Glass cabinets in Teagan, order as Winstead Maple, as Teagan features a slab door design.

Base Cabinets with Doors Prepped for Glass, 35" High, 15" Deep

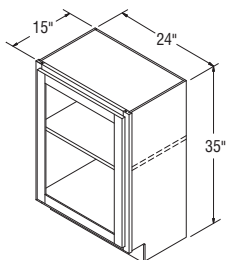

BPG2415FH

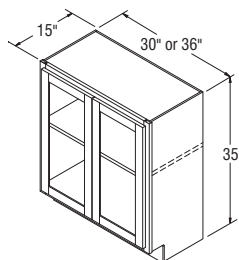

BPG3015FHB
BPG3615FHB

NOTES ✓

- ▶ Cabinets include matching Aristex™ interior and clips to install glass (glass not included).
- ▶ Includes one ¾" thick full depth adjustable shelf.
- ▶ Base Prepped for Glass cabinets are not available in Augusta or Teagan.
- ▶ For complementary Base Prepped for Glass cabinets in Teagan, order as Winstead Maple, as Teagan features a slab door design.

NOTES ✓

- ▶ Full extension slide out shelves pull out independently.
- ▶ Smart Stop™ drawer guides are not available on the Pots and Pans Pull-out in Select and APC Construction.



Base Pots and Pans Pull-out, 35" High, 24" Wide, 23 3/4" Deep

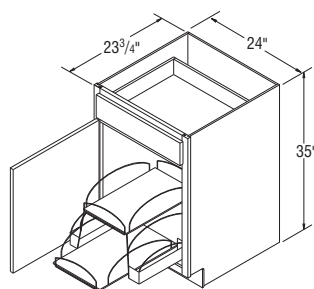

BPPP24

NOTES ✓

- ▶ BWB15FH has one 50-quart wastebasket and small storage tray on Full extension guides.
- ▶ Beige wastebasket support.
- ▶ Smart Stop™ drawer guides are not available in Select and APC Construction.



Base Wastebasket with Full Height Door, 35" High, 23 3/4" Deep

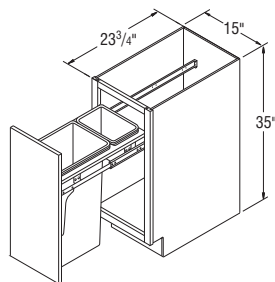

BWB15FH

NOTES ✓

- ▶ BWB18 and BWB21 have two 35-quart Pull-out wastebaskets on Full extension guides.
- ▶ Beige wastebasket support.
- ▶ Smart Stop™ drawer guides are not available in Select and APC Construction.



Base Wastebaskets, 35" High, 23 3/4" Deep

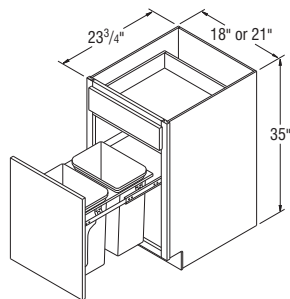

**BWB18
BWB21**

Base Wastebasket, Full Height Doors w/Bottom Mount Guide, 35" High, 23 3/4" Deep

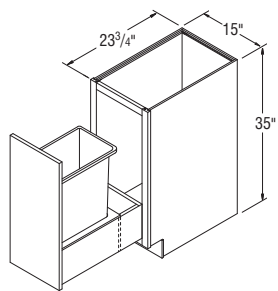

BWB15FHBMG

NOTES ✓

- ▶ BWB15FHBMG has one 50-quart wastebasket and small storage tray.
- ▶ Smart Stop™ drawer guides are standard on all construction platforms.



Base Wastebasket w/Bottom Mount Guide, 35" High, 23 3/4" Deep

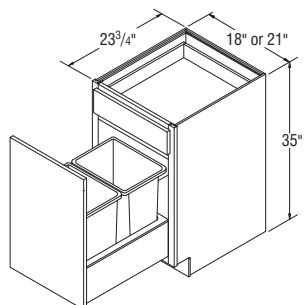

BWB18BMG
BWB21BMG

NOTES ✓

- ▶ BWB18BMG and BWB21BMG have two 35-quart Pull-out wastebaskets.
- ▶ Bottom drawer features wood dovetailed drawer box with Smart Stop™ drawer guides on all construction platforms.
- ▶ The top drawer will remain the standard drawer box unless the cabinet is upgraded to the Select or APC construction platform.



Sink/Range Bases, 35" High, 23 3/4" Deep

NOTES ✓

- ▶ FP = False Panel.
- ▶ It may be necessary to modify the corner braces/stretcher rails with some sink applications.
- ▶ Shelf not included; interiors will include shelf clip holes on all Sink Bases.
- ▶ Front-Onlys are not available in Sink Bases.

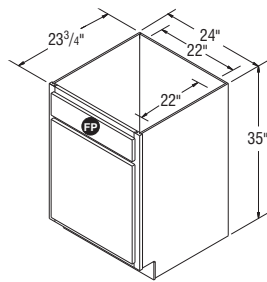

SB24

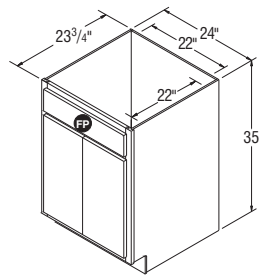

SB24DD

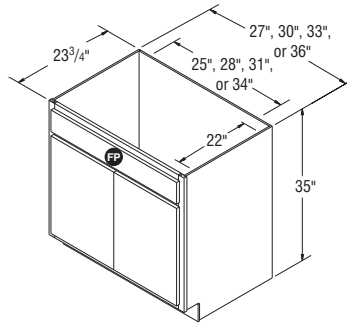

SB27B
SB30B
SB33B
SB36B

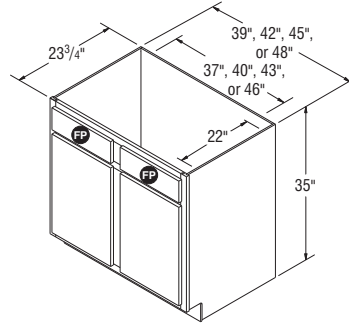

SB39
SB42
SB45
SB48

NOTES ✓

- ▶ Reversible Shelf is constructed from 3/4" thick laminated furniture board. Shelf shipped secure, can be positioned in left or right corner.
- ▶ Both doors will have a chrome and wood two-tiered rack that is 3 1/4" deep.
- ▶ Includes two installed tilt-out trays.
- ▶ Quarter round shelf will be natural maple laminate for all styles, including Glacier Gray, Stone Grey, Toasted Antique, and White styles.
- ▶ Soft Close Hinges are not available in Select and APC Construction.
- ▶ Shelf not included; interiors will include shelf clip holes on all Sink Bases.

Sink Base SuperCabinets™ with Reversible Shelf, 35" High, 23 3/4" Deep

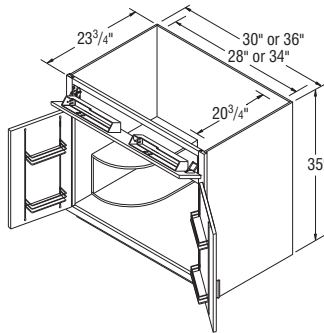

SB30STSB
SB36STSB



Sink Base SuperCabinets™, 35" High, 23 3/4" Deep

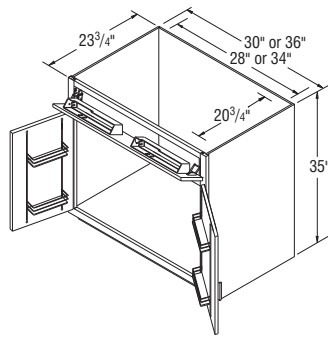

SB30STNSB
SB36STNSB

NOTES ✓

- ▶ Both doors will have a chrome and wood two-tiered rack that is 3 1/4" deep.
- ▶ Includes two installed tilt-out trays.
- ▶ Soft Close Hinges are not available in Select and APC Construction.
- ▶ Shelf not included; interiors will include shelf clip holes on all Sink Bases.



Country Sink Bases, 35" High, 23 3/4" Deep

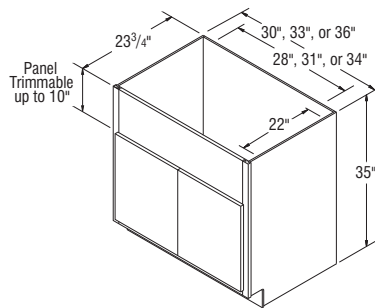

CNTYSB30B
CNTYSB33B
CNTYSB36B

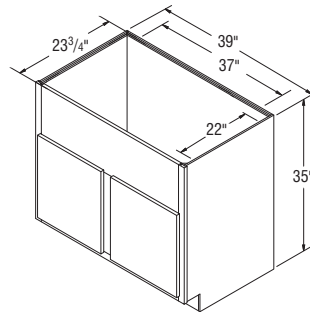

CNTYSB39

NOTES ✓

- ▶ It may be necessary to modify the corner braces/stretcher rails with some sink applications.
- ▶ Shelf not included; interiors will include shelf clip holes on all Sink Bases.
- ▶ When installing a sink, additional support may be required. Refer to the sink manufacturer guidelines.

Sink Base Diagonal Corner Cabinets, 35" High, 23 3/4" Deep

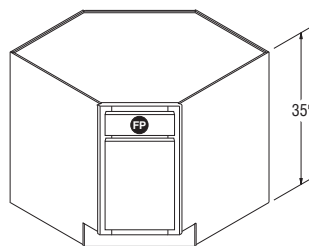

SBDC36
SBDC42

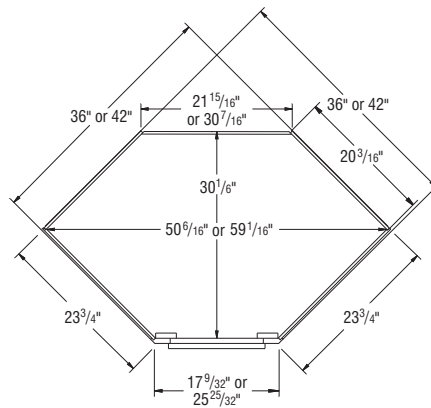

TOP VIEW

NOTES ✓

- ▶ FP = False Panel.
- ▶ For sufficient dishwasher door clearance and loading/unloading space, a 15" wide base cabinet is recommended for use between sink base diagonal corner cabinet and dishwasher.

	Wall Width	Max. Sink Width
SBDC36	36" x 36"	25 3/4"
SBDC42	42" x 42"	34 1/4"

NOTES ✓

- ▶ Sink Base floor included with all units.
- ▶ Trimmable 3" each side on partial overlay styles. Not trimmable on full overlay styles.
- ▶ SF30 single door only available partial overlay styles.
- ▶ SF30B only available full overlay styles.
- ▶ SF42 only available full overlay styles.
- ▶ SF42B only available partial overlay styles.

Sink/Range Fronts, 35" High

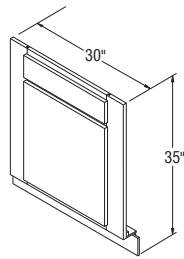

PARTIAL OVERLAY
SF30

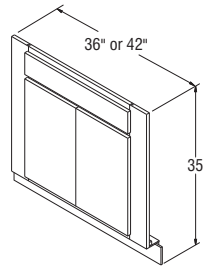

PARTIAL OVERLAY
SF36B
SF42B

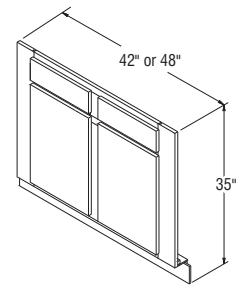

PARTIAL OVERLAY
SF48

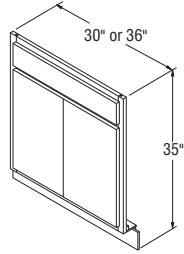

FULL OVERLAY
SF30B
SF36B

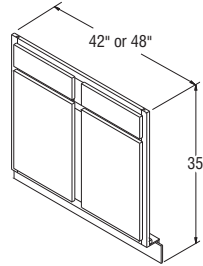

FULL OVERLAY
SF42
SF48

NOTES ✓

- ▶ Sink Base floor included with all units.
- ▶ Toekick is not attached, ships loose.
- ▶ For sufficient dishwasher door clearance and loading/unloading space, a 15" wide base cabinet is recommended for use between sink base diagonal corner cabinet and dishwasher.
- ▶ Floor dimensions:
SFC36 – 3/8" x 36" x 36".
SFC42 – 3/8" x 42" x 42".

Sink Front Corners, 35" High

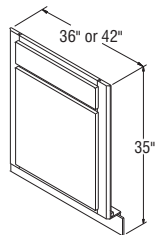

SFC36
SFC42

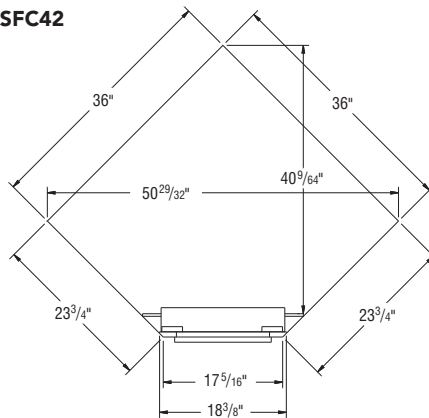

SFC36
TOP VIEW

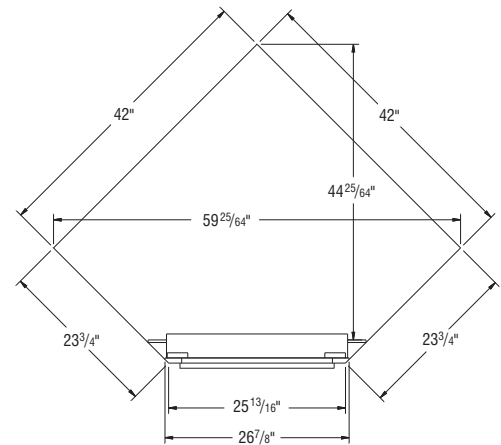

SFC42
TOP VIEW

	Wall Width	Max. Sink Width
SFC36	36" x 36"	25 ³ / ₄ "
SFC42	42" x 42"	34 ¹ / ₄ "

Four Drawer Bases, 35" High, 23 3/4" Deep

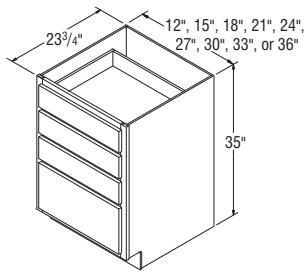

DB12-4
DB15-4
DB18-4
DB21-4
DB24-4
DB27-4
DB30-4
DB33-4
DB36-4

NOTES ✓

- ▶ DB36-4 is recommended for use with Pegged Dish Organizer (PDO) on page 167. PDO can also be trimmed to fit smaller widths.
- ▶ Raised panel styles - drawer fronts will convert to raised panel;
Full overlay - 10 1/4" or higher
Partial overlay - 9 7/8" or higher

Three Drawer Bases, 35" High, 23 3/4" Deep

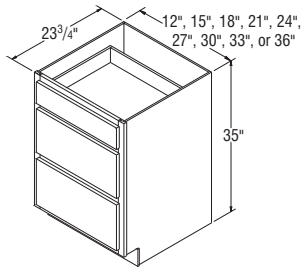

DB12
DB15
DB18
DB21
DB24
DB27
DB30
DB33
DB36

NOTES ✓

- ▶ DB36 is recommended for use with Pegged Dish Organizer (PDO) on page 167. PDO can also be trimmed to fit smaller widths.
- ▶ Raised panel styles - drawer fronts will convert to raised panel;
Full overlay - 10 1/4" or higher
Partial overlay - 9 7/8" or higher

Three Drawer Bases with False Panel, 35" High, 23 3/4" Deep

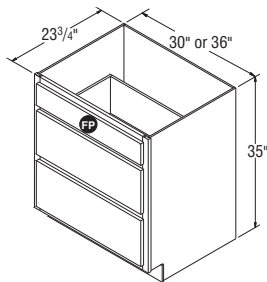

DBFP30
DBFP36

NOTES ✓

- ▶ Cabinet features a false panel to accommodate the install of a cooktop.
- ▶ DBFP36 is recommended for use with Pegged Dish Organizer (PDO) on page 167. PDO can also be trimmed to fit DBFP30.
- ▶ Raised panel styles - drawer fronts will convert to raised panel;
Full overlay - 10 1/4" or higher
Partial overlay - 9 7/8" or higher
- ▶ Clearance behind drawer box and back of cabinet is approximately 3 7/16" on PABD drawers and 2 7/16" on plywood drawers.

NOTES ✓

- ▶ Microwave opening is trimmable.
- ▶ Designed for Built-in Microwaves with trim kits (cabinet has standard Aristex™ natural interior).



Base Built-in Microwave Cabinet, 35" High, 23 3/4" Deep

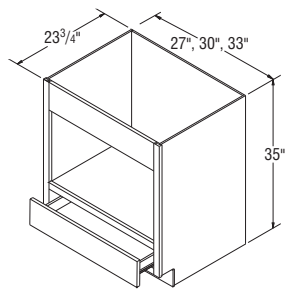

BMW2735
BMW3035
BMW3335

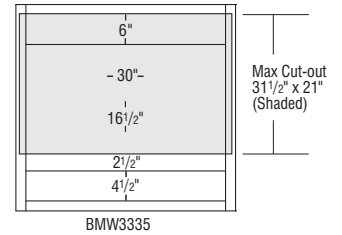
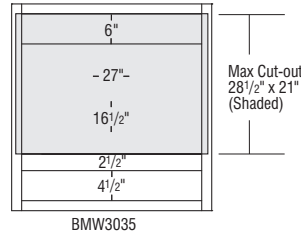
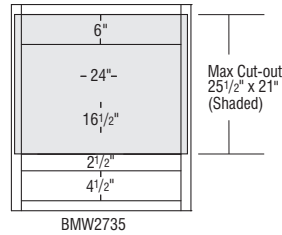

NOTES ✓

- ▶ Trim kit not applicable.
- ▶ Matching Aristex™ interior.



Base Microwave Cabinets with Deep Drawer, 35" High, 23 3/4" Deep *New*

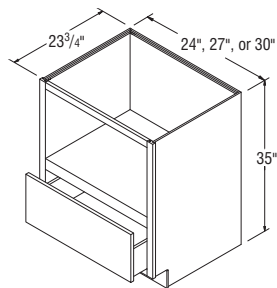

BMW2435DD
BMW2735DD
BMW3035DD

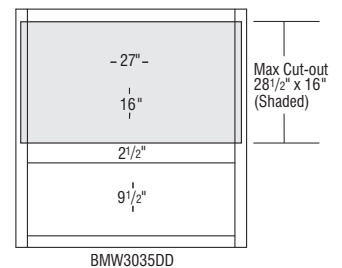
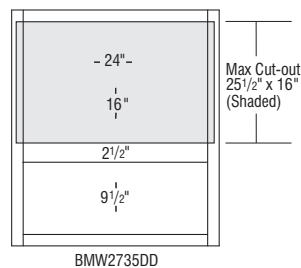
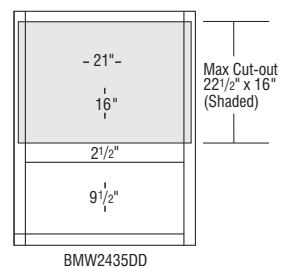

Base Microwave Cabinets with Deep Drawer, 34 1/2" High, 23 3/4" Deep *New*

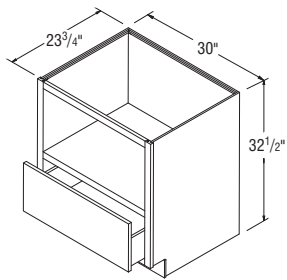

BMW3032.5DD

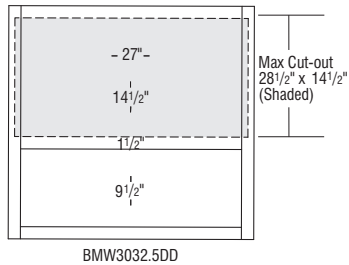

BMW3032.5DD

NOTES ✓

- ▶ Trim kit not applicable.
- ▶ Matching Aristex™ interior.



Square Corner/Base Roto Easy Reach Cabinets, 35" High, 23 3/4" Deep

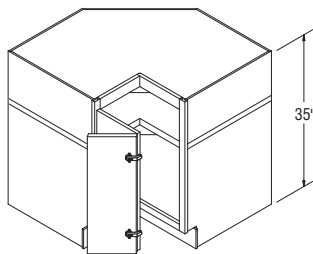

SCER36*

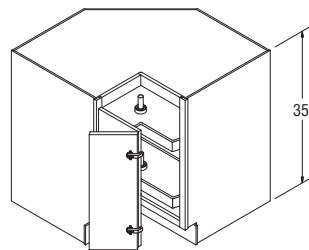

BRER36*

*Specify L or R for full overley styles.

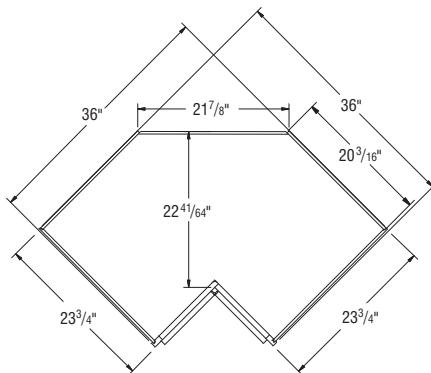

TOP VIEW

NOTES ✓

- ▶ One knuckle hinge door.
- ▶ Includes magnetic catch.
- ▶ SCER shelf is not adjustable.
- ▶ Cannot convert SCER36 to BRER.
- ▶ BRER36 includes two 28" diameter rotating plastic white trays. Each tray has a 60 lb. load capacity
- ▶ BRER: WARNING! The rotating trays in this cabinet are preinstalled and cannot be removed or replaced. Do not stand on, or apply excessive pressure that could cause a tray to crack or break.
- ▶ Decorative hardware must be countersunk to prevent scratching of adjacent cabinets and face frame of SCER/BRER.
- ▶ Soft Close Hinges are not available in Select and APC Construction.



NOTES ✓

- ▶ One rotating door.
- ▶ Two rotating white shelves.
- ▶ Nominal gap of 1/4" on all sides of door.
- ▶ SCR33 has 17" diameter shelf and holds 20 lbs. per shelf.
- ▶ SCR36 has 27" diameter shelf and holds 60 lbs. per shelf.
- ▶ APC charges do not apply to SCR cabinets.
- ▶ Soft Close Hinges are not available in Select and APC Construction.
- ▶ For stability, install SCR cabinets between base cabinets.

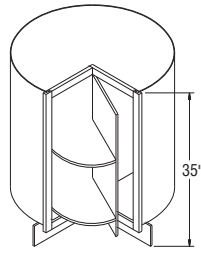

SCR33
SCR36

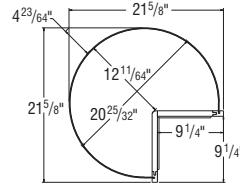

SCR33
TOP VIEW

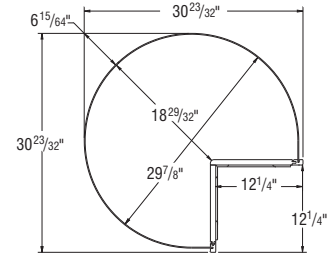

SCR36
TOP VIEW



Base Lazy Susans, 35" High

NOTES ✓

- ▶ One knuckle hinge door.
- ▶ Includes magnetic catch.
- ▶ BLS33 has two 17" diameter rotating plastic white shelves that hold 20 lbs. per shelf.
- ▶ BLS36 has two 27" diameter rotating plastic white shelves that hold 60 lbs. per shelf.
- ▶ APC charges do not apply to BLS cabinets.
- ▶ Soft Close Hinges are not available in Select and APC Construction.
- ▶ For stability, install SCR cabinets between base cabinets.

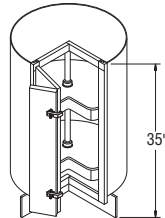

BLS33*

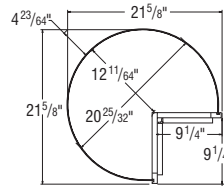

BLS33
TOP VIEW

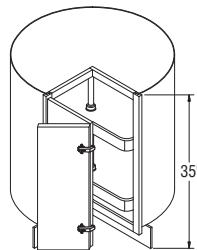

BLS36*

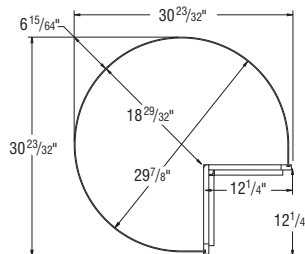

BLS36
TOP VIEW

*Specify L or R for full overlay styles.



Base Corner Cabinet Installation Charts

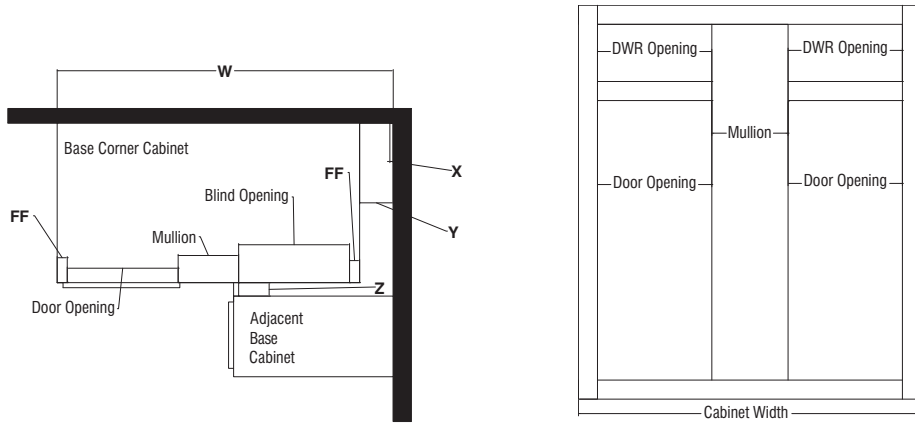

Full Overlay Base Corner Cabinet Information

Full Overlay Styles	Actual Cabinet Width	X		Y	Z		W	
		Min. Pull	Min. Pull w/Hardware	Max. Pull	Min. Filler Required	Min. Filler Required w/Hardware	Min. Pull From Wall To End of Cabinet	Max Pull From Wall To End of Cabinet
BC36	27"	9 ³ / ₄ "	11 ¹ / ₄ "	12 ¹ / ₂ "	1"	2 ¹ / ₂ "	36 ³ / ₄ "	39 ¹ / ₂ "
BC39	30"	6 ³ / ₄ "	8 ¹ / ₄ "	12 ¹ / ₂ "	1"	2 ¹ / ₂ "	36 ³ / ₄ "	42 ¹ / ₂ "
BC42	36"	3 ³ / ₄ "	5 ¹ / ₄ "	9 ¹ / ₂ "	1"	2 ¹ / ₂ "	39 ³ / ₄ "	45 ¹ / ₂ "
BC45	42"	³ / ₄ "	2 ¹ / ₄ "	6 ¹ / ₂ "	1"	2 ¹ / ₂ "	42 ³ / ₄ "	48 ¹ / ₂ "
BC48	45"	0"	³ / ₄ "	5"	1"	2 ¹ / ₂ "	45"	50"
BC51	48"	0"	0"	3 ¹ / ₂ "	1"	2 ¹ / ₂ "	48"	51 ¹ / ₂ "

7/16" Overlay Base Corner Cabinet Information

7/16" Overlay Styles	Actual Cabinet Width	X		Y	Z		W	
		Min. Pull	Min. Pull w/Hardware	Max. Pull	Min. Filler Required	Min. Filler Required w/Hardware	Min. Pull From Wall To End of Cabinet	Max Pull From Wall To End of Cabinet
BC36	27"	9 ¹ / ₄ "	10 ³ / ₄ "	12 ¹ / ₂ "	¹ / ₂ "	2"	36 ¹ / ₄ "	39 ¹ / ₂ "
BC39	30"	6 ¹ / ₄ "	7 ³ / ₄ "	12 ¹ / ₂ "	¹ / ₂ "	2"	36 ¹ / ₄ "	42 ¹ / ₂ "
BC42	36"	3 ¹ / ₄ "	4 ³ / ₄ "	9 ¹ / ₂ "	¹ / ₂ "	2"	39 ¹ / ₄ "	45 ¹ / ₂ "
BC45	42"	¹ / ₄ "	1 ³ / ₄ "	6 ¹ / ₂ "	¹ / ₂ "	2"	42 ¹ / ₄ "	48 ¹ / ₂ "
BC48	45"	0"	¹ / ₄ "	5"	¹ / ₂ "	2"	45"	50"
BC51	48"	0"	0"	3 ¹ / ₂ "	¹ / ₂ "	2"	48"	51 ¹ / ₂ "

Base Corner Door, Drawer Front, and Opening Sizes

SKU	7/16" Overlay Door	7/16" Overlay Drawer Front	Full Overlay Door	Full Overlay Door Drawer Front	Door Opening	Drawer Opening
BC36	9 ⁷ / ₈ " x 22 ⁷ / ₈ "	9 ⁷ / ₈ " x 5 ¹ / ₈ "	11 ¹ / ₂ " x 24 ¹ / ₈ "	11 ¹ / ₂ " x 5 ³ / ₄ "	9" x 22"	9" x 4 ¹ / ₂ "
BC39	9 ⁷ / ₈ " x 22 ⁷ / ₈ "	9 ⁷ / ₈ " x 5 ¹ / ₈ "	11 ¹ / ₂ " x 24 ¹ / ₈ "	11 ¹ / ₂ " x 5 ³ / ₄ "	9" x 22"	9" x 4 ¹ / ₂ "
BC42	12 ⁷ / ₈ " x 22 ⁷ / ₈ "	12 ⁷ / ₈ " x 5 ¹ / ₈ "	14 ¹ / ₂ " x 24 ¹ / ₈ "	14 ¹ / ₂ " x 5 ³ / ₄ "	12" x 22"	12" x 4 ¹ / ₂ "
BC45	15 ⁷ / ₈ " x 22 ⁷ / ₈ "	15 ⁷ / ₈ " x 5 ¹ / ₈ "	17 ¹ / ₂ " x 24 ¹ / ₈ "	17 ¹ / ₂ " x 5 ³ / ₄ "	15" x 22"	15" x 4 ¹ / ₂ "
BC48	17 ³ / ₈ " x 22 ⁷ / ₈ "	17 ³ / ₈ " x 5 ¹ / ₈ "	19" x 24 ¹ / ₈ "	19" x 5 ³ / ₄ "	16 ¹ / ₂ " x 22"	16 ¹ / ₂ " x 4 ¹ / ₂ "
BC51	18 ⁷ / ₈ " x 22 ⁷ / ₈ "	18 ⁷ / ₈ " x 5 ¹ / ₈ "	20 ¹ / ₂ " x 24 ¹ / ₈ "	20 ¹ / ₂ " x 5 ³ / ₄ "	18" x 22"	18" x 4 ¹ / ₂ "

NOTES ✓

- ▶ Adjustable 3/4" thick half depth shelf included.
- ▶ All Base Corner cabinets are reversible from left blind to right blind.
- ▶ 3" Filler is included with all Base Corner cabinets and shipped under Toekick or in cabinet. Brellin, Briarcliff II, Durham, Eastland, Overton, and Wentworth styles come with F331 and OL31.
- ▶ To ensure proper door/drawer clearance, we recommend you do not install appliances next to the blind.
- ▶ One door and one drawer.
- ▶ Cabinets are designed to use same amount of wall space designated in the sku nomenclature.
- ▶ Cover panel shipped with cabinet for field installation to cover blind opening.
- ▶ Reference Installation Charts for proper size and identification. See page 103.

Base Corner Cabinets, 35" High, 23 3/4" Deep

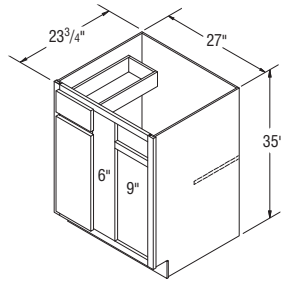

BC36

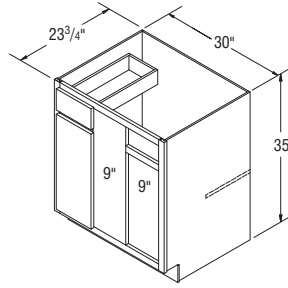

BC39

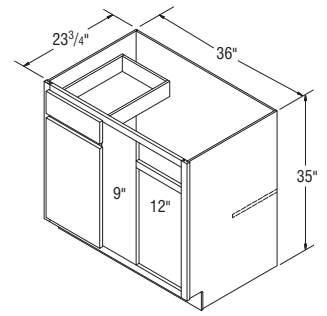

BC42

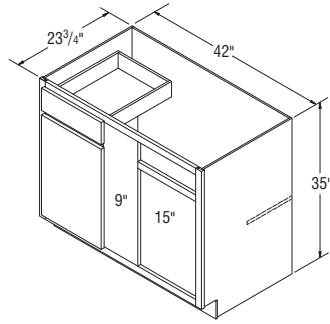

BC45

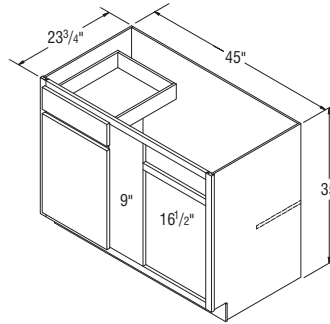

BC48

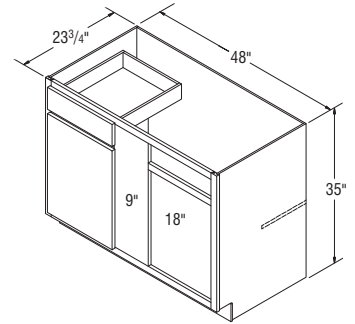

BC51

NOTES ✓

- ▶ Two doors.
- ▶ Includes 1/2" thick fixed shelf.
- ▶ Not designed for stand alone island applications.
- ▶ Standard and Select have laminate, non-matching sides.
- ▶ APC sides are unfinished.



Base End Cabinet, 35" High, 23 3/4" Deep

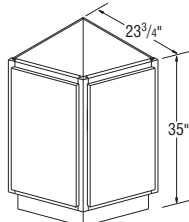

BECF24

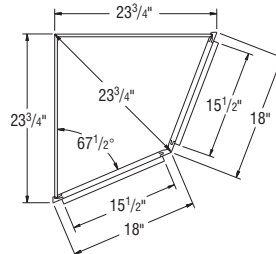

TOP VIEW

Base End Cabinet, 35" High, 12" Wide, 23 3/4" Deep

NOTES ✓

- ▶ Includes one 12" deep 3/4" thick adjustable shelf.
- ▶ 23 3/4" side is unfinished in APC only.

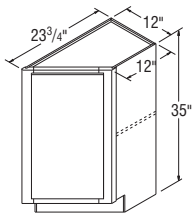

BEC12*

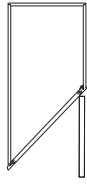

BEC12R
TOP VIEW

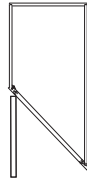

BEC12L
TOP VIEW

*L or R designation specifies 12" deep side and door hinging.

Peninsula Base Cabinets, 35" High, 23 3/4" Deep

NOTES ✓

- ▶ Reversible units with one full depth, 3/4" thick, plywood fixed shelf in all construction platforms.
- ▶ Peninsula cabinets not designed to be used as stand alone island cabinets.
- ▶ PB18 and PB24 have two doors, one drawer, and one drawer front.
- ▶ PB24DD has four doors, one drawer, and one drawer front.
- ▶ PB42-PB48 have four doors, two drawers, and two drawer fronts.
- ▶ PB30B-PB36B have four doors (two sets of butt doors), one drawer, and one drawer front.

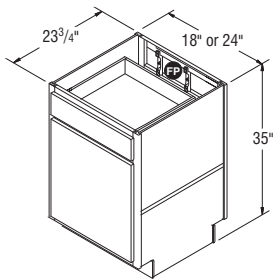

PB18
PB24

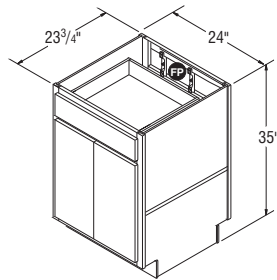

PB24DD

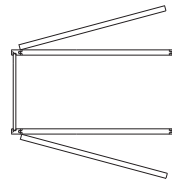

TOP VIEW

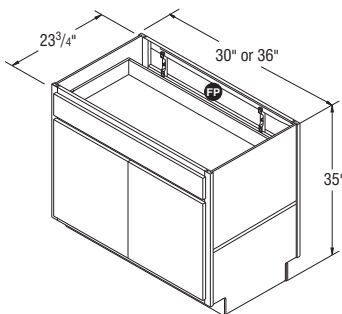

PB30B
PB36B

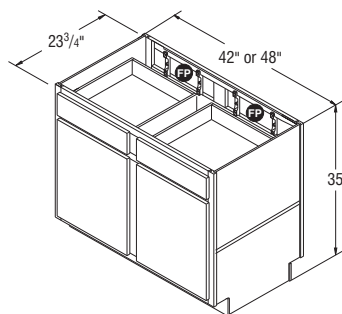

PB42
PB48

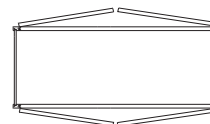

TOP VIEW

NOTES ✓

- ▶ Two doors and three drawers.
- ▶ Oven shelf support kit included.
- ▶ For OCINSTALLKIT, see page 169.
- ▶ Shelves not available on this cabinet.
- ▶ Back of cabinet scored for easy back removal if needed when oven used is deeper than cabinet can accommodate.
- ▶ Cabinet features concealed face mount hinges.

DESIGN SOLUTIONS

- ▶ Be sure to confirm a heat shield is built into your appliance by the manufacturer or install the heat shield included with your appliance.
- ▶ Oven cabinets are trimmable to accommodate a variety of appliance sizes.

Oven Cabinets, 84" High, 23 3/4" Deep

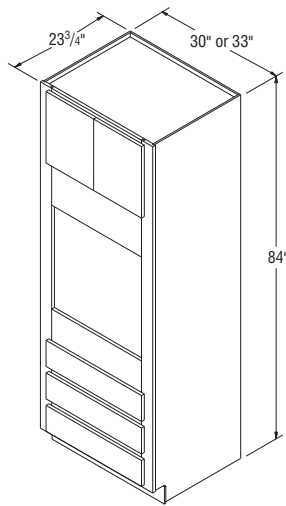

OCSD30B
OCSD33B

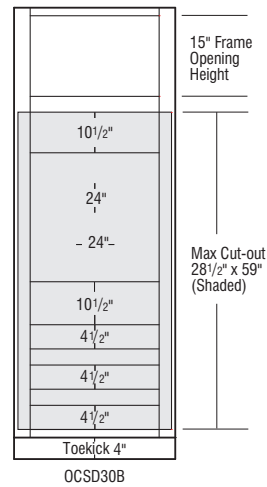

OCSD30B

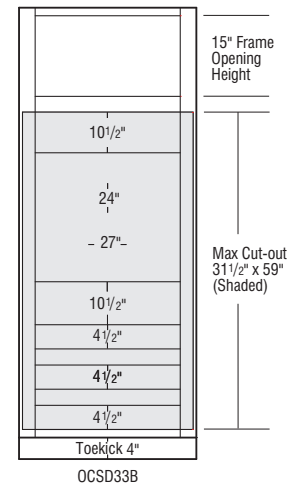

OCSD33B

NOTES ✓

- ▶ Two doors and three drawers.
- ▶ Oven shelf support kit included.
- ▶ For OCINSTALLKIT, see page 169.
- ▶ All 90" cabinets are shipped as an 86" cabinet with unfinished Loose Toe Kick Sub Assembly unattached.
- ▶ Additional material may be needed to cover unfinished Loose Toe Kick Sub Assembly.
- ▶ Shelves not available on this cabinet.
- ▶ Refer to Loose Toe Kick Sub Assembly Installation instructions for cabinet installation.
- ▶ Back of cabinet scored for easy back removal if needed when oven used is deeper than cabinet can accommodate.
- ▶ Cabinet features concealed face mount hinges.

DESIGN SOLUTIONS

- ▶ Be sure to confirm a heat shield is built into your appliance by the manufacturer or install the heat shield included with your appliance.
- ▶ Oven cabinets are trimmable to accommodate a variety of appliance sizes.

Oven Cabinets, 90" High, 23 3/4" Deep

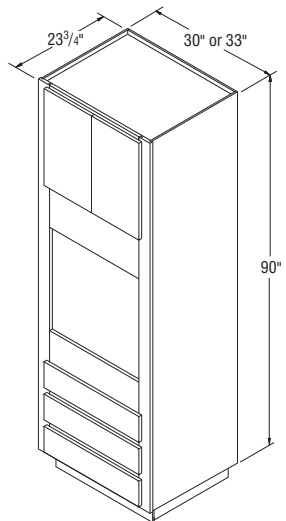

OCSD3090B
OCSD3390B

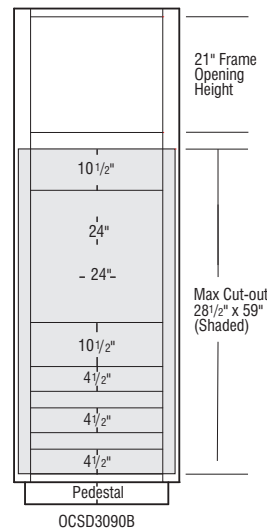

OCSD3090B

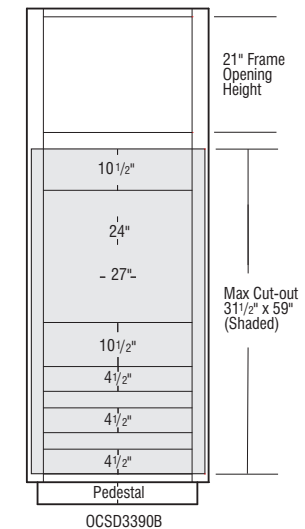

OCSD3390B

Oven Cabinets, 96" High, 23 3/4" Deep

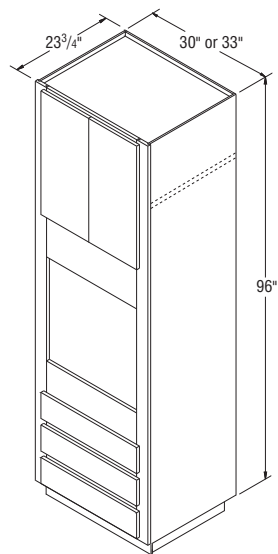

OCSD3096B
OCSD3396B

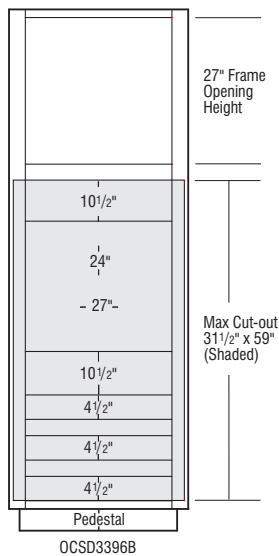
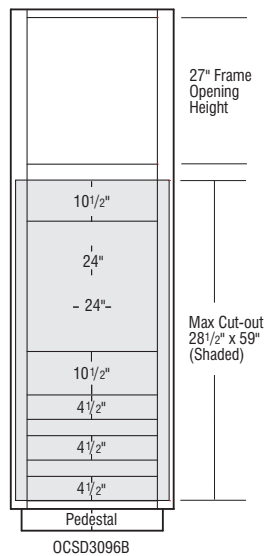

NOTES ✓

- ▶ Two doors, one adjustable shelf, and three drawers.
- ▶ Oven shelf support kit included.
- ▶ For OCINSTALLKIT, see page 169.
- ▶ All 96" cabinets are shipped as a 92" cabinet with unfinished Loose Toekick Sub Assembly unattached.
- ▶ Additional material may be needed to cover unfinished Loose Toekick Sub Assembly.
- ▶ Refer to Loose Toekick Sub Assembly Installation instructions for cabinet installation.
- ▶ Back of cabinet scored for easy back removal if needed when oven used is deeper than cabinet can accommodate.
- ▶ Cabinet features concealed face mount hinges.

DESIGN SOLUTIONS

- ▶ Be sure to confirm a heat shield is built into your appliance by the manufacturer or install the heat shield included with your appliance.
- ▶ Oven cabinets are trimmable to accommodate a variety of appliance sizes.

Oven Cabinets Double, 84" High, 23 3/4" Deep

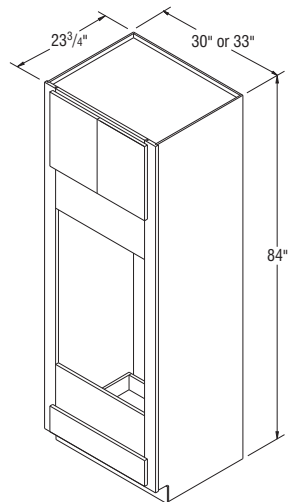

OD30B
OD33B

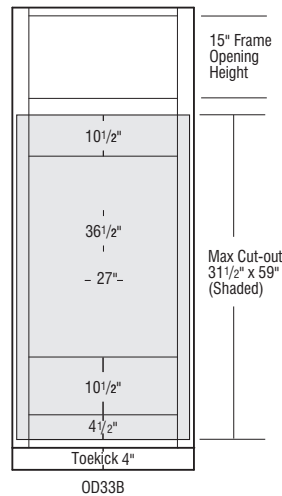
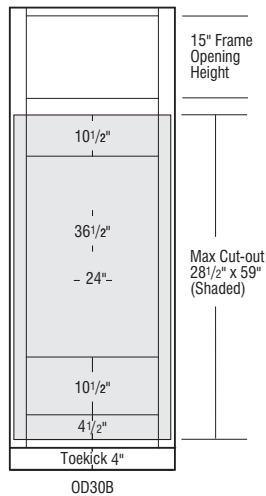

NOTES ✓

- ▶ Two doors and one drawer.
- ▶ Oven shelf support kit included.
- ▶ For OCINSTALLKIT, see page 169.
- ▶ Back of cabinet scored for easy back removal if needed when oven used is deeper than cabinet can accommodate.
- ▶ Cabinet features concealed face mount hinges.

DESIGN SOLUTIONS

- ▶ Be sure to confirm a heat shield is built into your appliance by the manufacturer or install the heat shield included with your appliance.
- ▶ Oven cabinets are trimmable to accommodate a variety of appliance sizes.

NOTES ✓

- ▶ Two doors and one drawer.
- ▶ Oven shelf support kit included.
- ▶ For OCINSTALLKIT, see page 169.
- ▶ All 90" cabinets are shipped as an 86" cabinet with unfinished Loose Toekick Sub Assembly unattached.
- ▶ Additional material may be needed to cover unfinished Loose Toekick Sub Assembly.
- ▶ Refer to Loose Toekick Sub Assembly Installation instructions for cabinet installation.
- ▶ Back of cabinet scored for easy back removal if needed when oven used is deeper than cabinet can accommodate.
- ▶ Cabinet features concealed face mount hinges.

DESIGN SOLUTIONS

- ▶ Be sure to confirm a heat shield is built into your appliance by the manufacturer or install the heat shield included with your appliance.
- ▶ Oven cabinets are trimmable to accommodate a variety of appliance sizes.

Oven Cabinets Double, 90" High, 23 3/4" Deep

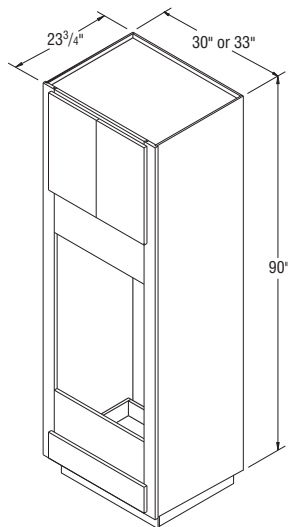

OD3090B
OD3390B

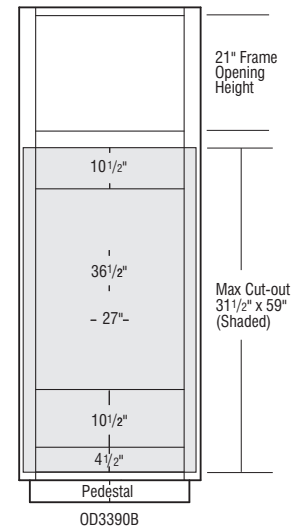
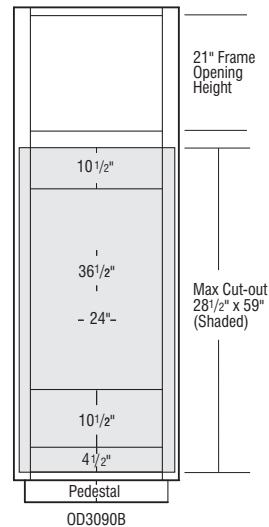

NOTES ✓

- ▶ Two doors, one adjustable shelf, and one drawer.
- ▶ Oven shelf support kit included.
- ▶ For OCINSTALLKIT, see page 169.
- ▶ All 96" cabinets are shipped as a 92" cabinet with unfinished Loose Toekick Sub Assembly unattached.
- ▶ Additional material may be needed to cover unfinished Loose Toekick Sub Assembly.
- ▶ Refer to Loose Toekick Sub Assembly Installation instructions for cabinet installation.
- ▶ Back of cabinet scored for easy back removal if needed when oven used is deeper than cabinet can accommodate.
- ▶ Cabinet features concealed face mount hinges.

DESIGN SOLUTIONS

- ▶ Be sure to confirm a heat shield is built into your appliance by the manufacturer or install the heat shield included with your appliance.
- ▶ Oven cabinets are trimmable to accommodate a variety of appliance sizes.

Oven Cabinets Double, 96" High, 23 3/4" Deep

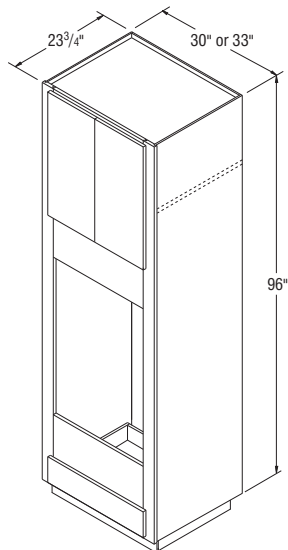

OD3096B
OD3396B

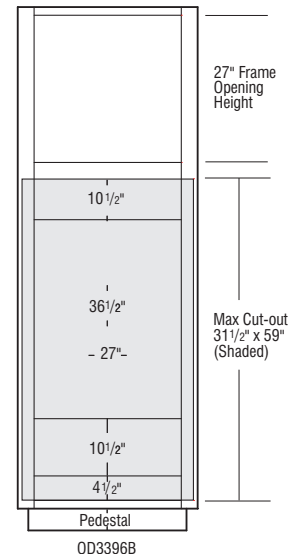
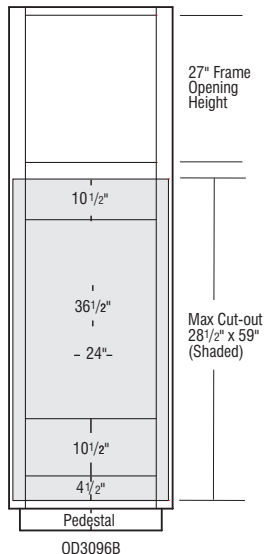

Microwave Cabinets, 84" High, 23 3/4" Deep

NOTES ✓

- ▶ Two doors above microwave, one drawer and two doors below microwave.
- ▶ Back of cabinet scored for easy back removal if needed when oven used is deeper than cabinet can accommodate.
- ▶ Drawer aligns with a standard 35" high Base cabinet.
- ▶ Upper doors align with a 24" high Wall Cabinet.

DESIGN SOLUTIONS

- ▶ Be sure to confirm a heat shield is built into your appliance by the manufacturer or install the heat shield included with your appliance.
- ▶ Microwave cabinets are trimmable to accommodate a variety of appliance sizes.

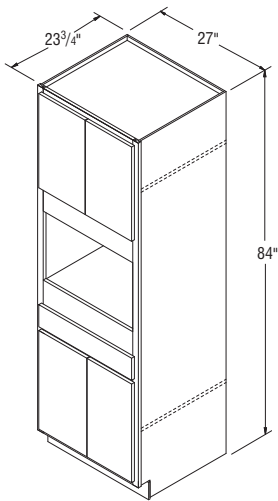

TMW27B

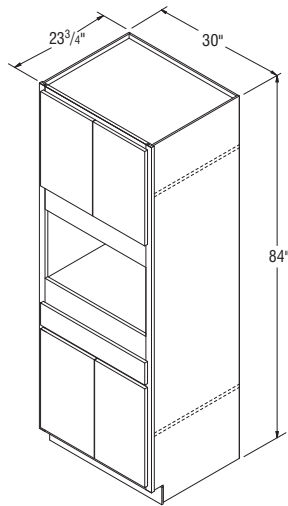

TMW30B

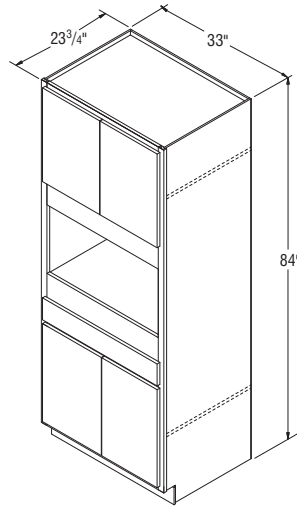

TMW33B

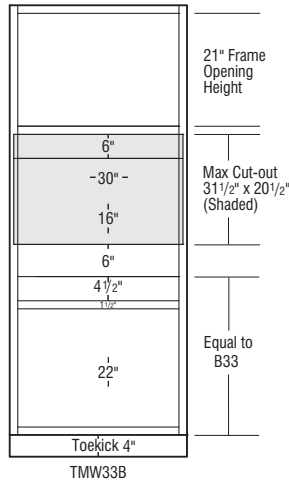
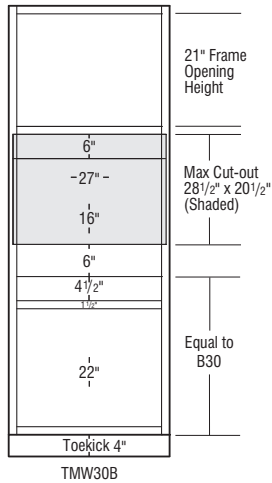
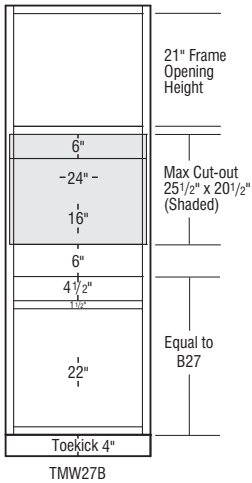

NOTES ✓

- ▶ Two doors above microwave, one drawer and two doors below microwave.
- ▶ All 90" cabinets are shipped as an 86" cabinet with unfinished Loose Toekick Sub Assembly unattached.
- ▶ Additional material may be needed to cover unfinished Loose Toekick Sub Assembly.
- ▶ Refer to Loose Toekick Sub Assembly Installation instructions for cabinet installation.
- ▶ Back of cabinet scored for easy back removal if needed when oven used is deeper than cabinet can accommodate.
- ▶ Drawer aligns with a standard 35" high Base cabinet.
- ▶ Upper doors align with a 24" high Wall Cabinet.

DESIGN SOLUTIONS

- ▶ Be sure to confirm a heat shield is built into your appliance by the manufacturer or install the heat shield included with your appliance.
- ▶ Microwave cabinets are trimmable to accommodate a variety of appliance sizes.

Microwave Cabinets, 90" High, 23 3/4" Deep

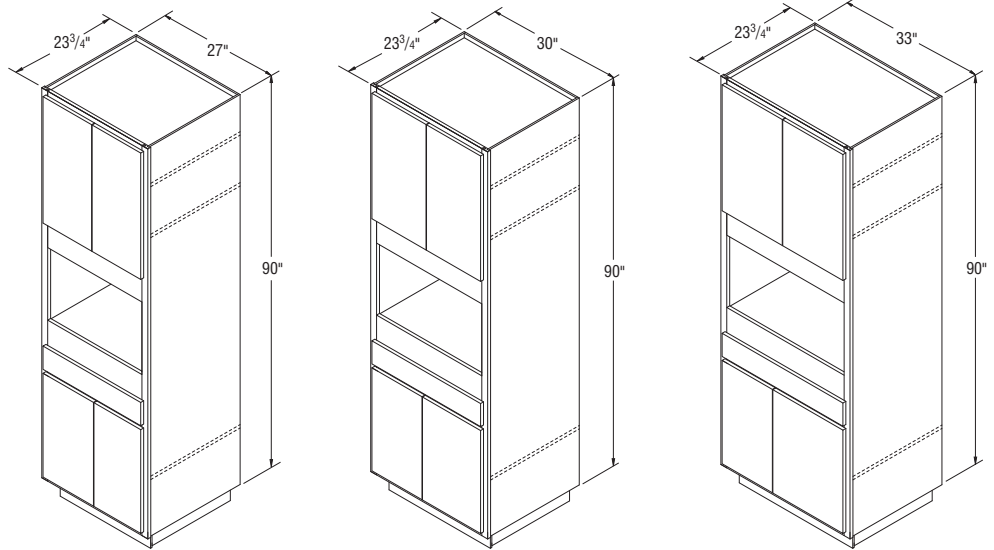

TMW2790B

TMW3090B

TMW3390B

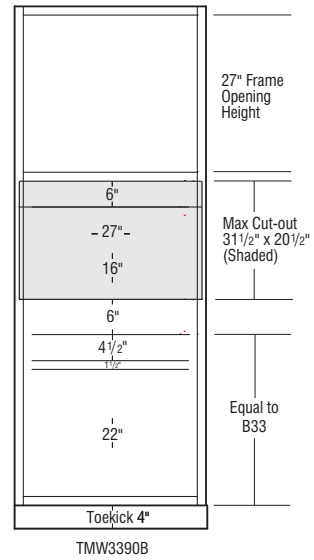
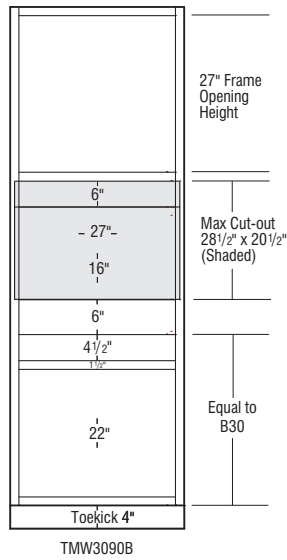
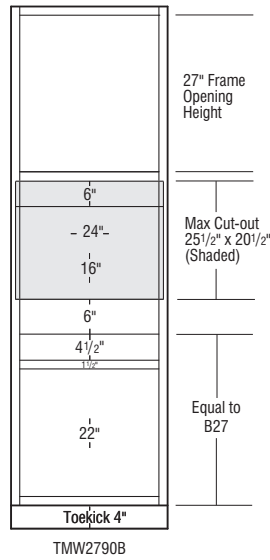

Microwave Cabinets, 96" High, 23 3/4" Deep

NOTES

- ▶ Two doors above microwave, one drawer and two doors below microwave.
- ▶ All 96" cabinets are shipped as an 92" cabinet with unfinished Loose Toekick Sub Assembly unattached.
- ▶ Additional material may be needed to cover unfinished Loose Toekick Sub Assembly.
- ▶ Refer to Loose Toekick Sub Assembly Installation instructions for cabinet installation.
- ▶ Back of cabinet scored for easy back removal if needed when oven used is deeper than cabinet can accommodate.
- ▶ Drawer aligns with a standard 35" high Base cabinet.
- ▶ Upper doors align with a 24" high Wall Cabinet.

DESIGN SOLUTIONS

- ▶ Be sure to confirm a heat shield is built into your appliance by the manufacturer or install the heat shield included with your appliance.
- ▶ Microwave cabinets are trimmable to accommodate a variety of appliance sizes.

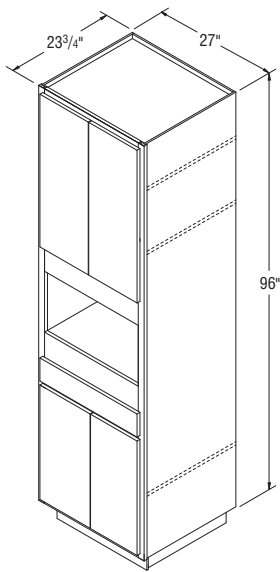

TMW2796B

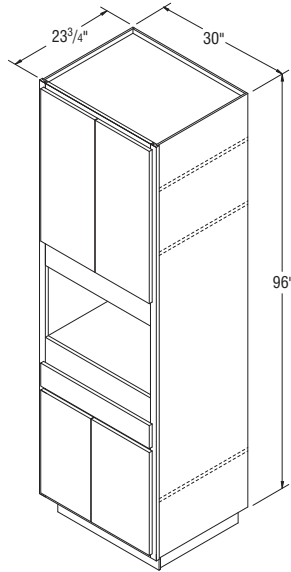

TMW3096B

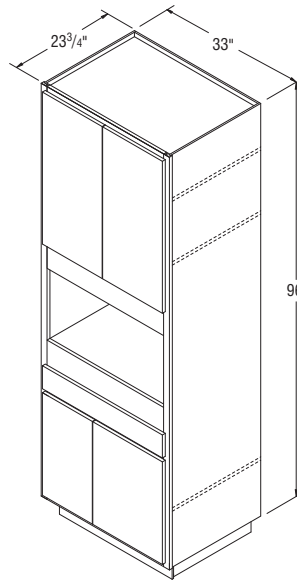

TMW3396B

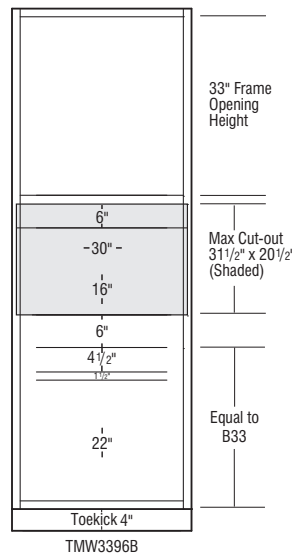
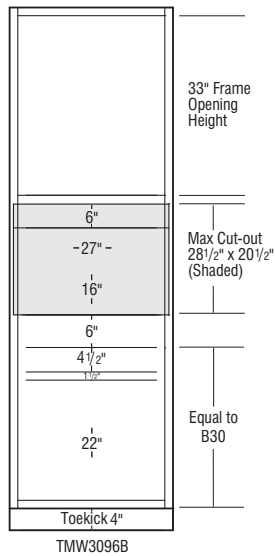
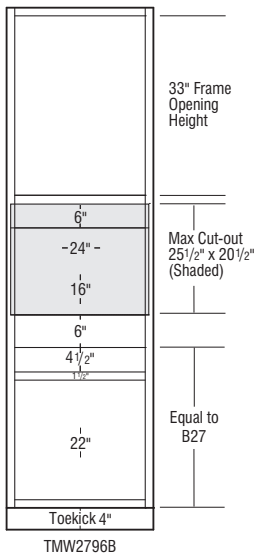

NOTES ✓

- ▶ Two doors above the microwave and one deep drawer below the oven.
- ▶ Oven shelf support kit included.
- ▶ Back of cabinet scored for easy back removal if needed when oven used is deeper than cabinet can accommodate.

DESIGN SOLUTIONS

- ▶ Be sure to confirm a heat shield is built into your appliance by the manufacturer or install the heat shield included with your appliance.
- ▶ Oven cabinets are trimmable to accommodate a variety of appliance sizes.

Oven with Microwave Cabinets, 84" High, 23 3/4" Deep

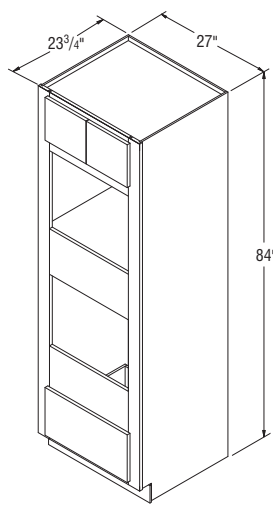

OMS27DDB

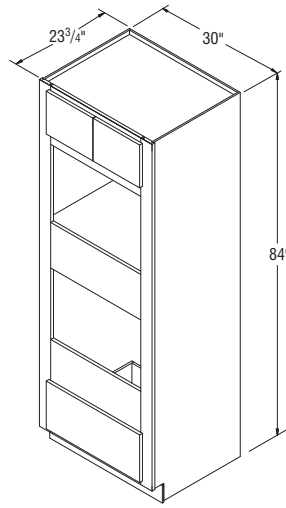

OMS30DDB

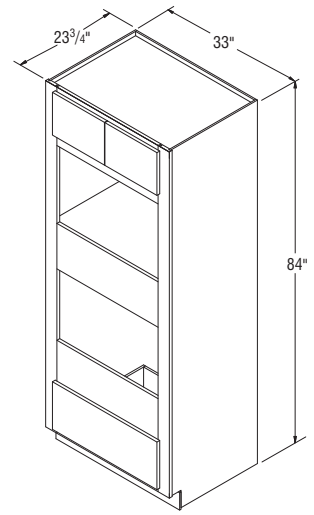

OMS33DDB

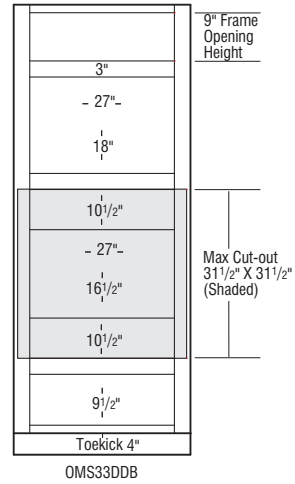
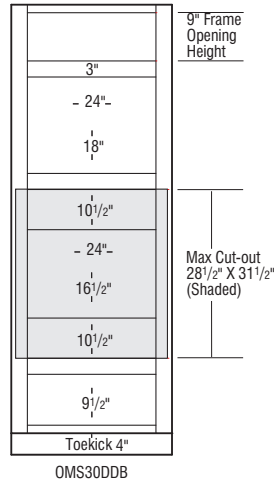
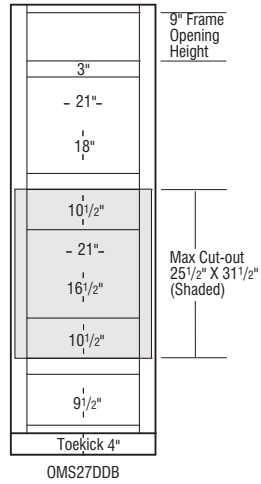

Oven with Microwave Cabinets, 90" High, 23 3/4" Deep

NOTES ✓

- ▶ Two doors above microwave, one deep drawer below oven.
- ▶ Oven shelf support kit included.
- ▶ All 90" cabinets are shipped as an 86" cabinet with unfinished Loose Toekick Sub Assembly unattached.
- ▶ Additional material may be needed to cover unfinished Loose Toekick Sub Assembly.
- ▶ Refer to Loose Toekick Sub Assembly Installation instructions for cabinet installation.
- ▶ Back of cabinet scored for easy back removal if needed when oven used is deeper than cabinet can accommodate.

DESIGN SOLUTIONS

- ▶ Be sure to confirm a heat shield is built into your appliance by the manufacturer or install the heat shield included with your appliance.
- ▶ Oven cabinets are trimmable to accommodate a variety of appliance sizes.

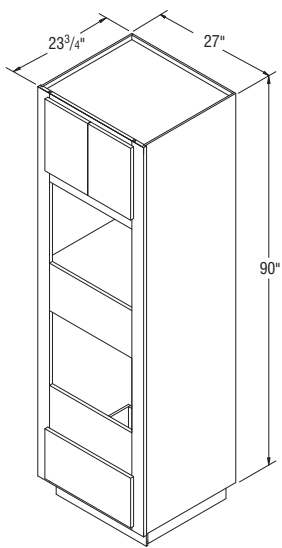

OMS2790DDB

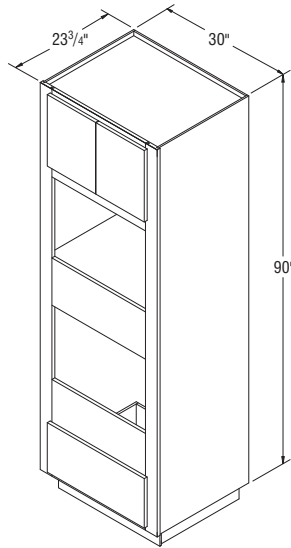

OMS3090DDB

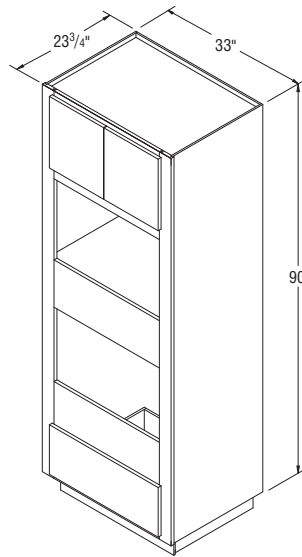

OMS3390DDB

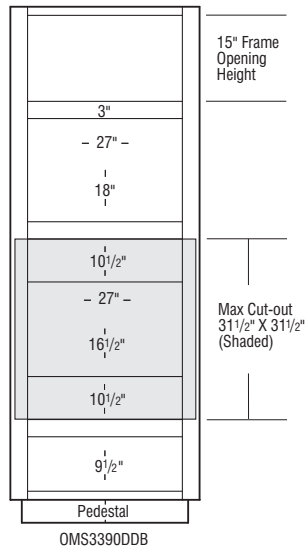
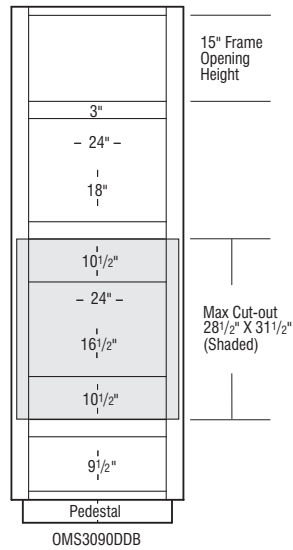
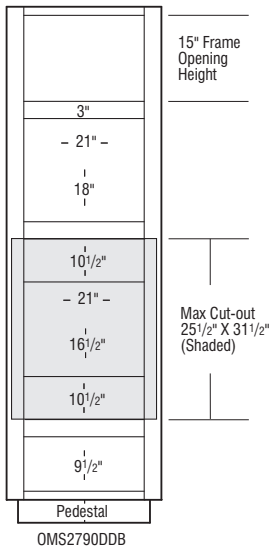

NOTES ✓

- ▶ Two doors above microwave, one deep drawer below oven.
- ▶ Oven shelf support kit included.
- ▶ All 96" cabinets are shipped as an 92" cabinet with unfinished Loose Toekick Sub Assembly unattached.
- ▶ Additional material may be needed to cover unfinished Loose Toekick Sub Assembly.
- ▶ Refer to Loose Toekick Sub Assembly Installation instructions for cabinet installation.
- ▶ Back of cabinet scored for easy back removal if needed when oven used is deeper than cabinet can accommodate.

DESIGN SOLUTIONS

- ▶ Be sure to confirm a heat shield is built into your appliance by the manufacturer or install the heat shield included with your appliance.
- ▶ Oven cabinets are trimmable to accommodate a variety of appliance sizes.

Oven with Microwave Cabinets, 96" High, 23 3/4" Deep

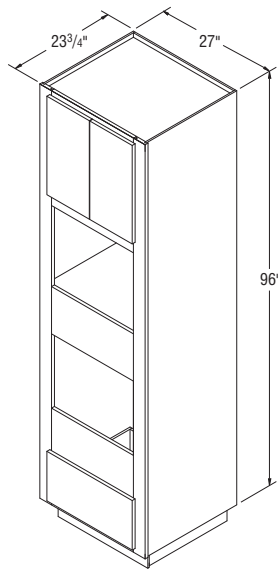

OMS2796DDB

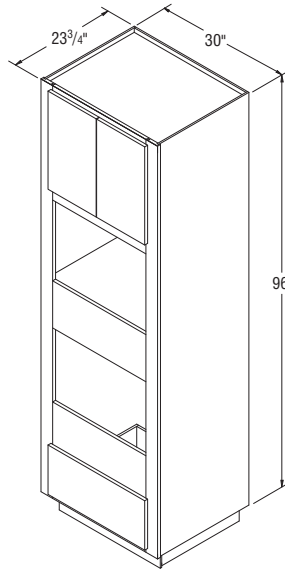

OMS3096DDB

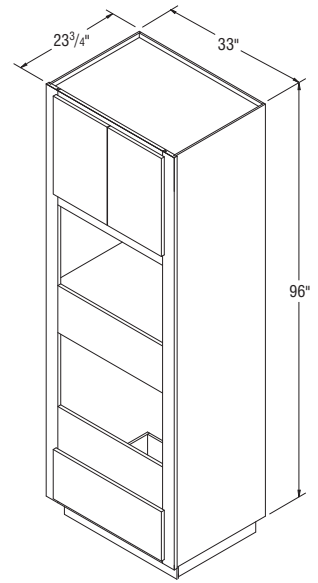

OMS3396DDB

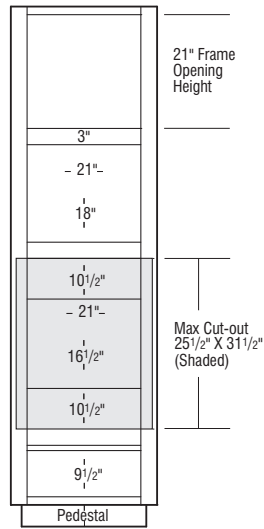

OMS2796DDB

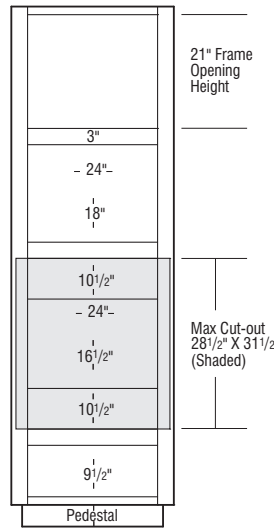

OMS3096DDB

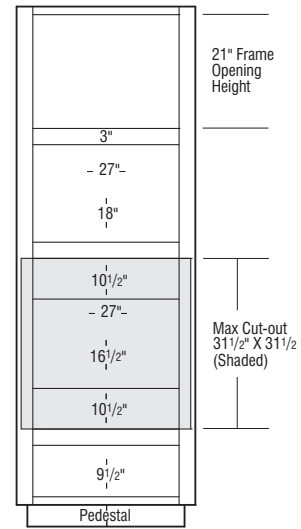

OMS3396DDB

Pantry SuperCabinets™, 84" High, 23 3/4" Deep

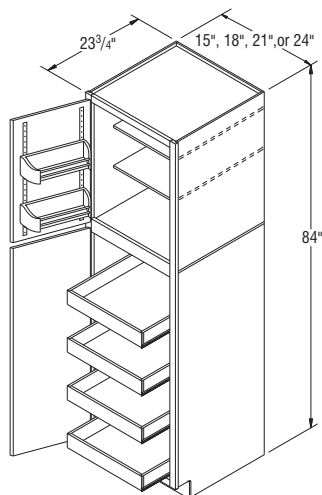

PSC15*
PSC18*
PSC21*
PSC24*

*Specify L or R on all single door Pantry SuperCabinets.

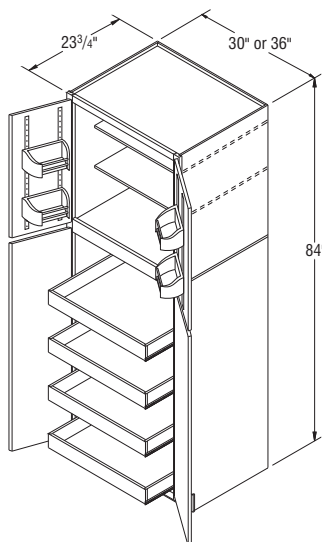

PSC30B
PSC36B

NOTES ✓

- ▶ Two reduced depth 3/4" thick adjustable shelves in top section.
- ▶ Each upper door features two adjustable height door racks.
- ▶ Four adjustable height Roll Trays in bottom section.
- ▶ Upgrade charges do not include Roll Trays.
- ▶ Large openings on miter styles will be two doors doweled together.
- ▶ Refer to the Cabinet Specifications Section for door opening dimensions.
- ▶ Smart Stop™ drawer guides are not available on Roll Trays in Select and APC Construction.



Pantry SuperCabinets™, 90" High, 23 3/4" Deep

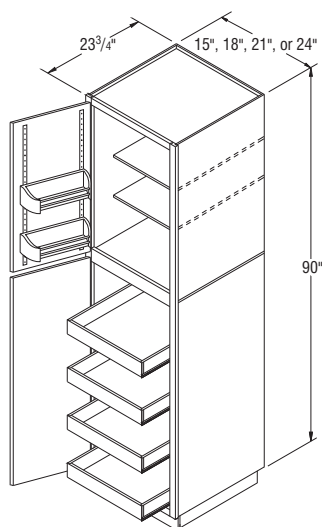

PSC1590*
PSC1890*
PSC2190*
PSC2490*

*Specify L or R on all single door Pantry SuperCabinets.

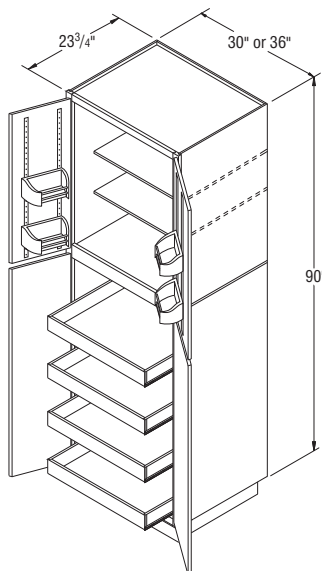

PSC3090B
PSC3690B

NOTES ✓

- ▶ Two reduced depth 3/4" thick adjustable shelves in top section.
- ▶ Each upper door features two adjustable height door racks.
- ▶ Four adjustable height Roll Trays in bottom section.
- ▶ Upgrade charges do not include Roll Trays.
- ▶ Large openings on miter styles will be two doors doweled together.
- ▶ All 90" Pantry SuperCabinets™ are shipped as a 86" cabinet with unfinished Loose Toekick Sub Assembly.
- ▶ Additional material may be needed to cover unfinished Loose Toekick Sub Assembly
- ▶ Refer to the Cabinet Specifications Section for door opening dimensions.
- ▶ Refer to Loose Toekick Sub Assembly Installation instructions for cabinet installation.
- ▶ Smart Stop™ drawer guides are not available on Roll Trays in Select and APC Construction.



NOTES ✓

- ▶ Two reduced depth $\frac{3}{4}$ " thick adjustable shelves in top section.
- ▶ Each upper door features two adjustable height door racks.
- ▶ Four adjustable height Roll Trays in bottom section.
- ▶ Upgrade charges do not include Roll Trays.
- ▶ Large openings on miter styles will be two doors doweled together.
- ▶ All 96" Pantry SuperCabinets™ are shipped as a 92" cabinet with unfinished Loose Toekick Sub Assembly.
- ▶ Additional material may be needed to cover unfinished Loose Toekick Sub Assembly.
- ▶ Refer to the Cabinet Specifications Section for door opening dimensions.
- ▶ Refer to Loose Toekick Sub Assembly Installation instructions for cabinet installation.
- ▶ Smart Stop™ drawer guides are not available on Roll Trays in Select and APC Construction.

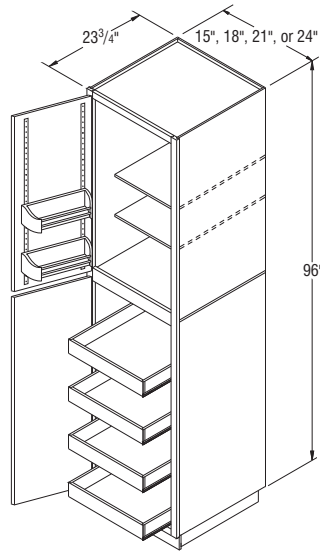
Pantry SuperCabinets™, 96" High, 23 $\frac{3}{4}$ " Deep

PSC1596*
PSC1896*
PSC2196*
PSC2496*

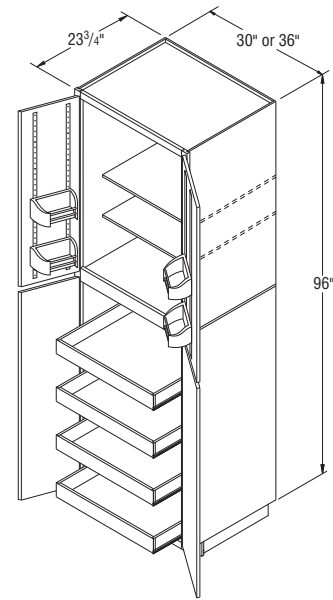

PSC3096B
PSC3696B

*Specify L or R on all single door Pantry SuperCabinets.

Utility Cabinets, 84" High, 12" and 23 3/4" Deep

NOTES ✓

- ▶ 84" high Utility cabinets include one fixed shelf between doors.
- ▶ Large openings on miter styles will be two doors doweled together.
- ▶ Shelves not included in Utility cabinets. For shelf and Roll Tray options see pages 170-171.
- ▶ Refer to the Cabinet Specifications Section for door opening dimensions.

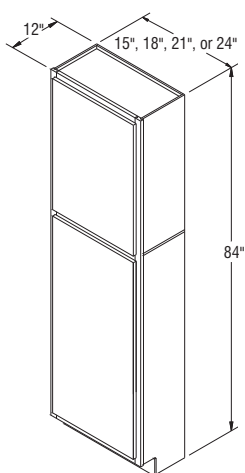

U1512*
U1812*
U2112*
U2412*

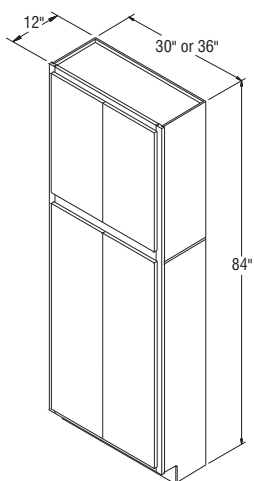

U3012B
U3612B

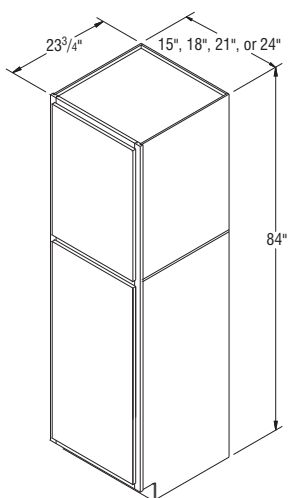

U15*
U18*
U21*
U24*

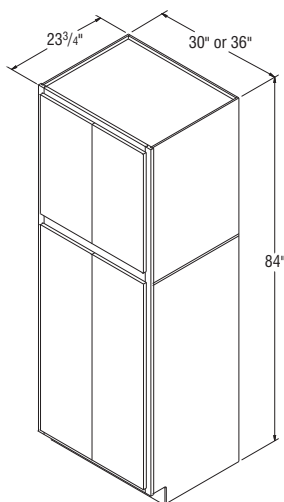

U30B
U36B

*Specify L or R on all single door Utility Cabinets.

NOTES ✓

- ▶ 90" high Utility cabinets include one fixed shelf between doors.
- ▶ Large openings on miter styles will be two doors doweled together.
- ▶ Shelves not included in Utility cabinets. For shelf and Roll Tray options see pages 170-171.
- ▶ All 90" high Utility cabinets are shipped as an 86" cabinet with unfinished Loose Toekick Sub Assembly.
- ▶ Additional material may be needed to cover unfinished Loose Toekick Sub Assembly.
- ▶ Refer to the Cabinet Specifications Section for door opening dimensions.
- ▶ Refer to Loose Toekick Sub Assembly Installation instructions for cabinet installation.



Utility Cabinets, 90" High, 12" and 23 3/4" Deep

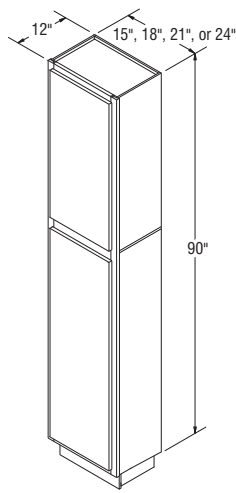

U159012*
U189012*
U219012*
U249012*

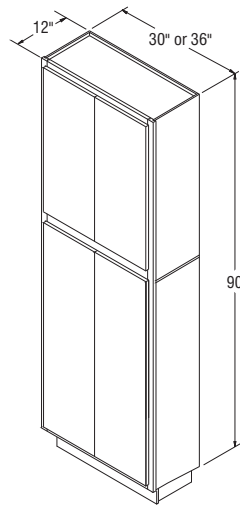

U309012B
U369012B

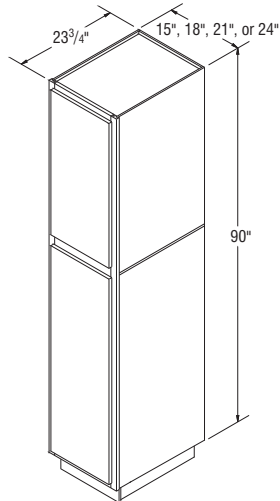

U1590*
U1890*
U2190*
U2490*

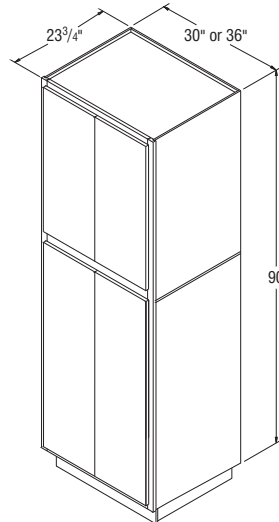

U3090B
U3690B

*Specify L or R on all single door Utility Cabinets.

Utility Cabinets, 96" High, 12" and 23 3/4" Deep

NOTES ✓

- ▶ 96" high Utility cabinets include one fixed shelf between doors.
- ▶ Large openings on miter styles will be two doors doweled together.
- ▶ Shelves not included in Utility cabinets. For shelf and Roll Tray options see pages 170-171.
- ▶ All 96" Utility cabinets are shipped as a 92" cabinet with unfinished Loose Toekick Sub Assembly.
- ▶ Additional material may be needed to cover unfinished Loose Toekick Sub Assembly.
- ▶ Refer to the Cabinet Specifications Section for door opening dimensions.
- ▶ Refer to Loose Toekick Sub Assembly instructions for cabinet installation.

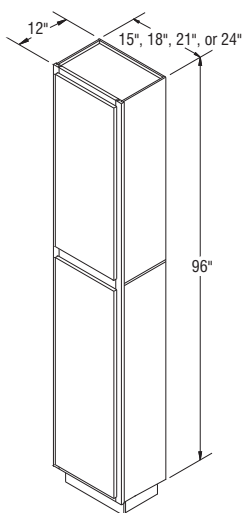

U159612*
U189612*
U219612*
U249612*

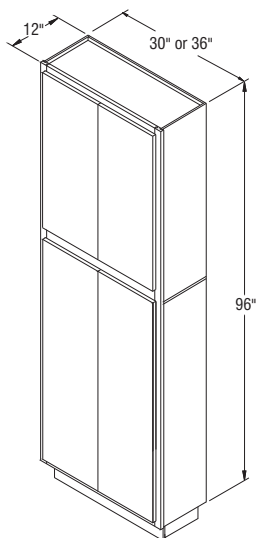

U309612B
U369612B

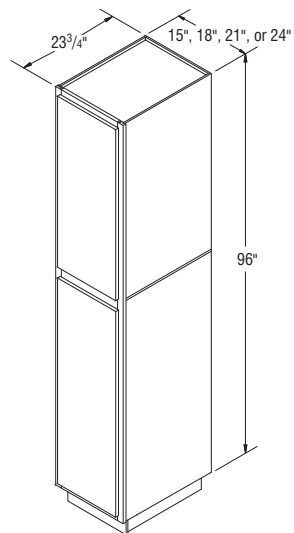

U1596*
U1896*
U2196*
U2496*

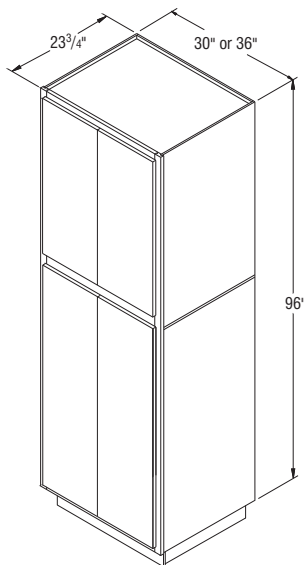

U3096B
U3696B

*Specify L or R on all single door Utility Cabinets.

NOTES ✓

- ▶ Includes three $\frac{3}{4}$ " thick matching Aristex™ shelves.
- ▶ Matching Aristex™ interior.
- ▶ Designed to mount on the Bookcase Base cabinet with countertop.
- ▶ For loads on shelves over 60 lbs., Aristokraft recommends the use of the Bookshelf Kit on page 165.

Bookcases, 52 1/2" High, 12" Deep

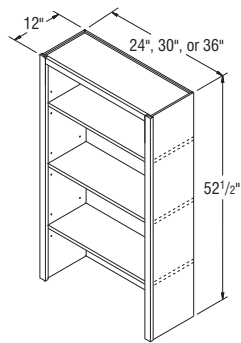

BK2452.5
BK3052.5
BK3652.5

NOTES ✓

- ▶ Includes four $\frac{3}{4}$ " thick matching Aristex™ shelves.
- ▶ Matching Aristex™ interior.
- ▶ Designed to mount on the Bookcase Base cabinet with countertop.
- ▶ For loads on shelves over 60 lbs., Aristokraft recommends the use of the Bookshelf Kit on page 165.

Bookcases, 64 1/2" High, 12" Deep

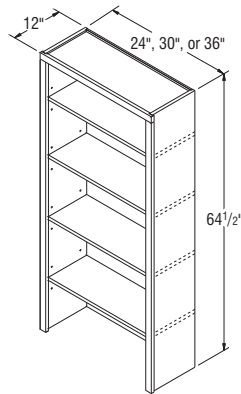

BK2464.5
BK3064.5
BK3664.5

NOTES ✓

- ▶ Includes five $\frac{3}{4}$ " thick matching Aristex™ shelves — four adjustable and one fixed center shelf.
- ▶ Matching Aristex™ interior.
- ▶ Wide bottom rail.
- ▶ For loads on shelves over 60 lbs., Aristokraft recommends the use of the bookshelf Kit on page 165.

Bookcases, 84" High, 12" Deep

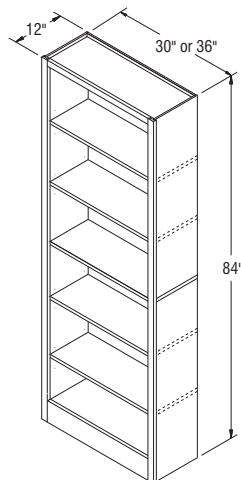

BK3084
BK3684

Bookcase Bases, 30" High, 21" Deep

NOTES ✓

- ▶ Includes one $\frac{3}{4}$ " thick full depth adjustable shelf.
- ▶ Matching Aristex™ interior.
- ▶ Does not include countertop.

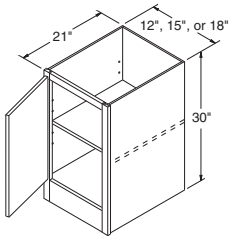

BKB1230
BKB1530
BKB1830

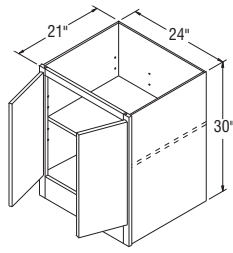

BKB2430

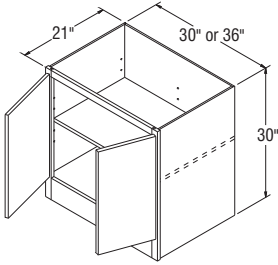

BKB3030B
BKB3630B

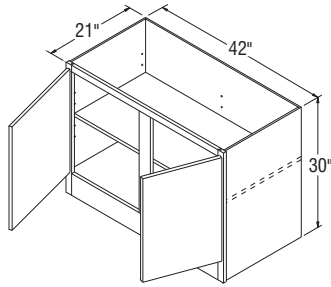

BKB4230

Vanity File Drawer Base, 30" High, 18" Wide, 21" Deep

NOTES ✓

- ▶ Includes two full height drawers with Full extension guides for all construction options.
- ▶ Includes hanging file system for folders, sent uninstalled.
- ▶ Includes wide bottom rail, no recessed Toekick.
- ▶ It is recommended that this unit be fastened to the wall when installing.
- ▶ Interior dimension for Standard Construction file drawer is $12\frac{31}{32}$ " W x 19" D x $9\frac{5}{8}$ " H.
- ▶ Interior dimension for Select and All-plywood Construction dovetail file drawer is $12\frac{2}{8}$ " W x $16\frac{5}{8}$ " D x $9\frac{1}{4}$ " H.
- ▶ Standard Construction accommodates side-to-side filing of letter documents and side-to-side filing of legal documents. Drawer width will not permit front-to-back filing of legal documents.
- ▶ Select and All-plywood Construction accommodates side-to-side filing of legal and letter documents.
- ▶ Drawer fronts will utilize raised panels on applicable styles.
- ▶ Smart Stop™ drawer guides are not available in Select and APC Construction.

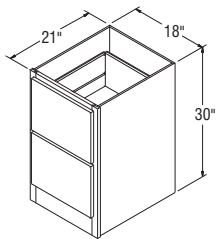

VFDB18

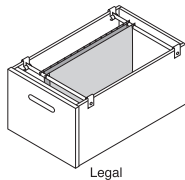

Legal

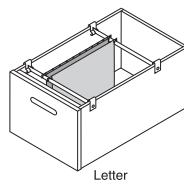

Letter

Standard/Select & APC



NOTES ✓

- ▶ The bottom drawer is deep for standard letter and legal documents and includes two hanging rods.
- ▶ Bottom file drawer has ¾ extension guides.
- ▶ Interior dimension for standard file drawer is:
VFD18 – 12³¹/₃₂" W x 19" D x 9⁵/₈" H.
VFD21 – 15³¹/₃₂" W x 19" D x 9⁵/₈" H.
- ▶ Raised panel styles - drawer fronts will convert to raised panel;
Full overlay - 10¹/₄" or higher
Partial overlay - 9⁷/₈" or higher



Vanity File Drawers, 30" High, 21" Deep

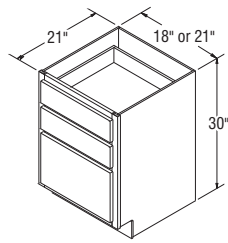

**VFD18
VFD21**

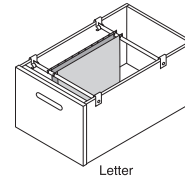
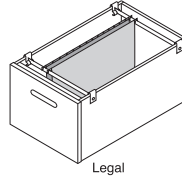

Standard/Select & APC

NOTES ✓

- ▶ Includes one adjustable ¾" thick half depth shelf.
- ▶ VB24 has butt doors on all door styles.

Vanity Bases, 30" High, 21" Deep

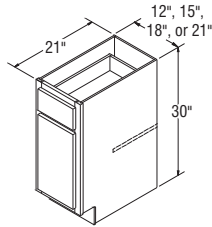

**VB12
VB15
VB18
VB21**

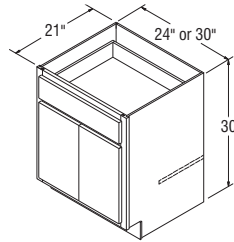

**VB24
VB30B**

NOTES ✓

- ▶ Raised panel styles - drawer fronts will convert to raised panel;
Full overlay - 10¹/₄" or higher
Partial overlay - 9⁷/₈" or higher

Vanity Three Drawer Bases, 30" High, 21" Deep

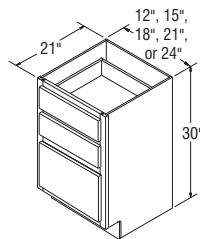

**VDB12
VDB15
VDB18
VDB21
VDB24**

Vanity Bases, 30" High, 18" Deep

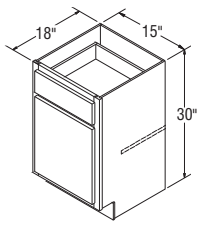

VB1518

NOTES ✓

- ▶ Includes one adjustable $\frac{3}{4}$ " thick half depth shelf.
- ▶ 18" deep Vanities available in Standard construction only.

Vanity Sink Bases, 30" High, 18" Deep

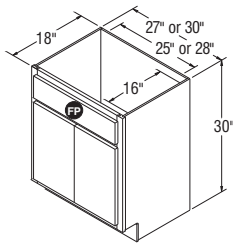

VSB2718B
VSB3018B

NOTES ✓

- ▶ FP = False Panel.
- ▶ It may be necessary to modify the corner braces/stretcher rails with some sink applications.
- ▶ 18" deep Vanities available in Standard Construction only.
- ▶ Vanity interiors are not drilled for shelf clip holes, nor do they include a shelf.

Kneespace Drawers, 4 3/4" High, 21" Deep (Trimmable)

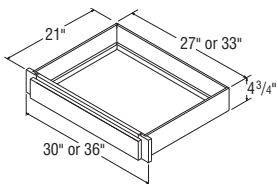

KDT30
KDT36

NOTES ✓

- ▶ Face frame trimmable 3" overall, $1\frac{1}{2}$ " on each side.
- ▶ Shallow depth drawer.
- ▶ Briarcliff II and Wentworth have a slab drawer front.
- ▶ 5-piece drawers not available.

NOTES ✓

- ▶ FP = False Panel.
- ▶ It may be necessary to modify the corner braces/stretcher rails with some sink applications.
- ▶ Vanity interiors are not drilled for shelf clip holes, nor do they include a shelf.

Vanity Console Bases, 32 1/2" High, 21" Deep

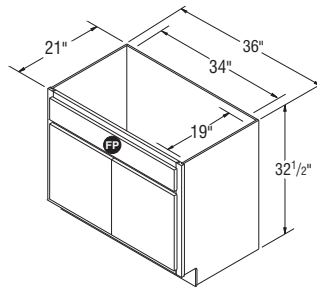

VCB3632.5B

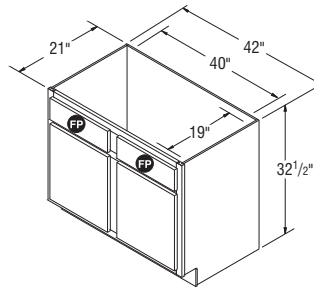

VCB4232.5

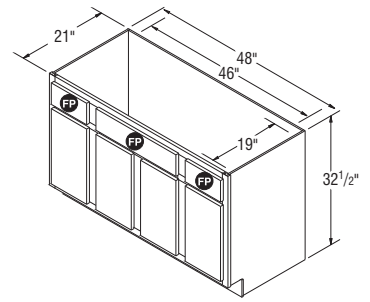

VCB4832.5

NOTES ✓

- ▶ FP = False Panel.
- ▶ It may be necessary to modify the corner braces/stretcher rails with some sink applications.
- ▶ Vanity interiors are not drilled for shelf clip holes, nor do they include a shelf.

Vanity Console Bases, 35" High, 21" Deep

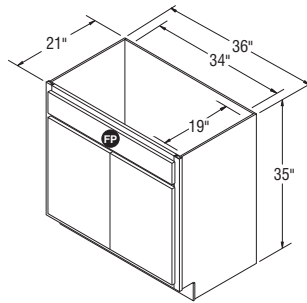

VCB3635B

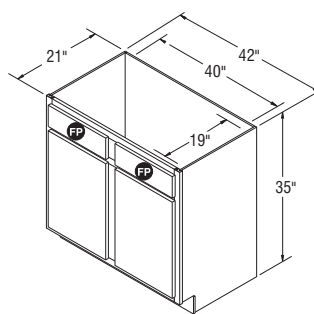

VCB4235

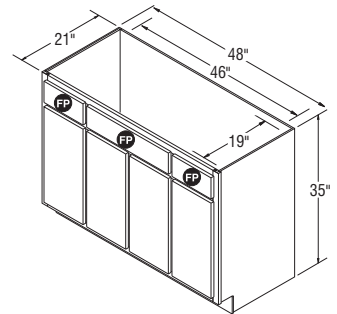

VCB4835

NOTES ✓

- ▶ Includes one adjustable 3/4" thick half depth shelf.
- ▶ VB2432.518 are butt door only in all styles.
- ▶ 18" deep Vanities available in Standard construction only.

Vanity Bases, 32 1/2" High, 18" Deep

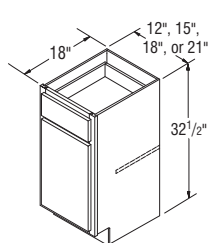

VB1232.518
VB1532.518
VB1832.518
VB2132.518

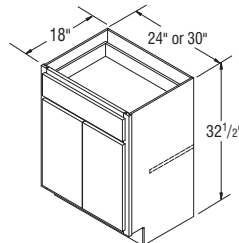

VB2432.518
VB3032.518B

Vanity Bases, 32 1/2" High, 21" Deep

NOTES ✓

- ▶ Includes one adjustable 3/4" thick half depth shelf.

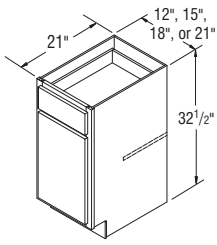

VB1232.5
VB1532.5
VB1832.5
VB2132.5

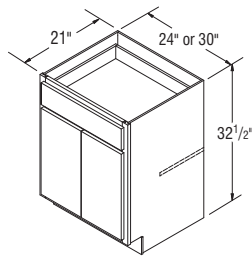

VB2432.5
VB3032.5B

Vanity Bases Full Height Doors, 32 1/2" High, 21" Deep

NOTES ✓

- ▶ Includes one adjustable 3/4" thick half depth shelf.
- ▶ VB2432.5FH has butt doors on all door styles.

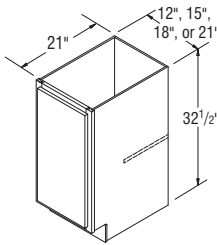

VB1232.5FH
VB1532.5FH
VB1832.5FH
VB2132.5FH

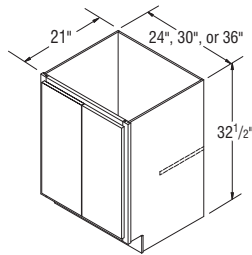

VB2432.5FH
VB3032.5FHB
VB3332.5FHB
VB3632.5FHB

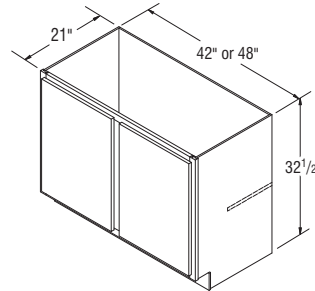

VB4232.5FH
VB4832.5FH

Vanity Bases, 35" High, 21" Deep

NOTES ✓

- ▶ Includes one adjustable 3/4" thick half depth shelf.
- ▶ VB2435 has butt doors on all door styles.

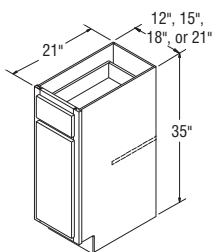

VB1235
VB1535
VB1835
VB2135

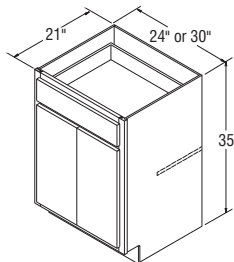

VB2435
VB3035B

NOTES ✓

- ▶ Includes one adjustable 3/4" thick half depth shelf.
- ▶ VB2435FH has butt doors on all door styles.

Vanity Bases Full Height Doors, 35" High, 21" Deep

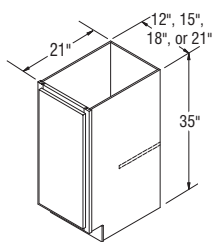

**VB1235FH
VB1535FH
VB1835FH
VB2135FH**

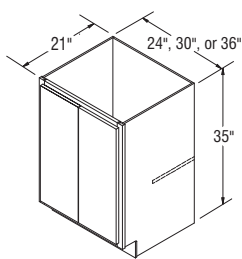

**VB2435FH
VB3035FHB
VB3635FHB**

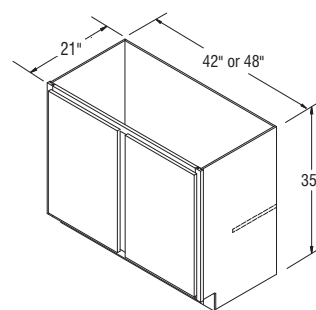

**VB4235FH
VB4835FH**

NOTES ✓

- ▶ Features a wood Pull-out unit with adjustable shelves, chrome rail sides, and Full extension guides.
- ▶ Smart Stop™ is not available in Select and APC Construction.



Vanity Base Pull-out, 35" High, 9" Wide, 21" Deep

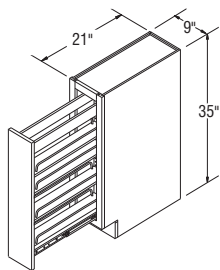

VBP0935

NOTES ✓

- ▶ FP = False Panel.
- ▶ It may be necessary to modify the corner braces/stretcher rails with some sink applications.
- ▶ Raised panel styles - drawer fronts will convert to raised panel; Full overlay - 10 1/4" or higher Partial overlay - 9 5/8" or higher
- ▶ Vanity interiors are not drilled for shelf clip holes, nor do they include a shelf.
- ▶ 18" deep Vanities available in Standard construction only.

Vanity Door and Drawer Bases, 32 1/2" High, 18" Deep

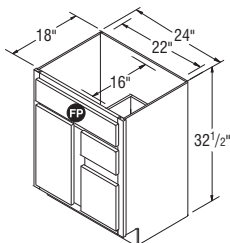

VSD2432.518* *New*

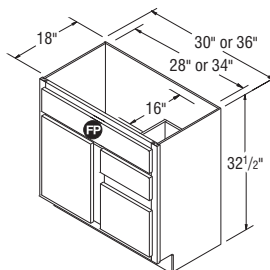

**VSD3032.518* *New*
VSD3632.518* *New***

*Specify L or R for which side to locate door.

Vanity Door and Drawer Bases, 32 1/2" High, 21" Deep

NOTES ✓

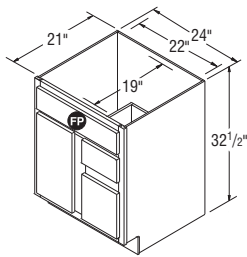

VSD2432.5* New

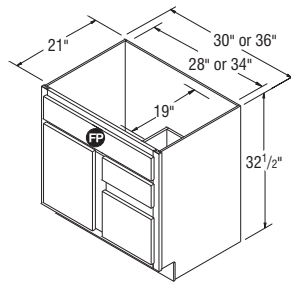

VSD3032.5* New
VSD3632.5* New

- ▶ FP = False Panel.
- ▶ It may be necessary to modify the corner braces/stretcher rails with some sink applications.
- ▶ Raised panel styles - drawer fronts will convert to raised panel;
Full overlay - 10 1/4" or higher
Partial overlay - 9 7/8" or higher
- ▶ Vanity interiors are not drilled for shelf clip holes, nor do they include a shelf.

*Specify L or R for which side to locate door.

Vanity Door and Drawer Bases, 35" High, 21" Deep

NOTES ✓

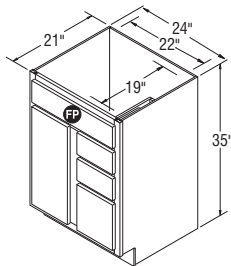

VSD2435* New

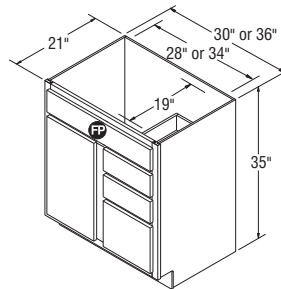

VSD3035* New
VSD3635* New

- ▶ FP = False Panel.
- ▶ It may be necessary to modify the corner braces/stretcher rails with some sink applications.
- ▶ Raised panel styles - drawer fronts will convert to raised panel;
Full overlay - 10 1/4" or higher
Partial overlay - 9 7/8" or higher
- ▶ Vanity interiors are not drilled for shelf clip holes, nor do they include a shelf.

*Specify L or R for which side to locate door.

Vanity Double Drawer Bases, 32 1/2" High, 18" Deep

NOTES ✓

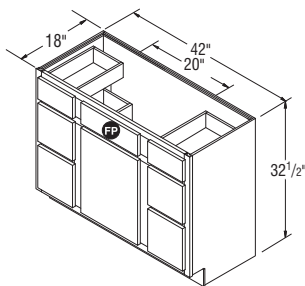

VDDB4232.518

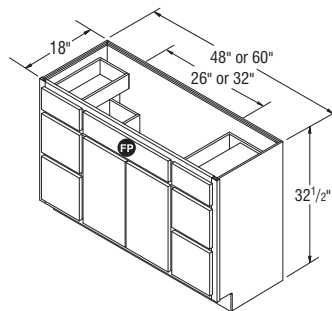

VDDB4832.518
VDDB6032.518

- ▶ FP = False Panel.
- ▶ It may be necessary to modify the corner braces/stretcher rails with some sink applications.
- ▶ Raised panel styles - drawer fronts will convert to raised panel;
Full overlay - 10 1/4" or higher
Partial overlay - 9 7/8" or higher
- ▶ Vanity interiors are not drilled for shelf clip holes, nor do they include a shelf.
- ▶ 18" deep Vanities available in Standard construction only.

NOTES ✓

- ▶ FP = False Panel.
- ▶ It may be necessary to modify the corner braces/stretcher rails with some sink applications.
- ▶ Raised panel styles - drawer fronts will convert to raised panel;
Full overlay - 10 1/4" or higher
Partial overlay - 9 7/8" or higher
- ▶ Vanity interiors are not drilled for shelf clip holes, nor do they include a shelf.
- ▶ Vddb48 and Vddb60 have butt doors on all styles.

Vanity Double Drawer Bases, 32 1/2" High, 21" Deep

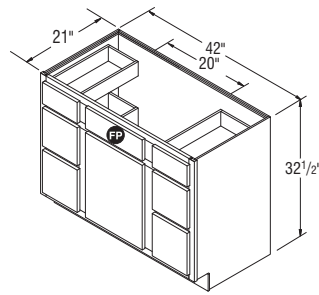

Vddb4232.5

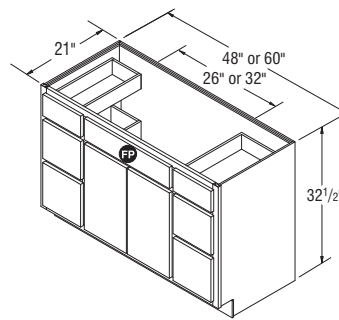

Vddb4832.5
Vddb6032.5

NOTES ✓

- ▶ FP = False Panel.
- ▶ Vddb4835 and Vddb6035 have butt doors on all door styles.
- ▶ Raised panel styles - drawer fronts will convert to raised panel;
Full overlay - 10 1/4" or higher
Partial overlay - 9 7/8" or higher
- ▶ Vanity interiors are not drilled for shelf clip holes, nor do they include a shelf.

Vanity Double Drawer Bases, 35" High, 21" Deep

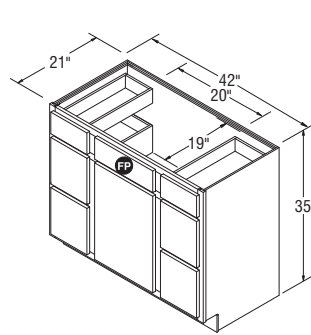

Vddb4235-3

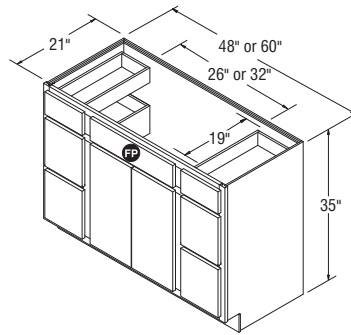

Vddb4835-3
Vddb6035-3

NOTES ✓

- ▶ FP = False Panel.
- ▶ Cabinet is 57" wide.
- ▶ Front frame is 60" wide.
- ▶ Front end rails are each 3" and can be trimmed to 1 1/2".
- ▶ Vddb6032.5 has butt doors on all door styles.
- ▶ Raised panel styles - drawer fronts will convert to raised panel;
Full overlay - 10 1/4" or higher
Partial overlay - 9 7/8" or higher
- ▶ Vanity interiors are not drilled for shelf clip holes, nor do they include a shelf.
- ▶ Only available in Partial overlay.

Trimmable Vanity Double Drawer Base, 32 1/2" High, 60" Wide, 21" Deep

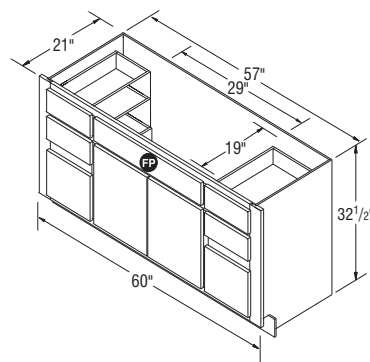

Vddb6032.5

Vanity Sink Base, 32 1/2" High, 18" Wide, 16" Deep

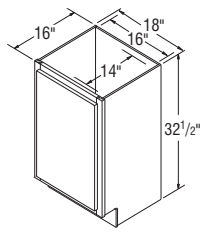

VSB1832.518

NOTES ✓

- ▶ It may be necessary to modify the corner braces/stretcher rails with some sink applications.
- ▶ 16" wide and 14" deep space for sink opening.
- ▶ One full height door.
- ▶ Vanity interiors are not drilled for shelf clip holes, nor do they include a shelf.
- ▶ 16" deep Vanities available in Standard Construction only.

Vanity Sink Bases, 32 1/2" High, 18" Deep

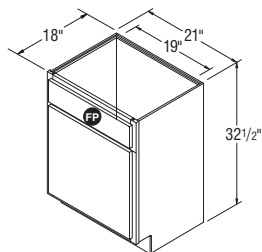

VSB2132.518

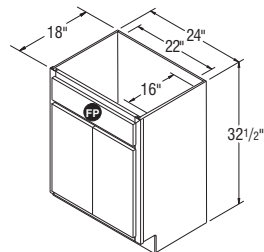

VSB2132.516

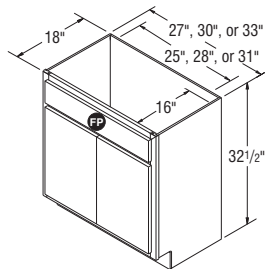

VSB3032.518B
VSB3332.518B

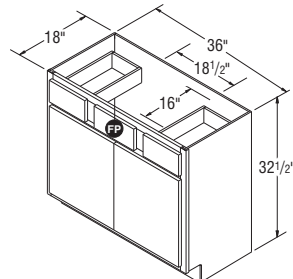

VSB3632.518B

NOTES ✓

- ▶ FP = False Panel.
- ▶ Recommended for use in vanity designs for ADA compliance with a maximum installed height of 34".
- ▶ It may be necessary to modify the corner braces/stretcher rails with some sink applications.
- ▶ VSB2432.518 has butt doors on all door styles.
- ▶ Vanity interiors are not drilled for shelf clip holes, nor do they include a shelf.
- ▶ 18" deep Vanities available in Standard construction only.

NOTES ✓

- ▶ FP = False Panel.
- ▶ Recommended for use in vanity designs for ADA compliance with a maximum installed height of 34".
- ▶ It may be necessary to modify the corner braces/stretcher rails with some sink applications.
- ▶ VSB2432.5 has butt doors on all door styles.
- ▶ Vanity interiors are not drilled for shelf clip holes, nor do they include a shelf.

Vanity Sink Bases, 32 1/2" High, 21" Deep

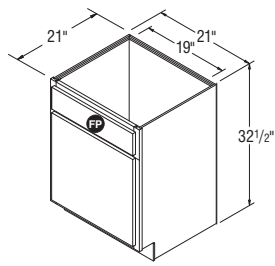

VSB2132.5

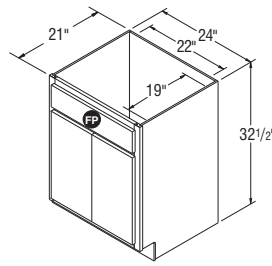

VSB2432.5

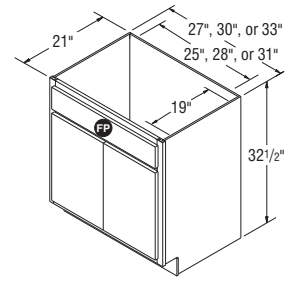

**VSB2732.5B
VSB3032.5B
VSB3332.5B**

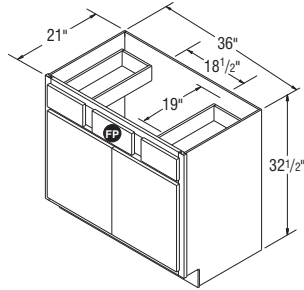

VSB3632.5B

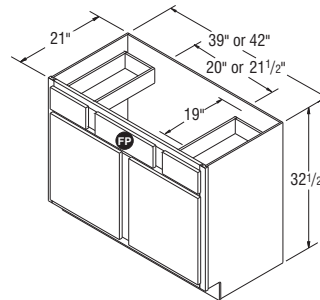

**VSB3932.5
VSB4232.5**

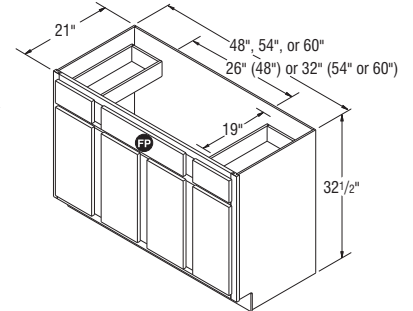

**VSB4832.5
VSB5432.5
VSB6032.5**

NOTES ✓

- ▶ FP = False Panel.
- ▶ It may be necessary to modify the corner braces/stretcher rails with some sink applications.
- ▶ VSB2435 has butt doors on all door styles.
- ▶ Vanity interiors are not drilled for shelf clip holes, nor do they include a shelf.

Vanity Sink Bases, 35" High, 21" Deep

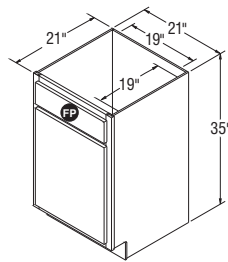

VSB2135

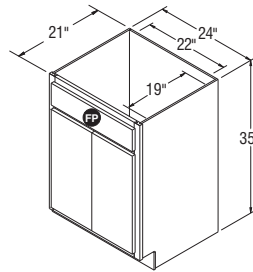

VSB2435

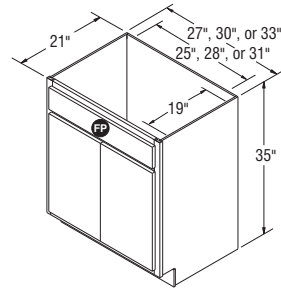

**VSB2735B
VSB3035B
VSB3335B**

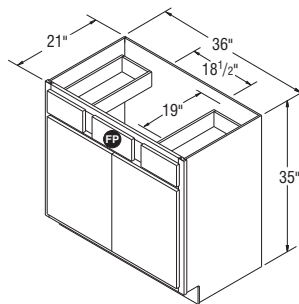

VSB3635B

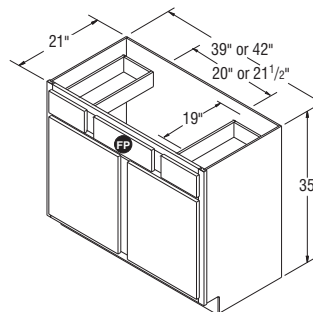

**VSB3935
VSB4235**

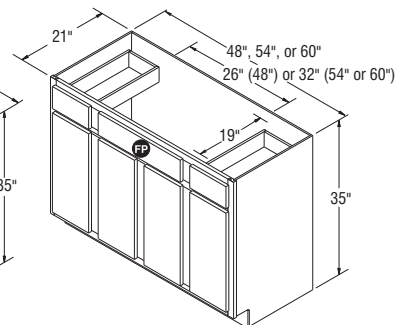

**VSB4835
VSB5435
VSB6035**

Vanity Sink Drawer Base, 32 1/2" High, 60" Wide, 21" Deep

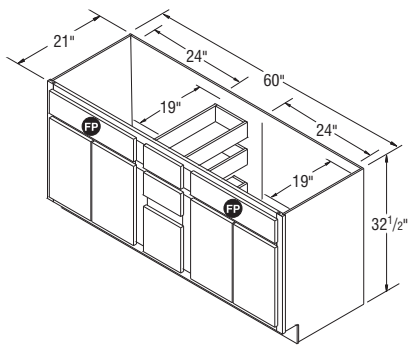

VSDB6032.5

NOTES ✓

- ▶ FP = False Panel.
- ▶ Four doors (two butt each end), three center drawers, two false drawer fronts, 24" wide (each side) and 19" deep space for sink opening (each side).
- ▶ It may be necessary to modify the corner braces/stretcher rails with some sink applications.
- ▶ Raised panel styles - drawer fronts will convert to raised panel;
Full overlay - 10 1/4" or higher
Partial overlay - 9 7/8" or higher
- ▶ Vanity interiors are not drilled for shelf clip holes, nor do they include a shelf.

Vanity Sink Drawer Base, 35" High, 60" Wide, 21" Deep

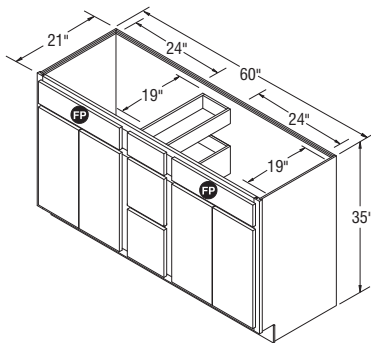

VSDB6035-3

NOTES ✓

- ▶ FP = False Panel.
- ▶ Four doors (two butt each end), four center drawers, two false drawer fronts, 24" wide (each side) and 19" deep space for sink opening (each side).
- ▶ It may be necessary to modify the corner braces/stretcher rails with some sink applications.
- ▶ Raised panel styles - drawer fronts will convert to raised panel;
Full overlay - 10 1/4" or higher
Partial overlay - 9 7/8" or higher
- ▶ Vanity interiors are not drilled for shelf clip holes, nor do they include a shelf.

Vanity Three Drawer Bases, 32 1/2" High, 18" Deep

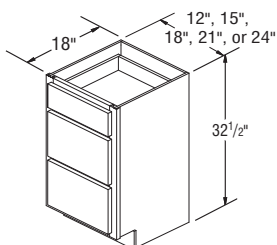

VDB1232.518
VDB1532.518
VDB1832.518
VDB2132.518
VDB2432.518

NOTES ✓

- ▶ Raised panel styles - drawer fronts will convert to raised panel;
Full overlay - 10 1/4" or higher
Partial overlay - 9 7/8" or higher
- ▶ 18" deep Vanities available in Standard construction only.

NOTES ✓

- ▶ Raised panel styles - drawer fronts will convert to raised panel;
- Full overlay - 10¹/₄" or higher
- Partial overlay - 9⁷/₈" or higher

Vanity Three Drawer Bases, 32 1/2" High, 21" Deep

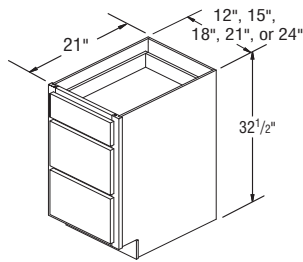

- VDB1232.5**
- VDB1532.5**
- VDB1832.5**
- VDB2132.5**
- VDB2432.5**

NOTES ✓

- ▶ Raised panel styles - drawer fronts will convert to raised panel;
- Full overlay - 10¹/₄" or higher
- Partial overlay - 9⁷/₈" or higher

Vanity Four Drawer Bases, 35" High, 21" Deep

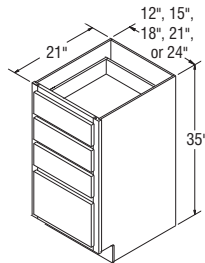

- VDB1235-4**
- VDB1535-4**
- VDB1835-4**
- VDB2135-4**
- VDB2435-4**

NOTES ✓

- ▶ Raised panel styles - drawer fronts will convert to raised panel;
- Full overlay - 10¹/₄" or higher
- Partial overlay - 9⁷/₈" or higher

Vanity Three Drawer Bases, 35" High, 21" Deep

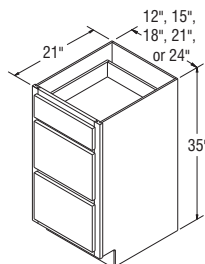

- VDB1235**
- VDB1535**
- VDB1835**
- VDB2135**
- VDB2435**

Vanity Wall Cabinet, 20" High, 15" Wide, 4 1/8" Deep

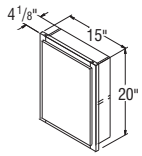

VWC1520*

*Specify L or R on all Arch styles.
Doors will be Arch when ordering these styles.

NOTES ✓

- ▶ Must be recess mounted; exterior not finished.
- ▶ Cut out dimensions: 13 7/8" W x 18 5/8" H x 3 3/8" D
- ▶ Only available in Standard Construction.
- ▶ Includes fixed shelf.

Vanity Tank Topper, 31" High, 24" Wide, 9" Deep

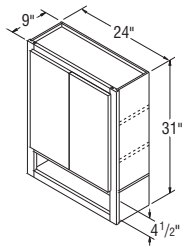

VTT24B

NOTES ✓

- ▶ Matching Aristex™ interior.
- ▶ Two butt doors, open shelf.
- ▶ Two adjustable 3/4" thick shelves.

Vanity Drawers Trimmable, 21" Deep (Trimmable 3")

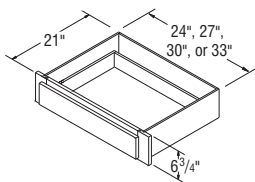

VDT27B
VDT30B
VDT33B
VDT36B

NOTES ✓

- ▶ Cabinets may not feature matching exterior laminate, so installation between two adjacent cabinets, walls, and/or panels is recommended.
- ▶ Face frame trimmable 3" overall, 1 1/2" on each side.
- ▶ Not available in All-plywood Construction.

NOTES ✓

- ▶ Two doors and one drawer.
- ▶ Top door will be an Arch in applicable styles.
- ▶ Upper doors cannot be cut-for-glass.
- ▶ Includes 3/4" thick adjustable shelves, two in top section, one in bottom section and one fixed shelf.
- ▶ Drawer front height aligns with 35" Vanity/Base cabinet drawer fronts.
- ▶ Large openings on miter door styles will be two doors doweled together.
- ▶ 18" deep Vanities available in Standard construction only.
- ▶ TKIT not available.



Linen Closets with Drawer, 84" High, 18" Deep

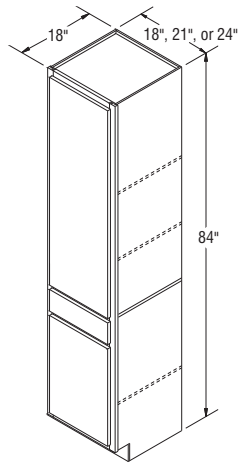

LCD1818*
LCD2118*
LCD2418*

*Specify L or R on all styles.

NOTES ✓

- ▶ Two doors and one drawer.
- ▶ Top door will be an Arch in applicable styles.
- ▶ Includes 3/4" thick adjustable shelves, two in top section, one in bottom section and one fixed shelf.
- ▶ Drawer front height aligns with 35" Vanity/Base cabinet drawer fronts.
- ▶ Large openings on miter door styles will be two doors doweled together.



Linen Closets with Drawer, 84" High, 21" Deep

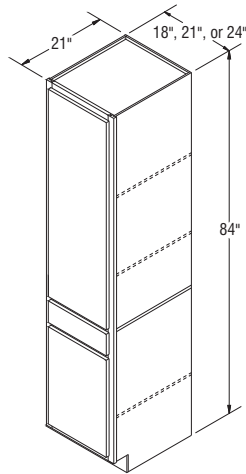

LCD18*
LCD21*
LCD24*

*Specify L or R on all styles.

Linen Closets SuperCabinet™ with Removable Hamper, 84" High, 21" Deep

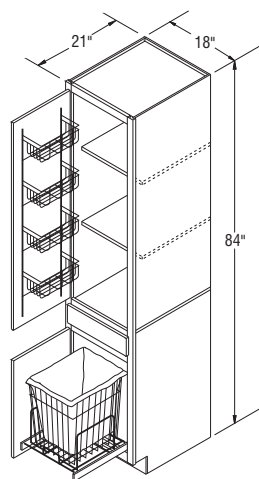

LCD18SC*

*Specify L or R on all styles.

NOTES ✓

- ▶ Two doors and one drawer.
- ▶ Top door will be an Arch in applicable styles.
- ▶ Includes two ¾" thick adjustable shelves and 5" deep chrome door rack.
- ▶ Drawer front height aligns with standard 35" Base cabinet drawer front.
- ▶ Large openings on miter door styles will be two doors doweled together.
- ▶ Includes Full extension non Smart Stop™ removable chrome Pull-out Hamper with removable cloth liner.



Vanity Medicine Cabinet, 24" High, 17" Wide, 4 3/8" Deep

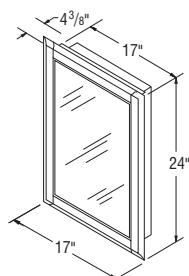

VMC1724

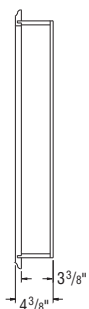

SIDE VIEW

NOTES ✓

- ▶ Interior of cabinet is white for all styles.
- ▶ One mirrored door with solid-wood frame.
- ▶ Can be surface or recess mounted (recess mount recommended for all finishes other than white).
- ▶ Box made of white formed plastic
- ▶ Includes two adjustable shelves and one adjustable toothbrush shelf (plastic).
- ▶ Cabinet is reversible.
- ▶ Cut out for recess: 14 1/4" W x 2 1/4" D x 21" H.
- ▶ Not available in Cherry.
- ▶ Soft Close Hinges are not available in Select and APC Construction.



Vanity Tri-View Medicine Cabinet, 32" High, 4" Deep

NOTES ✓

- ▶ Three mirrored doors.
- ▶ Solid-wood face frame.
- ▶ Can be surface or recess mounted.
- ▶ Chrome touch latches and hinges are used on doors.
- ▶ Box exterior matches face frame.
- ▶ Three fixed shelves.
- ▶ Cut out for recess:
 - VTMC2432 – 21⁵/₈" W x 3¹⁵/₁₆" D x 29³/₈" H.
 - VTMC3032 – 27⁵/₈" W x 3¹⁵/₁₆" D x 29³/₈" H.
 - VTMC3632 – 33⁵/₈" W x 3¹⁵/₁₆" D x 29³/₈" H.
 - VTMC4832 – 45⁵/₈" W x 3¹⁵/₁₆" D x 29³/₈" H.
- ▶ Soft Close Hinges are not available in Select and APC Construction.

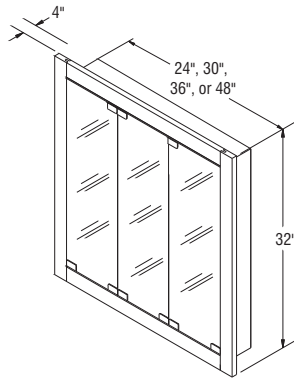

- VTMC2432**
- VTMC3032**
- VTMC3632**
- VTMC4832**



Linen Closet Shelf Kits

NOTES ✓

- ▶ Four shelves with clips.
- ▶ Shelves can be trimmed in the field to accommodate 18" deep linen closets.
- ▶ Available in natural maple laminate only.
- ▶ Order under style #010.
- ▶ Dimensions:
 - LKS18 – 1/2" T x 16 1/2" W x 20 3/16" D
 - LKS21 – 3/4" T x 19 1/2" W x 20 3/16" D
 - LKS24 – 1/2" T x 22 1/2" W x 20 3/16" D

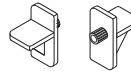
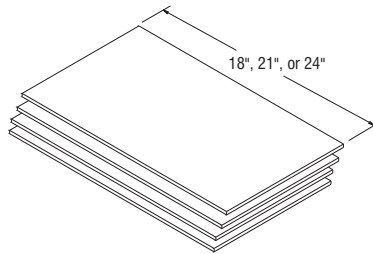

- LKS18C**
- LKS21C**
- LKS24C**



Universal Design Notes

32½" high cabinets are designed to comply with ADA (Americans with Disabilities Act) requirements of a 34" high overall counter height, including a 1½" countertop.

Available in the following styles:

- ▶ Avalon Maple
- ▶ Benton Birch
- ▶ Brellin Birch
- ▶ Ellis PureStyle™
- ▶ Landen Maple
- ▶ Lillian PureStyle™
- ▶ Oakland Oak
- ▶ Saybrooke Birch
- ▶ Sinclair Birch
- ▶ Westbury Oak
- ▶ Winstead Maple

Base Cabinets, 32 ½" High

NOTES ✓

- ▶ Includes one ¾" thick half depth adjustable shelf.
- ▶ B4232.5 includes one ¾" thick full depth adjustable shelf.

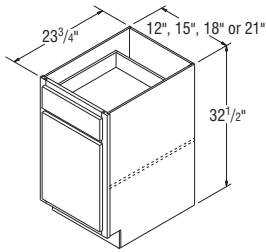

B1232.5
B1532.5
B1832.5
B2132.5

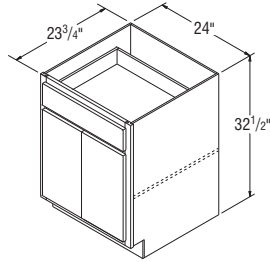

B2432.5DD

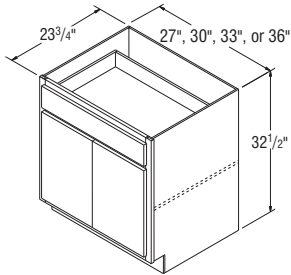

B2732.5B
B3032.5B
B3332.5B
B3632.5B

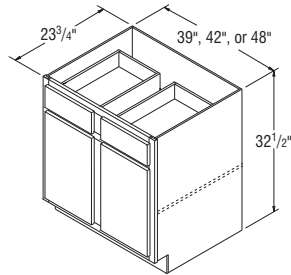

B3932.5
B4232.5
B4832.5

Base Cabinets with Full Height Doors, 32 ½" High

NOTES ✓

- ▶ Includes one ¾" thick full depth adjustable shelf.

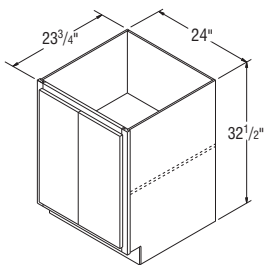

B2432.5DDFH

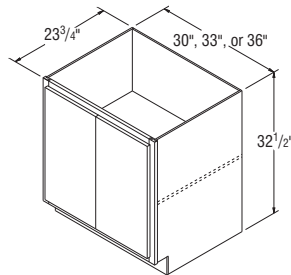

B3032.5FHB
B3332.5FHB
B3632.5FHB

NOTES ✓

- ▶ FP = False Panel.
- ▶ It may be necessary to modify the corner braces with some sink applications.
- ▶ Vanity interiors are not drilled for shelf clip holes, nor do they include a shelf.

Sink Base Cabinets, 32 1/2" High

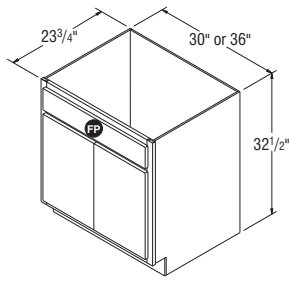

SB3032.5B
SB3632.5B

NOTES ✓

- ▶ FP = False Panel.
- ▶ Sink Base Floor included with all units.
- ▶ Trimmable 3" each side.

Sink Fronts, 32 1/2" High

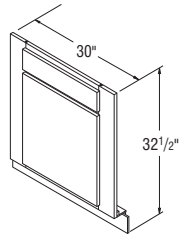

PARTIAL OVERLAY
SF3032.5

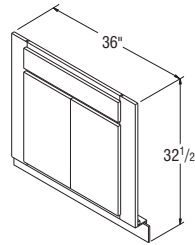

PARTIAL OVERLAY
SF3632.5B

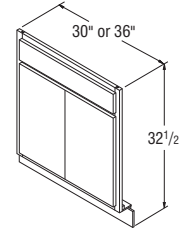

FULL OVERLAY
SF3032.5B-SF3632.5B

NOTES ✓

- ▶ 26" and 32" wide and 16 1/2" deep space for sink opening.
- ▶ Shipped unassembled.
- ▶ Removable front panel.
- ▶ Do not use or install as a freestanding unit.
- ▶ It may be necessary to modify the corner braces with some sink applications.
- ▶ Front panel does not include a door style profile.
- ▶ Not available in All-plywood Construction.

Sink Unit Cabinets with Front Panel, 32 1/2" High

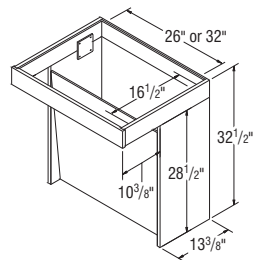

SU3032.5
SU3632.5

Three Drawer Base Cabinets, 32 1/2" High

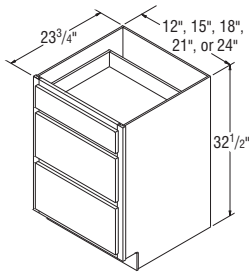

DB1232.5
DB1532.5
DB1832.5
DB2132.5
DB2432.5

Square Corner Roto Base Cabinet, 32 1/2" High

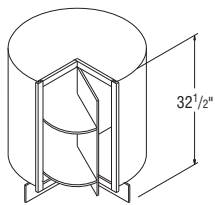

SCR3632.5

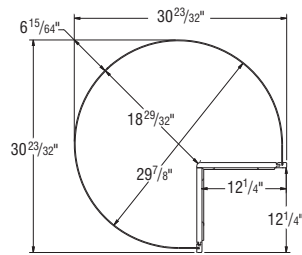

TOP VIEW

NOTES ✓

- ▶ Two rotating 27" diameter white shelves with a 60 lb. load capacity per shelf.
- ▶ One rotating door.
- ▶ Nominal gap of 1/4" on all sides of door.
- ▶ APC charges do not apply to SCR cabinets.
- ▶ Soft Close Hinges are not available in Select and APC Construction.
- ▶ When ordering APC Construction, top and bottom will utilize particleboard, but drum material does not change.
- ▶ For stability, install SCR cabinets between base cabinets.



Base Lazy Susan Cabinet, 32 1/2" High

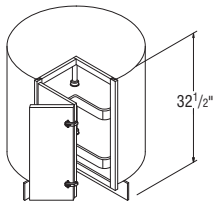

BLS3632.5*

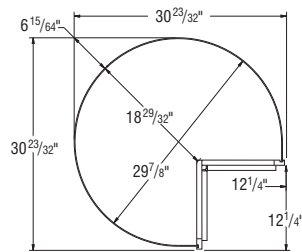

TOP VIEW

NOTES ✓

- ▶ One knuckle hinge door.
- ▶ Includes magnetic catch.
- ▶ Two 27" diameter rotating plastic white shelves that hold 60 lbs. per shelf.
- ▶ APC charges do not apply to BLS cabinets.
- ▶ Soft Close Hinges are not available in Select and APC Construction.
- ▶ For stability, install BLS cabinets between base cabinets.



*Specify L or R for full overlay styles.

Universal Base Corner Cabinet Information

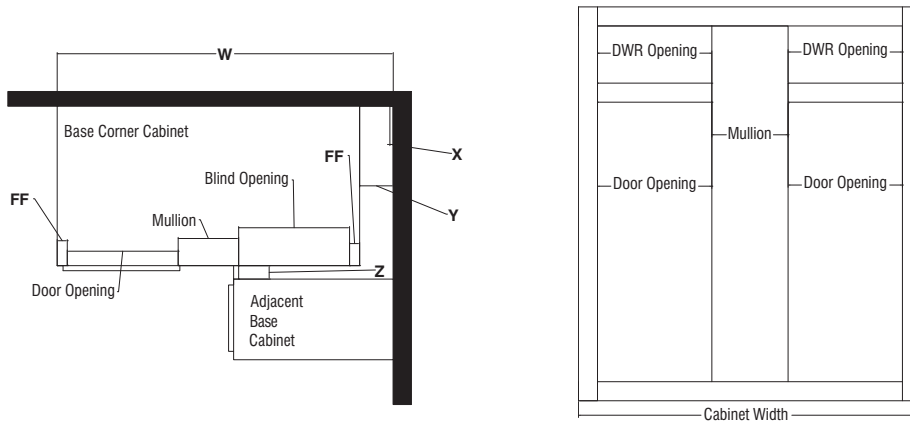

Full Overlay Universal Base Corner Cabinet Information

Full Overlay Styles	Actual Cabinet Width	X		Y	Z		W	
		Min. Pull	Min. Pull w/Hardware	Max. Pull	Min. Filler Required	Min. Filler Required w/Hardware	Min. Pull From Wall To End of Cabinet	Max Pull From Wall To End of Cabinet
BC3632.5	27"	9 ³ / ₄ "	11 ¹ / ₄ "	12 ¹ / ₂ "	1"	2 ¹ / ₂ "	36 ³ / ₄ "	39 ¹ / ₂ "
BC3932.5	30"	6 ³ / ₄ "	8 ¹ / ₄ "	12 ¹ / ₂ "	1"	2 ¹ / ₂ "	36 ³ / ₄ "	42 ¹ / ₂ "
BC4232.5	36"	3 ³ / ₄ "	5 ¹ / ₄ "	9 ¹ / ₂ "	1"	2 ¹ / ₂ "	39 ³ / ₄ "	45 ¹ / ₂ "
BC4532.5	42"	³ / ₄ "	2 ¹ / ₄ "	6 ¹ / ₂ "	1"	2 ¹ / ₂ "	42 ³ / ₄ "	48 ¹ / ₂ "
BC4832.5	45"	0"	³ / ₄ "	5"	1"	2 ¹ / ₂ "	45"	50"

7/16" Overlay Universal Base Corner Cabinet Information

7/16" Overlay Styles	Actual Cabinet Width	X		Y	Z		W	
		Min. Pull	Min. Pull w/Hardware	Max. Pull	Min. Filler Required	Min. Filler Required w/Hardware	Min. Pull From Wall To End of Cabinet	Max Pull From Wall To End of Cabinet
BC3632.5	27"	9 ³ / ₄ "	10 ³ / ₄ "	12 ¹ / ₂ "	¹ / ₂ "	2"	36 ³ / ₄ "	39 ¹ / ₂ "
BC3932.5	30"	6 ¹ / ₄ "	7 ³ / ₄ "	12 ¹ / ₂ "	¹ / ₂ "	2"	36 ³ / ₄ "	42 ¹ / ₂ "
BC4232.5	36"	3 ³ / ₄ "	4 ³ / ₄ "	9 ¹ / ₂ "	¹ / ₂ "	2"	39 ³ / ₄ "	45 ¹ / ₂ "
BC4532.5	42"	¹ / ₄ "	1 ³ / ₄ "	6 ¹ / ₂ "	¹ / ₂ "	2"	42 ¹ / ₄ "	48 ¹ / ₂ "
BC4832.5	45"	0"	¹ / ₄ "	5"	¹ / ₂ "	2"	45"	50"
BC4832.5	45"	0"	¹ / ₄ "	5"	¹ / ₂ "	2"	45"	50"

Base Corner Cabinets, 32 1/2" High, 23 3/4" Deep

NOTES ✓

- ▶ Includes one 3/4" thick full depth adjustable shelf.
- ▶ All Base Corner Cabinets are reversible from left blind to right blind.
- ▶ 3" filler is included with all Base Corner Cabinets and shipped unattached. Brellin comes with Filler and Overlay.
- ▶ To ensure proper door/drawer clearance we recommend you do not install appliances next to the blind.
- ▶ Adjoining run of cabinets will cover blind opening.
- ▶ One door and one drawer installed on each Base Corner Cabinet.
- ▶ Base Corner Cabinets are designed to use same amount of wall space designated in the SKU nomenclature, and may be pulled up to maximum amount on chart to accommodate odd dimensions in a kitchen.
- ▶ For minimum and maximum pull dimensions, refer to allowable minimum and maximum pull dimensions provided.

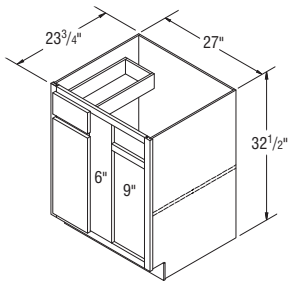

BC3632.5

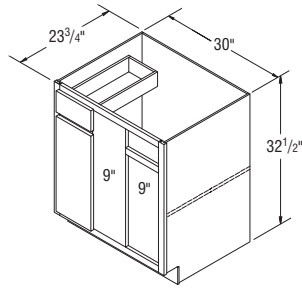

BC3932.5

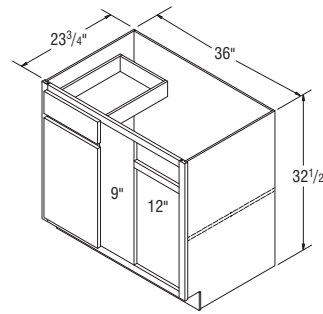

BC4232.5

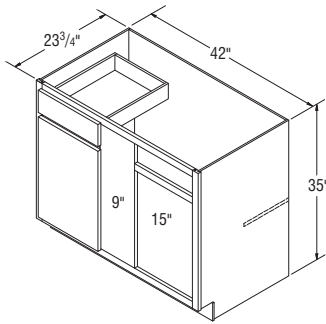

BC4532.5

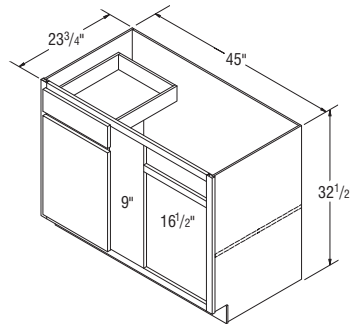

BC4832.5

Built-in Microwave Cabinet, 32 1/2" High

NOTES ✓

- ▶ Microwave opening is trimmable.
- ▶ Designed for Built-in Microwaves with trim kits (Cabinet has standard Aristex™ natural interior).

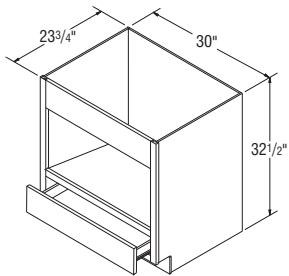

BMW3032.5

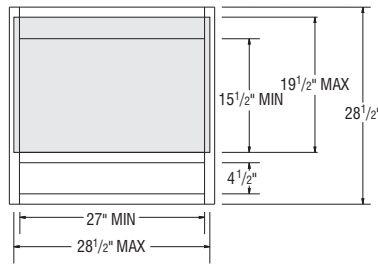

TRIM AREA

NOTES ✓

- ▶ Recommended installation height of 32½" to allow sufficient toe clearance for Universal Design stand-alone vanity applications as a wall hanging unit.
- ▶ Sink Opening Dimensions:
 Depth: 16¾"
 Widths: VWS2923 = 24¾"
 VWS3223 = 27¾"
 VWS3523 = 30¾"
 VWS4123 = 36¾"
- ▶ Cabinet construction will be All-plywood.

Vanity Wall Sink Cabinets, 23" High

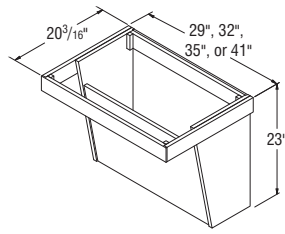

- VWS2923**
- VWS3223**
- VWS3523**
- VWS4123**

NOTES ✓

- ▶ Must be ordered with Vanity Wall Sink Cabinet (VWS). Not designed to be a stand-alone unit.
- ▶ Two plywood mending plates included to mount RVWS to VWS.
- ▶ Able to be removed for handicap accessible use.

Removable Vanity Wall Sink Cabinets, 32 1/2" High, 21" Deep

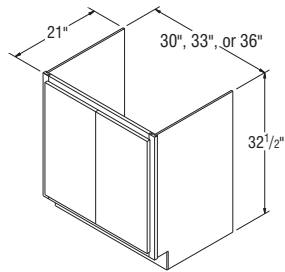

- RVWS3032B**
- RVWS3332B**
- RVWS3632B**

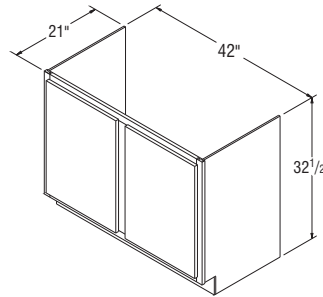

- RVWS4232**

Scribe Moulding

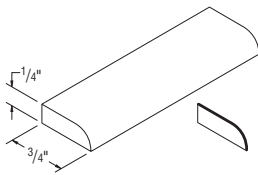

MSW8
PSMSW8

Outside Corner Moulding – 90° and 135°

DESIGN SOLUTIONS

- Use to create a finished look on ends of cabinet runs.

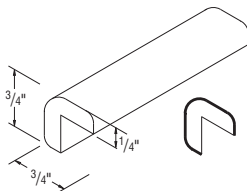

MOCW8

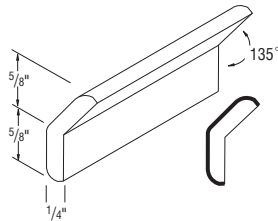

MOC135-8

Triple Bead Moulding

DESIGN SOLUTIONS

- Can be used with Inset Crown Moulding.

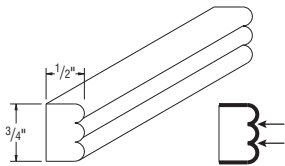

MTBEAD8
PSMTBEAD8

Trim Moulding

DESIGN SOLUTIONS

- Can be used to hide seams in stacked cabinet applications.

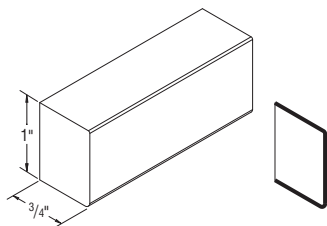

MTW8
PSMTW8

Finished edges indicated by bold lines on side view drawings.
Glazed edges indicated by arrows on side view drawings.

NOTES ✓

► MSHKRCROWN8 available in maple finishes only.

DESIGN SOLUTIONS

- For Moulding Solutions, see pages 36 & 37.
- Remember to order extra Mouldings when working with mitered corners.
- MICROWN8 and PSMICROWN8 are designed for inserts (i.e. dentil, rope, triple bead.)
- MLCOVECR8 ships with cleat unattached and can be top or face mounted.
- At minimum, leave a 3" reveal at the end of a run to allow Moulding and countertop ample clearance to return back to the wall.



Crown Moulding

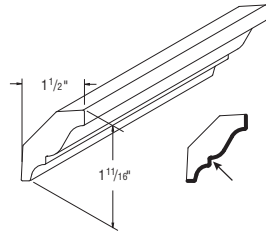

MCROWN8 (1 - 8' pc)
PSMICROWN8 (1 - 8' pc)

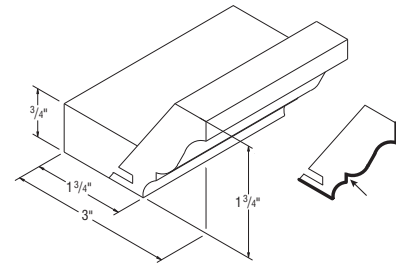

Full Overlay
MFOLCR8 (1 - 8' pc)
PSMFOLCR8 (1 - 8' pc)

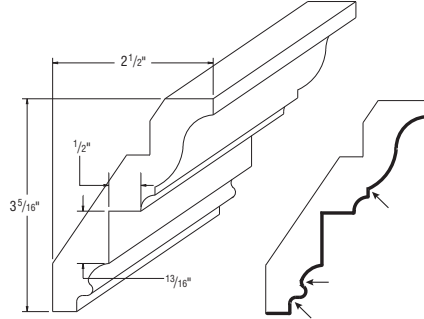

Insert
MICROWN8 (1 - 8' pc)
PSMICROWN8 (1 - 8' pc)

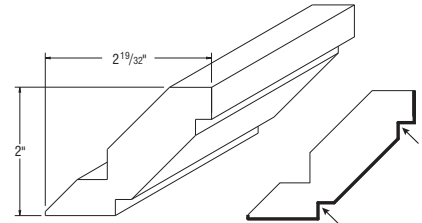

Shaker
MSHKRCROWN8 (1 - 8' pc)

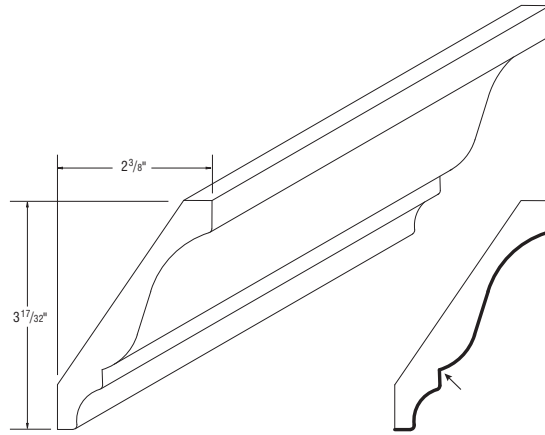

Tall
MTCROWN8 (1 - 8' pc)
PSMTCROWN8 (1 - 8' pc)

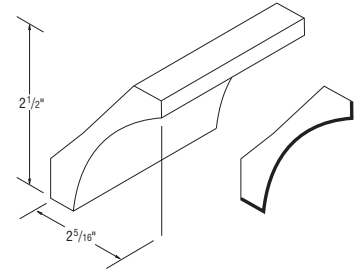

Small Cove
MSMCOVECR8 (1 - 8' pc)

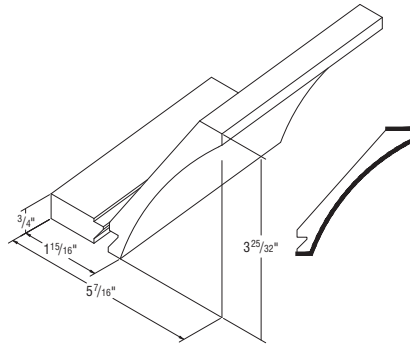

MLCOVECR8

Finished edges indicated by bold lines on side view drawings.
Glazed edges indicated by arrows on side view drawings.

Starter Moulding

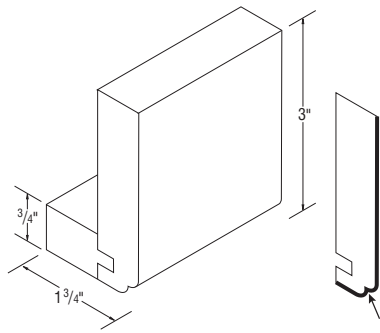

MSTR8 (1 - 8' pc)

NOTES ✓

- ▶ Top-mount installation only (cleat is attached).

DESIGN SOLUTIONS

- ▶ MSTR8 is for use with stacked moulding designs for ease of installation of top mouldings.



Starter Moulding Shaker

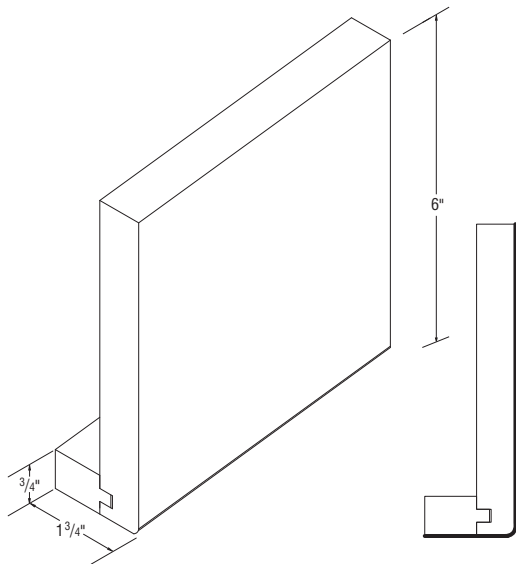

MSFMS8

NOTES ✓

- ▶ Top-mount installation only (cleat is attached).

Soffit Filler Mouldings

NOTES ✓

- Cleat shipped unattached, can be MSFM8 (1 - 8' pc) top or face mounted.

DESIGN SOLUTIONS

- MSFM8 is for use with stacked moulding designs for ease of installation.

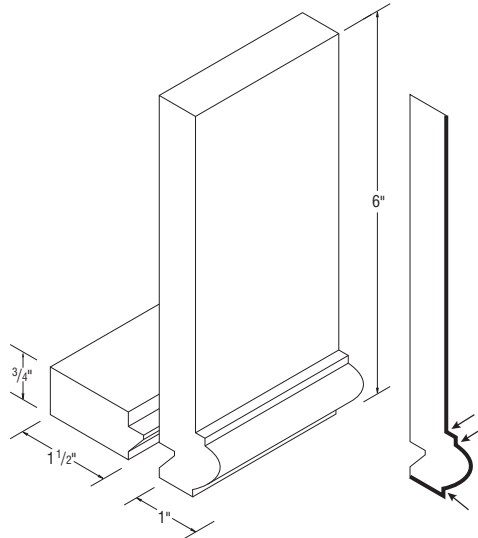

MSFM8 (1 - 8' pc)

Counter Top Moulding

DESIGN SOLUTIONS

- MCTB8 can be flipped upside-down and used as top trim.

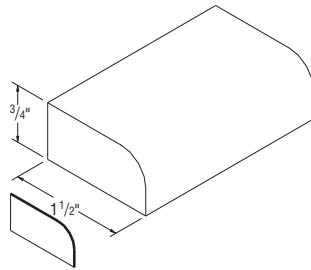

MCTR8 (1 - 8' pc)

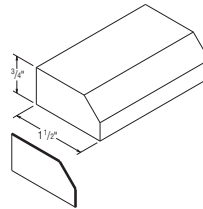

MCTB8 (1 - 8' pc)

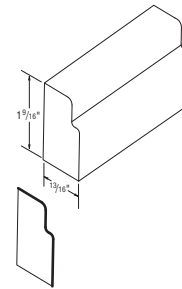

MCTT8 (1 - 8' pc)

Finished edges indicated by bold lines on side view drawings.
Glazed edges indicated by arrows on side view drawings.

Cove Moulding

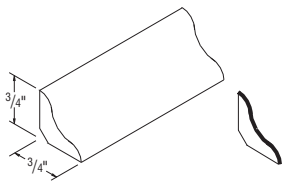

MCV8 (1 - 8' pc)

Quarter Round Moulding

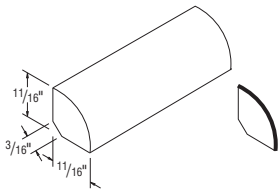

MQR8 (1 - 8' pc)

PSMQR8 (1 - 8' pc)

Batten Moulding

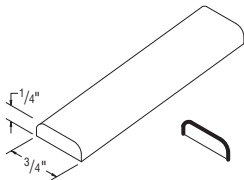

MBAT8 (1 - 8' pc)

Traditional Soffit Trim Moulding

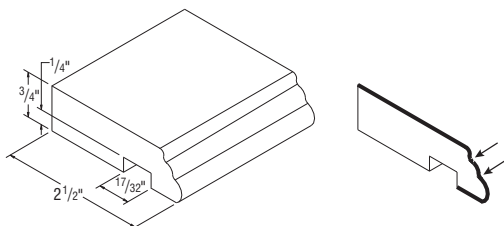

MTST8 (1 - 8' pc)

PSMTST8 (1 - 8' pc)

Finished edges indicated by bold lines on side view drawings.
Glazed edges indicated by arrows on side view drawings.

DESIGN SOLUTIONS

► MTCAP8 and PSMTCAP8 can be flipped upside-down and used as a base piece for a stacked top trim.



Traditional Cap Moulding

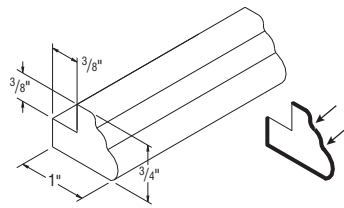

MTCAP8 (1 - 8' pc)
PSMTCAP8 (1 - 8' pc)

Tall Light Rail Moulding

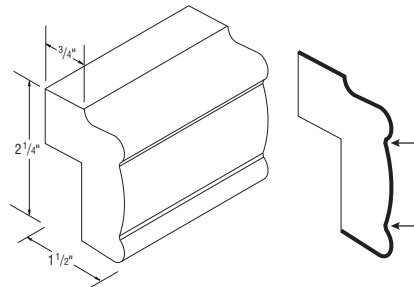

MTLR8 (1 - 8' pc)
PSMTLR8 (1 - 8' pc)

NOTES ✓

► Designed to mount under the face frame of Wall Cabinets.



Light Rail Moulding

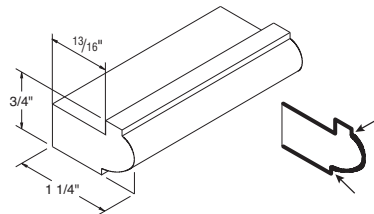

MLR8 (1 - 8' pc)

Traditional Trim Moulding

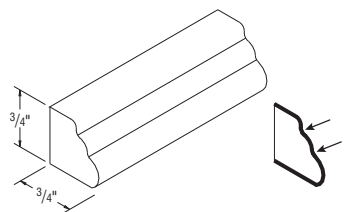

MTT8 (1 - 8' pc)

Finished edges indicated by bold lines on side view drawings.
Glazed edges indicated by arrows on side view drawings.

Traditional Batten Moulding

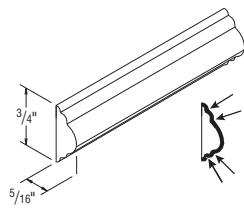

MTBAT8 (1 - 8' pc)

DESIGN SOLUTIONS

- ▶ MTBAT8 can be used with Insert Crown Moulding.



Dentil Moulding

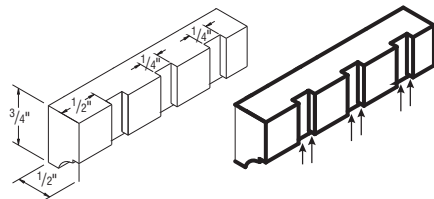

MDENTIL8 (1 - 8' pc)

NOTES ✓

- ▶ MDENTIL8 can be used with Insert Crown Moulding.



Rope Moulding

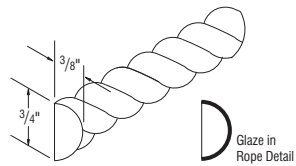

MROPE8 (1 - 8' pc)

DESIGN SOLUTIONS

- ▶ MROPE8 can be used with Insert Crown Moulding.



Base Shoe Moulding

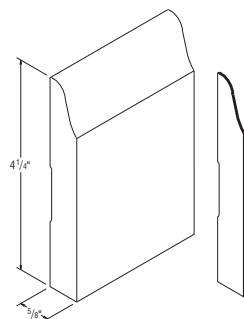

MBS8 (1 - 8' pc)

Finished edges indicated by bold lines on side view drawings.
Glazed edges indicated by arrows on side view drawings.



NOTES ✓

- ▶ FBC3X3 Overlays available for Briarcliff II, Durham, Eastland, Overton, and Wentworth.
- ▶ All Fillers finished on front and two long edges, except for F531A45 and BLVDFF331 which are finished on both sides and both long edges.
- ▶ All Fillers are 3/4" thick.
- ▶ BLVDFF331 - 45° reversible angled Filler (fluted one side). Comes as a pair. Reversible, finished on back.
- ▶ F531A45 - 45° reversible decorative angled Filler (fluted one side). Comes as a pair. Trimmable 2" top and bottom. Reversible, finished on back.
- ▶ TKF3 - Toekick Filler. Order under style #010. Shipped unassembled.
- ▶ F14X96 is 1/4" thick. Designed to fill space between adjacent cabinets. When ordered with Rustic Birch door styles, will not feature Rustic characteristics. Finished 1/4" on front and 3/4" all edges (backs are not finished).

Fillers

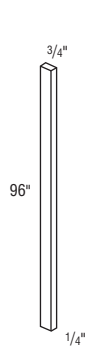

F14X96

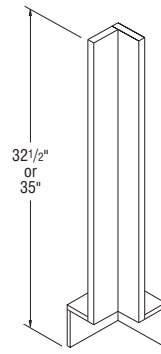

FBC3X332.5
FBC3X3

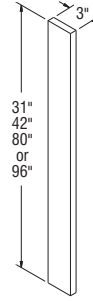

F331
F342
F380
F396

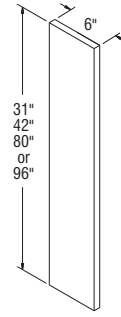

F631
F642
F680
F696

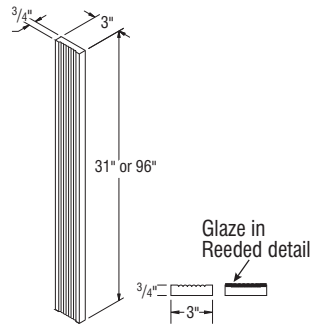

3" Reeded Fillers

FF331
FF396

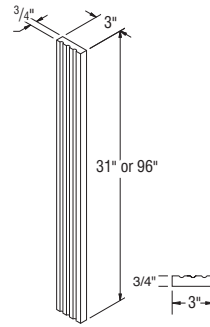

3" Fluted Fillers

FFL331
FFL396

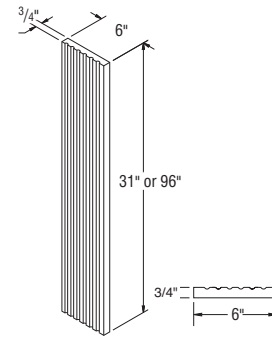

6" Fluted Fillers

FFL631
FFL696

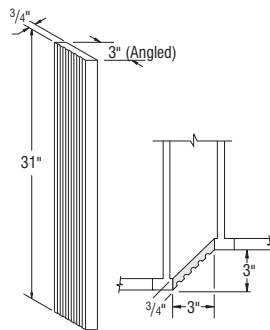

Angled Fluted/
Plain Filler

BLVDFF331

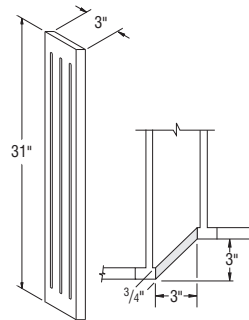

Decorative Angled Fluted/
Plain Filler

F531A45



TKF3*

*Order under style #010.



Box Column Filler, 42" High, 15" Deep

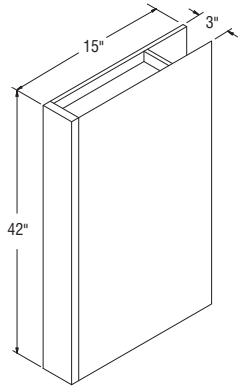

W34215BCF

NOTES ✓

- ▶ Solid-wood $\frac{3}{4}$ " front filler.
- ▶ Plywood construction with flush ends. Ends are $\frac{3}{8}$ ".
- ▶ Front and both sides are finished; interior supports and back are unfinished.
- ▶ Finished veneer on end panel exterior.
- ▶ Trimmable to required depth or height.
- ▶ Reversible, may be used on either left or right end.
- ▶ Not available in Birch or Rustic Birch.

Box Column Filler, 35" High, 27" Deep

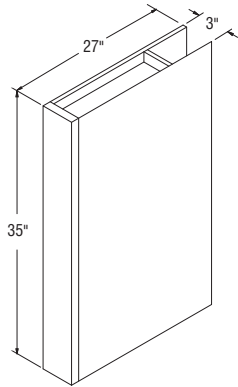

B33527BCF

NOTES ✓

- ▶ Solid-wood $\frac{3}{4}$ " front filler.
- ▶ Plywood construction with flush ends. Ends are $\frac{3}{8}$ ".
- ▶ Front and both sides are finished; interior supports and back are unfinished.
- ▶ Finished veneer on end panel exterior.
- ▶ Trimmable to required depth or height.
- ▶ Reversible, may be used on either left or right end.
- ▶ Not available in Birch or Rustic Birch.

Box Column Filler, 96" High, 27" Deep

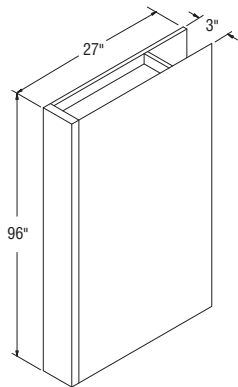

T39627BCF

NOTES ✓

- ▶ Solid-wood $\frac{3}{4}$ " front filler.
- ▶ Plywood construction with flush ends. Ends are $\frac{3}{8}$ ".
- ▶ Front and both sides are finished; interior supports and back are unfinished.
- ▶ Finished veneer on end panel exterior.
- ▶ Trimmable to required depth or height.
- ▶ Reversible, may be used on either left or right end.
- ▶ Not available in Birch or Rustic Birch.

Overlays*

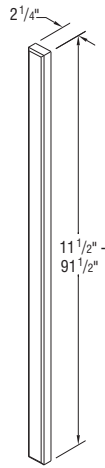

* Overlays are only available in Brellin, Briarcliff II, Durham, Eastland, Overton and Wentworth.

- | | |
|-------------|--------------|
| OL12 | OL335 |
| OL14 | OL36 |
| OL18 | OL42 |
| OL24 | OL80 |
| OL26 | OL86 |
| OL30 | OL92 |
| OL31 | |

Model	Dimensions	Usage Details
OL12	2 1/4" x 11 1/2"	12" high Wall
OL14	2 1/4" x 13 1/2"	14" high Wall
OL18	2 1/4" x 17 1/2"	18" high Wall
OL24	2 1/4" x 23 1/2"	24" high Wall
OL26	2 1/4" x 25 1/2"	30" high Vanity
OL30	2 1/4" x 29 1/2"	30" high Wall
OL31	2 1/4" x 30 1/8"	35" high Base/Vanity
OL335	2 1/4" x 30 1/8"	PEPR335 Panels
OL36	2 1/4" x 35 1/2"	36" high Wall
OL42	2 1/4" x 41 1/2"	42" high Wall
OL80	2 1/4" x 79 1/2"	84" high Utility
OL86	2 1/4" x 85 1/2"	90" high Utility
OL92	2 1/4" x 91 1/2"	96" high Utility

Overlays*

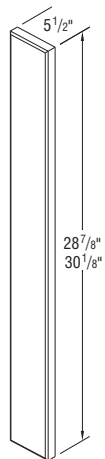

OL631

Model	Dimensions	Usage Details
OL631	Full overlay Door Styles 5 1/2" x 30 1/8"	35" high Base/Vanity
	Partial overlay Door Styles 5 1/2" x 28 7/8"	35" high Base/Vanity

Split Turnings

NOTES ✓

- ▶ SPTRINGEND is sold in pairs and are trimmable up to 5" each.

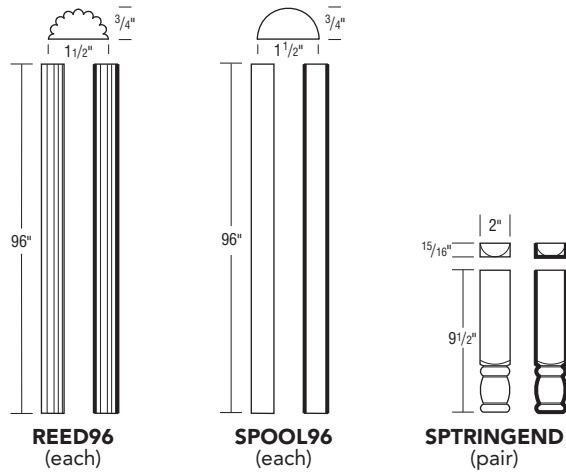

Bar Bracket Corbel, 8" High

NOTES ✓

- ▶ In order to support substantial weight, Corbels must be properly installed with attachment screws driven into a stud wall. Attachment screws not provided.

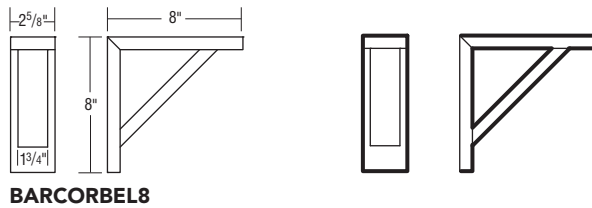

Cove Shaker Corbel, 12" High

NOTES ✓

- ▶ In order to support substantial weight, Corbels must be properly installed with attachment screws driven into a stud wall. Attachment screws not provided.

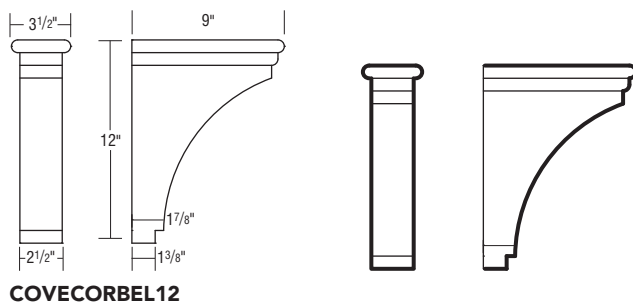

Finished edges indicated by bold lines on side view drawings.

NOTES ✓

- ▶ In order to support substantial weight, Corbels must be properly installed with attachment screws driven into a stud wall. Attachment screws not provided.



Shaker Corbel, 11" High

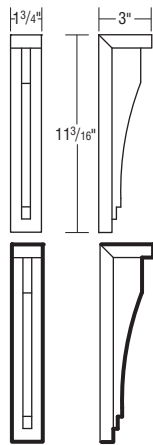

SHKCORBEL11

NOTES ✓

- ▶ Finished on all sides (reversible).
- ▶ Not intended to be used as a freestanding shelf support.
- ▶ VCORBEL sold in pairs.
- ▶ VCORBEL is 3/4" thick.
- ▶ VCORBEL11 has a 3" wide back plate.



Valance Corbels, 4" & 9 1/4" High

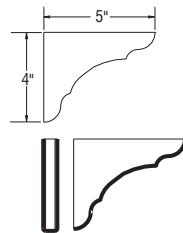

VCORBEL (pair)

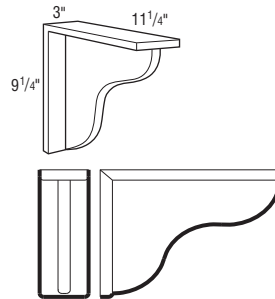

VCORBEL11

NOTES ✓

- ▶ In order to support substantial weight, Corbels must be properly installed with attachment screws driven into a stud wall. Attachment screws not provided.



Art Corbel, 9" High

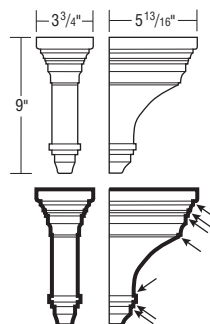

CORBELART9

Finished edges indicated by bold lines on side view drawings.
Glazed edges indicated by arrows on side view drawings.

Mission Corbels, 6" & 9" High

NOTES ✓

- In order to support substantial weight, Corbels must be properly installed with attachment screws driven into a stud wall. Attachment screws not provided.

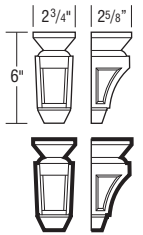

CORBELMIS6

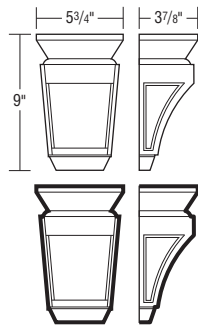

CORBELMIS9

Corbels, 9" & 13" High

DESIGN SOLUTIONS

- In order to support substantial weight, Corbels must be properly installed with attachment screws driven into a stud wall. Attachment screws not provided.

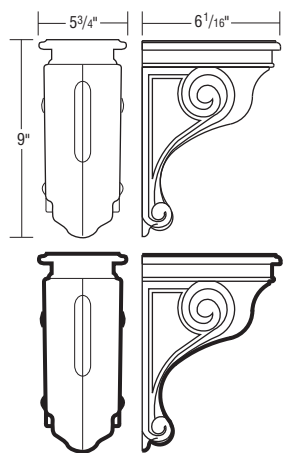

SMCORBEL

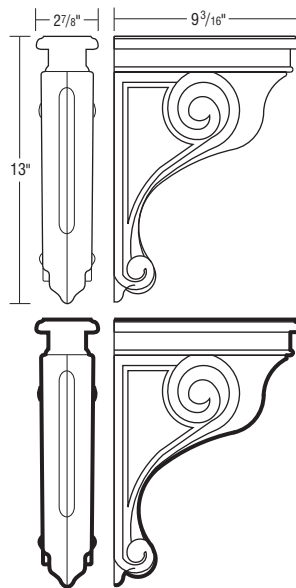

LGCORBEL

NOTES ✓

► Trimmable.



Decorative Feet

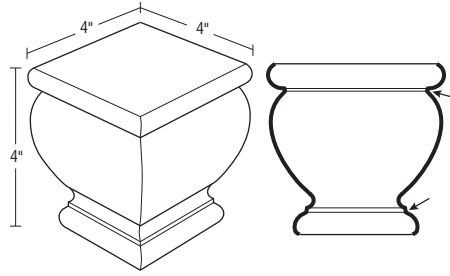

BUNLIFOOT

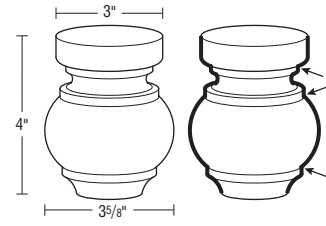

CRAFTFOOT

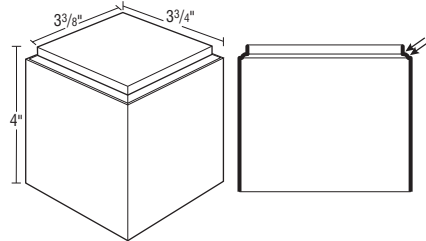

SQFOOT

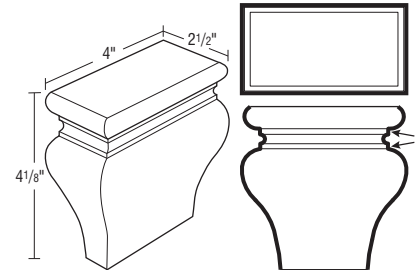

TKTLFOOT

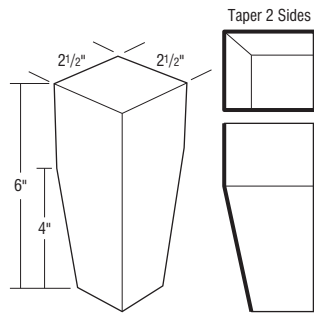

TAPLEG

Finished edges indicated by bold lines on side view drawings.
 Glazed edges indicated by arrows on side view drawings.

Decorative Legs

NOTES ✓

► Trimmable.

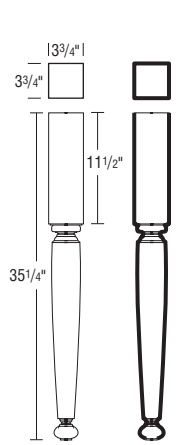

ISLEGSQ

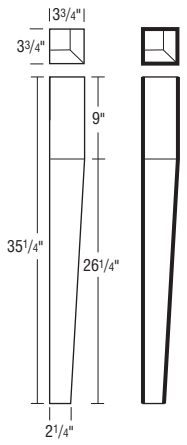

ISLEG2S

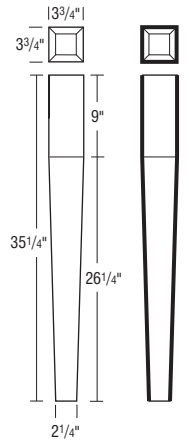

ISLEG4S

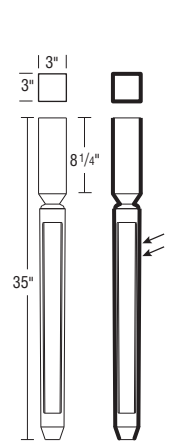

DLEGMISION

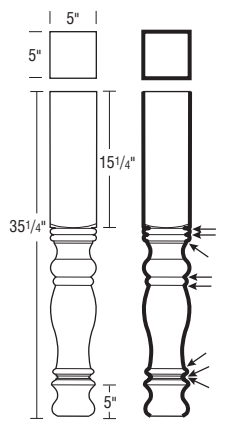

ENGISLCOLUMN

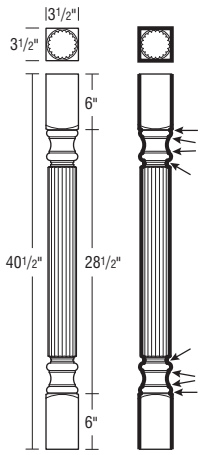

RDLEG

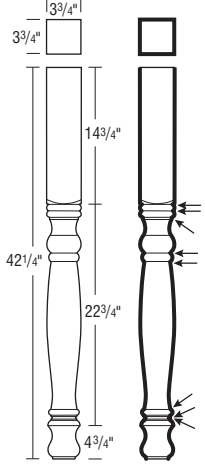

ENGBARCOLUMN

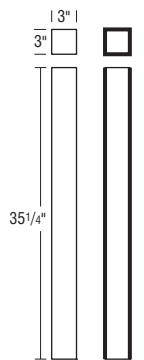

STISLEG

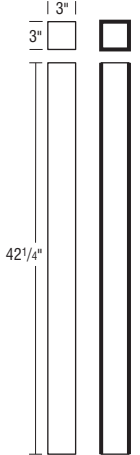

STBARLEG

Finished edges indicated by bold lines on side view drawings.
Glazed edges indicated by arrows on side view drawings.

NOTES ✓

- ▶ 3/4" thick.
- ▶ Valances not finished on back or ends.



Valances Arch, 5" High

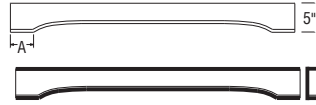

- V525RA**
- V531RA**
- V537RA**
- V543RA**
- V549RA**
- V561RA**
- V573RA**

Model	A =	Length
V525RA	4 1/4"	25"
V531RA	4 1/4"	31"
V537RA	4 1/4"	37"
V543RA	4 1/2"	43"
V549RA	4 1/2"	49"
V561RA	6"	61"
V573RA	6 3/4"	73"

DESIGN SOLUTIONS

- ▶ 3/4" thick.
- ▶ Valances not finished on back or ends.



Valances Straight, 5" High or 8 7/8" High

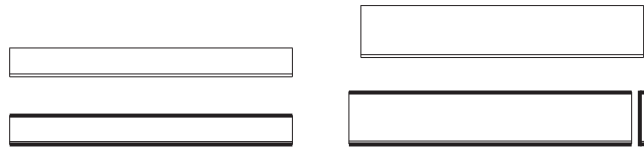

- V531ST**
- V537ST**
- V540ST**
- V543ST**
- V546ST**
- V549ST**
- V561ST**
- V573ST**

- V937ST**
- V949ST**
- V961ST**
- V973ST**

Model	Length
V531ST	31"
V537ST	37"
V540ST	40"
V543ST	43"
V546ST	46"
V549ST	49"
V561ST	61"
V573ST	73"
V937ST	37"
V949ST	49"
V961ST	61"
V973ST	73"

Finished edges indicated by bold lines on side view drawings.

Panels

NOTES ✓

► Plywood may contain MDF or particleboard in its core in accordance with ANSI/HPVA HP-1 standards.

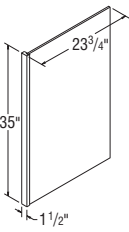

PEPR1.535
PEPR335 *

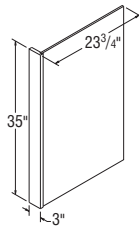

PEPRPLY1.535
PEPRPLY335*

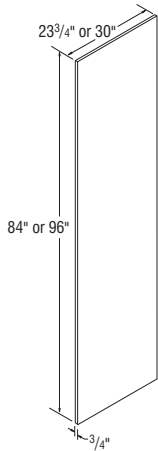

PREF2384
PREF2396
PREF3084
PREF3096

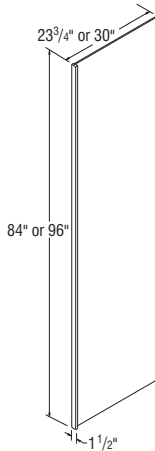

PREPRP1.584
PREPRP1.596
PREPR1.53084
PREPR1.53096

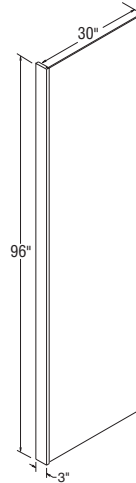

PREPR33096 *

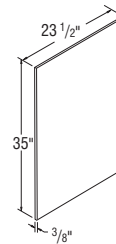

PSFEP

*When ordered in Rustic Finishes, rustic characteristics on Filler only.

Panel	Description	Size (T x W x H)	Edge Finish	Color Side 1	Color Side 2	Finish
PEPR1.535	Particle Board $\frac{3}{8}$ " End Panel w/ $\frac{1}{2}$ " Stile	$1\frac{1}{2}$ " x $23\frac{3}{4}$ " x 35"	Front Long	Exterior	Interior	Laminate
PEPR335 *	Particle Board $\frac{3}{8}$ " End Panel w/ $\frac{3}{8}$ " Stile	3" x $23\frac{3}{4}$ " x 35"	Front Long	Exterior	Interior	Laminate
PEPRPLY1.535	Plywood $\frac{3}{8}$ " End Panel w/ $\frac{1}{2}$ " Stile	$1\frac{1}{2}$ " x $23\frac{3}{4}$ " x 35"	Front Long	Exterior	Interior	Laminate
PEPRPLY335 *	Plywood $\frac{3}{8}$ " End Panel w/ $\frac{3}{8}$ " Stile	3" x $23\frac{3}{4}$ " x 35"	Front Long	Exterior	Interior	Laminate
PREF2384	Particle Board Refrigerator End Panel	$\frac{3}{4}$ " x $23\frac{3}{4}$ " x 84"	1 Long	Exterior	Exterior	Veneer
PREF2396	Particle Board Refrigerator End Panel	$\frac{3}{4}$ " x $23\frac{3}{4}$ " x 96"	1 Long	Exterior	Exterior	Veneer
PREF3084	Particle Board Refrigerator End Panel	$\frac{3}{4}$ " x 30" x 84"	1 Long	Exterior	Exterior	Veneer
PREF3096	Particle Board Refrigerator End Panel	$\frac{3}{4}$ " x 30" x 96"	1 Long	Exterior	Exterior	Veneer
PREPRP1.584	Plywood $\frac{3}{8}$ " Refrigerator End Panel w/ $\frac{1}{2}$ " Stile	$1\frac{1}{2}$ " x $23\frac{3}{4}$ " x 84"	Front Long	Exterior	Exterior	Laminate
PREPRP1.596	Plywood $\frac{3}{8}$ " Refrigerator End Panel w/ $\frac{1}{2}$ " Stile	$1\frac{1}{2}$ " x $23\frac{3}{4}$ " x 96"	Front Long	Exterior	Exterior	Laminate
PREPR1.53084	Plywood $\frac{3}{8}$ " Refrigerator End Panel w/ $\frac{1}{2}$ " Stile	$1\frac{1}{2}$ " x 30" x 84"	Front Long	Exterior	Exterior	Laminate
PREPR1.53096	Plywood $\frac{3}{8}$ " Refrigerator End Panel w/ $\frac{1}{2}$ " Stile	$1\frac{1}{2}$ " x 30" x 96"	Front Long	Exterior	Exterior	Laminate
PREPR33096 *	Particle Board $\frac{3}{4}$ " Refrigerator End Panel w/ $\frac{3}{8}$ " Stile	3" x 30" x 96"	Front Long	Exterior	Exterior	Veneer
PSFEP	Plywood Sink End Panel	$\frac{3}{8}$ " x $23\frac{1}{2}$ " x 35"	None	Exterior	Interior	Laminate

NOTES ✓

► Plywood may contain MDF or particleboard in its core in accordance with ANSI/HPVA HP-1 standards.



Stock Panels

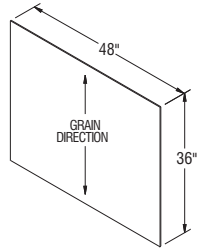

PA4836*
P4836

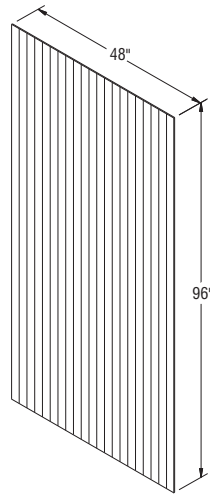

BP4896*

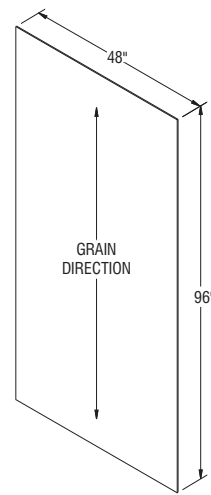

PA4896
P4896

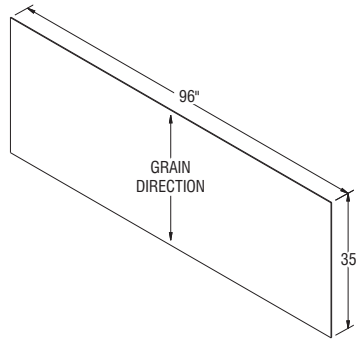

PP9635

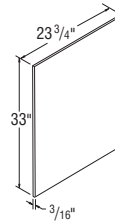

PDWP

*Opagues will be constructed of MDF.

Panel	Description	Size (T x W x H)	Edge Finish	Color Side 1	Color Side 2	Finish
BP4896	Beadboard Panel	3/16" x 48" x 96"	None	Exterior	Raw	Veneer
PA4836	Stock Panel - Aristex™ Laminate	1/4" x 48" x 36"	None	Exterior	Raw	Laminate
PA4896	Stock Panel - Aristex™ Laminate	1/4" x 48" x 96"	None	Exterior	Raw	Laminate
PP9635	Stock Panel - Veneer	3/16" x 96" x 35"	None	Exterior	Raw	Veneer
P4836	Stock Panel - Veneer	3/16" x 48" x 36"	None	Exterior	Raw	Veneer
P4896	Stock Panel - Veneer	3/16" x 48" x 96"	None	Exterior	Raw	Veneer
PDWP	Dishwasher Front Panel - Veneer	3/16" x 23 3/4" x 33"	None	Exterior	Raw	Veneer

Veneer End Panels

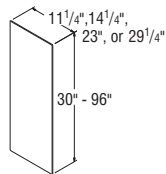

EPV1130 EPV2335
EPV1142 EPV2384
EPV1430 EPV2396
EPV1442

NOTES ✓

- ▶ End Panels are shipped one per carton. Not sold in pairs.
- ▶ EPV1430 and EPV1442 are sized for 15" deep cabinets.
- ▶ Plywood may contain MDF or particleboard in its core in accordance with ANSI/HPVA HP-1 standards.
- ▶ Opaques will be constructed of MDF.



Panel	Description	Size (T x W x H)	Edge Finish	Color Side 1	Color Side 2	Finish
EPV1130	Wall End Panel for 12" Depth	3/16" x 11 1/4" x 30"	None	Exterior	Raw	Veneer
EPV1142	Wall End Panel for 12" Depth	3/16" x 11 1/4" x 42"	None	Exterior	Raw	Veneer
EPV1430	Wall End Panel for 15" Depth	3/16" x 14 1/4" x 30"	None	Exterior	Raw	Veneer
EPV1442	Wall End Panel for 15" Depth	3/16" x 14 1/4" x 42"	None	Exterior	Raw	Veneer
EPV2335	Base End Panel	3/16" x 23" x 35"	None	Exterior	Raw	Veneer
EPV2384	Utility End Panel	3/16" x 23" x 84"	None	Exterior	Raw	Veneer
EPV2396	Utility End Panel	3/16" x 23" x 96"	None	Exterior	Raw	Veneer
EPV3096	Utility End Panel	3/16" x 29 1/4" x 96"	None	Exterior	Raw	Veneer

Laminate End Panels

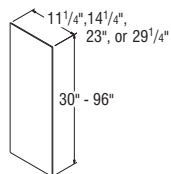

EPA1130 EPA2335
EPA1142 EPA2384
EPA1430 EPA2396
EPA1442 EPA3096

DESIGN SOLUTIONS

- ▶ 1/4" thick panels with one-sided Aristex™ laminate on exterior (no edge finish).
- ▶ End Panels are shipped one per carton. Not sold in pairs.
- ▶ EPA1430 and EPA1442 are sized for 15" deep cabinets.



Panel	Description	Size (T x W x H)	Edge Finish	Color Side 1	Color Side 2	Finish
EPA1130	Wall End Panel for 12" Depth	1/4" x 11 1/4" x 30"	None	Exterior	Raw	Laminate
EPA1142	Wall End Panel for 12" Depth	1/4" x 11 1/4" x 42"	None	Exterior	Raw	Laminate
EPA1430	Wall End Panel for 15" Depth	1/4" x 14 1/4" x 30"	None	Exterior	Raw	Laminate
EPA1442	Wall End Panel for 15" Depth	1/4" x 14 1/4" x 42"	None	Exterior	Raw	Laminate
EPA2335	Base End Panel	1/4" x 23" x 35"	None	Exterior	Raw	Laminate
EPA2384	Utility End Panel	1/4" x 23" x 84"	None	Exterior	Raw	Laminate
EPA2396	Utility End Panel	1/4" x 23" x 96"	None	Exterior	Raw	Laminate
EPA3096	Utility End Panel	1/4" x 29 1/4" x 96"	None	Exterior	Raw	Laminate

NOTES ✓

- ▶ DBEP and DPBEP include one door and one drawer front on an EP2335 Veneer End Panel and five screws for mounting.
- ▶ DBEPFH includes one door on an EP2335 Veneer End Panel and five screws for mounting.
- ▶ DBEPFH-12 includes one door on a Veneer Panel and five screws for mounting.
- ▶ DUEP includes two doors and one EP__ Veneer End Panel, and screws for assembly. Shipped assembled.
- ▶ DUEP includes three doors on miter styles.
- ▶ DVEP includes one door, one drawer front, and one Panel 20 1/4" x 30", and screws for assembly. Shipped assembled.
- ▶ DVEP32.5 includes one door, one door front, and on Panel 20 1/4" x 32 1/2", and screws for assembly. Shipped assembled.
- ▶ DWEP parts include one door and an EP__ Veneer End Panel and four screws for mounting. Shipped assembled.
- ▶ Actual sizes of doors and drawer fronts used will vary slightly by style. For exact dimensions, refer to parts dimension guide.
- ▶ Panel construction is the same for Standard, Select, and APC.
- ▶ Plywood may contain MDF or particleboard in its core in accordance with ANSI/HPVA HP-1 standards.

Decorative End Panels

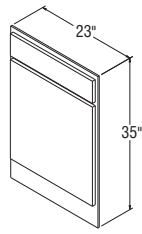

DBEP*

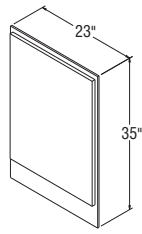

DBEPFH*

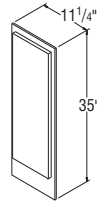

DBEPFH-12*

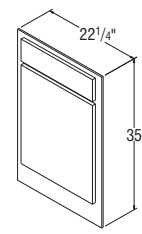

DPBEP*

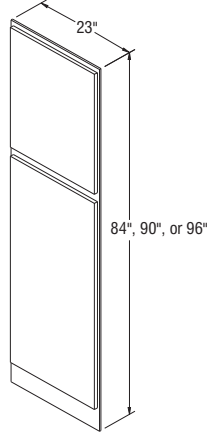

DUEP84*
DUEP90*
DUEP96*

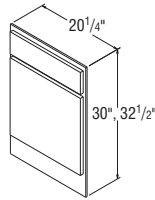

DVEP*
DVEP32.5*

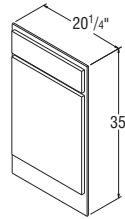

DVEP35*

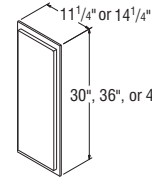

DWEP30*
DWEP36*
DWEP42*
DWEP1530*
DWEP1536*
DWEP1542*

*Specify L or R on full overlay styles for all Decorative Panels except DDWP.

Panel	Description	Size (T x W x H)	Edge Finish	Color Side 1	Color Side 2	Finish
DBEP & DBEPFH *	Decorative Base End	3/16" x 23" x 35"	None	Exterior	Raw	Veneer
DBEPFH-12 *	Decorative Base End for 12" Depth	3/16" x 11 1/4" x 35"	None	Exterior	Raw	Veneer
DPBEP *	Decorative Peninsula Base End	3/16" x 22 1/4" x 35"	None	Exterior	Raw	Veneer
DUEP84 *	Decorative Utility End	3/16" x 23" x 84"	None	Exterior	Raw	Veneer
DUEP90 *	Decorative Utility End	3/16" x 23" x 90"	None	Exterior	Raw	Veneer
DUEP96 *	Decorative Utility End	3/16" x 23" x 96"	None	Exterior	Raw	Veneer
DVEP *	Decorative Vanity End	3/16" x 20 1/4" x 30"	None	Exterior	Raw	Veneer
DVEP32.5*	Decorative Vanity End	3/16" x 20 1/4" x 32 1/2"	None	Exterior	Raw	Veneer
DVEP35 *	Decorative Vanity End	3/16" x 20 1/4" x 35"	None	Exterior	Raw	Veneer
DWEP30 *	Decorative Wall End	3/16" x 11 1/4" x 30"	None	Exterior	Raw	Veneer
DWEP36 *	Decorative Wall End	3/16" x 11 1/4" x 36"	None	Exterior	Raw	Veneer
DWEP42 *	Decorative Wall End	3/16" x 11 1/4" x 42"	None	Exterior	Raw	Veneer
DWEP1530 *	Decorative Wall End for 15" Depth	3/16" x 14 1/4" x 30"	None	Exterior	Raw	Veneer
DWEP1536 *	Decorative Wall End for 15" Depth	3/16" x 14 1/4" x 36"	None	Exterior	Raw	Veneer
DWEP1542 *	Decorative Wall End	3/16" x 14 1/4" x 42"	None	Exterior	Raw	Veneer

Vanity Tapered End Panel, 30" High, 21" Deep

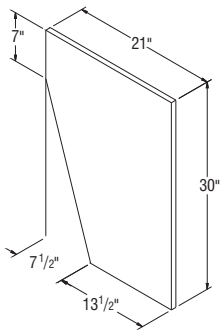

VTEP

NOTES ✓

- ▶ 3/4" thick.
- ▶ Veneer panel with front edgebanded and both sides finished.



Vanity Tapered End Panel, 32 1/2" High, 21" Deep

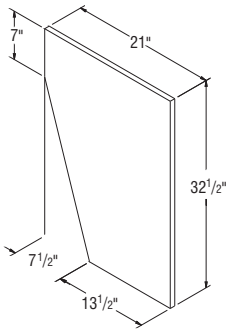

VTEP32.5

NOTES ✓

- ▶ 3/4" thick.
- ▶ Veneer panel with front edgebanded and both sides finished.



Range Panel, 35" High

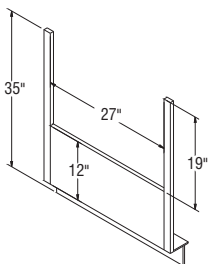

RP30

NOTES ✓

- ▶ Rail, Panel, and Toekick.
- ▶ 27" opening.

DESIGN SOLUTIONS

- ▶ Use drawer front to cover bottom portion of panel.



NOTES ✓

- ▶ Plywood may contain MDF or particleboard in its core in accordance with ANSI/HPVA HP-1 standards.



Toekick

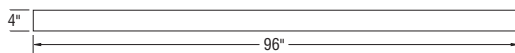

- TOEKICK8** (1 - 8' pc)
- TOEKICK** (4 - 8' pc)
- TOEKICKPLY8** (1 - 8' pc)

Panel	Description	Size (T x W x H)	Edge Finish	Color Side 1	Color Side 2	Finish
TOEKICK8	Aristex™ Toekick	1/4" x 4" x 96"	None	Exterior	Raw	Laminate
TOEKICK	Aristex™ Toekick	1/4" x 4" x 96"	None	Exterior	Raw	Laminate
TOEKICKPLY8	Plywood Toekick	1/4" x 4" x 96"	None	Exterior	Raw	Veneer

NOTES ✓

- ▶ TKC dimension: 3/4" x 4" x 3/4"
- ▶ Sold in pairs.

Toekick Cap

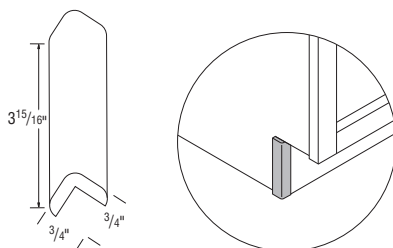

TKC

Exterior Shelves

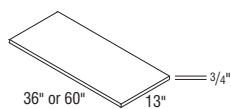

- WSS36** (2/ctn.)
- WSS60** (2/ctn.)

Shelf	Description	Size (T x W x D)	Edge Finish	Color Side 1	Color Side 2	Finish
WSS36	Wall System Shelves	3/4" x 36" x 13"	1 Long	Exterior	Exterior	Veneer
WSS60	Wall System Shelves	3/4" x 60" x 13"	1 Long	Exterior	Exterior	Veneer

Bookshelf Kit

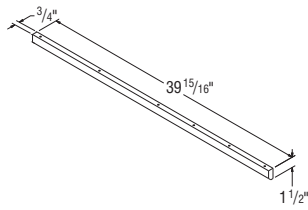

BKSHELFKIT*

*Order under door style number.

NOTES ✓

- ▶ Recommended for use with Bookcase units where loads on shelves will exceed over 60 lbs.
- ▶ One Shelf Kit required per shelf.
- ▶ When ordered in a Rustic Birch style, will not feature rustic characteristics.

Stem Glass Holders (Under Wall Cabinet Accessory)

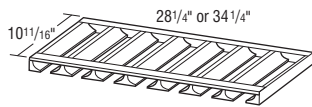

SGH30 SGH36



Side View

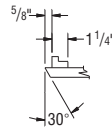

NOTES ✓

- ▶ Designed to be mounted underneath a standard Wall cabinet.
- ▶ SGH30 holds 7 rows.
- ▶ SGH36 holds 9 rows.
- ▶ SGH30 - space between rails is 1 11/32" wide.
- ▶ SGH36 - space between rails is 1 11/18" wide.



Organizer Shelves (Under Wall Cabinet Accessory)

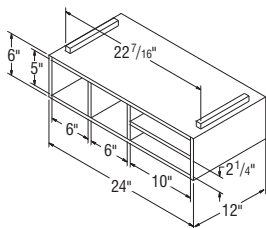

ORG24

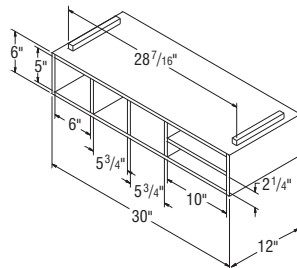

ORG30

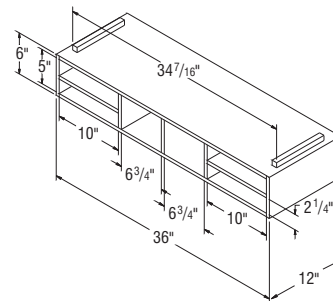

ORG36

NOTES ✓

- ▶ Designed to mount underneath Wall cabinet.
- ▶ Top, bottom, and sides are finished.



NOTES ✓

- ▶ One 3/4" thick matching Aristex™ shelf mounted to each Stem Glass Holder.
- ▶ Stem Glass Holder is installed by placing shelf in position with included shelf clips.
- ▶ SGH18 fits 18" wide Wall cabinets.
- ▶ SGH21 fits 21" wide Wall cabinets.

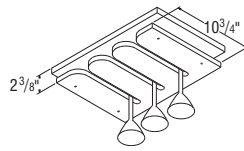

SGH18
SGH21



Wall Spice Racks (Wall Cabinet Accessory)

NOTES ✓

- ▶ Natural wood finish with chrome bars.
- ▶ Designed for Wall cabinets (30", 36", and 42" high), Base cabinets, Utility cabinets, and Linen Closet cabinets. Make sure to avoid interference with Roll Trays, full-depth shelves, or other interior cabinet accessories.
- ▶ Mounts to door frame with provided screws.
- ▶ Order under style #010.

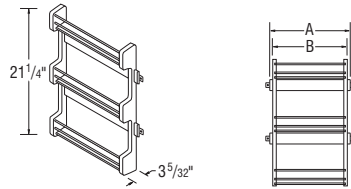

SRD15
SRD18
SRD21

DESIGN SOLUTIONS

- ▶ Great for use in the bathroom to hold vitamins, medications, etc.

Model	Recommended	A Dimension	B Dimension
SRD15	15" or 30" wide	10 1/2"	9 1/2" wide
SRD18	18" or 36" wide	13 1/2"	12 1/2" wide
SRD21	21" or 42" wide	16 1/2"	15 1/2" wide



Pegged Dish Organizer (Drawer Accessory)

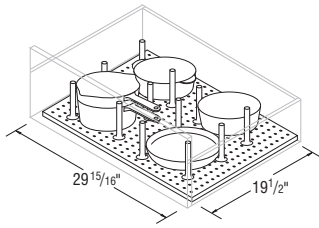

PDO



PDOPOSTS

NOTES ✓

- ▶ PDO includes 8 wooden posts and board.
- ▶ PDOPOSTS includes 4 wooden posts.
- ▶ Pegged board is $\frac{3}{8}$ " thick.
- ▶ Recommended for use in DB36, DB36-4, DBFP36, and DBFP36-4. Pegged board can be trimmed for use in smaller applications.
- ▶ Order under style #010.



Wood and Plastic Cutlery Tray

NOTES ✓

- ▶ Place a cabinet with a PCDT or WCDT next to the dishwasher for convenience.
- ▶ PCDT - plastic.
- ▶ WCDT - wood.
- ▶ PCDT is designed to fit in the Particle Board (PABD) drawer box only.
- ▶ The WCDT can be cut to fit either wood or Particle Board (PABD) drawer boxes.
- ▶ WCDT is not available in B12.

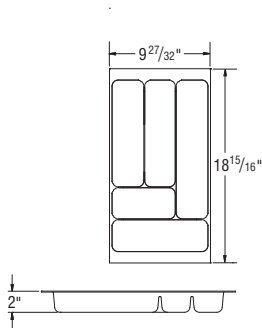

PCDT15

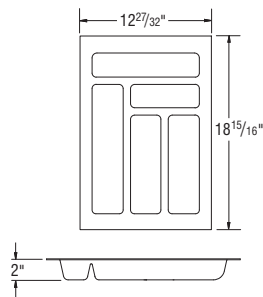

PCDT18

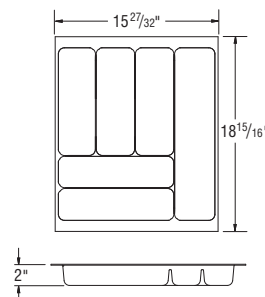

PCDT21

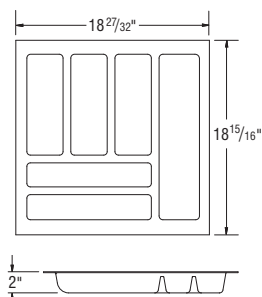

PCDT24

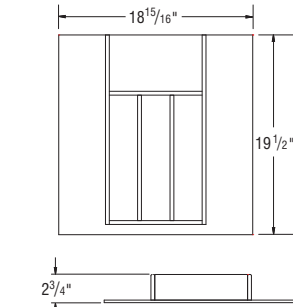

WCDT



SKU	Width	Depth	Usage Details
PCDT15	9 27/32"	18 15/16"	Designed to be used in 12 7/8" wide Particle Board Drawer boxes.
PCDT18	12 27/32"	18 15/16"	Designed to be used in 15 7/8" wide Particle Board Drawer boxes.
PCDT21	15 27/32"	18 15/16"	Designed to be used in 18 7/8" wide Particle Board Drawer boxes.
PCDT24	18 27/32"	18 15/16"	Designed to be used in 21 7/8" wide Particle Board Drawer boxes.
WCDT	18 15/16"	19 1/2"	Designed to fit in all-wood drawer boxes 15" or greater (Does not fit in a B12). Can be trimmed to fit in Particle Board Drawer boxes.

NOTES ✓

- ▶ Designed to capture spills and is removable for cleaning.
- ▶ Will contain a spill of up to 3 quarts (2.8 liters).
- ▶ CABMAT36 is not trimmable.

CabMat™

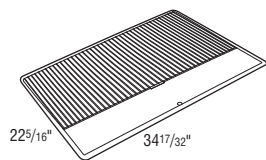

CABMAT36

NOTES ✓

- ▶ Meets KCMA standards of 15 lbs. per square foot.
- ▶ Cannot be trimmed.
- ▶ Kit includes two 1/4" thick tempered glass shelves and shelf clips.
- ▶ Order under style #010.

Glass Shelf Kits, 12" Deep

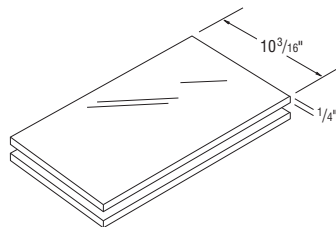

- GSK1512**
- GSK1812**
- GSK2112**
- GSK2412**
- GSK3012**
- GSK3612**



NOTES ✓

- ▶ Meets KCMA standards of 15 lbs. per square foot.
- ▶ Cannot be trimmed.
- ▶ Kit includes two 1/4" thick tempered glass shelves and shelf clips.
- ▶ Order under style #010.

Glass Shelf Kits, Diagonal

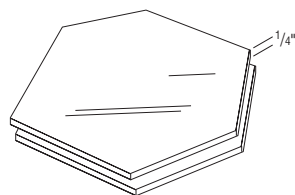

Fits DC...24
GSKDC24

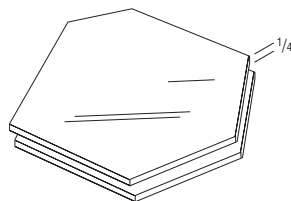

Fits DC...27
GSKDC27



Heat Shield, Angled

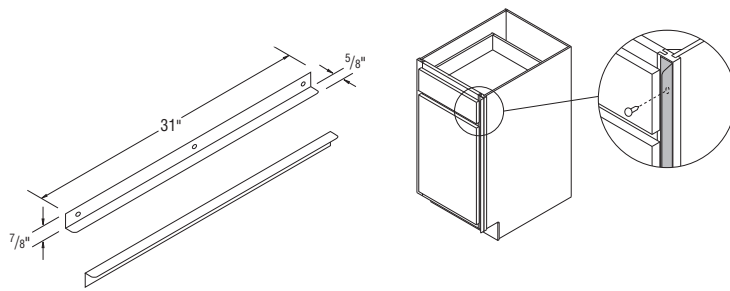

HEATSHIELDAN

NOTES ✓

- ▶ Sold in pairs.
- ▶ Used to deflect heat from self-cleaning ovens, away from cabinet doors and drawer fronts.
- ▶ Includes installation screws.
- ▶ White finish.
- ▶ For use on cabinets next to an oven/range when an additional $\frac{1}{8}$ " cannot be added to the oven manufacturer's recommended space requirement between the oven and each adjacent cabinet.
- ▶ Cabinet door cannot be hinged on the same side as the angled heat shield, not compatible with double door cabinets.
- ▶ Installs on the front of the face frame of each cabinet adjacent to the oven.



Heat Shield, Straight

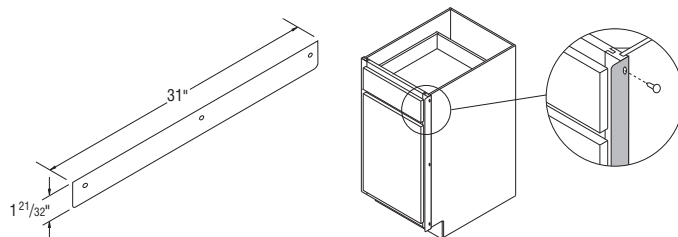

HEATSHIELDST

NOTES ✓

- ▶ Sold in pairs.
- ▶ Used to deflect heat from self-cleaning ovens, away from cabinet doors and drawer fronts.
- ▶ Includes installation screws.
- ▶ White finish.
- ▶ For use on cabinets next to an oven/range when an additional $\frac{1}{8}$ " can be added to the oven manufacturer's recommended space requirement.
- ▶ Installs on the side of the face frame of each cabinet adjacent to the oven.



Oven Installation Kit

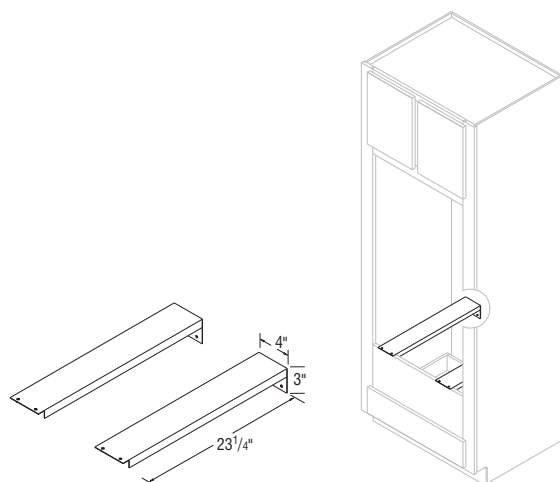

OCINSTALLKIT

NOTES ✓

- ▶ Two metal brackets to support ovens and microwaves.
- ▶ Designed to be used with OCSD, OD, and OMS cabinets.
- ▶ Cabinet not included.
- ▶ Order under style #010.



NOTES ✓

- ▶ Utility Shelf Kits contain two shelves and eight clips.
- ▶ Shelves are 3/4" thick.
- ▶ Maximum weight per square foot is 15 lbs.
- ▶ Utility Shelf Kits are natural maple laminate.
- ▶ Order under style #010.



Utility Shelf Kits

	Dimensions	Natural Maple Laminate	Plywood	Fits 12" Deep	Fits 24" Deep
UKS15	13 1/2" x 22 1/2"	✓			✓
UKS18	16 1/2" x 22 1/2"	✓			✓
UKS21	19 1/2" x 22 3/8"	✓			✓
UKS24	22 1/2" x 22 1/2"	✓			✓
UKS30	28 1/2" x 22 1/2"	✓			✓
UKS36	34 1/2" x 22 1/2"	✓			✓
UKS1512	13 1/2" x 10 11/32"	✓		✓	
UKS1812	16 1/2" x 10 11/32"	✓		✓	
UKS2112	19 1/2" x 10 11/32"	✓		✓	
UKS2412	22 1/2" x 10 11/32"	✓		✓	
UKS3012	28 1/2" x 10 11/32"	✓		✓	
UKS3612	34 1/2" x 10 11/32"	✓		✓	
UKS15PL	13 1/2" x 22 1/2"	✓	✓		✓
UKS18PL	16 1/2" x 22 1/2"	✓	✓		✓
UKS21PL	19 1/2" x 22 3/8"	✓	✓		✓
UKS24PL	22 1/2" x 22 1/2"	✓	✓		✓
UKS30PL	28 1/2" x 22 1/2"	✓	✓		✓
UKS36PL	34 1/2" x 22 1/2"	✓	✓		✓
UKS1512PL	13 1/2" x 10 11/32"	✓	✓	✓	
UKS1812PL	16 1/2" x 10 11/32"	✓	✓	✓	
UKS2112PL	19 1/2" x 10 11/32"	✓	✓	✓	
UKS2412PL	22 1/2" x 10 11/32"	✓	✓	✓	
UKS3012PL	28 1/2" x 10 11/32"	✓	✓	✓	
UKS3612PL	34 1/2" x 10 11/32"	✓	✓	✓	

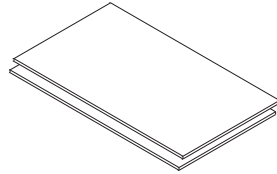

Utility Shelf Kit Shelves

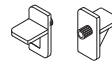

Utility Shelf Kit Clips

Pantry Roll Tray Kit

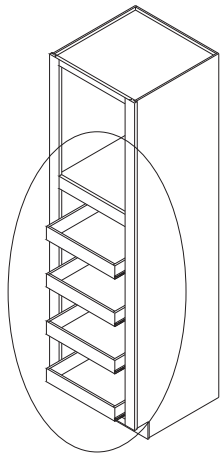

Pantry Roll Tray Kit

UPK15
UPK18
UPK21
UPK24
UPK30
UPK36

Model	Dimensions	Natural Maple Laminate	Thickness
UPK15	10 ¹¹ / ₁₆ " x 21 ¹³ / ₁₆ "	✓	3 ¹ / ₈ "
UPK18	13 ¹¹ / ₁₆ " x 21 ¹³ / ₁₆ "	✓	3 ¹ / ₈ "
UPK21	16 ¹¹ / ₁₆ " x 21 ¹³ / ₁₆ "	✓	3 ¹ / ₈ "
UPK24	19 ¹¹ / ₁₆ " x 21 ¹³ / ₁₆ "	✓	3 ¹ / ₈ "
UPK30	25 ¹¹ / ₁₆ " x 21 ¹³ / ₁₆ "	✓	3 ¹ / ₈ "
UPK36	31 ¹¹ / ₁₆ " x 21 ¹³ / ₁₆ "	✓	3 ¹ / ₈ "

NOTES ✓

- ▶ Pantry Roll Tray Kits feature 1/2" thick solid-wood front and furniture board sides and back.
- ▶ Pantry Roll Tray Kits contain four trays, eight suspension tracks, and eight bumper pads with installation screws.
- ▶ Maximum weight per square foot is 15 lbs.
- ▶ Pantry Roll Tray Kits cannot be used in any Utility cabinet 12" deep.
- ▶ Order under style #010.
- ▶ Smart Stop™ Pantry Roll Tray Kits are not available.

DESIGN SOLUTIONS

- ▶ Shelf or Roll Tray Kits can be used to convert a standard Utility cabinet into a Pantry.



Roll Tray Kits

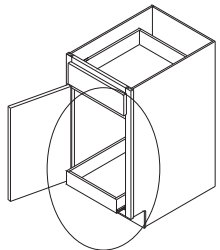

TKIT15
TKIT18
TKIT21
TKIT24
TKIT27
TKIT30
TKIT33
TKIT36
TKIT39
TKIT45

Model	Recommended Width of Face Frame Opening	Trays	Track Sliders	Mounting Blocks	2 1/2" Wood Screws	5/8" Wood Screws	1/8" Spacers
TKIT15	12"	1	2	2	2	4	2
TKIT18	15"	1	2	2	2	4	2
TKIT21	18"	1	2	2	2	4	2
TKIT24	21"	1	2	2	2	4	2
TKIT27	24"	1	2	2	2	4	2
TKIT30	27"	1	2	2	2	4	2
TKIT33	30"	1	2	2	2	4	2
TKIT36	33"	1	2	2	2	4	2
TKIT39	16 1/2"	2	4	4	2	8	2
TKIT45	19 1/2"	2	4	4	2	8	2

NOTES ✓

- ▶ Roll Tray Kits feature 1/2" thick solid-wood front and furniture board sides and back.
- ▶ Maximum weight per square foot is 15 lbs.
- ▶ All guides are white.
- ▶ Order under style #010.
- ▶ See Storage Accessories Matrix on pages 181 & 182.
- ▶ Bumper pads for field installation included.
- ▶ Smart Stop™ Roll Tray Kits are not available.

DESIGN SOLUTIONS

- ▶ An additional Roll-out Tray can be installed in place of the Base cabinet half depth shelf.



DESIGN SOLUTIONS

- ▶ Not recommended in BMD....FH, BMD....FHB, BPG....FH, BPG....FHB.
- ▶ Includes 1 divider, 3 clips.
- ▶ Tray divider is chrome wire.

Chrome Tray Divider Kit

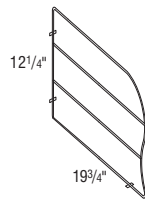

CTDK

NOTES ✓

- ▶ RTBP includes two bumpers and two screws for installation.
- ▶ Used to protect door from roll tray corners.
- ▶ Included with roll tray cabinets and with roll tray kits.
- ▶ Can be retrofit to all roll trays.
- ▶ Order under style #010.



Roll Tray Bumper Pad

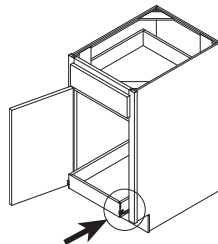

RTBP

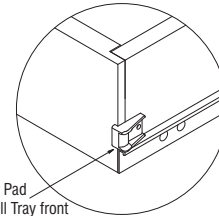

Place Bumper Pad on edge of Roll Tray front on top of Roll Tray Slide.

NOTES ✓

- ▶ White epoxy coated wire with Full extension guides (non Smart Stop™).
- ▶ Includes two 27 quart Wastebaskets with wire storage compartment.
- ▶ Mounted on white melamine board and installs to floor of cabinet.
- ▶ Order under style #010.
- ▶ Installation of this accessory requires removing half depth shelf. See matrix on pages 181 & 182 for installation recommendations.

Double Wastebasket Roll-out Kit

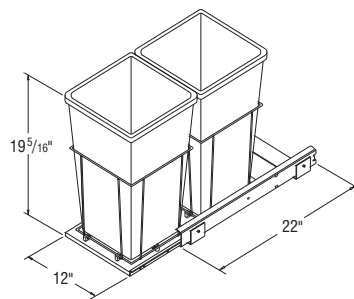

DWBR*

*Fits 15" wide Base cabinet.



Sink Tilt-Out Trays

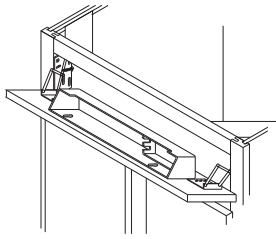

STOT30WHB
STOT36WHB

Model	Cabinet Width	Description
STOT30WHB	30"	two 11½" white trays, 2 hinges
STOT36WHB	36"	two 14½" white trays, 2 hinges

NOTES ✓

- ▶ Pulls to add to the false front must be ordered separately.
- ▶ If STOTs are used on a full overlay style, it is recommended that a pull be used.
- ▶ STOT30WHB & STOT36WHB are for cabinets with one false front.
- ▶ Two white trays, 2¼" deep.
- ▶ Order under style #010.
- ▶ See Storage Accessory Matrix on pages 181 & 182.



Smart Stop Door Mechanism

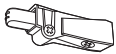

SSDM

NOTES ✓

- ▶ Creates a smooth and silent closing motion.
- ▶ Recommended usage per cabinet: 1 per door on any door with 2 hinges and 2 per door on any door with 3 or more hinges (cabinets under 36" high have 2 hinges, 36" and higher have 3 hinges). Additional units may be required when an accessory item is attached to the cabinet door.
- ▶ Not recommended for use on bifold doors or Base SuperCabinets™.



Hinges

HINGE6WAY*
HINGE6WAYSC *

*Order under door style number.

NOTES ✓

- ▶ For use to provide additional door adjustment in field.
- ▶ Designed to be placed between the face frame and hinge mounting plate.
- ▶ HNGSPCRF sold in pairs.
- ▶ HNGSPCRF50 sold in packs of 50.
- ▶ Use to decrease gap between BUTT door - insert behind screw on face frame.

Frame Spacers

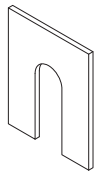

HNGSPCRF
HNGSPCRF50

NOTES ✓

- ▶ For use to provide additional door adjustment in field.
- ▶ Designed to be placed around the hinge cup and against the back of the door.
- ▶ HNGSPCRD sold in pairs.
- ▶ HNGSPCRD50 sold in packs of 50.
- ▶ Use to reduce appearance of a slight warp in a door - insert behind cup of hinge on door, opposite of warp.

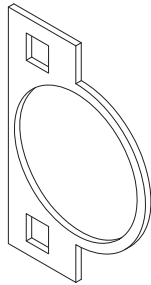

HNGSPCRD
HNGSPCRD50

Hinge Spacers

NOTES ✓

- ▶ For use in applications with cabinets installed at varying depths to prevent the door damage caused by opening into an adjacent cabinets.
- ▶ Restricts hinges to 86 degree opening capability.
- ▶ Not recommended for cabinets with roll trays specified in partial overlay styles.
- ▶ Sold in pairs.



HNGRESCLP

Hinge Angle Restrictor Clips

Stain, Toner, and Touch-up

Touch-up Kit

TUKIT*



Pint of Toner

TONERPT**



Pint of Stain

STAINPT**

Quart of Stain

STAINQT**

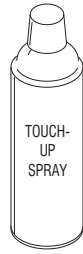

Touch-up Spray Can

TUPSPRAY****

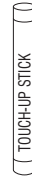

Touch-up Stick

TUPSTICK***

NOTES ✓

- ▶ Order 1 pint of Toner for 1 quart of Stain.
- ▶ For white and antique styles, Touch-up is only recommended for face frames and End Panels.
- ▶ Use Maple/Birch for Rustic finishes.



*Touch-up Kit contains one felt marker and one putty stick.

**TONEPT, STAINPT, and STAINQT are not available in Antique, Glacier Gray, Stone Gray, or White.

***Touch-up Stick – when ordering TUPSTICK, a single putty stick in the selected color is sent.

****TUPSPRAY is a 13 oz. can (400 ml)















Wood Species	Color	TONERPT Required	STAINPT or STAINQT Required
Cherry	Café	✓	✓
	Flagstone	✓	✓
	Java Glaze	✓	✓
	Pumpnickel Glaze	✓	✓
	Rouge	✓	✓
	Saddle	✓	✓
	Umber	✓	✓
	Wheat	•	✓
Hickory	Saddle	✓	✓
	Wheat	•	✓
Maple/Birch	Autumn	✓	✓
	Café	✓	✓
	Flagstone	✓	✓
	Java Glaze	✓	✓
	Pumpnickel Glaze	✓	✓
	Rouge	✓	✓
	Saddle	✓	✓
	Sarsaparilla	✓	✓
Oak	Umber	✓	✓
	Saddle	✓	✓
	Sarsaparilla	✓	✓
	Wheat	•	✓

















Hardware Chart

- ▶ Screws included with hardware.
- ▶ Order under style #010.
- ▶ Hardware is recommended for use on all full overlay and miter door styles (except Avalon and Radford). All other door styles have a reverse bevel and hardware is not required.
- ▶ **For 5-piece drawer front panel dimensions, please see page 180.**

*Hardware does not fit certain door styles with 5-piece drawers because of small width of recessed center drawer panel.



	PRODUCT CODE	Item Description	Finish/Color	Drill Center
	H311 *	Pull 5 ² / ₃ "	Antique Pewter	128mm
	H312 *	Cup Pull 4 ¹ / ₁₆ "	Antique Pewter	64mm
	H313	Knob 1 ¹ / ₄ "	Antique Pewter	N/A
	H412	Pull 7 ⁵ / ₁₆ "	Brushed Pewter	160mm
	H413	Knob 1 ¹ / ₄ "	Brushed Pewter	N/A
	H515	Pull 5 ¹³ / ₁₆ "	Brushed Nickel	128mm
	H516	Pull 4 ¹ / ₂ "	Brushed Nickel	96mm
	H315 *	Pull 5 ¹ / ₃ "	Brushed Satin Nickel	128mm
	H316	Knob 1 ¹ / ₄ "	Brushed Satin Nickel	N/A
	H332 *	Pull 5"	Brushed Satin Nickel	96mm
	H345	Knob 1 ¹ / ₄ "	Brushed Satin Nickel	N/A
	H346	Pull 4 ¹ / ₈ "	Brushed Satin Nickel	96mm
	H348	Knob 1 ¹¹ / ₁₆ "	Brushed Satin Nickel	N/A
	H349	Pull 7"	Brushed Satin Nickel	96mm
	H350	Pull 8 ¹ / ₈ "	Brushed Satin Nickel	128mm

	PRODUCT CODE	Item Description	Finish/Color	Drill Center
	H400	Pull 5"	Brushed Satin Nickel	96mm
	H401	Pull 6 ³ / ₄ "	Brushed Satin Nickel	128mm
	H402	Knob 1 ¹ / ₄ "	Brushed Satin Nickel	N/A
	H411	Pull 7"	Brushed Satin Nickel	6"
	H403	Pull 5"	Dark Bronze	96mm
	H404	Pull 6 ³ / ₄ "	Dark Bronze	128mm
	H405	Knob 1 ¹ / ₄ "	Dark Bronze	N/A
	H318 *	Pull 5 ⁵ / ₈ "	Flat Black	128mm
	H323	Knob 1 ¹ / ₄ "	Flat Black	N/A
	H416	Pull 4 ³ / ₁₆ "	Flat Black	96mm
	H417	Pull 6 ¹¹ / ₁₆ "	Flat Black	160mm
	H418	Knob 1 ³ / ₁₆ "	Flat Black	N/A
	H504	Pull 3 ³ / ₄ "	Gilded Bronze	96mm
	H505	Knob 1 ¹ / ₄ "	Gilded Bronze	N/A
	H506	Pull 5 ⁵ / ₈ "	Gilded Bronze	128mm
	H507	Knob 1 ¹ / ₄ "	Gilded Bronze	N/A

- ▶ Screws included with hardware.
- ▶ Order under style #010.
- ▶ Hardware is recommended for use on all full overlay and miter door styles (except Avalon and Radford). All other door styles have a reverse bevel and hardware is not required.

▶ For 5-piece drawer front panel dimensions, please see page 180.

*Hardware does not fit certain door styles with 5-piece drawers because of small width of recessed center drawer panel.



Hardware Chart

- ▶ Screws included with hardware.
- ▶ Order under style #010.
- ▶ Hardware is recommended for use on all full overlay and miter door styles (except Avalon and Radford). All other door styles have a reverse bevel and hardware is not required.

▶ **For 5-piece drawer front panel dimensions, please see page 180.**

*Hardware does not fit certain door styles with 5-piece drawers because of small width of recessed center drawer panel.



	PRODUCT CODE	Item Description	Finish/Color	Drill Center
	H419	Pull 5½"	Gun Metal	128mm
	H420	Knob 1¼"	Gun Metal	N/A
	H409	Pull 7"	Matte Black	6"
	H410	Knob 1¼"	Matte Black	N/A
	H333 *	Pull 4¾"	Oil Rubbed Bronze	4"
	H334	Knob 1¼"	Oil Rubbed Bronze	N/A
	H302 *	Pull 4¾"	Patina Black	4"
	H303	Knob 1¼"	Patina Black	N/A
	H500	Pull 4 ¹³ / ₁₆ "	Polished Chrome	96mm
	H501	Knob 1¾"	Polished Chrome	N/A
	H406	Pull 4¾"	Polished Chrome	96mm
	H407	Pull 5"	Polished Chrome	128mm
	H408	Knob 1⅞"	Polished Chrome	N/A
	H508	Knob 1¼"	Polished Chrome	N/A
	H512	Pull 6"	Polished Chrome	128mm

	PRODUCT CODE	Item Description	Finish/Color	Drill Center
	H513	Pull 5"	Polished Chrome	96mm
	H414	Pull 4 ¹³ / ₁₆ "	Polished Nickel	96mm
	H415	Pull 6 ¹ / ₁₆ "	Polished Nickel	128mm
	H503	Pull 3"	Satin Nickel	76mm
	H509	Knob 1 ³ / ₁₆ "	Satin Nickel	N/A
	H510	Pull 6 ⁵ / ₁₆ "	Satin Nickel	96mm
	H511	Pull 4 ³ / ₄ "	Satin Nickel	96mm
	H514	Pull 6"	Satin Nickel	128mm
	H336 *	Pull 5 ² / ₃ "	Venetian Bronze	128mm
	H340	Knob 1 ¹ / ₄ "	Venetian Bronze	N/A
	H421	Pull 5 ¹ / ₂ "	Venetian Bronze	128mm
	H422	Knob 1 ¹ / ₄ "	Venetian Bronze	N/A
	H517	Utility Hook 2 ¹³ / ₁₆ "	Satin Nickel	10mm
	H518	Utility Hook 2 ¹³ / ₁₆ "	Black	10mm
	H519	Utility Hook 2 ¹³ / ₁₆ "	Chrome	10mm
	H520	Utility Hook 2 ¹³ / ₁₆ "	Refined Bronze	10mm

- ▶ Screws included with hardware.
- ▶ Order under style #010.
- ▶ Hardware is recommended for use on all full overlay and miter door styles (except Avalon and Radford). All other door styles have a reverse bevel and hardware is not required.

▶ For 5-piece drawer front panel dimensions, please see page 180.

*Hardware does not fit certain door styles with 5-piece drawers because of small width of recessed center drawer panel.



5-piece Drawer Front Dimensions - Based on a 12" Wide Base Cabinet

5-PIECE STYLE NAME	DRAWER FRONT WIDTH	DRAWER FRONT HEIGHT	FLAT PANEL WIDTH	FLAT PANEL HEIGHT
Benton 5-piece	9 ⁷ / ₈ "	5 1 ¹ / ₈ "	5 ⁷ / ₈ "	1 1 ¹ / ₈ "
Briarcliff II	11 1 ¹ / ₂ "	5 ³ / ₄ "	6"	1 1 ¹ / ₈ "
Durham	11 1 ¹ / ₂ "	5 ³ / ₄ "	7 1 ¹ / ₂ "	1 ³ / ₄ "
Eastland 5-piece	11 1 ¹ / ₂ "	5 ³ / ₄ "	6"	1 1 ¹ / ₈ "
Harrison 5-piece	11 1 ¹ / ₂ "	5 ³ / ₄ "	7 1 ¹ / ₁₆ "	1 5 ¹ / ₁₆ "
Korbett 5-piece	11 1 ¹ / ₂ "	5 ³ / ₄ "	5 1 ¹ / ₂ "	1 5 ¹ / ₁₆ "
Landen 5-piece	9 ⁷ / ₈ "	5 1 ¹ / ₈ "	5 ⁷ / ₈ "	1 1 ¹ / ₈ "
Lillian	9 ⁷ / ₈ "	5 1 ¹ / ₈ "	5 ⁵ / ₈ "	7 ⁷ / ₈ "
Overton	11 1 ¹ / ₂ "	5 ³ / ₄ "	7 1 ¹ / ₂ "	1 ³ / ₄ "
Saybrooke 5-piece	9 ⁷ / ₈ "	5 1 ¹ / ₈ "	5 ⁷ / ₈ "	1 1 ¹ / ₈ "
Wentworth	11 1 ¹ / ₂ "	5 ³ / ₄ "	7 1 ¹ / ₂ "	1 ³ / ₄ "
Winstead 5-piece	11 1 ¹ / ₂ "	5 ³ / ₄ "	7 1 ¹ / ₁₆ "	1 5 ¹ / ₁₆ "

5-piece Drawer Front Dimensions - Based on a VSB36 Wide Cabinet

5-PIECE STYLE NAME	DRAWER FRONT WIDTH	DRAWER FRONT HEIGHT	FLAT PANEL WIDTH	FLAT PANEL HEIGHT
Benton 5-piece	7 ⁵ / ₈ "	5 1 ¹ / ₈ "	3 ⁵ / ₈ "	1 1 ¹ / ₈ "
Briarcliff II	9 1 ¹ / ₄ "	5 ³ / ₄ "	3 3 ³ / ₄ "	1 1 ¹ / ₈ "
Durham	9 1 ¹ / ₄ "	5 ³ / ₄ "	5 1 ¹ / ₄ "	1 ³ / ₄ "
Eastland 5-piece	9 1 ¹ / ₄ "	5 ³ / ₄ "	3 3 ³ / ₄ "	1 1 ¹ / ₈ "
Harrison 5-piece	9 1 ¹ / ₄ "	5 ³ / ₄ "	4 1 ¹³ / ₁₆ "	1 5 ¹ / ₁₆ "
Korbett 5-piece	9 1 ¹ / ₄ "	5 ³ / ₄ "	3 1 ¹ / ₄ "	1 5 ¹ / ₁₆ "
Landen 5-piece	7 ⁵ / ₈ "	5 1 ¹ / ₈ "	3 ⁵ / ₈ "	1 1 ¹ / ₈ "
Lillian	7 ⁵ / ₈ "	5 1 ¹ / ₈ "	3 ⁵ / ₈ "	7 ⁷ / ₈ "
Overton	9 1 ¹ / ₄ "	5 ³ / ₄ "	5 1 ¹ / ₄ "	1 ³ / ₄ "
Saybrooke 5-piece	7 ⁵ / ₈ "	5 1 ¹ / ₈ "	3 ⁵ / ₈ "	1 1 ¹ / ₈ "
Wentworth	9 1 ¹ / ₄ "	5 ³ / ₄ "	5 1 ¹ / ₄ "	1 ³ / ₄ "
Winstead 5-piece	9 1 ¹ / ₄ "	5 ³ / ₄ "	4 1 ¹³ / ₁₆ "	1 5 ¹ / ₁₆ "

Drawer Front sizes are representative of a VSB36 cabinet, smallest drawer front available.

Trim Items with Rustic Characteristics

Use Rustic Common Style Numbers to order items with Rustic Characteristics.
For all other trim items, use Maple Common Style Numbers (see page 25).

Product Code	Description	Page #
BBCPO	Base Box Column Pull-out Cabinet	91
MCROWN8	Moulding Crown	144
MICROWN8	Moulding Insert Crown	144
MFOLCR8	Moulding Full Overlay Crown	144
MTCROWN8	Moulding Tall Crown	144
MSHKRCROWN8	Moulding Shaker Crown	144
MSMCOVECR8	Moulding Small Cove Crown	144
MBS8	Moulding Base Shoe	149
FBC3X3	Filler - Base Corner	150
F3__ & F6__	Filler - Base & Tall Straight	150
V__RA & V__ST	Valance - Arch & Straight	158
PEPR335	Aristex™ End Panel with 3" Stile	159
PEPRPLY__35	Plywood End Panel with 1 1/2" or 3" Stile	159
PREF23__	Plywood Refrigerator End Panel	159
PREPRP_____	Plywood Refrigerator End Panel with 1 1/2" Stile	159
PREPR1.530__	Plywood 3/8" Refrigerator End Panel with 1 1/2" Stile	159
PREPR33096	Veneer Furniture Board Refrigerator End Panel with 3" Stile	159
PDWP	Dishwasher Front Panel	160
PP9635	Stock Panel	160
P48__	Stock Panel	160
EPV_____	Veneer End Panel	161

Traditional Storage Accessory Matrix

NOTES ✓

Cabinet	Double Wastebasket Roll-out	STOT30WHB Sink Tilt-out Tray 30" Two 1 1/2" trays, 2 hinges	STOT36WHB Sink Tilt-out Tray 36" Two 14 1/2" trays, 2 hinges	Roll-out Kit*
B12	•	•	•	•
B12TD	•	•	•	•
B15	H	•	•	TKIT15
B15RT	•	•	•	TKIT15
B18	H	•	•	TKIT18
B18RT	•	•	•	TKIT18
B21	H	•	•	TKIT21
B21RT	•	•	•	TKIT21
B24	H	•	•	TKIT24
B24RT	•	•	•	TKIT24
B24DD	H	•	•	TKIT24
B24DDRT	•	•	•	TKIT24
B27B	•	•	•	TKIT27
B27RTB	•	•	•	TKIT27
B30B	H	•	•	TKIT30
B30RTB	•	•	•	TKIT30
B33B	H	•	•	TKIT33
B33RTB	•	•	•	TKIT33
B36B	H	•	•	TKIT36
B36RTB	•	•	•	TKIT36
B39	H	•	•	TKIT39
B39RT	•	•	•	TKIT39
B42	H	•	•	TKIT21
B42RT	•	•	•	TKIT21
B45	H	•	•	TKIT45
B45RT	•	•	•	TKIT45
B48	H	•	•	TKIT24
B48RT	•	•	•	TKIT24
B15FH	✓	•	•	TKIT15
B18FH	I	•	•	TKIT18
B21FH	I	•	•	TKIT21
B24FH	I	•	•	TKIT24
B30FHB	I	•	•	TKIT30
B36FHB	I	•	•	TKIT36
BWB15FH	•	•	•	•
BWB18	•	•	•	•
BWB21	•	•	•	•
BWB15FHBMG	•	•	•	•
BWB18BMG	•	•	•	•
BWB21BMG	•	•	•	•
BC36	•	•	•	•
BC39	H	•	•	•
BC42	H	•	•	TKIT15
BC45	H	•	•	TKIT18
BC48	H	•	•	TKIT39
BC51	H	•	•	TKIT21
SCER36	•	•	•	•
SB24	P	I [†]	I [†]	TKIT24
SB24DD	P	I [†]	I [†]	TKIT24
SB27B	P	I [†]	•	TKIT27
SB30B	P	✓	•	TKIT30
SB33B	P	✓	•	TKIT33
SB36B	P	I	✓	TKIT36
SB39	P	•	•	TKIT39
SB42	P	•	•	TKIT21
SB45	P	•	•	TKIT45
SB48	P	•	•	TKIT24

KEY

- F** Must remove full depth shelf.
- H** Must remove half depth adjustable shelf.
- I** Can be installed without modification to cabinet.
- P** Location of plumbing should be checked prior to installation of storage accessory.
- ✓ Recommended for ideal fit, and can be installed without modification to cabinet.
- Not applicable.
- † Only one tray will fit.

KEY

- F** Must remove full depth shelf.
H Must remove half depth adjustable shelf.
I Can be installed without modification to cabinet.
P Location of plumbing should be checked prior to installation of storage accessory.
✓ Recommended for ideal fit, and can be installed without modification to cabinet.
• Not applicable.
† Only one tray will fit.

Traditional Storage Accessory Matrix

Cabinet	Double Wastebasket Roll-out	STOT30WHB Sink Tilt-out Tray 30" Two 11 1/2" trays, 2 hinges	STOT36WHB Sink Tilt-out Tray 36" Two 14 1/2" trays, 2 hinges	Roll-out Kit*
SBDC36	P	I †	•	•
SBDC42	P	I †	•	•
SF30 (POL)	P	•	•	•
SF30B (FOL)	P	I	•	•
SF36B (POL)	P	I	•	•
SF36B (FOL)	P	I	✓	•
SF42	P	•	•	•
SF48	P	•	•	•
SFC36	P	I †	•	•
SFC42	P	I †	I †	•
PB18	F	•	•	•
PB24	F	•	•	•
PB24DD	F	•	•	•
PB30B	F	•	•	•
PB36B	F	•	•	•
PB42	F	•	•	•
PB48	F	•	•	•
PBSC27B	F	•	•	•
PBSC42	F	•	•	•
PBSC48	F	•	•	•
U15/U1590/U1596	I	•	•	TKIT15
U18/U1890/U18596	I	•	•	TKIT18
U24/U2490/U2496	I	•	•	TKIT24
U30B/U3090B/U3096B	I	•	•	TKIT30
U36B/U3690B/U3696B	I	•	•	TKIT36
B30FH32.5B	I	•	•	TKIT30
B33FH32.5B	I	•	•	TKIT33
B36FH32.5B	I	•	•	TKIT36
SB3032.5B	•	✓	•	TKIT30
SB3632.5B	•	I	✓	TKIT36
U1832.5	I	•	•	TKIT18
U2432.5	I	•	•	TKIT24

Glass Size Chart for Wall Prepped for Glass Cabinets

	Briarcliff Durham Eastland Wentworth		Korbett Overton		Brellin Harrison Winstead		Benton Ellis Lillian Saybrooke		Landen		Ayden Avalon Oakland Radford Sinclair Westbury	
	Butt Doors		Butt Doors		Butt Doors		Butt Doors		Butt Doors		Butt Doors	
	Width	Height	Width	Height	Width	Height	Width	Height	Width	Height	Width	Height
RECOMMENDED GLASS SIZES												
BPG2412FH	18 ⁵ / ₈ "	25 ¹ / ₄ "	18 ¹ / ₄ "	24 ⁷ / ₈ "	19 ⁷ / ₈ "	26 ¹ / ₂ "	18 ¹ / ₄ "	25 ¹ / ₄ "	17 ¹ / ₈ "	24 ¹ / ₈ "	18 ⁵ / ₈ "	25 ⁵ / ₈ "
BPG2415FH	18 ⁵ / ₈ "	25 ¹ / ₄ "	18 ¹ / ₄ "	24 ⁷ / ₈ "	19 ⁷ / ₈ "	26 ¹ / ₂ "	18 ¹ / ₄ "	25 ¹ / ₄ "	17 ¹ / ₈ "	24 ¹ / ₈ "	18 ⁵ / ₈ "	25 ⁵ / ₈ "
BPG3012FHB	9 ¹³ / ₁₆ "	25 ¹ / ₄ "	9 7/16"	24 ⁷ / ₈ "	11 ¹ / ₁₆ "	26 ¹ / ₂ "	10 ¹ / ₄ "	25 ¹ / ₄ "	9 ⁵ / ₈ "	24 ¹ / ₈ "	10 ⁵ / ₈ "	25 ⁵ / ₈ "
BPG3015FHB	9 ¹³ / ₁₆ "	25 ¹ / ₄ "	9 ⁷ / ₁₆ "	24 ⁷ / ₈ "	11 ¹ / ₁₆ "	26 ¹ / ₂ "	10 ¹ / ₄ "	25 ¹ / ₄ "	9 ⁵ / ₈ "	24 ¹ / ₈ "	10 ⁵ / ₈ "	25 ⁵ / ₈ "
BPG3612FHB	12 ¹³ / ₁₆ "	25 ¹ / ₄ "	12 ¹ / ₁₆ "	24 ⁷ / ₈ "	14 ¹ / ₁₆ "	26 ¹ / ₂ "	13 ¹ / ₄ "	25 ¹ / ₄ "	12 ¹ / ₈ "	24 ¹ / ₈ "	13 ⁵ / ₈ "	25 ⁵ / ₈ "
BPG3615FHB	12 ¹³ / ₁₆ "	25 ¹ / ₄ "	12 ¹ / ₁₆ "	24 ⁷ / ₈ "	14 ¹ / ₁₆ "	26 ¹ / ₂ "	13 ¹ / ₄ "	25 ¹ / ₄ "	12 ¹ / ₈ "	24 ¹ / ₈ "	13 ⁵ / ₈ "	25 ⁵ / ₈ "
DCPG2414	9 ⁵ / ₈ "	8 ⁵ / ₈ "	9 ¹ / ₄ "	8 ¹ / ₄ "	10 ⁷ / ₈ "	9 ⁷ / ₈ "	12 ¹ / ₄ "	8 ¹ / ₄ "	11 ¹ / ₈ "	7 ¹ / ₈ "	12 ⁵ / ₈ "	8 ⁵ / ₈ "
DCPG2418	9 ⁵ / ₈ "	12 ⁵ / ₈ "	9 ¹ / ₄ "	12 ¹ / ₄ "	10 ⁷ / ₈ "	13 ⁷ / ₈ "	12 ¹ / ₄ "	12 ¹ / ₄ "	11 ¹ / ₈ "	11 ¹ / ₈ "	12 ⁵ / ₈ "	12 ⁵ / ₈ "
DCPG2424	9 ⁵ / ₈ "	18 ⁵ / ₈ "	9 ¹ / ₄ "	18 ¹ / ₄ "	10 ⁷ / ₈ "	19 ⁷ / ₈ "	12 ¹ / ₄ "	18 ¹ / ₄ "	11 ¹ / ₈ "	17 ¹ / ₈ "	12 ⁵ / ₈ "	18 ⁵ / ₈ "
DCPG2430	9 ⁵ / ₈ "	24 ⁵ / ₈ "	9 ¹ / ₄ "	24 ¹ / ₄ "	10 ⁷ / ₈ "	25 ⁷ / ₈ "	12 ¹ / ₄ "	24 ¹ / ₄ "	11 ¹ / ₈ "	23 ¹ / ₈ "	12 ⁵ / ₈ "	24 ⁵ / ₈ "
DCPG2436	9 ⁵ / ₈ "	30 ⁵ / ₈ "	9 ¹ / ₄ "	30 ¹ / ₄ "	10 ⁷ / ₈ "	31 ⁷ / ₈ "	12 ¹ / ₄ "	30 ¹ / ₄ "	11 ¹ / ₈ "	29 ¹ / ₈ "	12 ⁵ / ₈ "	30 ⁵ / ₈ "
DCPG2442	9 ⁵ / ₈ "	36 ⁵ / ₈ "	9 ¹ / ₄ "	36 ¹ / ₄ "	10 ⁷ / ₈ "	37 ⁷ / ₈ "	12 ¹ / ₄ "	36 ¹ / ₄ "	11 ¹ / ₈ "	35 ¹ / ₈ "	12 ⁵ / ₈ "	36 ⁵ / ₈ "
DCPG2714	9 ⁵ / ₈ "	8 ⁵ / ₈ "	9 ¹ / ₄ "	8 ¹ / ₄ "	10 ⁷ / ₈ "	9 ⁷ / ₈ "	12 ¹ / ₄ "	8 ¹ / ₄ "	11 ¹ / ₈ "	7 ¹ / ₈ "	12 ⁵ / ₈ "	8 ⁵ / ₈ "
DCPG2718	9 ⁵ / ₈ "	12 ⁵ / ₈ "	9 ¹ / ₄ "	12 ¹ / ₄ "	10 ⁷ / ₈ "	13 ⁷ / ₈ "	12 ¹ / ₄ "	12 ¹ / ₄ "	11 ¹ / ₈ "	11 ¹ / ₈ "	12 ⁵ / ₈ "	12 ⁵ / ₈ "
DCPG2724	9 ⁵ / ₈ "	18 ⁵ / ₈ "	9 ¹ / ₄ "	18 ¹ / ₄ "	10 ⁷ / ₈ "	19 ⁷ / ₈ "	12 ¹ / ₄ "	18 ¹ / ₄ "	11 ¹ / ₈ "	17 ¹ / ₈ "	12 ⁵ / ₈ "	18 ⁵ / ₈ "
DCPG2730	9 ⁵ / ₈ "	24 ⁵ / ₈ "	9 ¹ / ₄ "	24 ¹ / ₄ "	10 ⁷ / ₈ "	25 ⁷ / ₈ "	12 ¹ / ₄ "	24 ¹ / ₄ "	11 ¹ / ₈ "	23 ¹ / ₈ "	12 ⁵ / ₈ "	24 ⁵ / ₈ "
DCPG2736	9 ⁵ / ₈ "	30 ⁵ / ₈ "	9 ¹ / ₄ "	30 ¹ / ₄ "	10 ⁷ / ₈ "	31 ⁷ / ₈ "	12 ¹ / ₄ "	30 ¹ / ₄ "	11 ¹ / ₈ "	29 ¹ / ₈ "	12 ⁵ / ₈ "	30 ⁵ / ₈ "
DCPG2742	9 ⁵ / ₈ "	36 ⁵ / ₈ "	9 ¹ / ₄ "	36 ¹ / ₄ "	10 ⁷ / ₈ "	37 ⁷ / ₈ "	12 ¹ / ₄ "	36 ¹ / ₄ "	11 ¹ / ₈ "	35 ¹ / ₈ "	12 ⁵ / ₈ "	36 ⁵ / ₈ "
PWPG3024B	9 ¹³ / ₁₆ "	18 ⁵ / ₈ "	9 ⁷ / ₁₆ "	18 ¹ / ₄ "	11 ¹ / ₁₆ "	19 ⁷ / ₈ "	10 ¹ / ₄ "	18 ¹ / ₄ "	9 ⁵ / ₈ "	17 ¹ / ₈ "	10 ⁵ / ₈ "	18 ⁵ / ₈ "
PWPG3624B	12 ¹³ / ₁₆ "	18 ⁵ / ₈ "	12 ¹ / ₁₆ "	18 ¹ / ₄ "	14 ¹ / ₁₆ "	19 ⁷ / ₈ "	13 ¹ / ₄ "	18 ¹ / ₄ "	12 ¹ / ₈ "	17 ¹ / ₈ "	13 ⁵ / ₈ "	18 ⁵ / ₈ "
WPG1214	6 ⁵ / ₈ "	8 ⁵ / ₈ "	6 ¹ / ₄ "	8 ¹ / ₄ "	7 ⁷ / ₈ "	9 ⁷ / ₈ "	6 ¹ / ₄ "	8 ¹ / ₄ "	5 ⁵ / ₈ "	7 ⁵ / ₈ "	6 ⁵ / ₈ "	8 ⁵ / ₈ "
WPG1218	6 ⁵ / ₈ "	12 ⁵ / ₈ "	6 ¹ / ₄ "	12 ¹ / ₄ "	7 ⁷ / ₈ "	13 ⁷ / ₈ "	6 ¹ / ₄ "	12 ¹ / ₄ "	5 ⁵ / ₈ "	11 ¹ / ₈ "	6 ⁵ / ₈ "	12 ⁵ / ₈ "
WPG1230	6 ⁵ / ₈ "	24 ⁵ / ₈ "	6 ¹ / ₄ "	24 ¹ / ₄ "	7 ⁷ / ₈ "	25 ⁷ / ₈ "	6 ¹ / ₄ "	24 ¹ / ₄ "	5 ⁵ / ₈ "	23 ¹ / ₈ "	6 ⁵ / ₈ "	24 ⁵ / ₈ "
WPG1236	6 ⁵ / ₈ "	30 ⁵ / ₈ "	6 ¹ / ₄ "	30 ¹ / ₄ "	7 ⁷ / ₈ "	31 ⁷ / ₈ "	6 ¹ / ₄ "	30 ¹ / ₄ "	5 ⁵ / ₈ "	29 ¹ / ₈ "	6 ⁵ / ₈ "	30 ⁵ / ₈ "
WPG1242	6 ⁵ / ₈ "	36 ⁵ / ₈ "	6 ¹ / ₄ "	36 ¹ / ₄ "	7 ⁷ / ₈ "	37 ⁷ / ₈ "	6 ¹ / ₄ "	36 ¹ / ₄ "	5 ⁵ / ₈ "	35 ¹ / ₈ "	6 ⁵ / ₈ "	36 ⁵ / ₈ "
WPG1514	9 ⁵ / ₈ "	8 ⁵ / ₈ "	9 ¹ / ₄ "	8 ¹ / ₄ "	10 ⁷ / ₈ "	9 ⁷ / ₈ "	9 ¹ / ₄ "	8 ¹ / ₄ "	8 ⁵ / ₈ "	7 ⁵ / ₈ "	9 ⁵ / ₈ "	8 ⁵ / ₈ "
WPG1518	9 ⁵ / ₈ "	12 ⁵ / ₈ "	9 ¹ / ₄ "	12 ¹ / ₄ "	10 ⁷ / ₈ "	13 ⁷ / ₈ "	9 ¹ / ₄ "	12 ¹ / ₄ "	8 ⁵ / ₈ "	11 ¹ / ₈ "	9 ⁵ / ₈ "	12 ⁵ / ₈ "
WPG1530	9 ⁵ / ₈ "	24 ⁵ / ₈ "	9 ¹ / ₄ "	24 ¹ / ₄ "	10 ⁷ / ₈ "	25 ⁷ / ₈ "	9 ¹ / ₄ "	24 ¹ / ₄ "	8 ⁵ / ₈ "	23 ¹ / ₈ "	9 ⁵ / ₈ "	24 ⁵ / ₈ "
WPG1536/WPG153615	9 ⁵ / ₈ "	30 ⁵ / ₈ "	9 ¹ / ₄ "	30 ¹ / ₄ "	10 ⁷ / ₈ "	31 ⁷ / ₈ "	9 ¹ / ₄ "	30 ¹ / ₄ "	8 ⁵ / ₈ "	29 ¹ / ₈ "	9 ⁵ / ₈ "	30 ⁵ / ₈ "
WPG1542/WPG154215	9 ⁵ / ₈ "	36 ⁵ / ₈ "	9 ¹ / ₄ "	36 ¹ / ₄ "	10 ⁷ / ₈ "	37 ⁷ / ₈ "	9 ¹ / ₄ "	36 ¹ / ₄ "	8 ⁵ / ₈ "	35 ¹ / ₈ "	9 ⁵ / ₈ "	36 ⁵ / ₈ "
WPG1814	12 ⁵ / ₈ "	8 ⁵ / ₈ "	12 ¹ / ₄ "	8 ¹ / ₄ "	13 ⁷ / ₈ "	9 ⁷ / ₈ "	12 ¹ / ₄ "	8 ¹ / ₄ "	11 ¹ / ₈ "	7 ⁵ / ₈ "	12 ⁵ / ₈ "	8 ⁵ / ₈ "
WPG1818	12 ⁵ / ₈ "	12 ⁵ / ₈ "	12 ¹ / ₄ "	12 ¹ / ₄ "	13 ⁷ / ₈ "	13 ⁷ / ₈ "	12 ¹ / ₄ "	12 ¹ / ₄ "	11 ¹ / ₈ "	11 ¹ / ₈ "	12 ⁵ / ₈ "	12 ⁵ / ₈ "
WPG1830	12 ⁵ / ₈ "	24 ⁵ / ₈ "	12 ¹ / ₄ "	24 ¹ / ₄ "	13 ⁷ / ₈ "	25 ⁷ / ₈ "	12 ¹ / ₄ "	24 ¹ / ₄ "	11 ¹ / ₈ "	23 ¹ / ₈ "	12 ⁵ / ₈ "	24 ⁵ / ₈ "
WPG1836/WPG183615	12 ⁵ / ₈ "	30 ⁵ / ₈ "	12 ¹ / ₄ "	30 ¹ / ₄ "	13 ⁷ / ₈ "	31 ⁷ / ₈ "	12 ¹ / ₄ "	30 ¹ / ₄ "	11 ¹ / ₈ "	29 ¹ / ₈ "	12 ⁵ / ₈ "	30 ⁵ / ₈ "
WPG1842/WPG184215	12 ⁵ / ₈ "	36 ⁵ / ₈ "	12 ¹ / ₄ "	36 ¹ / ₄ "	13 ⁷ / ₈ "	37 ⁷ / ₈ "	12 ¹ / ₄ "	36 ¹ / ₄ "	11 ¹ / ₈ "	35 ¹ / ₈ "	12 ⁵ / ₈ "	36 ⁵ / ₈ "
WPG2114	15 ⁵ / ₈ "	8 ⁵ / ₈ "	15 ¹ / ₄ "	8 ¹ / ₄ "	16 ⁷ / ₈ "	9 ⁷ / ₈ "	15 ¹ / ₄ "	8 ¹ / ₄ "	14 ¹ / ₈ "	7 ⁵ / ₈ "	15 ⁵ / ₈ "	8 ⁵ / ₈ "
WPG2118	15 ⁵ / ₈ "	12 ⁵ / ₈ "	15 ¹ / ₄ "	12 ¹ / ₄ "	16 ⁷ / ₈ "	13 ⁷ / ₈ "	15 ¹ / ₄ "	12 ¹ / ₄ "	14 ¹ / ₈ "	11 ¹ / ₈ "	15 ⁵ / ₈ "	12 ⁵ / ₈ "
WPG2130/WPG213016	15 ⁵ / ₈ "	24 ⁵ / ₈ "	15 ¹ / ₄ "	24 ¹ / ₄ "	16 ⁷ / ₈ "	25 ⁷ / ₈ "	15 ¹ / ₄ "	24 ¹ / ₄ "	14 ¹ / ₈ "	23 ¹ / ₈ "	15 ⁵ / ₈ "	24 ⁵ / ₈ "
WPG2136/WPG213615	15 ⁵ / ₈ "	30 ⁵ / ₈ "	15 ¹ / ₄ "	30 ¹ / ₄ "	16 ⁷ / ₈ "	31 ⁷ / ₈ "	15 ¹ / ₄ "	30 ¹ / ₄ "	14 ¹ / ₈ "	29 ¹ / ₈ "	15 ⁵ / ₈ "	30 ⁵ / ₈ "
WPG2142/WPG214215	15 ⁵ / ₈ "	36 ⁵ / ₈ "	15 ¹ / ₄ "	36 ¹ / ₄ "	16 ⁷ / ₈ "	37 ⁷ / ₈ "	15 ¹ / ₄ "	36 ¹ / ₄ "	14 ¹ / ₈ "	35 ¹ / ₈ "	15 ⁵ / ₈ "	36 ⁵ / ₈ "
WPG2414	18 ⁵ / ₈ "	8 ⁵ / ₈ "	18 ¹ / ₄ "	8 ¹ / ₄ "	19 ⁷ / ₈ "	9 ⁷ / ₈ "	18 ¹ / ₄ "	8 ¹ / ₄ "	17 ¹ / ₈ "	7 ⁵ / ₈ "	18 ⁵ / ₈ "	8 ⁵ / ₈ "
WPG2418	18 ⁵ / ₈ "	12 ⁵ / ₈ "	18 ¹ / ₄ "	12 ¹ / ₄ "	19 ⁷ / ₈ "	13 ⁷ / ₈ "	18 ¹ / ₄ "	12 ¹ / ₄ "	17 ¹ / ₈ "	11 ¹ / ₈ "	18 ⁵ / ₈ "	12 ⁵ / ₈ "
WPG2424	18 ⁵ / ₈ "	18 ⁵ / ₈ "	18 ¹ / ₄ "	18 ¹ / ₄ "	19 ⁷ / ₈ "	19 ⁷ / ₈ "	18 ¹ / ₄ "	18 ¹ / ₄ "	17 ¹ / ₈ "	17 ¹ / ₈ "	18 ⁵ / ₈ "	18 ⁵ / ₈ "
WPG2430/WPG243015	18 ⁵ / ₈ "	24 ⁵ / ₈ "	18 ¹ / ₄ "	24 ¹ / ₄ "	19 ⁷ / ₈ "	25 ⁷ / ₈ "	18 ¹ / ₄ "	24 ¹ / ₄ "	17 ¹ / ₈ "	23 ¹ / ₈ "	18 ⁵ / ₈ "	24 ⁵ / ₈ "
WPG2436/WPG243615	18 ⁵ / ₈ "	30 ⁵ / ₈ "	18 ¹ / ₄ "	30 ¹ / ₄ "	19 ⁷ / ₈ "	31 ⁷ / ₈ "	18 ¹ / ₄ "	30 ¹ / ₄ "	17 ¹ / ₈ "	29 ¹ / ₈ "	18 ⁵ / ₈ "	30 ⁵ / ₈ "
WPG2442/WPG244215	18 ⁵ / ₈ "	36 ⁵ / ₈ "	18 ¹ / ₄ "	36 ¹ / ₄ "	19 ⁷ / ₈ "	37 ⁷ / ₈ "	18 ¹ / ₄ "	36 ¹ / ₄ "	17 ¹ / ₈ "	35 ¹ / ₈ "	18 ⁵ / ₈ "	36 ⁵ / ₈ "
WPG2436DD	6 ¹³ / ₁₆ "	30 ⁵ / ₈ "	6 ⁷ / ₁₆ "	30 ¹ / ₄ "	8 ¹ / ₁₆ "	31 ⁷ / ₈ "	7 ¹ / ₄ "	30 ¹ / ₄ "	6 ¹ / ₈ "	29 ¹		

Glass Size Chart for Wall Prepped for Glass Cabinets

	Briarcliff Durham Eastland Wentworth		Korbett Overton		Brellin Harrison Winstead		Benton Ellis Lillian Saybrooke		Landen		Ayden Avalon Oakland Radford Sinclair Westbury	
	Butt Doors		Butt Doors		Butt Doors		Butt Doors		Butt Doors		Butt Doors	
	Width	Height	Width	Height	Width	Height	Width	Height	Width	Height	Width	Height
RECOMMENDED GLASS SIZES												
WPG3318B	11 ⁵ / ₁₆ "	12 ⁵ / ₈ "	10 ¹⁵ / ₁₆ "	12 ¹ / ₄ "	12 ¹ / ₁₆ "	13 ⁷ / ₈ "	11 ³ / ₄ "	12 ¹ / ₄ "	10 ⁵ / ₈ "	11 ¹ / ₈ "	12 ¹ / ₈ "	12 ⁵ / ₈ "
WPG3324B	11 ⁵ / ₁₆ "	18 ⁵ / ₈ "	10 ¹⁵ / ₁₆ "	18 ¹ / ₄ "	12 ² / ₁₆ "	19 ⁷ / ₈ "	11 ³ / ₄ "	18 ¹ / ₄ "	10 ⁵ / ₈ "	17 ¹ / ₈ "	12 ¹ / ₈ "	18 ⁵ / ₈ "
WPG3330B/WPG333015B	11 ⁵ / ₁₆ "	24 ⁵ / ₈ "	10 ¹⁵ / ₁₆ "	24 ¹ / ₄ "	12 ² / ₁₆ "	25 ⁵ / ₈ "	11 ³ / ₄ "	24 ¹ / ₄ "	10 ⁵ / ₈ "	23 ¹ / ₈ "	12 ¹ / ₈ "	24 ⁵ / ₈ "
WPG3336B/WPG333615B	11 ⁵ / ₁₆ "	30 ⁵ / ₈ "	10 ¹⁵ / ₁₆ "	30 ¹ / ₄ "	12 ² / ₁₆ "	31 ⁷ / ₈ "	11 ³ / ₄ "	30 ¹ / ₄ "	10 ⁵ / ₈ "	29 ¹ / ₈ "	12 ¹ / ₈ "	30 ⁵ / ₈ "
WPG3342B/WPG334215B	11 ⁵ / ₁₆ "	36 ⁵ / ₈ "	10 ¹⁵ / ₁₆ "	36 ¹ / ₄ "	12 ² / ₁₆ "	37 ⁷ / ₈ "	11 ³ / ₄ "	36 ¹ / ₄ "	10 ⁵ / ₈ "	35 ¹ / ₈ "	12 ¹ / ₈ "	36 ⁵ / ₈ "
WPG3612B	12 ¹³ / ₁₆ "	6 ⁵ / ₈ "	12 ¹ / ₁₆ "	6 ¹ / ₄ "	14 ¹ / ₁₆ "	7 ⁷ / ₈ "	13 ³ / ₄ "	6 ¹ / ₄ "	12 ¹ / ₈ "	5 ¹ / ₈ "	13 ⁵ / ₈ "	6 ⁵ / ₈ "
WPG3614B	12 ¹³ / ₁₆ "	8 ⁵ / ₈ "	12 ¹ / ₁₆ "	8 ¹ / ₄ "	14 ¹ / ₁₆ "	9 ⁷ / ₈ "	13 ³ / ₄ "	8 ¹ / ₄ "	12 ¹ / ₈ "	7 ¹ / ₈ "	13 ⁵ / ₈ "	8 ⁵ / ₈ "
WPG3618B	12 ¹³ / ₁₆ "	12 ⁵ / ₈ "	12 ¹ / ₁₆ "	12 ¹ / ₄ "	14 ¹ / ₁₆ "	13 ⁷ / ₈ "	13 ³ / ₄ "	12 ¹ / ₄ "	12 ¹ / ₈ "	11 ¹ / ₈ "	13 ⁵ / ₈ "	12 ⁵ / ₈ "
WPG3621B/WPG362115B	12 ¹³ / ₁₆ "	15 ⁵ / ₈ "	12 ¹ / ₁₆ "	15 ¹ / ₄ "	14 ¹ / ₁₆ "	16 ⁷ / ₈ "	13 ³ / ₄ "	15 ¹ / ₄ "	12 ¹ / ₈ "	14 ¹ / ₈ "	13 ⁵ / ₈ "	15 ⁵ / ₈ "
WPG3624B/WPG362415B	12 ¹³ / ₁₆ "	18 ⁵ / ₈ "	12 ¹ / ₁₆ "	18 ¹ / ₄ "	14 ¹ / ₁₆ "	19 ⁷ / ₈ "	13 ³ / ₄ "	18 ¹ / ₄ "	12 ¹ / ₈ "	17 ¹ / ₈ "	13 ⁵ / ₈ "	18 ⁵ / ₈ "
WPG3630B/WPG363015B	12 ¹³ / ₁₆ "	24 ⁵ / ₈ "	12 ¹ / ₁₆ "	24 ¹ / ₄ "	14 ¹ / ₁₆ "	25 ⁵ / ₈ "	13 ³ / ₄ "	24 ¹ / ₄ "	12 ¹ / ₈ "	23 ¹ / ₈ "	13 ⁵ / ₈ "	24 ⁵ / ₈ "
WPG3636B/WPG363615B	12 ¹³ / ₁₆ "	30 ⁵ / ₈ "	12 ¹ / ₁₆ "	30 ¹ / ₄ "	14 ¹ / ₁₆ "	31 ⁷ / ₈ "	13 ³ / ₄ "	30 ¹ / ₄ "	12 ¹ / ₈ "	29 ¹ / ₈ "	13 ⁵ / ₈ "	30 ⁵ / ₈ "
WPG3642B/WPG364215B	12 ¹³ / ₁₆ "	36 ⁵ / ₈ "	12 ¹ / ₁₆ "	36 ¹ / ₄ "	14 ¹ / ₁₆ "	37 ⁷ / ₈ "	13 ³ / ₄ "	36 ¹ / ₄ "	12 ¹ / ₈ "	35 ¹ / ₈ "	13 ⁵ / ₈ "	36 ⁵ / ₈ "
WPG3912	14 ¹ / ₈ "	6 ⁵ / ₈ "	13 ³ / ₄ "	6 ¹ / ₄ "	15 ³ / ₈ "	7 ⁷ / ₈ "	13 ³ / ₄ "	6 ¹ / ₄ "	12 ⁵ / ₈ "	5 ¹ / ₈ "	14 ¹ / ₈ "	6 ⁵ / ₈ "
WPG3914	14 ¹ / ₈ "	8 ⁵ / ₈ "	13 ³ / ₄ "	8 ¹ / ₄ "	15 ³ / ₈ "	9 ⁷ / ₈ "	13 ³ / ₄ "	8 ¹ / ₄ "	12 ⁵ / ₈ "	7 ¹ / ₈ "	14 ¹ / ₈ "	8 ⁵ / ₈ "
WPG3918	14 ¹ / ₈ "	12 ⁵ / ₈ "	13 ³ / ₄ "	12 ¹ / ₄ "	15 ³ / ₈ "	13 ⁷ / ₈ "	13 ³ / ₄ "	12 ¹ / ₄ "	12 ⁵ / ₈ "	11 ¹ / ₈ "	14 ¹ / ₈ "	12 ⁵ / ₈ "
WPG3930/WPG393015	14 ¹ / ₈ "	24 ⁵ / ₈ "	13 ³ / ₄ "	24 ¹ / ₄ "	15 ³ / ₈ "	25 ⁵ / ₈ "	13 ³ / ₄ "	24 ¹ / ₄ "	12 ⁵ / ₈ "	23 ¹ / ₈ "	14 ¹ / ₈ "	24 ⁵ / ₈ "
WPG4212 (MIDDLE)	9 ⁵ / ₈ "	6 ⁵ / ₈ "	9 ¹ / ₄ "	6 ¹ / ₄ "	10 ⁷ / ₈ "	7 ⁷ / ₈ "	9 ¹ / ₄ "	6 ¹ / ₄ "	8 ¹ / ₈ "	5 ¹ / ₈ "	9 ⁵ / ₈ "	6 ⁵ / ₈ "
WPG4212 (OUTER)	8 ¹ / ₈ "	6 ⁵ / ₈ "	7 ³ / ₄ "	6 ¹ / ₄ "	9 ³ / ₈ "	7 ⁷ / ₈ "	7 ³ / ₄ "	6 ¹ / ₄ "	6 ⁵ / ₈ "	5 ¹ / ₈ "	8 ¹ / ₈ "	6 ⁵ / ₈ "
WPG4214 (MIDDLE)	9 ⁵ / ₈ "	8 ⁵ / ₈ "	9 ¹ / ₄ "	8 ¹ / ₄ "	10 ⁷ / ₈ "	9 ⁷ / ₈ "	9 ¹ / ₄ "	8 ¹ / ₄ "	8 ¹ / ₈ "	7 ¹ / ₈ "	9 ⁵ / ₈ "	8 ⁵ / ₈ "
WPG4214 (OUTER)	8 ¹ / ₈ "	8 ⁵ / ₈ "	7 ³ / ₄ "	8 ¹ / ₄ "	9 ³ / ₈ "	9 ⁷ / ₈ "	7 ³ / ₄ "	8 ¹ / ₄ "	6 ⁵ / ₈ "	7 ¹ / ₈ "	8 ¹ / ₈ "	8 ⁵ / ₈ "
WPG4218	15 ⁵ / ₈ "	12 ⁵ / ₈ "	15 ¹ / ₄ "	12 ¹ / ₄ "	16 ⁷ / ₈ "	13 ⁷ / ₈ "	15 ¹ / ₄ "	12 ¹ / ₄ "	14 ¹ / ₈ "	11 ¹ / ₈ "	15 ⁵ / ₈ "	12 ⁵ / ₈ "
WPG4230/WPG423015	15 ⁵ / ₈ "	24 ⁵ / ₈ "	15 ¹ / ₄ "	24 ¹ / ₄ "	16 ⁷ / ₈ "	25 ⁵ / ₈ "	15 ¹ / ₄ "	24 ¹ / ₄ "	14 ¹ / ₈ "	23 ¹ / ₈ "	15 ⁵ / ₈ "	24 ⁵ / ₈ "
WPG4530/WPG453015	17 ¹ / ₈ "	24 ⁵ / ₈ "	16 ³ / ₄ "	24 ¹ / ₄ "	18 ³ / ₈ "	25 ⁵ / ₈ "	16 ³ / ₄ "	24 ¹ / ₄ "	15 ⁵ / ₈ "	23 ¹ / ₈ "	17 ¹ / ₈ "	24 ⁵ / ₈ "
WPG4812 (MIDDLE)	9 ⁵ / ₈ "	6 ⁵ / ₈ "	9 ¹ / ₄ "	6 ¹ / ₄ "	10 ⁷ / ₈ "	7 ⁷ / ₈ "	9 ¹ / ₄ "	6 ¹ / ₄ "	8 ¹ / ₈ "	5 ¹ / ₈ "	9 ⁵ / ₈ "	6 ⁵ / ₈ "
WPG4812 (OUTER)	11 ¹ / ₈ "	6 ⁵ / ₈ "	10 ³ / ₄ "	6 ¹ / ₄ "	12 ³ / ₈ "	7 ⁷ / ₈ "	10 ³ / ₄ "	6 ¹ / ₄ "	9 ⁵ / ₈ "	5 ¹ / ₈ "	11 ¹ / ₈ "	6 ⁵ / ₈ "
WPG4814 (MIDDLE)	9 ⁵ / ₈ "	8 ⁵ / ₈ "	9 ¹ / ₄ "	8 ¹ / ₄ "	10 ⁷ / ₈ "	9 ⁷ / ₈ "	9 ¹ / ₄ "	8 ¹ / ₄ "	8 ¹ / ₈ "	7 ¹ / ₈ "	9 ⁵ / ₈ "	8 ⁵ / ₈ "
WPG4814 (OUTER)	11 ¹ / ₈ "	8 ⁵ / ₈ "	10 ³ / ₄ "	8 ¹ / ₄ "	12 ³ / ₈ "	9 ⁷ / ₈ "	10 ³ / ₄ "	8 ¹ / ₄ "	9 ⁵ / ₈ "	7 ¹ / ₈ "	11 ¹ / ₈ "	8 ⁵ / ₈ "
WPG4830	18 ⁵ / ₈ "	24 ⁵ / ₈ "	18 ¹ / ₄ "	24 ¹ / ₄ "	19 ⁷ / ₈ "	25 ⁵ / ₈ "	18 ¹ / ₄ "	24 ¹ / ₄ "	17 ¹ / ₈ "	23 ¹ / ₈ "	18 ⁵ / ₈ "	24 ⁵ / ₈ "

ACCESSORIES AND PARTS

Aristokraft cabinetry is constructed to strict specifications, including the moisture content present in wood. When the moisture content is maintained at a constant level, Aristokraft is able to minimize the amount of expansion and contraction associated with natural wood. When a great amount of expansion and contraction occur, the result can be a warped door. By strictly controlling the amount of humidity present during manufacturing, Aristokraft is helping to ensure you receive a quality product.

Because wood is a natural product, each piece of wood exhibits its own unique color and grain variations. These differences give wood its genuine beauty. The wood's natural properties also determine how each individual piece will react to changing weather conditions. Therefore, eliminating warped doors is virtually impossible.

If you feel that you have a warped door, Aristokraft requires that you perform initial testing to determine the extent of the problem.

1. Remove the door from the cabinet and remove all decorative surface knobs or pulls and hinges.
2. Place the door on a completely flat surface, as determined by using a level, and alternately press on the opposite corners to observe if the door "rocks" or pulls away from the flat surface.
3. If you observe a gap between the door and flat surface, measure the distance to determine the amount of warpage.
 - A door must be warped at least 1/4" before it can be considered for replacement. When ordering a replacement by using Aristokraft Part Replacement Order Form, be sure to fill in the reason for proper replacement code as "06".
 - If the door is warped less than 1/4", we recommend you allow a complete heating and cooling cycle (summer to winter) to allow the door to reach moisture equilibrium. Adding magnetic catches or roller catches will often correct minor problems.
4. If the door does not pull away from the flat surface, it is not warped. Most likely, there is a problem with the cabinet installation. When cabinets are not properly installed in a level or plumb position, they will become racked and will cause the door to appear warped. To check for a racked cabinet, place a level on one end rail. The bubble in the level will appear centered if the cabinet was properly installed in a level position. Now, place the level on the other end rail. Again, if the bubble appears centered the cabinet is properly installed in a level position. Any variations in the location of the bubble will indicate the cabinet was not properly installed. (A plumb bob will reveal the same information.)

Another proper installation check is to place the level in the top, and then bottom of the installed cabinet's face frame. Identify the bubble's position in both, top and bottom, locations of the face frame. The bubble's position will indicate if the cabinet was not properly installed.

Cabinet Care Suggestions

Cleaning Tip: Never use a dishcloth to clean or dry cabinet exteriors or interiors. Remnants of detergent or grease may be contained within the dishcloth.

Interiors: Aristokraft cabinet interiors are surfaced with Aristex™, a quality laminate material that resists scuffs, marks, and most common household spills.

1. To clean the interior surface, simply wipe with a damp cloth or sponge, then dry.
2. To remove food residue or grease, use the suds from any common dishwashing liquid and a damp cloth to wipe clean. Dry thoroughly.

CAUTION: If a spill occurs, it is important to clean up the spill and dry the surface immediately. A spill left unattended will soak through the Aristex™ and cause damage.

Exteriors — Wood Finish: Aristokraft wood exteriors are manufactured with a quality finish that protects the wood and brings out its full beauty. To maintain your cabinets' appearance, Aristokraft recommends cleaning them at least once a month.

1. Simply wipe the surface of your cabinets with a clean damp cloth, then dry.
2. To remove general soil or grease, use the suds from any common dishwashing liquid and a damp cloth to wipe clean. Dry thoroughly.
3. Excess moisture can damage any cabinet finish; areas near the sink, range, dishwasher, oven and baseboards are the most susceptible. Keep these surfaces dry.
4. Because Aristokraft uses a quality varnish on the finish, waxing your cabinets is not necessary. If waxing is preferred, use any furniture polish or lemon oil recommended for fine furniture. Be sure to completely wipe off the excess wax to avoid build-up.

CAUTION: Avoid using cleaners that contain bleach, ammonia or state on the label they have any type of abrasives. These cleaners can cause damage to your cabinet finish.

Exteriors — PureStyle™/Thermofoil: Some Aristokraft styles use doors and drawer fronts with a laminate or thermofoil finish. To clean this type of finish, Aristokraft recommends the same procedure described for wood exteriors.

Discontinued Product Policy

- A minimum of 60 days notice will be given to customers announcing the discontinuation of a product.
- Product will no longer be available to order after the discontinuation date. Only warranty orders will be considered. With warranty orders, Aristokraft will have the option to repair or replace a customer's defective product with the same discontinued product they originally purchased or with a current product that is similar in appearance.

Freight Policy

- If an entire order is no charge, Aristokraft will pay for standard ground freight.
- If an order contains a chargeable item, the cost of freight will be charged to the customer's invoice.
- If a customer requests an upgrade to a parcel shipment method, the customer will be charged the entire freight charge.

Returned Goods Policy

- All cabinets are manufactured according to the individual order and cannot be changed, cancelled, or returned once order has been scheduled.

Transportation Claims

- Please inspect merchandise at time of signing freight bill, and have the transportation company note any damage incurred in transit.

Disclosure

- Prices and specifications are subject to change without notice.

Aristokraft Warranty

Aristokraft has a Five Year Limited Warranty. For terms & conditions, please visit: <https://www.aristokraft.com/warranty>

Sales Rep: _____

Rep Phone: _____

Customer Service

Hours: M-F, 7:30am – 8:00pm E.D.T.

Phone: (877) 779-9293

Fax: (877) 333-7122

Aristokraft®

www.aristokraft.com



Part of the
MasterBrand®
Family

Styles, product availability and construction may vary slightly from those shown in this book due to material availability and/or design evolution. Specifications are subject to change without notice. Customer service is available if your design requires verification of product availability and specifications. Product photography and illustrations have been reproduced as accurately as printing technologies permit. To ensure highest satisfaction, we strongly recommend you view an actual sample for best color, wood grain and finish representation.

masterbrand.com
© 2019 MasterBrand Cabinets, Inc.