

Excel

Grow Light, 230V or 110-240V, 630W

Data Sheet

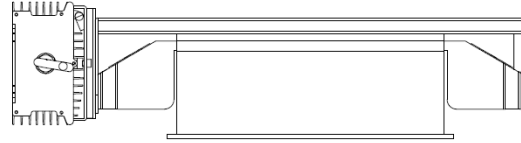
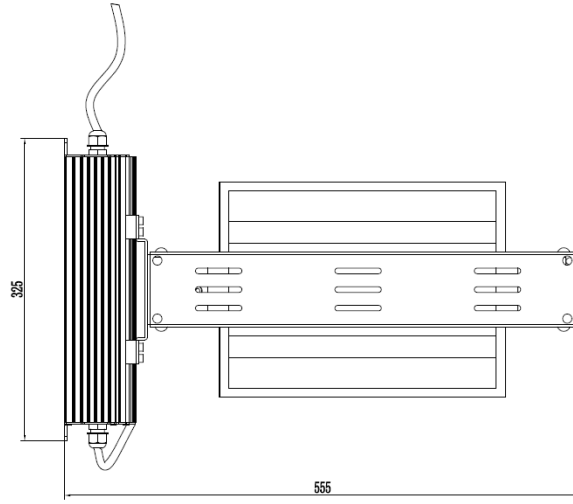
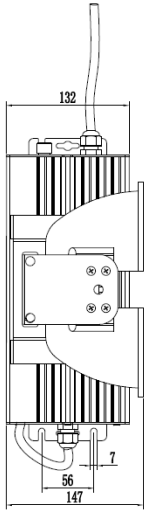

110-240V

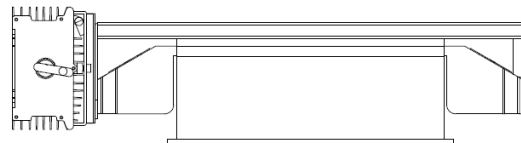
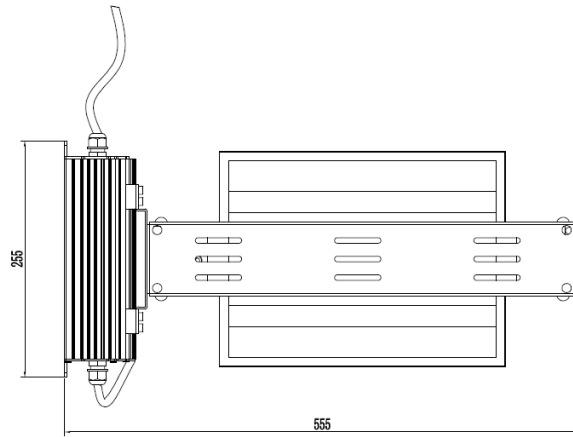
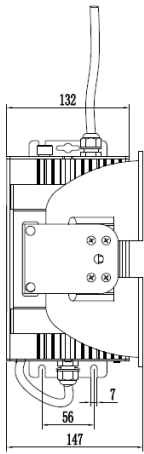

230V

110-240V Universal Ballast Specifications

	Min	Max
Input Voltage	110 V _{AC}	240 V _{AC}
Input Frequency	50 Hz	60 Hz
Input AC Current ¹ (110 V _{AC} input)	-	6.8 A
Input AC Current ¹ (240 V _{AC} input)	1.2 A	-
Efficiency ³ (110 V _{AC} input)	90%	92.5%
Efficiency ³ (240 V _{AC} input)	92%	92.5%
Operating Temperature	-15 °C (5 °F)	45 °C (113 °F)
Enclosure Temperature Increase	-	45 °C (81 °F)
Turn-on Delay Time	1 s	2 s

Ingress Protection	IP54
Lamp Power	630 W
Lamp Voltage	200 V
Over Temperature Protection ⁴	55 °C (131 °F)
Open Circuit Protection	Yes
Short Circuit Protection	Yes
Output Power Limit	Yes
Dimensions ⁵ (L x W x H)	555 mm x 330 mm x 147 mm (21.85" x 13" x 5.8")
Weight ⁵	6.4 kg (14 lbs)

230V Optimized Ballast Specifications

	Min	Max
Input Voltage	175 V _{AC}	265 V _{AC}
Input Frequency	50 Hz	60 Hz
Input AC Current ¹ (175 V _{AC} input)	-	4.1 A
Input AC Current ¹ (265 V _{AC} input)	-	2.7 A
Efficiency ³	91%	93%
Operating Temperature	-15 °C (5 °F)	45 °C (113 °F)
Enclosure Temperature Increase	-	35 °C (63 °F)
Turn-on Delay Time	1 s	2 s

Ingress Protection	IP54
Lamp Power	630 W
Lamp Voltage	200 V
Over Temperature Protection ⁴	55 °C (131 °F)
Open Circuit Protection	Yes
Short Circuit Protection	Yes
Output Power Limit	Yes
Dimensions ⁵ (L x W x H)	555 mm x 267 mm x 147 mm (21.85" x 10.5" x 5.8")
Weight ⁵	5.4 kg (11.9 lbs)

1. Measured at full load
2. Measured at full load with 5 A lamp current
3. Ambient temperature threshold
4. Measured at 175 V_{AC} input
5. Complete fixture with bulb

Photon Flux Distribution

Measured with Blaze CMH bulb (4200K) running at 630W (100%) with fixture centrally hanging at pre-determined height above a 40"x50" grow area.

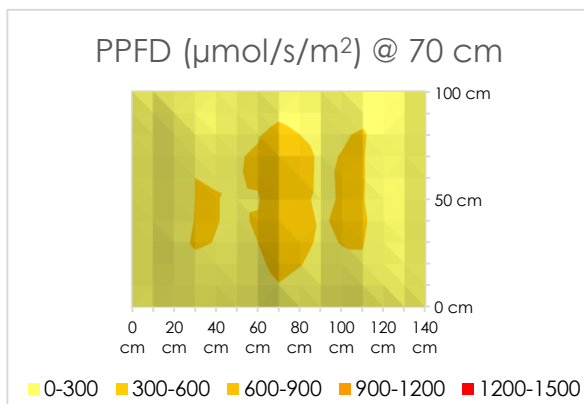
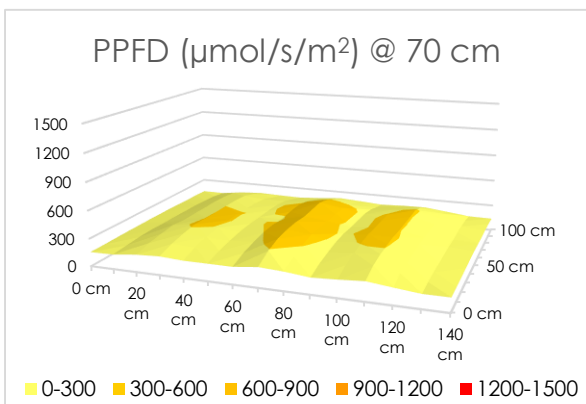
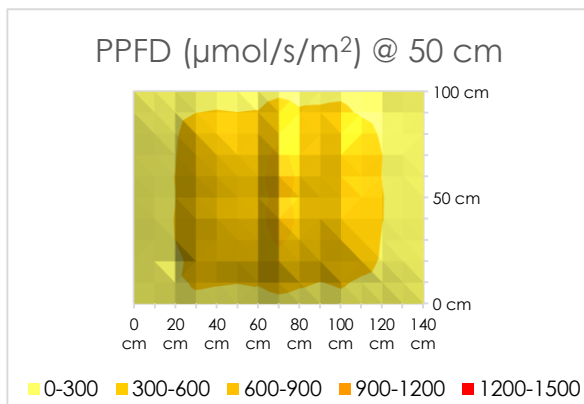
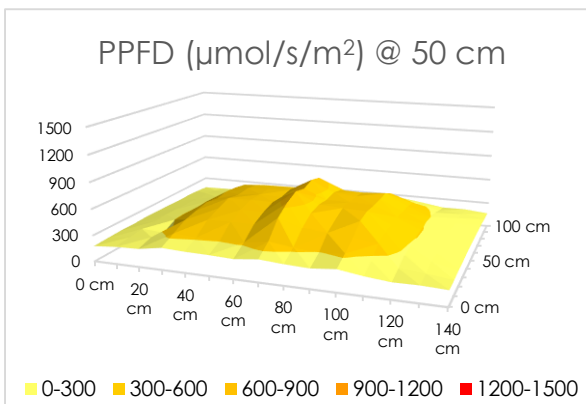
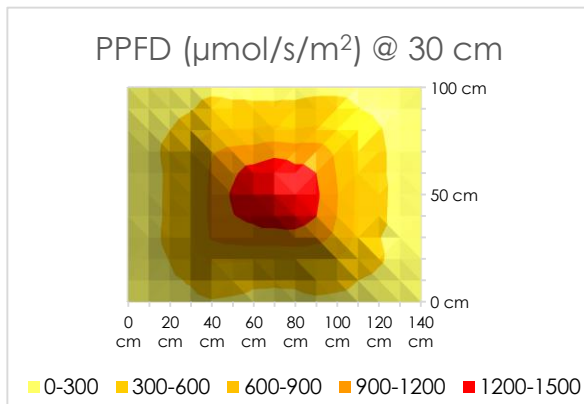
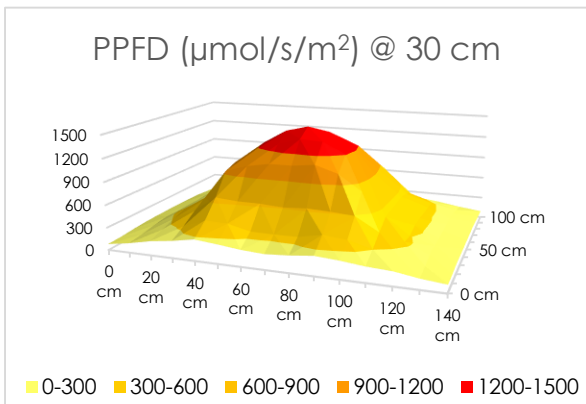

Photon Flux Distribution

Measured with Blaze CMH bulb (4200K) running at 693W (110%) with fixture centrally hanging at pre-determined height above a 40"x50" grow area.

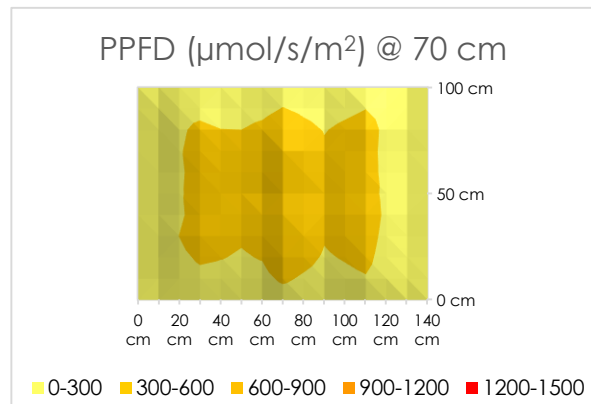
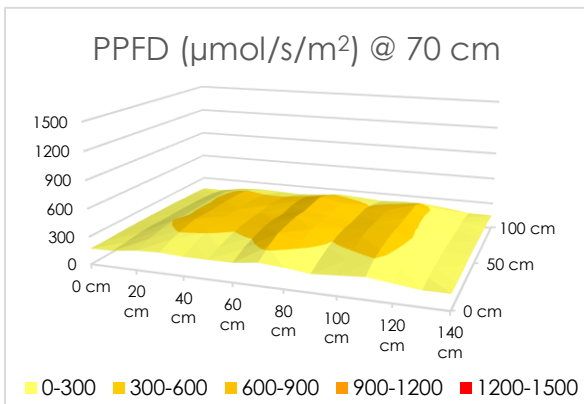
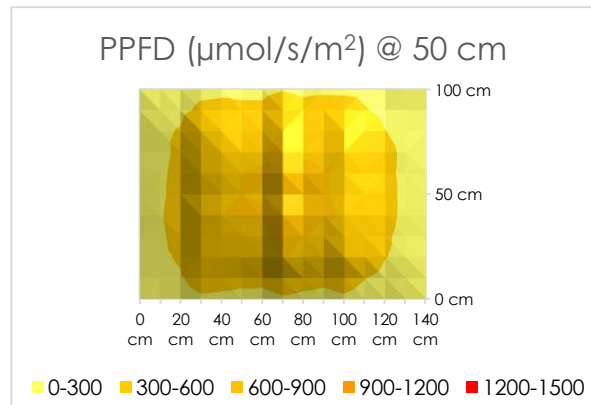
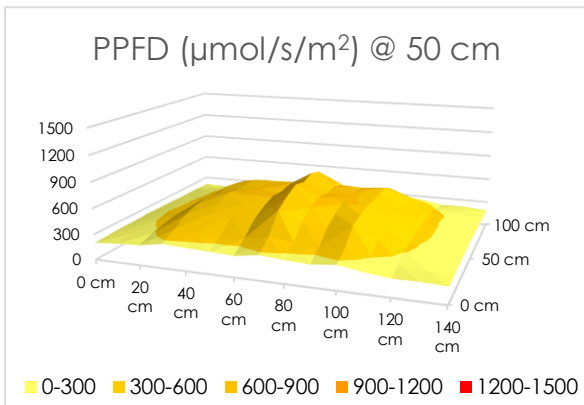
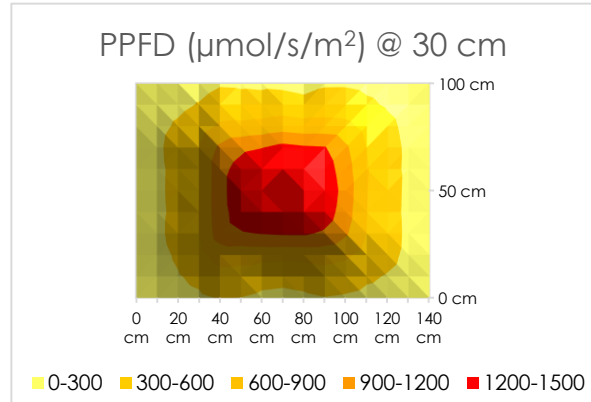
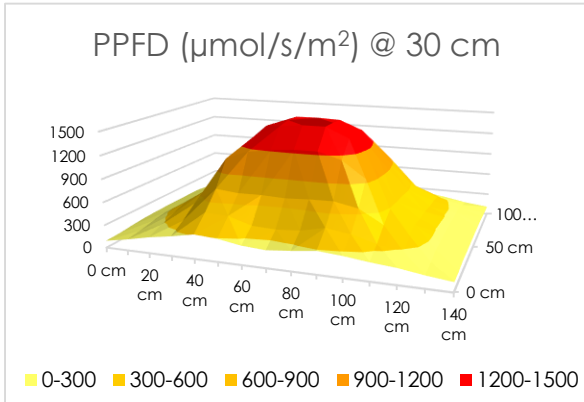

A 1281 Reamwood Ave.
Sunnyvale, CA 94089

P 1.800.369.8673

O 1.650.564.3058

E info@aessensegrows.com