

IF IN DOUBT - ASK

THIRD ANGLE PROJECTION TO BS308  DO NOT SCALE

REMOVE ALL BURRS & SHARP EDGES

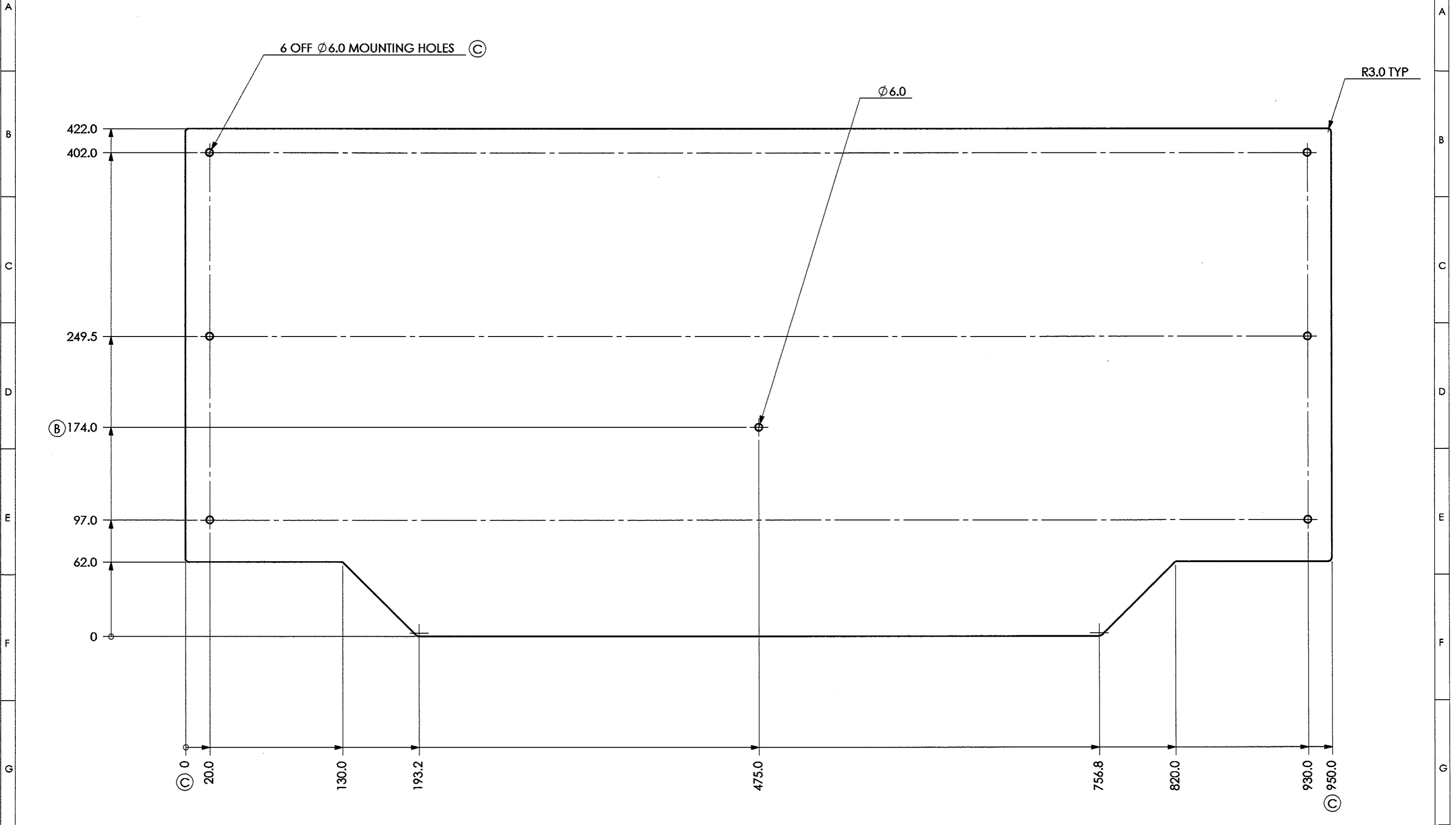

TOLERANCES

| | |
|------------------|--------|
| 0 DECIMAL PLACES | ± 0.5 |
| 1 DECIMAL PLACE | ± 0.25 |
| 2 DECIMAL PLACES | ± 0.15 |

ANGULAR ± 0.25°

THESE TOLERANCES APPLY, AND ALL DIMS ARE IN MM UNLESS OTHERWISE STATED

| | |
|------------|----------|
| ECP No | 7381 |
| DATE | 08/01/02 |
| NAME | RJB |
| PROD. ENG. | |

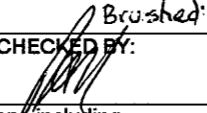
| | |
|--------------|--|
| MATERIAL: | Stainless Steel 1.5mm |
| FINISH: | Brushed |
| APPROVED BY: |  |
| CHECKED BY: |  |

| | |
|---------|----------|
| VEE | --- |
| DRAWN | RJB |
| DATE | 17/06/01 |
| USED ON | STD 2000 |
| SCALE | 1:3 |
| SHEET | 1 OF 2 |
| PAPER | A3 |

CASH BASES 

Cash Bases Ltd. Tel: +44 (0)1273 616300
 Newhaven, East Sussex BN9 0LA Fax: +44 (0)1273 512010
 United Kingdom www.cashbases.co.uk

| | |
|----------------|---------------------|
| TITLE | U/COUNTER MNTG BRKT |
| REV | D |
| DRAWING NUMBER | F00216 |

© No part of this drawing may be reproduced or transmitted by any form, or in any means including photocopying and recording, without prior permission of Cash Bases Ltd. Newhaven, East Sussex.

IF IN DOUBT - ASK

THIRD ANGLE PROJECTION TO BS308  DO NOT SCALE

REMOVE ALL BURRS & SHARP EDGES

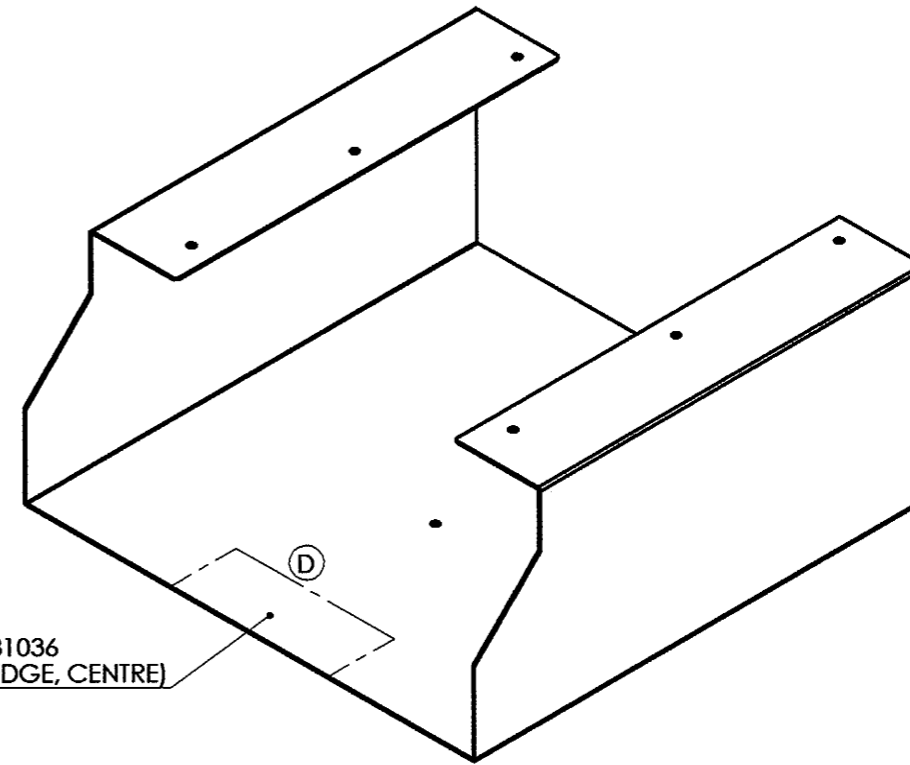
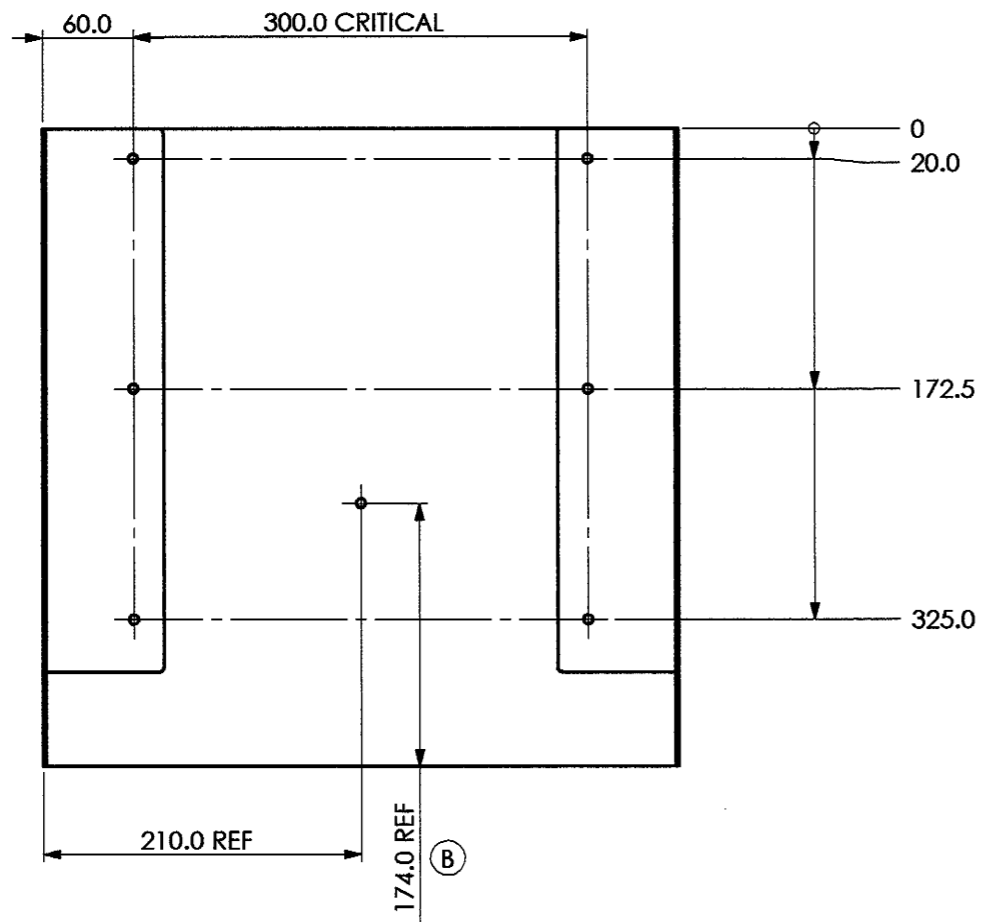

(D) LABEL 81036
(POSN.: FRONT EDGE, CENTRE)

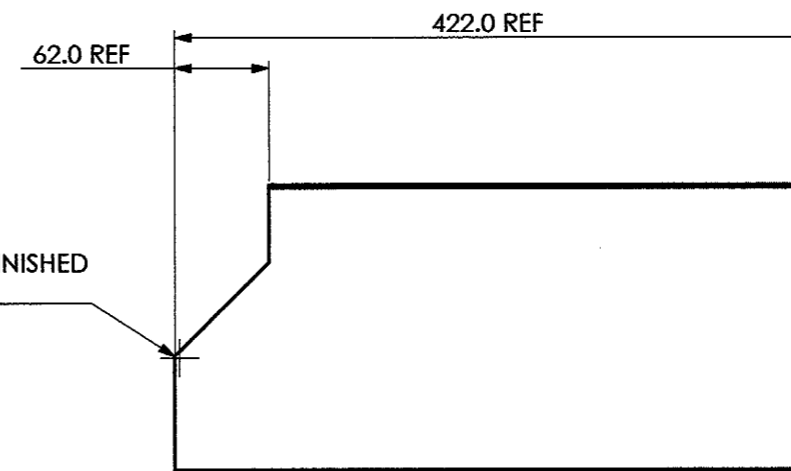
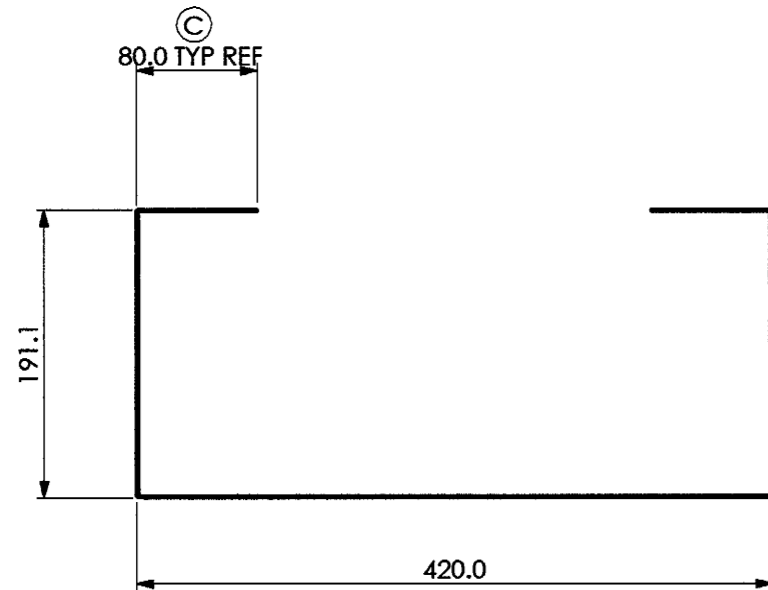

(D) FRONT CORNERS MUST BE FINISHED
TO REMOVE SHARP EDGES

TOLERANCES

0 DECIMAL PLACES ± 0.5

1 DECIMAL PLACE ± 0.25

2 DECIMAL PLACES ± 0.15

ECP No 7381

DATE 08/01/02

NAME RJB

MATERIAL: Stainless Steel 1.5mm

FINISH: Brushed

VEE 10 mm

DRAWN RJB



DATE 17/06/01

CASH BASES 

TITLE U/COUNTER MNTG BRKT

ANGULAR ± 0.25°

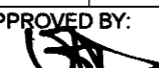
THESE TOLERANCES APPLY, AND ALL DIMS ARE IN MM UNLESS OTHERWISE STATED

PROD. ENG. APPROVED BY:  CHECKED BY: 

USED ON STD 2000

SCALE 1:5

SHEET 2 OF 2

PAPER A3

Cash Bases Ltd. Tel: +44 (0)1273 616300

Newhaven, East Sussex BN9 0LA Fax: +44 (0)1273 512010

United Kingdom www.cashbases.co.uk

REV D

DRAWING NUMBER

© No part of this drawing may be reproduced or transmitted by any form, or in any means including photocopying and recording, without prior permission of Cash Bases Ltd. Newhaven, East Sussex.

F00216