



# amp.14150 User Guide

*14 channel premium amplifier*



**Last modified:** 09/28/2016

**Copyright** © 28SEP16 Clare Controls, LLC. All rights reserved.

This document may not be copied in whole or in part or otherwise reproduced without prior written consent from Clare Controls, LLC., except where specifically permitted under U.S. and international copyright law.

**Trademarks** The amp.14150 name is a trademark of Clare Controls, LLC.

**Manufacturer** Clare Controls, LLC.  
7519 Pennsylvania Ave., Suite 104, Sarasota, FL 34243, USA

**Compliance**



**FCC compliance** This device complies with part 15 of the FCC Rules. Operation is subject to the following two conditions: (1) This device may not cause harmful interference, and (2) this device must accept any interference received, including interference that may cause undesired operation.

**EU compliance**



**2002/96/EC (WEEE directive):** Products marked with this symbol cannot be disposed of as unsorted municipal waste in the European Union. For proper recycling, return this product to your local supplier upon the purchase of equivalent new equipment, or dispose of it at designated collection points. For more information see: [www.recyclethis.info](http://www.recyclethis.info).

**Contact information** For contact information, see [www.clarecontrols.com](http://www.clarecontrols.com).

# Content

## **Important information...ii**

Warranty information...ii

Limitation of liability...iii

Important safety instructions...iv

## **Welcome to amp.14150...1**

Features...1

Rear panel features...3

Rack mounting the amp.14150 amplifier...4

Installation – getting connected...5

Installation – setup and options...6

Global switches...6

## **Operations...7**

## **Troubleshooting...8**

## **Specifications...9**

# Important information

## Warranty information

Clare Controls offers a three (3) year limited warranty on original Clare Controls components, from the date of shipment from Clare Controls. To view complete limited warranty details, including limitations and exclusions, [www.clarecontrols.com/warranty](http://www.clarecontrols.com/warranty).



## Limitation of liability

To the maximum extent permitted by applicable law, in no event will Clare Controls, LLC. be liable for any lost profits or business opportunities, loss of use, business interruption, loss of data, or any other indirect, special, incidental, or consequential damages under any theory of liability, whether based in contract, tort, negligence, product liability, or otherwise. Because some jurisdictions do not allow the exclusion or limitation of liability for consequential or incidental damages the preceding limitation may not apply to you. In any event the total liability of Clare Controls, LLC. shall not exceed the purchase price of the product. The foregoing limitation will apply to the maximum extent permitted by applicable law, regardless of whether Clare Controls, LLC. has been advised of the possibility of such damages and regardless of whether any remedy fails of its essential purpose.

While every precaution has been taken during the preparation of this manual to ensure the accuracy of its contents, Clare Controls, LLC. assumes no responsibility for errors or omissions.

## Important safety instructions



---

**WARNING:** To reduce the risk of fire or electric shock, do not expose this apparatus in or near rain or moisture.

---



---

**Caution:** To reduce the risk of electrical shock, do not remove cover. No user serviceable parts inside. Refer servicing to qualified service personnel.

---

1. Read the following instructions carefully.
2. Keep manual for future reference.
3. Heed all warnings.
4. Follow all instructions in this manual.
5. Do not expose the apparatus to dripping or splashing and that no objects filled with liquids, such as vases, shall be placed on the apparatus.
6. Do not use this apparatus near water.
7. Clean only with a dry cloth.
8. Do not block any ventilation openings. Install according to manufacturer's instructions.
9. Do not install near any heat sources such as radiators, heat registers, stoves or other apparatus that produce heat.
10. Do not override the safety purpose of the polarized or grounding-type plug. A polarized plug has two blades - one wider than the other. A grounding type plug has two blades and a third grounding prong. The wide blade or the third prong is provided for your safety. If the provided plug does not fit into your outlet, consult an electrician for replacement of the obsolete outlet.
11. Protect the power cord from being walked on or pinched particularly at plug, convenience receptacles, and the point where it exits from the apparatus.
12. Only use attachments/accessories specified by the manufacturer.
13. Unplug this apparatus during lightning storms or when unused for long periods of time.
14. Refer all servicing to qualified service personnel. Servicing is required when the apparatus has been damaged in any way, such as when the power-supply cord or plug is damaged, liquid has been spilled, or objects have fallen into the apparatus, the apparatus has been exposed to rain or moisture, does not operate normally, or has been dropped.

15. The apparatus shall be connected to a MAINS socket outlet with a protective earthing connection.
16. The MAINS plug or the appliance coupler is used as the disconnect device, and shall remain readily operable.
17. To completely disconnect this unit from the AC MAINS, disconnect the power supply cord plug from the AC receptacle





# Welcome to amp.14150

The Clare Controls amp.14150 is a 14-channel Class D amplifier. It is a compact and efficient cool-running device housed in a 2U rack-mount chassis. The amp.14150 uses an advanced switch-mode power supply to drive fourteen channels, delivering 150 watts at 8Ω. The amp.14150 is stable to 4Ω.

The amp.14150 incorporates fourteen channels of clear audio performance. It uses two independent feedback loops that provide lower distortion, less noise on output, a frequency response that is less dependent on load and lower output impedance than other Class D amplifiers.

The amp.14150 also includes a switch-mode power supply that consumes less than 0.2 W in standby. Nine independent protection circuits ensure uninterrupted music until maximum limits are reached.

## Features

### Efficiency

The amp.14150 is built on Class D technology, running cooler, more efficiently (greater than 90%), and more economically than traditional Class A/B amps, with equal or better audio performance.

### 2U form factor

Class D amplifier technology can also be built into smaller, lighter components, allowing us to fit fourteen high-performance channels in a 2U rack-mountable chassis.

### Advanced protection

The amp.14150 features a comprehensive protection system with a total of nine independent protection circuits. These circuits monitor the temperatures, currents, and voltages of several different functional blocks to assure optimal reliability.

### Global switching

A dedicated input can be assigned to multiple output channels via the channel Global In connection. By turning ON the Global DIP switch for each pair of channels, those channels can be configured to play the common signals from the global input. This allows you to use multiple channels for a single listening area without the need for line level distribution amps or Y-cables.

## **Individual channel and gain adjustments**

Each channel has its own gain adjustment, which adjusts the maximum output. This allows you to match the output to its area. It can also be used to limit how loud each speaker is allowed to play. If you choose to use Global switching, you can use the Global gain to control the maximum output for all Global channels at once. Regardless of which gain you use, be sure to set the volume at a level that does not clip or cause distortion when the volume is at its maximum level. This can cause damage to the speakers and the amplifier.

## **Installation-friendly connections**







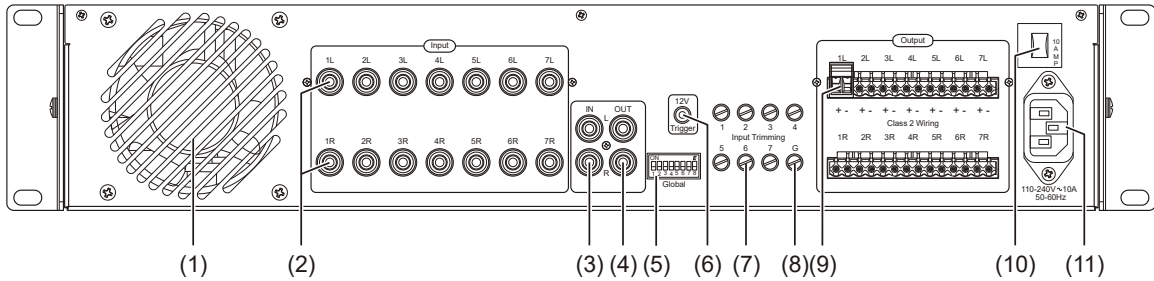

Each speaker connection features a removable terminal connector that accommodates up to 14 gauge stranded speaker wire.

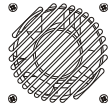
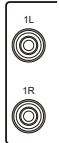
## **Power**

The amp.14150 receives its power from a standard 110VAC/60Hz or 240VAC/50Hz outlet. The amp can be triggered to turn on via the 12 VDC trigger input on the rear of the amp. This allows the amp to remain in Standby mode until it is required for use, thereby greatly reducing overall power consumption.

# Rear panel features

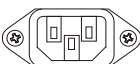

	<p>(1) Fan</p> <p>Rear location fan with front intake allows for direct stacking of the amplifier with other equipment, greatly reducing rack space usage.</p>
	<p>(2) Line inputs</p> <p>Individual channel inputs for use with multi-channel preamps or dedicated sources.</p>
	<p>(3) Global input</p> <p>Allows an individual input source to be shared across any or all channels.</p> <p>(4) Global loop out</p> <p>Allows global inputs to be looped out to other amplifiers or devices.</p>
	<p>(5) Global DIP switch</p> <p>Allows distribution of the audio signal from the Global In (L and R) to multiple amplifier channels in a configuration of your choice. (DIP ...8 is not used.)</p>
	<p>(6) 12V trigger</p> <p>Powers on the amplifier from Standby mode into full power mode when triggered.</p>
	<p>(7) Gain control</p> <p>Allows individual control of the maximum output for each pair of amp channels.</p>
	<p>(8) Global gain</p> <p>Allows control of the maximum output of all channels that have been set to Global mode (i.e., Global DIP switches for those channels are ON).</p>
	<p>(9) Speaker outputs</p> <p>Individual terminal connectors (included) for each speaker.</p>
	<p>(10) 10 amp breaker</p> <p>Manual reset circuit breaker.</p>
	<p>(11) Power connector</p>

## Rack mounting the amp.14150 amplifier

Your amp.14150 comes equipped with rack ears for mounting the unit in a 2U rack space.

### Notes

- Be sure that the unit is in a well-ventilated area that provides adequate cooling.
- Do not block the fan vent located on the rear of the unit.
- Do not place the unit on carpeting or any similar material.
- Do not install the unit near a source of heat, or in an extremely humid or wet location.
- If your installation lacks good airflow (such as solid cabinet doors or wall-mounted racks), it may be necessary to create ventilation to allow outside air into the space.

### To mount the amp.14150 in a rack:

1. Remove the eight screws (four on each side) from the amp.14150 and set aside.
2. Place an ear on each side of the amp.14150, and then attach them using the screws you set aside.
3. Slide the unit into the rack, and then attach it with four rack mounting screws.

Figure 1: amp.14150 rack mounting

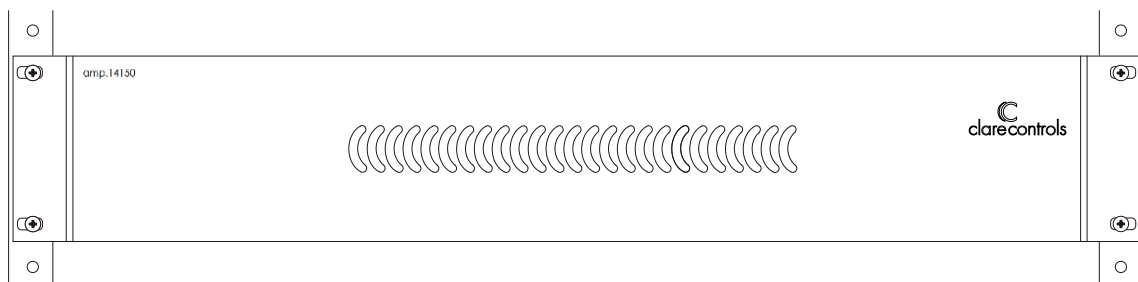

## Installation – getting connected

---

**Caution:** All connections and switching must be done with the amplifier powered off. Do not connect the power cord to the amplifier until your connections and set up is complete.

---

### Inputs

For line level connections, use high-quality RCA cables that feature low impedance, shielding and high-quality connectors.

### Speaker outputs

Use 14-18 gauge stranded two-conductor loudspeaker wire for all high level connections. At each loudspeaker-level connection, ensure that at least 2 inches of each conductor are separated. Strip away 1/4 inch of insulation from each conductor. Connect the appropriate conductor to the speaker connection using the terminal connectors, observing correct polarity.

### Verifying phase

If during or after calibrating your receiver you suspect the sound is not right and you cannot see any markings on the wire to verify that polarity is correct, try this simple test:

1. Sit in the normal listening position for the system.
2. Play some music with your receiver set to Mono. Listen to the music and observe the audio.

Does the bass sound full and even with the other audio?

Do the vocals sound centered and even in volume? If any of the answers are YES, follow steps 3 and 4.

3. Turn off your receiver and reverse the connections for one of the speakers.
4. Repeat your test at the same volume level while reversing connections for each speaker, one by one. When the sound has the loudest and best sounding bass, and vocals are centered and clear, your connections are correct and in-phase.

### Loop outputs

Any source connected to the Global Line In Input can be sent to other components or amplifiers by connecting them to the Global Loop output connectors.

# Installation – setup and options

## Input selection

---

**Caution:** Only change DIP switch positions when the amplifier is turned off. Each channel is capable of delivering the sources from a dedicated Line-In or the Global-Inputs by changing the Line-In/ Global In DIP switch.

---

## Power connection

Plug the supplied power cord into the amplifier and to a polarized wall outlet or appropriate surge protector.

**Note:** There is no power button on the amp.14150. The unit automatically powers up when you plug it into an outlet.

---

**Caution:** Do not plug the amplifier's power cord into a switched outlet, as is featured on some surround receivers. If you wish to have the amplifier turn on when the receiver is powered up, use the 12V trigger jack on the rear of the unit.

---

## Global switches

The global switches allow you to distribute the audio signal from Global In to multiple amplifier channels in a configuration of your choice.

### To use the Global switches:

1. Connect the audio source to Global IN (Fig. 2, item 1).
2. Set the Global DIP switches for the channels to ON (Fig. 2, item 2).
3. Connect the leads of the speakers to the matching channel connectors (Fig 2, item 3).

**Figure 2: Example of global switching**

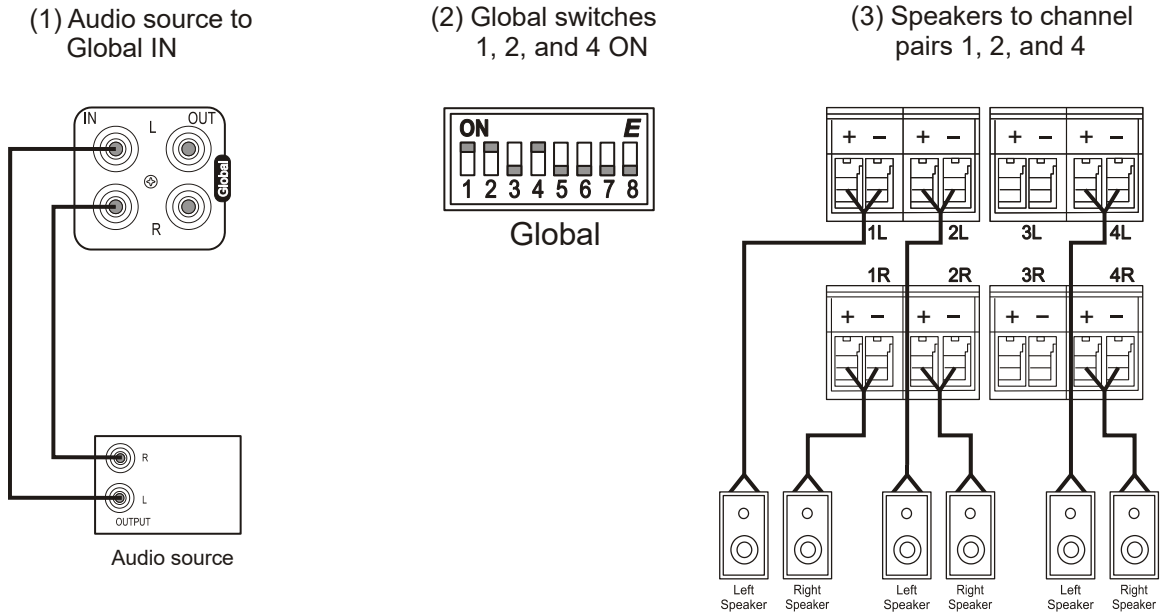

## Operations

### LED indicators

When the amp.14150 is powered on, the LEDs on the front panel indicate the amplifiers operating state.

BLUE – Amplifier is ON and functioning properly

ORANGE – Amplifier is ON and in Standby mode.

## Gain adjustments

Use the gain adjustments on the rear panel of the amplifier to adjust the maximum output level of each channel pair. This is useful when you want to limit the maximum volume level in an area, such as a child's room or guest area. Be sure to set the gain adjustment at a level that does not clip or cause distortion when the volume is set to the maximum level. This can cause damage to the speakers and the amplifier.

## Troubleshooting

### No audio from any channel.

- Verify that the power cable to the amplifier is correctly connected and plugged into an outlet that has power.
- The audio cable to the source component is not properly connected, it is not properly connected to the input, or the cable is defective. Check your connections and replace defective cables with ones that are known to be good.

### No audio from one or more channels.

- The audio cable to the source component is not connected properly or it is defective. Check the connections or replace the cable, if necessary.
- The Global DIP switch is positioned incorrectly. Set the DIP switch to its proper position. See "Global switches" on page 6.
- Check the speaker wire connections at the amplifier and the speaker.
- The Gain adjustment for the channel is turned down. Turn it slowly to the right to raise the volume.
- To test a bad channel, connect it to a speaker that you know works.

### Hearing a hum or buzzing sound.

- Check the RCA input cables by removing them one at time. (Be sure to power down the device before disconnecting the cable.) Check to see if a connection or a cable is to blame.

### Amplifier will not turn on.

- Check that the amplifier is plugged into a live outlet.
- Check that 12V is present, if using the 12V trigger.



# Specifications

Voltage	120 to 240 VAC, 10 A 50/60 Hz
Current Standby	0.06 A (1.3 A with music, max.) 2.6 A (with Sine wave, worst case)
Inputs	7 Gold RCA jacks with adjustable gain, 2 Gold RCA jacks with adjustable gain for Global IN, and 2 Gold RCA jacks for Global OUT (no adjustable gain) (+4 dBu pro to -10 dBV consumer)
Input impedance	Single ended 10 k $\Omega$
Output power	14 x 150 W into 8 $\Omega$
Peak output power	150 W per channel at 8 W; 300 W per channel at 4 W
Frequency response	10 Hz to 20 kHz (4 $\Omega$ , 8 $\Omega$ , Open load)
Idle noise	< 140 dBr(A)
THD+N distortion (4 $\Omega$ SE, f = 100 Hz, Po=1 W)	0.003%
IMD Intermodulation (CCIF) (f=18.5 kHz, 1 kHz Po 10 W)	0.0009%
Trigger control	12 VDC on 3.5 mm mono jack (tip +, sleeve -)
Fan noise	Variable speed, 28 db(A) worst case
Standby power	<0.5 W
Weight	16.7 lbs. (7.6 kg)
Dimensions (W x H x D)	17.00 x 3.5 x 16 in. (43.2 x 8.9 x 40.6 cm)
Operating environment Temperature Relative humidity	32 to 95°F (0 to 35°C) 0 to 95% noncondensing

**Note:** All specifications are subject to change without notice.





