

# The New Face of Building Exteriors.



ACORN



BARK



FAWN



## INSTALLATION GUIDE



*Signature Stain*™  
Created by Tando

Tando provides these instructions as general guidelines only. The contractor and/or installer shall be responsible for ensuring that all applicable local building codes are followed, which may require modification of these general guidelines. Tando assumes no liability for personal injury or property damage resulting from improper or careless application of the described techniques.

For more information on Tando and its wide variety of state of the art products, please call us at 844-MY-TANDO (844.698.2636).

Installation Guidelines can be downloaded from our website: [www.tandobp.com](http://www.tandobp.com).

# RUSTIC CEDAR 6 INSTALLATION GUIDE



## GENERAL INFORMATION

1-Tando products are intended for use in a vertical placement only and are not designed or warranted for roofing or flooring applications. However mansard roofs with a 45/12 slope or greater are acceptable applications.

2-Tando products are designed as an exterior cladding, not as a weather resistant barrier. TandoShake is designed to allow the material underneath it to breathe; therefore, it is not a watertight covering. To achieve designed performance, TandoShake must be installed over a weather resistant house barrier system, such as house wrap.

3-As with the majority of exterior building materials, Tando products will expand and contract with a change in temperature. Therefore, during installation it is necessary to position the TandoShake properly to compensate for temperature effects.

4-It is essential to work over a smooth, flat, nailable wall surface, (i.e. minimum 7/16"(1,11cm) OSB board or plywood is recommended). If Tando products are being installed over furring strips, furring strips must be installed on a 45° angle, spaced 8"(20,32cm) center to center, while ensuring that the side seams are supported by furring strips.

5-Fixtures cannot be installed directly to TandoShake; always use a wooden support or specifically designed mounting blocks to attach fixtures. Follow the mounting block manufacturer's installation instructions and ensure proper clearance to the TandoShake (recommended minimum of 1/4"(0,64cm)) to allow room for expansion and contraction.

6-Non-corrosive fasteners are required to secure the sections and they must penetrate through the solid surface by at least 1 1/4"(3,18cm) and into a solid substrate by at least 7/16"(1,11cm).

7-Always begin the installation at the lowest point of the structure, work from left to right installing one row at a time, and completing one wall before beginning another.

8-Store product on edge (vertical), do not stack flat.

9-Keep the R-E-L number, located on the box of your products (ex: REL-123456) for future reference.

10-To cut the material, it is recommended to use a circular saw with a thin kerf finishing blade.

11-Some finish trims such as J-channel and Outside Corner Post, must be installed on wall prior to installation of TandoShake. Follow the finish trim manufacturer's instructions for proper installation.

12-Fastening TandoShake should not restrict movement. Fasteners should be driven straight into the center of any nailing slot with the head of the fastener making light contact with the product, allowing the section to be hung. The center nail hole must always be securely fastened to ensure that the section expands and contracts from the center out.

13-If a partial piece is used at either end, a new center hole should be created, by drilling a 1/8"(0,32cm) hole in the top flange, near the center of the section at the same height as the other installation holes.

14-If face nailing is employed, pre-drill a hole in an inconspicuous area, such as a shingle seam. The hole must be larger than the shank of the nail or screw, but smaller than the head, to allow for possible thermal movement. The head can be covered with matching paint or caulk.

15-It is best to work with the product at waist-level, allowing the installer to inspect the back of the product, verifying that all fingers are properly engaged. Do not force product up into the upper fingers of the lower row, as this may damage the stop posts and/or will override the expansion joints and cause buckling.

16-Fitting product between windows and around openings requires a spacing of 1/4"(0,64cm) to allow for expansion.

17-Variations in shade and color are an inherent characteristic of TandoShake natural color.

# RUSTIC CEDAR 6 INSTALLATION GUIDE

## BASIC GUIDELINES

1-Always fasten through the installation holes. These holes include a polymer film, which permits for precise centering of the fastener, allowing the expansion and contraction of the material. Each complete section must be fastened through the center hole, at both extremities, plus 2 others evenly spaced on each side of the center hole and have a minimum of 7 fasteners in the nailing channel at maximum spacing of 16"(40,64cm) or less (Figure 1). If TandoShake is installed on a wall with furrings, furring strips should be installed on a 45° angle, at 8"(20,32cm) center to center and a furring strip is required behind each fastener.

2-Never hammer or screw the fasteners in completely; leave a gap of 1/16"(0,16cm) between the nailing channel and the fastener's head (Figure 2). The stoppers located around the holes help to stop the hammer from driving the nails in too far, and provides the required gap. Always use non-corrosive nails or screws with a head of 0.4"(1cm) in diameter and a body of 0.150"(0,38cm) in diameter and penetrate through the solid surface by at least 1 1/4"(3,18cm) and into a solid substrate by at least 7/16"(1,11cm).

3-Make sure that all pieces are properly joined together (push firmly upwards on the section making sure that the insertion is complete) (Figure 3).

4-When using a finish trim (J-channel, Outside Corner Post, etc.), leave a space of 1/4"(0,64cm) between the trim and TandoShake (Figure 4). The required opening for finish trim is 1 1/8"(2,86cm).

Figure 1

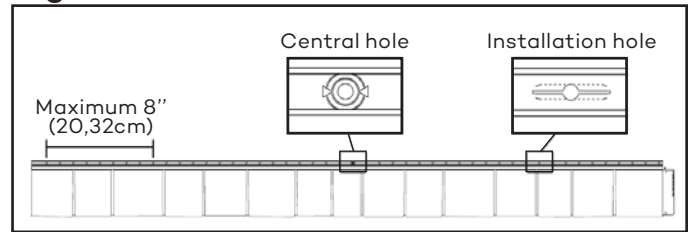

Figure 2

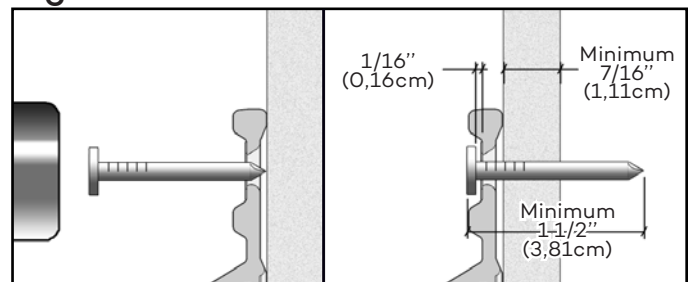

Figure 3

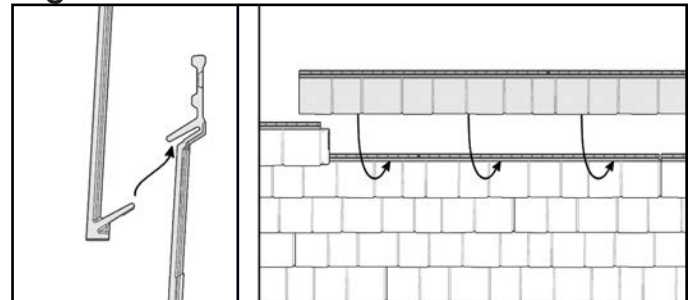
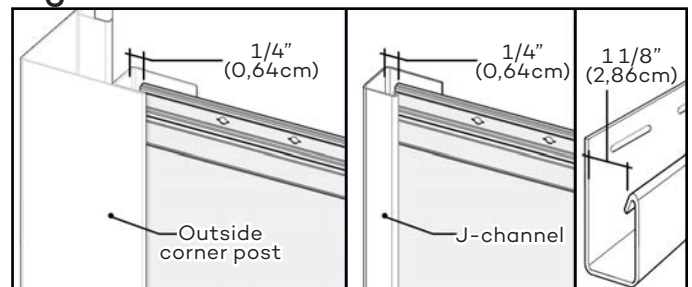

Figure 4



Some elements of the image above were partly removed to facilitate understanding.

# RUSTIC CEDAR 6 INSTALLATION GUIDE

## INSTALLATION STEPS

1-First install the starter strips at the lowest point of the structure. Make sure that the horizontal starting line is perfectly leveled and square with the wall. Leave a 1" (2,54cm) gap at each end of the wall when using decorative corners (1). If a floor is against the wall, install the top of the starter strips at 2 1/2" (6,35cm) above it in order to leave a gap of 5/8" (1,59cm) between starter strips and the floor (2). If there is no floor, starter strips should be flush with the base of the wall. Fasten the starter strips at maximum intervals of 8" (20,32cm) or less. Install the next starter strip by pressing it against the previous one (3) and fasten it as mentioned above (Figure A). Be sure to align adjacent walls.

2-Determine the number of sections needed for the wall by dividing the total length of the wall, less the width of the corner pieces used, by 95 1/4" (241,93cm). Cut the left side of the first section in a straight line in order to avoid having a very small piece at the right end of the wall. Any installed piece should be at least 12" (30,48cm) long. Insert the first section into the starter strip and slide it leftward leaving a 2 5/8" (6,67cm) space between its edge and the wall corner (Decorative corners will be installed after. See corners installation instruction section for detail) or slide the section into the trim leaving a space of 1/4" (0,64cm) between the inside wall of the trim and the section (Figure B).

3-On each section, fasten the center hole of the product, this will ensure even movement of sections in both directions during expansion/contraction. Also place a fastener into the last hole on both ends, plus 2 others evenly spaced on each side of the center hole of the nailing channel (Figure C). Fasteners should never be spaced more than 16" (40,64cm). Each full length section should be secured with a minimum of 7 fasteners. Remember that fasteners must be placed in the center of the nailing slots. Always use non-corrosive fasteners penetrating into a solid substrate of no less than 7/16" (1,11cm) thick. When attaching the fasteners, be sure they only lightly touch the product allowing it to move with varying temperatures and they are installed flush with the section, so as not to interfere with the succeeding row.

- If the product is installed on a furring wall, a furring strip is required behind each fastener.

- If a section does not have the initial center hole, drill a new center hole of 1/8" (0,32cm) diameter at the same height as the other installation holes.

Figure A

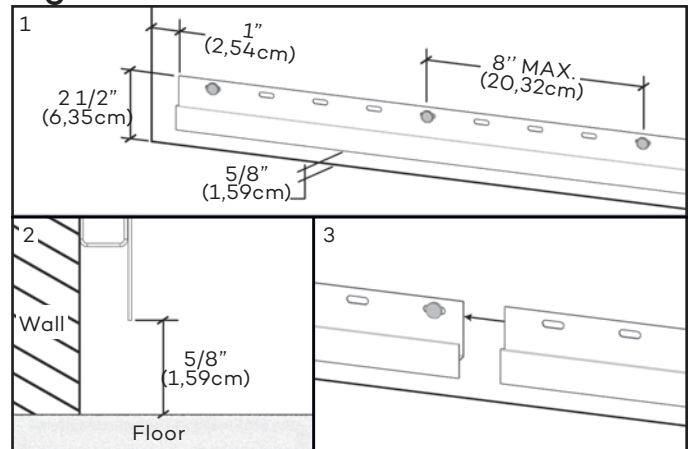

Figure B

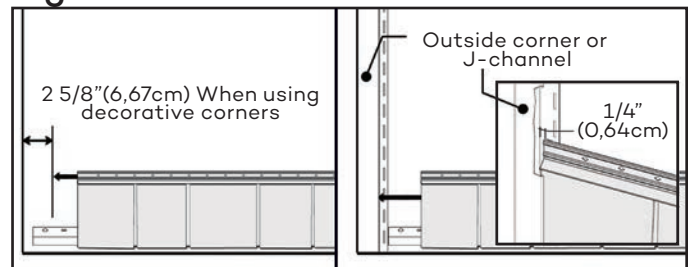
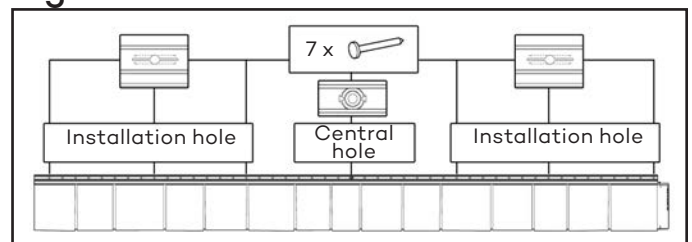

Figure C



# RUSTIC CEDAR 6 INSTALLATION GUIDE

## INSTALLATION STEPS (CONTINUATION)

4-Install the next section by hooking it into the starter strip and overlapping the previous, closest of the desired position (1), then rotate it upwards to fully engage the hook (2) (Figure D). If installed at outdoor temperature above 68°F(20°C), slide until the stopper located on the upper right end. A reference line located on the bottom right end allows to validate positioning. If installed at outdoor temperature between 32°F(0°C) and 68°F(20°C), adjust the left edge to the temperature line (Figure D.1). If installed at outdoor temperature below 32°F(0°C) position the section slightly right (1/16"(0,16cm)) of the 32°F(0°C) and 68°F(20°C) line. Once properly positioned, fasten it as previously indicated. Repeat this step until the end of the row.

5-Repeat steps 2 to 4 for the subsequent rows until the last row, alternating the cutting distance of the first section of approximately 16"(40,64cm) for each row. Insert the bottom section hook with the top hooks of the row below and push firmly upwards on the product making sure that the insertion is complete. For an authentic look, eliminate stacking seams by alternating the cut positions for each of the following rows (Figure E).

6-For the last row or places where you may need to attach product other than in installation holes, use a knife to create a new 1"(2,54cm) slot (Figure F); the slot must be wider than the fastener but not as wide as the fastener head. Although not set in installation holes, this type of cutting will allow the expansion/contraction movement of sections.

-Note: For proper installation & optimal appearance, shim as required to adjust the angle of the last row.

Reminder: Do not set accessories directly on TandoShake. The fasteners must be fixed into a solid surface. If you need to set accessories over TandoShake, at a concealed spot on the product, create a new 1"(2,54cm) slot larger than the fastener body but smaller than the fastener head to permit expansion/contraction of sections.

Figure D

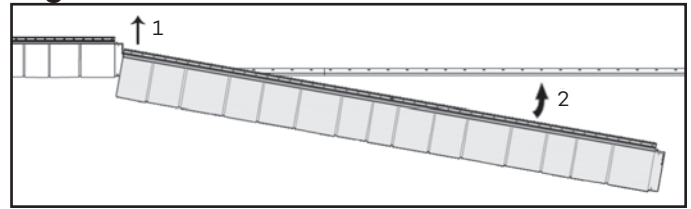

Figure D.1

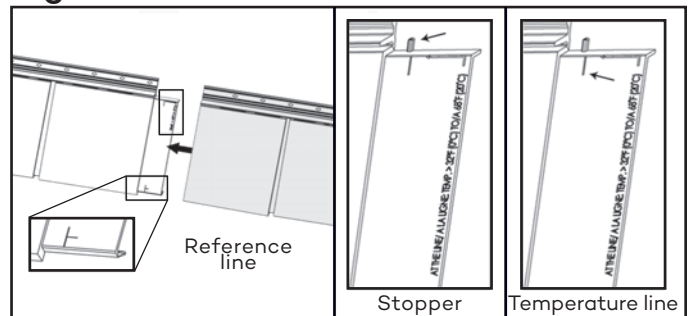

Figure E

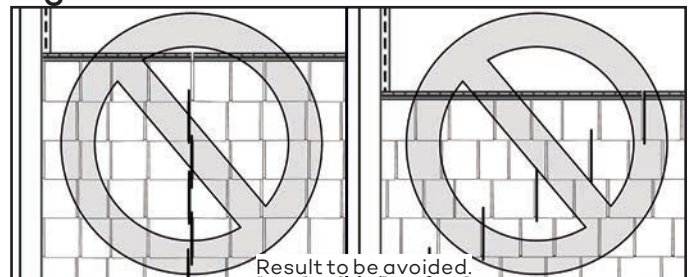
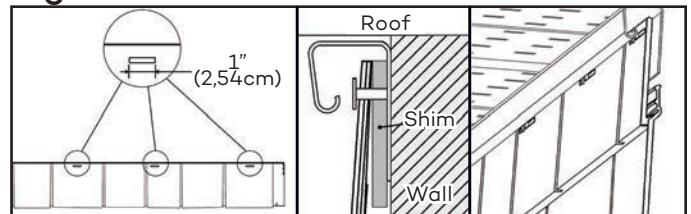

Figure F



## SPECIAL SITUATIONS AND SUGGESTIONS

SITUATION:	ITEMS TO CHECK:
- Sections won't seat properly side to side.	The wall may not be level and flat. Check previous section to ensure that all bottom hooks and fingers are properly seated. (See General Information) Use shims as needed to ensure a level wall surface.
- The continuous bottom hook won't engage into the continuous top finger.	
- Sections are buckling on the wall.	Make sure the fasteners are not restricting product movement. Check for proper spacing at interlocks. Make sure fasteners are fully engaged.
- Sections are not lying flat against the wall.	

7-We suggest alternating the cutting distance of the first section of every rows from this pattern to obtain a nicer look: 0"(0cm) - 15"(38,1cm) - 6"(15,2cm) - 21"(53,3cm). (Figure G)

**Figure G**

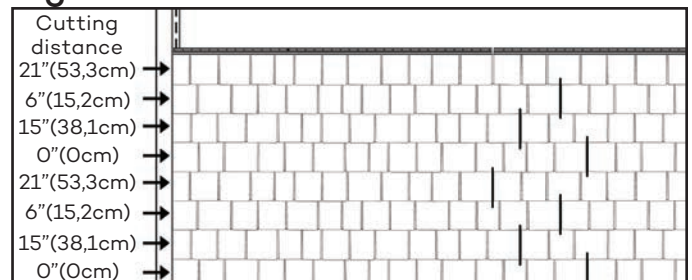

## DECORATIVE CORNERS INSTALLATION

**Caution:** Rustic Cedar 6 must be installed on adjacent walls prior to installing the Rustic Cedar 6 corners and be sure that rows are aligned.

1-The installation of Rustic Cedar 6 corners begins once you have completed two adjacent walls.

-Note: For proper installation & optimal corner appearance, make sure that rows of adjacent walls are at 2 5/8"(6,67cm) from corner wall and at an equivalent height.

2-The corner is slightly adjustable as the height of the Rustic Cedar 6 shingles varies. While installing, slip the two external hooks (located at rear of part) under the starter strip (A). \*For the first row only, you may have to cut the two internal hooks to avoid interference with the starter strip.\* Push the corner upwards on product shingles until proper fit (B). Fasten into slots at the top (Figure H).

**Figure H**

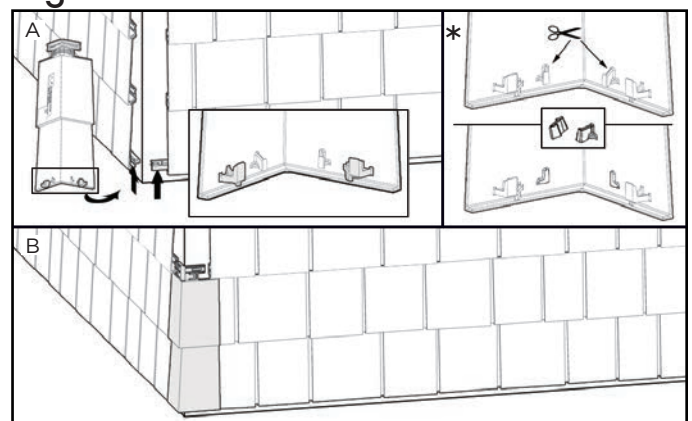

# RUSTIC CEDAR 6 INSTALLATION GUIDE

## DECORATIVE CORNERS INSTALLATION (CONTINUATION)

3-For all the other corners, insert the two internal hooks into the two openings (A). Ensure they are locked in place by pushing firmly near hooks to fully engage the corners. Push corner upwards on product shingles until proper fit (B). Fasten into the slots at the top (Figure I).

4-For the last corner only, cut excess from part. On each side of the corner, make a new hole wider than the shaft of the fastener, but smaller than the head. Affix a nailing strip behind these locations as required for a proper fit with the shingle angle of section on each side and fasten it on wall. (Figure J)

Figure I

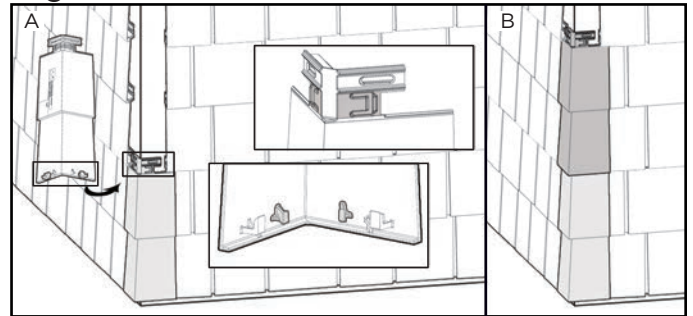

Figure J



## INSTALLATION TIP

1-Many solutions are possible to finish corners: PVC Trimboard (A), Outside or Inside Corner Post (B) or two J-channels for an inside corner (C) (Figure K). Whatever options you choose, it is important to seal the corners of the wall prior to installation of the trim.

Figure K

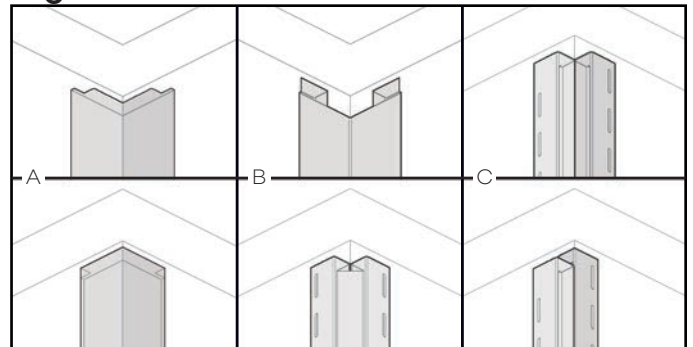

For details, see the respective installation guide of each product.