



IMPORTANT FOR FUTURE REFERENCE

Please complete this information and retain this manual for the life of the equipment:

Model #: _____

Serial #: _____

Date Purchased: _____

Service Manual

Covering

Compact Pasta Control

Pitco p/n 60143701

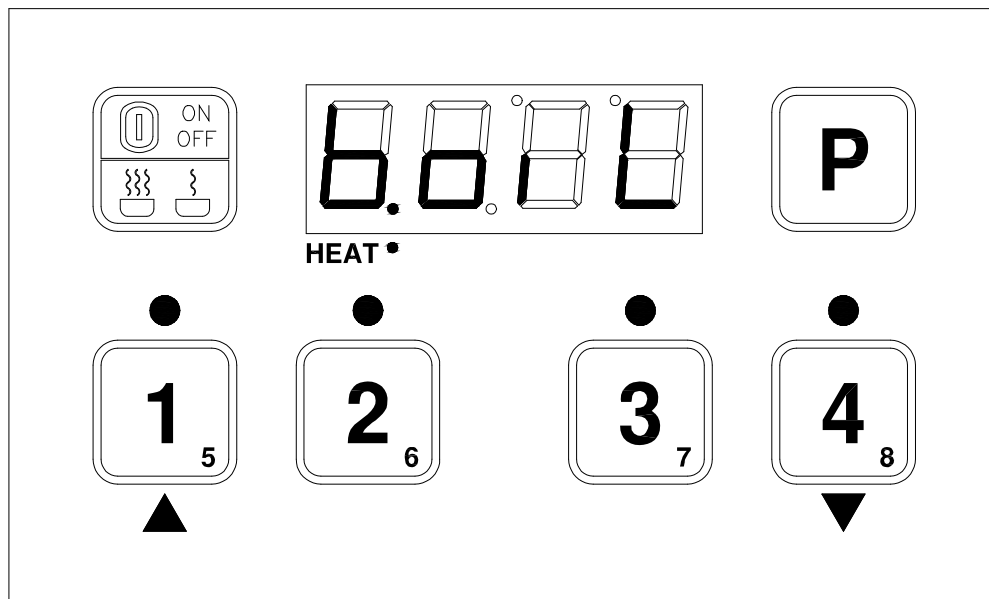

TABLE OF CONTENTS

OPERATION..... 3

1.1 To TURN CONTROL ON:..... 3

1.2 To TURN CONTROL OFF:..... 3

1.3 To ACTIVATE TIMERS 1-4: 3

1.4 To ACTIVATE TIMERS 5-8: 3

1.5 To CANCEL A COOK:..... 3

1.6 To ENTER BOIL MODE: 3

1.7 To ENTER SIMMER MODE: 4

2 PROGRAMMING..... 4

2.1 To UNLOCK:..... 4

2.2 To CHANGE SIMMER TEMPERATURE:..... 4

2.3 To CHANGE TIMERS 1-4:..... 4

2.4 To CHANGE TIMERS 5-8:..... 4

2.5 To EXIT PROGRAMMING: 5

3 LEVEL 2 PROGRAMMING: (FOR TECHNICIANS AND FACTORY USE) 6

3.1 To UNLOCK..... 6

3.2 PASSWORD ENTRY TO LEVEL 2 PROGRAMMING: 6

3.3 DISPLAY TYPES 6

3.4 PASSWORD SET OPTION 7

3.5 DISPLAY IN DEGREES °F OR °C..... 7

3.6 NUMBER OF BASKET LIFTS..... 7

3.7 COOK DONE ALARM OPTIONS:..... 7

3.8 EXIT PROGRAMMING 8

4 OTHER DISPLAYS:..... 8

LOW VAT TEMPERATURE 8

DRAIN VALVE OPEN..... 8

EQUIPMENT FAULT DISPLAYS 8

4.4 To CHANGE PORT ADDRESS..... 8

4.5 To VIEW SOFTWARE REVISION 9

5 ELECTRICAL CONNECTIONS 9

6 CHART: PROBE RESISTANCE VS TEMPERATURE 10

1 Operation

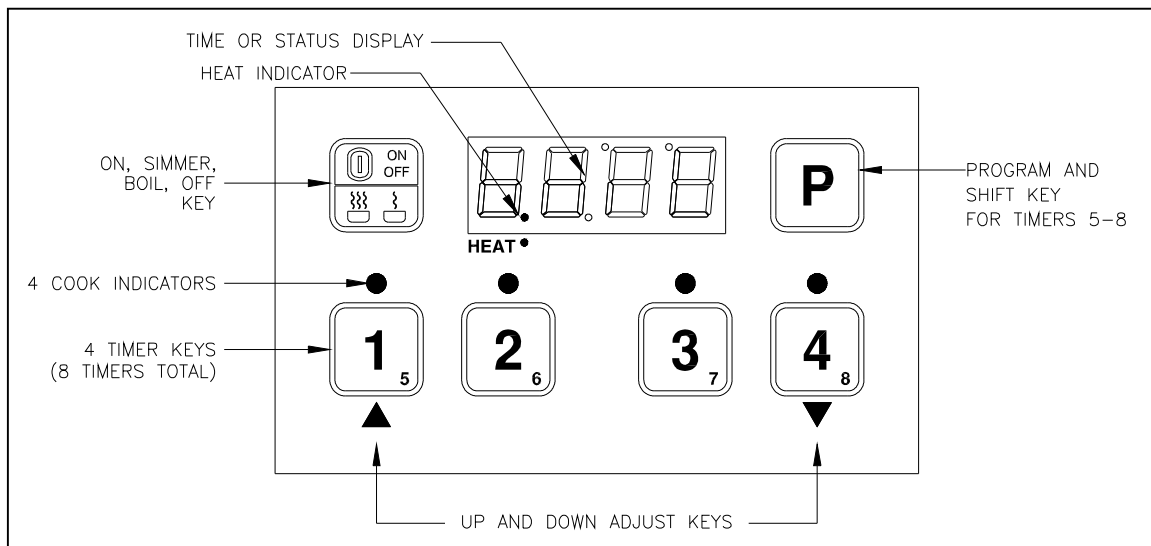

Warning

Make certain cook tank is filled with water before turning this appliance ON.



1.1 To Turn Control ON:

Press the  button. Display will show **601 L**, **51 00**, or **--- F**.

1.2 To Turn Control OFF:

Press and hold the  button. Display will show **OFF**.

1.3 To Activate timers 1-4:

Press , ,  or .

1.4 To Activate timers 5-8:

Press  then , ,  or .

Note: Multiple timers may run together, but only one timer for a key.

1.5 To Cancel a Cook:

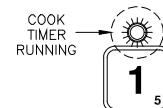

Press and hold the timer key until the cook indicator or light above the key is off.



1.6 To Enter Boil Mode:



Press  until **601 L** is displayed.

1.7 To Enter Simmer Mode:

Press  until  is displayed.

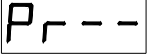

2 Programming

To enter the programming menu, press and hold  key for 3 seconds.







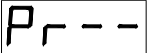

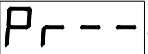

The display will show  for program entry or  for locked entry.

If control is displaying [Pr--] skip the next step.







2.1 To Unlock:

With display showing , press the  key once followed by  key. Display will show . Control is now unlocked ready for programming.

2.2 To Change Simmer Temperature:

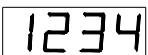
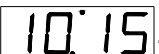



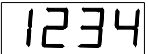

With display showing , Press the  key, display will show . Press the  key to display the current simmer temperature setting as , or . To change this setting, use the  key or  key to adjust temperature, then press the  key to save value. Display will show . Continue to the next step.

2.3 To Change Timers 1-4:



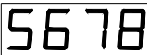

With display showing , press the  key once. Display will show . Press the timer key needing adjustment. The indicator above that key will illuminate, and the display will show the current timer setting, for example . Use the  key or  key to adjust time. Press the  key to save value. Display returns to  above. Repeat for other timer keys in this group.

When all keys in this group are set, press the  key to continue.

2.4 To Change Timers 5-8:

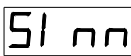

Display will show . Press the timer key needing adjustment. The indicator above that key will illuminate, and the display will show the current timer setting, for example . Use the  key or  key to adjust time. Press the  key to save value. Display returns to  above. Repeat for other timer keys in this group. When all keys in this group are set, press  to continue. Display will show .

2.5 To Exit Programming:

Press and hold the  key to exit. Display will show  or,  or, .

3 Level 2 Programming: (for technicians and factory use)

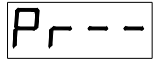
To enter the programming menu, press and hold  key for 3 seconds. The display will show

 for program entry, or  for locked entry.

If control is displaying [Pr--] skip the next step.



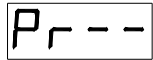

3.1 To Unlock

With display showing , press the  key once followed by  key. Display will show

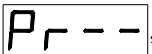
. Control is now unlocked ready for programming.

3.2 Password Entry to Level 2 programming:

A password is always required to enter Level 2 programming. With display showing , press

   . Display will show . Control is now ready for Level 2

programming. Press  to continue.

3.3 Display Types

One of three possible display modes may be selected. *The factory setting for this part is [t -0]. [t -2] option is not available on 60143701.* Display shows:

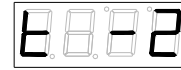
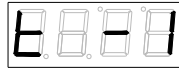
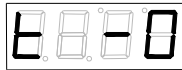

With this selection, [boil] or [Sim] is displayed. *Display may also read [---F] when water temperature is below 70 °F (21 °C). This is typical for cold start-ups.*

With this selection, display will alternate between temperature display and mode; [boil] or [Simm].

While in **SIMMER** [Simm], display will show an alternating display depending on water temperature.

- When temperature is lower than 10°F below set point. Display will alternate between [Louu] and [Simm].
- When temperature is greater than 10°F below set point, display will alternate between [drop] and [Simm].

While in **BOIL** [boil], display will show an alternating display depending on water temperature.

- When temperature is lower than 205°F, display will alternate between [Louu] and [boil].
- When temperature is greater than 205°F, display will show only [boil] continuously.



To change this setting, use and to adjust display type. Press to save value and continue.

3.4 Password Set Option

When locked, control will need a password key sequence to make future changes. Display shows:

or . To change this setting, use and keys to adjust the lock type.

Press the key to save value and continue.

3.5 Display in degrees °F or °C

Display shows or . To change this setting, use and keys to adjust

temperature scale. Press to save value and continue.

3.6 Number of Basket Lifts

This setting is for the number of basket lift outputs in use. Display will show current setting of , or , or . Factory setting is for one basket lift output enabled. If basket lifts are not supplied, any setting is acceptable. To scroll

through possible settings use and keys. Then

press to save value and continue.

BASKET LIFT OUTPUT		
Setting	Left	Right
LIF0	none	none
LIF1	Any Cook key	none
LIF2	1/5 & 2/6 key	3/7 & 4/8 key



3.7 Cook Done Alarm Options:





With this factory default selection, control will signal the end of cook with a blinking timer light, and, and audible alarm. When the cook key is pressed, the alarm ends. Operators then remove food from the vat.

If the optional basket lifts are installed on this appliance, the cook done alarm may be change to this setting. When the cook is done, an audible alarm with sound for 5 seconds, and then auto cancel. The basket lift removes the food from the vat.

If the optional basket lifts are installed on this appliance, the cook done alarm may be change to this setting. When the cook is done, NO audible alarm sounds. 5 seconds later the cook key will auto cancel. The basket lift removes the food from the vat.

3.8 Exit Programming

Display shows . Press  for 2 seconds.

Display will return one of the normal operating displays, , or . Display may also include alternating messages of , or  depending on water temperature.

4 Other Displays:

4.1 Low Vat Temperature

When tank temperature is below 70°F (21°C), the display will show as blanks. This is normal for cold start-ups. **Heat Demand** indicator is located between the first and second digits of display.

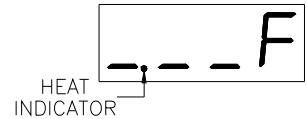

4.2 Drain Valve Open

When drain valve is detected open, normal operations are suspended. The display will show Drain-Turn-Off message until reset. To reset, CLOSE the drain valve, turn the control OFF. Allow the appliance to cool. When the tank is refilled control may be turned ON. *Note: some applications do not use the drain valve input.*

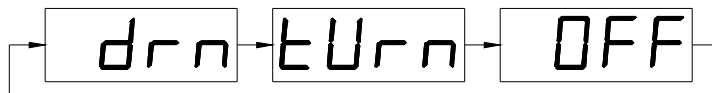

4.3 Equipment Fault Displays

4.3.1 Probe Faults

If temperature probe faults are detected, the display will show [Prob] and sound the alarm. All timer functions are disabled, and heat control shut off. To reset, turn control Off then On.



4.3.2 High Temperature Alarm

This display shows when the control detects a temperature above the alarm limit of 230°F (110°C). A continuous alarm will sound. To reset, turn control Off. Allow the appliance to cool. When the tank is refilled control may be turned ON.



4.4 To Change Port Address

With display showing  (from section "To Enter Level 2 Programming"), press  and

 simultaneously for 2 seconds. Display show the current address setting.

Use  and  to change address. Press  to save selection and return to 

display. This address setting has no effect on operations of the controller, and, is only meaningful when control is networked for data collection with other controls. In this case, controls must have different port addresses. Press and hold the  to exit.

4.5 To View Software Revision

While display is showing one of the normal operator displays ([bOIL], [Sim], or [_ °F]), press and hold



and the



simultaneously for 2 seconds. Display will show a rotating display, 4 digits each, for 2 seconds each.

“FLSt”----“1034”----“1” “----“ECL-“----“C*”
 “SoFt”----“2034”----“1” “----“ECL-“----“C*”
 “dnLd”----“3034”----“1” “----“ECL-“----“C*”

Note: Displayed values will vary from those shown in this example, and is dependant on manufacturing date, and revision of control.

5 Electrical Connections

J1 CONNECTIONS FOR P/N 60143701	
TERMINAL	DESCRIPTION
1	24 VAC POWER
2	24 VAC POWER COM
3	PROBE +
4	PROBE -
5	DRAIN INTERLOCK (24 VAC INPUT, FROM DRAIN SENSOR)
6	FUTURE EXPANSION
7	24 VDC RELAY PWR RETURN
8	NOT USED
9	NOT USED
10	RIGHT BASKET LIFT(24VDC)
11	LEFT BASKET LIFT(24VDC)
12	NOT USED
13	HEAT DEMAND RELAY (LINE IN)
14	NOT USED
15	HEAT DEMAND RELAY (OUT)

6 Chart: Probe Resistance vs Temperature

Probe Resistance vs Temperature (in 5°F Increments).								
Probe Temp (°F)	Probe Temp (°C)	Resistance (Ohms)	Probe Temp (°F)	Probe Temp (°C)	Resistance (Ohms)	Probe Temp (°F)	Probe Temp (°C)	Resistance (Ohms)
10	-12.2	562734	175	79.4	11719	340	171.1	1058.23
15	-9.4	483875	180	82.2	10716	345	173.9	998.09
20	-6.7	417167	185	85.0	9812	350	176.7	942.00
25	-3.9	360589	190	87.8	8995	355	179.4	889.67
30	-1.1	312474	195	90.6	8255	360	182.2	840.78
35	1.7	271446	200	93.3	7586	365	185.0	795.10
40	4.4	236370	205	96.1	6979	370	187.8	752.38
45	7.2	206311	210	98.9	6427	375	190.6	712.41
50	10.0	180491	215	101.7	5926	380	193.3	674.95
55	12.8	158252	220	104.4	5470	385	196.1	639.87
60	15.6	139055	225	107.2	5055	390	198.9	606.96
65	18.3	122489	230	110.0	4675	395	201.7	576.09
70	21.1	108051	235	112.8	4329	400	204.4	547.09
75	23.9	95539	240	115.6	4013	405	207.2	519.86
80	26.7	84644	245	118.3	3723	410	210.0	494.24
85	29.4	75136	250	121.1	3458	415	212.8	470.16
90	32.2	66823	255	123.9	3214	420	215.6	447.49
95	35.0	59540	260	126.7	2991	425	218.3	426.13
100	37.8	53146	265	129.4	2785	430	221.1	406.02
105	40.6	47523	270	132.2	2597	435	223.9	387.04
110	43.3	42569	275	135.0	2422	440	226.7	369.14
115	46.1	38195	280	137.8	2262	445	229.4	352.24
120	48.9	34328	285	140.6	2113.9	450	232.2	336.29
125	51.7	30902	290	143.3	1977.3	455	235.0	321.21
130	54.4	27862	295	146.1	1851.0	460	237.8	306.94
135	57.2	25161	300	148.9	1734.3	465	240.6	293.46
140	60.0	22755	305	151.7	1626.1	470	243.3	280.69
145	62.8	20610	310	154.4	1525.9	475	246.1	268.61
150	65.6	18695	315	157.2	1433.0	480	248.9	257.15
155	68.3	16981	320	160.0	1346.7	485	251.7	246.30
160	71.1	15446	325	162.8	1266.6	490	254.4	236.00
165	73.9	14069	330	165.6	1192.1	495	257.2	226.24
170	76.7	12823	335	168.3	1122.8	500	260.0	216.96

Notes:



In the event of problems with or questions about your order, please contact the Pitco Frialator factory at
(603) 225-6684 Worldwide.
website address: www.pitco.com

In the event of problems with or questions about your equipment, please contact the Pitco Frialator Authorized Service and Parts representative (ASAP) covering your area, or contact Pitco at the numbers listed to the left.

MAILING ADDRESS- P.O. BOX 501, CONCORD, NH 03302-0501
SHIPPING ADDRESS- 10 FERRY ST., CONCORD, NH 03301