



IMPORTANT FOR FUTURE REFERENCE

Please complete this information and retain this manual for the life of the equipment:

Model #: _____

Serial #: _____

Date Purchased: _____

ENGLISH

Installation & Operation Manual

CRTE: Electric Counter Top Rethermalizer



TO THE PURCHASER, OWNER AND STORE MANAGER

Please review these warnings prior to posting them in a prominent location for reference.

WARNING

DO NOT store or use gasoline or other flammable vapors and liquids in the vicinity of this or any other appliance.

WARNING

Improper installation, alteration, service or maintenance can cause property damage, injury or death. Read the installation, operating and maintenance instructions thoroughly before installing or servicing this appliance.

WARNING

Installation, maintenance and repairs should be performed by a Pitco Authorized Service and Parts (ASAP) company technician or other qualified personnel. Installation, maintenance or repairs by an unauthorized and unqualified personnel will void the warranty.

WARNING

Installation and all connections must be made according to national and local regulations and codes in force.

WARNING

A country approved all pole circuit breaker with a minimum open contact gap of 3mm must be used for proper installation. (CE countries)

WARNING

During the warranty period if a customer elects to use a non-original part or modifies an original part purchased from Pitco and/or its Authorized Service and Parts (ASAP) companies, this warranty will be void. In addition, Pitco and its affiliates will not be liable for any claims, damages or expenses incurred by the customer which arises directly or indirectly, in whole or in part, due to the installation of any modified part and/or received from an unauthorized service center.

WARNING

This appliance, when installed, must be electrically grounded in accordance with local codes or national codes. For domestic models, in the absence of local codes the installation must conform to the National Electric Code, ANSI/NFPA 70, or the Canadian Electrical Code, CSA C22.2, as applicable.

WARNING

Adequate means must be provided to LIMIT the movement of this appliance without depending on the electrical cord connection. Single appliances equipped with legs must be stabilized by installing anchor straps. All appliances equipped with casters must be stabilized by installing restraining chains.

WARNING

DO NOT alter or remove structural material on the appliance to accommodate placement under a ventilation hood.

WARNING

This appliance is not intended for use by persons (including children) with reduced physical, sensory or mental capabilities, or lack of experience and knowledge, unless given supervision or instruction concerning use of the appliance by a person responsible for their safety.

WARNING

If the appliance is equipped with a power cord and it is damaged, it must be replaced by a Pitco Authorized Service and Parts (ASAP) company technician, or a similarly qualified person in order to avoid a hazard.

WARNING

The power supply must be disconnected before servicing, maintaining or cleaning this appliance.

WARNING

The appliance is NOT jet stream approved. DO NOT clean the appliance with a water jet.

WARNING

DO NOT attempt to move this appliance or transfer hot liquids from one container to another when the unit is at operating temperature or filled with hot liquids. Serious personal injury could result if skin comes in contact with the hot surfaces or liquids.

WARNING

DO NOT sit or stand on this appliance. The appliance's front panel, tank, splash back, tank cover, workshelf, drain board is not a step. Serious injury could result from slipping, falling or contact with hot liquids.

WARNING

NEVER use the appliance as a step for cleaning or accessing the ventilation hood. Serious injury could result from slips, trips or from contacting hot liquids.

WARNING

The water level should be maintained at the level line. DO NOT turn the appliance on until the heating elements are fully covered with water at all times. Serious injury could result from hot steam vapors off the heating elements.

WARNING

If overflow drain is not equipped or if overflow drain stop is used, do not leave appliance unattended while filling with water. Over filling the appliance can cause serious injuries and damage the equipment.

WARNING

Completely shut the appliance down when the water is being drained from the appliance. This will prevent the appliance from heating up during the draining and filling process. Serious injury can occur.

WARNING

This appliance is intended for indoor use only.

WARNING

DO NOT operate appliance unless all panels and access covers are attached correctly.

WARNING

It is recommended that this appliance be inspected by a qualified service technician for proper performance and operation on a yearly basis.



1. INSTALLATION	2
1.1. CHECKING YOUR NEW APPLIANCE	2
1.2. INSTALLATION CLEARANCES	3
1.3. INSTALLATION TO COUNTER	3
1.4. DRAINAGE CONNECTIONS	3
1.5. ELECTRICAL CONNECTIONS	4
1.6. VENTILATION AND FIRE SAFETY SYSTEMS	6
1.7. INSPECTION	6
1.8. INITIAL CLEANING	7
2. OPERATION	8
2.1. FILLING THE APPLIANCE	8
2.1.1. FILLING THE COOKER TANK	8
2.2. APPLIANCE START UP	8
2.2.1. High Temperature Limit Switch	8
2.2.2. Liquid Level Control Sensor	8
2.3. COOKING	9
2.3.1. ADDITIONAL CONTROLLER FUNCTIONS	9
2.3.2. COOKING TIPS	9
2.4. APPLIANCE SHUTDOWN	9
3. PREVENTATIVE MAINTENANCE	10
3.1. DAILY PREVENTATIVE MAINTENANCE	10
3.1.1. APPLIANCE INSPECTION	10
3.1.2. CLEANING THE COOK TANK	10
3.1.3. CLEANING THE CABINET	10
3.2. MONTHLY PREVENTATIVE MAINTENANCE	10
3.2.1. DELIMING	10
3.3. ANNUAL/PERIODIC PREVENTATIVE MAINTENANCE AND INSPECTION	11
3.3.1. HEATING ELEMENT	11
3.3.2. TEMPERATURE PROBE & HIGH LIMIT PROBE	11
3.3.3. LOW WATER LEVEL SENSOR	11
3.3.4. CONTROLLER	11
3.3.5. CONTROL BOX & ELECTRICAL COMPONENTS	11
3.3.6. TANK	11
3.3.7. DRAIN SYSTEM	11
4. TROUBLESHOOTING	12
4.1. POWER FAILURE	12
4.2. HIGH TEMPERATURE LIMIT	12
4.3. LIQUID LEVEL CONTROL	12
4.4. TROUBLESHOOTING CHART	13
4.5. ELECTRICAL SCHEMATIC	13
4.6. PROGRAMMING INSTRUCTIONS	14

1. INSTALLATION

1.1. CHECKING YOUR NEW APPLIANCE

Your new Pitco appliance has been carefully packed into one crate. Every effort has been made to ensure that it is delivered to you in perfect condition. As you unpack your new appliance, inspect each of the pieces for damage. If something is damaged, DO NOT sign the bill of lading. Contact the shipper immediately; the shipper is only responsible for 15 days after delivery. Check the packing list enclosed with your appliance to ensure that you have received all the parts to the appliance. If you are missing any parts, contact the dealer from whom the appliance was purchased. As you unpack the appliance and its accessories be careful to keep the weight of the appliance evenly distributed. Refer to the table below to identify which accessories should be included with your appliance.

Locate your Pitco model number and serial number on the inner door of the appliance and the find the date purchased. Write this information on the front cover of this manual for future reference.

If you have completed the above steps that are applicable to the appliance you purchased, the appliance is now ready to be installed. Although it may be possible for you to install and set up your new appliance, it is **STRONGLY** recommended that you have this done by qualified professionals. A qualified professional will ensure that the installation is safe and meets local building and fire codes.

#	Description	CRTE
1	Drain Hose	Standard
2	Soup Rack (Quantity 4)	Standard
3	Element Rack	Optional
4	3 Product Rack (Quantity 2)	Optional
5	Tank Cover for 3 Product Rack	Optional

Accessories

WARNING

DO NOT install this appliance next to a deep fat fryer. A splash over of water into the hot oil may cause a steam eruption leading to property damage and/or personal injury.

WARNING

DO NOT sit or stand on this appliance. The appliance's front panel, tank, tank cover, workshelf, drain board is not a step. Serious injury could result from slipping, falling or contact with hot liquids.

1.2. INSTALLATION CLEARANCES

The clearances shown below are for combustible and non-combustible installations and will allow for safe and proper operation of your appliance.

	Combustible Construction	Non Combustible Construction
	Inches (centimeters)	Inches (centimeters)
Back	6.0" (15.24cm)	0.0" (0.0cm)
Sides	6.0" (15.24cm)	0.0" (0.0cm)
Counter	4.75" (12.07cm)	0.0" (0.0cm)

In addition to the above clearances there must also be at least 16 inches (40.64cm) of aisle space in front of the unit.

WARNING

DO NOT obstruct the flow of ventilation, or air openings around the appliance. Adequate clearance around the appliance is necessary for servicing and proper component ventilation. Ensure that you meet the minimum clearance requirements specified in this manual.

WARNING

The appliance should be secured to the counter top to prevent accidental moving of the appliance and the splashing of hot liquid on the operator.

1.3. INSTALLATION TO COUNTER

After the appliance is in its permanent location, check to ensure that it is level. Level the counter as needed.

WARNING

DO NOT perform leveling procedure when appliance is in operation or full of hot liquids. Serious injury could result.

1.4. DRAINAGE CONNECTIONS

The plumbing installation should be done by a licensed plumber and must comply with local and national codes. The drainage connection is located at the front of the appliance in the bottom left corner and is equipped with a 3/8" quick disconnect.

This appliance has a drain that can be inserted into a drainage system. The drain hose must be inserted into the tank quick disconnect fitting before the appliance can drain correctly. Drain connections for this appliance are to be made at the end of the 36" (91.44 cm.) long drain hose (3/8" (0.95 cm.) ID tubing).

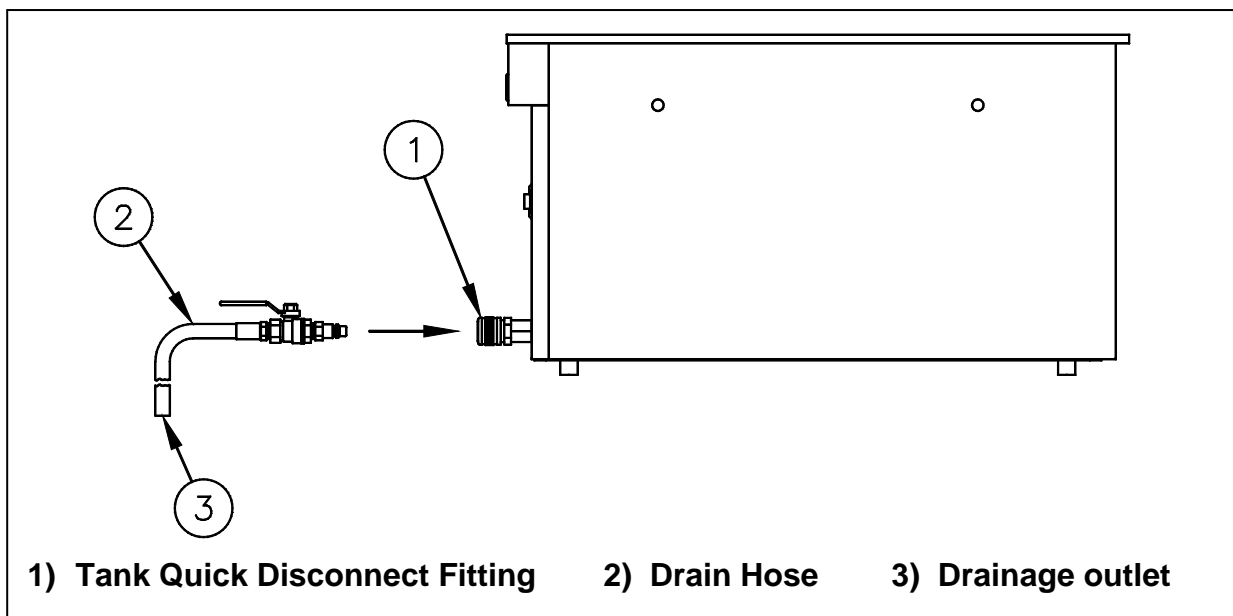

1.5. ELECTRICAL CONNECTIONS

It is advised that this power supply be plugged into a wall receptacle that is controlled by the ventilation control. This will prevent the appliance from being operated without the ventilator on. The power requirements for your appliance are listed below.

Voltage/Phase	KW	Amps
200VAC, single phase	5.5	28
208VAC, single phase	6	29
220VAC, single phase	5	23
230VAC, single phase	5.5	24
240VAC, single phase	6	25

CAUTION
Connecting the appliance to the wrong power supply may damage the appliance and void the warranty.
WARNING
This appliance must be connected to a power supply having the same voltage and phase as specified on the data plate located on the inside of the appliance door.
WARNING
DO NOT attempt to connect the appliance to an electrical supply other than that indicated on the data plate. Electrical connection should be performed by qualified personnel.
WARNING
The electrical connection used by this appliance must comply with local codes. If there are no local codes that apply, refer to the National Electrical Code (NEC), ANSI/NFPA 70 for installation in the US. In Canada, refer to CSA Standard C22.2 and local codes. In all other cases, refer to local and national codes and regulations.
WARNING
The appliance must be grounded in accordance with local code; if there is no local code, comply with the NEC and ANSI/NFPA No. 70 latest edition (for US and Canadian installations). In all other cases, refer to local and national codes and regulations. To comply with European requirements, European models are equipped with an equalization-bonding clamp. An equalization bonding lead must be connected to this clamp to provide sufficient protection against potential difference. This clamp, located on the rear of the appliance is marked with the following universal symbol. 
WARNING
A country approved all pole circuit breaker with a minimum open contact gap of 3mm must be used for proper installation. (CE countries)
WARNING
This equipment must be installed so that the plug is accessible unless other means for disconnection from the power supply (e.g. a circuit breaker) is provided.
WARNING
If this appliance is permanently connected to fixed wiring, it must be connected by means of copper wires having a temperature rating of not less than 167°F (75°C).
WARNING
All copper wiring for this appliance must be made in accordance with the wiring diagram(s) located on the appliance.

Available Power Cords

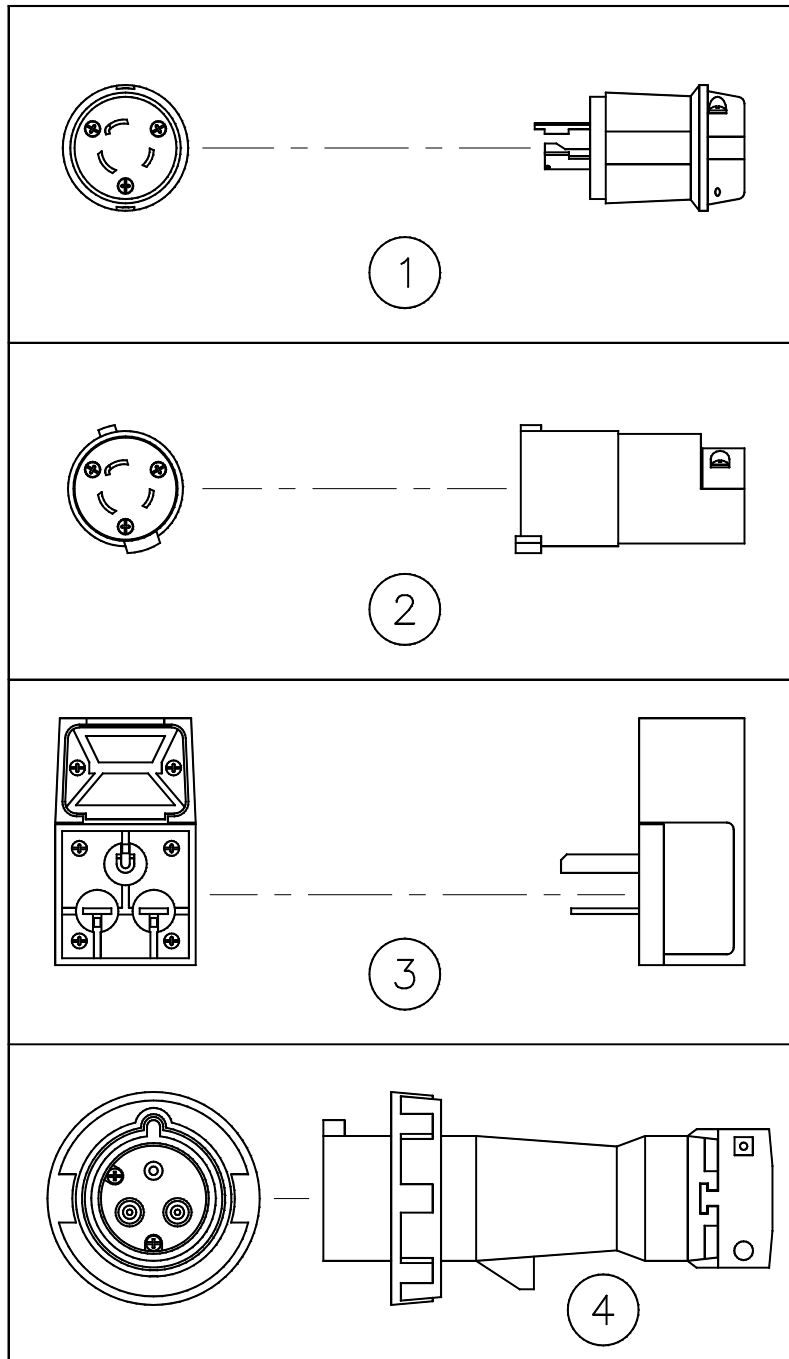

#	Description	Standard	Hubbell #	Mates to
1	Twist Lock	NEMA L6-30P	HBL2621	HBL2620
2	Shrouded Twist Lock	NEMA L6-30P	HBL2621S	HBL2626
3	Right Angle Straight Blade	NEMA 6-30P	HBL9331	HBL9330
4	Pin & Sleeve	IEC 309-1 or IEC 309-2	HBL330P6W	HBL330C6W or HBL330R6W

Appliance will be shipped with only one power cord from the listing above.

1.6. VENTILATION AND FIRE SAFETY SYSTEMS

Your new appliance must have proper ventilation to function safely and properly. It is very important to install a fire safety system. Your ventilation system should be designed to allow for easy cleaning. Frequent cleaning and proper maintenance of the ventilation system and the appliance will reduce the chances of fire. Ventilation and fire safety systems must comply too local and national codes.

1.7. INSPECTION

Before you begin filling and operating the appliance, perform the following visual checks:

- ✓ After the appliance is in its permanent location, check to ensure that it is level. Any additional leveling that is necessary can be performed as previously described.
- ✓ Ensure that the probe, heating element, low water level sensor and high temperature limit is in place and secure. Check the high limit bulb mounting screws to ensure that they are tight.
- ✓ Review the installation portion of this manual and ensure that all steps have been followed and executed properly.

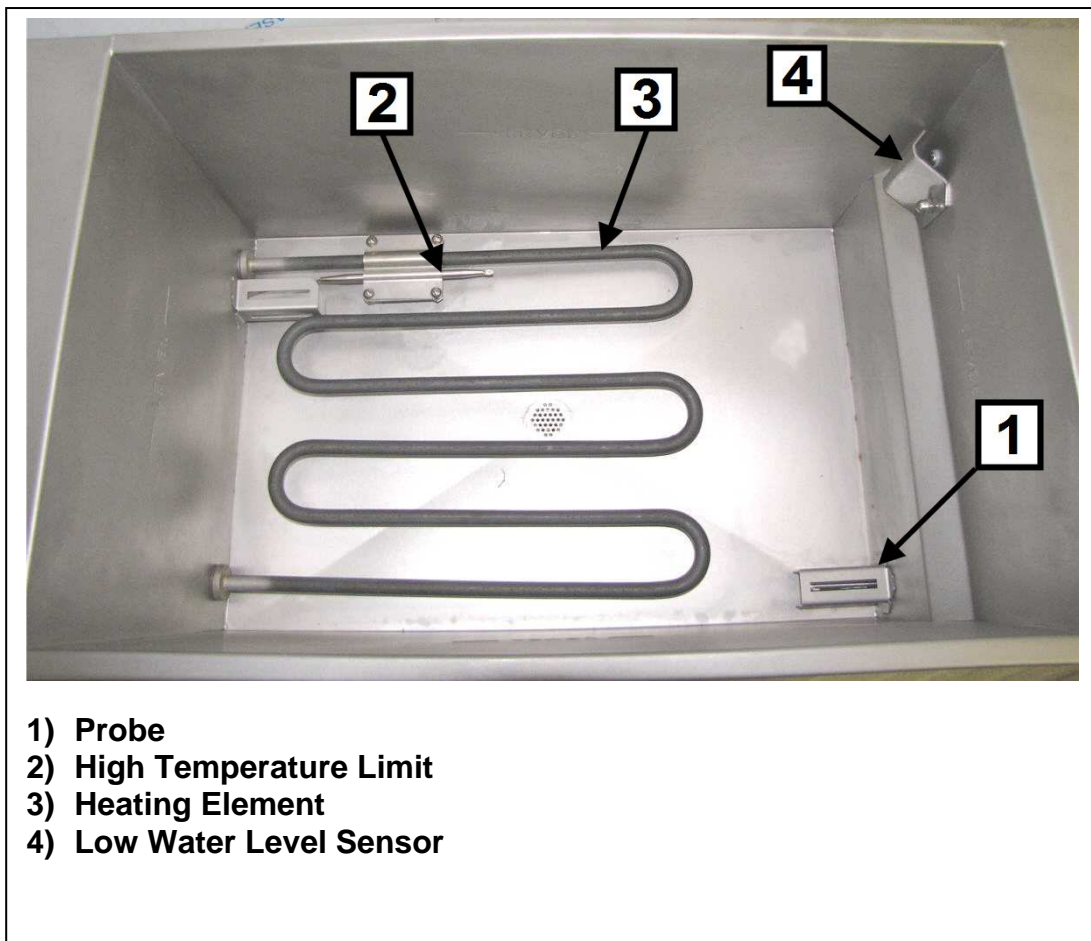

CAUTION

Be careful not to disturb or damage the probe, low water sensor and high temperature limit during operation and cleaning of this appliance.



1.8. INITIAL CLEANING

When your appliance is shipped, many of its parts are covered with a thin coat of oil for protection. Before the appliance is ready for cooking it must be cleaned. This will remove the oil coating and any foreign matter that may have accumulated during storage and shipment. Refer to the following procedure to clean the appliance.

WARNING

Wear protective gloves and clothing when cleaning and draining the appliance and when disposing of water. The water is extremely hot and can cause severe injuries.

CAUTION

DO NOT leave the appliance unattended during cleaning. Never let the water level go below the heating element.

1. Read the "operation" section of this manual prior to filling or operating the appliance.
2. The following steps should be followed using a grease dissolving commercial cleaner.

WARNING

Use a commercial grade cleaner formulated to effectively clean and sanitize food contact surfaces. Read the directions and precautionary statements before use. Particular attention must be paid to the concentration of cleaner and the length of time the cleaner remains on the food contact surfaces.

3. Following the manufacturer's directions of the cleaning product, clean the tank interior and all other food contact surfaces.
4. The exterior of the cabinet should be wiped down to remove any dust or foreign matter that may have accumulated during shipment of the appliance.
5. When cleaning is complete, rinse the inside of the tank thoroughly with cool water. Continue to rinse the tank until the cleaner has been completely and thoroughly rinsed from the tank.
6. Using a clean dry cloth, wipe out all of the water.

2. OPERATION

2.1. FILLING THE APPLIANCE

2.1.1. FILLING THE COOKER TANK

It is recommended that the cooker tank is filled with hot water. This will greatly decrease the time it takes for the appliance to reach operating temperature. Refer to the following procedure to fill the cook tank prior to operation.

CAUTION
This appliance is not designed for cooking with oil. Fill with potable water only.

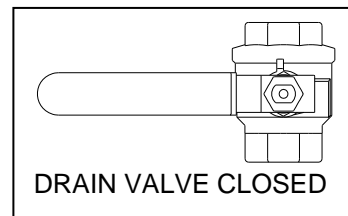

1. If the drain line hose is connected, ensure that the drain valve is closed.
2. Fill the tank with water until the water reaches the water level line(s), verify that the water level is above the low water level sensors. The unit may not operate properly if the low water level sensor is not sufficiently covered with water.

WARNING
Water must completely cover the heating elements at all times while appliance is on.

WARNING
Dry fired elements are extremely hot, Dry firing the elements will shorten its service life and may void your warranty.

2.2. APPLIANCE START UP

Refer to the following procedure to start the appliance prior to operation.

1. If the drain hose is connected, ensure that the drain valve is closed.
2. Fill the cook tank with water. (See section 2.1 "Filling the Appliance")
3. Press the power switch to the position. Releasing the switch return to the On (I) position.

WARNING
NEVER operate the appliance with an empty cook tank. It may void the warranty. Adding water to an empty tank after the elements have been heated may cause injuries from hot splattering liquids and steam.

Tank Capacity	
Model	Capacity
CRTE	6 Gal. (22.7 Liters)

4. The appliance is now on and heating the water in the cook tank.

2.2.1. High Temperature Limit Switch

The appliance is equipped with an auto-reset High Temperature Limit switch. The High Temperature Limit switch will interrupt power to the element if the internal cook tank reaches an unsafe temperature. This is to protect the appliance in the event the water is drained from the tank while the unit is on, or if the appliance is left unattended for an extended period of time allowing the water to boil or evaporate out of the tank. To reset the switch, refer to Section 4.2.



2.2.2. Liquid Level Control Sensor

The appliance is equipped with a Liquid Level Safety Control that will interrupt power to the element if the water level is below the fill line. This is to protect the appliance in the event the water is drained from the tank while the unit is on, or if the appliance is left unattended for an extended period of time allowing the water to boil or evaporate below the Liquid Level Sensors, (See Photo at Right). A warning lamp on the front of the unit alerts the operator that the water level is too low. To restart the appliance, refer to Section

OPERATION



2.3. COOKING

It is important to keep the cook tank full of water to minimize the chance of boiling the appliance dry and to keep the water at a level that will provide optimum cooking performance. To ensure the quality of the food you cook in this appliance, follow the preparation instructions from the food manufacturer.

2.3.1. ADDITIONAL CONTROLLER FUNCTIONS

Some controllers have additional functions not described in this manual. If your appliance's controller has additional functions, refer to the controller's operation manual to access these functions.

2.3.2. COOKING TIPS

- ✓ Always follow the food manufacturer's directions and only use sealed bagged products in this appliance.
- ✓ Some products can be reheated and held at the same temperature. If this is the case, the product may be held in this appliance while still in its vacuum-sealed bag. No separate holding device required.
- ✓ Product bag size can be important in reaching the shortest retherm times. Thin bags typically retherm faster than thicker ones.
- ✓ Always allow a gap between product bags. This will allow the hot water to circulate around the entire surface of the product bag, creating good heat transfer and ultimately shorter retherm times.
- ✓ Do NOT retherm in boiling water. Boiling water increases your energy and water consumption and furthermore this appliance is NOT recommended for boiling.
- ✓ Always follow proper food safety. Refer to FDA and the food manufacturer's guidelines for proper handling of the vacuum-sealed product.

Typical Retherm Times

Product	Appliance Temperature	
	140F	200F
Frozen	40 min.	9-10 min.
Thawed	30 min.	7-8 min.

*This table is for reference only.
Please refer to the product
manufacturer's specifications to
determine exact cook times.*

2.4. APPLIANCE SHUTDOWN

Press the power switch to the 0 (OFF) position to shutdown the appliance.

3. PREVENTATIVE MAINTENANCE

3.1. DAILY PREVENTATIVE MAINTENANCE

Performing the preventative maintenance steps below on a daily basis will keep your equipment safe and at peak performance.

3.1.1. APPLIANCE INSPECTION

- ✓ Check that the high temperature limit, temperature probe, low water level sensor and the heating element are in the correct position and secured in place.
- ✓ Check that wires and cords are not frayed or loose in and out of the cabinet.
- ✓ Check around the appliance for loose parts or accessories that need to be secured or other foreign items (ex: Aerosol cans) that should be removed from the area.
- ✓ Check for water leaks around the drain lines and in and out of the cabinet and around the appliance.

WARNING
The power supply must be disconnected before cleaning and servicing this appliance!

3.1.2. CLEANING THE COOK TANK

1. Turn the appliance off.
2. Scrub the tank, racks, heating element and temperature probe using a Scotchbrite™ or other mildly abrasive pad with a commercial type cleaner specifically designed for cleaning and sanitizing food contact surfaces. Follow the directions and familiarize yourself with the safe use of this cleaner prior to using it to clean the appliance. Care must be taken to remove all the foreign material on the tank and on components in the tank.
3. Use a cotton swab, or a soft bristle brush to clean off the contact(s) of the low water level sensor. Build up of mineral deposits on the contacts may cause the unit to improperly function.
4. When cleaning is complete, rinse the inside of the tank and its components thoroughly with cool water. Continue to rinse at least twice or until the cleaner has been completely and thoroughly rinsed from the tank.

WARNING
Wear protective gloves and clothing when cleaning and draining the appliance and when disposing of water. The water is extremely hot and can cause severe injuries.

WARNING
Read the operation section of this manual prior to filling or operating the appliance.

WARNING
DO NOT leave the appliance unattended during cleaning.

3.1.3. CLEANING THE CABINET

1. The outside of the cabinet should be cleaned with a damp cloth and mild detergent to remove oil, dust, dirt and debris. Be careful not to introduce the detergent into the tank and food zone regions of the appliance.

3.2. MONTHLY PREVENTATIVE MAINTENANCE

Water can leave mineral deposits inside the tank. Performing the monthly preventative maintenance steps below will keep your equipment safe and at peak performance. It may be necessary to clean these components more than once a month.

3.2.1. DELIMING

1. Read the "operation" section of this manual prior to filling or operating the appliance.
2. Following the manufacturer's deliming instructions, remove deposits from the tank's interior.
3. When cleaning is complete, rinse the inside of the tank and its components thoroughly with cool water. Continue to rinse at least twice or until the cleaner has been completely and thoroughly rinsed from the tank.
4. Using a clean dry cloth, wipe out all of the water.



3.3. ANNUAL/PERIODIC PREVENTATIVE MAINTENANCE AND INSPECTION

This section should ONLY be performed by a qualified service technician as part of a regular kitchen maintenance program. This inspection should take place a minimum of once a year by an Authorized Service Technician recommended by Pitco.

WARNING

The power supply must be disconnected before cleaning and servicing this appliance!

3.3.1. HEATING ELEMENT

- ✓ Check if the element is mechanically sound and in good condition. Look for scale build up and inspect for signs of repeated dry firing.
- ✓ Verify element wires are in good working condition. Look for damage to wires or frayed insulation. Check that the insulation is dry.
- ✓ Verify that bulkhead connections/nut is tight and leak free. Look for water stains and wet surfaces.
- ✓ Verify amp-draw is within range as compared to the information on the data plate.

3.3.2. TEMPERATURE PROBE & HIGH LIMIT PROBE

- ✓ Verify probes are in good working condition. Check for damage and that the fasteners are tightly secured to the tank.
- ✓ Verify compression fittings are leak free.
- ✓ Check wiring for loose electrical connections.

3.3.3. LOW WATER LEVEL SENSOR

- ✓ Verify contacts are clean and free of damage.
- ✓ Verify that the contacts are properly secured, contacts should not rotate.
- ✓ Verify there are no water leaks around the contact fluropolymer washers.

3.3.4. CONTROLLER

Perform the following inspection if the appliance is equipped with a temperature controller.

- ✓ Verify that the controller is in good mechanical condition. Check all lights, displays and switches to assure that they are working properly. Examine overlay for damage that could allow moisture to enter.
- ✓ Check for loose electrical connections.
- ✓ Verify set temperature. Check temperature 1" above controller probe, if necessary check probe resistance.

3.3.5. CONTROL BOX & ELECTRICAL COMPONENTS

- ✓ Verify that heating contactors are in good condition. Check for worn or pitted contacts. Verify that wires are tight and in good condition.
- ✓ Verify that all components (transformer, terminal block, relays, drain switches, etc...) are in good condition. Verify that wires are tight and in good condition.
- ✓ Verify enclosures are free of leaks. Check for water stains and wet surfaces.
- ✓ Verify that the covers and panels are in tact and provide a safe condition. Check for loose parts.
- ✓ Verify power cord is in good condition. Check for frayed or exposed wires. Verify that the insulation is in good condition and the attachment to the appliance is tight.

3.3.6. TANK

- ✓ Verify that the tank is in good condition. Check for scale build up and inspect for signs of corrosion. Verify that tank is leak free. Check drain overflow (if equipped) for scale build up and debris blockage.

3.3.7. DRAIN SYSTEM

- ✓ Verify that drain valve is in good condition. Check for leaks in the seal area and fitting region.
- ✓ Verify that drain lines are leak free, kink free and in good condition. Check for scale build up and debris blockage. Verify that the clamps and connections are securely tightened.

4. TROUBLESHOOTING

4.1. POWER FAILURE

If electric power is removed for any reason, the appliance will shut down. To restart the appliance, follow the appliance start up procedure in section 2.2.

CAUTION
DO NOT attempt to operate this appliance during a power outage.

4.2. HIGH TEMPERATURE LIMIT

This appliance is equipped with a high temperature limit switch. The high temperature limit switch will stop the appliance from functioning if the internal cook tank reaches an unsafe temperature. In the event that the high temperature limit has tripped, refer to the following steps to reset the switch.

1. Turn the appliance off.
2. Allow the appliance ample time to cool to room temperature.
3. Add water to the cook tank as needed.
4. The high limit switch is now reset and the appliance is ready for start up.
5. Restart the appliance by pressing the power switch to the  position and releasing.

WARNING
DO NOT add water to the tank until it has been given ample time to cool down. Failure to do so may result in damage to the appliance and/or injury to the operator.

4.3. LIQUID LEVEL CONTROL

This appliance is equipped with a Liquid Level Control. The level control will stop the appliance from functioning if the water falls below the liquid level sensors. There is a warning lamp on the front of the appliance that alerts the operator that the water level is too low, follow these steps to reset the switch.

- 1 Turn the appliance off.
- 2 If the heating elements are exposed, allow the appliance ample time to cool to room temperature.
- 3 Add water to the nominal fill line in the tank, covering the sensors will reset the liquid level control.
- 4 The appliance is ready for start up by pressing the power switch to the  position and releasing.

4.4. TROUBLESHOOTING CHART

Problem	Probable Cause	Corrective Action
Control does not activate	No power to appliance	Check main building power supply
	Circuit breaker tripped	Reset power supply Circuit Breaker
	I/O switch in the O (off) position	Press the power switch to the start Position and release
	Power cord disconnected	Check power cord connection
	High temperature limit tripped	Allow the appliance to cool to room temperature and the high limit switch will auto-reset.
	Low water level	Fill appliance with water level fill line(s)
Appliance stops heating	Circuit breaker tripped	Reset power supply Circuit Breaker
	High temperature limit tripped	Allow the appliance to cool to room temperature and the high limit switch will auto-reset.
	Low water level	Fill appliance with water level fill line(s)

4.5. ELECTRICAL SCHEMATIC

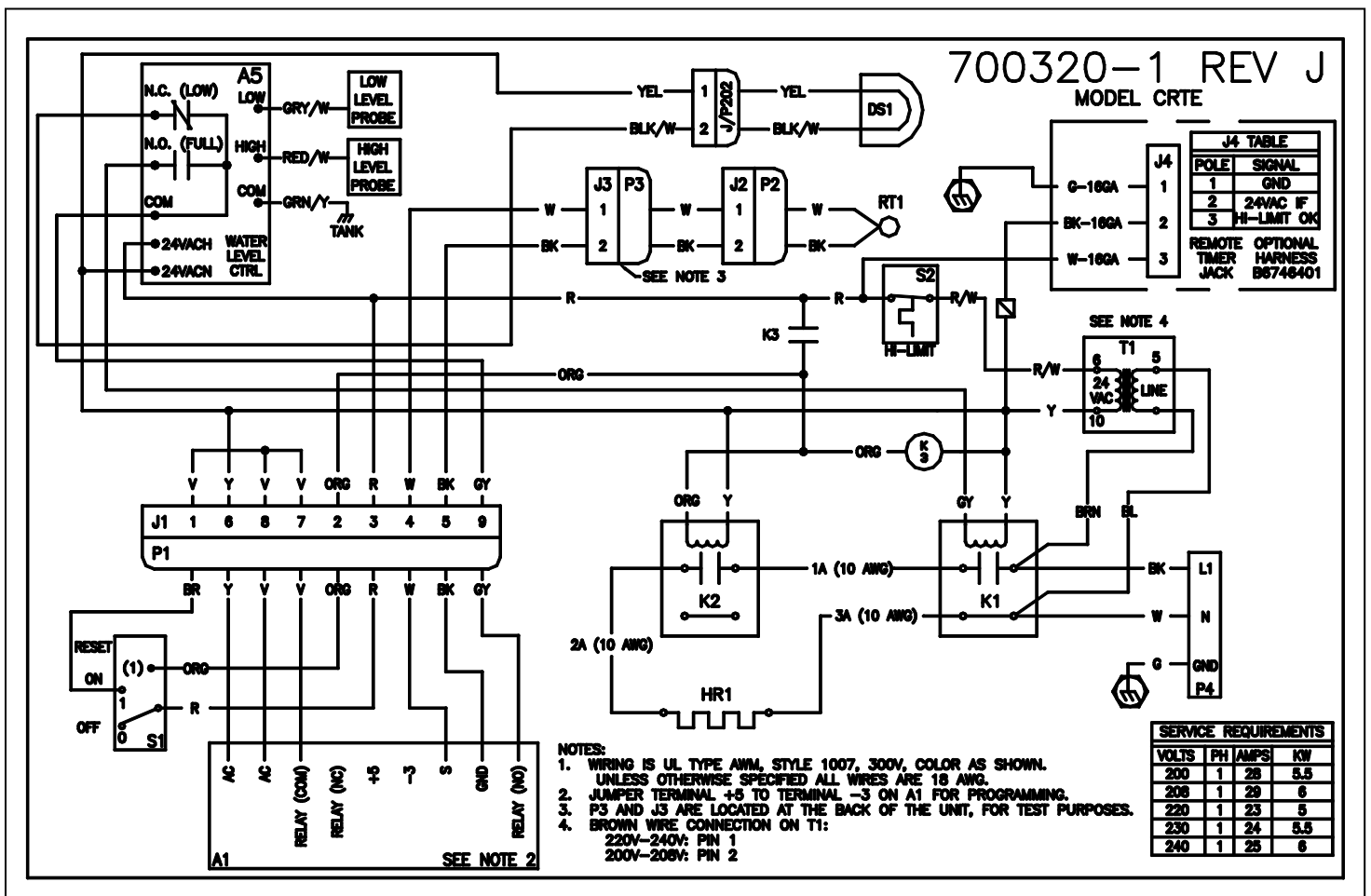

4.6. PROGRAMMING INSTRUCTIONS

REETHERMALIZER DIGITAL THERMOSTAT

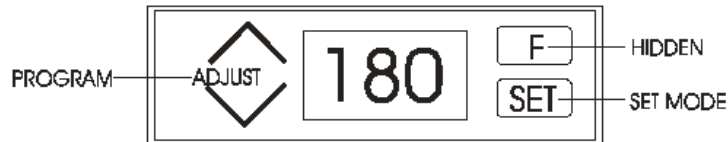

PROGRAMMABLE FUNCTIONS

- DF1 * Differential temperature - Sets the temperature range above and below the set temperature that the heating system cycles on and off
- HI * Maximum controller temperature - Sets the maximum temperature that can be programmed into the controller
- LO * Minimum controller temperature - Sets the minimum temperature that can be programmed into the controller
- CAL * Calibration range - Enables calibration corrections to be made between actual temperature and sensed temperature at the probe
- SP1 * Set temperature mode - Set temperature is programmed in this mode

ENTERING PROGRAMMING MODE

A JUMPER WIRE MUST BE INSTALLED BETWEEN TERMINALS +5 AND -3 ON THE BACK OF THE CONTROLLER. CONTROLLER IS NON-PROGRAMMABLE WITHOUT JUMPER WIRE INSTALLED

PROGRAMMING SET TEMPERATURE

- * Press **SET**, Display will show "SP1"
(Set temperature mode - Set temperature is programmed in this mode)
- * Press **SET**, Display will show "XXX" (XXX = current set temperature)
- * Press **ADJUST** to change temperature setting (**NOTE: If set temperature will not adjust to desired setting, check HI and LO temperature settings**)
- * Press **SET** to save new temperature setting



PROGRAMMING, Cont'd

CHANGING PROGRAMMABLE SETTINGS

- DF1 * Press , Display will show "DF1"
- * Press again, Display will show "XX" (XX = current setting)
- * Press to change setting
- HI * Press again, Display will show "HI"
- * Press again, Display will show "XXX" (XXX = current setting)
- * Press to change setting
- LO * Press again, Display will show "LO"
- * Press again, Display will show "XXX" (XXX = current setting)
- * Press to change setting
- CAL * Press again, Display will show "CAL"
- * Press again, Display will show "XX" (XX = current setting) NOTE: This Number can be set as a NEGATIVE number (-30) or a POSITIVE number (+30) above or below set point
- * Press to change setting

SAVE / EXIT PROGRAMMING MODE

TO SAVE OR EXIT PROGRAMMING MODE AT ANY TIME PRESS F UNTIL DISPLAY SCREEN IS BLANK AND THEN REMOVE JUMPER WIRE.

THIS PAGE INTENTIONALLY LEFT BLANK



THIS PAGE INTENTIONALLY LEFT BLANK



In the event of problems with or questions about your order, please contact the Pitco Frialator factory at:
(603) 225-6684 World Wide
Website Address: www.pitco.com

In the event of problems with or questions about your equipment, please contact the Pitco Frialator Authorized Service and Parts representative (ASAP) covering your area, or contact Pitco at the numbers listed to the left.

MAILING ADDRESS – P.O. BOX 501, CONCORD, NH 03302-0501