



HERITAGE I12 COMPUTER QUICK PROGRAMMING CARD

TURN ON and OFF

To Turn the Appliance ON : (See Note 1)

Press Rocker Switch to on. Display will show: [HEATING], [MELTING] or [READY].

To Turn the Appliance OFF :

(See Note 1) Press Rocker Switch

Off., Display will show:

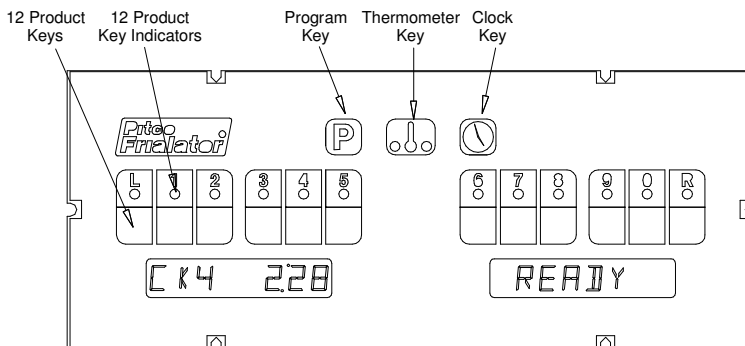

The Software number and then [OFF] [OFF] on single vat or a dual vat if both sides are off.

Note 1: Use Left Rocker Switch for left side and Right Rocker Switch for the right of dual vat control.



OPERATIONS

To Check Actual Temp : Press , Display shows actual temp and then returns to normal mode.

To Check Set Temp : Press  , Display shows set temp and then returns to normal mode.

To Check Cook, Shake and Hold Time : Press  then the Product Key desired. See example below:

Typical displays using key 4 as an example:

Key 4 set for 3 minutes and 28 seconds cook time.

Key 4 Shake Time is set for 2 minutes and :00 seconds before the end of the Cook.

Key 4 Hold Time in set for 10:00 minutes.

In a few moments, the display will return to [READY] or last mode of operation.

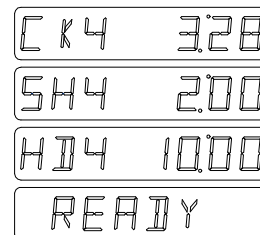

To Check Time Remaining on a Non-Displayed Product Key when Multiple Timers are in Use :

Press  then the Product Key of the Non – Displaying timer key, The display will switch from showing the lowest time remaining over to the time remaining for the key that was pressed. Repeat for other keys.

To Start a Cook : When display shows [READY] Press any [L,1,2,3,4,5,6,7,8,9,0,R] Product Key to start cook timer. The indicator light above will flash to indicate the timer is running:

To End a Cook : When the audible alarm is beeping, press the appropriate Product Key  (i.e. Key 4) with the flashing indicator light, all other indicator lights are off until the key is pressed.

To Cancel a Cook : Press and Hold the Product Key you want to cancel until its indicator light is off.

Boil Out Mode : After filling empty vat with water, turn appliance on.

Automatic Entry : When the water temperature reaches just below 212°F (100°C) the computer will display.

PRESS 0 TO BOIL, press Product Key  to continue heating,

display then shows .

Manual Entry : Press  then enter Product Key [2] [1] [2] for Fahrenheit or [1] [0] [0] for Celsius display unit. When last digit is entered, boil mode will start automatically. On Dual Vat computers both sides will enter boil mode. You must turn off both sides of the fryer to exit Boil mode.

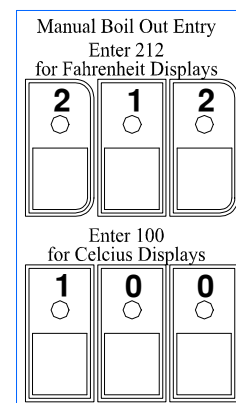



FIRST LEVEL PROGRAMMING

ENTER PROGRAM Press **[P]** key, display show **[PROGRAM]**, If PASSWORD IS REQUIRED, and you are unable to remember the set password use (6684).

SET TEMPERATURE Single or Dual Vat (left side) - Press Enter Desired Temperature.

Dual Vat (right side) - Press Enter Desired Temperature.

*To SAVE and CONTINUE Press **[P]**, to EXIT First Level Programming Press **[P]** Again.*

SET TIME(s) .. Press , display shows **[SELECT] [PRODUCT]**, Press any Product Key **[L,1,2,3,4,5,6,7,8,9,0,R]**.

COOK TIME (CKn mm:ss) Enter Time and Press to proceed to **SHAKE TIME (SHn mm:ss)** Enter Time and

Press to proceed to **HOLD TIME (HDn mm:ss)** Enter Time and Press to proceed to **HOLD PRE-ALARM**

(PAn mm:ss) Enter Time and Press to return to **[SELECT] [TIME]**, repeat for other product keys.

*To SAVE and CONTINUE Press **[P]**, to EXIT First Level Programming Press **[P]** Again.*

SECOND LEVEL PROGRAMMING

ENTER PROGRAM Press **[P]** key, display shows **[PROGRAM]**, If PASSWORD IS REQUIRED, and you are unable to remember the set password use (6684). Then press **[0]** you have now entered the upper level programming, all the useable function keys will be lighted and the display will show **[SELECT OPTIONS]**.

NOTE: Any time **[P]** is used to save a setting, **[0]** must be pressed to return to **[SELECT OPTIONS]**.

- | | |
|---------------------------|---|
| Function Keys Programming | 1 FAHRENHEIT / CELCIUS – Toggle between Fahrenheit and Celcius scale by pressing the [0] key
Change is saved by pressing the [P] key to set |
| | 2 SET PASSWORD – Press [0] to choose [PASS REQ] or [NO PASS] . If password is chosen then press [P] , current password displays. Use the number keys to enter new password and press [P] to set. |
| | 3 BEEPER VOLUME & TONE – Press [0] to toggle between levels 1,2,3 & Tone(1,2,3) and press [P] to set. |
| | 4 LANGUAGE – Press [0] to toggle between different languages and press [P] to set. |
| | 5 MELT CYCLE – Press [0] to toggle [NO MELT] , [SOLID] , or [LIQUID] and press [P] to set. |
| | 6 RECOVERY TIME – Press [0] to display [F065 LXXX] , “F” is Factory time and lastest time is “LXXX” |
| | 7 CONTROL/TIMER (Single or Dual-left side) – Press [0] to switch control to timer mode,press [P] to set. |
| | 8 CONTROL/ TIMER (Dual Tank-right side) – Press [0] to switch control to timer mode , press [P] to set. |

*To SAVE and CONTINUE Press **[P]**, to EXIT SECOND Level Programming Press **[P]** Again.*

OTHER DISPLAYS:

[PROBE OP] [OPEN] If probe is detected open, normal heating and cooking activities are suspended.

[HIGH TMP] [HIGH TMP] If vat temperature has exceeded set temperature by 40°F (22°C), or an absolute of 410°F (210°C) max.

[DRAINING] [TURN OFF] Drain valve has been opened, Heat control is turned off. To restore to normal operation, close the drain valve. Display will show **[TURN OFF] [TURN OFF]**. Turn controller off, and refill the vat.

[HEAT] [FAILURE] OR [IGNITION] [FAILURE] Heating system failed to respond due to a tripped high temperature limit switch and is in need of resetting. For gas models, the pilot failed to light, flame ignition detection is marginal or draft protector tripped on SCB.

[SYSTEM] [FAILURE] If probe is detected as a short circuit, normal heating and cooking activities are suspended.